

Gabriel®

THE ORIGINAL

2025

AUTOMOTIVE SHOCKS & STRUTS

CATALOG



SCAN TO WATCH!
*Which is the best Gabriel®
shock or strut for my vehicle?*



Gabriel.com

2025 Table of Contents / Table des matières / Contenido

Footnote Index	2
Sales Popularity Listing / Liste des Codes de « Popularité » / Lista de Terminos mas Populares.....	3
Application Data	
Passenger Cars & Light Trucks.....	4
Numerical Listing	
Steering / Axle Shaft Dampers.....	210
Steering Stabilizers.....	210
Front Load Carriers	214
Rear Load Carriers.....	215
Ultra Strut Cartridges	217
HiJackers	217
Ultra Struts.....	252
Guardian Struts.....	230
Ultra ReadyMount.....	230
LTV Severe Duty Shocks	239
ProGuard Shocks.....	241
Ultra Truck Shocks	248
Ultra Shocks.....	257
MaxControl Monotube Shocks	261
Guardian Shocks.....	264
Classic Shocks.....	272
Suspension Mounts	274
Strut Cushions.....	278
Competitive & OE Interchange List	282
Reference Section:	
A..... Left / Right Combinations.....	432
B..... Mounting Codes / Extended and Collapsed Length Charts.....	435
B..... Specs by Part Number.....	447
C..... Disposal of Old or Defective Shocks & Struts.....	472
C..... <i>Disposition de Vieux ou Défectueux Chocs et de Contrefiches</i> <i>de Gas-Pressurized</i>	473
C..... <i>Como Deshacerse de Amortiguadores y Struts Viejos o</i> <i>Defectuosos-sin Presurizacion con Gas</i>	474
D..... Air Adjustable Hose Kits.....	475



FOOTNOTE INDEX

- 1 - 4 Future Part
- 5 Use kit no. 140719 to replace O.E. hardware for lower shock absorber mounting when studs break or self-tapping screws are no longer useable.
- 6 It is recommended that when replacing shocks on vehicles with "quad shocks" option, all 4 shocks should be matched by series.
- 7 Pair Packs. Air hose kit included.
- 8 Pair Packs.
- 9 See Ref. D for procedures to replace Elec. Adj. Susp. with non-adj. product.
- 10 The Nivomat leveling shocks are on the rear only. If suspension spring contacts units, rotate suspension spring 180 degrees.
- 30 For GM Vehicles equipped with factory installed leveling systems, see Ref. A.
- 31 With Nivomat Self-Leveling Suspension replace spring with Volvo No. 1229052/4.
- 32 With Nivomat Self-Leveling Suspension replace spring with Volvo No. 1359710 or 1273977.
- 33 Also works as conventional type replacement for Nivomat suspension.
- 34 If suspension spring contacts this unit, rotate suspension spring 180 degrees.
- 35 Slight grinding of control arm opening is required to install product made before Aug. 1988.
- 36 Requires special strut installation tool.
- 37 Jounce Bumper hardware from O.E. part may need to be reused.
- 39 Conventional gas-charged strut can be used to replace O.E. air adjustable gas-charged strut. However, the self-leveling system must be deactivated. See Ref. A for instructions.
- 40 ReadyMount Strut. Complete Assembled Unit.
- 41 ReadyMount Strut. Complete Assembled Unit. See Ref. D for procedures to replace Elec. Adj. Susp. with non-adj. product.
- 42 ReadyMount Strut, does not include springs due to vehicle design.
- 43 ReadyMount Strut, does not include springs due to vehicle design. See Ref. D for procedures to replace Elec. Adj. Susp. with non-adj. product.
- 44 This strut is not gas pressurized therefore the piston rod will not extend without assistance.
- 45 Strut must be rotated to align notch with lower control arm
- 46 Upper Mount orientation may be required.
- 50 Bellows Kit No.141242 is recommended for use to protect piston rod from potentially harmful road debris.
- 51 Strut Cushion.
- 52 See Ref. C for optional Steering Stabilizer Boots.
- 53 Strut Mount. Hardware from O.E. Part may need to be reused.
- 54 Kit with Mount and Bearing. Hardware from O.E. Part may need to be reused.
- 55 Mount Kit includes Mount, Spring Seat, Bearing & Isolator. Hardware from O.E. Part may need to be reused.
- 56 Mount Kit includes Mount, Bumper/Bellow & Retainers. Hardware from O.E. Part may need to be reused.
- 57 Mount Kit includes Lower Spring Seat with Internal Bearing & Isolator. Hardware from O.E. Part may need to be reused.
- 58 Mount Kit includes Suspension Bearing. Hardware from O.E. Part may need to be reused.
- 59 Strut Mount Contains a Plastic Bearing. Hardware from O.E. Part may need to be reused.
- 60 Strut Mount Contains a Metal Bearing. Hardware from O.E. Part may need to be reused.
- 61 Mount Kit includes Upper Spring Seat. Hardware from O.E. Part may need to be reused.
- 62 Mount Kit includes Lower Suspension Mount Bushing. Hardware from O.E. Part may need to be reused.
- 63 Mount Kit includes Isolator. Hardware from O.E. Part may need to be reused.
- 64 Mount Kit includes Lower Rubber Spring Seat Isolator. Hardware from O.E. Part may need to be reused.
- 65 Mount Kit includes Upper Spring Seat with Isolator. Hardware from O.E. Part may need to be reused.
- 66 Upper Spring Seat with Spacer. Hardware from O.E. Part may need to be reused.
- 67 Strut Mount Kit. Hardware from O.E. Part may need to be reused.
- 69 Strut Mount & 1 Retainer. Hardware from O.E. Part may need to be reused.
- 70 Mount Kit includes Bushing & Sleeve. Hardware from O.E. Part may need to be reused.
- 72 Mount Kit includes Upper/Lower Retainer, Upper/Lower Cushion, 1 Lower Spring Isolator & 1 Sleeve
- 80 Mounting bracket not required, install on O.E. Shock Mounts. See Ref. C for optional Steering Stabilizer Boots.
- 81 Mounting bracket kit is required for installation. See Numeric Listing. See Ref. C for optional Steering Stabilizer Boots.
- 82 Use kit if listed. See Ref. C for optional Steering Stabilizer Boots.
- 83 For dual system, two stabilizers and one bracket kit are to be ordered. See Ref. C for optional Steering Stabilizer Boots.
- 98 Notice: The level of difficulty to install this product is moderately high. Please review the installation instructions carefully before proceeding.
- 99 Notice: The level of difficulty to install this product is moderately high. Please review the installation instructions carefully before proceeding. Requires special strut installation tool.

SALES POPULARITY LISTING
LISTE DES CODES DE «POPULARITÉ»
LISTA DE TERMINOS MAS POPULARES

- A** FAST
RAPIDE
RAPIDO
- B** GOOD
BON
BUENO
- C** FAIR
PASSABLE
RAZONABLE
- D** SLOW
LENT
LENTO
- FF** NEW ITEM, AVAILABILITY TO BE ANNOUNCED
NOUVEL ITEM DISPONIBILITÉ À ÊTRE ANNONCÉE
ARTICULO NUEVO, DISPONIBILIDAD SERA ANUNCIADO
- N** NEW ITEM
NOUVEL ARTICLE
ARTICULO NUEVO
- S** SUPERSEDED - SELL UNTIL FACTORY INVENTORY IS DEPLETED,
THEN USE REPLACEMENT PART NUMBER
REPLACÉ – VENDRE JUSQU’À ÉPUISEMENT DU STOCK EN USINE,
PUIS UTILISER LE NUMÉRO DE PIÈCE DE REMPLACEMENT
REEMPLAZA – VENDERSE HASTA QUE EL INVENTARIO DE LA FABRICA
SE TERMINE, ENTONCES USE LA PARTE QUE LA REEMPLAZA
- W** EXTREMELY SLOW
TRÈS LENT
EXTREMADAMENTE LENTO
- X** DISCONTINUE WHEN CURRENT FACTORY INVENTORY IS DEPLETED -
LAST YEAR IN CATALOG
ARRÊTEZ QUAND L’INVENTAIRE DU FABRICANT EST ÉPUIsé –
DERNIÈRE ANNÉE DANS LE CATALOGUE
DESCONTINUAR CUANDO EL INVENTARIO ACTUAL SE TERMINE –
EN EL CATALOGO DEL AÑO PASADO

APPLICATION GUIDE

Year	Fitment Notes										
		Ultra	Ready Mounts	Max Control\ LTV\ ProGuard\ Guardian	Strut Cushion\ Strut Mount\ Dampers\ Stabilizer	HiJackers\ Load Carrier\ Classic	Ultra	Ready Mounts	Max Control\ LTV\ ProGuard\ Guardian	Strut Cushion\ Strut Mount\ Dampers\ Stabilizer	HiJackers\ Load Carrier\ Classic

ACURA

ACURA

CL

01-03	Left		G56991 ⁴⁰	142230 ⁵³	G56943 ⁴⁰	M55871
	Right		G56992 ⁴⁰	142230 ⁵³	G56943 ⁴⁰	M55871
97-99	All		M55877	142230 ⁵³	M55786	143064 ⁵¹

CSX

06-11	Left		G57390 ⁴⁰		G51807
	Right		G57391 ⁴⁰		G51807

EL

01-03	Left		G56621	G57521 ⁴⁰	142230 ⁵³		G51700
	Right		G56622	G57522 ⁴⁰	M56622	142230 ⁵³		G51700
97-00	Left		G56996 ⁴⁰	142230 ⁵³ 143064 ⁵¹		G55910	G56998 ⁴⁰	143064 ⁵¹
	Right		G56997 ⁴⁰	142230 ⁵³ 143064 ⁵¹		G55910	G56998 ⁴⁰	143064 ⁵¹

INTEGRA

94-01	All		142230 ⁵³ 143064 ⁵¹	143064 ⁵¹
	Exc. RS & Type R Models		M55802 ⁴⁶
	Exc.Type R Models Left		G56993 ⁴⁰	G56995 ⁴⁰
	Exc.Type R Models Right		G56994 ⁴⁰	G56995 ⁴⁰
90-93	All		142230 ⁵³ 143064 ⁵¹	142230 ⁵³ 143064 ⁵¹

LEGEND

91-95	All		143063 ⁵¹
86-90	Auto-Leveling System		142230 ⁵³ 143064 ⁵¹	143063 ⁵¹

MDX

07-13	Left Exc. Active Suspension		G52249	G57560 ⁴⁰		G64080
	Right Exc. Active Suspension		G52250	G57561 ⁴⁰		G64080
03-06	Left		G52140	143315 ⁵⁴		G64003	61704
	Right		G52141	143315 ⁵⁴		G64003	61704
01-02	Left		G56759	G57119 ⁴⁰	143315 ⁵⁴		G64003	61704
	Right		G56758	G57120 ⁴⁰	143315 ⁵⁴		G64003	61704

RDX

07-12	Left		G52187		G51966
-------	------	--	--------	------	------	------	------	--	--------	------	------	------	------

40 Complete Assembled Unit.;



51 Strut Cushion for use with the Strut/Cartridge/Shocks.;

54 Kit with Mount and Bearing. Hardware from O.E. Part may need to be reused.;

46 Upper Mount orientation may be required.;

53 Hardware from O.E. Part may need to be reused.;



APPLICATION GUIDE

Year	Fitment Notes										
		Ultra	Ready Mounts	Max Control\ LTV\ ProGuard\ Guardian	Strut Cushion\ Strut Mount\ Dampers\ Stabilizer	HiJackers\ Load Carrier\ Classic	Ultra	Ready Mounts	Max Control\ LTV\ ProGuard\ Guardian	Strut Cushion\ Strut Mount\ Dampers\ Stabilizer	HiJackers\ Load Carrier\ Classic



ACURA

ACURA







RDX (cont)

07-12	Right		G52188		G51966
-------	-------	---	--------	------	------	------	------	---	--------	------	------	------	------



RL

05-12	All		G51911	
-------	-----	---	--------	------	------	------	------	---	------	------	------	------	------















RSX

05-06	All			G51914	142230 ⁵³
02-06	Base & Type S Models		143353 ⁵⁴	
02-04	All			142230 ⁵³





SLX

96-99	All		G63707		G63708	61608
-------	-----	---	--------	------	------	------	------	---	--------	------	-------	------	------



TL

13-14	All		142230 ⁵³		G51919
09-12	All		142230 ⁵³		G51919	142230 ⁵³
04-08	All		142230 ⁵³		G51738	G57056 ⁴⁰	142230 ⁵³
99-03	Left		G56991 ⁴⁰	142230 ⁵³		M55871	142230 ⁵³
	Right		G56992 ⁴⁰	142230 ⁵³		M55871	142230 ⁵³
	Base SubModel			G56943 ⁴⁰
95-98	All		142230 ⁵³	





TSX

09-14	All			G51919
04-08	All			G51847

VIGOR

92-94	All		142230 ⁵³ 143064 ⁵¹		143064 ⁵¹
-------	-----	---	------	------	------	--	------	---	------	------	------	----------------------	------







ZDX

10-13	Left Exc. Electronic Suspension		G52249		G64080
	Right Exc. Electronic Suspension		G52250		G64080

AMERICAN MOTORS

AMERICAN MOTORS

AMBASSADOR

70-74	All		82126		81340	43140 ⁹ 49203 ⁷
67-69	All			43140 ⁹ 49205 ⁷ 82155
60-66	All			82066

7 Pair Packs, Air hose kit included.;

40 Complete Assembled Unit.;



53 Hardware from O.E. Part may need to be reused.;

8 Pair Packs.;

51 Strut Cushion for use with the Strut/Cartridge/Shocks.;

54 Kit with Mount and Bearing. Hardware from O.E. Part may need to be reused.;

APPLICATION GUIDE

Year	Fitment Notes										
		Ultra	Ready Mounts	Max Control\ LTV\ ProGuard\ Guardian	Strut Cushion\ Strut Mount\ Dampers\ Stabilizer	HiJackers\ Load Carrier\ Classic	Ultra	Ready Mounts	Max Control\ LTV\ ProGuard\ Guardian	Strut Cushion\ Strut Mount\ Dampers\ Stabilizer	HiJackers\ Load Carrier\ Classic

AMERICAN MOTORS

AMERICAN

64-68	All		82069		43140 ⁸ 49205 ⁷ 82155
61-63	All		43140 ⁸ 49205 ⁷ 82155
59-60	All		43140 ⁸ 82155
58	All		82066

AMERICAN MOTORS

AMX

78-80	All		82126		82125
70	All		82126		81340	43140 ⁸ 49203 ⁷
68-69	All		82069		43140 ⁸ 82155

CLASSIC

61-66	All		82066
-------	-----	--	------	------	------	------	------	--	------	------	------	------	------	-------

CONCORD

78-83	All		82126		82125
-------	-----	--	------	------	------	------	-------	--	------	------	------	------	------	-------

EAGLE

80-88	All		81491	81340	43140 ⁸ 49203 ⁷
	Steering Stabilizer		6804SE ⁸⁰											

GREMLIN

71-78	All		82126		82125
70	All		82126		49131 ⁷ 82051

HORNET

71-77	All		82126		82125
70	All		82126		49131 ⁷ 82051

JAVELIN

70-74	All		82126		81340	43140 ⁸ 49203 ⁷
68-69	All		82069		43140 ⁸ 49205 ⁷ 82155

MARLIN

67	All		43140 ⁸ 49205 ⁷ 82155
65-66	All		82066

MATADOR

71-78	All		82126		81340	43140 ⁸ 49203 ⁷
-------	-----	--	------	------	------	------	-------	--	------	------	-------	------	------	--

PACER

75-80	All		82025		81270	49105 ⁷
-------	-----	--	------	------	------	------	-------	--	------	------	-------	------	------	--------------------

RAMBLER

69	All		82069		43140 ⁸ 49205 ⁷ 82155
----	-----	--	------	------	------	------	-------	--	------	------	------	------	------	---



7 Pair Packs, Air hose kit included.;

8 Pair Packs.;

80 Mounting bracket not required, install on O.E. Shock Mounts. See Ref. C for

optional Steering Stabilizer Boots.;

APPLICATION GUIDE

Year	Fitment Notes										
		Ultra	Ready Mounts	Max Control\ LTV\ ProGuard\ Guardian	Strut Cushion\ Strut Mount\ Dampers\ Stabilizer	HiJackers\ Load Carrier\ Classic	Ultra	Ready Mounts	Max Control\ LTV\ ProGuard\ Guardian	Strut Cushion\ Strut Mount\ Dampers\ Stabilizer	HiJackers\ Load Carrier\ Classic

AUDI

AUDI

4000

80-87	All				142195 ⁵³ 143057 ⁵¹					143061 ⁵¹	
-------	-----	--	--	--	--	--	--	--	--	----------------------	--

4000 QUATTRO

84-87	All				142195 ⁵³ 143057 ⁵¹					143061 ⁵¹	
-------	-----	--	--	--	--	--	--	--	--	----------------------	--

A3

12-13	All		G57277 ⁴⁰								
06-13	Exc. Electronic Suspension							G51799			
06-11	All		G57277 ⁴⁰		143344 ⁵³					143345 ⁵³	

A3 QUATTRO

06-13	Exc. Electronic Suspension							G51799			
04-13	All		G57277 ⁴⁰								

A4

01-08	All		G51740					G69586			
00	All		G51740								
96-99	Exc. Sport Suspension		G51097								

A4 QUATTRO

01-08	Mfg. from 11/00; Exc. Sport Suspension							G69586			
00-08	Mfg. from 11/00; Exc. Sport Suspension		G51740								
96-00	Mfg. to 11/00; Exc. Sport Suspension		G51097								

A6

00-04	Left Exc. Sport Suspension		G57135 ⁴⁰								
	Right Exc. Sport Suspension		G57136 ⁴⁰								
98-04	All							G69946		142653 ⁵³	

A6 QUATTRO

00-04	Left Exc. Sport Suspension		G57135 ⁴⁰								
	Right Exc. Sport Suspension		G57136 ⁴⁰								
98-04	All							G51742			
95-97	All				143061 ⁵¹			G51742			

COUPE

83-87	All				142195 ⁵³ 143057 ⁵¹					143061 ⁵¹	
-------	-----	--	--	--	--	--	--	--	--	----------------------	--





COUPE QUATTRO

90-91	All				142195 ⁵³ 143057 ⁵¹						
-------	-----	--	--	--	--	--	--	--	--	--	--

40 Complete Assembled Unit;

51 Strut Cushion for use with the Strut/Cartridge/Shocks.;



APPLICATION GUIDE

Year	Fitment Notes										
		 Ultra	Ready Mounts	Max Control\ LTV\ ProGuard\ Guardian	Strut Cushion\ Strut Mount\ Dampers\ Stabilizer	HiJackers\ Load Carrier\ Classic	 Ultra	Ready Mounts	Max Control\ LTV\ ProGuard\ Guardian	Strut Cushion\ Strut Mount\ Dampers\ Stabilizer	HiJackers\ Load Carrier\ Classic

AUDI

AUDI





FOX

73-79	All										143059 ⁵¹	
-------	-----	---	--	--	--	--	---	--	--	--	----------------------	--





QUATTRO

84-86	All							G51742				
-------	-----	---	--	--	--	--	---	--------	--	--	--	--



TT

08-09	All					143344 ⁵³					143345 ⁵³	
00-06	All					142651 ⁵⁴		69420				

TT QUATTRO

08-10	All					143344 ⁵³					143345 ⁵³	
00-06	All					142651 ⁵⁴						



V8 QUATTRO

90-94	All					143057 ⁵¹						
-------	-----	---	--	--	--	----------------------	---	--	--	--	--	--

AVANTI

AVANTI







II

89-91	All		69600					69724				
87-88	All		69600					69604				









BMW

BMW







128i

08-13	All							70045 ⁹⁷				
	Left Exc. Sport Suspension		G52142	G57363 ⁴⁰								
	Right Exc. Sport Suspension		G52143	G57364 ⁴⁰								

135i

12-13	Left Exc. Sport Suspension		G52142	G57363 ⁴⁰				70045 ⁹⁷				
	Right Exc. Sport Suspension		G52143	G57364 ⁴⁰				70045 ⁹⁷				
08-11	All							70045 ⁹⁷				
	Left Exc. Sport Suspension		G52142	G57363 ⁴⁰								
	Right Exc. Sport Suspension		G52143	G57364 ⁴⁰								

318i

99	All							69863				
92-98	All					143061 ⁵¹		69863			142135 ⁵³	
91	All					143061 ⁵¹		69725			142135 ⁵³	

40 Complete Assembled Unit.;



53 Hardware from O.E. Part may need to be reused.;

97 Notice: The level of difficulty to install this product is moderately high. Please review Gabriel Technical Bulletin 70045 carefully before proceeding. (<https://gabriel.com/answergarage/lv-technical-bulletins>);

51 Strut Cushion for use with the Strut/Cartridge/Shocks.;

54 Kit with Mount and Bearing. Hardware from O.E. Part may need to be reused.;

APPLICATION GUIDE

Year	Fitment Notes										
		Ultra	Ready Mounts	Max Control LTV ProGuard Guardian	Strut Cushion\ Strut Mount\ Dampers\ Stabilizer	HiJackers\ Load Carrier\ Classic	Ultra	Ready Mounts	Max Control LTV ProGuard Guardian	Strut Cushion\ Strut Mount\ Dampers\ Stabilizer	HiJackers\ Load Carrier\ Classic

BMW

BMW

318i (cont)

84-85	All	143061 ⁵¹	69725	142135 ⁵³
-------	-----	-------	-------	-------	----------------------	-------	-------	-------	-------	----------------------	-------

318IS

92-98	All	143061 ⁵¹	69863	142135 ⁵³
91	All	143061 ⁵¹	69725	142135 ⁵³

318TI

95-99	All	143057 ⁵¹	69903	142135 ⁵³
-------	-----	-------	-------	-------	----------------------	-------	-------	-------	-------	----------------------	-------

323Ci

00	All	69863
	Coupe	143082 ⁵³
	Coupe Left Exc. Sport Suspension	G52237
	Coupe Right Exc. Sport Suspension	G52238

323i

07-11	Left Exc. Sport Suspension	G52142
	Right Exc. Sport Suspension	G52143
00	Sedan Left Exc. Sport Suspension	G52237
	Sedan Right Exc. Sport Suspension	G52238
	Wagon	143082 ⁵³	69863
98-99	All	143061 ⁵¹	69863	142135 ⁵³

323IS

98-99	All	69863
-------	-----	-------	-------	-------	-------	-------	-------	-------	-------	-------	-------

325

87-88	All	143061 ⁵¹	69725	142135 ⁵³
86	All	69725



325Ci

01-06	All	69863
	Left Exc. Sport Suspension	G52237
	Right Exc. Sport Suspension	G52238
	Sport Suspension; Exc. M-Sport Pack II	143082 ⁵³

325E

84-87	All	143061 ⁵¹	69725	142135 ⁵³
-------	-----	-------	-------	-------	----------------------	-------	-------	-------	-------	----------------------	-------

APPLICATION GUIDE

Year	Fitment Notes										
		Ultra	Ready Mounts	Max Control\ LTV\ ProGuard\ Guardian	Strut Cushion\ Strut Mount\ Dampers\ Stabilizer	HiJackers\ Load Carrier\ Classic	Ultra	Ready Mounts	Max Control\ LTV\ ProGuard\ Guardian	Strut Cushion\ Strut Mount\ Dampers\ Stabilizer	HiJackers\ Load Carrier\ Classic

BMW

BMW

325I

01-06	Mfg. to 9/01; Sport Suspension	↓	143082 ⁵³	↓
06	All	↓	↓	70045 ⁹⁷
	Left Exc. Sport Suspension	↓	G57363 ⁴⁰	↓
	Left Mfg. to 9/01; Sport Suspension	↓	G52142	↓
	Right Exc. Sport Suspension	↓	G57364 ⁴⁰	↓
	Right Mfg. to 9/01; Sport Suspension	↓	G52143	↓
01-05	All	↓	↓	69863
	Sedan Left Exc. Sport Suspension	↓	G52237	↓
	Sedan Right Exc. Sport Suspension	↓	G52238	↓
92-95	E36(MfrBodyCode)	↓	↓	69863
87-95	All	↓	143061 ⁵¹	↓	142135 ⁵³
87-92	E30(MfrBodyCode) Exc. Sport Suspension	↓	↓	69725

325IS

87-92	All	↓	143061 ⁵¹	↓	69725	142135 ⁵³
-------	-----	---	------	------	------	----------------------	------	---	-------	------	------	----------------------	------

325IX

88-91	All	↓	143061 ⁵¹	↓	142135 ⁵³
-------	-----	---	------	------	------	----------------------	------	---	------	------	------	----------------------	------

328CI

00	All	↓	143082 ⁵³	↓	69863
	Coupe Left Exc. Sport Suspension	↓	G52237	↓
	Coupe Right Exc. Sport Suspension	↓	G52238	↓

328D

14	All	↓	↓	70045 ⁹⁷
----	-----	---	------	------	------	------	------	---	---------------------	------	------	------	------

328D XDRIVE

14	All	↓	↓	70045 ⁹⁷
----	-----	---	------	------	------	------	------	---	---------------------	------	------	------	------

328I

07-14	Exc. F30 Suspension	↓	↓	70045 ⁹⁷
07-13	Left	↓	G52142	↓
	Left Exc. Sport Suspension	↓	G57363 ⁴⁰	↓
	Right	↓	G52143	↓
	Right Exc. Sport Suspension	↓	G57364 ⁴⁰	↓



40 Complete Assembled Unit.;

53 Hardware from O.E. Part may need to be reused.;

51 Strut Cushion for use with the Strut/Cartridge/Shocks.;

97 Notice: The level of difficulty to install this product is moderately high. Please review Gabriel Technical Bulletin 70045 carefully before proceeding.(<https://gabriel.com/answergarage/iv-technical-bulletins>);

APPLICATION GUIDE

Year	Fitment Notes										
		Ultra	Ready Mounts	Max Control LTV ProGuard Guardian	Strut Cushion\ Strut Mount\ Dampers\ Stabilizer	HiJackers\ Load Carrier\ Classic	Ultra	Ready Mounts	Max Control LTV ProGuard Guardian	Strut Cushion\ Strut Mount\ Dampers\ Stabilizer	HiJackers\ Load Carrier\ Classic

BMW

BMW

328i (cont)

99-00	All	143082 ⁵³	69863
96-98	All	143061 ⁵¹	69863	142135 ⁵³

328IS

96-99	All	69863
-------	-----	-------	-------	-------	-------	-------	-------	-------	-------	-------	-------

328XI

07-08	All	70045 ⁹⁷
-------	-----	-------	-------	-------	-------	-------	---------------------	-------	-------	-------	-------

330Ci

01-06	All	69863
	Exc. Sport Suspension M-Sport Pack II	143082 ⁵³
	Left Exc. Sport Suspension	G52237
	Right Exc. Sport Suspension	G52238

330i

06	All	70045 ⁹⁷
	Left	G52142
	Left Exc. Sport Suspension	G57363 ⁴⁰
	Right	G52143
	Right Exc. Sport Suspension	G57364 ⁴⁰
01-05	All	69863

335D

09-11	Left	G52142
	Right	G52143

335i

07-13	All	70045 ⁹⁷
	Left	G52142
	Left Exc. Sport Suspension	G57363 ⁴⁰
	Right	G52143
	Right Exc. Sport Suspension	G57364 ⁴⁰

335IS

11-13	Left	G52142	70045 ⁹⁷
	Right	G52143	70045 ⁹⁷



40 Complete Assembled Unit;

53 Hardware from O.E. Part may need to be reused.;

51 Strut Cushion for use with the Strut/Cartridge/Shocks.;

97 Notice: The level of difficulty to install this product is moderately high. Please review Gabriel Technical Bulletin 70045 carefully before proceeding (<https://gabriel.com/answergarage/lv-technical-bulletins>);

APPLICATION GUIDE

Year	Fitment Notes										
		Ultra	Ready Mounts	Max Control\ LTV\ ProGuard\ Guardian	Strut Cushion\ Strut Mount\ Dampers\ Stabilizer	HiJackers\ Load Carrier\ Classic	Ultra	Ready Mounts	Max Control\ LTV\ ProGuard\ Guardian	Strut Cushion\ Strut Mount\ Dampers\ Stabilizer	HiJackers\ Load Carrier\ Classic

BMW

BMW

525I

08	All
04-07	All	G52314	G51900
01-03	Wagon Exc. Electronic Adjustable Suspension	69998
89-95	All	143061 ⁵¹

528E

82-88	All	143061 ⁵¹
-------	-----	-------	-------	-------	-------	----------------------	-------	-------	-------	-------	-------	-------	-------	-------	-------	-------	-------	-------	-------	-------

528I

08-10	All	G52314
99-00	Wagon	69998
97-00	Exc. Electronic Adjustable Suspension	143082 ⁵³

530I

08	All	G51900
04-07	All	G52314	G51900
94-95	All	143061 ⁵¹

533I

83-84	All	143061 ⁵¹
-------	-----	-------	-------	-------	-------	----------------------	-------	-------	-------	-------	-------	-------	-------	-------	-------	-------	-------	-------	-------	-------

535I

08-10	All	G52314
90-93	Mfg. from 8/90	143061 ⁵¹
85-89	All	143061 ⁵¹

535IS

88	All	143061 ⁵¹
----	-----	-------	-------	-------	-------	----------------------	-------	-------	-------	-------	-------	-------	-------	-------	-------	-------	-------	-------	-------	-------

540I

00-03	Wagon Exc. Electronic Adjustable Suspension	69998
-------	---	-------	-------	-------	-------	-------	-------	-------	-------	-------	-------	-------	-------	-------	-------	-------	-------	-------	-------	-------

545I

04-05	All	G52314
-------	-----	--------	-------	-------	-------	-------	-------	-------	-------	-------	-------	-------	-------	-------	-------	-------	-------	-------	-------	-------



550I

06-10	All	G52314
-------	-----	--------	-------	-------	-------	-------	-------	-------	-------	-------	-------	-------	-------	-------	-------	-------	-------	-------	-------	-------

635CSI

85-89	All	143061 ⁵¹	143063 ⁵¹
-------	-----	-------	-------	-------	-------	----------------------	-------	-------	-------	-------	-------	-------	-------	-------	-------	-------	-------	----------------------	-------	-------

APPLICATION GUIDE

Year	Fitment Notes										
		Ultra	Ready Mounts	Max Control LTV ProGuard Guardian	Strut Cushion\ Strut Mount\ Dampers\ Stabilizer	HiJackers\ Load Carrier\ Classic	Ultra	Ready Mounts	Max Control LTV ProGuard Guardian	Strut Cushion\ Strut Mount\ Dampers\ Stabilizer	HiJackers\ Load Carrier\ Classic

BMW

BMW

735i

86-92	All		143061 ⁵¹
-------	-----	--	------	------	------	----------------------	------	--	------	------	------	------

735iL

88-92	All		143061 ⁵¹
-------	-----	--	------	------	------	----------------------	------	--	------	------	------	------

M3

88-91	All		69725	142135 ⁵³
-------	-----	--	------	------	------	------	------	-------	------	------	------	----------------------	------

X3

04-10	Left		G52199	70034
	Right		G52200	70034

X5

00-06	All		69725
	Coil(FrontSpringType) Left		G52144
	Coil(FrontSpringType) Right		G52145

BUICK

BUICK

ALLURE

10	FWD, Left Exc. Electronic Suspension		G52278	70059
	FWD, Right Exc. Electronic Suspension		G52279	70059
05-09	All		G55948	G57060 ⁴⁰	142526 ⁵⁴	143061 ⁵¹
	Exc. Models w/ 17" Wheels		G55949
	Left		143073 ⁵³
	Left Models w/ 16" Wheels		G56924 ⁴⁰
	Models w/ 17" or 18" Wheels		G52244
	Right		143074 ⁵³
	Right Models w/ 16" Wheels		G56925 ⁴⁰

APOLLO

73-75	All		69600	81494	34051 ⁸
73	Heavy Duty Suspension		69724	81514	49157 ⁷

CENTURION

71-73	All		69675 ⁵	81446	34073 ⁸	69724 ⁵	81514	43049 ⁸ 49131 ³⁰
-------	-----	--	--------------------	------	-------	------	--------------------	--------------------	------	-------	------	---	------

CENTURY

97-05	All		G55948	G57060 ⁴⁰	142526 ⁵⁴	G55949	143061 ⁵¹
-------	-----	--	--------	----------------------	------	----------------------	------	--------	------	------	------	----------------------	------

5 Use kit No. 140719 to replace O.E. hardware for lower shock absorber mounting when studs break or self-tapping screws are not longer useable;

8 Pair Packs;

40 Complete Assembled Unit;

53 Hardware from O.E. Part may need to be reused;



7 Pair Packs, Air hose kit included.;

30 For GM Vehicles equipped with factory installed leveling systems, see Ref A.;

51 Strut Cushion for use with the Strut/Cartridge/Shocks.;

54 Kit with Mount and Bearing. Hardware from O.E. Part may need to be reused.;















APPLICATION GUIDE

Year	Fitment Notes										
		Ultra	Ready Mounts	Max Control\ LTV\ ProGuard\ Guardian	Strut Cushion\ Strut Mount\ Dampers\ Stabilizer	HiJackers\ Load Carrier\ Classic	Ultra	Ready Mounts	Max Control\ LTV\ ProGuard\ Guardian	Strut Cushion\ Strut Mount\ Dampers\ Stabilizer	HiJackers\ Load Carrier\ Classic

BUICK

BUICK















CENTURY (cont)

97-05	Left		G55948	G57060 ⁴⁰	142526 ⁵⁴		G55949	G56924 ⁴⁰	143073 ⁵³
	Right		G55948	G57060 ⁴⁰	142526 ⁵⁴		G55949	G56925 ⁴⁰	143074 ⁵³
78-81	All		69600	81494	34051 ⁸		69604	81492	43060 ⁸ 49334 ³⁰
73-77	All		69600	81494	34051 ⁸		69604	81492	43060 ⁸ 49152 ³⁰
58	All		81270		49310 ⁷ 82156
57	All			49310 ⁷ 82156
56	All		82087	









COMMERCIAL CHASSIS

91-96	All		69675 ⁵	81446	34073 ⁸		43049 ⁸
-------	-----	---	--------------------	------	-------	------	--------------------	---	------	------	------	------	--------------------





ELECTRA

85-90	All		G56701	143061 ⁵¹	
	Air(RearSpringType) Conventional Replacement for Air Assist Rear Susp. Strut w/Upper Mount			G56726 ⁴³
85-89	Estate Wagon		34073 ⁸	
71-84	All		69675 ⁵	81446	34073 ⁸		69724	81514	43049 ⁸ 49131 ³⁰
65-70	All		82601		82602
61-64	All		82087		82609
59-60	Exc. Air Suspension			43140 ⁸ 82155





ENCLAVE

13-17	All		G57709 ⁴⁰		G64040
08-12	All		G52125	143366 ⁵³		G64040
	AWD		G57109 ⁴⁰	
	FWD		G57314 ⁴⁰	



ENCORE

13-22	Left		G52494		G511030
	Right		G52495		G511030

ESTATE WAGON

71-83	All		69675 ⁵	81446	34073 ⁸		69604	81492	43060 ⁸ 49152 ³⁰
70	All		82601		69724	81514	49128 ³⁰

GRAN SPORT

65-67	All		82138		69604	81492	43060 ⁸ 49152 ³⁰
-------	-----	---	------	------	------	------	-------	---	-------	------	-------	------	---

5 Use kit No. 140719 to replace O.E. hardware for lower shock absorber mounting when studs break or self-tapping screws are not longer useable.;

8 Pair Packs.;

40 Complete Assembled Unit.;

51 Strut Cushion for use with the Strut/Cartridge/Shocks.;

54 Kit with Mount and Bearing. Hardware from O.E. Part may need to be reused.;



7 Pair Packs, Air hose kit included.;

30 For GM Vehicles equipped with factory installed leveling systems, see Ref. A.;

43 Does not include springs due to vehicle design. See Ref. D for procedures to replace Elec Adj Susp with non-adj product.;

53 Hardware from O.E. Part may need to be reused.;



APPLICATION GUIDE

Year	Fitment Notes										
		Ultra	Ready Mounts	Max Control LTV ProGuard Guardian	Strut Cushion\ Strut Mount\ Dampers\ Stabilizer	HiJackers\ Load Carrier\ Classic	Ultra	Ready Mounts	Max Control LTV ProGuard Guardian	Strut Cushion\ Strut Mount\ Dampers\ Stabilizer	HiJackers\ Load Carrier\ Classic





BUICK

BUICK



















GS / GS350 / GS400 / GS455

68-72	All		69600	81494		69604	81492	43060 ⁸ 49152 ³⁰
-------	-----	---	-------	------	-------	------	------	---	-------	------	-------	------	---

























INVICTA

61-63	All		82087		82609
59-60	Exc. Air Suspension			43140 ⁸ 82155



LACROSSE

10-16	FWD, Left Exc. Electronic Suspension		G52278		70059
	FWD, Right Exc. Electronic Suspension		G52279		70059
05-09	All		G55948	G57060 ⁴⁰	142526 ⁵⁴		143061 ⁵¹
	Exc. Models w/ 17" Wheels			G55949
	Left			143073 ⁵³
	Left Models w/ 16" Wheels			G56924 ⁴⁰
	Models w/ 17" or 18" Wheels			G52244
	Right			143074 ⁵³
	Right Models w/ 16" Wheels			G56925 ⁴⁰

LESABRE

00-05	Exc. Electronic Adjustable Suspension		G56509	G57051 ⁴⁰	
	With OE Style air fitting			49255 ⁷
	Without OE Style air fitting			49228 ³⁰
91-99	All		G56718 ⁹	M56718 ⁹	142530 ⁵⁴	
86-99	Coil(RearSpringType)			G56726 ⁴³
90	Early Design Front Strut w/ Spring Guard		G56701	143061 ⁵¹	
	Late Design Front Strut without Spring Guard		G56718 ⁹	M56718 ⁹	
86-89	All		G56701	143061 ⁵¹	34073 ⁸	
71-85	All		69675 ⁵	81446	34073 ⁸		69724	81514	43049 ⁸ 49131 ³⁰
65-70	All		82601		82602
61-64	All		82087		82609
59-60	Exc. Air Suspension			43140 ⁸ 82155

LIMITED

58	All		81270		49310 ⁷ 82156
----	-----	---	------	------	-------	------	------	---	------	------	------	------	-----------------------------

5 Use kit No. 140719 to replace O.E. hardware for lower shock absorber mounting when studs break or self-tapping screws are not longer useable.;

8 Pair Packs.;

30 For GM Vehicles equipped with factory installed leveling systems, see Ref. A.;

43 Does not include springs due to vehicle design. See Ref. D for procedures to replace Elec Adj Susp with non-adj product.;

53 Hardware from O.E. Part may need to be reused.;

7 Pair Packs, Air hose kit included.;



9 See Ref. D for procedures to replace Elec Adj Susp with non-adj product.;

40 Complete Assembled Unit.;

51 Strut Cushion for use with the Strut/Cartridge/Shocks.;

54 Kit with Mount and Bearing. Hardware from O.E. Part may need to be reused.;

APPLICATION GUIDE

Year	Fitment Notes										
		Ultra	Ready Mounts	Max Control\ LTV\ ProGuard\ Guardian	Strut Cushion\ Strut Mount\ Dampers\ Stabilizer	HiJackers\ Load Carrier\ Classic	Ultra	Ready Mounts	Max Control\ LTV\ ProGuard\ Guardian	Strut Cushion\ Strut Mount\ Dampers\ Stabilizer	HiJackers\ Load Carrier\ Classic

BUICK

BUICK

LUCERNE

06-11	Exc. Magnetic Ride Control Suspension	G52116	G57324 ⁴⁰	49228 ³⁰
-------	---------------------------------------	--------	----------------------	------	------	------	------	------	------	------	---------------------

PARK AVENUE

98-05	All	G56929 ⁴⁰	143057 ⁵¹
97-05	With OE Style air fitting	49255 ⁷
	Without OE Style air fitting	49228 ³⁰
97	All	143057 ⁵¹
91-96	All	G56718 ⁹	M56718 ⁸
	Air(RearSpringType) Conventional Replacement for Air Assist Susp; Exc. Elec. Adj. Susp.	G56726 ⁴³

RAINIER

04-07	All	G51718 ⁴⁵	G57022 ⁴⁰	61717 77971
	Coil(FrontSpringType)	G63842

REGAL

11-17	FWD, Exc. Active Suspension	G51982
97-04	All	G55948	G57060 ⁴⁰	G55949	143061 ⁵¹
	Exc. Heavy Duty Suspension	142526 ⁵⁴
	Left	G56924 ⁴⁰
	Left Exc. Heavy Duty Suspension	143073 ⁵³
	Right	G56925 ⁴⁰
	Right Exc. Heavy Duty Suspension	143074 ⁵³
88-96	All	M56708
78-87	All	69600	81494	34051 ⁸	69604	81492	43060 ⁸ 49334 ³⁰
73-77	All	69600	81494	34051 ⁸	69604	81492	43060 ⁸ 49152 ³⁰

RENDEZVOUS

02-07	Exc. Hydraulic Self-Leveling System	G57274 ⁴⁰	G63868	61777
-------	-------------------------------------	------	----------------------	------	------	------	------	--------	------	-------	------

RIVIERA

98-99	All	G56929 ⁴⁰	143057 ⁵¹
95-99	With OE Style air fitting	49255 ⁷
	Without OE Style air fitting	49228 ³⁰
97	All	143057 ⁵¹

7 Pair Packs, Air hose kit included.;

9 See Ref. D for procedures to replace Elec Adj Susp with non-adj product.;

40 Complete Assembled Unit.;

45 Strut must be rotated to align notch with lower control arm.;

53 Hardware from O.E. Part may need to be reused.;

8 Pair Packs.;



30 For GM Vehicles equipped with factory installed leveling systems, see Ref A.;

43 Does not include springs due to vehicle design. See Ref. D for procedures to replace Elec Adj Susp with non-adj product.;

51 Strut Cushion for use with the Strut/Cartridge/Shocks.;

54 Kit with Mount and Bearing. Hardware from O.E. Part may need to be reused.;









APPLICATION GUIDE

Year	Fitment Notes										
		Ultra	Ready Mounts	Max Control LTV ProGuard Guardian	Strut Cushion\ Strut Mount\ Dampers\ Stabilizer	HiJackers\ Load Carrier\ Classic	Ultra	Ready Mounts	Max Control LTV ProGuard Guardian	Strut Cushion\ Strut Mount\ Dampers\ Stabilizer	HiJackers\ Load Carrier\ Classic

















BUICK

BUICK

















RIVIERA (cont)

95-96	All		G56718 ⁹	M56718 ⁹			
86-89	All		143061 ⁵¹			
71-78	All		69675 ⁵	81446	34073 ⁸		69724	81514	43049 ⁸ 49131 ³⁰
66-70	All		82601		82618
63-65	All		82087		82609















ROADMASTER

92-96	All		69675 ⁵	81446	34073 ⁸	
	Sedan			69724	81514	43049 ⁸ 49131 ³⁰
	Wagon			69604	81492	43060 ⁸ 49152 ³⁰
91	All		81446	34073 ⁸	
	Wagon		69675 ⁵		69604	81492	43060 ⁸ 49152 ³⁰
58	Exc. Air Suspension		81270		49310 ⁷ 82156
57	Exc. Air Suspension			49310 ⁷ 82156
56	Exc. Air Suspension		82087		81147



SKYLARK

92-98	All		143059 ⁵¹	
75-79	All		69600	81494	34051 ⁸	
69-72	All		69600	81494	34051 ⁸		69604	81492	43060 ⁸ 49152 ³⁰
68	All		69600	81494		69604	81492	43060 ⁸ 49152 ³⁰
	Heavy Duty Suspension		34051 ⁸	
64-67	Exc. Heavy Duty Suspension			69724	81514	43049 ⁸ 49131 ³⁰
	Heavy Duty Suspension		82138		69604	81492	43060 ⁸ 49152 ³⁰
61-63	All			81495	43140 ⁸ 49205 ⁷

SPECIAL

68-69	All		69600	81494	34051 ⁸		69604	81492	43060 ⁸ 49152 ³⁰
64-67	Exc. Heavy Duty Suspension			69724	81514	43049 ⁸ 49131 ³⁰
	Heavy Duty Suspension		82138		69604	81492	43060 ⁸ 49152 ³⁰
61-63	All			81495	43140 ⁸ 49205 ⁷
58	Exc. Air Suspension		81270		49310 ⁷ 82156
57	Exc. Air Suspension			49310 ⁷ 82156
56	All		82087		81147

SPORTWAGON

70-72	All		69600	81494	34051 ⁸		69604	81492	43060 ⁸ 49152 ³⁰
-------	-----	---	-------	------	-------	------	--------------------	---	-------	------	-------	------	---

5 Use kit No. 140719 to replace O.E. hardware for lower shock absorber mounting when studs break or self-tapping screws are not longer useable.;

8 Pair Packs.;



30 For GM Vehicles equipped with factory installed leveling systems, see Ref A.;

7 Pair Packs, Air hose kit included.;

9 See Ref. D for procedures to replace Elec Adj Susp with non-adj product.;

51 Strut Cushion for use with the Strut/Cartridge/Shocks.;





APPLICATION GUIDE

Year	Fitment Notes										
		Ultra	Ready Mounts	Max Control\ LTV\ ProGuard\ Guardian	Strut Cushion\ Strut Mount\ Dampers\ Stabilizer	HiJackers\ Load Carrier\ Classic	Ultra	Ready Mounts	Max Control\ LTV\ ProGuard\ Guardian	Strut Cushion\ Strut Mount\ Dampers\ Stabilizer	HiJackers\ Load Carrier\ Classic









BUICK

BUICK









SPORTWAGON (cont)

68-69	All		69600	81494	34051 ⁸		69606	81495	43140 ⁹ 49205 ⁷
64-67	All		82138		69606	81495	43140 ⁹ 49205 ⁷





SUPER

58	Exc. Air Suspension		81270		49310 ⁷ 82156
57	Exc. Air Suspension			49310 ⁷ 82156
56	All			81147
	Exc. Air Suspension		82087	





TERRAZA

05-07	FWD		G57142 ⁴⁰	142526 ⁵⁴	
	FWD, Exc. Air-Leveling Suspension			G63776	49230 ⁷
	FWD, Exc. Auto-Leveling System		G52025	
05-06	AWD		G55948	

VERANO

12-17	Left		G57377 ⁴⁰	
	Right		G57378 ⁴⁰	





WILDCAT

65-70	All		82601		82602
63-64	All		82087		82609



CADILLAC

CADILLAC



60 SPECIAL

93	All		G56718 ⁹	M56718 ⁹	
	Coil(RearSpringType) Conventional Type Replacement for Air Assist Rear Suspension			G56726 ⁴³







ALLANTE

87-88	All		143061 ⁵¹	
-------	-----	---	------	------	------	----------------------	------	---	------	------	------	------	------

BROUGHAM

87-92	All		69675 ⁹	81446	143061 ⁵¹	34073 ⁸		69724	81514	43049 ⁹ 49131 ³⁰
-------	-----	---	--------------------	------	-------	----------------------	--------------------	---	-------	------	-------	------	---

CALAIS

71-76	All		82601		82602
69-70	All		82601	
65-68	All		82601		82060

5 Use kit No. 140719 to replace O.E. hardware for lower shock absorber mounting when studs break or self-tapping screws are not longer useable.;

8 Pair Packs.;

30 For GM Vehicles equipped with factory installed leveling systems, see Ref A.;

43 Does not include springs due to vehicle design. See Ref. D for procedures to replace Elec Adj Susp with non-adj product.;

54 Kit with Mount and Bearing. Hardware from O.E. Part may need to be reused.;



7 Pair Packs, Air hose kit included.;

9 See Ref. D for procedures to replace Elec Adj Susp with non-adj product.;

40 Complete Assembled Unit.;

51 Strut Cushion for use with the Strut/Cartridge/Shocks.;











APPLICATION GUIDE

Year	Fitment Notes										
		Ultra	Ready Mounts	Max Control\ LTV\ ProGuard\ Guardian	Strut Cushion\ Strut Mount\ Dampers\ Stabilizer	HiJackers\ Load Carrier\ Classic	Ultra	Ready Mounts	Max Control\ LTV\ ProGuard\ Guardian	Strut Cushion\ Strut Mount\ Dampers\ Stabilizer	HiJackers\ Load Carrier\ Classic





CADILLAC

CADILLAC































COMMERCIAL CHASSIS

92-96	RWD		69675 ⁵	81446	34073 ⁸		69724	81514	43049 ⁸ 49131 ³⁰
91-93	FWD		G56718 ⁹	M56718 ⁹	
85-90	All		G56701	143061 ⁵¹	
77-84	All		69675 ⁵	81446	34073 ⁸		69724	81514	43049 ⁸ 49131 ³⁰
75-76	All		82601		82125



CTS

08-11	Exc. Magnetic Ride Control Suspension		G51901	
03-07	Exc. Magnetic Ride Control Suspension		G51746		70031









DEVILLE

00-05	Exc. Electronic Adjustable Suspension		G56509	G57051 ⁴⁰		49228 ³⁰
	w/ OE Style air fitting Exc. Electronic Adjustable Suspension			49255 ⁷
91-93	Exc. Electronic Adjustable Suspension		G56718 ⁹	M56718 ⁹	
85-93	Air(RearSpringType) Conventional Type Replacement for Air Assist Rear Suspension			G56726 ⁴³
85-90	All		G56701	143061 ⁵¹	
77-84	All		69675 ⁵	81446	34073 ⁸		69724	81514	43049 ⁸ 49131 ³⁰
71-76	All		82601		82602
69-70	All		82601	
65-68	All		82601		82060
61-64	All		82109		82125
58-60	All		69625	34073 ⁸ 82099		82125
56	All		69625	34073 ⁸ 82099		82034
55	All			82034
54	All			82066
53	All		82026		82066

DTS

06-11	Exc. Magnetic Ride Control Suspension		G52116	G57324 ⁴⁰		49228 ³⁰
-------	---------------------------------------	---	--------	----------------------	------	------	------	---	------	------	------	------	---------------------

ELDORADO

97-02	Exc. Electronic Ride Control			49254 ⁷
86-89	All		143061 ⁵¹	
71-78	All		82010	
68-70	Vertically Mounted		82010		49122 ⁷

5 Use kit No. 140719 to replace O.E. hardware for lower shock absorber mounting when studs break or self-tapping screws are not longer useable.;

8 Pair Packs.;

30 For GM Vehicles equipped with factory installed leveling systems, see Ref A.;

43 Does not include springs due to vehicle design. See Ref. D for procedures to replace Elec Adj Susp with non-adj product.;



7 Pair Packs, Air hose kit included.;

9 See Ref. D for procedures to replace Elec Adj Susp with non-adj product.;

40 Complete Assembled Unit.;

51 Strut Cushion for use with the Strut/Cartridge/Shocks.;

APPLICATION GUIDE

Year	Fitment Notes										
		Ultra	Ready Mounts	Max Control\ LTV\ ProGuard\ Guardian	Strut Cushion\ Strut Mount\ Dampers\ Stabilizer	HiJackers\ Load Carrier\ Classic	Ultra	Ready Mounts	Max Control\ LTV\ ProGuard\ Guardian	Strut Cushion\ Strut Mount\ Dampers\ Stabilizer	HiJackers\ Load Carrier\ Classic

CADILLAC

CADILLAC

ELDORADO (cont)

68-70	Vertically Mounted; Single Leaf Rear Springs		82040
67	Vertically Mounted		82034

ESCALADE

07-13	Exc. Electronic Ride Control		143316 ⁵³	G63866	61675 77953
02-13	AWD, Exc. Z55 Auto Ride Suspension		49235 ⁷
	RWD, Exc. Electronic Ride Control		49155 ⁵
02-06	All		58803 77803
	Exc. Electronic Ride Control		G63866	61675 77953
99-00	All		G63609	58609 61542 77609 81726	G63638	61565 77638	43180 ⁸ 49231 ⁷

ESCALADE ESV

11-13	Exc. Electronic Ride Control		143316 ⁵³
07-10	Exc. Electronic Ride Control		143316 ⁵³	61675
03-06	Exc. Electronic Ride Control		61675

ESCALADE EXT

11-13	Exc. Electronic Ride Control		143316 ⁵³
07-10	Exc. Electronic Ride Control		143316 ⁵³	61675
02-06	Exc. Electronic Ride Control		61675
02-04	All		58803 77803

FLEETWOOD

94-96	All		34073 ⁸
93-96	RWD		69675 ⁵	81446	69724	81514	43049 ⁹ 49131 ³⁰
85-93	Conventional Type Replacement for Air Assist Rear Suspension		G56726 ⁴³
93	All		G56718 ⁹	M56718 ⁹	34073 ⁸
91-92	All		G56718 ⁹	M56718 ⁹
85-90	All		G56701	143061 ⁵¹
85-86	RWD		69675 ⁵	81446	69724	81514	43049 ⁹ 49131 ³⁰
77-84	All		34073 ⁸
	RWD		69675 ⁵	81446	69724	81514	43049 ⁹ 49131 ³⁰
71-76	All		82601
69-70	All		82601
65-68	All		82601

5 Use kit No. 140719 to replace O.E. hardware for lower shock absorber mounting when studs break or self-tapping screws are not longer useable.;

8 Pair Packs.;

30 For GM Vehicles equipped with factory installed leveling systems, see Ref A.;

51 Strut Cushion for use with the Strut/Cartridge/Shocks.;



7 Pair Packs, Air hose kit included.;

9 See Ref. D for procedures to replace Elec Adj Susp with non-adj product.;

43 Does not include springs due to vehicle design. See Ref. D for procedures to replace Elec Adj Susp with non-adj product.;

53 Hardware from O.E. Part may need to be reused.;















APPLICATION GUIDE

Year	Fitment Notes										
		Ultra	Ready Mounts	Max Control\ LTV\ ProGuard\ Guardian	Strut Cushion\ Strut Mount\ Dampers\ Stabilizer	HiJackers\ Load Carrier\ Classic	Ultra	Ready Mounts	Max Control\ LTV\ ProGuard\ Guardian	Strut Cushion\ Strut Mount\ Dampers\ Stabilizer	HiJackers\ Load Carrier\ Classic





CADILLAC

CADILLAC

FLEETWOOD / 60 SERIES / 70 SERIES

61-64	All		82109		82125
57-60	All		69625	34073 ⁸ 82099		82125
56	All		69625	34073 ⁸ 82099		82034
55	All			82034
54	All			82066
52-53	All		82026		82066
50-51	All		82026		82060





SEVILLE

98-04	Exc. Electronic Adjustable Suspension		G56509	G57051 ⁴⁰
	w/ OE Style air fitting Exc. Electronic Adjustable Suspension		49255 ⁷
	Without OE Style air fitting		49228 ³⁰
86-89	All		143061 ⁵¹
76-79	All		69600	81494	14018	34051 ⁸





CHEVROLET

CHEVROLET



ASTRO

90-05	All		G63454	61539 77454	49215 ⁷
	AWD		G63818	58609 61542 77609 81726
	RWD		G63375 ⁵	61555 77375 81713 ⁵
85-89	RWD		G63375 ⁵	61555 77375 81713 ⁵	G63454	61539 77454	49215 ⁷

AVALANCHE 1500

07-13	Exc. Electronic Ride Control		143316 ⁵³
	Exc. Z55 or ZW7 Ride Suspension		G51891	G57125 ⁴⁰	G63866	61675 77953 81930
02-13	4WD, Exc. Z55 Auto Ride Suspension		49235 ⁷
	RWD		49155 ⁷
02-06	Exc. Electronic Ride Control		G63803	58803 61643 77803 81922	G63866	61675 77953 81930

AVALANCHE 2500

02-06	Exc. Electronic Ride Control		G63817	58817 61663 77817 81925	G63866	61675 77953 81930
	4WD, Exc. Z55 Auto Ride Suspension		49235 ⁷
	RWD		49155 ⁷

5 Use kit No. 140719 to replace O.E. hardware for lower shock absorber mounting when studs break or self-tapping screws are not longer useable.;

8 Pair Packs.;

40 Complete Assembled Unit.;



53 Hardware from O.E. Part may need to be reused.;

7 Pair Packs, Air hose kit included.;

30 For GM Vehicles equipped with factory installed leveling systems, see Ref A.;

51 Strut Cushion for use with the Strut/Cartridge/Shocks.;



APPLICATION GUIDE

Year	Fitment Notes										
		Ultra	Ready Mounts	Max Control\ LTV\ ProGuard\ Guardian	Strut Cushion\ Strut Mount\ Dampers\ Stabilizer	HiJackers\ Load Carrier\ Classic	Ultra	Ready Mounts	Max Control\ LTV\ ProGuard\ Guardian	Strut Cushion\ Strut Mount\ Dampers\ Stabilizer	HiJackers\ Load Carrier\ Classic















CHEVROLET

CHEVROLET

AVEO

04-11	Left		G56886	G57130 ⁴⁰	143239 ⁵³
	Right		G56887	G57131 ⁴⁰	143239 ⁵³





BEL AIR

81	All		77375		
	Sedan		69724	81514	43049 ⁹ 49131 ³⁰
	Sedan Police and Taxi Models		G63375 ⁵	61555	
	Sedan; Exc. Police and Taxi Models		69675 ⁵	81446	34073 ⁸	
71-75	Sedan Police and Taxi Models		G63375 ⁵	61555	
	Wagon		81713 ⁵	
65-75	Sedan; Exc. Police and Taxi Models		69675 ⁵	81446	34073 ⁸	
75	All		77375	69724	81514
	Sedan		43049 ⁹ 49131 ³⁰
71-74	All		77375	69724	81514	43049 ⁹ 49131 ³⁰
65-70	All		69724	81514	43049 ⁹ 49131 ³⁰
58-64	All		82118	49131 ³⁰ 82051
55-57	All		69625	34073 ⁸ 82099	82066
51-54	All		82026	43140 ⁹ 82155
50	All		82026
	Exc. Air Suspension		43140 ⁹ 82155





BERETTA

92-96	All		143059 ⁵¹
-------	-----	---	------	------	------	----------------------	------	------	------	------	------

BISCAYNE

71-72	All		69675 ⁵	77375	34073 ⁸	69724	81514	43049 ⁹ 49131 ³⁰
	Police and Taxi Models		61555 81713 ⁵
65-72	Exc. Police and Taxi Models		81446
65-70	All		34073 ⁸	69724	81514	43049 ⁹ 49131 ³⁰
58-64	All		82118	49131 ³⁰ 82051



BLAZER 2WD

95-05	RWD; S Models, Exc. Xtreme Models		G63421	58421 61504 81750	34051 ⁸	663422	61528 77422 81482	43162 ⁹ 49213 ⁷
87-91	Full Size; Exc. Quad Suspension		49155 ⁷
85-86	All		14017
75-86	Steering Stabilizer		6804SE ⁸⁰	6804SE ⁸⁰	6804SE ⁸⁰	6804SE ⁸⁰	6804SE ⁸⁰	6804SE ⁸⁰	6804SE ⁸⁰	6804SE ⁸⁰	6804SE ⁸⁰	6804SE ⁸⁰

5 Use kit No. 140719 to replace O.E. hardware for lower shock absorber mounting when studs break or self-tapping screws are not longer useable.;
8 Pair Packs.;
40 Complete Assembled Unit.;
53 Hardware from O.E. Part may need to be reused.;

7 Pair Packs, Air hose kit included.;
30 For GM Vehicles equipped with factory installed leveling systems, see Ref A.;
51 Strut Cushion for use with the Strut/Cartridge/Shocks.;
80 Mounting bracket not required, install on O.E. Shock Mounts. See Ref. C for optional Steering Stabilizer Boots.;

APPLICATION GUIDE

Year	Fitment Notes										
		Ultra	Ready Mounts	Max Control LTV ProGuard Guardian	Strut Cushion\ Strut Mount\ Dampers\ Stabilizer	HiJackers\ Load Carrier\ Classic	Ultra	Ready Mounts	Max Control LTV ProGuard Guardian	Strut Cushion\ Strut Mount\ Dampers\ Stabilizer	HiJackers\ Load Carrier\ Classic

CHEVROLET

CHEVROLET

BLAZER 2WD (cont)

Year	Fitment Notes	Ultra	Ready Mounts	Max Control LTV ProGuard Guardian	Strut Cushion\ Strut Mount\ Dampers\ Stabilizer	HiJackers\ Load Carrier\ Classic	Ultra	Ready Mounts	Max Control LTV ProGuard Guardian	Strut Cushion\ Strut Mount\ Dampers\ Stabilizer	HiJackers\ Load Carrier\ Classic
79-84	RWD; Dual System Steering Stabilizer						6802SE ⁸⁴				
77-84	All				14017		G63349		81164		43111 ⁸
69-84	RWD	G63355		61525 81039		34036 ⁸					
75-76	All				14017		G63349		81164		43111 ⁸ 49155 ⁷
73-74	All						G63349		61524 81164		49155 ⁷
	Exc. Lift Kit										43111 ⁸
69-72	Coil(RearSpringType)										49107 ⁷ 82003
	Leaf(RearSpringType)										49162 ⁷
	RWD						G63306				
	Single System Steering Stabilizer	6803SE ⁸⁴	6803SE ⁸⁴	6803SE ⁸⁴	6803SE ⁸⁴	6803SE ⁸⁴	6803SE ⁸⁴	6803SE ⁸⁴	6803SE ⁸⁴	6803SE ⁸⁴	6803SE ⁸⁴

BLAZER 4WD

Year	Fitment Notes	Ultra	Ready Mounts	Max Control LTV ProGuard Guardian	Strut Cushion\ Strut Mount\ Dampers\ Stabilizer	HiJackers\ Load Carrier\ Classic	Ultra	Ready Mounts	Max Control LTV ProGuard Guardian	Strut Cushion\ Strut Mount\ Dampers\ Stabilizer	HiJackers\ Load Carrier\ Classic
95-05	4WD; S Models; Exc. ZR2	G63423		58423 61531 77423 81516			G63422		61528 77422 81482		43162 ⁸ 49213 ⁷
92-94	4WD, Full Size	G63609		58609 61542 77609 81726			G63638 ⁵⁰		61565 77638		43180 ⁸ 49231 ⁷
87-91	Full Size; Exc. Quad Suspension										49155 ⁷
	4WD				14017						
	4WD, Full Size								61524		
	4WD, Full Size; Quad Suspension Long Shock			81496 ⁵							
	4WD, Full Size; Quad Suspension Long Shock; Exc. Lift Kit			61522 ⁵							
	4WD; Full Size; Exc. Quad Suspension						G63349		81164		
	4WD; Full Size; Exc. Quad Suspension and Lift										43111 ⁸
76-91	4WD, Exc. Quad Suspension	G63347		61516 ⁵ 81113 ⁵							
85-86	All				14017						
	4WD						G63349		61524 81164		43111 ⁸ 49155 ⁷
81-86	4WD, Quad Suspension Long Shock			81496 ⁵							
	4WD, Quad Suspension Long Shock; Exc. Lift Kit			61522 ⁵							
79-86	4WD; Dual System Steering Stabilizer						6802SE ⁸⁴				
75-86	Steering Stabilizer						6804SE ⁸⁰				
77-84	All				14017		G63349		81164		43111 ⁸
	4WD								61524		49155 ⁷
75-76	All				14017		G63349		81164		43111 ⁸ 49155 ⁷
76	4WD								61524		
75	4WD	G63347							61524		

6 It is recommended that when replacing shocks on vehicles with "quad shocks" all 4 shocks should be matched by series.;

8 Pair Packs.;



80 Mounting bracket not required, install on O.E. Shock Mounts. See Ref. C for optional Steering Stabilizer Boots.;

7 Pair Packs, Air hose kit included.;

50 Bellows Kit No.141242 is recommended for use to protect piston rod from potentially harmful road debris.;

84 Replacement damper for vehicles with the Gabriel Aftermarket mounting kit;

APPLICATION GUIDE

Year	Fitment Notes										
		Ultra	Ready Mounts	Max Control\ LTV\ ProGuard\ Guardian	Strut Cushion\ Strut Mount\ Dampers\ Stabilizer	HiJackers\ Load Carrier\ Classic	Ultra	Ready Mounts	Max Control\ LTV\ ProGuard\ Guardian	Strut Cushion\ Strut Mount\ Dampers\ Stabilizer	HiJackers\ Load Carrier\ Classic

CHEVROLET

CHEVROLET

BLAZER 4WD (cont)

75	4WD, Exc. Quad Suspension	OO	61516 ⁶ 81113 ⁶		
73-74	All	OO	G63349	61524 81164	49155 ⁷
	Exc. Lift Kit	OO	43111 ⁵
69-74	4WD, Exc. Quad Suspension	OO	G63347	61516 ⁶ 81113 ⁶
	RWD	OO	G63355	61525 81039	34036 ⁸
69-72	Coil(RearSpringType)	OO	49107 ⁷ 82003
	Leaf(RearSpringType)	OO	49162 ⁷
	Single System Steering Stabilizer	OO	6803SE ⁸⁴									

BLAZER, S MODELS

83-94	All	OO	G63422	61528 77422 81482	43162 ⁹ 49213 ⁷
	4WD	OO	G63423	58423 61531 77423 81516
	RWD	OO	G63421	58421 61504 81750	34051 ⁸
	Single System Steering Stabilizer; with a factory mounting hole in the steering linkage.	OO	6801SE ⁸⁰									

BROOKWOOD

71-72	All	OO	69675 ⁵	81446	34073 ⁸	OO	69604	81492
69-70	All	OO	69675 ⁵	81446	34073 ⁸	OO	69724	81514	43049 ⁹ 49131 ⁹⁰

C10 PANEL

63-67	Leaf (Rear Spring Type)	OO	G63306	49162 ⁷
67	All	OO	G63355	61525 81039	G64101
63-66	All	OO	G63355	61525 81039	34036 ⁸	OO	G64101
60-62	All	OO	82035

C20 PANEL

67	All	OO	34036 ⁸
----	-----	----	------	------	------	------	--------------------	------	------	------	------	------	------

C30 PANEL

63-66	All	OO	34036 ⁸
-------	-----	----	------	------	------	------	--------------------	------	------	------	------	------	------

C3500HD

91-02	I Beam Front Axle	OO	OO	43180 ⁹
	Exc. I Beam Front Axle	OO	OO	61543	43163 ⁹

CAMARO

14-15	SS, Left	OO	G52395	OO	G51916
	SS, Right	OO	G52396	OO	G51916

5 Use kit No. 140719 to replace O.E. hardware for lower shock absorber mounting when studs break or self-tapping screws are not longer useable.;

7 Pair Packs, Air hose kit included.;

30 For GM Vehicles equipped with factory installed leveling systems, see Ref A.;



84 Replacement damper for vehicles with the Gabriel Aftermarket mounting kit;

6 It is recommended that when replacing shocks on vehicles with "quad shocks" all 4 shocks should be matched by series.;

8 Pair Packs.;

80 Mounting bracket not required, install on O.E. Shock Mounts. See Ref. C for optional Steering Stabilizer Boots.;

APPLICATION GUIDE

Year	Fitment Notes										
		Ultra	Ready Mounts	Max Control LTV ProGuard Guardian	Strut Cushion\ Strut Mount\ Dampers\ Stabilizer	HiJackers\ Load Carrier\ Classic	Ultra	Ready Mounts	Max Control LTV ProGuard Guardian	Strut Cushion\ Strut Mount\ Dampers\ Stabilizer	HiJackers\ Load Carrier\ Classic

CHEVROLET

CAMARO (cont)

CHEVROLET

10-13	3.6L V6 Left	↓	G52280		
	3.6L V6 Right	↓	G52281		
13	All	↓	↓	G51916	
	SS, Left	↓	G52395	↓	
	SS, Right	↓	G52396	↓	
10-12	Left	↓	143460 ⁶⁷	↓	G51916	143461 ⁵³	
	Right	↓	143460 ⁶⁷	↓	G51916	143462 ⁵³	
	SS, Left	↓	G52395	↓	G51975	
	SS, Right	↓	G52396	↓	G51975	
93-02	Left	↓	G57107 ⁴⁰	↓	69676	75676 81481	49203 ⁷
	Right	↓	G57108 ⁴⁰	↓	69676	75676 81481	49203 ⁷
82-92	All	↓	G56700	↓	69676	75676 81481	49203 ⁷
70-81	All	↓	69675 ⁵	81446	34073 ⁸	↓	69624	81095	49135 ³⁰
68-69	Multi-Leaf Springs	↓	↓	69606	81495	43140 ⁸
	Single Leaf Rear Springs	↓	↓	49122 ⁷ 82040
67-69	All	↓	69600	81494	34051 ⁸	↓
	Multi-Leaf Springs	↓	↓	49205 ⁷
67	Multi-Leaf Springs	↓	↓	43140 ⁸
	Single Leaf Rear Springs	↓	↓	82040
	Single Leaf Spring	↓	↓	49122 ⁷

CAPRICE

81-96	Sedan Police and Taxi Models	↓	G63375 ⁵	61555 77375 81713 ⁵	↓	69724	81514	43049 ⁸ 49131 ³⁰
77-96	Wagon	↓	81446	↓	69604	81492	43060 ⁸ 49152 ³⁰
71-96	All	↓	69675 ⁵	34073 ⁸	↓
75-80	Exc. Wagon	↓	↓	43049 ⁸ 49131 ³⁰
	Sedan Police and Taxi Models	↓	G63375 ⁵	61555 77375 81713 ⁵	↓	69724	81514
73-76	Wagon	↓	81446	↓	69604	81492	49152 ³⁰
73-74	Sedan Police and Taxi Models	↓	G63375 ⁵	61555 77375 81713 ⁵	↓	69724	81514	43049 ⁸ 49131 ³⁰
71-72	Police and Taxi Models	↓	G63375 ⁵	61555	↓	43049 ⁸
	Sedan; Police and Taxi Models	↓	77375	↓

5 Use kit No. 140719 to replace O.E. hardware for lower shock absorber mounting when studs break or self-tapping screws are not longer useable.;

8 Pair Packs.;

40 Complete Assembled Unit.;



67 Mount Kit. Hardware from O.E. Part may need to be reused.;;

7 Pair Packs, Air hose kit included.;

30 For GM Vehicles equipped with factory installed leveling systems, see Ref A.;

53 Hardware from O.E. Part may need to be reused.;







APPLICATION GUIDE

Year	Fitment Notes										
		Ultra	Ready Mounts	Max Control\ LTV\ ProGuard\ Guardian	Strut Cushion\ Strut Mount\ Dampers\ Stabilizer	HiJackers\ Load Carrier\ Classic	Ultra	Ready Mounts	Max Control\ LTV\ ProGuard\ Guardian	Strut Cushion\ Strut Mount\ Dampers\ Stabilizer	HiJackers\ Load Carrier\ Classic



CHEVROLET

CHEVROLET



CAPRICE (cont)

71-72	Hardtop Exc. Police and Taxi Models		81446	
	Hardtop Police and Taxi Models		81713 ⁵	69724	81514	49131 ³⁰
	Wagon		69604	81492	49152 ³⁰
70	All		69675 ⁵	34073 ⁸	69724	81514	43049 ⁹ 49131 ³⁰
	Hardtop		81446
66-69	All		69675 ⁵	81446	34073 ⁸	69724	81514	43049 ⁹ 49131 ³⁰





CAPTIVA SPORT

12-15	Left		G57549 ⁴⁰
	Right		G57550 ⁴⁰

CAVALIER

99-05	All		G55698	G56951 ⁴⁰	143057 ⁵¹	G55825	G56938 ⁴⁰
95-98	All		G55698	143057 ⁵¹	G55825	G56938 ⁴⁰
87-94	All		143059 ⁵¹



CHEVELLE

68-73	All		69600	81494	34051 ⁸	69604	81492	43060 ⁹ 49152 ³⁰
64-67	All		82138
	Exc. Heavy Duty Suspension		69724	81514	43049 ⁹ 49131 ³⁰
	Heavy Duty Suspension		69604	81492	43060 ⁹ 49152 ³⁰

CHEVETTE

76-87	All		81340	43140 ⁹
-------	-----	---	-------	-------	-------	-------	-------	-------	-------	-------	-------	-------	--------------------

CHEVY II

68	All		69600	81494	69724	81514	43049 ⁹
	Multi-Leaf Rear Spring		49157 ⁷
62-67	All		82070	81242	43099 ⁹ 49173 ⁷



CITY EXPRESS

15-18	All		G64146
-------	-----	---	-------	-------	-------	-------	-------	-------	--------	-------	-------	-------	-------

CLASSIC

04-05	All		G56927 ⁴⁰	M55974	G56928 ⁴⁰	M56501	143057 ⁵¹
-------	-----	---	-------	----------------------	--------	-------	-------	-------	-------	----------------------	--------	----------------------	-------

COBALT

05-10	Exc. SS & Sport Models Left		G56810	G57047 ⁴⁰	143323 ⁵³	69587
	Exc. SS & Sport Models Right		G56810	G57048 ⁴⁰	143323 ⁵³	69587

5 Use kit No. 140719 to replace O.E. hardware for lower shock absorber mounting when studs break or self-tapping screws are not longer useable.;

8 Pair Packs.;

40 Complete Assembled Unit.;

53 Hardware from O.E. Part may need to be reused.;

7 Pair Packs, Air hose kit included.;

30 For GM Vehicles equipped with factory installed leveling systems, see Ref A.;

51 Strut Cushion for use with the Strut/Cartridge/Shocks.;

APPLICATION GUIDE

Year	Fitment Notes										
		Ultra	Ready Mounts	Max Control LTV ProGuard Guardian	Strut Cushion\ Strut Mount\ Dampers\ Stabilizer	HiJackers\ Load Carrier\ Classic	Ultra	Ready Mounts	Max Control LTV ProGuard Guardian	Strut Cushion\ Strut Mount\ Dampers\ Stabilizer	HiJackers\ Load Carrier\ Classic

CHEVROLET

COLORADO

15-23	All		49235 ⁷	
15-22	Exc. ZR2		G57748 ⁴⁰	G63866	77953
04-12	RWD		G57282 ⁴⁰
	RWD, Coil(FrontSpringType) D Standard Suspension; Exc. Z71 Off Road Package		G51850	G63882
	Torsion Bar(FrontSpringType)		G63884	G63879	77422	43162 ⁸ 49213 ⁷

CHEVROLET

CORSICA

92-96	All		143059 ⁵¹
-------	-----	--	------	------	------	----------------------	------	------	------	------	------

CORVAIR

65-69	All		82109
60-64	All		69625	34073 ⁸ 82099

CORVAIR TRUCK

61-64	All		69625	34073 ⁸ 82099
-------	-----	--	-------	------	------	------	-----------------------------	------	------	------	------

CORVETTE

97-13	Exc. Electronic Adjustable Suspension		G51904	G51871
89-96	Exc. Electronic Adjustable Suspension		69811 ⁹	69795 ⁹
88	Exc. Electronic Adjustable Suspension		69795 ⁹
84-87	All		69714	69715
63-82	All		69625	69622	81880	49304 ⁷
60-62	All		82026	43140 ⁸ 82155
53-59	All		82026	82039

CRUZE

10-15	Left		G57377 ⁴⁰	143473 ⁵³	G51971	143474 ⁵³
	Right		G57378 ⁴⁰	143473 ⁵³	G51971	143474 ⁵³

CRUZE LIMITED

16	All		143473 ⁵³	G51971	143474 ⁵³
	Left Exc. 3 Stud Mounts		G57377 ⁴⁰
	Right Exc. 3 Stud Mounts		G57378 ⁴⁰

DEL RAY

58	All		82118	49131 ³⁰ 82051
----	-----	--	------	------	------	------	-------	------	------	------	------	------------------------------

EL CAMINO

78-87	All		61504 81750	34051 ⁸	81492	43060 ⁸ 49334 ³⁰
68-77	All		61504 81750	34051 ⁸	81492	43060 ⁸ 49152 ³⁰

7 Pair Packs, Air hose kit included.;

9 See Ref. D for procedures to replace Elec Adj Susp with non-adj product.;

40 Complete Assembled Unit.;



53 Hardware from O.E. Part may need to be reused.;

8 Pair Packs.;

30 For GM Vehicles equipped with factory installed leveling systems, see Ref A.;

51 Strut Cushion for use with the Strut/Cartridge/Shocks.;

APPLICATION GUIDE

Year	Fitment Notes										
		Ultra	Ready Mounts	Max Control\ LTV\ ProGuard\ Guardian	Strut Cushion\ Strut Mount\ Dampers\ Stabilizer	HiJackers\ Load Carrier\ Classic	Ultra	Ready Mounts	Max Control\ LTV\ ProGuard\ Guardian	Strut Cushion\ Strut Mount\ Dampers\ Stabilizer	HiJackers\ Load Carrier\ Classic

CHEVROLET

CHEVROLET

EL CAMINO (cont)

64-67	All	⌋	82138	⌋	81514	43049 ⁹
	Exc. Heavy Duty Suspension	⌋	⌋	69724	49131 ⁷
59-60	All	⌋	82118	⌋	49131 ⁷ 82051

EQUINOX

14-17	All	⌋	⌋	G64140
07-17	Left Exc. Models w/ 19" Wheels	⌋	G57197 ⁴⁰	⌋
	Left Exc. Sport Suspension	⌋	G52127	⌋
	Right Exc. Models w/ 19" Wheels	⌋	G57198 ⁴⁰	⌋
	Right Exc. Sport Suspension	⌋	G52128	⌋
07-13	All	⌋	⌋	G64015	61718
07-12	Left Models w/ 19" Wheels	⌋	G57322 ⁴⁰	⌋
	Right Models w/ 19" Wheels	⌋	G57323 ⁴⁰	⌋
05-06	Left	⌋	G56773	G57110 ⁴⁰	143363 ⁵³	⌋	G64015	61718
	Right	⌋	G56774	G57111 ⁴⁰	143363 ⁵³	⌋	G64015	61718

FLEETLINE

49-52	All	⌋	G63610	82026	⌋	61592 81340	43140 ⁹ 49205 ⁷ 82066
-------	-----	---	--------	-------	-------	-------	-------	---	-------	-------	----------------	-------	---

FLEETLINE TRUCK

49-52	All	⌋	G63610	82026	⌋	61592 81340	43140 ⁹ 49205 ⁷ 82066
-------	-----	---	--------	-------	-------	-------	-------	---	-------	-------	----------------	-------	---

HHR

06-11	Exc. SS Models Left	⌋	G56810	G57047 ⁴⁰	143323 ⁵³	⌋	69587
	Exc. SS Models Right	⌋	G56810	G57048 ⁴⁰	143323 ⁵³	⌋	69587

IMPALA

17-20	Left	⌋	G57716 ⁴⁰	⌋	70204
	Right	⌋	G57717 ⁴⁰	⌋	70204
14-16	Left	⌋	G57716 ⁴⁰	142526 ⁵⁴	⌋	70204	143061 ⁵¹
	Right	⌋	G57717 ⁴⁰	142526 ⁵⁴	⌋	70204	143061 ⁵¹
00-13	All	⌋	G55948	G57060 ⁴⁰	142526 ⁵⁴	⌋	143061 ⁵¹
	Exc. Models w/ 17" Wheels	⌋	⌋	G55949
	Left Models w/ 16" Wheels	⌋	⌋	G56924 ⁴⁰
	Right Models w/ 16" Wheels	⌋	⌋	G56925 ⁴⁰

7 Pair Packs, Air hose kit included.;

40 Complete Assembled Unit.;



53 Hardware from O.E. Part may need to be reused.;

8 Pair Packs.;

51 Strut Cushion for use with the Strut/Cartridge/Shocks.;

54 Kit with Mount and Bearing. Hardware from O.E. Part may need to be reused.;

APPLICATION GUIDE

Year	Fitment Notes										
		Ultra	Ready Mounts	Max Control LTV ProGuard Guardian	Strut Cushion\ Strut Mount\ Dampers\ Stabilizer	HiJackers\ Load Carrier\ Classic	Ultra	Ready Mounts	Max Control LTV ProGuard Guardian	Strut Cushion\ Strut Mount\ Dampers\ Stabilizer	HiJackers\ Load Carrier\ Classic

CHEVROLET

CHEVROLET

IMPALA (cont)

04-11	Models w/ 17" or 18" Wheels	G52244
00-11	Left	143073 ⁵³	...
	Right	143074 ⁵³	...
94-96	All	⊥ ⊕ 69675 ⁵	34073 ⁸	43049 ⁸ 49131 ³⁰
	Sedan	⊥ ⊕ 69724	...	81514
	Wagon; Exc. Police and Taxi Models	⊥ ⊕	...	81446
83-85	All	⊥ ⊕ 69675 ⁵	34073 ⁸	⊥ ⊕	43049 ⁸ 49131 ³⁰
	Sedan	⊥ ⊕ 69724	...	81514
71-85	Sedan; Police and Taxi Models	⊥ ⊕ G63375 ⁵	...	61555 77375 81713 ⁵
65-85	Wagon; Exc. Police and Taxi Models	⊥ ⊕	...	81446
73-82	Exc. Wagon	⊥ ⊕	43049 ⁸
	Sedan	⊥ ⊕ 69724	...	81514	...	49131 ³⁰
71-82	Wagon	⊥ ⊕ 69604	...	81492	...	43060 ⁸ 49152 ³⁰
65-82	All	⊥ ⊕ 69675 ⁵	34073 ⁸
65-72	Sedan	⊥ ⊕ 69724	...	81514	...	43049 ⁸ 49131 ³⁰
61-64	All	⊥ ⊕	82118	⊥ ⊕	82051
	Sedan	⊥ ⊕	49131 ³⁰
58-60	All	⊥ ⊕	82118	⊥ ⊕	49131 ³⁰ 82051

IMPALA LIMITED

14-16	All	⊥ ⊕ G55948
	Classic Body Style	⊥ ⊕	...	G57060 ¹⁰
	Exc. Models w/ 17" Wheels	⊥ ⊕	G55949	...

K20 PANEL

67	All	⊥ ⊕	⊥ ⊕ G63306
----	-----	--------	-----	-----	-----	-----	---------------	-----	-----	-----	-----

KINGSWOOD

71-72	All	⊥ ⊕ 69675 ⁵	...	81446	...	34073 ⁸	⊥ ⊕ 69604	...	81492
69-70	All	⊥ ⊕ 69675 ⁵	...	81446	...	34073 ⁸	⊥ ⊕ 69724	...	81514	...	43049 ⁸ 49131 ³⁰

LUMINA

95-01	All	⊥ ⊕	143061 ⁵¹	...
	Left	⊥ ⊕	143071 ⁵³ 143073 ⁵³	...
	Right	⊥ ⊕	143072 ⁵³ 143074 ⁵³	...

5 Use kit No. 140719 to replace O.E. hardware for lower shock absorber mounting when studs break or self-tapping screws are not longer useable.;

30 For GM Vehicles equipped with factory installed leveling systems, see Ref A.;



51 Strut Cushion for use with the Strut/Cartridge/Shocks.;

8 Pair Packs.;

40 Complete Assembled Unit.;

53 Hardware from O.E. Part may need to be reused.;

APPLICATION GUIDE

Year	Fitment Notes										
		Ultra	Ready Mounts	Max Control\ LTV\ ProGuard\ Guardian	Strut Cushion\ Strut Mount\ Dampers\ Stabilizer	HiJackers\ Load Carrier\ Classic	Ultra	Ready Mounts	Max Control\ LTV\ ProGuard\ Guardian	Strut Cushion\ Strut Mount\ Dampers\ Stabilizer	HiJackers\ Load Carrier\ Classic

CHEVROLET

CHEVROLET

LUMINA (cont)

90-94	All	M56708
-------	-----	-------	-------	-------	-------	-------	-------	--------	-------	-------

LUV PICKUP

81-82	All	G63492	61506 81318	49311 ⁷	
	4WD	↓ O	G63909	61508 77909 81507	
	RWD	↓ O	G63902	61501 81478	
79-82	4WD; Single System Steering Stabilizer; with a factory mounting hole in the steering linkage.	↓ O	6801SE ⁸⁰										
72-80	All	↓ O	G63909	61508 77909 81507	↓ O	G63907	61500 77907 81147	43048 ⁹

MALIBU

08-12	All	143425 ⁵⁸	
04-12	Exc. Classic Models Left	↓	143354 ⁵³	↓ O	69590	
	Exc. Classic Models Right	↓	143355 ⁵³	↓ O	69590	
	Exc. Hybrid Models Left	↓	G57069 ⁴⁰	
	Exc. Hybrid Models Right	↓	G57070 ⁴⁰	
08-10	4Cyl: Exc. Classic and Hybrid Models Left	↓	G57121 ⁴⁰	
	4Cyl: Exc. Classic and Hybrid Models Right	↓	G57122 ⁴⁰	
04-08	Exc. Maxx Models	↓ O	69589	
04	All	↓	143425 ⁵⁸	
98-03	Rear Strut Lower Mounting holes at 2.4" Apart	↓	G56928 ⁴⁰	M56501	
97-03	All	↓	G56927 ⁴⁰	M55974	↓	143057 ⁵¹	
78-83	All	↓ E	69600	81494	34051 ⁸	↓ O	69604	81492	43060 ⁹ 49334 ³⁰
73-77	All	↓ E	69600	81494	34051 ⁸	↓ O	69604	81492	43060 ⁹ 49152 ³⁰
64-67	All	↓ E	82138	
	Exc. Heavy Duty Suspension	↓ O	69724	81514	43049 ⁹ 49131 ³⁰
	Heavy Duty Suspension	↓ O	69604	81492	43060 ⁹ 49152 ³⁰

METRO

98-01	Non-ABS	↓	143059 ⁵¹	↓	G55772	143057 ⁵¹
-------	---------	---	-------	-------	-------	----------------------	-------	---	--------	-------	-------	----------------------	-------

MONTE CARLO

05-07	Models w/ 17" or 18" Wheels	↓	↓	G52244
-------	-----------------------------	---	-------	-------	-------	-------	-------	---	--------	-------	-------	-------	-------

7 Pair Packs, Air hose kit included.;

30 For GM Vehicles equipped with factory installed leveling systems, see Ref A.;

51 Strut Cushion for use with the Strut/Cartridge/Shocks.;

68 Mount Kit. Hardware from O.E. Part may need to be reused.;



8 Pair Packs.;

40 Complete Assembled Unit.;

53 Hardware from O.E. Part may need to be reused.;

80 Mounting bracket not required, install on O.E. Shock Mounts. See Ref. C for optional Steering Stabilizer Boots.;

APPLICATION GUIDE

Year	Fitment Notes										
		Ultra	Ready Mounts	Max Control LTV ProGuard Guardian	Strut Cushion\ Strut Mount\ Dampers\ Stabilizer	HiJackers\ Load Carrier\ Classic	Ultra	Ready Mounts	Max Control LTV ProGuard Guardian	Strut Cushion\ Strut Mount\ Dampers\ Stabilizer	HiJackers\ Load Carrier\ Classic

CHEVROLET

CHEVROLET

MONTE CARLO (cont)

00-07	All	↑	G55948	G57060 ⁴⁰	142526 ⁵⁴	↑	143059 ⁵¹
	Exc. Models w/ 17" Wheels	↑	↑	G55949
	Left Models w/ 16" Wheels	↑	↑	G56924 ⁴⁰
	Right Models w/ 16" Wheels	↑	↑	G56925 ⁴⁰
97-07	Left	↑	↑	143073 ⁵³
	Right	↑	↑	143074 ⁵³
95-99	All	↑	↑	143059 ⁵¹
95-96	Left	↑	↑	143071 ⁵³	143073 ⁵³
	Right	↑	↑	143072 ⁵³	143074 ⁵³
73-88	All	⊕	69600	81494	34051 ⁸	⊕	69604	81492	43060 ⁸ 49334 ³⁰
70-72	All	⊕	69600	81494	34051 ⁸	⊕	69604	81492	43060 ⁸ 49152 ³⁰

NOVA

85-88	All	↑	143059 ⁵¹	↑	142249 ⁵³	143058 ⁵¹
73-79	All	⊕	69600	81494	34051 ⁸	⊕
73	Heavy Duty Suspension	⊕	⊕	69724	81514	49157 ⁷
69-72	All	⊕	69600	81494	34051 ⁸	⊕	69724	81514
	Multi-Leaf Rear Spring	⊕	⊕	43049 ⁸ 49157 ⁷

ONE-FIFTY SERIES

55-57	All	⊕	69625	34073 ⁸ 82099	⊕	82066
53-54	All	⊕	82026	⊕	43140 ⁸ 82155

OPTRA

06-08	All	↑	143349 ⁶⁷	↑
-------	-----	---	------	------	------	----------------------	------	---	------	------	------	------	------

PICKUP

60	All	⊕	82035	⊕	82086
	Dana 60 Axle up to 3 1/2" O.D. or Napco axle up to 3 3/8" O.D.	⊕	6803SE ⁸⁴										
57-58	All	⊕	82047	⊕
	3100, 3200 & 3600 Models	⊕	⊕	82060
	3800	⊕	⊕	43140 ⁸ 49203 ⁷ 82155
	Dana 60 Axle up to 3 1/2" O.D. or Napco axle up to 3 3/8" O.D.	⊕	6803SE ⁸⁴										
50-58	Single System Steering Stabilizer; w/ I-Beam Axle	⊕	6802SE ⁸⁴										
55-56	All	⊕	G63405	⊕

7 Pair Packs, Air hose kit included.;

30 For GM Vehicles equipped with factory installed leveling systems, see Ref A.;

51 Strut Cushion for use with the Strut/Cartridge/Shocks.;

54 Kit with Mount and Bearing. Hardware from O.E. Part may need to be reused.;

84 Replacement damper for vehicles with the Gabriel Aftermarket mounting kit;



8 Pair Packs.;

40 Complete Assembled Unit.;

53 Hardware from O.E. Part may need to be reused.;

67 Mount Kit. Hardware from O.E. Part may need to be reused.;

APPLICATION GUIDE

Year	Fitment Notes										
		Ultra	Ready Mounts	Max Control\ LTV\ ProGuard\ Guardian	Strut Cushion\ Strut Mount\ Dampers\ Stabilizer	HiJackers\ Load Carrier\ Classic	Ultra	Ready Mounts	Max Control\ LTV\ ProGuard\ Guardian	Strut Cushion\ Strut Mount\ Dampers\ Stabilizer	HiJackers\ Load Carrier\ Classic

CHEVROLET

CHEVROLET

PICKUP (cont)

55-56	3200 & 3600 2nd Series	OO	81147
	3800	OO	61500 81147	43140 ⁸ 49203 ⁷ 82155
54-55	3100, 3200, 3600 & 3800	IT	81270
55	3100	OO	49311 ⁷
	3100, 3124 2nd Series	OO	61500 81147	81318	49311 ⁷
54	All	OO	43140 ⁸ 49203 ⁷ 82155
50-53	3100, 3200, 3600 & 3800	IT	81270	82066

PICKUP 1/2 TON, C10

75-86	All	OO	G63355	61525 81039	34036 ⁸	OO	G63349	61524 81164	43111 ⁸ 49155 ⁷
73-86	Single System Steering Stabilizer	OO	6802SE ⁸⁴										
73-74	All	OO	G63355	61525 81039	34036 ⁸	OO	61524 81164	43111 ⁸ 49155 ⁷
67-72	Coil(RearSpringType)	OO	OO	49107 ⁷ 82003
63-72	All	OO	G63355	61525 81039	34036 ⁸	OO
	Leaf(RearSpringType)	OO	OO	G63306	49162 ⁷
60-62	All	OO	82035	OO	82086

PICKUP 1/2 TON, C15 / C1500

88-02	All	OO	G63489	58489 61544 77489 81668	34073 ⁸	OO	G63488	61543 77488 81667	43163 ⁸ 49218 ⁷
92-99	Exc. OE Unit	OO	6853SE ⁸⁶										

PICKUP 1/2 TON, K10

81-86	Exc. Lift Kit	OO	G63347	OO	G63349	81164
	Quad Suspension Long Shock; Exc. Lift Kit	OO	61522 ⁶ 81496 ⁶	OO
	Quad Suspension Short Shock; Exc. Lift Kit	OO	61516 ⁶	OO
	Standard Suspension; Exc. Lift Kit	OO	81113 ⁶	OO
75-86	All	OO	14017	OO	61524	43111 ⁸ 49155 ⁷
73-86	Steering Stabilizer	OO	6804SE ⁸⁰										
67-86	Dual System Steering Stabilizer	OO	6802SE ⁸⁴										
75-80	Exc. Lift Kit	OO	G63347	61516 ⁶ 81113 ⁶	OO	G63349	81164
74	All	OO	14017	OO	43111 ⁸
	Exc. Lift Kit	OO	G63347	61516 ⁶ 81113 ⁶	OO	G63349	61524 81164	49155 ⁷
73	All	OO	14017	OO	61524	43111 ⁸
	Exc. Lift Kit	OO	G63347	61516 ⁶ 81113 ⁶	OO	G63349	81164	49155 ⁷
69-72	All	OO	G63347	OO	G63306
	Exc. Lift Kit	OO	61516 ⁶ 81113 ⁶	OO

6 It is recommended that when replacing shocks on vehicles with "quad shocks" all 4 shocks should be matched by series.;

8 Pair Packs.;



84 Replacement damper for vehicles with the Gabriel Aftermarket mounting kit;

7 Pair Packs, Air hose kit included.;

80 Mounting bracket not required, install on O.E. Shock Mounts. See Ref. C for optional Steering Stabilizer Boots.;

86 Exc. OE Unit;



APPLICATION GUIDE

Year	Fitment Notes										
		Ultra	Ready Mounts	Max Control LTV ProGuard Guardian	Strut Cushion\ Strut Mount\ Dampers\ Stabilizer	HiJackers\ Load Carrier\ Classic	Ultra	Ready Mounts	Max Control LTV ProGuard Guardian	Strut Cushion\ Strut Mount\ Dampers\ Stabilizer	HiJackers\ Load Carrier\ Classic



CHEVROLET

CHEVROLET





PICKUP 1/2 TON, K10 (cont)

61-72	Steering Stabilizer		6803SE ⁸⁴										
67-68	All		G63306









































PICKUP 1/2 TON, K15 / K1500

88-99	All		G63818	58901 77609		G63488	61543 77488 81667	43163 ⁸ 49218 ⁷
92-97	Exc. OE Unit		6853SE ⁸⁶										

PICKUP 1/2 TON, R10

87	All		G63355	61525 81039	34036 ⁸		G63349	61524 81164	43111 ⁸
	RWD			49155 ⁷
	Single System Steering Stabilizer		6802SE ⁸⁴										

PICKUP 1/2 TON, SILVERADO 1500

23-24	Exc. Electronic Adaptable Suspension			61690
	Exc. Z45 Adaptable Ride Control (22 Inch Wheels)			G63959
22-24	Exc. Z45 Adaptable Ride Control (22 Inch Wheels)			77412	43181 ⁸ 49235 ⁷
22	Exc. Electronic Adaptable Suspension			G63959	61690
19-21	All			61690
	Exc. Z45 Adaptable Ride Control (22 Inch Wheels)			G63959	77412	43181 ⁸ 49235 ⁷
07-18	4WD		G57000 ⁴⁰	
	RWD, Exc. Electronic Ride Control		G57023 ⁴⁰	
18	All		G51949		G63959	61690	43181 ⁸ 49235 ⁷
	Exc. Z45 Adaptable Ride Control (22 Inch Wheels)			77412
14-17	All		G51949		G63959	61690 77976	43181 ⁸ 49235 ⁷
08-13	All			G63959	61690 77976	43181 ⁸ 49235 ⁷
	Exc. Classic Models and Electronic Adjustable Suspension		G51870	143316 ⁵³	
99-07	4WD; Classic and Old Body Style; Exc. Electronic Adjustable Suspension		G63803	58803 61643 77803 81922		G63675	61642 77412 81921
07	All			77976	43181 ⁸ 49235 ⁷
	Exc. Classic Models and Electronic Adjustable Suspension		G51870	143316 ⁵³		G63959	61690
	RWD, Exc. Electronic Adjustable Suspension			61600
	RWD; Classic and Old Body Style; Exc. Electronic Adjustable Suspension			77662
	RWD; Classic Models Only; Exc. Electronic Adjustable Suspension		G63783	61641 77783 81920		G63662	81873	43181 ⁸
	RWD; Classic Models Only; Exc. Z55 Auto Ride Suspension			49235 ⁷

7 Pair Packs, Air hose kit included.;

40 Complete Assembled Unit.;





84 Replacement damper for vehicles with the Gabriel Aftermarket mounting kit;

8 Pair Packs.;

53 Hardware from O.E. Part may need to be reused.;

86 Exc. OE Unit;

APPLICATION GUIDE

Year	Fitment Notes										
		 Ultra	Ready Mounts	Max Control\ LTV\ ProGuard\ Guardian	Strut Cushion\ Strut Mount\ Dampers\ Stabilizer	HiJackers\ Load Carrier\ Classic	 Ultra	Ready Mounts	Max Control\ LTV\ ProGuard\ Guardian	Strut Cushion\ Strut Mount\ Dampers\ Stabilizer	HiJackers\ Load Carrier\ Classic





CHEVROLET

CHEVROLET











PICKUP 1/2 TON, SILVERADO 1500 (cont)

99-06	RWD; Classic Models Only; Exc. Electronic Adjustable Suspension		G63783	61641 77783 81920		G63662	61600 77662 81873	43181 ⁸ 49235 ⁷
-------	---	---	--------	------	-------------------------	------	------	---	--------	------	-------------------------	------	--





















PICKUP 1/2 TON, SILVERADO 1500 HD

05-06	All		G63817	58817 61663 77817 81925		G63675	61642 77412 81921
01-03	All		G63817	58817 61663 77817 81925		G63675	61642 77412 81921



PICKUP 1/2 TON, V10

87	All		14017		49155 ⁷
	Exc. Lift Kit		G63347		G63349	61524 81164	43111 ⁸
	Quad Suspension Long Shock; Exc. Lift Kit		61522 ⁶ 81496 ⁶	
	Quad Suspension Short Shock; Exc. Lift Kit		61516 ⁶ 81113 ⁶	
	Dual System Steering Stabilizer		6802SE ⁸⁴										
	Steering Stabilizer		6804SE ⁸⁰										









PICKUP 3/4 TON, C20

75-86	All		G63355	61525 81039	
	Crew Cab Pickup		34036 ⁸		G63366
	Standard Cab Pickup		34036 ⁸		G63349	61524 81164	43111 ⁸ 49155 ⁷
63-86	Single System Steering Stabilizer		6802SE ⁸⁴										
73-74	Crew Cab Pickup		G63355	61525 81039	34036 ⁸	
	Standard Cab Pickup			61524 81164	43111 ⁸ 49155 ⁷	
67-72	All		G63355	61525 81039	34036 ⁸		G63306
	Coil(RearSpringType)			49107 ⁷ 82003	
	Leaf(RearSpringType)			49162 ⁷	
63-66	All		G63355	61525 81039	34036 ⁸		G63306	49162 ⁷
60-62	All		82035		82086

PICKUP 3/4 TON, C25 / C2500

88-00	All		G63489	58489 61544 77489 81668	34073 ⁸		G63488	61543 77488 81667	43163 ⁸ 49218 ⁷
92-99	Exc. OE Unit		6853SE ⁸⁶										

PICKUP 3/4 TON, K20

81-86	Exc. Lift Kit		G63347		G63349	61524 81164	43111 ⁸
	Quad Suspension Long Shock; Exc. Lift Kit		61522 ⁶ 81496 ⁶	
	Quad Suspension Short Shock; Exc. Lift Kit		61516 ⁶	
	Standard Suspension; Exc. Lift Kit		81113 ⁶		49155 ⁷

6 It is recommended that when replacing shocks on vehicles with "quad shocks" all 4 shocks should be matched by series.;

8 Pair Packs.;



84 Replacement damper for vehicles with the Gabriel Aftermarket mounting kit;

7 Pair Packs, Air hose kit included.;

80 Mounting bracket not required, install on O.E. Shock Mounts. See Ref. C for optional Steering Stabilizer Boots.;

86 Exc. OE Unit;

APPLICATION GUIDE

Year	Fitment Notes										
		Ultra	Ready Mounts	Max Control\ LTV\ ProGuard\ Guardian	Strut Cushion\ Strut Mount\ Dampers\ Stabilizer	HiJackers\ Load Carrier\ Classic	Ultra	Ready Mounts	Max Control\ LTV\ ProGuard\ Guardian	Strut Cushion\ Strut Mount\ Dampers\ Stabilizer	HiJackers\ Load Carrier\ Classic

CHEVROLET

CHEVROLET

PICKUP 3/4 TON, K20 (cont)

73-86	All	○	14017		
	Steering Stabilizer	○	6804SE ⁸⁰										
67-86	Dual System Steering Stabilizer	○	6802SE ⁸⁴										
75-80	Exc. Lift Kit	○	G63347	61516 ⁶ 81113 ⁶	○	G63349	61524 81164	43111 ⁸ 49155 ⁷
73-74	Exc. Lift Kit	○	G63347	61516 ⁶ 81113 ⁶	○	61524 81164	43111 ⁸ 49155 ⁷
69-72	Exc. Lift Kit	○	G63347	61516 ⁶ 81113 ⁶	○
67-72	All	○	○	G63306
61-72	Steering Stabilizer	○	6803SE ⁸⁴										

PICKUP 3/4 TON, K25 / K2500

99-00	Exc. OE Unit	○	6853SE ⁸⁶										
88-00	All	○	G63609	58609 61542 77609 81726	○	G63488	61543 77488 81667	43163 ⁸ 49218 ⁷

PICKUP 3/4 TON, R20

87-88	All	○	G63355	61525 81039	○
	Crew Cab Pickup	○	34036 ⁸	○	G63366
	Single System Steering Stabilizer	○	6802SE ⁸⁴										
87	Standard Cab Pickup	○	○	G63349	61524 81164	43111 ⁸ 49155 ⁷

PICKUP 3/4 TON, R2500

89	All	○	G63355	61525 81039	34036 ⁸	○	G63366
	Single System Steering Stabilizer	○	6802SE ⁸⁴										

PICKUP 3/4 TON, SILVERADO 2500

11-18	All	○	○	G64121
05-08	All	○	G63817	58817 61663 77817 81925	○	G63675	61642 77412 81921
99-04	All	○	○	G63675	61642 77412 81921
	4WD	○	G63817	58817 61663 77817 81925	○
	RWD, Exc. Electronic Adjustable Suspension	○	G63783	61641 77783 81920	○

PICKUP 3/4 TON, SILVERADO 2500 HD

11-24	All	○	G64148	○	G64121	77976	43181 ⁸
05-10	9200# GVW	○	G63817	58817 61663 77817	○
01-10	All	○	○	G63675	61642 77412 81921
01-09	9200# GVW w/ OE Unit - 15059138 15155638	○	6853SE ⁸²										

6 It is recommended that when replacing shocks on vehicles with "quad shocks" all 4 shocks should be matched by series.;

8 Pair Packs.;

82 Use kit if listed, See Ref. C for optional Steering Stabilizer Boots.;

86 Exc. OE Unit;

7 Pair Packs, Air hose kit included.;

80 Mounting bracket not required, install on O.E. Shock Mounts. See Ref. C for optional Steering Stabilizer Boots.;

84 Replacement damper for vehicles with the Gabriel Aftermarket mounting kit;

APPLICATION GUIDE

Year	Fitment Notes										
		Ultra	Ready Mounts	Max Control\ LTV\ ProGuard\ Guardian	Strut Cushion\ Strut Mount\ Dampers\ Stabilizer	HiJackers\ Load Carrier\ Classic	Ultra	Ready Mounts	Max Control\ LTV\ ProGuard\ Guardian	Strut Cushion\ Strut Mount\ Dampers\ Stabilizer	HiJackers\ Load Carrier\ Classic

CHEVROLET

CHEVROLET

PICKUP 3/4 TON, SILVERADO 2500 HD (cont)

01-09	9200# GVW w/o OE Unit - 15059138 15155638		6803SE ⁸⁴							
01-04	9200# GVW	 O 	58817 77817
	4WD, 9200# GVW	 O 	G63817	61663
	RWD	 O 	G63783	61641 77783 81920

PICKUP 3/4 TON, V20

87	All	 O 	14017	49155 ⁷		
	Exc. Quad Suspension and Lift Kit	 O 	G63347	61516	G63349	61524 81164	43111 ⁸
	Quad Suspension Long Shock; Exc. Lift Kit	 O 	61522 ⁸ 81496 ⁸	
	Dual System Steering Stabilizer	 O 	6802SE ⁸⁴										
	Steering Stabilizer	 O 	6804SE ⁸⁰										

PICKUP 1 TON, C30

75-86	All	 O 	G63355	61525 81039	34036 ⁸	 O 	G63366
73-86	Single System Steering Stabilizer; with Cooler	 O 	6802SE ⁸⁴										
63-74	All	 O 	G63355	61525 81039	34036 ⁸	 O
67-72	Exc. 11,000# Rear Axle	 O 	 O 	G63306	49162 ⁷
61-72	Single System Steering Stabilizer	 O 	6802SE ⁸⁴										
61-62	All	 O 	82035	 O

PICKUP 1 TON, C35/3500

98-00	Crew Cab; Exc. HD Straight Front Axle	 O 	G63489	58489 61544	 O 	G63488
92-00	Exc. HD Straight Front Axle	 O 	81668	 O
	Exc. HD Straight Front Axle	 O 	G63489	58489 61544 77489	 O 	G63488
	Extended & Standard Cab; Exc. HD Straight Front Axle	 O 	 O 	81667
91-00	All	 O 	 O 	77488	49218 ⁷
88-00	Extended & Standard Cab; Exc. Straight Front Axle	 O 	34073 ⁸	 O
92-97	Crew Cab; Exc. HD Straight Front Axle	 O 	G63489	58489 61544 77489	 O 	G63488
88-91	Cab & Chassis; Exc. HD Solid Front Axle	 O 	G63355	61525 81039	34036 ⁸	 O 	G63366
91	Extended & Standard Cab; Exc. HD Straight Front Axle	 O 	G63489	58489 61544 77489 81668	 O 	G63488	81667
88-90	Extended & Standard Cab; Exc. HD Straight Front Axle	 O 	G63489	58489 61544 77489 81668	 O 	G63488	61543 77488 81667	43163 ⁸ 49218 ⁷

PICKUP 1 TON, K30

77-86	All	 O 	G63411	14017	 O 	G63675	61642 77412 81921
	Dual System Steering Stabilizer	 O 	6802SE ⁸⁴										

6 It is recommended that when replacing shocks on vehicles with "quad shocks" all 4 shocks should be matched by series.;



8 Pair Packs.;

84 Replacement damper for vehicles with the Gabriel Aftermarket mounting kit;

7 Pair Packs, Air hose kit included.;

80 Mounting bracket not required, install on O.E. Shock Mounts. See Ref. C for optional Steering Stabilizer Boots.;

APPLICATION GUIDE

Year	Fitment Notes										
		Ultra	Ready Mounts	Max Control LTV ProGuard Guardian	Strut Cushion\ Strut Mount\ Dampers\ Stabilizer	HiJackers\ Load Carrier\ Classic	Ultra	Ready Mounts	Max Control LTV ProGuard Guardian	Strut Cushion\ Strut Mount\ Dampers\ Stabilizer	HiJackers\ Load Carrier\ Classic

CHEVROLET

CHEVROLET

PICKUP 1 TON, K30 (cont)

77-86	Steering Stabilizer	6804SE ⁸⁰									
73-74	All	14017

PICKUP 1 TON, K35 / K3500

95-00	Exc. OE Unit	6853SE ⁸⁶									
88-00	All	G63609	58609 61542 77609 81726	G63488	61543 77488 81667	43163 ⁸ 49218 ⁷

PICKUP 1 TON, R30

87-88	All	G63355	61525 81039	34036 ⁸	G63366
	Single System Steering Stabilizer; with Cooler	6802SE ⁸⁴									

PICKUP 1 TON, R3500

90-91	All	G63411	81039	14017	G63675	61642 77412 81921
89-91	Single System Steering Stabilizer; with Cooler	6802SE ⁸⁴									
89	All	81039	14017
	Exc. Standard Cab	G63411	G63675	61642 77412 81921
	Standard Cab Pickup	G63355	61525	34036 ⁸	G63366

PICKUP 1 TON, SILVERADO 3500

15-18	All	G64121
11-13	All	G64121
01-09	All	G63817	58817 61663 77817 81925	G63675	61642 77412 81921

PICKUP 1 TON, SILVERADO 3500 HD

11-24	All	G64148	G64121	77976	43181 ⁸
08-10	All	G63817	58817 61663 77817	G63675	61642 77412 81921
07	All	G63817	58817 61663 77817	G63675	61642
	Classic	77412

PICKUP 1 TON, V30

87-88	All	G63411	14017	G63675	61642 77412 81921
-------	-----	--------	-------	-------	-------	-------	--------	-------	-------------------------	-------	-------

PICKUP 1 TON, V3000 / V3500

89-91	All	G63411	14017	G63675	61642 77412 81921
-------	-----	--------	-------	-------	-------	-------	--------	-------	-------------------------	-------	-------

PRIZM

98-02	Left	G55999	G56948 ⁴⁰	143059 ⁵¹ 143281 ⁵³	G55661	G56949 ⁴⁰	143058 ⁵¹
-------	------	--------	----------------------	-------	--	-------	--------	----------------------	-------	----------------------	-------

7 Pair Packs, Air hose kit included.;

40 Complete Assembled Unit.;

53 Hardware from O.E. Part may need to be reused.;

84 Replacement damper for vehicles with the Gabriel Aftermarket mounting kit;



8 Pair Packs.;

51 Strut Cushion for use with the Strut/Cartridge/Shocks.;

80 Mounting bracket not required, install on O.E. Shock Mounts. See Ref. C for optional Steering Stabilizer Boots.;

86 Exc. OE Unit;

APPLICATION GUIDE

Year	Fitment Notes										
		Ultra	Ready Mounts	Max Control\ LTV\ ProGuard\ Guardian	Strut Cushion\ Strut Mount\ Dampers\ Stabilizer	HiJackers\ Load Carrier\ Classic	Ultra	Ready Mounts	Max Control\ LTV\ ProGuard\ Guardian	Strut Cushion\ Strut Mount\ Dampers\ Stabilizer	HiJackers\ Load Carrier\ Classic

CHEVROLET

CHEVROLET

PRIZM (cont)

98-02	Right	G55999	G56948 ⁴⁰	143059 ⁵¹ 143281 ⁵³	G55662	G56950 ⁴⁰	143058 ⁵¹
-------	-------	--------	----------------------	------	--	------	--------	----------------------	------	----------------------	------

S10

92-04	4WD; Exc. ZR2, ZR5 or Sport Chassis	G63423	58423 61531 77423 81516	G63422	61528 77422 81482	43162 ⁸ 49213 ⁷
83-04	4WD; Single System Steering Stabilizer; with a factory mounting hole in the steering linkage.	6801SE ⁸⁰									
02-03	RWD; Exc. Sport Chassis or Xtreme Chassis	G63421	58421 61504 81750	34051 ⁸	61528 77422 81482	43162 ⁸ 49213 ⁷
82-03	RWD; Single System Steering Stabilizer	6802SE ⁸⁴									
01	RWD; Exc. Sport Chassis or Xtreme Chassis	G63421	58421 61504 81750	34051 ⁸	61528 81482	43162 ⁸ 49213 ⁷
99-00	RWD; Exc. Sport Chassis or Xtreme Chassis	G63421	58421 61504 81750	34051 ⁸	61528 77422 81482	43162 ⁸ 49213 ⁷
92-98	RWD; Exc. Sport Chassis or Xtreme Chassis	G63421	58421 61504 81750	34051 ⁸
91	4WD; Exc. ZR2, Baja & Sport Chassis	G63423	58423 61531 77423 81516
	4WD; Exc. ZR2, ZR5 or Sport Chassis	G63422	61528 77422 81482	43162 ⁸ 49213 ⁷
	RWD; Exc. ZR2, Baja & Sport Chassis	G63421	58421 61504 81750	34051 ⁸
83-90	4WD; Exc. ZR2, ZR5 or Sport Chassis	G63423	58423 61531 77423 81516	G63422	61528 77422 81482	43162 ⁸ 49213 ⁷
82-90	RWD; Exc. Sport Chassis or Xtreme Chassis	G63421	58421 61504 81750	34051 ⁸
82	4WD; Exc. ZR2, ZR5 or Sport Chassis	49213 ⁷

SILVERADO 1500 HD CLASSIC

07	All	G63817	58817 61663 77817 81925	G63675	81921
	4WD	61642 77412

SILVERADO 1500 LD

19	All	77412	49235 ⁷
	4WD	G57000 ⁴⁰
	RWD, Exc. Electronic Ride Control	G57023 ⁴⁰

SILVERADO 2500 HD CLASSIC

07	All	G63817	61663 77817	G63675	61642 77412
	9200# GVW	58817

7 Pair Packs, Air hose kit included.;

40 Complete Assembled Unit.;

53 Hardware from O.E. Part may need to be reused.;



84 Replacement damper for vehicles with the Gabriel Aftermarket mounting kit;

8 Pair Packs.;

51 Strut Cushion for use with the Strut/Cartridge/Shocks.;

80 Mounting bracket not required, install on O.E. Shock Mounts. See Ref. C for optional Steering Stabilizer Boots.;

APPLICATION GUIDE

Year	Fitment Notes										
		Ultra	Ready Mounts	Max Control LTV ProGuard Guardian	Strut Cushion\ Strut Mount\ Dampers\ Stabilizer	HiJackers\ Load Carrier\ Classic	Ultra	Ready Mounts	Max Control LTV ProGuard Guardian	Strut Cushion\ Strut Mount\ Dampers\ Stabilizer	HiJackers\ Load Carrier\ Classic

CHEVROLET

CHEVROLET

SILVERADO 3500 CLASSIC

07	All	
	Heavy Duty		58817

SPECTRUM

85-88	All		143058 ⁵¹
-------	-----	--	------	------	------	----------------------	------	------	------	------

SPRINT

89-91	All		143059 ⁵¹	G55772	143057 ⁵¹
-------	-----	--	------	------	------	----------------------	------	--------	------	------	----------------------	------

SSR

03-06	All		G51718 ⁴⁵	G63842
-------	-----	--	----------------------	------	------	------	------	--------	------	------	------	------

STYLELINE DELUXE

49-52	All		82026	43140 ⁸ 49203 ⁷ 82155
-------	-----	--	------	------	------	------	-------	------	------	------	------	---

STYLELINE SPECIAL

49-52	All		82026	43140 ⁸ 49203 ⁷ 82155
-------	-----	--	------	------	------	------	-------	------	------	------	------	---

SUBURBAN 1/2 TON, 1500

20	All		77975
	Old Body Style		G51949	G64101
	4WD, Old Body Style		G57023 ⁴⁰
15-19	Old Body Style		G51949
	4WD		G57023 ⁴⁰	49235 ⁷
14-19	All		G64101	77975	43181 ⁸
12-14	4WD		49235 ⁷
14	Exc. Z55 or ZW7 Ride Suspension		G51891	G57125 ⁴⁰
12-13	All		G64101	43181 ⁸
	Exc. Z55 or ZW7 Ride Suspension		G51891	G57125 ⁴⁰	143316 ⁵³
07-11	Exc. Z55 or ZW7 Ride Suspension		G51891	G57125 ⁴⁰	143316 ⁵³	G63866	61675 77953 81930
00-11	4WD, Exc. Z55 Auto Ride Suspension		49235 ⁷
	RWD		49155 ⁷
00-06	Exc. Z55 Auto Ride Suspension		G63803	58803 61643 77803 81922	G63866	61675 77953 81930
00-05	Exc. OE Unit		6853SE ⁸⁶									
63-66	All		G63355	61525 81039	34036 ⁸	G63306	49162 ⁷
61-62	All		82035	82086

7 Pair Packs, Air hose kit included.;

40 Complete Assembled Unit.;

51 Strut Cushion for use with the Strut/Cartridge/Shocks.;



86 Exc. OE Unit.;

8 Pair Packs.;

45 Strut must be rotated to align notch with lower control arm.;

53 Hardware from O.E. Part may need to be reused.;

APPLICATION GUIDE

Year	Fitment Notes										
		Ultra	Ready Mounts	Max Control\ LTV\ ProGuard\ Guardian	Strut Cushion\ Strut Mount\ Dampers\ Stabilizer	HiJackers\ Load Carrier\ Classic	Ultra	Ready Mounts	Max Control\ LTV\ ProGuard\ Guardian	Strut Cushion\ Strut Mount\ Dampers\ Stabilizer	HiJackers\ Load Carrier\ Classic

CHEVROLET

CHEVROLET

SUBURBAN 1/2 TON, C10

73-86	All	81039	34036 ⁸	OO G63349	61524 81164	43111 ⁵ 49155 ⁷
68-86	Single System Steering Stabilizer	6802SE ⁸⁴									
67-86	RWD	OO G63355	61525	OO
68-72	All	81039	34036 ⁸	OO	49107 ⁷ 82003
67-72	4WD	OO G63347	61516	OO
67	All	81039	34036 ⁸	OO

SUBURBAN 1/2 TON, C15 / C1500

92-99	All	OO G63489	58489 61544 77489 81668	34073 ⁸	OO G63896	61565 77638	43180 ⁵ 49231 ⁷
-------	-----	-----------	-------	----------------------------------	-------	--------------------	-----------	-------	----------------	-------	--

SUBURBAN 1/2 TON, K10

81-86	Exc. Lift Kit	OO G63347	OO G63349	81164	43111 ⁵
	Quad Suspension Long Shock; Exc. Lift Kit	61522 ⁶ 81496 ⁶	OO
	Quad Suspension Short Shock; Exc. Lift Kit	61516 ⁶	OO
	Standard Suspension; Exc. Lift Kit	81113 ⁶	OO	49155 ⁷
73-86	All	14017	OO	61524
	Steering Stabilizer	6804SE ⁸⁰									
68-86	Dual System Steering Stabilizer	6802SE ⁸⁴									
73-80	Exc. Lift Kit	OO G63347	61516 ⁶ 81113 ⁶	OO G63349	81164	43111 ⁵ 49155 ⁷
69-72	Exc. Lift Kit	OO G63347	61516 ⁶ 81113 ⁶	OO
68-72	Steering Stabilizer	6803SE ⁸⁴									

SUBURBAN 1/2 TON, K15 / K1500

92-99	All	OO G63609	58609 61542 77609 81726	OO G63638	61565 77638	43180 ⁵ 49231 ⁷
-------	-----	-----------	-------	----------------------------------	-------	-------	-----------	-------	----------------	-------	--

SUBURBAN 1/2 TON, R10

87-88	All	OO G63355	61525 81039	14017	34036 ⁸	OO G63349	61524 81164	43111 ⁵
	Dual System Steering Stabilizer	6802SE ⁸⁴									
	RWD	OO	49155 ⁷
	Steering Stabilizer	6804SE ⁸⁰									

SUBURBAN 1/2 TON, R1500

89-91	All	OO G63355	61525 81039	34036 ⁸	OO G63349	61524 81164	43111 ⁵
	RWD	OO	49155 ⁷
	Single System Steering Stabilizer	6802SE ⁸⁴									

SUBURBAN 1/2 TON, V10

87-88	Quad Suspension Long Shock; Exc. Lift Kit	61522 ⁶ 81496 ⁶	OO
	Quad Suspension Short Shock; Exc. Lift Kit	61516 ⁶ 81113 ⁶	OO

6 It is recommended that when replacing shocks on vehicles with "quad shocks" all 4 shocks should be replaced by series.;



8 Pair Packs.;

84 Replacement damper for vehicles with the Gabriel Aftermarket mounting kit;

7 Pair Packs, Air hose kit included.;

80 Mounting bracket not required, install on O.E. Shock Mounts. See Ref. C for optional Steering Stabilizer Boots.;

APPLICATION GUIDE

Year	Fitment Notes										
		Ultra	Ready Mounts	Max Control LTV ProGuard Guardian	Strut Cushion\ Strut Mount\ Dampers\ Stabilizer	HiJackers\ Load Carrier\ Classic	Ultra	Ready Mounts	Max Control LTV ProGuard Guardian	Strut Cushion\ Strut Mount\ Dampers\ Stabilizer	HiJackers\ Load Carrier\ Classic

CHEVROLET

CHEVROLET

SUBURBAN 1/2 TON, V1500

89-91	All	49155 ⁷
	Exc. Lift Kit	G63349	61524 81164	43111 ⁸
	Exc. Quad Suspension and Lift Kit	61516

SUBURBAN 3/4 TON, 2500

12-13	All	81925
	Exc. Z55 Auto Ride Suspension and Quadrasteer	G63817	58817 61663 77817	G63866	61675 77953
	4WD	49235 ⁷
00-13	RWD	49155 ⁷
00-11	Exc. Z55 Auto Ride Suspension and Quadrasteer	G63817	58817 61663 77817 81925	G63866	61675 77953 81930
	4WD, Exc. Z55 Auto Ride Suspension	49235 ⁷
00-05	Exc. OE Unit	6853SE ⁸⁶								

SUBURBAN 3/4 TON, C20

73-86	All	G63355	61525 81039	34036 ⁸	G63349	61524 81164	43111 ⁸ 49155 ⁷
68-86	Single System Steering Stabilizer	6802SE ⁸⁴								
68-72	All	G63355	61525 81039	34036 ⁸	49107 ⁷ 82003
67	All	61525	34036 ⁸

SUBURBAN 3/4 TON, C25 / C2500

92-99	All	G63489	58489 61544 77489 81668	34073 ⁸	G63896	61565 77638	43180 ⁸ 49231 ⁷
-------	-----	--------	------	----------------------------------	------	--------------------	--------	------	----------------	--

SUBURBAN 3/4 TON, K20

81-86	Exc. Lift Kit	G63347	G63349	61524 81164	43111 ⁸
	Quad Suspension Long Shock; Exc. Lift Kit	61522 ⁸ 81496 ⁸
	Quad Suspension Short Shock; Exc. Lift Kit	61516 ⁸
	Standard Suspension; Exc. Lift Kit	81113 ⁸	49155 ⁷
73-86	All	14017
	Steering Stabilizer	6804SE ⁸⁰								
68-86	Dual System Steering Stabilizer	6802SE ⁸⁴								
73-80	Exc. Lift Kit	G63347	61516 ⁸ 81113 ⁸	G63349	61524 81164	43111 ⁸ 49155 ⁷
69-72	Exc. Lift Kit	G63347	61516 ⁸ 81113 ⁸
68-72	Steering Stabilizer	6803SE ⁸⁴								

SUBURBAN 3/4 TON, K25 / K2500

95-99	Exc. OE Unit	6853SE ⁸⁶								
-------	--------------	----------------------	--	--	--	--	--	--	--	--

6 It is recommended that when replacing shocks on vehicles with "quad shocks" all 4 shocks should be matched by series.;

8 Pair Packs.;



84 Replacement damper for vehicles with the Gabriel Aftermarket mounting kit;

7 Pair Packs, Air hose kit included.;

80 Mounting bracket not required, install on O.E. Shock Mounts. See Ref. C for optional Steering Stabilizer Boots.;

86 Exc. OE Unit;

APPLICATION GUIDE

Year	Fitment Notes										
		Ultra	Ready Mounts	Max Control\ LTV\ ProGuard\ Guardian	Strut Cushion\ Strut Mount\ Dampers\ Stabilizer	HiJackers\ Load Carrier\ Classic	Ultra	Ready Mounts	Max Control\ LTV\ ProGuard\ Guardian	Strut Cushion\ Strut Mount\ Dampers\ Stabilizer	HiJackers\ Load Carrier\ Classic

CHEVROLET

CHEVROLET

SUBURBAN 3/4 TON, K25 / K2500 (cont)

92-99	All	G63609	58609 61542 77609 81726	G63638	61565 77638	43180 ⁸ 49231 ⁷
-------	-----	--------	------	----------------------------------	------	------	--------	------	----------------	------	--

SUBURBAN 3/4 TON, R20

87-88	All	G63355	61525 81039	34036 ⁸	G63349	61524 81164	43111 ⁸
	RWD	49155 ⁷
	Single System Steering Stabilizer	6802SE ⁸⁴									

SUBURBAN 3/4 TON, R2500

89-91	All	G63355	61525 81039	34036 ⁸	G63349	61524 81164	43111 ⁸
	RWD	49155 ⁷
	Single System Steering Stabilizer	6802SE ⁸⁴									

SUBURBAN 3/4 TON, V20

87-88	All	14017	49155 ⁷
	Exc. Quad Suspension and Lift Kit	G63347	G63349	61524 81164	43111 ⁸
	Quad Suspension Long Shock; Exc. Lift Kit	61522 ⁶ 81496 ⁶
	Quad Suspension Short Shock; Exc. Lift Kit	61516 81113 ⁶
	Dual System Steering Stabilizer	6802SE ⁸⁴									
	Steering Stabilizer	6804SE ⁸⁰									

SUBURBAN 3/4 TON, V2500

89-91	All	14017	49155 ⁷
	Exc. Lift Kit	G63347	G63349	61524 81164	43111 ⁸
	Quad Suspension Long Shock; Exc. Lift Kit	61522 ⁶ 81496 ⁶
	Quad Suspension Short Shock; Exc. Lift Kit	61516 81113 ⁶
	Dual System Steering Stabilizer	6802SE ⁸⁴									
	Steering Stabilizer	6804SE ⁸⁰									

SUBURBAN 3500 HD

16-19	All	61663	G64000
-------	-----	------	------	-------	------	------	--------	------	------	------	------

TAHOE

15-20	Old Body Style	G51949
15-19	4WD	G57023 ⁴⁰	49235 ⁷
12-19	All	77975	43181 ⁸
11-19	Exc. Police Package	G64101
12-14	Exc. Z55 or ZW7 Ride Suspension	G51891	G57125 ⁴⁰	143316 ⁵³
	4WD	49235 ⁷

6 It is recommended that when replacing shocks on vehicles with "quad shocks" all 4 shocks should be matched by series.;

8 Pair Packs.;

53 Hardware from O.E. Part may need to be reused.;



84 Replacement damper for vehicles with the Gabriel Aftermarket mounting kit;

7 Pair Packs, Air hose kit included.;

40 Complete Assembled Unit.;

80 Mounting bracket not required, install on O.E. Shock Mounts. See Ref. C for optional Steering Stabilizer Boots.;

























APPLICATION GUIDE

Year	Fitment Notes										
		Ultra	Ready Mounts	Max Control\ LTV\ ProGuard\ Guardian	Strut Cushion\ Strut Mount\ Dampers\ Stabilizer	HiJackers\ Load Carrier\ Classic	Ultra	Ready Mounts	Max Control\ LTV\ ProGuard\ Guardian	Strut Cushion\ Strut Mount\ Dampers\ Stabilizer	HiJackers\ Load Carrier\ Classic

CHEVROLET

CHEVROLET





TAHOE (cont)

07-11	Exc. Z55 or ZW7 Ride Suspension		G51891	G57125 ⁴⁰	143316 ⁵³		G63866	61675 77953 81930
02-11	RWD			49155 ⁷
00-11	4WD, Exc. Z55 Auto Ride Suspension			49235 ⁷
11	All			43181 ⁸
02-06	Exc. Z55 Auto Ride Suspension		G63803	58803 61643 77803 81922		G63866	61675 77953 81930
95-05	Old Body Style		6853SE ⁸²										
00-01	New Body Style; Exc. Z55 Auto Ride Suspension		G63803	58803 61643 77803		G63866	61675 77953
	New Body Style; Exc. Z55 Auto Ride Suspension		81922		81930
01	RWD, Old Body Style			49155 ⁷
95-00	Old Body Style			61565 77638	43180 ⁸
	4WD, Old Body Style		G63609	58901 61542 77609 81726		G63638	49231 ⁷
00	RWD, Old Body Style		G63489	58489 61544 77489 81668	34073 ⁸		G63896	49155 ⁷
96-99	RWD, Old Body Style		G63489	58489 61544 77489 81668	34073 ⁸		G63896
95	RWD		34073 ⁸	
	RWD, Old Body Style		G63489	58489 61544 77489 81668		G63896





TORNADO

04-08	All			G63875
-------	-----	--	------	------	------	------	------	---	--------	------	------	------	------







TOWNSMAN

71-72	All		69675 ⁵	81446	34073 ⁸		69604	81492
69-70	All		69675 ⁵	81446	34073 ⁸		69724	81514	43049 ⁸ 49131 ³⁰

TRACKER

99-04	All		143204 ⁵³	
98-04	Non-ABS			G63799	61560 81904

TRAILBLAZER

06-09	Exc. SS Models		G51718 ⁴⁵	G57022 ⁴⁰	
02-09	Air(RearSpringType)			G64014	61717
	Coil(RearSpringType)			G63842	77971
02-05	All		G51718 ⁴⁵	G57022 ⁴⁰	

5 Use kit No. 140719 to replace O.E. hardware for lower shock absorber mounting when studs break or self-tapping screws are not longer useable;

8 Pair Packs;

40 Complete Assembled Unit;

53 Hardware from O.E. Part may need to be reused;



7 Pair Packs, Air hose kit included.;

30 For GM Vehicles equipped with factory installed leveling systems, see Ref A.;

45 Strut must be rotated to align notch with lower control arm.;

82 Use kit if listed, See Ref. C for optional Steering Stabilizer Boots.;

APPLICATION GUIDE

Year	Fitment Notes										
		Ultra	Ready Mounts	Max Control\ LTV\ ProGuard\ Guardian	Strut Cushion\ Strut Mount\ Dampers\ Stabilizer	HiJackers\ Load Carrier\ Classic	Ultra	Ready Mounts	Max Control\ LTV\ ProGuard\ Guardian	Strut Cushion\ Strut Mount\ Dampers\ Stabilizer	HiJackers\ Load Carrier\ Classic

CHEVROLET

TRAILBLAZER EXT

CHEVROLET

02-06	All	G51718 ⁴⁵	77971
-------	-----	----------------------	------	------	------	------	------	------	-------	------	------

TRaverse

15-17	All	G57709 ⁴⁰	G64040
13-14	All	G57709 ⁴⁰	143486 ⁶⁷	G64040
09-12	All	G52125	143366 ⁵³	G64040
	AWD	G57109 ⁴⁰
09-11	FWD	G57314 ⁴⁰

TRAX

13-22	Left	G52494	G511030
	Right	G52495	G511030

TWO-TEN SERIES

55-57	All	69625	34073 ⁸ 82099	82066
54	All	82026	43140 ⁸ 49203 ⁷ 82155
53	All	82026	43140 ⁸ 82155

UPLANDER

05-09	Exc. Auto-Leveling System	G52025
	FWD, Exc. Air-Leveling Suspension	142526 ⁵⁴
	FWD, Exc. Auto-Leveling System	G57142 ⁴⁰	G63776
05-08	FWD, Exc. Auto-Leveling System & Independent Rear Suspension	49230 ⁷

VAN 1/2 TON, G / EXPRESS

12-14	AWD, Torsion Bar(FrontSpringType)	G63893	61683
03-14	All	G63896	77638	43180 ⁸ 49231 ⁷
	RWD, Coil(FrontSpringType)	G63894	61684
03-11	Exc. Upfitter Package and Cutaway Chassis	61565
	Torsion Bar (FrontSpringType)	G63893	61683
96-02	All	G63375 ⁵	61555 77375 81713 ⁵	G63896	61565 77638	43180 ⁸ 49231 ⁷
	Exc. 8600# GVW	34073 ⁸
78-95	All	G63357 ⁵	58357 61517	G63413	61522 81496 ⁹	49212 ⁷
70-95	Single System Steering Stabilizer	6802SE ⁶⁴

5 Use kit No. 140719 to replace O.E. hardware for lower shock absorber mounting when studs break or self-tapping screws are not longer useable.;

7 Pair Packs, Air hose kit included.;

40 Complete Assembled Unit.;

53 Hardware from O.E. Part may need to be reused.;

67 Mount Kit. Hardware from O.E. Part may need to be reused.;

6 It is recommended that when replacing shocks on vehicles with "quad shocks" all 4 shocks should be matched by series.;



8 Pair Packs.;

45 Strut must be rotated to align notch with lower control arm.;

54 Kit with Mount and Bearing. Hardware from O.E. Part may need to be reused.;

84 Replacement damper for vehicles with the Gabriel Aftermarket mounting kit.;

APPLICATION GUIDE

Year	Fitment Notes										
		Ultra	Ready Mounts	Max Control LTV ProGuard Guardian	Strut Cushion\ Strut Mount\ Dampers\ Stabilizer	HiJackers\ Load Carrier\ Classic	Ultra	Ready Mounts	Max Control LTV ProGuard Guardian	Strut Cushion\ Strut Mount\ Dampers\ Stabilizer	HiJackers\ Load Carrier\ Classic

CHEVROLET

CHEVROLET

VAN 1/2 TON, G / EXPRESS (cont)

71-77	All	⊗	G63357 ⁵	58357 61517	⊗	G63306	49162 ⁷
67-70	All	⊗	⊗	G63306	49162 ⁷
70	Independent Front Suspension	⊗	G63357 ⁵	58357 61517	⊗
64-66	All	⊗	⊗	82003

VAN 1/2 TON, P SERIES

74-80	All	⊗	G63355	61525 81039	34036 ⁶	⊗	G63366	77662
73	All	⊗	G63355	61525 81039	34036 ⁶	⊗	G63349	61524 81164	43111 ⁸ 49155 ⁷
67-72	All	⊗	G63355	61525 81039	34036 ⁶	⊗	49107 ⁷ 82003
63-66	All	⊗	G63355	61525 81039	34036 ⁶	⊗	G63306	49162 ⁷
61-62	All	⊗	82035	⊗	82086

VAN 3/4 TON, G / EXPRESS

24	All	⊗	G63895	61685	⊗	G63897	61687 77638
17-23	All	⊗	G63895	61685	⊗	G63897	61687 77638	43180 ⁶
10-16	All	⊗	61685	⊗	G63897	61687 77638	43180 ⁶
03-16	Coil(FrontSpringType)	⊗	G63895	⊗
03-12	Torsion Bar (FrontSpringType)	⊗	G63893	61683	⊗
03-09	All	⊗	⊗	G63897	61687 77638	43180 ⁶
96-02	Exc. 8600# GVW	⊗	G63375 ⁵	61555 77375 81713 ⁵	34073 ⁶	⊗	G63638	61565 77638	43180 ⁶ 49231 ⁷
78-95	All	⊗	G63357 ⁵	⊗
	Exc. 8600# GVW	⊗	58357 61517	⊗	G63413	61522 81496 ⁶	49212 ⁷
70-95	Single System Steering Stabilizer	⊗	6802SE ⁸⁴										
71-77	All	⊗	G63357 ⁵	58357 61517	⊗	G63306	49162 ⁷
70	All	⊗	58357	⊗	G63306	49162 ⁷
	Independent Front Suspension	⊗	G63357 ⁵	61517	⊗
67-69	All	⊗	⊗	G63306	49162 ⁷

VAN 3/4 TON, P SERIES

79-89	All	⊗	G63355	61525 81039	34036 ⁶	⊗	G63366	77662
73-78	All	⊗	G63355	61525 81039	34036 ⁶	⊗	G63349	61524 81164	43111 ⁸ 49155 ⁷
68-72	All	⊗	G63355	61525 81039	34036 ⁶	⊗	G63306	49162 ⁷
63-67	All	⊗	82047	⊗
61-62	All	⊗	82047	⊗	43140 ⁶ 49203 ⁷ 82155

VAN 1 TON, G / EXPRESS

25	All	⊗	⊗	61687
----	-----	---	------	------	------	------	------	---	------	------	-------	------	------



5 Use kit No. 140719 to replace O.E. hardware for lower shock absorber mounting when studs break or self-tapping screws are not longer useable.;

7 Pair Packs, Air hose kit included.;

6 It is recommended that when replacing shocks on vehicles with "quad shocks" all 4 shocks should be matched by series.;

8 Pair Packs.;

APPLICATION GUIDE

Year	Fitment Notes										
		Ultra	Ready Mounts	Max Control\ LTV\ ProGuard\ Guardian	Strut Cushion\ Strut Mount\ Dampers\ Stabilizer	HiJackers\ Load Carrier\ Classic	Ultra	Ready Mounts	Max Control\ LTV\ ProGuard\ Guardian	Strut Cushion\ Strut Mount\ Dampers\ Stabilizer	HiJackers\ Load Carrier\ Classic

CHEVROLET

CHEVROLET

VAN 1 TON, G / EXPRESS (cont)

24	All	OE	G63895	61685	OE	G63897	77638
17-23	All	OE	G63895	61685	OE	G63897	61687 77638	43180 ⁸
13-16	All	OE	61685	OE	G63897	61687 77638	43180 ⁸
03-16	Coil(FrontSpringType)	OE	G63895
10-12	All	OE	61685	OE	77638	43180 ⁸
03-12	Single Rear Wheels	OE	OE	G63897	61687
	Torsion Bar (FrontSpringType)	OE	G63893
03-09	All	OE	OE	77638	43180 ⁸
97-02	All	OE	G63375 ⁵	61555 77375 81713 ⁵	OE	61565	43180 ⁸ 49231 ⁷
	Exc. 8600# GVW	OE	34073 ⁸	OE	G63638
96	All	OE	G63357	58357 61517 61555 77375 81713 ⁵	OE	43180 ⁸ 49231 ⁷
	Exc. 8600# GVW	OE	34073 ⁸	OE	61565
	Cutaway Van	OE	58357	OE	G63671
94-95	Single System Steering Stabilizer; HD with Straight Front Axle & Tilt Hood	OE	6804SE ⁸⁰										
92-95	9200# GVW	OE	OE	77403
	Cutaway Van	OE	OE	G63671	61522 81496 ⁶	49212 ⁷
78-95	All	OE	G63357	58357 61517	OE
	Exc. Cutaway Van	OE	OE	G63413
71-95	Single System Steering Stabilizer	OE	6802SE ⁸⁴										
79-91	9200# GVW	OE	OE	G63403	77403
78-91	Cutaway Van	OE	OE	61522 81496 ⁶	49212 ⁷
76-77	All	OE	G63357	OE	G63306	49162 ⁷
75	110.0 / 279.4(WheelBase)	OE	OE	G63306	49162 ⁷
	125.0 / 317.5(WheelBase)	OE	OE	G63306	49162 ⁷
	146.0 / 370.8(WheelBase)	OE	G63357	58357 61517
71-74	All	OE	G63357	58357 61517	OE	G63306	49162 ⁷

VAN 1 TON, P SERIES

86-99	Motorhome Chassis w/ I-Beam Front Suspension	OE	G63625
85-99	Motorhome Chassis w/ Independent Front Suspension	OE	G63394
73-99	All	OE	OE	G63366
85-93	Single System Steering Stabilizer; w/ I-Beam Front Suspension	OE	6804SE ⁸⁰										
73-90	Cutaway Chassis	OE	G63355	61525 81039	34036 ⁸	

5 Use kit No. 140719 to replace O.E. hardware for lower shock absorber mounting when studs break or self-tapping screws are not longer useable;

7 Pair Packs, Air hose kit included.;



80 Mounting bracket not required, install on O.E. Shock Mounts. See Ref. C for optional Steering Stabilizer Boots;;

6 It is recommended that when replacing shocks on vehicles with "quad shocks" all 4 shocks should be matched by series.;

8 Pair Packs.;

84 Replacement damper for vehicles with the Gabriel Aftermarket mounting kit;















APPLICATION GUIDE

Year	Fitment Notes										
		Ultra	Ready Mounts	Max Control LTV ProGuard Guardian	Strut Cushion\ Strut Mount\ Dampers\ Stabilizer	HiJackers\ Load Carrier\ Classic	Ultra	Ready Mounts	Max Control LTV ProGuard Guardian	Strut Cushion\ Strut Mount\ Dampers\ Stabilizer	HiJackers\ Load Carrier\ Classic











CHEVROLET

CHEVROLET





VAN 1 TON, P SERIES (cont)

85	Motorhome Chassis w/ I-Beam Front Suspension		G63403	58403 77403	
74-84	Motorhome Chassis		G63394	
68-72	All		34036 ⁶	
	Cutaway Chassis		G63355	61525 81039	
	Exc. 11,000# Rear Axle			G63306	49162 ⁷
63-67	All		82047	
61-62	All		82047		43140 ⁸ 49203 ⁷ 82155

VENTURE

05	All		G55948	G57060 ¹⁰	142526 ⁵⁴		G63776	61659 81924
	FWD			49230 ⁷
02-04	All		G55948	142526 ⁵⁴		G63776	61659 81924
	FWD		G57060 ¹⁰		49230 ⁷
97-01	FWD		G55948	G57060 ¹⁰	142526 ⁵⁴		G63776	61659 81924	49230 ⁷





















VOLT

12-15	Left		G57377 ⁴⁰	
	Right		G57378 ⁴⁰	



CHRYSLER

CHRYSLER

200

11-14	Convertible Left		G57577 ⁴⁰		G57579 ⁴⁰
	Convertible Right		G57578 ⁴⁰		G57579 ⁴⁰
	Sedan Left		G57465 ⁴⁰		G57447 ⁴⁰
	Sedan Right		G57466 ⁴⁰		G57447 ⁴⁰
14	Left		G52117	143336 ⁵⁴		G51863
	Right		G52118	143336 ⁵⁴		G51863
11-13	All		143336 ⁵⁴	
	Left		G52117	
	Right Standard Suspension		G52118	
	Standard Suspension			G51863

300

11-22	RWD			G51721
-------	-----	---	------	------	------	------	------	---	--------	------	------	------	------



7 Pair Packs, Air hose kit included.;

8 Pair Packs.;

48 40 Complete Assembled Unit.;

54 Kit with Mount and Bearing. Hardware from O.E. Part may need to be reused.;

APPLICATION GUIDE

Year	Fitment Notes										
		Ultra	Ready Mounts	Max Control\ LTV\ ProGuard\ Guardian	Strut Cushion\ Strut Mount\ Dampers\ Stabilizer	HiJackers\ Load Carrier\ Classic	Ultra	Ready Mounts	Max Control\ LTV\ ProGuard\ Guardian	Strut Cushion\ Strut Mount\ Dampers\ Stabilizer	HiJackers\ Load Carrier\ Classic

CHRYSLER

CHRYSLER

300 (cont)

11-13	All		143468 ⁵⁷	
06-10	RWD, Left		G57071 ⁴⁰ G57194 ⁴⁰	
	RWD, Right		G57072 ⁴⁰ G57195 ⁴⁰	
05-10	All		143335 ⁵⁷
	AWD, Exc. Nivomat Suspension			70086
	RWD		143369 ⁵³
	RWD, Exc. Nivomat Suspension			G51721
	RWD, Left Exc. Performance Suspension		G51761
	RWD, Left Performance Suspension		G51947
	RWD, Right Exc. Performance Suspension		G51760
RWD, Right Performance Suspension		G51948	
05	RWD, Left		G57071 ⁴⁰
	RWD, Right		G57072 ⁴⁰
70-71	All		82011		49149 ⁷	
65-69	All		82011		49106 ⁷ 82131	
57-64	All		82072		81469	49110 ⁷

300M

99-04	Left		G56962 ⁴⁰	143057 ⁵¹		G55856	G56964 ⁴⁰	142828 ⁵³ 143058 ⁵¹
	Right		G56963 ⁴⁰	143057 ⁵¹		G55856	G56964 ⁴⁰	142828 ⁵³ 143058 ⁵¹

ASPEN

07-09	All		G64016	61720		G63892
-------	-----	--	--------	------	-------	------	------	--	--------	------	------	------	------

CIRRUS

99-00	All		143030 ⁵³ 143064 ⁵¹		G51268	143063 ⁵¹
	J2(MfrBodyCode)		G51267
95-98	All		143030 ⁵³ 143064 ⁵¹	143063 ⁵¹
	Convertible		G57422 ⁴⁰

CONCORDE

98-04	Left		G56962 ⁴⁰	143057 ⁵¹		G55856	G56964 ⁴⁰	142828 ⁵³ 143058 ⁵¹
	Right		G56963 ⁴⁰	143057 ⁵¹		G55856	G56964 ⁴⁰	142828 ⁵³ 143058 ⁵¹
93-97	All		142755 ⁵⁷ 143057 ⁵¹

7 Pair Packs, Air hose kit included.;



51 Strut Cushion for use with the Strut/Cartridge/Shocks.;

67 Mount Kit. Hardware from O.E. Part may need to be reused.;

40 Complete Assembled Unit.;

53 Hardware from O.E. Part may need to be reused.;

APPLICATION GUIDE

Year	Fitment Notes										
		Ultra	Ready Mounts	Max Control LTV ProGuard Guardian	Strut Cushion\ Strut Mount\ Dampers\ Stabilizer	HiJackers\ Load Carrier\ Classic	Ultra	Ready Mounts	Max Control LTV ProGuard Guardian	Strut Cushion\ Strut Mount\ Dampers\ Stabilizer	HiJackers\ Load Carrier\ Classic

CHRYSLER

CHRYSLER

CONQUEST

87-89	Exc. Electronic Adjustable Suspension	↑	143058 ⁵¹	143057 ⁵¹
-------	---------------------------------------	---	-------	-------	-------	----------------------	-------	-------	-------	-------	----------------------	-------

CORDOBA

77-79	All	○	81153
75-76	All	○	81153	49106 ⁷ 82131

CROSSFIRE

04-08	All	○	70064
-------	-----	---	-------	-------	-------	-------	-------	-------	-------	-------	-------	-------

DAYTONA

86-93	All	↑	142933 ⁶⁷	49369 ⁷
	CAN	↑	143059 ⁵¹
84-85	All	○	49369 ⁷

DYNASTY

88-93	All	↑	142933 ⁶⁷
	CAN	↑	143059 ⁵¹

E CLASS

84	All	○	49369 ⁷
83	All	○	143057 ⁵¹	49369 ⁷

EXECUTIVE LIMOUSINE

85	All	○	49369 ⁷
----	-----	---	-------	-------	-------	-------	-------	-------	-------	-------	-------	--------------------

EXECUTIVE SEDAN

84	All	○	49369 ⁷
83	All	○	143057 ⁵¹	49369 ⁷

IMPERIAL

90-93	All	↑	142933 ⁶⁷ 143059 ⁵¹
	Exc. Hydraulic Self-Leveling System	○	49369 ⁷
74-75	All	○	49106 ⁷ 82131
67-73	All	○	82011	81091	49149 ⁷
57-66	All	○	82072	81469	49110 ⁷
56	All	○	81582
55	All	○	81582	81469	49110 ⁷

INTREPID

98-04	Left	↑	G56962 ⁴⁰	G55856	142828 ⁵³
	Right	↑	G56963 ⁴⁰	G55856	142828 ⁵³
	CAN	↑	143057 ⁵¹	143058 ⁵¹

7 Pair Packs, Air hose kit included.;



51 Strut Cushion for use with the Strut/Cartridge/Shocks.;

67 Mount Kit. Hardware from O.E. Part may need to be reused.;

40 Complete Assembled Unit.;

53 Hardware from O.E. Part may need to be reused.;

APPLICATION GUIDE

Year	Fitment Notes										
		Ultra	Ready Mounts	Max Control\ LTV\ ProGuard\ Guardian	Strut Cushion\ Strut Mount\ Dampers\ Stabilizer	HiJackers\ Load Carrier\ Classic	Ultra	Ready Mounts	Max Control\ LTV\ ProGuard\ Guardian	Strut Cushion\ Strut Mount\ Dampers\ Stabilizer	HiJackers\ Load Carrier\ Classic

CHRYSLER

CHRYSLER

INTREPID (cont)

93-97	CAN				143057 ⁵¹					
-------	-----	--	--	--	----------------------	--	--	--	--	--

LASER

86	All				142933 ⁶⁷		69632			49369 ⁷
84-85	All						69632			49369 ⁷

LEBARON

86-95	All				142933 ⁶⁷ 143059 ⁵¹		69632			49369 ⁷
84-85	All						69632			49369 ⁷
82-83	All				143057 ⁵¹		69632			49369 ⁷
81	All				143057 ⁵¹		69632			
	Exc. M Body									49369 ⁷

LHS

99-01	Left		G56962 ⁴⁰		143057 ⁵¹		G55856	G56964 ⁴⁰		142828 ⁵³ 143058 ⁵¹	
	Right		G56963 ⁴⁰		143057 ⁵¹		G55856	G56964 ⁴⁰		142828 ⁵³ 143058 ⁵¹	
94-97	All				142755 ⁶⁷ 143057 ⁵¹					143058 ⁵¹	

NASSAU

55-56	All			81582					81469		49110 ⁷
-------	-----	--	--	-------	--	--	--	--	-------	--	--------------------

NEON

00-02	Left	G55892	G56975 ⁴⁰	M55892	142932 ⁶⁷			G56973 ⁴⁰		143057 ⁵¹ 143256 ⁵³	
	Right	G55892	G56975 ⁴⁰	M55892	142932 ⁶⁷			G56974 ⁴⁰		143057 ⁵¹ 143256 ⁵³	

NEW YORKER

94-96	All				142755 ⁶⁷ 143057 ⁵¹					
88-93	All				142933 ⁶⁷					
	Exc. Hydraulic Self-Leveling System						69632			49369 ⁷
86-87	All				142933 ⁶⁷		69632			49369 ⁷
84-85	All						69632			49369 ⁷
83	All				143057 ⁵¹		69632			49369 ⁷
74-78	All									49106 ⁷ 82131
70-73	All					82011			81091	49149 ⁷
65-69	All					82011				49106 ⁷ 82131
57-64	All								81469	49110 ⁷
55-56	All			81582					81469	49110 ⁷
51-54	All								81469	49110 ⁷

7 Pair Packs, Air hose kit included.;



51 Strut Cushion for use with the Strut/Cartridge/Shocks.;

67 Mount Kit. Hardware from O.E. Part may need to be reused.;

40 Complete Assembled Unit.;

53 Hardware from O.E. Part may need to be reused.;







APPLICATION GUIDE

Year	Fitment Notes										
		Ultra	Ready Mounts	Max Control\ LTV\ ProGuard\ Guardian	Strut Cushion\ Strut Mount\ Dampers\ Stabilizer	HiJackers\ Load Carrier\ Classic	Ultra	Ready Mounts	Max Control\ LTV\ ProGuard\ Guardian	Strut Cushion\ Strut Mount\ Dampers\ Stabilizer	HiJackers\ Load Carrier\ Classic



CHRYSLER

CHRYSLER



NEWPORT

79-81	All		81153
74-78	All		49106 ⁷ 82131
70-73	All		82011	49149 ⁷
65-69	All		82011	49106 ⁷ 82131
57-64	All		82072	49110 ⁷
55-56	All		81582	49110 ⁷
51-54	All		81469	49110 ⁷





PACIFICA

04-08	Left		G57112 ⁴⁰	143059 ⁵¹
	Right		G57113 ⁴⁰	143059 ⁵¹































PT CRUISER

01-10	All		G55896	G56965 ⁴⁰	M55896	142932 ⁶⁷		69473	143057 ⁵¹
-------	-----	---	--------	----------------------	--------	----------------------	------	---	-------	------	------	----------------------	------

SARATOGA

57-60	All		82072		81469	49110 ⁷
51-52	All			81469	49110 ⁷

SEBRING

08-10	Left		G52117	143336 ⁵⁴		G51863
	Right		G52118	143336 ⁵⁴		G51863
	Convertible Left		G57577 ⁴⁰		G57579 ⁴⁰
	Convertible Right		G57578 ⁴⁰		G57579 ⁴⁰
	Sedan Left		G57465 ⁴⁰		G57447 ⁴⁰
	Sedan Right		G57466 ⁴⁰		G57447 ⁴⁰
07	All		143336 ⁵⁴		G51863
03-06	Sedan and Convertible; JR (MfrBodyCode)		G51267	143423 ⁶⁷		G51268	143321 ⁵³ 143423 ⁶⁷
01-06	Convertible			G57422 ⁴⁰
	Sedan, JR(MfrBodyCode)			G57026 ⁴⁰
01-05	Coupe, ST(MfrBodyCode)		143087 ⁵³		G57075 ⁴⁰	142419 ⁶⁷
01-02	Sedan and Convertible; JR (MfrBodyCode)		G51267	143423 ⁶⁷		G51268	143321 ⁵³
99-00	Convertible		143030 ⁵³ 143064 ⁵¹		143063 ⁵¹ 143320 ⁵³
	Coupe		G55820	142419 ⁶⁷ 143057 ⁵¹		G57075 ⁴⁰	142419 ⁶⁷ 143057 ⁵¹
	Sedan and Convertible; JR (MfrBodyCode)		G51267		G51268

7 Pair Packs, Air hose kit included.;

51 Strut Cushion for use with the Strut/Cartridge/Shocks.;



52 54 Kit with Mount and Bearing. Hardware from O.E. Part may need to be reused.;

40 Complete Assembled Unit.;

53 Hardware from O.E. Part may need to be reused.;

67 Mount Kit. Hardware from O.E. Part may need to be reused.;

APPLICATION GUIDE

Year	Fitment Notes										
		Ultra	Ready Mounts	Max Control\ LTV\ ProGuard\ Guardian	Strut Cushion\ Strut Mount\ Dampers\ Stabilizer	HiJackers\ Load Carrier\ Classic	Ultra	Ready Mounts	Max Control\ LTV\ ProGuard\ Guardian	Strut Cushion\ Strut Mount\ Dampers\ Stabilizer	HiJackers\ Load Carrier\ Classic

CHRYSLER

CHRYSLER

SEBRING (cont)

96-98	Convertible	143030 ⁵³ 143064 ⁵¹	143063 ⁵¹
	Coupe	G55820	142419 ⁶⁷ 143057 ⁵¹	142419 ⁶⁷ 143057 ⁵¹
95	All	142419 ⁶⁷ 143057 ⁵¹	142419 ⁶⁷ 143057 ⁵¹
	Coupe	G55820

SPIRIT

92-95	All	69632
-------	-----	-------	-------	-------	-------	-------	-------	-------	-------	-------

ST REGIS

55-56	All	81582	81469	49110 ⁷
-------	-----	-------	-------	-------	-------	-------	-------	-------	-------	-------	--------------------

TOWN & COUNTRY

08-16	All	G57206 ⁴⁰	
	Exc. Self-Leveling Suspension	G64042	
	Exc. S Models	G52131	
01-07	All	G56620	
	Left	G56956 ⁴⁰	
	Right	G56957 ⁴⁰	
96-07	Exc. Hydraulic Self-Leveling System	G63690 ¹⁰	61605 ³⁴ 81878	49236 ⁷
96-00	All	G55697	M55697	143059 ⁵¹	
90-95	All	142933 ⁶⁷ 143059 ⁵¹	G63426	49236 ⁷
82-88	All	69632	49369 ⁷
79-81	All	81153
74-78	All	49106 ⁷ 82131
71-73	All	82011	81091	49149 ⁷
65-70	All	82011	49106 ⁷ 82131
57-64	All	82072	81469	49110 ⁷
55-56	All	81582	81469	49110 ⁷
51-54	All	81469	49110 ⁷

VOYAGER / GRAND VOYAGER

04-07	Left	G56620	G56956 ⁴⁰	143059 ⁵¹
	Right	G56620	G56957 ⁴⁰	143059 ⁵¹
01-03	Left	G56956 ⁴⁰
	Right	G56957 ⁴⁰

7 Pair Packs, Air hose kit included.;

34 If suspension spring contacts this unit, rotate suspension spring 180 degrees.;

51 Strut Cushion for use with the Strut/Cartridge/Shocks.;



67 Mount Kit. Hardware from O.E. Part may need to be reused.;

10 The Nivomat leveling shocks are on the rear only. If suspension spring contacts units, rotate suspension spring 180 degrees.;

40 Complete Assembled Unit.;

53 Hardware from O.E. Part may need to be reused.;

APPLICATION GUIDE

Year	Fitment Notes										
		Ultra	Ready Mounts	Max Control LTV ProGuard Guardian	Strut Cushion\ Strut Mount\ Dampers\ Stabilizer	HiJackers\ Load Carrier\ Classic	Ultra	Ready Mounts	Max Control LTV ProGuard Guardian	Strut Cushion\ Strut Mount\ Dampers\ Stabilizer	HiJackers\ Load Carrier\ Classic

CHRYSLER

CHRYSLER

VOYAGER / GRAND VOYAGER (cont)

03	All	↓	G56620	143059 ⁵¹		
	Exc. Hydraulic Self-Leveling System	↓	○	G63690 ¹⁰	61605 ³⁴ 81878	49236 ⁷
01-02	All	↓	G56620	143059 ⁵¹	○	49236 ⁷
00-02	Exc. Hydraulic Self-Leveling System	↓	○	G63690 G63690 ¹⁰	61605 ³⁴ 81878	49236 ⁷
00	All	↓	G55697	M55697	143059 ⁵¹	○	49236 ⁷
	Non-ABS	↓	G55697	M55697	○
	Non-ABS Exc. Hydraulic Self-Leveling System	↓	○	61605 ³⁴ 81878

WINDSOR

57-61	All	↓	82072	○	81469	49110 ⁷
55-56	All	↓	81582	○	81469	49110 ⁷
51-54	All	↓	○	81469	49110 ⁷

COACH HOUSE

COACH HOUSE

PLATINUM

03-24	Motorhomes with Ford E450 Chassis	↓	G63622	○
		↓	○	G63623

PLATINUM III

19-22	MotorHomes with Ford Transit-350 Chassis	↓	○	G64177
-------	--	---	------	------	------	------	------	---	--------	------	------	------	------

PLATINUM IV

23-24	Motorhomes with Ford E450 Chassis	↓	G63622	○
		↓	○	G63623

COACHMEN

COACHMEN

BEYOND

19-22	MotorHomes with Ford Transit-350 Chassis	↓	○	G64177
-------	--	---	------	------	------	------	------	---	--------	------	------	------	------

CONCORD

23-24	MotorHomes with Ford E350 or E450 Chassis	↓	G63622	○
		↓	○	G63623
07-19	MotorHomes with Ford E350 or E450 Chassis	↓	G63622	○
		↓	○	G63623

CROSS TRAIL TRANSIT

21-22	MotorHomes with Ford Transit-350 Chassis	↓	○	G64177
-------	--	---	------	------	------	------	------	---	--------	------	------	------	------

FREEDOM EXPRESS

09	MotorHomes with Ford E350 or E450 Chassis	↓	G63622	○
		↓	○	G63623



7 Pair Packs, Air hose kit included.;

34 If suspension spring contacts this unit, rotate suspension spring 180 degrees.;

10 The Nivomat leveling shocks are on the rear only. If suspension spring contacts units, rotate suspension spring 180 degrees.;

51 Strut Cushion for use with the Strut/Cartridge/Shocks.;

APPLICATION GUIDE

Year	Fitment Notes										
		Ultra	Ready Mounts	Max Control\ LTV\ ProGuard\ Guardian	Strut Cushion\ Strut Mount\ Dampers\ Stabilizer	HiJackers\ Load Carrier\ Classic	Ultra	Ready Mounts	Max Control\ LTV\ ProGuard\ Guardian	Strut Cushion\ Strut Mount\ Dampers\ Stabilizer	HiJackers\ Load Carrier\ Classic

COACHMEN

COACHMEN

FREELANDER

08-24	MotorHomes with Ford E350 or E450 Chassis	 O	G63622
		
		 O	G63623
		

LEPRECHAUN

11-24	MotorHomes with Ford E350 or E450 Chassis	 O	G63622
		
08-09	MotorHomes with Ford E350 or E450 Chassis	 O	G63622
		
		 O	G63623
		

NOVA

25	20C, Left	 O	G57800 ⁴⁰
	20C, Right		G57801 ⁴⁰

DAIHATSU

DAIHATSU

ROCKY

90-92	All	 O	G63611	81872
-------	-----	-------	--------	------	-------	------	------	------	------	------	------

DESOTO

DESOTO

ADVENTURER

60	All	 O	82072	81469	49110 ⁷
57-59	All	 O	82072	81469
56	All	 E	81582	81469

CUSTOM

51-52	All	 O	81469	49110
-------	-----	-------	------	------	------	------	------	------	------	-------	------	-------

DELUXE

51-52	All	 O	81469	49110
-------	-----	-------	------	------	------	------	------	------	------	-------	------	-------

DESOTO

61	All	 O	82072	81469	49110 ⁷
----	-----	-------	------	------	------	------	-------	------	------	-------	------	--------------------

FIREHOME

57-59	All	 O	82072	81469	49110 ⁷
55-56	All	 E	81582	81469	49110 ⁷
52-54	All	 O	81469	49110 ⁷

FIREFLITE

57-60	All	 O	82072	81469	49110 ⁷
56	All	 E	81582	81469	49110 ⁷



FIRESWEEP

57-59	All	 O	82072	81469	49110 ⁷
-------	-----	-------	------	------	------	------	-------	------	------	-------	------	--------------------

POWERMASTER

53-54	All	 O	81469	49110 ⁷
-------	-----	-------	------	------	------	------	------	------	------	-------	------	--------------------

APPLICATION GUIDE

Year	Fitment Notes										
		Ultra	Ready Mounts	Max Control LTV ProGuard Guardian	Strut Cushion\ Strut Mount\ Dampers\ Stabilizer	HiJackers\ Load Carrier\ Classic	Ultra	Ready Mounts	Max Control LTV ProGuard Guardian	Strut Cushion\ Strut Mount\ Dampers\ Stabilizer	HiJackers\ Load Carrier\ Classic

DODGE

DODGE

330

63-64	All		82090		49106 ⁷ 82131
-------	-----	--	-------	-------	-------	-------	-------	--	-------	-------	-------	-------	-----------------------------

400

82-83	All		143057 ⁵¹		69632	49369 ⁷
-------	-----	--	-------	-------	-------	----------------------	-------	--	-------	-------	-------	-------	--------------------

440

63-64	All		82090		49106 ⁷ 82131
-------	-----	--	-------	-------	-------	-------	-------	--	-------	-------	-------	-------	-----------------------------

600

86-88	All		142933 ⁶⁷		69632	49369 ⁷
84-85	All			69632	49369 ⁷
83	All		143057 ⁵¹		69632	49369 ⁷

880

65	All		82011		49106 ⁷ 82131
62-64	All		82072		81469	49110 ⁷

2000 GTX

89-90	Exc. Auto-Leveling System		142419 ⁶⁷
89	CAN		143064 ⁵¹

A100 TRUCK

64-70	All		81469	49110 ⁷
70	Dual System Steering Stabilizer; with I-Beam Axle		6802SE ⁸⁴										
	Single System Steering Stabilizer; with I Beam Axle		6803SE ⁸⁴										
64-69	Dual System Steering Stabilizer		6802SE ⁸⁴										

ARIES

86-89	All		142933 ⁶⁷		69632	49369 ⁷
84-85	All			69632	49369 ⁷
81-83	All		143057 ⁵¹		69632	49369 ⁷

ATTITUDE

12-14	Left		G52353		70095
	Right		G52354		70095
06-11	Left		G52154		70036
	Right		G52155		70036

AVENGER

08-14	Left		G52117	G57465 ⁴⁰	143336 ⁵⁴		G51863
	Right		G52118	G57466 ⁴⁰	143336 ⁵⁴		G51863

7 Pair Packs, Air hose kit included.;

51 Strut Cushion for use with the Strut/Cartridge/Shocks.;



67 Mount Kit. Hardware from O.E. Part may need to be reused.;

40 Complete Assembled Unit.;

54 Kit with Mount and Bearing. Hardware from O.E. Part may need to be reused.;

84 Replacement damper for vehicles with the Gabriel Aftermarket mounting kit;

APPLICATION GUIDE

Year	Fitment Notes										
		Ultra	Ready Mounts	Max Control\ LTV\ ProGuard\ Guardian	Strut Cushion\ Strut Mount\ Dampers\ Stabilizer	HiJackers\ Load Carrier\ Classic	Ultra	Ready Mounts	Max Control\ LTV\ ProGuard\ Guardian	Strut Cushion\ Strut Mount\ Dampers\ Stabilizer	HiJackers\ Load Carrier\ Classic

DODGE

DODGE

AVENGER (cont)

08-14	FWD	G57447 ⁴⁰
95-00	All	G55820	142419 ⁶⁷	142419 ⁶⁷

CALIBER

12	Left	G52081	G57176 ⁴⁰	143495 ⁵⁴	G51842	G57178 ⁴⁰
	Right	G52082	G57177 ⁴⁰	143495 ⁵⁴	G51842	G57178 ⁴⁰
07-11	Left	G52081	G57176 ⁴⁰	143495 ⁵⁴	G51842	G57178 ⁴⁰	143496 ⁶⁷
	Right	G52082	G57177 ⁴⁰	143495 ⁵⁴	G51842	G57178 ⁴⁰	143496 ⁶⁷

CARAVAN / GRAND CARAVAN

19-20	All	G57206 ⁴⁰	G64042
	Exc. GT & RT Models	G52131
17-18	Exc. GT & RT Models	G52131	G64042
08-18	All	G57206 ⁴⁰
12-16	Exc. Self-Leveling Suspension	G64042
	Exc. GT & RT Models	G52131
08-11	Exc. Self-Leveling Suspension	G52131	G64042
06-07	All	G56620
01-07	Exc. Hydraulic Self-Leveling System	G63690 ¹⁰	61605 ³⁴ 81878	49236 ⁷
	Left	G56956 ⁴⁰
	Right	G56957 ⁴⁰
05	All	G56620	G63690 ¹⁰
01-04	All	G56620
96-00	All	143059 ⁵¹
	Exc. Hydraulic Self-Leveling System	G55697	M55697	G63690 ¹⁰	61605 ³⁴ 81878	49236 ⁷
86-95	All	142933 ⁶⁷ 143059 ⁵¹	G63426	49236 ⁷
84-85	All	143059 ⁵¹	G63426	49236 ⁷

CHALLENGER

11-22	RWD, Exc. Nivomat Suspension	G51721
08-10	Left	G51947	143369 ⁵³	143335 ⁶⁷

7 Pair Packs, Air hose kit included.;

34 If suspension spring contacts this unit, rotate suspension spring 180 degrees.;

51 Strut Cushion for use with the Strut/Cartridge/Shocks.;

54 Kit with Mount and Bearing. Hardware from O.E. Part may need to be reused.;



10 The Nivomat leveling shocks are on the rear only. If suspension spring contacts units, rotate suspension spring 180 degrees.;

40 Complete Assembled Unit.;

53 Hardware from O.E. Part may need to be reused.;

67 Mount Kit. Hardware from O.E. Part may need to be reused.;

APPLICATION GUIDE

Year	Fitment Notes										
		Ultra	Ready Mounts	Max Control LTV ProGuard Guardian	Strut Cushion\ Strut Mount\ Dampers\ Stabilizer	HiJackers\ Load Carrier\ Classic	Ultra	Ready Mounts	Max Control LTV ProGuard Guardian	Strut Cushion\ Strut Mount\ Dampers\ Stabilizer	HiJackers\ Load Carrier\ Classic

DODGE

DODGE

CHALLENGER (cont)

08-10	Right	↑	G51948	143369 ⁵³	↑	143335 ⁶⁷
78-83	All	↑	143059 ⁵¹	↑
70-74	All	○	82090	○	49106 ⁷ 82131

CHARGER

07-22	RWD, Exc. Nivomat Suspension	↑	○	G51721
11-13	AWD	↑	143468 ⁶⁷	↑
07-10	AWD, Exc. Nivomat Suspension	↑	○	70086
06-10	All	↑	↑	143335 ⁶⁷
	RWD	↑	143369 ⁵³	↑
	RWD, Left	↑	G57071 ⁴⁰ G57194 ⁴⁰	↑
	RWD, Left Exc. Police Models	↑	G51761	↑
	RWD, Left Police Package	↑	G51947	↑
	RWD, Right	↑	G57072 ⁴⁰ G57195 ⁴⁰	↑
	RWD, Right Exc. Police Models	↑	G51760	↑
	RWD, Right Police Package	↑	G51948	↑
06	Exc. Nivomat Suspension	↑	○	G51721
83-87	All	↑	143057 ⁵¹	↑	142173 ⁵³
77-78	All	○	81153	↑
73-76	All	○	81153	○	49106 ⁷ 82131
66-72	All	○	82090	○	49106 ⁷ 82131

COLT

93-95	All	↑	G55911	142329 ⁵³	↑	142419 ⁶⁷ 143064 ⁵¹
90-95	Exc. Wagon	↑	143057 ⁵¹	↑
92	All	↑	↑	142419 ⁶⁷ 143064 ⁵¹
89-91	Hatchback	↑	↑	142419 ⁶⁷ 143064 ⁵¹
85-91	Vista, FWD, Wagon	↑	143059 ⁵¹	↑
84	Wagon	↑	143059 ⁵¹	↑
75-80	Wagon	↑	143059 ⁵¹	○	43048 ⁸ 49310 ⁷ 82156
77-79	Exc. Wagon & Hatchback	○	○	81676
71-74	All	○	○	43048 ⁸ 49310 ⁷ 82156

7 Pair Packs, Air hose kit included.;

40 Complete Assembled Unit.;



58 53 Hardware from O.E. Part may need to be reused.;

8 Pair Packs.;

51 Strut Cushion for use with the Strut/Cartridge/Shocks.;

67 Mount Kit. Hardware from O.E. Part may need to be reused.;

APPLICATION GUIDE

Year	Fitment Notes										
		Ultra	Ready Mounts	Max Control\ LTV\ ProGuard\ Guardian	Strut Cushion\ Strut Mount\ Dampers\ Stabilizer	HiJackers\ Load Carrier\ Classic	Ultra	Ready Mounts	Max Control\ LTV\ ProGuard\ Guardian	Strut Cushion\ Strut Mount\ Dampers\ Stabilizer	HiJackers\ Load Carrier\ Classic

DODGE

DODGE

COLT (cont)

71-74	Wagon				143059 ⁵¹					
-------	-------	--	--	--	----------------------	--	--	--	--	--

CONQUEST

84-86	All								143058 ⁵¹	
-------	-----	--	--	--	--	--	--	--	----------------------	--

CORONET

73-76	All			81153						49106 ⁷ 82131
65-72	All					82090				49106 ⁷ 82131
57-59	All					82072		81469		49110 ⁷
55-56	All			81582				81469		49110 ⁷
51-54	All							81469		49110 ⁷

CUSTOM

57-61	All					82072		81469		49110 ⁷
55-56	All			81582				81469		49110 ⁷
54	All							81469		49110 ⁷

DAKOTA

10	4WD							G63891			
	RWD							G63890			
05-09	All		G51815			143385 ⁵⁷					
	4WD			G57146 ⁴⁰				G63891			
	RWD			G57409 ⁴⁰				G63890			
97-04	All							G63403		61658 77403 81923	
	4WD		G63905		61601 77905 81836						
	RWD		G63915		61512 77915 81559						
87-96	4WD				61679 81836					61584 81837	
	RWD		G63915		61512 77915 81559					81560	
87-94	Single System Steering Stabilizer									6804SE ⁸⁰	

DART

13-16	Sport Suspension							G511142			
63-76	All					82090			81469		49110 ⁷
62	All					82090					49106 ⁷ 82131
60-61	All					82072			81469		49110 ⁷

DAYTONA

86-93	All				142933 ⁵⁷ 143059 ⁵¹						
-------	-----	--	--	--	--	--	--	--	--	--	--

7 Pair Packs, Air hose kit included.;



51 Strut Cushion for use with the Strut/Cartridge/Shocks.;

80 Mounting bracket not required, install on O.E. Shock Mounts. See Ref. C for optional Steering Stabilizer Boots.;

40 Complete Assembled Unit.;

67 Mount Kit. Hardware from O.E. Part may need to be reused.;

APPLICATION GUIDE

Year	Fitment Notes										
		Ultra	Ready Mounts	Max Control LTV ProGuard Guardian	Strut Cushion\ Strut Mount\ Dampers\ Stabilizer	HiJackers\ Load Carrier\ Classic	Ultra	Ready Mounts	Max Control LTV ProGuard Guardian	Strut Cushion\ Strut Mount\ Dampers\ Stabilizer	HiJackers\ Load Carrier\ Classic

DODGE

DODGE

DAYTONA (cont)

84-93	Exc. Shelby & Base Models	69632	49369 ⁷
-------	---------------------------	-------	-------	-------	-------	-------	-------	-------	-------	-------	-------	--------------------

DURANGO

16-21	All	G511000
11-15	Left	G57749 ⁴⁰	G511000
	Right	G57825 ⁴⁰	G511000
04-09	All	G64016	61720	G63892	61734
99-03	RWD	G63915	61512 77915 81559
98-03	All	G63403	77403
	4WD	G63905	61601 77905 81836
	Exc. AWD	61658 81923

DYNASTY

88-93	All	142933 ⁶⁷ 143059 ⁵¹
-------	-----	-------	-------	-------	--	-------	-------	-------	-------	-------	-------	-------

INTREPID

98-04	Left	G56962 ⁴⁰	143057 ⁵¹	G55856	G56964 ⁴⁰	142828 ⁵³ 143058 ⁵¹
	Right	G56963 ⁴⁰	143057 ⁵¹	G55856	G56964 ⁴⁰	142828 ⁵³ 143058 ⁵¹
93-97	All	142755 ⁶⁷ 143057 ⁵¹

JOURNEY

17-20	Exc. GT Left	G52148
	Exc. GT Right	G52149
11-20	AWD Right	G57751 ⁴⁰
09-20	FWD; Exc. GT & R/T Models Left	G57266 ⁴⁰
	FWD; Exc. GT & R/T Models Right	G57267 ⁴⁰
20	Left AWD	G57750 ⁴⁰
12-19	AWD, Left	G57750 ⁴⁰
09-16	Left	G52148
	Right	G52149
11	AWD Left	G57750 ⁴⁰
09-10	FWD	G51848

LANCER

86-89	All	142933 ⁶⁷	69632	49369 ⁷
-------	-----	-------	-------	-------	----------------------	-------	-------	-------	-------	-------	-------	--------------------

7 Pair Packs, Air hose kit included.;



51 Strut Cushion for use with the Strut/Cartridge/Shocks.;

60 67 Mount Kit. Hardware from O.E. Part may need to be reused.;

40 Complete Assembled Unit.;

53 Hardware from O.E. Part may need to be reused.;

APPLICATION GUIDE

Year	Fitment Notes										
		Ultra	Ready Mounts	Max Control\ LTV\ ProGuard\ Guardian	Strut Cushion\ Strut Mount\ Dampers\ Stabilizer	HiJackers\ Load Carrier\ Classic	Ultra	Ready Mounts	Max Control\ LTV\ ProGuard\ Guardian	Strut Cushion\ Strut Mount\ Dampers\ Stabilizer	HiJackers\ Load Carrier\ Classic

DODGE

DODGE

LANCER (cont)

85	All		69632	49369 ⁷
61-62	All	⊥	82090	81469	49110 ⁷

M300

74	All	⊥	G63605	G63183	82065
----	-----	---	--------	------	------	------	--------	------	------	------	-------

M350

74	All	⊥	G63605	82065
----	-----	---	--------	------	------	------	------	------	------	------	-------

MAGNUM

05-08	All		⊥	143335 ⁶⁷
	Exc. Nivomat Suspension		⊥	G51721
	RWD	⊥	143369 ⁵³
	RWD, Left	⊥	G57071 ⁴⁰ G57194 ⁴⁰
	RWD, Left Exc. Performance Suspension	⊥	G51761
	RWD, Left Performance Suspension	⊥	G51947
	RWD, Right	⊥	G57072 ⁴⁰ G57195 ⁴⁰
	RWD, Right Exc. Performance Suspension	⊥	G51760
RWD, Right Performance Suspension	⊥	G51948	
78-79	All	⊥	81153	

MEADOWBROOK

51-54	All		⊥	81469	49110 ⁷
-------	-----	--	------	------	------	------	---	------	------	-------	------	--------------------

MINI RAM

87-88	All	⊥	143059 ⁵¹	⊥	G63426	49236 ⁷
84-86	All	⊥	G63359 ³⁵	58359 ³⁵ 61523 ³⁵ 81096 ³⁵	34052 ⁸	⊥	G63413 ³⁵	61522 ⁶ 81496	43085 ⁸ 49212 ⁷

MONACO

77-78	All	⊥	81153	⊥	49106 ⁷ 82131	
74-76	All	⊥	⊥	49106 ⁷ 82131	
73	All	⊥	82011	⊥	81091	82131
	Exc. Wagon	⊥	⊥	49106 ⁷
	Wagon	⊥	⊥	49149 ⁷
72	All	⊥	82011	⊥	49106 ⁷ 82131	
71	All	⊥	82011	⊥	81091
	Wagon	⊥	⊥	49149 ⁷
65-70	All	⊥	82011	⊥	49106 ⁷ 82131	

6 It is recommended that when replacing shocks on vehicles with "quad shocks" all 4 shocks should be matched by series.;

8 Pair Packs.;

40 Complete Assembled Unit.;

53 Hardware from O.E. Part may need to be reused.;



7 Pair Packs, Air hose kit included.;

35 Slight grinding of control arm opening is required to install product made before Aug 1988.;

51 Strut Cushion for use with the Strut/Cartridge/Shocks.;

67 Mount Kit. Hardware from O.E. Part may need to be reused.;

APPLICATION GUIDE

Year	Fitment Notes										
		Ultra	Ready Mounts	Max Control\ LTV\ ProGuard\ Guardian	Strut Cushion\ Strut Mount\ Dampers\ Stabilizer	HiJackers\ Load Carrier\ Classic	Ultra	Ready Mounts	Max Control\ LTV\ ProGuard\ Guardian	Strut Cushion\ Strut Mount\ Dampers\ Stabilizer	HiJackers\ Load Carrier\ Classic

DODGE

DODGE

NEON

00-05	All	142932 ⁶⁷	143057 ⁵¹ 143256 ⁵³
	Exc. SRT4 Left	G55892	G56975 ⁴⁰	M55892	G56973 ⁴⁰
	Exc. SRT4 Right	G55892	G56975 ⁴⁰	M55892	G56974 ⁴⁰
95-99	All	143057 ⁵¹	143059 ⁵¹

NITRO

07-11	Left	G51728	G57007 ⁴⁰	G63844
	Right	G51728	G57008 ⁴⁰	G63844

OMNI

90	All	143059 ⁵¹	142173 ⁵³
78-89	All	143057 ⁵¹	142173 ⁵³

PICKUP 1/2 TON, D100 SERIES

72-93	All	G63359 ³⁵	58359 ³⁵ 61523 ³⁵ 81096 ³⁵	34052 ⁸	G63353	81091	49149 ⁷
86-89	Single System Steering Stabilizer	6802SE ⁸⁴									
72-79	Single System Steering Stabilizer	6802SE ⁸⁴									
60-71	Single System Steering Stabilizer; with I Beam Axle	6802SE ⁸⁴									
60	All	82065

PICKUP 1/2 TON, W100 SERIES

90-93	Single System Steering Stabilizer	6802SE ⁸⁴									
81-93	Exc. Lift Kit	G63183	61632 81825	81342
60-89	Single System Steering Stabilizer	6803SE ⁸⁴									
60-86	Dual System Steering Stabilizer; Exc. Vacuum Servo Mounted on Drivers Side of Axle	6802SE ⁸⁴									
72-80	All	G63183	61632 81825	81342
61-71	All	G63183	61632 81825
60	All	82065

PICKUP 3/4 TON, D200 SERIES

82-93	All	G63353	81091	49149 ⁷
	Exc. Heavy Duty Package	G63359 ³⁵	58359 ³⁵ 61523 ³⁵ 81096 ³⁵	34052 ⁸
	Heavy Duty Package	G63360 ³⁵	81834
73-93	Single System Steering Stabilizer	6802SE ⁸⁴									
75-81	Heavy Duty Package	G63360 ³⁵
	165.0 / 419.1(WheelBase) Heavy Duty Package	81834

7 Pair Packs, Air hose kit included.;

35 Slight grinding of control arm opening is required to install product made before Aug 1988.;

51 Strut Cushion for use with the Strut/Cartridge/Shocks.;

67 Mount Kit. Hardware from O.E. Part may need to be reused.;;



8 Pair Packs.;

40 Complete Assembled Unit.;

53 Hardware from O.E. Part may need to be reused.;

84 Replacement damper for vehicles with the Gabriel Aftermarket mounting kit;

APPLICATION GUIDE

Year	Fitment Notes										
		Ultra	Ready Mounts	Max Control\ LTV\ ProGuard\ Guardian	Strut Cushion\ Strut Mount\ Dampers\ Stabilizer	HiJackers\ Load Carrier\ Classic	Ultra	Ready Mounts	Max Control\ LTV\ ProGuard\ Guardian	Strut Cushion\ Strut Mount\ Dampers\ Stabilizer	HiJackers\ Load Carrier\ Classic

DODGE

DODGE

PICKUP 3/4 TON, D200 SERIES (cont)

81	All
	Exc. Heavy Duty Package	G63359 ³⁵	58359 ³⁵ 61523 ³⁵ 81096 ³⁵	34052 ⁸	49149 ⁷
72-80	All	49149 ⁷
	Exc. Heavy Duty Package	G63359 ³⁵	58359 ³⁵ 61523 ³⁵ 81096 ³⁵	34052 ⁸
72-74	Heavy Duty Package	G63360 ³⁵	81834
60-71	Single System Steering Stabilizer; with I Beam Axle	6802SE ⁸⁴									
60	All	82065

PICKUP 3/4 TON, W200 SERIES

90-93	Single System Steering Stabilizer	6802SE ⁸⁴									
81-93	Exc. Crew Cab & Lift Kit	G63183	61632 81825	81342
69-89	Single System Steering Stabilizer	6803SE ⁸⁴									
60-86	Dual System Steering Stabilizer; Exc. Vacuum Servo Mounted on Drivers Side of Axle	6802SE ⁸⁴									
72-80	All	G63183	61632 81825	81342
69-71	All	G63183	61632 81825
61-67	All	G63183	61632 81825
60-67	Single System Steering Stabilizer	6803SE ⁸⁴									
60	All	82065

PICKUP 1 TON, D300 SERIES

75-93	Single System Steering Stabilizer	6802SE ⁸⁴									
72-93	All	49149 ⁷
	Heavy Duty Package	G63360 ³⁵	81834
72-74	Single System Steering Stabilizer; with Coil Spring Front Suspension	6802SE ⁸⁴									
61-71	All	82065
60-71	Single System Steering Stabilizer; with I Beam Axle	6802SE ⁸⁴									

PICKUP 1 TON, W300 SERIES

90-93	Single System Steering Stabilizer	6802SE ⁸⁴									
81-93	Exc. Quad Suspension and Lift Kit	G63183	61632 81825	81342
60-89	Single System Steering Stabilizer	6803SE ⁸⁴									
60-86	Dual System Steering Stabilizer; Exc. Vacuum Servo Mounted on Drivers Side of Axle	6802SE ⁸⁴									
72-80	All	G63183	61632 81825	81342
61-71	All	G63183	61632 81825	G63183	61632 81825

7 Pair Packs, Air hose kit included.;

35 Slight grinding of control arm opening is required to install product made before Aug 1988.;

8 Pair Packs.;

84 Replacement damper for vehicles with the Gabriel Aftermarket mounting kit;

APPLICATION GUIDE

Year	Fitment Notes										
		Ultra	Ready Mounts	Max Control LTV ProGuard Guardian	Strut Cushion\ Strut Mount\ Dampers\ Stabilizer	HiJackers\ Load Carrier\ Classic	Ultra	Ready Mounts	Max Control LTV ProGuard Guardian	Strut Cushion\ Strut Mount\ Dampers\ Stabilizer	HiJackers\ Load Carrier\ Classic

DODGE

DODGE

PICKUP 1/2 TON, RAM 1500 (SEE RAM 1500)

09-10	4WD	↓	G51856	G57147 ⁴⁰		
	RWD	↓	G64043		
08-10	All	↓	77412		
06-08	4WD, Mega Cab	↓	61712		
	4WD; Exc. Mega Cab	↓	G51758	G57053 ⁴⁰	143324 ⁵³	G63961	61691 81931		
	4WD; w/5.7L	↓	77980		
	RWD, Exc. Mega Cab	↓	34052 ⁸		
	RWD, Extended Crew Cab Pickup	↓	77949		
	RWD; Exc. Mega Cab	↓	G63958	77954 81933	G63962	61692	
06-07	Exc. Mega Cab	↓	77412		
00-07	4WD; With OEM # 52106909AB, AC, AD	↓	6847SE ⁸²							
02-05	All	↓	G63675	77412 81931
	4WD	↓	G63848	77947 81932	61691
	RWD	↓	G63958	77954 81933	34052 ⁸	61692
94-01	All	↓	G63662	61600 77662 81873	43181 ⁸ 49235 ⁷
	4WD	↓	G63673	61634 77673 81919
	RWD	↓	G63661	61599 77661 81928
94-97	4WD; With OEM 52038276	↓	6804SE ⁸⁰							

PICKUP 3/4 TON, RAM 2500 (SEE RAM 2500)

07-10	4WD	↓	G64011	61714 77948	61716
03-10	All	↓	77950
	4WD, 8800# GVW	↓	G64013
	RWD	↓	77949
	RWD, Crew Cab Pickup	↓	G63971	61710
00-07	4WD; With OEM # 52106909AB, AC, AD	↓	6847SE ⁸²							
06	4WD	↓	G64011	61714	61716
	4WD; Exc. 5.7L	↓	77948
	4WD; w/5.7L	↓	77980
04-05	4WD	↓	G64011	61714 77948	61716
03	Exc. 8800# GVW	↓	G63662	61600 81873
	4WD	↓	77948	61716
99-02	4WD, Exc. 8800# GVW	↓	G63673	61634 77673 81919

7 Pair Packs, Air hose kit included.;

40 Complete Assembled Unit.;



80 Mounting bracket not required, install on O.E. Shock Mounts. See Ref. C for optional Steering Stabilizer Boots.;

8 Pair Packs.;

53 Hardware from O.E. Part may need to be reused.;

82 Use kit if listed, See Ref. C for optional Steering Stabilizer Boots.;

APPLICATION GUIDE

Year	Fitment Notes										
		Ultra	Ready Mounts	Max Control\ LTV\ ProGuard\ Guardian	Strut Cushion\ Strut Mount\ Dampers\ Stabilizer	HiJackers\ Load Carrier\ Classic	Ultra	Ready Mounts	Max Control\ LTV\ ProGuard\ Guardian	Strut Cushion\ Strut Mount\ Dampers\ Stabilizer	HiJackers\ Load Carrier\ Classic

DODGE

DODGE

PICKUP 3/4 TON, RAM 2500 (SEE RAM 2500) (cont)

94-02	Exc. 8800# GVW	G63662	61600 77662 81873	49235 ⁷
	4WD, 8800# GVW	G63674	61635 77674	G63675	61642 77675 81921
	RWD	G63661	61599 77661 81928
96-98	4WD, Exc. 8800# GVW	G63673	61634 77673
94-97	4WD; With OEM 52038276	6804SE ⁸⁰										
94-95	4WD, Exc. 8800# GVW	G63673	61634 77673 81919

PICKUP 1 TON, RAM 3500 (SEE RAM 3500)

08-10	RWD, Crew Cab Pickup	G63971
07-10	4WD	G63673	77948
03-10	All	77950
	RWD	77949
03-07	RWD, Crew Cab Pickup	G63971	61710
00-07	4WD; With OEM # 52106909AB, AC, AD	6847SE ⁸²										
	RWD; With OEM # 52106909AB, AC, AD and Solid Front Axle	6847SE ⁸²										
06	4WD	G63673
	4WD, Exc. 5.9L	77948
	4WD; w/5.7L	77980
03-05	4WD	G63673	77948
94-02	4WD	G63674	61635 77674	G63675	61642 77675 81921
	RWD, Exc. Solid Front Axle	G63661	61599 77661 81928	G63662	61600 77662 81873	43181 ⁸ 49235 ⁷
	RWD, Solid Front Axle	G63674	61635 77674	G63675	61642 77675 81921
94-97	4WD; With OEM 52038276	6804SE ⁸⁰										
	RWD; w/ OEM 52038276 Solid Front Axle	6804SE ⁸⁰										

PICKUP, RAM 50

87-93	4WD	61529	G63419
	RWD	G63950	61556	G63907	61500 77907 81147	43048 ⁸ 49310 ⁷
83-93	Single System Steering Stabilizer	6802SE ⁸⁴										
83-86	All	G63907	61500 77907	43048 ⁸ 49310 ⁷
	4WD	G63418
	RWD	G63950	61556	81147

7 Pair Packs, Air hose kit included.;



80 Mounting bracket not required, install on O.E. Shock Mounts. See Ref. C for optional Steering Stabilizer Boots.;

84 Replacement damper for vehicles with the Gabriel Aftermarket mounting kit;

8 Pair Packs.;

82 Use kit if listed, See Ref. C for optional Steering Stabilizer Boots.;

APPLICATION GUIDE

Year	Fitment Notes										
		Ultra	Ready Mounts	Max Control\ LTV\ ProGuard\ Guardian	Strut Cushion\ Strut Mount\ Dampers\ Stabilizer	HiJackers\ Load Carrier\ Classic	Ultra	Ready Mounts	Max Control\ LTV\ ProGuard\ Guardian	Strut Cushion\ Strut Mount\ Dampers\ Stabilizer	HiJackers\ Load Carrier\ Classic

DODGE

DODGE

SPRINTER 2500 (cont)

07-09	Single Rear Wheels	OO	G63918
03-06	All	G56778
	Exc. Dual Rear Wheels	OO	G63918

SPRINTER 3500

07-09	All	...	G57802 ⁴⁰
	Single Rear Wheels	OO	G63918
03-06	All	G56778
	Exc. Dual Rear Wheels	OO	G63918

ST. REGIS

79-81	All	IO	81153
-------	-----	----	-----	-----	-------	-----	--	-----	-----	-----	-----	-----

STEALTH

91-96	All		142419 ⁶⁷	...
-------	-----	--	-----	-----	-----	-----	--	-----	-----	-----	----------------------	-----

STRATUS

01-06	Sedan	G51267		G51268	G57026 ⁴⁰	...	143321 ⁵³	...
	Sedan and Convertible; JR (MfrBodyCode)	143423 ⁶⁷	143423 ⁶⁷	...
01-05	Coupe	G57075 ⁴⁰
	Coupe, ST(MfrBodyCode)	143087 ⁵³	142419 ⁶⁷	...
99-00	All	143064 ⁵¹	143063 ⁵¹	...
	Sedan	G51267		G51268
	Sedan and Convertible; JR (MfrBodyCode)	143423 ⁶⁷	...
95-98	All	143030 ⁵³ 143064 ⁵¹	143063 ⁵¹	...
	Convertible	G57422 ⁴⁰

TRUCK

59-60	All	OO	82065	
53-58	All	OO	82065	OO	82065

VAN 1/2 TON, A / B SERIES / RAM

99-03	109.3 / 277.6(WheelBase) Exc. 7000# GVW	IO	G63359 ³⁵	...	58359 ³⁵ 61523 ³⁵ 81096 ³⁵	...	34052 ⁸	OO	G63413	...	61522 ⁶ 81496	...	43085 ⁸ 49212 ⁷
82-98	109.6 / 278.4(WheelBase) Exc. 7000# GVW	IO	G63359 ³⁵	...	58359 ³⁵ 61523 ³⁵ 81096 ³⁵	...	34052 ⁸	OO	G63413	...	61522 ⁶ 81496	...	43085 ⁸ 49212 ⁷
71-87	Single System Steering Stabilizer	OO	6803SE ⁸⁴										

6 It is recommended that when replacing shocks on vehicles with "quad shocks" all 4 shocks should be matched by series.;

8 Pair Packs.;

40 Complete Assembled Unit.;

53 Hardware from O.E. Part may need to be reused.;

84 Replacement damper for vehicles with the Gabriel Aftermarket mounting kit;



7 Pair Packs, Air hose kit included.;

35 Slight grinding of control arm opening is required to install product made before Aug 1988.;

51 Strut Cushion for use with the Strut/Cartridge/Shocks.;

67 Mount Kit. Hardware from O.E. Part may need to be reused.;;











APPLICATION GUIDE

Year	Fitment Notes										
		Ultra	Ready Mounts	Max Control LTV ProGuard Guardian	Strut Cushion\ Strut Mount\ Dampers\ Stabilizer	HiJackers\ Load Carrier\ Classic	Ultra	Ready Mounts	Max Control LTV ProGuard Guardian	Strut Cushion\ Strut Mount\ Dampers\ Stabilizer	HiJackers\ Load Carrier\ Classic











DODGE

DODGE















VAN 1/2 TON, A / B SERIES / RAM (cont)

81	109.6 / 278.4(WheelBase) Exc. 7000# GVW		G63359 ³⁵	58359 ³⁵ 61523 ³⁵ 81096 ³⁵		G63413	61522 ⁶ 81496	43085 ⁶
71-80	All		58359 ³⁵ 61523 ³⁵ 81096 ³⁵	34052 ⁸		G63413	61522 ⁶ 81496	43085 ⁶ 49212 ⁷
	Exc. 4000# Front Axle		G63359 ³⁵	
71	Single System Steering Stabilizer; with I Beam Axle		6802SE ⁸⁴										
64-70	All			81469	49110 ⁷
	Van			82065





VAN 3/4 TON, A / B SERIES / RAM

81-03	All		G63359 ³⁵	58359 ³⁵ 61523 ³⁵ 81096 ³⁵	34052 ⁸		G63413	61522 ⁶ 81496	43085 ⁶ 49212 ⁷
80-87	Single System Steering Stabilizer		6803SE ⁸⁴										
71-80	All		58359 ³⁵ 61523 ³⁵ 81096 ³⁵	34052 ⁸		G63413	61522 ⁶ 81496	43085 ⁶ 49212 ⁷
	Exc. 4000# Front Axle		G63359 ³⁵	
78-79	Van Charger Special		6803SE ⁸⁴										
71-77	Single System Steering Stabilizer		6803SE ⁸⁴										
71	Single System Steering Stabilizer; with I Beam Axle		6802SE ⁸⁴										









VAN 1 TON, A / B SERIES / RAM

95-03	All		G63359 ³⁵	58359 ³⁵ 61523 ³⁵ 81096 ³⁵	34052 ⁸		G63413	61522 ⁶ 81496	43085 ⁶ 49212 ⁷
94	All			61522 ⁶ 81496	43085 ⁶ 49212 ⁷
	Exc. 4000# Front Axle		G63359 ³⁵	58359 ³⁵ 61523 ³⁵ 81096 ³⁵	34052 ⁸		G63413
71-93	All			G63413	61522 ⁶ 81496	43085 ⁶ 49212 ⁷
	4000# Front Axle		G63360 ³⁵	81834	
	Exc. 4000# Front Axle		G63359 ³⁵	58359 ³⁵ 61523 ³⁵ 81096 ³⁵	34052 ⁸	
71-87	Single System Steering Stabilizer		6803SE ⁸⁴										
71	Single System Steering Stabilizer; with I Beam Axle		6802SE ⁸⁴										

VAN 1 TON, P SERIES

66-72	All			82065
61-64	All			82065

VAN, CB300

78-80	All			G63413	61522 ⁶ 81496	43085 ⁶ 49212 ⁷
	Exc. 4000# Front Axle		G63359 ³⁵	58359 ³⁵ 61523 ³⁵ 81096 ³⁵	34052 ⁸	
74-80	4000# Front Axle		G63360 ³⁵	81834	
74-77	Exc. 4000# Front Axle		G63359 ³⁵	61523 ³⁵ 81096 ³⁵	





6 It is recommended that when replacing shocks on vehicles with "quad shocks" all 4 shocks should be matched by series.;

8 Pair Packs.;

7 Pair Packs, Air hose kit included.;

35 Slight grinding of control arm opening is required to install product made before Aug 1988.;







APPLICATION GUIDE

Year	Fitment Notes										
		 Ultra	Ready Mounts	Max Control\ LTV\ ProGuard\ Guardian	Strut Cushion\ Strut Mount\ Dampers\ Stabilizer	HiJackers\ Load Carrier\ Classic	 Ultra	Ready Mounts	Max Control\ LTV\ ProGuard\ Guardian	Strut Cushion\ Strut Mount\ Dampers\ Stabilizer	HiJackers\ Load Carrier\ Classic

DODGE

DODGE



VAN, CB300 (cont)

74-77	Up through 8300# GVW		58359 ³⁵	34052 ⁸	
77	All		G63413	61522 ⁶ 81496	43085 ⁸
	Over 8300# GVW		49212 ⁷
75-76	All		G63413	61522 ⁶ 81496	43085 ⁸ 49212 ⁷
74	All		G63413	61522 ⁶ 81496	43085 ⁸
	Over 8300# GVW		49212 ⁷









EAGLE

EAGLE



2000 GTX

91-93	All		142419 ⁹⁷
	CAN		143057 ⁵¹	143064 ⁵¹

SUMMIT

93-96	All		143057 ⁵¹	142419 ⁹⁷
	Coupe		G55911	142329 ⁵³
	Sedan		G55911	142329 ⁵³
92	All		143057 ⁵¹
	Sedan		142419 ⁹⁷ 143064 ⁵¹
	Wagon		142419 ⁹⁷
89-91	All		143057 ⁵¹	143064 ⁵¹
	Sedan		142419 ⁹⁷

TALON

95-98	All		142419 ⁹⁷	142419 ⁹⁷
90-94	All		143057 ⁵¹	142419 ⁹⁷ 143064 ⁵¹

VISION

93-97	All		142755 ⁶⁷ 143057 ⁵¹
-------	-----	---	------	------	------	--	------	------	------	------	------	------



VISTA

89-91	CAN, Wagon		143059 ⁵¹
-------	------------	---	------	------	------	----------------------	------	------	------	------	------	------

EDSEL

EDSEL

BERMUDA

58	All		69625	34073 ⁸ 82099		82076
----	-----	---	-------	------	------	------	-----------------------------	---	------	------	------	------	-------

6 It is recommended that when replacing shocks on vehicles with "quad shocks" all 4 shocks should be matched by series.;

8 Pair Packs.;

51 Strut Cushion for use with the Strut/Cartridge/Shocks.;



67 Mount Kit. Hardware from O.E. Part may need to be reused.;

7 Pair Packs, Air hose kit included.;

35 Slight grinding of control arm opening is required to install product made before Aug 1988.;

53 Hardware from O.E. Part may need to be reused.;

APPLICATION GUIDE

Year	Fitment Notes										
		Ultra	Ready Mounts	Max Control LTV ProGuard Guardian	Strut Cushion\ Strut Mount\ Dampers\ Stabilizer	HiJackers\ Load Carrier\ Classic	Ultra	Ready Mounts	Max Control LTV ProGuard Guardian	Strut Cushion\ Strut Mount\ Dampers\ Stabilizer	HiJackers\ Load Carrier\ Classic

EDSEL

EDSEL

CITATION

58	All	69625	34073 ⁸ 82099	○	82076
----	-----	-------	------	------	------	-----------------------------	---	------	------	------	------	-------

CORSAIR

58-59	All	69625	34073 ⁸ 82099	○	82076
	Exc. Wagon	○	49110 ⁷

PACER

58	All	69625	34073 ⁸ 82099	○	81270	49105 ⁷
----	-----	-------	------	------	------	-----------------------------	---	------	------	-------	------	--------------------

RANGER

60	All	82099	○	82076
58-59	All	82099	○	81270	49105 ⁷

ROUNDUP

58	All	69625	34073 ⁸ 82099	○	82076
----	-----	-------	------	------	------	-----------------------------	---	------	------	------	------	-------

VILLAGER

58-60	All	69625	34073 ⁸ 82099	○	82076
-------	-----	-------	------	------	------	-----------------------------	---	------	------	------	------	-------

FIAT

FIAT

1500

66-67	Exc. Wagon	○	43140 ⁸
64-65	Wagon	○	49310 ⁷

FORD

FORD

AEROSTAR

89-97	All	○	49221 ⁷
	RWD	81582	○
86-88	RWD	81582	○	G63490	61541 81583

ASPIRE

94-97	Non-ABS	143057 ⁵¹	○
-------	---------	------	------	------	----------------------	------	---	------	------	------	------	------

BRONCO

80-96	Exc. Lift Kit	○	G63409	61554 81710	43167 ⁸
	Quad Suspension; Forward of Front Axle; Exc. Lift Kit	G63410 ⁶	61546 ⁸	○
	Rearward of Front Axle; Exc. Lift Kit	G63414 ⁶	61520 ⁸ 77414 ⁶ 81490	34057 ⁸	○
78-96	Dual System Steering Stabilizer; Exc. Sway Bar	○	6802SE ⁸⁴				
78-79	All	○	G63377	61519 81484	43058 ⁸ 49127 ⁷
	Quad Suspension Forward, Non Quad Suspension Left	G63511 ⁶	○
	Quad Suspension Rearward, Non Quad Suspension Right	61521 ⁶ 81394	○
70-79	Single System Steering Stabilizer	○	6803SE ⁸⁴				



6 It is recommended that when replacing shocks on vehicles with "quad shocks" all 4 shocks should be matched by series.;

8 Pair Packs.;

7 Pair Packs, Air hose kit included.;

51 Strut Cushion for use with the Strut/Cartridge/Shocks.;

APPLICATION GUIDE

Year	Fitment Notes										
		Ultra	Ready Mounts	Max Control\ LTV\ ProGuard\ Guardian	Strut Cushion\ Strut Mount\ Dampers\ Stabilizer	HiJackers\ Load Carrier\ Classic	Ultra	Ready Mounts	Max Control\ LTV\ ProGuard\ Guardian	Strut Cushion\ Strut Mount\ Dampers\ Stabilizer	HiJackers\ Load Carrier\ Classic

FORD

FORD

BRONCO (cont)

74-77	From Serial #830001; Exc. Lift Kit RWD, 4WD Quad Suspension Rearward of Front Axle, Non Quad Suspension	I O	G63386	61521 ⁶ 81394	
66-77	From Serial #830001	I O	G63377	61519 81484	43058 ⁸ 49127 ⁷
	From Serial #830001; Exc. Lift Kit RWD, 4WD Quad Suspension Rearward of Front Axle	I O
73	From Serial #830001; Exc. Lift Kit	I O	81394
	From Serial #830001; Exc. Lift Kit RWD, 4WD Quad Suspension Rearward of Front Axle, Non Quad Suspension	I O	G63386	61521 ⁶
70-72	From Serial #830001; Exc. Lift Kit RWD, 4WD Quad Suspension Rearward of Front Axle, Non Quad Suspension	I O	G63386	61521 ⁶ 81394
66-69	Single System Steering Stabilizer	O O	6804SE ⁸⁰								
69	From Serial #830001; Exc. Lift Kit	I O	81394
	From Serial #830001; Exc. Lift Kit RWD, 4WD Quad Suspension Rearward of Front Axle, Non Quad Suspension	I O	G63386	61521 ⁶
66-68	From Serial #830001; Exc. Lift Kit RWD, 4WD Quad Suspension Rearward of Front Axle, Non Quad Suspension	I O	G63386	61521 ⁶ 81394
66	Thru Serial #830000	I O	G63350	61518 81242	43099 ⁸ 49173 ⁷

BRONCO II

84-90	Single System Steering Stabilizer	O O	6802SE ⁸⁴									
90	All	I O	G63614	58929 61561 77614 81744 ⁴⁸	G63525	61627 77525 81730	49223 ⁷
89	Mfg. from 2/89; Vehicles w/ 12mm bolt in rear lower mount	I O	77414 ⁵	G63525	61627 77525 81730	49223 ⁷
	Mfg. to 2/89; Vehicles w/ 10mm & 12mm bolt in rear lower mount	I O	G63414 ⁵	61520 ⁶ 81490	61533
84-88	w/ 10mm Bolt In Rear Lower Mount	I O	G63414 ⁵	61520 ⁶ 77414 ⁵ 81490	61533

CONTOUR

95-00	All	I O	142843 ⁵⁴ 143061 ⁵¹	M55693	142402 ⁵³ 143058 ⁵¹
-------	-----	--------	------	------	--	------	------	------	------	--------	--	------

COUNTRY SEDAN

65-74	All	I E	69675 ⁵	81446	34073 ⁸	I O	69606	81495	43140 ⁹ 49205 ⁷
60-64	All	I E	69625	34073 ⁸ 82099	I O	82076
57-59	All	I E	69625	34073 ⁸ 82099	I T	49105 ⁷ 82125
52-56	All	I T	82026	I T	49105 ⁷ 82125
50-51	All	I T	82026	O O	49310 ⁷ 82156

5 Use kit No. 140719 to replace O.E. hardware for lower shock absorber mounting when studs break or self-tapping screws are not longer useable.;

7 Pair Packs, Air hose kit included.;

48 Installation Hardware Included;

53 Hardware from O.E. Part may need to be reused.;

80 Mounting bracket not required, install on O.E. Shock Mounts. See Ref. C for optional Steering Stabilizer Boots.;

6 It is recommended that when replacing shocks on vehicles with "quad shocks" all 4 shocks should be matched by series.;



8 Pair Packs.;

51 Strut Cushion for use with the Strut/Cartridge/Shocks.;

54 Kit with Mount and Bearing. Hardware from O.E. Part may need to be reused.;

84 Replacement damper for vehicles with the Gabriel Aftermarket mounting kit;

APPLICATION GUIDE

Year	Fitment Notes										
		Ultra	Ready Mounts	Max Control LTV ProGuard Guardian	Strut Cushion Strut Mount Dampers Stabilizer	HiJackers Load Carrier Classic	Ultra	Ready Mounts	Max Control LTV ProGuard Guardian	Strut Cushion Strut Mount Dampers Stabilizer	HiJackers Load Carrier Classic

FORD

FORD

COUNTRY SQUIRE

87-91	All	⊖	69675 ⁵	81446	34073 ⁸	⊖	69606	81495	43140 ⁶ 49205 ⁷
65-74	All	⊖	69675 ⁵	81446	34073 ⁸	⊖	69606	81495	43140 ⁶ 49205 ⁷
60-64	All	⊖	69625	34073 ⁸ 82099	⊖	82076
59	All	⊖	69625	34073 ⁸ 82099	⊖	69624	49135 ⁷ 82076
57-58	All	⊖	69625	34073 ⁸ 82099	⊖	69624	81095	49135 ⁷
52-56	All	⊖	82026	⊖	49105 ⁷ 82125
50-51	All	⊖	82026	⊖	82060

COURIER

72-82	All	⊖	G63421	58421 61504 81750	⊖	82125
-------	-----	---	--------	------	-------------------------	------	------	---	------	------	------	------	-------

COURIER SEDAN DELIVERY

59-60	All	⊖	69625	34073 ⁸ 82099	⊖	82076
57-58	All	⊖	69625	34073 ⁸ 82099	⊖	69624	81095	49135 ⁷
54-56	All	⊖	82026	⊖	49105 ⁷ 82125

CRESTLINE

52-54	All	⊖	82026	⊖	49105 ⁷ 82125
50-51	All	⊖	82026	⊖	49310 ⁷ 82156

CROWN VICTORIA

07-11	All	⊖	143357 ⁶⁷	⊖
	Exc. Police and Taxi Models	⊖	G51887	G57080 ⁴⁰	⊖	69575
03-11	Police and Taxi Models	⊖	G51888	⊖	69574
03-06	Exc. Police and Taxi Models	⊖	G51887	G57080 ⁴⁰	143357 ⁶⁷	⊖	69575
94-02	All	⊖	69675 ⁵	⊖	69606	81495	43140 ⁶
	Exc. Hydraulic Self-Leveling System	⊖	34073 ⁸	⊖
93-02	Police and Taxi Models	⊖	G63375 ⁵	61555 77375 81713 ⁵	⊖
92-02	Rear Air Springs	⊖	⊖	49205 ⁷
	Exc. Police and Taxi Models	⊖	81446	⊖
93	All	⊖	69675 ⁵	⊖	69606	81495
	Exc. Hydraulic Self-Leveling System	⊖	34073 ⁸	⊖	43140 ⁶
92	All	⊖	69675 ⁵	⊖	69606	81495	43140 ⁶
	Exc. Hydraulic Self-Leveling System	⊖	34073 ⁸	⊖

CUSTOM

67-72	All	⊖	69675 ⁵	81446	34073 ⁸	⊖	69606	81495	43140 ⁶ 49205 ⁷
-------	-----	---	--------------------	------	-------	------	--------------------	---	-------	------	-------	------	--

5 Use kit No. 140719 to replace O.E. hardware for lower shock absorber mounting when studs break or self-tapping screws are not longer useable.;



8 Pair Packs.;

72 67 Mount Kit. Hardware from O.E. Part may need to be reused.;

7 Pair Packs, Air hose kit included.;

40 Complete Assembled Unit.;











APPLICATION GUIDE

Year	Fitment Notes										
		Ultra	Ready Mounts	Max Control\ LTV\ ProGuard\ Guardian	Strut Cushion\ Strut Mount\ Dampers\ Stabilizer	HiJackers\ Load Carrier\ Classic	Ultra	Ready Mounts	Max Control\ LTV\ ProGuard\ Guardian	Strut Cushion\ Strut Mount\ Dampers\ Stabilizer	HiJackers\ Load Carrier\ Classic







FORD

FORD



CUSTOM (cont)

65-66	All		69625	81446	34073 ⁸ 82099		69606	81495	43140 ⁹ 49205 ⁷ 82076
64	All		69625	34073 ⁸ 82099		82076
57	All		69625	34073 ⁸ 82099		49105 ⁷ 82125
52	All		82026		49105 ⁷ 82125
50-51	All		82026		49310 ⁷ 82156



CUSTOM 300

60	All		69625	34073 ⁸ 82099		82076
59	All		69625	34073 ⁸ 82099	
58	All		69625	34073 ⁸ 82099		49105 ⁷ 82125



CUSTOM 500

68-77	All		69675 ⁵	81446	34073 ⁸		69606	81495	43140 ⁹ 49205 ⁷
-------	-----	---	--------------------	------	-------	------	--------------------	---	-------	------	-------	------	--







CUSTOMLINE

52-56	All		82026		49105 ⁷ 82125
-------	-----	--	------	------	------	------	-------	--	------	------	------	------	-----------------------------





DEL RIO WAGON

57-58	All		69625	34073 ⁸ 82099		69624	81095	49135 ⁷
-------	-----	---	-------	------	------	------	-----------------------------	---	-------	------	-------	------	--------------------



DELUXE

49-51	All		82026		82156
	Direct Acting Shocks			49310 ⁷
47-48	Direct Acting Shocks		82007		49310 ⁷ 82156

ECONOLINE

00-06	All		G63622	58622		G63623	61646
61-67	All		G63492	61506 81318		G63299	49311 ⁷ 82007









ECONOLINE SUPER DUTY

96-99	All		77614		77623
	Steering Stabilizer		6828SE ⁸⁰										

ECONOLINE VAN

61-67	Steering Stabilizer		6802SE ⁸⁴									
-------	---------------------	---	----------------------	--	--	--	--	--	--	--	--	--

EDGE

15-18	Left		G57752 ⁴⁰	
	Right		G57753 ⁴⁰	
11-14	Left		G52351	G57582 ⁴⁰		G64111
	Right		G52352	G57583 ⁴⁰		G64111

5 Use kit No. 140719 to replace O.E. hardware for lower shock absorber mounting when studs break or self-tapping screws are not longer useable.;

8 Pair Packs.;



80 Mounting bracket not required, install on O.E. Shock Mounts. See Ref. C for optional Steering Stabilizer Boots.;

7 Pair Packs, Air hose kit included.;

40 Complete Assembled Unit.;

84 Replacement damper for vehicles with the Gabriel Aftermarket mounting kit;





APPLICATION GUIDE

Year	Fitment Notes										
		Ultra	Ready Mounts	Max Control LTV ProGuard Guardian	Strut Cushion\ Strut Mount\ Dampers\ Stabilizer	HiJackers\ Load Carrier\ Classic	Ultra	Ready Mounts	Max Control LTV ProGuard Guardian	Strut Cushion\ Strut Mount\ Dampers\ Stabilizer	HiJackers\ Load Carrier\ Classic



FORD

FORD



















EDGE (cont)

07-10	Left		G56840	G57582 ⁴⁰	143415 ⁵³		G64037
	Right		G56841	G57583 ⁴⁰	143415 ⁵³		G64037







ELITE

75-76	All		69675 ⁵	81446		69606	81495	43140 ⁸ 49205 ⁷
-------	-----	---	--------------------	------	-------	------	------	---	-------	------	-------	------	--





ESCAPE

17-19	All			G511001
13-16	Left		G57517 ⁴⁰		G511001
	Right		G57518 ⁴⁰		G511001
12	Left		G56601	G57045 ⁴⁰		G511001 G64047
	Right		G56568	G57046 ⁴⁰		G511001 G64047
08-11	Left		G56601	G57045 ⁴⁰		G64047
	Right		G56568	G57046 ⁴⁰		G64047
01-07	Left		G56601	G57045 ⁴⁰		69900 G63862
	Right		G56568	G57046 ⁴⁰		69900 G63862



ESCORT

97-03	All		143061 ⁵¹		M55848
91-96	All		143057 ⁵¹		M55848	143058 ⁵¹
81-90	All		143057 ⁵¹		143059 ⁵¹









EXCURSION

00-05	4WD		G63809	77809		G63837	77837
	4WD; With OE Unit		6854SE ⁸⁰										
	RWD		G63614	77614		G63607	77607

EXP

82-88	All		143057 ⁵¹		143059 ⁵¹
-------	-----	---	------	------	------	----------------------	------	---	------	------	------	----------------------	------

EXPEDITION

14-21	4WD		G57683 ⁴⁰	
07-21	Coil (FrontSpringType); Exc. Air Suspension			G51861
14-17	4WD; RWD; Exc. Air Suspension			G57173 ⁴⁰
07-13	4WD; RWD; Exc. Air Suspension		G57172 ⁴⁰		G57173 ⁴⁰

5 Use kit No. 140719 to replace O.E. hardware for lower shock absorber mounting when studs break or self-tapping screws are not longer useable.;

8 Pair Packs.;

51 Strut Cushion for use with the Strut/Cartridge/Shocks.;



80 Mounting bracket not required, install on O.E. Shock Mounts. See Ref. C for optional Steering Stabilizer Boots.;

7 Pair Packs, Air hose kit included.;

40 Complete Assembled Unit.;

53 Hardware from O.E. Part may need to be reused.;

APPLICATION GUIDE

Year	Fitment Notes										
		Ultra	Ready Mounts	Max Control\ LTV\ ProGuard\ Guardian	Strut Cushion\ Strut Mount\ Dampers\ Stabilizer	HiJackers\ Load Carrier\ Classic	Ultra	Ready Mounts	Max Control\ LTV\ ProGuard\ Guardian	Strut Cushion\ Strut Mount\ Dampers\ Stabilizer	HiJackers\ Load Carrier\ Classic

FORD

FORD

EXPEDITION (cont)

07-13	Coil (Rear Spring Type); Exc. Air Suspension	↓	G51860	
03-06	All	↓	G51729	G57016 ⁴⁰	143317 ⁵³
	Exc. Adjustable Suspension	↓	143244 ⁵³
	4WD	↓	G57015 ⁴⁰
97-02	RWD	↓	G51719	G57212 ⁴⁰
	All	↓	O	G63717	61614 77717
	4WD, Exc. Front Air- Leveling	↓	G63716	61613 77716 81914
	RWD, Exc. Front Air- Leveling	↓	G63714	58714 61611 77714 81912
	Steering Stabilizer	O	6861SE ⁸²											

EXPLORER

16-19	Left	↓	G57819 ⁴⁰	↓	G51980
	Right	↓	G57820 ⁴⁰	↓	G51980
13-15	AWD; Mfg from 9/5/12 Left	↓	G57697 ⁴⁰	↓
	AWD; Mfg from 9/5/12 Right	↓	G57698 ⁴⁰	↓
	FWD; Mfg from 9/5/12 Left	↓	G57699 ⁴⁰	↓
	FWD; Mfg from 9/5/12 Right	↓	G57700 ⁴⁰	↓
15	All	↓	↓	G51980
11-14	All	↓	↓	G51980	143476 ⁵³
11-13	AWD, Left Mfg. to 9/4/12	↓	G57691 ⁴⁰	↓
	AWD, Right Mfg. to 9/4/12	↓	G57692 ⁴⁰	↓
	FWD; Mfg. to 9/4/12 Left	↓	G57693 ⁴⁰	↓
	FWD; Mfg. to 9/4/12 Right	↓	G57694 ⁴⁰	↓
06-10	All	↓	G56838	G57095 ⁴⁰	143360 ⁵³	↓	G56839	G57096 ⁴⁰	143361 ⁵³
04-05	Exc. All Sport & Sport Trac Models	↓	G51723	G57019 ⁴⁰	↓	G51724	G57018 ⁴⁰
02-05	All	↓	143318 ⁵³	↓	143319 ⁵³
02-03	Exc. All Sport & Sport Trac Models	↓	G51722	G57017 ⁴⁰	↓	G51724	G57018 ⁴⁰
95-01	Exc. Adjustable Suspension	O	G63678	61623 77678 81893	O	G63679	61624 77679 81890	43171 ⁵ 49232 ⁷

7 Pair Packs, Air hose kit included.;



40 Complete Assembled Unit.;

82 Use kit if listed, See Ref. C for optional Steering Stabilizer Boots.;

8 Pair Packs.;

53 Hardware from O.E. Part may need to be reused.;



APPLICATION GUIDE

Year	Fitment Notes										
		Ultra	Ready Mounts	Max Control\ LTV\ ProGuard\ Guardian	Strut Cushion\ Strut Mount\ Dampers\ Stabilizer	HiJackers\ Load Carrier\ Classic	Ultra	Ready Mounts	Max Control\ LTV\ ProGuard\ Guardian	Strut Cushion\ Strut Mount\ Dampers\ Stabilizer	HiJackers\ Load Carrier\ Classic



FORD

FORD



EXPLORER (cont)

91-94	All		G63608	58929 61591 77608 81744 ⁴⁸	34076 ⁸		G63607	61590 77607
	Steering Stabilizer		6802SE ⁸⁴										



EXPLORER SPORT TRAC

01-05	All		G63678	61623 77678 81893		G63679	61624 77679 81890	43171 ⁸ 49232 ⁷
-------	-----	---	--------	------	-------------------------	------	------	---	--------	------	-------------------------	------	--



F-1

48-52	All		G63405	61500 81147		61550 81676
-------	-----	---	--------	------	----------------	------	------	---	------	------	----------------	------	------



F-2

48-52	All		G63405	61500 81147		61550 81676
-------	-----	---	--------	------	----------------	------	------	---	------	------	----------------	------	------







F-3

48-52	All		G63405	61500 81147		61550 81676
-------	-----	---	--------	------	----------------	------	------	---	------	------	----------------	------	------















F-200

86-90	All		81490	
-------	-----	---	------	------	-------	------	------	---	------	------	------	------	------



F-250 HD

97	All			77809
	4WD		G63455	61614 77414 ⁶ 81821		G63461	61530 77461 81510
	RWD		G63414	61520 81490		G63809	61547 81082	43167 ⁸













FAIRLANE

66-70	All		82126		81270	49105 ⁷
	Wagon; Multi-Leaf Rear Spring			69606
62-65	All		82075		81270	49105 ⁷
60-61	All		69625	34073 ⁸ 82099		82076
59	All		69625	34073 ⁸ 82099	
57-58	All		69625	34073 ⁸ 82099		81270	49105 ⁷
55-56	All		82026		81270	49105 ⁷

FAIRMONT

78-83	All		143059 ⁵¹	
-------	-----	---	------	------	------	----------------------	------	---	------	------	------	------	------

FALCON

66-70	All		82126	
	Exc. Wagon			81270
	Wagon			43140 ⁸ 49205 ⁷
	Wagon; Multi-Leaf Rear Spring			69606
	Exc. Wagon			49105 ⁷
	Wagon			81495



6 It is recommended that when replacing shocks on vehicles with "quad shocks" all 4 shocks should be matched by series.;
8 Pair Packs.;

7 Pair Packs, Air hose kit included.;

48 Installation Hardware Included;

84 Replacement damper for vehicles with the Gabriel Aftermarket mounting kit;

APPLICATION GUIDE

Year	Fitment Notes										
		Ultra	Ready Mounts	Max Control\ LTV\ ProGuard\ Guardian	Strut Cushion\ Strut Mount\ Dampers\ Stabilizer	HiJackers\ Load Carrier\ Classic	Ultra	Ready Mounts	Max Control\ LTV\ ProGuard\ Guardian	Strut Cushion\ Strut Mount\ Dampers\ Stabilizer	HiJackers\ Load Carrier\ Classic

FORD

FORD

FALCON (cont)

60-65	All		82126		81270	49105 ⁷
-------	-----	--	------	------	------	------	-------	--	------	------	-------	------	--------------------

FESTIVA

88-93	All		143059 ⁵¹	143063 ⁵¹
-------	-----	--	------	------	------	----------------------	------	--	------	------	------	----------------------	------

FIESTA

14-19	All			70052
11-13	Left		G52255		70052
	Right		G52256		70052

FIVE HUNDRED

05-07	FWD, Left			G51849	143390 ⁵³
	FWD, Right			G51849	143391 ⁵³

FLEX

09-19	All			G51996
09-11	Mfg. from 07/09 Left		G57495 ⁴⁰
	Mfg. from 07/09 Right		G57496 ⁴⁰

FOCUS

17-18	Left Exc. Electric; Standard Suspension		G57724 ⁴⁰
13-18	BATTERY EV (EV/BEV) Exc. Sport Suspension			G511134
	BATTERY EV (EV/BEV) Left Heavy Duty Suspension		G57726 ⁴⁰
	EcoBoost w/ Sport Suspension			G511135
12-18	Right Exc. Electric; Standard Suspension		G57725 ⁴⁰
	Right Heavy Duty Suspension		G57727 ⁴⁰
16	Left Standard Suspension		G57724 ⁴⁰
12-15	Left Exc. Electric; Standard Suspension		G57724 ⁴⁰
13-14	Exc. Heavy Duty Suspension; Naturally Aspirated Vehicles			G511002
12	Exc. Heavy Duty Suspension			G511002
	BATTERY EV (EV/BEV) Exc. Sport Suspension; Electric Vehicles			G511134
	BATTERY EV (EV/BEV) Left		G57726 ⁴⁰
08-11	Left		G56836	G57081 ⁴⁰	142930 ⁵⁴		69464 ³⁷	81935 ³⁷
	Right		G56837	G57082 ⁴⁰	142930 ⁵⁴		69464 ³⁷	81935 ³⁷

7 Pair Packs, Air hose kit included.;

40 Complete Assembled Unit.;



53 Hardware from O.E. Part may need to be reused.;

37 Reuse or replace O.E. bumper. It is not included with this shock. Use mount kit 142992 if upper hardware needs to be replaced.;

51 Strut Cushion for use with the Strut/Cartridge/Shocks.;

54 Kit with Mount and Bearing. Hardware from O.E. Part may need to be reused.;

APPLICATION GUIDE

Year	Fitment Notes										
		Ultra	Ready Mounts	Max Control LTV ProGuard Guardian	Strut Cushion\ Strut Mount\ Dampers\ Stabilizer	HiJackers\ Load Carrier\ Classic	Ultra	Ready Mounts	Max Control LTV ProGuard Guardian	Strut Cushion\ Strut Mount\ Dampers\ Stabilizer	HiJackers\ Load Carrier\ Classic

FORD

FORD

FOCUS (cont)

06-07	Left	↓	G56836	G57081 ⁴⁰	142930 ⁵⁴	↓
	Right	↓	G56837	G57082 ⁴⁰	142930 ⁵⁴	↓
	Hatchback	↓	↓	69464 ³⁷	81935
	Sedan	↓	↓	69464 ³⁷	81935
00-07	Wagon	↓	↓	69465
00-05	Left	↓	G56516	G57063 ⁴⁰	142930 ⁵⁴	↓
	Right	↓	G56517	G57064 ⁴⁰	142930 ⁵⁴	↓
	Hatchback	↓	143057 ⁵¹	↓	69464 ³⁷	81935
	Sedan	↓	143057 ⁵¹	↓	69464 ³⁷	81935

FORD

49	All	↓	82026	↓	82060
----	-----	---	------	------	------	------	-------	---	------	------	------	------	-------

FREESTAR

04-07	All	↓	G56655	↓	G63873
-------	-----	---	--------	------	------	------	------	---	--------	------	------	------	------

FREESTYLE

05-07	Left	↓	G52110	143341 ⁵³	↓
	Right	↓	G52111	143341 ⁵³	↓

FUSION

13-20	All	↓	G57812 ⁴⁰	↓	G51965
10-12	Left	↓	G51896	G57427 ⁴⁰	↓
	Right	↓	G51897	G57427 ⁴⁰	↓
06-12	FWD	↓	↓	69591
06-09	All	↓	G51859	G57148 ⁴⁰	↓

GALAXIE

65-67	All	↓	69675 ⁵	81446	34073 ⁸	↓	69606	81495	43140 ⁸ 49205 ⁷
60-64	All	↓	69625	34073 ⁸ 82099	↓	82076
59	All	↓	69625	34073 ⁸ 82099	↓

GALAXIE 500

68-74	All	↓	69675 ⁵	81446	34073 ⁸	↓	69606	81495	43140 ⁸ 49205 ⁷
64-66	All	↓	69675 ⁵	81446	↓	69606	81495	43140 ⁸ 49205 ⁷

5 Use kit No. 140719 to replace O.E. hardware for lower shock absorber mounting when studs break or self-tapping screws are not longer useable;

8 Pair Packs.;

40 Complete Assembled Unit.;

53 Hardware from O.E. Part may need to be reused.;



7 Pair Packs, Air hose kit included.;

37 Reuse or replace O.E. bumper. It is not included with this shock. Use mount kit 142992 if upper hardware needs to be replaced.;

51 Strut Cushion for use with the Strut/Cartridge/Shocks.;

54 Kit with Mount and Bearing. Hardware from O.E. Part may need to be reused.;

APPLICATION GUIDE

Year	Fitment Notes										
		Ultra	Ready Mounts	Max Control\ LTV\ ProGuard\ Guardian	Strut Cushion\ Strut Mount\ Dampers\ Stabilizer	HiJackers\ Load Carrier\ Classic	Ultra	Ready Mounts	Max Control\ LTV\ ProGuard\ Guardian	Strut Cushion\ Strut Mount\ Dampers\ Stabilizer	HiJackers\ Load Carrier\ Classic

FORD

FORD

GRANADA

81-82	All		143059 ⁵¹
75-80	All		81491	82130

GRAND MARQUIS

01-02	All		69675 ⁵	81446	34073 ⁸		69606	81495	43140 ⁹ 49205 ⁷
-------	-----	--	--------------------	------	-------	------	--------------------	--	-------	------	-------	------	--

LOBO

22	4WD		G57683 ⁴⁰	
14-21	4WD		G57683 ⁴⁰	OO	G64079	
14-20	RWD		OO	G64157	
11-13	RWD		G51865	G57132 ⁴⁰	OO	G64157	
09-13	4WD		G51864	OO	G64079	
	4WD, Extended Cab Pickup Exc. Sport Suspension		G57103 ⁴⁰	OO	
09-10	RWD		G51865	G57132 ⁴⁰	OO	G63867	
05-08	RWD		G51703	G57021 ⁴⁰	OO	
04-08	4WD		G51704	G57020 ⁴⁰	OO	G63867	
	RWD; Exc Lightning Model		OO	G63870	
04	RWD		G51703	G57021 ⁴⁰	OO	
00-03	RWD; Exc Lightning Model		IO	G63778	61638 81892	49237 ⁷
98-03	4WD		G63716	61613 77716 81914	IO	G63715	61612 77715 81913
	Steering Stabilizer		OO	6861SE ⁸²										
97-03	RWD		G63714	58714 61611 77714 81912	IO	
97-98	RWD; Exc Lightning Model		IO	G63778	61638 81892	49237 ⁷

LTD / COUNTRY SEDAN / COUNTRY SQUIRE / CROWN VICTORIA

87-91	All		69675 ⁵	81446	34073 ⁸		69606	81495	43140 ⁹ 49205 ⁷	
85-86	Police and Taxi Models		81446	IO	
83-86	All		143059 ⁵¹	IO	
67-82	All		69675 ⁵	81446	34073 ⁸		IO	69606	81495	43140 ⁹ 49205 ⁷
65-66	All		69675 ⁵	81446	IO	69606	81495



LTD II

77-79	All		69675 ⁵	81446	34073 ⁸		IO	69606	81495	43140 ⁹ 49205 ⁷
-------	-----	--	--------------------	------	-------	------	--------------------	--	----	-------	------	-------	------	--

5 Use kit No. 140719 to replace O.E. hardware for lower shock absorber mounting when studs break or self-tapping screws are not longer useable.;
8 Pair Packs.;
51 Strut Cushion for use with the Strut/Cartridge/Shocks.;

7 Pair Packs, Air hose kit included.;
40 Complete Assembled Unit.;
82 Use kit if listed, See Ref. C for optional Steering Stabilizer Boots.;

APPLICATION GUIDE

Year	Fitment Notes										
		Ultra	Ready Mounts	Max Control LTV ProGuard Guardian	Strut Cushion\ Strut Mount\ Dampers\ Stabilizer	HiJackers\ Load Carrier\ Classic	Ultra	Ready Mounts	Max Control LTV ProGuard Guardian	Strut Cushion\ Strut Mount\ Dampers\ Stabilizer	HiJackers\ Load Carrier\ Classic

FORD

FORD

MAINLINE

52-56	All	II	82026	II	81270	49105 ⁷
-------	-----	----	------	------	------	------	-------	----	------	------	-------	------	--------------------

MAVERICK

70-77	All	II	81076	II	82130
-------	-----	----	------	------	-------	------	------	----	------	------	------	------	-------

MUSTANG / MUSTANG II

11-14	All	II	G52406	II
05-14	Convertible	II	II	69593
	Coupe	II	II	69592
05-10	All	II	G56817	G57271 ⁴⁰	143341 ⁵³	II
94-04	Base, Mach & GT Models Only	II	G55681	II	69898	81794	49234 ⁷
84-04	Position Rear	II	14039 ⁸⁵										
87-93	GT	II	II	69755
84-93	GT, 3/4" Clevis Opening	II	G55551	II
79-93	All	II	143059 ⁵¹	II
84-86	GT, SVO	II	II	69755
82-83	GT	II	II	69755
74-77	All	II	82128	II
71-73	All	II	81491	II	81270	49105 ⁷
67-70	All	II	81076	II	81270	49105 ⁷
65-66	All	II	82104	II	81270	49105 ⁷

PARK LANE WAGON

56	All	II	82026	II	81270
----	-----	----	------	------	------	------	-------	----	------	------	-------	------	------

PICKUP 1/2 TON, F-100

80-83	All	II	II	43167 ⁸
	RWD	II	G63414 ⁸	61520 77414 ⁶ 81490	34057 ⁸	II	G63409	61554 81710
	Single System Steering Stabilizer	II	6802SE ⁸⁴										
77-79	Single System Steering Stabilizer; with Twin I-Beam Axle	II	6802SE ⁸⁴										
75-79	4WD; Dual System Steering Stabilizer; Exc. Sway Bar	II	6802SE ⁸⁴										
	RWD	II	G63386	II	G63350	61518 81242	43099 ⁸ 49173 ⁷
70-79	RWD, 4WD Quad Suspension Rearward of Front Axle	II	34058 ⁸	II
	RWD, 4WD Quad Suspension Rearward, Non Quad Suspension Right	II	61521 ⁸ 81394 ⁸	II
60-79	4WD; Single System Steering Stabilizer	II	6803SE ⁸⁴										
75-76	RWD; Single System Steering Stabilizer; with Twin I-Beam Axle	II	6802SE ⁸⁴										

6 It is recommended that when replacing shocks on vehicles with "quad shocks" all 4 shocks should be matched by series;

8 Pair Packs;

51 Strut Cushion for use with the Strut/Cartridge/Shocks;

80 84 Replacement damper for vehicles with the Gabriel Aftermarket mounting kit;



7 Pair Packs, Air hose kit included.;

40 Complete Assembled Unit.;

53 Hardware from O.E. Part may need to be reused.;

85 Rear Only;

APPLICATION GUIDE

Year	Fitment Notes										
		Ultra	Ready Mounts	Max Control\ LTV\ ProGuard\ Guardian	Strut Cushion\ Strut Mount\ Dampers\ Stabilizer	HiJackers\ Load Carrier\ Classic	Ultra	Ready Mounts	Max Control\ LTV\ ProGuard\ Guardian	Strut Cushion\ Strut Mount\ Dampers\ Stabilizer	HiJackers\ Load Carrier\ Classic

FORD

FORD

PICKUP 1/2 TON, F-100 (cont)

70-76	4WD		G63387	49178 ⁷
70-74	RWD		G63350	61518	49173 ⁷
	RWD		81242
	RWD, Exc. Supercab		43099 ⁸
65-74	RWD, 4WD Quad Suspension Rearward of Front Axle, Non Quad Suspension	I O	G63386
	RWD; Single System Steering Stabilizer with Twin I Beam Axle	O O	6802SE ⁸⁴									
65-69	RWD		G63377	49127 ⁷
	4WD; Exc. Lift Kit		82147
	RWD		61519	43058 ⁸
	RWD, 4WD Quad Suspension Rearward of Front Axle	I O	61521 ⁶ 81394 ⁶	34058 ⁸
	RWD; w/Front Coil Springs		81484
61-64	All		G63405	61500 81147	43048 ⁸ 49310 ⁷
60-64	RWD; Single Steering Stabilizer; with I Beam Axle	O O	6802SE ⁸⁴									
60	All		81495	43140 ⁸
56-59	All	I I	81270	81495	43140 ⁸
54-55	All	O O	61550 81676	61550 81676
53	All	O O	61550 81676	61550
	Exc. Heavy Duty Suspension		81676

PICKUP 1/2 TON, F-150

22-24	4WD		G64079
	4WD Exc. Tremor	I I	G57683 ⁴⁰
14-24	RWD		G64157
14-21	4WD	I I	G57683 ⁴⁰	G64079
11-13	RWD	I I	G51865	G57132 ⁴⁰	G64157
09-13	4WD	I I	G51864	G64079
	4WD, Extended Cab Pickup Exc. Sport Suspension		G57103 ⁴⁰
09-10	RWD	I I	G51865	G57132 ⁴⁰	G63867
05-08	4WD	I I	G51704	G57020 ⁴⁰	G63867
	RWD	I I	G51703	G57021 ⁴⁰
	RWD; Exc Lightning Model		G63870
04	4WD	I I	G51704	G57020 ⁴⁰	G63715 G63867	61612 77715 81913
	4WD, Exc. 7000# GVW	O O	G63716	61613 77716 81914



6 It is recommended that when replacing shocks on vehicles with "quad shocks" all 4 shocks should be matched by series.; 7 Pair Packs, Air hose kit included.;

8 Pair Packs.;

40 Complete Assembled Unit.;

84 Replacement damper for vehicles with the Gabriel Aftermarket mounting kit;

APPLICATION GUIDE

Year	Fitment Notes										
		Ultra	Ready Mounts	Max Control LTV ProGuard Guardian	Strut Cushion\ Strut Mount\ Dampers\ Stabilizer	HiJackers\ Load Carrier\ Classic	Ultra	Ready Mounts	Max Control LTV ProGuard Guardian	Strut Cushion\ Strut Mount\ Dampers\ Stabilizer	HiJackers\ Load Carrier\ Classic

FORD

FORD

PICKUP 1/2 TON, F-150 (cont)

04	RWD	⌋	G51703	G57021 ⁴⁰	58714 61611 77714 81912	⌋	61638 81892	49237 ⁷
	RWD; Exc Lightning Model	⌋	⌋	G63778 G63870
97-03	4WD	⌋	G63716	61613 77716 81914	⌋	G63715	61612 77715 81913
	RWD	⌋	G63714	58714 61611 77714 81912	⌋
	RWD; Exc Lightning Model	⌋	⌋	G63778	61638 81892	49237 ⁷
	Steering Stabilizer	⌋	6861SE ⁸²										
94-96	4WD; Single System Steering Stabilizer; with Twin Traction Beam	⌋	6802SE ⁸⁴										
85-96	RWD	⌋	G63414 ⁶	61520 ⁶ 77414 ⁶	34057 ⁸	⌋	G63809	61547 77809 81082	43167 ⁸
80-96	All	⌋	81490	⌋
	4WD, Exc. Lift Kit	⌋	⌋	G63461	61530 77461 81510
	4WD, Quad Suspension; Forward of Front Axle; Exc. Lift Kit	⌋	G63410 ⁶	61546 ⁶	⌋
	4WD, Rearward of Front Axle; Exc. Lift Kit	⌋	G63414 ⁶	61520 ⁶ 77414 ⁶	34057 ⁸	⌋
90-93	Single System Steering Stabilizer	⌋	6802SE ⁸⁴										
80-89	Steering Stabilizer	⌋	6802SE ⁸⁴										
80-84	RWD	⌋	G63414 ⁶	61520 ⁶ 77414 ⁶	34057 ⁸	⌋	G63409	61554 81710	43167 ⁸
77-79	Dual System Steering Stabilizer; Exc. Sway Bar	⌋	6802SE ⁸⁴										
76-79	4WD	⌋	⌋	G63387	49178 ⁷
	Single System Steering Stabilizer	⌋	6803SE ⁸⁴										
75-79	RWD	⌋	⌋	G63350	61518 81242	49173 ⁷
	RWD, RWD, 4WD Quad Suspension Rearward of Front Axle, Non Quad Suspension	⌋	G63386	⌋
	RWD, 4WD Quad Suspension Rearward of Front Axle	⌋	34058 ⁸	⌋
	RWD, 4WD Quad Suspension Rearward, Non Quad Suspension Right	⌋	61521 ⁶ 81394 ⁶	⌋
	RWD, Standard Cab Pickup	⌋	⌋	43099 ⁸
79	Custom, Ranger, Ranger Lariat, 4WD, Quad Suspension Forward, Non Quad Suspension Left	⌋	G63511 ⁶	⌋
78	Base, Custom, Northland, Ranger, Ranger Lariat, 4WD, Quad Suspension Forward, Non Quad Suspension Left	⌋	G63511 ⁶	⌋
75-76	Steering Stabilizer	⌋	6802SE ⁸⁴										
75	4WD	⌋	⌋	49178 ⁷
	4WD	⌋	6803SE ⁸⁴										

6 It is recommended that when replacing shocks on vehicles with "quad shocks" all 4 shocks should be matched by series.;

8 Pair Packs.;



82 Use kit if listed, See Ref. C for optional Steering Stabilizer Boots.;

7 Pair Packs, Air hose kit included.;

40 Complete Assembled Unit.;

84 Replacement damper for vehicles with the Gabriel Aftermarket mounting kit;

APPLICATION GUIDE

Year	Fitment Notes										
			Ultra	Ready Mounts	Max Control\ LTV\ ProGuard\ Guardian	Strut Cushion\ Strut Mount\ Dampers\ Stabilizer	HiJackers\ Load Carrier\ Classic		Ultra	Ready Mounts	Max Control\ LTV\ ProGuard\ Guardian

FORD

FORD



PICKUP 3/4 TON, F-250 / SUPERDUTY

23-24	4WD		O	G63886	77951
	RWD		O	G63622
			O	58807 77807
22-24	4WD		O	14072
24	4WD		O	61680
			O	77988
23	4WD		O	61680	77988
	RWD		O
17-22	RWD		O	58807 77807
	RWD, Exc. Off Road		O	G63622
22	4WD		O	G63886	61680 77951	77988
17-21	4WD		O	G63886	61680 77951	14072	77988
13-16	4WD		O	G63886	61680 77951	14072	61682 77952
	RWD		O	58807 77807
12-16	RWD, w/ Off Road Package		O	G63886	61682
11-16	RWD, Exc. Off Road		O	G63622	61713
11-12	RWD		O	58807 77807
08-12	4WD		O	G63886	61680 77951	14072	61682 77952
05-10	RWD		O	G63622	58807 77807
00-10	Steering Stabilizer		O	6828SE ⁸⁰								
10	RWD, Exc. Off Road		O	61713
05-09	RWD, Exc. Off Road		O	G63622	61713
99-09	RWD, w/ Off Road		O	G63886
05-07	4WD		O	G63886	61680 77951	61682 77952
	4WD, Exc. OE Unit		O	6856SE ⁸⁶								
01-04	4WD		O	G63809	58809 61655 61680 77809 77951	61656 77810
99-04	4WD; Replacement Kit		O	6855SE ⁸²								
	Exc. OE Unit		O	6850SE ⁸⁶								
	RWD		O	G63622	58807 77807	G63808	61654 77808
	RWD, Exc. Off Road		O	G63622
99-03	4WD; With OE Unit		O	6854SE ⁸⁰								
00	4WD		O	G63809	58809 61655 77809	61656 77810

80 Mounting bracket not required, install on O.E. Shock Mounts. See Ref. C for optional Steering Stabilizer Boots;;
86 Exc. OE Unit;

82 Use kit if listed, See Ref. C for optional Steering Stabilizer Boots.;

APPLICATION GUIDE

Year	Fitment Notes										
		Ultra	Ready Mounts	Max Control LTV ProGuard Guardian	Strut Cushion\ Strut Mount\ Dampers\ Stabilizer	HiJackers\ Load Carrier\ Classic	Ultra	Ready Mounts	Max Control LTV ProGuard Guardian	Strut Cushion\ Strut Mount\ Dampers\ Stabilizer	HiJackers\ Load Carrier\ Classic

FORD

FORD

PICKUP 3/4 TON, F-250 / SUPERDUTY (cont)



97-99	4WD, Up through 8500# GVW	G63716	61613 77716 81914	G63715	61612 77715 81913
	RWD, Up through 8500# GVW	G63714	58714 61611 77714 81912	G63778	61638 81892	49237 ⁷
99	4WD	G63809	58809 61655 61680 77809 77951	G63810	61656 77810
	Steering Stabilizer	6828SE ⁸⁰	6828SE ⁸⁰ 6861SE ⁸²	6828SE ⁸⁰ 6861SE ⁸²	6828SE ⁸⁰ 6861SE ⁸²	6828SE ⁸⁰ 6861SE ⁸²	6828SE ⁸⁰ 6861SE ⁸²	6828SE ⁸⁰ 6861SE ⁸²	6828SE ⁸⁰ 6861SE ⁸²	6828SE ⁸⁰ 6861SE ⁸²	6828SE ⁸⁰ 6861SE ⁸²
98	4WD, Over 8500# GVW	G63455	61614 77455
	Steering Stabilizer	6861SE ⁸²									
97	4WD, Over 8500# GVW	G63455	61614 77455 81821	G63461	61530 77461 81510
	RWD, Over 8500# GVW	G63414	61520 ⁸ 77414 ⁸ 81490	G63809	61547 77809 81082	43167 ⁸
	Steering Stabilizer	6828SE ⁸⁰	6828SE ⁸⁰ 6861SE ⁸²	6828SE ⁸⁰ 6861SE ⁸²	6828SE ⁸⁰ 6861SE ⁸²	6828SE ⁸⁰ 6861SE ⁸²	6828SE ⁸⁰ 6861SE ⁸²	6828SE ⁸⁰ 6861SE ⁸²	6828SE ⁸⁰ 6861SE ⁸²	6828SE ⁸⁰ 6861SE ⁸²	6828SE ⁸⁰ 6861SE ⁸²
92-96	Steering Stabilizer	6828SE ⁸⁰									
87-96	4WD	G63455	61614 77455 81821	G63461	61530 77461 81510
80-96	4WD; Single System Steering Stabilizer	6802SE ⁸⁴									
	RWD	G63414	61520 ⁸ 77414 ⁸ 81490	G63809	61547 77809 81082	43167 ⁸
96	RWD, Up through 8500# GVW	58714 61611 77714
86	4WD	G63461	81510
	4WD, Clevis Type Lower Front Mount; Exc. Dual Rear Wheels or Lift Kit	61530 77461
82-85	4WD, Clevis Type Lower Front Mount; Exc. Dual Rear Wheels or Lift Kit	G63461	61530 77461 81510
80-82	4WD, Standard Cab Pickup	G63410
82	4WD	61546 ⁸
80-81	4WD	61546 ⁸	G63461	61530 77461 81510
77-79	4WD; Standard Cab, Cab & Chassis; All From Serial No. Y20001	G63387	49178 ⁷
75-79	RWD	G63386
	RWD, Cab & Chassis	G63350	81242	43058 ⁸ 49127 ⁷
	RWD, Crew Cab Pickup	61518
	RWD, Extended Cab Pickup	G63377	61519 81484	43058 ⁸ 49127 ⁷
	RWD, Standard Cab Pickup	G63350	81242	43099 ⁸ 49173 ⁷
	RWD; Single System Steering Stabilizer	6802SE ⁸⁴									

6 It is recommended that when replacing shocks on vehicles with "quad shocks" all 4 shocks should be matched by series.;
8 Pair Packs.;

7 Pair Packs, Air hose kit included.;

80 Mounting bracket not required, install on O.E. Shock Mounts. See Ref. C for optional Steering Stabilizer Boots.;

APPLICATION GUIDE

Year	Fitment Notes										
		Ultra	Ready Mounts	Max Control\ LTV\ ProGuard\ Guardian	Strut Cushion\ Strut Mount\ Dampers\ Stabilizer	HiJackers\ Load Carrier\ Classic	Ultra	Ready Mounts	Max Control\ LTV\ ProGuard\ Guardian	Strut Cushion\ Strut Mount\ Dampers\ Stabilizer	HiJackers\ Load Carrier\ Classic

FORD

FORD

PICKUP 3/4 TON, F-250 / SUPERDUTY (cont)

70-79	RWD, 4WD Quad Suspension Rearward of Front Axle	I O	34058 ⁸
	RWD; Quad Suspension Rearward of Front Axle	I O	61521 ⁶
68-78	4WD; Up through Serial No. Y2000	I T	82034
	4WD; Up through Serial No. Y20000	I O	82147
75-77	Single System Steering Stabilizer	O O	6803SE ⁸⁴									
71-74	RWD; Exc. Extended Cab & Chassis Cab	I O	49173 ⁷
70-74	RWD; Exc. Supercab	I O	81242
	RWD; Standard Cab Pickup	I O	43099 ⁹
65-74	RWD, 4WD Quad Suspension Rearward of Front Axle, Non Quad Suspension	I O	G63386
	RWD; Exc. Supercab	I O	G63350
	RWD; Supercab	I O	G63377
	RWD	I O	61518	43058 ⁸
	RWD; Supercab	I O	61519 81484
60-74	Steering Stabilizer	O O	6803SE ⁸⁴									
65-69	Supercab	I O	49127 ⁷
	RWD; Quad Suspension Rearward of Front Axle	I O	61521 ⁶ 81394 ⁹
66-67	4WD; Up through Serial No. Y20000	I T	82034	82147
61-65	4WD	I T	82034
61-64	All	I O	G63405	61500 81147	43048 ⁸
60	All	I O	81495	49203 ⁷
56-59	All	I T	81270	81495	49203 ⁷
53-55	All	O O	61550 81676	61550 81676

PICKUP 1 TON, F-350 / SUPERDUTY

23-24	4WD	I O	G63886	77951
	RWD	I O	G63622
		I O	58807 77807
22-24	4WD	O O	14072
24	4WD	I O	61680
	RWD	I O	G64268	77988
23	4WD	I O	61680	G64268	77988
	RWD	I O	G64269
17-22	RWD	I O	G63622	77807	G64269
22	4WD	I O	G63886	61680 77951	G64268	77988
	RWD	I O	58807

6 It is recommended that when replacing shocks on vehicles with "quad shocks" all 4 shocks should be matched by series.;
7 Pair Packs, Air hose kit included.;
8 Pair Packs.;

84 Replacement damper for vehicles with the Gabriel Aftermarket mounting kit;

APPLICATION GUIDE

Year	Fitment Notes										
		Ultra	Ready Mounts	Max Control\ LTV\ ProGuard\ Guardian	Strut Cushion\ Strut Mount\ Dampers\ Stabilizer	HiJackers\ Load Carrier\ Classic	Ultra	Ready Mounts	Max Control\ LTV\ ProGuard\ Guardian	Strut Cushion\ Strut Mount\ Dampers\ Stabilizer	HiJackers\ Load Carrier\ Classic

FORD

FORD

PICKUP 1 TON, F-350 / SUPERDUTY (cont)

17-21	4WD		G63886	61680 77951	14072		G64268	77988
13-16	All		G63886	58807 61680 77807
	4WD		61680 77951	14072		G63888	77952
	4WD, Exc. Off Road		G63886
	4WD, w/ Off Road Package		61682
11-16	4WD		77951
	Exc. Off Road		G63622
05-16	RWD		G63622	58807 77807		G64010
	RWD, Exc. Off Road		61713
11-12	All		G63886	61680 77807
08-12	4WD		G63886	61680 77951	14072
05-12	4WD; Single Rear Wheels; Exc. Cab & Chassis			G63888	61682 77952
99-10	Steering Stabilizer		6828SE ⁸⁰										
99-09	All		G63886	61680 77807
	4WD		77951
	Exc. Off Road		G63622
05-07	4WD		G63886	61680 77951
99-04	4WD		G63809	58809 61655 77809		G63810	61656 77810
	4WD; Replacement Kit		6855SE ⁸²										
	Exc. OE Unit		6850SE ⁸⁶										
	RWD		G63622	58807 77807		G63808	61654 77808
99-03	4WD; With OE Unit		6854SE ⁸⁰										
86-97	4WD		G63455	61614 77455 81821
	4WD, Dual Rear Wheels			G63461	61530 77461 81510
	4WD, Exc. Dual Rear Wheels			G63456
80-97	RWD		G63414	61520 ⁵ 77414 ⁵ 81490
	RWD, Dual Rear Wheels			G63409	61554 81710
	RWD, Exc. Dual Rear Wheels			G63809	61547 77809 81082	43167 ⁸
97	Steering Stabilizer		6802SE ⁸⁴	6802SE ⁸⁴ 6828SE ⁸⁰	6802SE ⁸⁴ 6828SE ⁸⁰	6802SE ⁸⁴ 6828SE ⁸⁰	6802SE ⁸⁴ 6828SE ⁸⁰		6802SE ⁸⁴ 6828SE ⁸⁰	6802SE ⁸⁴ 6828SE ⁸⁰	6802SE ⁸⁴ 6828SE ⁸⁰	6802SE ⁸⁴ 6828SE ⁸⁰	6802SE ⁸⁴ 6828SE ⁸⁰
			6802SE ⁸⁴										
92-96	RWD; Dual System Steering Stabilizer		6828SE ⁸⁰										
	Steering Stabilizer		6828SE ⁸⁰										

6 It is recommended that when replacing shocks on vehicles with "quad shocks" all 4 shocks should be matched by series;
 80 Mounting bracket not required, install on O.E. Shock Mounts. See Ref. C for optional Steering Stabilizer Boots;;

8 Pair Packs.;
 82 Use kit if listed, See Ref. C for optional Steering Stabilizer Boots.;
 86 Exc. OE Unit;

APPLICATION GUIDE

Year	Fitment Notes										
			Ultra	Ready Mounts	Max Control\ LTV\ ProGuard\ Guardian	Strut Cushion\ Strut Mount\ Dampers\ Stabilizer	HiJackers\ Load Carrier\ Classic		Ultra	Ready Mounts	Max Control\ LTV\ ProGuard\ Guardian

FORD

FORD

PICKUP 1 TON, F-350 / SUPERDUTY (cont)

89-91	RWD; Single System Steering Stabilizer								6802SE ⁸⁴				
82-88	RWD; Single System Steering Stabilizer; w/o Anti-Sway Bar								6802SE ⁸⁴				
82-85	4WD, Clevis Type Lower Front Mount; Exc. Dual Rear Wheels or Lift Kit		G63461	61530 77461 81510	
80-81	4WD		G63410	61546 ⁶	G63461	61530 77461 81510	
79-81	RWD; Dual System Steering Stabilizer								6802SE ⁸⁴				
75-79	RWD, RWD, 4WD Quad Suspension Rearward of Front Axle, Non Quad Suspension		G63386	
	RWD, Cab & Chassis		43099 ⁹ 49173 ⁷	
	RWD, Extended Cab Pickup		G63350	43099 ⁹ 49173 ⁷	
	RWD, Standard Cab Pickup		G63377	61519 81484	43058 ⁸	
	RWD; Supercab		81242	
73-79	RWD, 4WD Quad Suspension Rearward of Front Axle		
	RWD; Standard Cab Pickup		49127 ⁷	
67-79	RWD; Extended Cab		61518	
	RWD; Quad Suspension Rearward of Front Axle		61521 ⁶ 81394 ⁶	
79	4WD		G63387	49178 ⁷	
75-78	Dual System Steering Stabilizer								6802SE ⁸⁴				
75-77	Single System Steering Stabilizer								6803SE ⁸⁴				
73-74	RWD; Supercab		G63377	
	RWD; Exc. Supercab		61519 81484	
	RWD; Supercab		43058 ⁸	
67-74	RWD, 4WD Quad Suspension Rearward of Front Axle, Non Quad Suspension		G63386	
65-74	Single System Steering Stabilizer; w/ Twin I Beam Axle								6802SE ⁸⁴				
	Steering Stabilizer								6803SE ⁸⁴				
74	RWD, Extended Cab & Chassis Cab		49173 ⁷	
	RWD, Supercab		G63350	43099 ⁹	
67-73	RWD, Supercab		G63350	
65-66	All		81147	G63405	61500	43048 ⁸	
61-64	All		G63405	61500 81147	43048 ⁸	
60-64	Steering Stabilizer		6802SE ⁸⁴	6802SE ⁸⁴ 6803SE ⁸⁴	6802SE ⁸⁴ 6803SE ⁸⁴	6802SE ⁸⁴ 6803SE ⁸⁴	6802SE ⁸⁴ 6803SE ⁸⁴	6802SE ⁸⁴ 6803SE ⁸⁴	6802SE ⁸⁴ 6803SE ⁸⁴	6802SE ⁸⁴ 6803SE ⁸⁴	6802SE ⁸⁴ 6803SE ⁸⁴	6802SE ⁸⁴ 6803SE ⁸⁴	
60	All		81270	
56-59	All		81270	
53-55	All		61550 81676	61550 81676	



6 It is recommended that when replacing shocks on vehicles with "quad shocks" all 4 shocks 7 Pair Packs, Air hose kit included.;

should be matched by series.;

84 Replacement damper for vehicles with the Gabriel Aftermarket mounting kit;

8 Pair Packs.;

APPLICATION GUIDE

Year	Fitment Notes										
		Ultra	Ready Mounts	Max Control\ LTV\ ProGuard\ Guardian	Strut Cushion\ Strut Mount\ Dampers\ Stabilizer	HiJackers\ Load Carrier\ Classic	Ultra	Ready Mounts	Max Control\ LTV\ ProGuard\ Guardian	Strut Cushion\ Strut Mount\ Dampers\ Stabilizer	HiJackers\ Load Carrier\ Classic





FORD

FORD









PICKUP P100

65-67	Single System Steering Stabilizer		6802SE ⁸⁴							
-------	-----------------------------------	---	----------------------	--	--	--	--	--	--	--







PINTO

74-80	Exc. Wagon & Hatchback		82128		82004
71-73	Sedan		82128		82004









POLICE INTERCEPTOR SEDAN

16-19	Left		G57744 ⁴⁰		70096
	Right		G57745 ⁴⁰		70096
13-15	Left		G57744 ⁴⁰	
	Right		G57745 ⁴⁰	











POLICE INTERCEPTOR UTILITY

16-19	Left		G57819 ⁴⁰		G51980
	Right		G57820 ⁴⁰		G51980
13-15	All			G51980









PROBE

93-97	All			143057 ⁵¹
90-92	GT, Automatic		142569 ⁶¹	
89-92	All		142852 ⁵⁴ 143057 ⁵¹	
89	GT		142569 ⁶¹	



RANCH WAGON

65-74	All		69675 ⁵	81446	34073 ⁸ 82126		69606	81495	43140 ⁸ 49205 ⁷
59-64	All		69625	34073 ⁸ 82099		82076
57-58	All		69625	34073 ⁸ 82099		69624	81095	49135 ⁷
52-56	All		82026		81270	49105 ⁷
50-51	All		82026		82060

RANCHERO

72-79	All		81446	34073 ⁸		69606	81495	43140 ⁸ 49205 ⁷
66-71	All		82126		69606	81495
60-65	All		82126		81270	49105 ⁷
59	All		69625	34073 ⁸ 82099		82076

RANGER

19-24	RWD			G63870
-------	-----	---	------	------	------	------	------	---	--------	------	------	------	------

5 Use kit No. 140719 to replace O.E. hardware for lower shock absorber mounting when studs break or self-tapping screws are not longer useable.;

8 Pair Packs.;

51 Strut Cushion for use with the Strut/Cartridge/Shocks.;

61 Mount Kit includes Upper Spring Seat. Hardware from O.E. Part may need to be reused.;



7 Pair Packs, Air hose kit included.;

40 Complete Assembled Unit.;

54 Kit with Mount and Bearing. Hardware from O.E. Part may need to be reused.;

84 Replacement damper for vehicles with the Gabriel Aftermarket mounting kit;

APPLICATION GUIDE

Year	Fitment Notes										
		Ultra	Ready Mounts	Max Control\ LTV\ ProGuard\ Guardian	Strut Cushion\ Strut Mount\ Dampers\ Stabilizer	HiJackers\ Load Carrier\ Classic	Ultra	Ready Mounts	Max Control\ LTV\ ProGuard\ Guardian	Strut Cushion\ Strut Mount\ Dampers\ Stabilizer	HiJackers\ Load Carrier\ Classic

FORD

FORD

RANGER (cont)

07-11	RWD, Coil(FrontSpringType)	 O	G63772	61626 77772 81916	 O	G63773	61627 77525 81917	43167 ⁸
98-11	Torsion Bar(FrontSpringType)	 O	G63678	61623 77678 81893	 O	G63775	61629 77524 81918
06	RWD, Coil(FrontSpringType)	 O	G63772	61626 77772 81916	 O	G63773	61627 77525 81917	43167 ⁸ 49223 ⁷
01-05	RWD, Exc. Edge, EV, Splash & Sport Models	 O	 O	43167 ⁸ 49223 ⁷
	RWD; Coil (FrontSpringType); Exc. Sport, STX & Tremor models w/Torsion Bar	 O	G63772	61626 77772 81916	 O
98-05	RWD, Coil(FrontSpringType)	 O	 O	G63773	61627 77525 81917
98-00	RWD, Exc. Edge, EV, Splash & Sport Models	 O	G63772	61626 77772 81916	 O	43167 ⁸ 49223 ⁷
90-97	All	 O	G63614	58929 61561 77614 81744 ⁴⁸	34076 ⁸	 O
	4WD	 O	 O	G63524	61573 77524 81905
	RWD	 O	 O	G63525	61627 77525 81730	43167 ⁸ 49223 ⁷
83-97	Steering Stabilizer	 O	6802SE ⁸⁴										
87-89	Exc. High Ryder Option	 O	G63414	61520 ⁶ 77414 ⁹ 81490	34057 ⁸	 O
89	4WD	 O	 O	G63524	81540
	4WD, High Ryder Option	 O	 O	61573
	4WD, Mfg. from 2/89; Vehicles w/ 12mm bolt in rear lower mount	 O	 O	77524 81905
	RWD, Mfg. from 2/89; Vehicles w/ 12mm bolt in rear lower mount	 O	 O	G63525	61627 77525 81730	49223 ⁷
	RWD, Mfg. to 2/89; Vehicles w/ 10mm bolt in rear lower mount	 O	 O	61533
83-88	4WD	 O	 O	81540
	RWD	 O	 O	61533
83-86	All	 O	G63414	61520 ⁶ 77414 ⁹ 81490	34057 ⁸	 O

SKYLINER

59	All	 O	69625	34073 ⁸ 82099	 O	82076
58	All	 O	69625	34073 ⁸ 82099	 O	69624	81095	49135 ⁷
57	All	 O	69625	34073 ⁸ 82099	 O	69624	81095
54-56	All	 O	82026	 O	81270	49105 ⁷

STARLINER

60	All	 O	69625	34073 ⁸ 82099	 O	82076
----	-----	-------	-------	------	------	------	-----------------------------	-------	------	------	------	------	-------

6 It is recommended that when replacing shocks on vehicles with "quad shocks" all 4 shocks should be matched by series.;



8 Pair Packs.;

84 Replacement damper for vehicles with the Gabriel Aftermarket mounting kit;

7 Pair Packs, Air hose kit included.;

48 Installation Hardware Included.;

APPLICATION GUIDE

Year	Fitment Notes										
		Ultra	Ready Mounts	Max Control\ LTV\ ProGuard\ Guardian	Strut Cushion\ Strut Mount\ Dampers\ Stabilizer	HiJackers\ Load Carrier\ Classic	Ultra	Ready Mounts	Max Control\ LTV\ ProGuard\ Guardian	Strut Cushion\ Strut Mount\ Dampers\ Stabilizer	HiJackers\ Load Carrier\ Classic

FORD

FORD

SUNLINER

60	All	⊖	69625	34073 ⁸ 82099	⊖	82076
59	All	⊖	69625	34073 ⁸ 82099	⊖
57-58	All	⊖	69625	81270	34073 ⁸ 82099	⊖	69624	81095
53-56	All	⊖	82026	⊖
52	All	⊖	82026	⊖	81270

SUPER DELUXE

47-48	All	⊖	⊖	49310 ⁷
	Direct Acting Shocks	⊖	82007	⊖	82156

TAURUS

18-19	All	⊖	⊖	70096
13-19	Left	⊖	G57746 ⁴⁰	⊖
	Left Police Interceptor	⊖	G57744 ⁴⁰	⊖
	Right	⊖	G57747 ⁴⁰	⊖
	Right Police Interceptor	⊖	G57745 ⁴⁰	⊖
10-17	w/ Suspension Code A and B; Exc. SHO Models	⊖	⊖	70096
10-14	All	⊖	⊖	143476 ⁵³
10-12	Left	⊖	G57497 ⁴⁰	⊖
	Left w/ Suspension Code A and B	⊖	G52398	⊖
	Right	⊖	G57498 ⁴⁰	⊖
	Right w/ Suspension Code A and B	⊖	G52399	⊖
09	FWD, Left	⊖	G52129	G57497 ⁴⁰	⊖	G57449 ⁴⁰
	FWD, Right	⊖	G52130	G57498 ⁴⁰	⊖	G57450 ⁴⁰
08	FWD, Left	⊖	G52129	143415 ⁵³	⊖	G57449 ⁴⁰
	FWD, Right	⊖	G52130	143415 ⁵³	⊖	G57450 ⁴⁰
96-07	Left	⊖	G56934 ⁴⁰	142747 ⁶¹ 143059 ⁵¹	⊖
	Right	⊖	G56937 ⁴⁰	142747 ⁶¹ 143059 ⁵¹	⊖
94-07	Sedan	⊖	⊖	G55901	G56936 ⁴⁰	M55901	143057 ⁵¹
96-05	Wagon	⊖	⊖	69962
94-95	All	⊖	142746 ⁶⁷ 143059 ⁵¹	⊖
86-93	All	⊖	142746 ⁶⁷	⊖

7 Pair Packs, Air hose kit included.;

40 Complete Assembled Unit.;

53 Hardware from O.E. Part may need to be reused.;





67 Mount Kit. Hardware from O.E. Part may need to be reused.;

8 Pair Packs.;

51 Strut Cushion for use with the Strut/Cartridge/Shocks.;

61 Mount Kit includes Upper Spring Seat. Hardware from O.E. Part may need to be reused.;



APPLICATION GUIDE

Year	Fitment Notes										
		 Ultra	Ready Mounts	Max Control\ LTV\ ProGuard\ Guardian	Strut Cushion\ Strut Mount\ Dampers\ Stabilizer	HiJackers\ Load Carrier\ Classic	 Ultra	Ready Mounts	Max Control\ LTV\ ProGuard\ Guardian	Strut Cushion\ Strut Mount\ Dampers\ Stabilizer	HiJackers\ Load Carrier\ Classic





FORD

FORD



TAURUS (cont)

86-93	Sedan		143059 ⁵¹
	Wagon		143059 ⁵¹











TAURUS X

09	Left		G57359 ⁴⁰
	Right		G57360 ⁴⁰
08	Left		G57359 ⁴⁰	143415 ⁵³
	Right		G57360 ⁴⁰	143415 ⁵³





TEMPO

86-94	All		143059 ⁵¹
84-85	All		143057 ⁵¹	143059 ⁵¹

THUNDERBIRD

92-97	Exc. Electronic Adjustable Suspension		69845
87-88	Non-ABS		143059 ⁵¹
84-88	Position Rear		14039 ⁸⁵								
80-86	All		143059 ⁵¹
77-79	All		69675 ⁵	81446	34073 ⁸	69606	81495	43140 ⁸ 49205 ⁷
73-76	All		69675 ⁵	81446	34073 ⁸
67-72	All		69675 ⁵	81446	34073 ⁸	69606	81495	43140 ⁸ 49205 ⁷
59-60	All		69625	34073 ⁸ 82099
58	All		69625	34073 ⁸
57	All		69625	34073 ⁸ 82026	81270	49105 ⁷
55-56	All		82026	81270	49105 ⁷

TORINO

74-76	Wagon		81495
72-76	All		69675 ⁵	81446	34073 ⁸	69606	43140 ⁸ 49205 ⁷
68-71	All		82126	69606	49105 ⁷
71	Wagon		81495
68-70	Exc. Wagon		81270



TRANSIT

07-10	All		G64063
-------	-----	---	------	------	------	------	------	--------	------	------	------

5 Use kit No. 140719 to replace O.E. hardware for lower shock absorber mounting when studs break or self-tapping screws are not longer useable;
 8 Pair Packs.;
 51 Strut Cushion for use with the Strut/Cartridge/Shocks.;
 85 Rear Only;

7 Pair Packs, Air hose kit included.;
 40 Complete Assembled Unit.;
 53 Hardware from O.E. Part may need to be reused.;

APPLICATION GUIDE

Year	Fitment Notes										
		Ultra	Ready Mounts	Max Control\ LTV\ ProGuard\ Guardian	Strut Cushion\ Strut Mount\ Dampers\ Stabilizer	HiJackers\ Load Carrier\ Classic	Ultra	Ready Mounts	Max Control\ LTV\ ProGuard\ Guardian	Strut Cushion\ Strut Mount\ Dampers\ Stabilizer	HiJackers\ Load Carrier\ Classic

FORD

FORD

TRANSIT CONNECT

10-13	All		143564 ⁶⁷
-------	-----	--	------	------	------	----------------------	------	--	------	------	------	------

TRANSIT-150

25	All		G64177
23-24	All		G64177
15-22	All		G57816 ⁴⁰	G64177

TRANSIT-250

25	All		G64177
23-24	All		G64177
15-22	All		G57816 ⁴⁰	G64177

TRANSIT-350

25	All		G64177
23-24	All		G64177
15-22	All		G57816 ⁴⁰	G64177

VAN 1/2 TON, ECONOLINE / CLUB WAGON

12-14	All		G63622	58929 61591 77608 81744 ⁴⁸	34076 ⁶		G63623	61646 77623 81828	49178 ⁷
10-11	All		G63622	58929 61591 77608 81744 ⁴⁸	34076 ⁶		G63623	61595 77623 81828	49178 ⁷
08-09	All		G63622	58929 61591 77608 81744 ⁴⁸	34076 ⁶		G63623	61595	49178 ⁷
92-07	All		G63929	58929 61591 77608 81744 ⁴⁸	34076 ⁶		G63624	61595 81833	49178 ⁷
75-91	All			G63350	61518 81242	43099 ⁶ 49173 ⁷
69-74	All		82012		G63377	61519 81484	43058 ⁶ 49127 ⁷
	Single System Steering Stabilizer; with Twin I-Beam Axle										6802SE ⁸⁴		

VAN 3/4 TON, ECONOLINE / CLUB WAGON / SUPERDUTY

03-14	All		G63622	58622 77614 81744 ⁴⁸	34076 ⁶		G63623	61646 77623 81828	49178 ⁷
96-04	Steering Stabilizer										6828SE ⁸⁰		
92-02	All		G63622	58622 61591 77614 81744 ⁴⁸	34076 ⁶		G63623	61646 77623 81828	49178 ⁷
75-91	RWD, 4WD Quad Suspension Rearward of Front Axle		34058 ⁶	
	RWD, 4WD Quad Suspension Rearward of Front Axle, Non Quad Suspension		G63386	61521 ⁶ 81394

6 It is recommended that when replacing shocks on vehicles with "quad shocks" all 4 shocks should be matched by series.;

8 Pair Packs.;

48 Installation Hardware Included;

80 Mounting bracket not required, install on O.E. Shock Mounts. See Ref. C for optional Steering Stabilizer Boots.;



7 Pair Packs, Air hose kit included.;

40 Complete Assembled Unit.;

67 Mount Kit. Hardware from O.E. Part may need to be reused.;

84 Replacement damper for vehicles with the Gabriel Aftermarket mounting kit;

APPLICATION GUIDE

Year	Fitment Notes										
		Ultra	Ready Mounts	Max Control\ LTV\ ProGuard\ Guardian	Strut Cushion\ Strut Mount\ Dampers\ Stabilizer	HiJackers\ Load Carrier\ Classic	Ultra	Ready Mounts	Max Control\ LTV\ ProGuard\ Guardian	Strut Cushion\ Strut Mount\ Dampers\ Stabilizer	HiJackers\ Load Carrier\ Classic

FORD

FORD

VAN 3/4 TON, ECONOLINE / CLUB WAGON / SUPERDUTY (cont)

91	All		O	G63387	49178 ⁷
90	All		O	81394	G63387	49178 ⁷
88-89	All		O	G63387	49178 ⁷
87	All		O	81394	G63387	49178 ⁷
86	All		O	G63387	49178 ⁷
85	All		O	81394	G63387	49178 ⁷
82-84	All		O	G63387	49178 ⁷
79-81	All		O	81394	G63387	49178 ⁷
74-79	QuadraVan Special		O	6803SE ⁸⁴											
75-78	All		O	G63387	49178 ⁷
69-74	All		O	82012	G63377	61519 81484	43058 ⁸ 49127 ⁷
	Single System Steering Stabilizer; with Twin I-Beam Axle		O	6802SE ⁸⁴											

VAN 1 TON, ECONOLINE / CLUB WAGON / SUPERDUTY

21-24	Steering Stabilizer		O	6828SE ⁸⁰												
24	All		O	G63622	
			O
			O	58622 77614 81744 ⁴⁸	61646 77623 81828	49178 ⁷
21-23	All		O	G63622	58622 77614 81744 ⁴⁸	G63623	61646 77623 81828	49178 ⁷	
12-19	All		O	G63622	58622 81744 ⁴⁸	34076 ⁸	G63623	61646	49178 ⁷	
	Exc. Cutaway Chassis		O	77614	77623 81828	
92-19	Steering Stabilizer		O	6828SE ⁸⁰												
09-11	All		O	G63622	61591 81744 ⁴⁸	34076 ⁸	49178 ⁷	
08-11	Exc. Cutaway Chassis		O	58622 77614	G63623	61646 77623 81828	
07-08	Cutaway Chassis		O	58622	
08	All		O	G63622	61591 77614 81744 ⁴⁸	34076 ⁸	77623	49178 ⁷	
07	All		O	61591 77614 81744 ⁴⁸	34076 ⁸	77623	49178 ⁷	
	Exc. Cutaway Chassis		O	G63622	58622 77614	G63623	61646 77623 81828	49178 ⁷	
04-06	Exc. Cutaway Chassis		O	58622	G63623	61646 77623 81828	
06	All		O	G63622	61591 77614 81744 ⁴⁸	34076 ⁸	49178 ⁷	
04-05	All		O	G63622	61591 77614 81744 ⁴⁸	34076 ⁸	61646 81828	49178 ⁷	
92-05	Cutaway Chassis		O	G63622	58622 77614	G63623	77623	

7 Pair Packs, Air hose kit included.;



48 Installation Hardware Included;

84 Replacement damper for vehicles with the Gabriel Aftermarket mounting kit;

8 Pair Packs.;

80 Mounting bracket not required, install on O.E. Shock Mounts. See Ref. C for optional Steering Stabilizer Boots;;





















APPLICATION GUIDE

Year	Fitment Notes										
		Ultra	Ready Mounts	Max Control LTV ProGuard Guardian	Strut Cushion\ Strut Mount\ Dampers\ Stabilizer	HiJackers\ Load Carrier\ Classic	Ultra	Ready Mounts	Max Control LTV ProGuard Guardian	Strut Cushion\ Strut Mount\ Dampers\ Stabilizer	HiJackers\ Load Carrier\ Classic











FORD

FORD





VAN 1 TON, ECONOLINE / CLUB WAGON / SUPERDUTY (cont)

99-03	All		G63622	58622 61591 77614 81744 ⁴⁸	34076 ⁸		G63623	61646 77623 81828	49178 ⁷
92-98	All		61591 81744 ⁴⁸	34076 ⁸		61646 81828	49178 ⁷
77-91	All			49178 ⁷
	RWD, 4WD Quad Suspension Rearward of Front Axle		34058 ⁸	
75-91	Cutaway Chassis			G63387
	Cutaway Chassis RWD, 4WD Quad Suspension Rearward of Front Axle, Non Quad Suspension		G63386	
	Exc. Cutaway Chassis			49178 ⁷
	Exc. Cutaway Chassis RWD, 4WD Quad Suspension Rearward of Front Axle		34058 ⁸	
	Exc. Cutaway Chassis RWD, 4WD Quad Suspension Rearward of Front Axle, Non Quad Suspension		61521 ⁶ 81394	
69-74	All		82012		G63377	61519 81484	43058 ⁸ 49127 ⁷

VICTORIA

60	All		69625	34073 ⁸ 82099		82076
59	All		69625	34073 ⁸ 82099	
57-58	All		69625	34073 ⁸ 82099		81270	49105 ⁷
52-56	All		82026		81270	49105 ⁷
51	All		82026		49310 ⁷ 82156





WINDSTAR

95-03	All		G56935 ⁴⁰	143059 ⁵¹	
	Coil(RearSpringType)			G63676	61625	49233 ⁷





FREIGHTLINER

FREIGHTLINER

SPRINTER 2500

07-18	All		G57802 ⁴⁰	
02-06	All		G56778		G63918



SPRINTER 3500

19-20	All			G64089
07-18	All		G57802 ⁴⁰		G64089

GEO

GEO



METRO

89-97	Non-ABS		143059 ⁵¹		G55772	143057 ⁵¹
-------	---------	---	------	------	------	----------------------	------	---	--------	------	------	----------------------	------

6 It is recommended that when replacing shocks on vehicles with "quad shocks" all 4 shocks should be matched by series.;
8 Pair Packs.;

7 Pair Packs, Air hose kit included.;;
40 Complete Assembled Unit.;;
51 Strut Cushion for use with the Strut/Cartridge/Shocks.;







APPLICATION GUIDE

Year	Fitment Notes										
		Ultra	Ready Mounts	Max Control\ LTV\ ProGuard\ Guardian	Strut Cushion\ Strut Mount\ Dampers\ Stabilizer	HiJackers\ Load Carrier\ Classic	Ultra	Ready Mounts	Max Control\ LTV\ ProGuard\ Guardian	Strut Cushion\ Strut Mount\ Dampers\ Stabilizer	HiJackers\ Load Carrier\ Classic



GEO

GEO



PRIZM

93-97	Left		G55999	143059 ⁵¹ 143281 ⁵³		G55661	G56949 ⁴⁰	143058 ⁵¹
	Right		G55999	143059 ⁵¹ 143281 ⁵³		G55662	G56950 ⁴⁰	143058 ⁵¹
89-92	All		G55591	143059 ⁵¹ 143281 ⁵³		143061 ⁵¹



SPECTRUM

89	All		143058 ⁵¹	
----	-----	---	------	------	------	----------------------	------	---	------	------	------	------	------

STORM

90-93	Non-ABS		143058 ⁵¹		143061 ⁵¹
-------	---------	---	------	------	------	----------------------	------	---	------	------	------	----------------------	------











TRACKER

89-97	All			G63799	61560 81904
-------	-----	---	------	------	------	------	------	---	--------	------	----------------	------	------



GMC

GMC







ACADIA

17	All		G57709 ⁴⁰	
13-16	All		G57709 ⁴⁰		G64040
07-12	All		G52125	143366 ⁵³		G64040
	AWD		G57109 ⁴⁰	
07-11	FWD		G57314 ⁴⁰	



















ACADIA LIMITED

17	All			G64040
----	-----	---	------	------	------	------	------	---	--------	------	------	------	------

C3500HD

01-02	All			61543
91-02	Exc. I Beam Front Axle			43163 ⁵
91-00	Solid Front Axle			61543

CANYON

15-23	All			49235 ⁷
23	Exc. ZR2		G57748 ⁴⁰	
21-22	Exc. ZR2			77953
22	Exc. ZR2 Package			G63866
15-21	Exc. ZR2			G63866
15-20	Exc. ZR2		G57748 ⁴⁰		77953
09-12	Torsion Bar(FrontSpringType)			G63879	43162 ⁵
04-12	RWD		G57282 ⁴⁰	
	RWD, Coil(FrontSpringType) D Standard Suspension; Exc. Z71 Off Road Package			G63882

7 Pair Packs, Air hose kit included.;



40 Complete Assembled Unit.;

53 Hardware from O.E. Part may need to be reused.;

8 Pair Packs.;

51 Strut Cushion for use with the Strut/Cartridge/Shocks.;

APPLICATION GUIDE

Year	Fitment Notes										
		Ultra	Ready Mounts	Max Control LTV ProGuard Guardian	Strut Cushion\ Strut Mount\ Dampers\ Stabilizer	HiJackers\ Load Carrier\ Classic	Ultra	Ready Mounts	Max Control LTV ProGuard Guardian	Strut Cushion\ Strut Mount\ Dampers\ Stabilizer	HiJackers\ Load Carrier\ Classic

GMC

GMC

CANYON (cont)

04-12	RWD, Torsion Bar(FrontSpringType)	77422	...	49213 ⁷
04-11	RWD, Coil(FrontSpringType) Exc. Z71 Off Road Package	G51850
04-08	Torsion Bar(FrontSpringType)	G63884	G63879	43162 ⁸

ENVOY

02-09	All	G51718 ⁴⁵	G57022 ⁴⁰	61717
	Coil(RearSpringType)	G63842	...	77971	...
03-06	Air(RearSpringType)	G64014

ENVOY XL

02-06	All	G51718 ⁴⁵	77971
-------	-----	----------------------	-----	-----	-----	-----	-----	-------	-----	-----

ENVOY XUV

04-05	All	G51718 ⁴⁵	77971
-------	-----	----------------------	-----	-----	-----	-----	-----	-------	-----	-----

JIMMY

05	4WD	G63423	...	58423 ⁵⁰ 61531 77423 81516	G63422	...	61528 77422 81482	...	43162 ⁸ 49213 ⁷
92-04	All	G63422	...	61528 77422 81482	...	43162 ⁸ 49213 ⁷
	4WD	G63423	...	58423 ⁵⁰ 61531 77423 81516
	RWD	G63421	...	58421 61504 81750	...	34051 ⁸
87-91	All	G63349	...	61524 81164
	Exc. Quad Suspension	49155 ⁷
85-91	4WD, Exc. Quad Suspension	61516 81113 ⁸
75-91	4WD	G63347 ⁵⁰
	4WD; Quad Suspension Long Shock	61522 ⁸ 81496 ⁸
73-91	Exc. Lift Kit	43111 ⁸
	Replacement damper for vehicles w/ OE stabilizer	14017
	Heavy Duty replacement damper for vehicles with OE stabilizer	6804SE ⁸⁰									
	Replacement Kit	6802SE ⁸⁴									
73-86	All	G63349	...	61524 81164	...	49155 ⁷
83-84	4WD, Exc. Quad Suspension	81113 ⁸
	4WD, Exc. Quad Suspension and Lift Kit	61516
73-84	RWD	G63355	...	61525 81039	...	34036 ⁸

6 It is recommended that when replacing shocks on vehicles with "quad shocks" all 4 shocks should be matched by series.;

8 Pair Packs.;

45 Strut must be rotated to align notch with lower control arm.;

80 Mounting bracket not required, install on O.E. Shock Mounts. See Ref. C for optional Steering Stabilizer Boots.;



7 Pair Packs, Air hose kit included.;

40 Complete Assembled Unit.;

50 Bellows Kit No.141242 is recommended for use to protect piston rod from potentially harmful road debris.;

84 Replacement damper for vehicles with the Gabriel Aftermarket mounting kit;

APPLICATION GUIDE

Year	Fitment Notes										
		Ultra	Ready Mounts	Max Control/ LTV/ ProGuard/ Guardian	Strut Cushion/ Strut Mount/ Dampers/ Stabilizer	HiJackers/ Load Carrier/ Classic	Ultra	Ready Mounts	Max Control/ LTV/ ProGuard/ Guardian	Strut Cushion/ Strut Mount/ Dampers/ Stabilizer	HiJackers/ Load Carrier/ Classic

GMC

GMC

JIMMY (cont)

82	4WD, Exc. Quad Suspension	OO	61516 81113 ⁶
79-81	4WD, Exc. Quad Suspension	OO	81113 ⁶
	4WD, Exc. Quad Suspension and Lift Kit	OO	61516
78	4WD, Exc. Quad Suspension	OO	61516 81113 ⁶
77	4WD, Exc. Quad Suspension	OO	81113 ⁶
	4WD, Exc. Quad Suspension and Lift Kit	OO	61516
75-76	4WD, Exc. Quad Suspension	OO	61516 81113 ⁶
73-74	4WD; Quad Suspension Long Shock	OO	61522 ⁶
70-74	4WD	OO	G63347 ⁵⁰
	4WD; Exc. Quad Suspension	OO	61516 81113 ⁶
70-72	Coil(RearSpringType)	OO	49107 ⁷
	4WD; K5 Dual System Steering Stabilizer	OO	6802SE ⁸⁴										
	4WD; K5 Single System Steering Stabilizer	OO	6803SE ⁸⁴										
	RWD	OO	G63355	61525 81039	34036 ⁸	OO	G63306

PICKUP

55-59	All	OO	82047	OO
	Series 100, 150	OO	OO	82060
53-59	Single System Steering Stabilizer; with Beam Axle	OO	6802SE ⁸⁴										
53-54	All	OO	81270	OO
	1/2 and 3/4 Ton	OO	OO	43140 ⁸ 49203 ⁷ 82155

PICKUP 1/2 TON, C15 / C1500

88-99	All	OO	G63489	58489 61544 77488 81668	34073 ⁸	OO	G63488	61543 77488 81667	43163 ⁸ 49218 ⁷
73-86	All	OO	G63355	61525 81039	34036 ⁸	OO	G63349	61524 81164	43111 ⁸ 49155 ⁷
	Single System Steering Stabilizer	OO	6802SE ⁸⁴										
68-72	RWD; Leaf(RearSpringType)	OO	OO	G63306
67-72	All	OO	G63355	61525 81039	34036 ⁸	OO
	Coil(RearSpringType)	OO	OO	49107 ⁷ 82003
	Leaf(RearSpringType)	OO	OO	49162 ⁷
67	Leaf(RearSpringType)	OO	OO	G63306

PICKUP 1/2 TON, K15 / K1500

88-99	All	OO	G63818	58901 77609	OO	G63488	61543 77488 81667	43163 ⁸ 49218 ⁷
81-86	Quad Suspension Long Shock	OO	61522 ⁶ 81496 ⁶	OO

6 It is recommended that when replacing shocks on vehicles with "quad shocks" all 4 shocks should be matched by series.;

8 Pair Packs.;

84 Replacement damper for vehicles with the Gabriel Aftermarket mounting kit;

7 Pair Packs, Air hose kit included.;

50 Bellows Kit No.141242 is recommended for use to protect piston rod from potentially harmful road debris.;

APPLICATION GUIDE

Year	Fitment Notes										
		Ultra	Ready Mounts	Max Control\ LTV\ ProGuard\ Guardian	Strut Cushion\ Strut Mount\ Dampers\ Stabilizer	HiJackers\ Load Carrier\ Classic	Ultra	Ready Mounts	Max Control\ LTV\ ProGuard\ Guardian	Strut Cushion\ Strut Mount\ Dampers\ Stabilizer	HiJackers\ Load Carrier\ Classic

GMC

GMC

PICKUP 1/2 TON, K15 / K1500 (cont)

77-86	All		14017		G63349	61524 81164	43111 ⁸
73-86	Exc. Quad Suspension	G63347	61516 81113	G63349	49155 ⁷
	Single System Steering Stabilizer	6804SE ⁸⁰										
69-86	Dual System Steering Stabilizer	6802SE ⁸⁴										
76	All	G63349	14017	G63349	61524 81164
	Exc. Lift Kit	G63349	G63349	43111 ⁸
75	All	G63349	14017	G63349	61524 81164	43111 ⁸
73-74	All	G63349	14017	G63349	61524 81164
69-72	Exc. Quad Suspension	G63347	61516 81113	G63349
	Single System Steering Stabilizer	6803SE ⁸⁴										

PICKUP 1/2 TON, R1500

87	All		G63355	61525 81039	34036 ⁸		G63349	61524 81164	43111 ⁸ 49155 ⁷
	Single System Steering Stabilizer	6802SE ⁸⁴											

PICKUP 1/2 TON, V1500

87	All		14017
	Exc. Lift Kit	G63347	G63349	61524 81164	43111 ⁸
	Quad Suspension Long Shock	G63349	61522 ⁸ 81496 ⁸	G63349
	Quad Suspension Short Shock	G63349	61516 81113 ⁸	G63349
	Quad Suspension; Exc. Lift Kit	G63349	G63349	49155 ⁷
	Dual System Steering Stabilizer	6802SE ⁸⁴										
	Single System Steering Stabilizer	6804SE ⁸⁰										

PICKUP 3/4 TON, C25 / C2500



88-00	All		G63489	58489 61544 77489 81668	34073 ⁸		G63488	61543 77488 81667	43163 ⁸ 49218 ⁷
85-86	Crew Cab Pickup	G63366	G63366	
83-86	All	G63349	81039	G63349	81164	
	Cab & Chassis	G63349	G63349	61524	43111 ⁸ 49155 ⁷	
	Exc. Extended Cab	G63355	61525	34036 ⁸	G63349	
	Standard Cab Pickup	G63349	G63349	61524	43111 ⁸ 49155 ⁷	
67-86	Single System Steering Stabilizer	6802SE ⁸⁴											
73-83	Crew Cab Pickup	G63366	G63366	
79-82	Cab & Chassis	G63349	G63349	61524 81164	43111 ⁸ 49155 ⁷	
	Exc. Extended Cab	G63355	61525 81039	34036 ⁸	G63349	
	Standard Cab Pickup	G63349	G63349	61524 81164	43111 ⁸ 49155 ⁷	
75-78	Cab & Chassis	G63349	G63349	81164	49155 ⁷	

6 It is recommended that when replacing shocks on vehicles with "quad shocks" all 4 shocks should be matched by series.;
8 Pair Packs.;

7 Pair Packs, Air hose kit included.;

80 Mounting bracket not required, install on O.E. Shock Mounts. See Ref. C for optional Steering Stabilizer Boots.;

APPLICATION GUIDE

Year	Fitment Notes										
		Ultra	Ready Mounts	Max Control\ LTV\ ProGuard\ Guardian	Strut Cushion\ Strut Mount\ Dampers\ Stabilizer	HiJackers\ Load Carrier\ Classic	Ultra	Ready Mounts	Max Control\ LTV\ ProGuard\ Guardian	Strut Cushion\ Strut Mount\ Dampers\ Stabilizer	HiJackers\ Load Carrier\ Classic

GMC

GMC

PICKUP 3/4 TON, C25 / C2500 (cont)

75-78	Exc. Extended Cab	○	G63355	61525 81039	34036 ⁸	○	G63349	61524	43111 ⁸
	Standard Cab Pickup	○	○	81164	49155 ⁷
73-74	All	○	G63355	61525 81039	34036 ⁸	○	43111 ⁸ 49155 ⁷
	Exc. Crew Cab & Bonus Cab	○	○	G63349	61524
67-72	Coil(RearSpringType)	○	○	49107 ⁷ 82003
72	All	○	G63355	61525 81039	34036 ⁸	○
	Leaf(RearSpringType)	○	○	G63306	49162 ⁷
71	All	○	G63355	61525 81039	34036 ⁸	○	G63306
	Leaf(RearSpringType)	○	○	49162 ⁷
67-70	All	○	G63355	61525 81039	34036 ⁸	○
	Leaf(RearSpringType)	○	○	G63306	49162 ⁷

PICKUP 3/4 TON, K25 / K2500

99-00	9200# GVW with OE Unit - 15059138 15155638	○	6853SE ⁸²										
88-00	All	○	G63609	58609 61542 77609 81726	○	G63488	61543 77488 81667	43163 ⁸ 49218 ⁷
81-86	Quad Suspension Long Shock; Exc. Lift Kit	○	61522 ⁶ 81496 ⁶	○
73-86	All	○	14017	○
	Exc. Lift Kit	○	○	G63349	61524 81164	43111 ⁸
	Exc. Quad Suspension and Lift Kit	○	G63347	61516 81113 ⁶	○	49155 ⁷
	Single System Steering Stabilizer	○	6804SE ⁸⁰										
67-86	Dual System Steering Stabilizer	○	6802SE ⁸⁴										
69-72	Exc. Quad Suspension and Lift Kit	○	G63347	61516 81113 ⁶	○
67-72	Single System Steering Stabilizer	○	6803SE ⁸⁴										

PICKUP 3/4 TON, R2500

87-89	Crew Cab Pickup	○	○	G63366
	Exc. Crew Cab & Bonus Cab	○	G63355	61525 81039	34036 ⁸	○	G63349	61524 81164	43111 ⁸ 49155 ⁷
	Single System Steering Stabilizer	○	6802SE ⁸⁴										

PICKUP 3/4 TON, V2500

87	All	○	14017	○
	Exc. Lift Kit	○	G63347	○	G63349	61524 81164	43111 ⁸ 49155 ⁷
	Quad Suspension Long Shock; Exc. Lift Kit	○	61522 ⁶ 81496 ⁶	○
	Quad Suspension Short Shock; Exc. Lift Kit	○	61516 81113 ⁶	○
	Single System Steering Stabilizer	○	6804SE ⁸⁰										
	Steering Stabilizer	○	6802SE ⁸⁴										

6 It is recommended that when replacing shocks on vehicles with "quad shocks" all 4 shocks should be matched by series.;

8 Pair Packs.;





82 Use kit if listed, See Ref. C for optional Steering Stabilizer Boots.;

7 Pair Packs, Air hose kit included.;

80 Mounting bracket not required, install on O.E. Shock Mounts. See Ref. C for optional Steering Stabilizer Boots.;

84 Replacement damper for vehicles with the Gabriel Aftermarket mounting kit;

APPLICATION GUIDE

Year	Fitment Notes										
		 Ultra	Ready Mounts	Max Control LTV ProGuard Guardian	Strut Cushion\ Strut Mount\ Dampers\ Stabilizer	HiJackers\ Load Carrier\ Classic	 Ultra	Ready Mounts	Max Control LTV ProGuard Guardian	Strut Cushion\ Strut Mount\ Dampers\ Stabilizer	HiJackers\ Load Carrier\ Classic

GMC

GMC

PICKUP 1 TON, C35/3500

99-00	Exc. HD Straight Front Axle		49218 ⁷
92-00	Exc. HD Straight Front Axle		81668
	Crew Cab Pickup Exc. HD Straight Front Axle		G63489	58489 61544 77489	G63488
91-00	All		77488
	Exc. I Beam Front Axle		61543	43163 ⁸
	Extended Cab Pickup Exc. HD Straight Front Axle		G63489	58489 61544 77489	G63488	81667
	Standard Cab Pickup Exc. HD Straight Front Axle		G63489	58489 61544 77489	G63488	81667
92-98	Cab & Chassis Exc. HD Straight Front Axle		49218 ⁷
88-91	Cab & Chassis		81039
	Cab & Chassis Exc. I Beam Front Axle		61525	34036 ⁸
91	Exc. HD Straight Front Axle		81668	49218 ⁷
	Cab & Chassis Exc. HD Solid Front Axle		G63366
89-90	Extended Cab Pickup Exc. HD Straight Front Axle		G63489	58489 61544 77489	G63488	77488 81667	43163 ⁸
88-90	All	
	Exc. HD Straight Front Axle		81668	61543	49218 ⁷
	Cab & Chassis Exc. HD Solid Front Axle		G63355	G63366
	Standard Cab Pickup Exc. HD Straight Front Axle		G63489	58489 61544 77489	G63488	77488 81667	43163 ⁸
88	Extended Cab Pickup Exc. HD Straight Front Axle		G63489	58489 61544 77489	G63488	77488	43163 ⁸
80-86	All		81039
72-86	Steering Stabilizer		6802SE ⁸⁴								
73-78	All		G63355	61525 81039	34036 ⁸	G63366
67-72	All		G63355	61525 81039	34036 ⁸
	Exc. 11,000# Rear Axle		G63306	49162 ⁷

PICKUP 1 TON, K35 / K3500

88-00	All		G63609	58609 61542 77609 81726	G63488	61543 77488 81667	43163 ⁸ 49218 ⁷
77-86	All		G63411	14017	G63675	61642 77412 81921
73-74	All		14017

PICKUP 1 TON, R3500

87-91	All		G63355	61525 81039	34036 ⁸	G63366
-------	-----	--	--------	------	----------------	------	--------------------	--------	------	------	------

PICKUP 1 TON, V3000 / V3500



87-91	All		G63411	14017	G63675	61642 77412 81921
-------	-----	--	--------	------	------	-------	------	--------	------	-------------------------	------

7 Pair Packs, Air hose kit included.;

8 Pair Packs.;

100 84 Replacement damper for vehicles with the Gabriel Aftermarket mounting kit;

APPLICATION GUIDE

Year	Fitment Notes										
		Ultra	Ready Mounts	Max Control\ LTV\ ProGuard\ Guardian	Strut Cushion\ Strut Mount\ Dampers\ Stabilizer	HiJackers\ Load Carrier\ Classic	Ultra	Ready Mounts	Max Control\ LTV\ ProGuard\ Guardian	Strut Cushion\ Strut Mount\ Dampers\ Stabilizer	HiJackers\ Load Carrier\ Classic

GMC

GMC

PICKUP 1 TON, V3000 / V3500 (cont)

87-88	Quad Suspension Long Shock; Exc. Lift Kit	OO	81496 ⁶
-------	---	----	------	------	--------------------	------	------	------	------	------

PICKUP 1000 SERIES

66	All	OO	G63355	61525 81039		
63-65	All	OO	G63355	61525 81039	34036 ⁸	OO	G63306	49162 ⁷
61-62	All	OO	82035	OO	82086

PICKUP 1500 SERIES

66	All	OO	G63355	61525 81039		
63-65	All	OO	G63355	61525 81039	34036 ⁸	OO	G63306	49162 ⁷
61-62	All	OO	82035	OO	82086

PICKUP 2500 SERIES

66	All	OO	G63355	61525 81039		
61-62	All	OO	82035	OO

S15 JIMMY

83-91	All	OO	OO	G63422	61528 77422 81482	43162 ⁸ 49213 ⁷
	4WD	OO	G63423	58423 61531 77423 81516
	RWD	OO	G63421	58421 61504 81750	34051 ⁸
	Single System Steering Stabilizer; with a factory mounting hole in the steering linkage.	OO	6801SE ⁶⁰										

SAFARI

90-05	All	OO	OO	G63454	61539 77454	49215 ⁷
	AWD	OO	G63818	58609 61542 77609 81726
	RWD	OO	G63375 ⁵	61555 77375 81713 ⁵
85-89	RWD	OO	G63375 ⁵	61555 77375 81713 ⁵	OO	G63454	61539 77454	49215 ⁷

SIERRA 1500

22-24	Exc. Electronic Adaptable Suspension	OO	OO	61690
19-24	Exc. Z45 Adaptable Ride Control (22 Inch Wheels)	OO	OO	G63959	77412	43181 ⁸ 49235 ⁷
19-21	All	OO	OO	61690
08-18	4WD	OO	G57000 ⁴⁰
07-18	RWD, Exc. Electronic Ride Control	OO	G57023 ⁴⁰
18	All	OO	G51949	OO	G63959	61690 77412	43181 ⁸ 49235 ⁷

5 Use kit No. 140719 to replace O.E. hardware for lower shock absorber mounting when studs break or self-tapping screws are not longer useable.;

7 Pair Packs, Air hose kit included.;



40 Complete Assembled Unit.;

6 It is recommended that when replacing shocks on vehicles with "quad shocks" all 4 shocks should be matched by series.;

8 Pair Packs.;

80 Mounting bracket not required, install on O.E. Shock Mounts. See Ref. C for optional Steering Stabilizer Boots.;



















APPLICATION GUIDE

Year	Fitment Notes										
		Ultra	Ready Mounts	Max Control\ LTV\ ProGuard\ Guardian	Strut Cushion\ Strut Mount\ Dampers\ Stabilizer	HiJackers\ Load Carrier\ Classic	Ultra	Ready Mounts	Max Control\ LTV\ ProGuard\ Guardian	Strut Cushion\ Strut Mount\ Dampers\ Stabilizer	HiJackers\ Load Carrier\ Classic







GMC

GMC



SIERRA 1500 (cont)

14-17	All		G51949		G63959	61690 77976	43181 ⁸ 49235 ⁷
08-13	All			G63959	61690 77976	43181 ⁸ 49235 ⁷
	Exc. Classic Models and Electronic Adjustable Suspension		G51870	143316 ⁵³	
99-07	4WD; Classic and Old Body Style; Exc. Electronic Adjustable Suspension		G63803	58803 61643 77803 81922		G63675	61642 77412 81921
	RWD; Classic Models Only; Exc. Electronic Adjustable Suspension		G63783	61641 77783 81920		G63662	61600 77662 81873	43181 ⁸
	RWD; Classic Models Only; Exc. Z55 Auto Ride Suspension			49235 ⁷
07	All			77976	43181 ⁸ 49235 ⁷
	4WD		G57000 ⁴⁰		49235 ⁷
	Exc. Classic Models and Electronic Adjustable Suspension		G51870	143316 ⁵³		G63959	61690
99-05	Exc. OE Unit		6853SE ⁸⁶										



SIERRA 1500 HD

05-06	All		G63817	58817 61663 77817 81925		G63675	61642 77412 81921
06	4WD, Torsion Bar(FrontSpringType)		61663	
01-03	All		G63817	58817 61663 77817 81925		G63675	61642 77412 81921







SIERRA 1500 HD CLASSIC

07	All		G63817	58817 61663 77817 81925		G63675	61642 77412 81921
----	-----	---	--------	------	----------------------------------	------	------	---	--------	------	-------------------------	------	------







SIERRA 1500 LIMITED

19	All			77412	49235 ⁷
----	-----	---	------	------	------	------	------	---	------	------	-------	------	--------------------

SIERRA 2500

99-04	All		58817		G63675	61642 77412 81921
	4WD		G63817	61663 77817 81925	
	4WD; Up through 8600# GVW; Exc. OE Steering Stabilizer		6853SE ⁸²										
	RWD, Exc. Electronic Adjustable Suspension		G63783	61641 77783 81920	

SIERRA 2500 HD

11-24	All		G64148		G64121	77976	43181 ⁸
01-10	All		58817		G63675	61642 77412 81921
	4WD		G63817	61663 77817	
01-09	9200# GVW with OE Unit - 15059138 15155638		6853SE ⁸²										

7 Pair Packs, Air hose kit included.;

40 Complete Assembled Unit.;



102 82 Use kit if listed, See Ref. C for optional Steering Stabilizer Boots.;

8 Pair Packs.;

53 Hardware from O.E. Part may need to be reused.;

86 Exc. OE Unit.;

APPLICATION GUIDE

Year	Fitment Notes										
		Ultra	Ready Mounts	Max Control\ LTV\ ProGuard\ Guardian	Strut Cushion\ Strut Mount\ Dampers\ Stabilizer	HiJackers\ Load Carrier\ Classic	Ultra	Ready Mounts	Max Control\ LTV\ ProGuard\ Guardian	Strut Cushion\ Strut Mount\ Dampers\ Stabilizer	HiJackers\ Load Carrier\ Classic

GMC

GMC

SIERRA 2500 HD (cont)

01-04	RWD		G63783	61641 77783 81920
-------	-----	---	--------	------	-------------------------	------	------	------	------	------

SIERRA 2500 HD CLASSIC

07	4WD		77412
----	-----	---	------	------	------	------	------	-------	------	------



SIERRA 3500

01-06	All		G63817	58817 61663 77817	G63675	61642 77412 81921
-------	-----	---	--------	------	-------------------------	------	------	--------	------	-------------------------	------	------





SIERRA 3500 CLASSIC

07	All		58817 61663	61642 77412
----	-----	---	------	------	----------------	------	------	------	------	----------------	------	------





SIERRA 3500 HD

11-24	All		G64148	G64121	77976	43181 ⁸
07-10	All		G63675	61642 77412 81921
	Torsion Bar(FrontSpringType)		G63817	58817 61663 77817





SONOMA / S15 2WD

82-04	All		G63422	61528 77422 81482	43162 ⁸ 49213 ⁷
	RWD		G63421	58421 61504 81750	34051 ⁸
91-93	Single System Steering Stabilizer; with a factory mounting hole in the steering linkage.		6801SE ⁸⁰	6801SE ⁸⁰	6801SE ⁸⁰	6801SE ⁸⁰	6801SE ⁸⁰	6801SE ⁸⁰	6801SE ⁸⁰	6801SE ⁸⁰	6801SE ⁸⁰	6801SE ⁸⁰
82-93	Single System Steering Stabilizer		6802SE ⁸⁴									
82-90	RWD; Single System Steering Stabilizer; with a factory mounting hole in the steering linkage.		6801SE ⁸⁰									

SONOMA / S15 4WD

83-04	4WD		G63423	58423 61531 77423 81516
82-04	All		G63422	61528 77422 81482	43162 ⁸ 49213 ⁷
04	RWD		G63421	58421 61504 81750	34051 ⁸
91-93	Single System Steering Stabilizer; with a factory mounting hole in the steering linkage.		6801SE ⁸⁰									
82	RWD		34051 ⁸

SPRINT / CABALLERO

78-87	All		61504	34051 ⁸
	RWD		G63421	58421 81750	81492	43060 ⁸ 49334 ³⁰
71-77	All		G63421	58421 61504 81750	81492	43060 ⁸ 49152 ³⁰
	RWD		34051 ⁸

7 Pair Packs, Air hose kit included.;





30 For GM Vehicles equipped with factory installed leveling systems, see Ref A.;

84 Replacement damper for vehicles with the Gabriel Aftermarket mounting kit;

8 Pair Packs.;

80 Mounting bracket not required, install on O.E. Shock Mounts. See Ref. C for optional Steering Stabilizer Boots;;



















APPLICATION GUIDE

Year	Fitment Notes										
		 Ultra	Ready Mounts	Max Control\ LTV\ ProGuard\ Guardian	Strut Cushion\ Strut Mount\ Dampers\ Stabilizer	HiJackers\ Load Carrier\ Classic	 Ultra	Ready Mounts	Max Control\ LTV\ ProGuard\ Guardian	Strut Cushion\ Strut Mount\ Dampers\ Stabilizer	HiJackers\ Load Carrier\ Classic













GMC

GMC



SUBURBAN 1/2 TON, C15 / C1500

93-99	All	 G63489	58489 61544 77489 81668	34073 ⁸	 G63896	61565 77638	43180 ⁸ 49231 ⁷
92	All	 G63489	58489 61544 77489 81668	34073 ⁸		61565 77638	43180 ⁸ 49231 ⁷
	Old Body Style		 G63896
75-86	All	 G63355	61525 81039	34036 ⁸	 G63349	61524 81164	43111 ⁸ 49155 ⁷
68-86	Single System Steering Stabilizer		6802SE ⁸⁴								
73-74	All	 G63355	81039	34036 ⁸	 G63349	61524 81164	43111 ⁸ 49155 ⁷
	Coil (FrontSpringType)		61525	
68-72	All	 G63355	34036 ⁸	
	Coil (FrontSpringType)		61525 81039	
	Coil(RearSpringType)			49107 ⁷ 82003











SUBURBAN 1/2 TON, K15 / K1500

92-99	All	 G63609	58609 ⁵⁰ 61542 77609 81726	 G63638	61565 77638	43180 ⁸ 49231 ⁷
81-86	Quad Suspension Long Shock		61522 ⁵ 81496 ⁸	
73-86	All		14017	 G63349	61524 81164	43111 ⁸
	Exc. Quad Suspension	 G63347	61516 81113		49155 ⁷
	Single System Steering Stabilizer		6804SE ⁸⁰								
68-86	Dual System Steering Stabilizer		6802SE ⁸⁴								
69-72	Exc. Quad Suspension	 G63347	61516 81113	
68-72	Single System Steering Stabilizer		6803SE ⁸⁴								

SUBURBAN 1/2 TON, R1500

87-91	All	 G63355	61525 81039	34036 ⁸	 G63349	61524 81164	43111 ⁸ 49155 ⁷
	Single System Steering Stabilizer		6802SE ⁸⁴								

SUBURBAN 1/2 TON, V1500

87-91	All		14017		
	Exc. Lift Kit	 G63347	 G63349	61524 81164	43111 ⁸ 49155 ⁷	
	Quad Suspension Long Shock		61522 ⁵ 81496 ⁸	
	Quad Suspension Short Shock		61516 81113 ⁸	
	Dual System Steering Stabilizer		6802SE ⁸⁴									
	Single System Steering Stabilizer		6804SE ⁸⁰									

6 It is recommended that when replacing shocks on vehicles with "quad shocks" all 4 shocks should be matched by series;
8 Pair Packs.;



80 Mounting bracket not required, install on O.E. Shock Mounts. See Ref. C for optional Steering Stabilizer Boots.;

7 Pair Packs, Air hose kit included.;

50 Bellows Kit No.141242 is recommended for use to protect piston rod from potentially harmful road debris.;

84 Replacement damper for vehicles with the Gabriel Aftermarket mounting kit;

APPLICATION GUIDE

Year	Fitment Notes										
		Ultra	Ready Mounts	Max Control\ LTV\ ProGuard\ Guardian	Strut Cushion\ Strut Mount\ Dampers\ Stabilizer	HiJackers\ Load Carrier\ Classic	Ultra	Ready Mounts	Max Control\ LTV\ ProGuard\ Guardian	Strut Cushion\ Strut Mount\ Dampers\ Stabilizer	HiJackers\ Load Carrier\ Classic

GMC

GMC

SUBURBAN 3/4 TON, C25 / C2500

92-99	All	G63489	58489 61544 77489 81668	34073 ⁸	G63896	61565 77638	43180 ⁹ 49231 ⁷
75-86	All	G63355	61525 81039	34036 ⁸	G63349	61524 81164	43111 ⁹ 49155 ⁷
68-86	Single System Steering Stabilizer	6802SE ⁸⁴									
73-74	All	G63355	61525 81039	34036 ⁸	43111 ⁹ 49155 ⁷
	Exc. Crew Cab & Bonus Cab	G63349	61524 81164
68-72	All	G63355	61525 81039	34036 ⁸	49107 ⁷ 82003

SUBURBAN 3/4 TON, K25 / K2500

92-99	All	G63609	58609 61542 77609 81726	G63638	61565 77638	43180 ⁹ 49231 ⁷
81-86	Quad Suspension Long Shock; Exc. Lift Kit	61522 ⁶ 81496 ⁶
73-86	All	14017
	Exc. Lift Kit	G63349	61524 81164	43111 ⁹
	Exc. Quad Suspension and Lift Kit	G63347	61516 81113 ⁶	49155 ⁷
	Single System Steering Stabilizer	6804SE ⁸⁰									
68-86	Dual System Steering Stabilizer	6802SE ⁸⁴									
69-72	Exc. Quad Suspension and Lift Kit	G63347	61516 81113 ⁶
68-72	Single System Steering Stabilizer	6803SE ⁸⁴									

SUBURBAN 3/4 TON, R2500

87-91	All	G63355	61525 81039	34036 ⁸	G63349	61524 81164	43111 ⁹ 49155 ⁷
	Single System Steering Stabilizer	6802SE ⁸⁴									

SUBURBAN 3/4 TON, V2500

87-91	All	14017
	Exc. Lift Kit	G63347	G63349	61524 81164	43111 ⁹ 49155 ⁷
	Quad Suspension Long Shock; Exc. Lift Kit	61522 ⁶ 81496 ⁶
	Quad Suspension Short Shock; Exc. Lift Kit	61516 81113 ⁶
	Dual System Steering Stabilizer	6802SE ⁸⁴									
	Single System Steering Stabilizer	6804SE ⁸⁰									

SYCLONE

91	All	G63423	58423 61531 77423 81516	G63422	61528 77422 81482	43162 ⁹ 49213 ⁷
	Single System Steering Stabilizer; with a factory mounting hole in the steering linkage.	6801SE ⁸⁰									

TERRAIN

14-17	All	G64140
-------	-----	------	------	------	------	------	--------	------	------	------	------

6 It is recommended that when replacing shocks on vehicles with "quad shocks" all 4 shocks should be matched by series.;



8 Pair Packs.;

84 Replacement damper for vehicles with the Gabriel Aftermarket mounting kit;

7 Pair Packs, Air hose kit included.;

80 Mounting bracket not required, install on O.E. Shock Mounts. See Ref. C for optional Steering Stabilizer Boots.;







APPLICATION GUIDE

Year	Fitment Notes										
		Ultra	Ready Mounts	Max Control\ LTV\ ProGuard\ Guardian	Strut Cushion\ Strut Mount\ Dampers\ Stabilizer	HiJackers\ Load Carrier\ Classic	Ultra	Ready Mounts	Max Control\ LTV\ ProGuard\ Guardian	Strut Cushion\ Strut Mount\ Dampers\ Stabilizer	HiJackers\ Load Carrier\ Classic

GMC

GMC

TERRAIN (cont)

10-16	Left		G52127		
	Left Exc. Models w/ 19" Wheels		G57197 ⁴⁰		
	Right		G52128		
	Right Exc. Models w/ 19" Wheels		G57198 ⁴⁰		
10-13	All		G64015	61718
10-12	Left Models w/ 19" Wheels		G57322 ⁴⁰	
	Right Models w/ 19" Wheels		G57323 ⁴⁰	

















TRACKER

89-91	All		81904
-------	-----	---	------	------	------	------	------	------	------	-------	------	------



TYPHOON

92-93	All		G63423	58423 61531 77423 81516	G63422	61528 77422 81482	43162 ⁸ 49213 ⁷
-------	-----	---	--------	------	----------------------------------	------	------	------	--------	------	-------------------------	------	--

VAN 1/2 TON, G / SAVANA

12-14	AWD, Torsion Bar(FrontSpringType)		G63893	61683	
03-14	All		G63896	43180 ⁶ 49231 ⁷
	RWD		77638
	RWD, Coil(FrontSpringType)		G63894	61684
03-11	Exc. Upfitter Package and Cutaway Chassis		61565
	Torsion Bar (FrontSpringType)		G63893	61683
96-02	All		61555	G63896	61565	43180 ⁶ 49231 ⁷
	Exc. 8600# GVW		34073 ⁸
	RWD		G63375 ⁵	77375 81713 ⁵	77638
78-95	All		G63357	58357 61517	G63413	61522 81496	49212 ⁷
70-95	Single System Steering Stabilizer		6802SE ⁶⁴										
71-77	All		G63357	58357 61517	G63306	49162 ⁷
70	All		58357	G63306	49162 ⁷
	Independent Front Suspension		G63357	61517
67-69	All		G63306	49162 ⁷
64-66	All		82003

VAN 1/2 TON, P SERIES

74-80	All		G63355	61525 81039	34036 ⁸	G63366	77662
73	All		G63355	61525 81039	34036 ⁸	G63349	61524 81164	43111 ⁸ 49155 ⁷
68-72	All		G63355	61525 81039	34036 ⁸	82003



5 Use kit No. 140719 to replace O.E. hardware for lower shock absorber mounting when studs break or self-tapping screws are not longer useable.;

8 Pair Packs.;

7 Pair Packs, Air hose kit included.;

40 Complete Assembled Unit.;

APPLICATION GUIDE

Year	Fitment Notes										
		Ultra	Ready Mounts	Max Control\ LTV\ ProGuard\ Guardian	Strut Cushion\ Strut Mount\ Dampers\ Stabilizer	HiJackers\ Load Carrier\ Classic	Ultra	Ready Mounts	Max Control\ LTV\ ProGuard\ Guardian	Strut Cushion\ Strut Mount\ Dampers\ Stabilizer	HiJackers\ Load Carrier\ Classic

GMC

GMC

VAN 1/2 TON, P SERIES (cont)

68-72	Coil(RearSpringType)		49107 ⁷	
67	All		G63355	61525 81039	34036 ⁸		G63306	49162 ⁷

VAN 3/4 TON, G / SAVANA

25	All		61687	
24	All		G63895	61685		G63897	77638
17-23	All		G63895	61685		G63897	61687 77638	43180 ⁸
10-16	All		61685		G63897	61687 77638	43180 ⁸
03-16	Coil(FrontSpringType)		G63895
03-12	Torsion Bar (FrontSpringType)		G63893	61683
03-09	All			G63897	61687 77638	43180 ⁸
96-02	Exc. 8600# GVW		G63375 ⁵	61555 77375 81713 ⁵	34073 ⁸		G63638	61565 77638	43180 ⁸ 49231 ⁷
78-95	Exc. 8600# GVW		G63357	58357 61517		G63413	61522 81496	49212 ⁷
70-95	Single System Steering Stabilizer		6802SE ⁸⁴										
71-77	All		G63357	58357 61517		G63306	49162 ⁷
67-70	All			G63306	49162 ⁷
70	Independent Front Suspension		G63357	58357 61517

VAN 3/4 TON, P SERIES

79-89	All		G63355	61525 81039	34036 ⁸		G63366
73-78	All		G63355	61525 81039	34036 ⁸		G63349	61524 81164	43111 ⁸ 49155 ⁷
68-72	All		G63355	61525 81039	34036 ⁸		G63306	49162 ⁷
67	All		82047	

VAN 1 TON, G / SAVANA

25	All		61687
24	All		G63895	61685		G63897	77638
17-23	All		G63895	61685		G63897	61687 77638	43180 ⁸
13-16	All		61685		G63897	61687 77638	43180 ⁸
03-16	Coil(FrontSpringType)		G63895
10-12	All		61685	77638	43180 ⁸
03-12	Single Rear Wheels			G63897	61687
	Torsion Bar (FrontSpringType)		G63893
04-09	All		77638	43180 ⁸
03	All		43180 ⁸
97-02	All		G63375 ⁵	61555 77375 81713 ⁵	43180 ⁸ 49231 ⁷
96-02	Exc. 8600# GVW		34073 ⁸		G63638	61565 77638

5 Use kit No. 140719 to replace O.E. hardware for lower shock absorber mounting when studs break or self-tapping screws are not longer useable;
8 Pair Packs.;

7 Pair Packs, Air hose kit included.;

84 Replacement damper for vehicles with the Gabriel Aftermarket mounting kit;

APPLICATION GUIDE

Year	Fitment Notes										
		Ultra	Ready Mounts	Max Control/ LTV/ ProGuard/ Guardian	Strut Cushion/ Strut Mount/ Dampers/ Stabilizer	HiJackers/ Load Carrier/ Classic	Ultra	Ready Mounts	Max Control/ LTV/ ProGuard/ Guardian	Strut Cushion/ Strut Mount/ Dampers/ Stabilizer	HiJackers/ Load Carrier/ Classic

GMC

GMC

VAN 1 TON, G / SAVANA (cont)

92-96	Cutaway Van	G63375 ⁵	G63671	
96	All	G63375 ⁵	58357	61555	43180 ⁶	
	7100, 7400 and 8600# GVW		77375	81713 ⁵	77638	49231 ⁷
	Cutaway Van 9200# GVW	
	Exc. Cutaway Van		61522 ⁸	81496
94-95	Single System Steering Stabilizer; HD with Straight Front Axle & Tilt Hood	6804SE ⁸⁰											
93-95	Cutaway Van 9200# GVW	G63403	77403	
79-95	Exc. Cutaway Van	G63413	61522 ⁸	81496	49212 ⁷
78-95	All	G63357	58357	61517	
71-95	Single System Steering Stabilizer	6802SE ⁸⁴											
92	Cutaway Van 9200# GVW	77403	
79-91	Cutaway Van 9200# GVW	G63403	77403	
78	Cutaway Van	G63413	61522 ⁸	81496	49212 ⁷
76-77	All	G63357	58357	61517	G63306	49162 ⁷	
	110.0 / 279.4(WheelBase)	58357	61517	G63306	49162 ⁷	
	125.0 / 317.5(WheelBase)	58357	61517	G63306	49162 ⁷	
71-74	All	G63357	58357	61517	G63306	
	Exc. 146" Wheelbase	49162 ⁷	

VAN 1 TON, P SERIES

86-99	Motorhome Chassis w/ I-Beam Front Suspension	G63625
85-99	Motorhome Chassis w/ Independent Front Suspension	G63394
75-99	All	G63366	77662
75-90	Cutaway Chassis	G63355	61525	81039	34036 ⁸
85	Motorhome Chassis w/ I-Beam Front Suspension	G63403	58403	77403
75-84	Motorhome Chassis	G63394
73-74	All	G63366
74	Cutaway Chassis	34036 ⁸
	Base, Cutaway Chassis	G63355	61525	81039	77662
	Motorhome	G63394	77662
73	Base, Cutaway Chassis	G63355	61525	81039	34036 ⁸	77662
68-72	All	G63355	61525	81039	34036 ⁸
	Exc. 11,000# Rear Axle	G63306	49162 ⁷

5 Use kit No. 140719 to replace O.E. hardware for lower shock absorber mounting when studs break or self-tapping screws are not longer useable.;

7 Pair Packs, Air hose kit included.;

80 Mounting bracket not required, install on O.E. Shock Mounts. See Ref. C for

6 It is recommended that when replacing shocks on vehicles with "quad shocks" all 4 shocks should be matched by series.;

8 Pair Packs.;

84 Replacement damper for vehicles with the Gabriel Aftermarket mounting kit;

APPLICATION GUIDE

Year	Fitment Notes										
		Ultra	Ready Mounts	Max Control/ LTV/ ProGuard/ Guardian	Strut Cushion/ Strut Mount/ Dampers/ Stabilizer	HiJackers/ Load Carrier/ Classic	Ultra	Ready Mounts	Max Control/ LTV/ ProGuard/ Guardian	Strut Cushion/ Strut Mount/ Dampers/ Stabilizer	HiJackers/ Load Carrier/ Classic

GMC

GMC

VAN 1 TON, P SERIES (cont)

67	All	G63355	82047	G63306
----	-----	--------	------	------	------	------	-------	--------	------	------	------	------

VAN, PB 1000 SERIES

63-65	All	G63355	61525 81039	34036 ⁸	G63306	49162 ⁷
-------	-----	--------	------	----------------	------	------	--------------------	--------	------	------	------	--------------------

YUKON

15-20	Old Body Style	G51949	G64101
	4WD, Old Body Style	G57023 ⁴⁰
12-20	All	77975	43181 ⁸
	4WD	49235 ⁷
12-14	Exc. Z55 or ZW7 Ride Suspension	G51891	G57125 ⁴⁰
	Old Body Style	G64101
07-14	Exc. Electronic Adjustable Suspension	143316 ⁵³
07-11	Exc. Z55 or ZW7 Ride Suspension	G51891	G57125 ⁴⁰	G63866	61675 77953 81930
00-11	4WD, Exc. Z55 Auto Ride Suspension	49235 ⁷
	RWD	49155 ⁷
00-06	Exc. Z55 Auto Ride Suspension	G63803	58803 61643 77803 81922	G63866	61675 77953 81930
99-05	Steering Stabilizer	6853SE ⁸²										
00	Denali	G63896
92-99	All	G63896	61565 77638	43180 ⁸ 49231 ⁷
	4WD	G63609	58901 61542 77609 81726
	RWD	G63489	58489 61544 77489 81668	34073 ⁸

YUKON XL

19-20	4WD	49235 ⁷
	4WD, Old Body Style	G57023 ⁴⁰
15-20	All	77975	43181 ⁸
	Old Body Style	G51949	G64101
15-18	4WD	G57023 ⁴⁰	49235 ⁷

YUKON XL 1/2 TON

12-14	All	G64101	43181 ⁸
	Exc. Z55 Auto Ride Suspension	143316 ⁵³
	Exc. Z55 or ZW7 Ride Suspension	G51891	G57125 ⁴⁰

7 Pair Packs, Air hose kit included.;



40 Complete Assembled Unit.;

82 Use kit if listed, See Ref. C for optional Steering Stabilizer Boots.;

8 Pair Packs.;

53 Hardware from O.E. Part may need to be reused.;

APPLICATION GUIDE

Year	Fitment Notes										
		Ultra	Ready Mounts	Max Control LTV ProGuard Guardian	Strut Cushion\ Strut Mount\ Dampers\ Stabilizer	Hijackers\ Load Carrier\ Classic	Ultra	Ready Mounts	Max Control LTV ProGuard Guardian	Strut Cushion\ Strut Mount\ Dampers\ Stabilizer	Hijackers\ Load Carrier\ Classic

GMC

GMC

YUKON XL 1/2 TON (cont)

12-14	4WD											49235 ⁷
07-11	Exc. Z55 Auto Ride Suspension				143316 ⁵³		G63866					
	Exc. Z55 or ZW7 Ride Suspension	G51891	G57125 ⁴⁰						61675 77953 81930			
00-11	4WD, Exc. Z55 Auto Ride Suspension											49235 ⁷
	RWD											49155 ⁷
00-06	Exc. Z55 Auto Ride Suspension	G63803		58803 61643 77803 81922			G63866		61675 77953 81930			

YUKON XL 3/4 TON

00-13	Exc. Z55 Auto Ride Suspension			81922								
00-11	Exc. Z55 Auto Ride Suspension and Quadrasteer						G63866		61675 77953 81930			
	4WD, Exc. Z55 Auto Ride Suspension											49235 ⁷
	RWD											49155 ⁷
00-06	Exc. Hydraulic Self-Leveling System	G63817		58817 61663 77817 81925								

HONDA

HONDA

ACCORD

15-17	All						G51892					
13-14	Coupe						G511003					
	Sedan						G51892					
08-12	Left	G51877					G51892	G57419 ⁴⁰				
	Right	G51878					G51892	G57419 ⁴⁰				
	Automatic Left		G57207 ⁴⁰									
	Automatic Right		G57208 ⁴⁰									
	Manual Left		G57417 ⁴⁰									
	Manual Right		G57418 ⁴⁰									
03-12	Exc. Hybrid				142230 ⁵³						142230 ⁵³	
03-07	Exc. Hybrid Models Left		G57054 ⁴⁰				G51738	G57056 ⁴⁰				
	Exc. Hybrid Models Right		G57055 ⁴⁰				G51738	G57056 ⁴⁰				
98-02	Left		G56991 ⁴⁰		142230 ⁵³ 143064 ⁵¹			G56943 ⁴⁰	M55871	142230 ⁵³ 143063 ⁵¹		
	Right		G56992 ⁴⁰		142230 ⁵³ 143064 ⁵¹			G56943 ⁴⁰	M55871	142230 ⁵³ 143063 ⁵¹		
94-97	All			M55877	142230 ⁵³ 143064 ⁵¹				M55786	143063 ⁵¹		



7 Pair Packs, Air hose kit included.;

110 51 Strut Cushion for use with the Strut/Cartridge/Shocks.;

40 Complete Assembled Unit.;

53 Hardware from O.E. Part may need to be reused.;

APPLICATION GUIDE

Year	Fitment Notes										
		Ultra	Ready Mounts	Max Control\ LTV\ ProGuard\ Guardian	Strut Cushion\ Strut Mount\ Dampers\ Stabilizer	HiJackers\ Load Carrier\ Classic	Ultra	Ready Mounts	Max Control\ LTV\ ProGuard\ Guardian	Strut Cushion\ Strut Mount\ Dampers\ Stabilizer	HiJackers\ Load Carrier\ Classic

HONDA

HONDA

ACCORD (cont)

90-93	All	G55774	142230 ⁵³ 143064 ⁵¹	M55786	143063 ⁵¹
86-89	All	142230 ⁵³	143064 ⁵¹
82-85	All	142850 ⁵⁴	143059 ⁵¹
76-81	All	143059 ⁵¹

CITY

10-12	Left	G52152	G51905
	Right	G52153	G51905

CIVIC

14-15	All	G511092
12-15	Sedan Left w/ 14mm Lower Mounting Holes	G57712 ⁴⁷
	Sedan Right w/ 14mm Lower Mounting Holes	G57713 ⁴⁷
12-13	All	G511092	143530 ⁶⁷
06-11	All	G51807	143498 ⁶⁸
	Exc. GX & SI Models Left	G57390 ⁴⁰
	Exc. GX & SI Models Right	G57391 ⁴⁰
03-05	Left	G57061 ⁴⁰	142230 ⁵³
	Right	G57062 ⁴⁰	142230 ⁵³
	Exc. Hybrid Models Left	G57049 ⁴⁰	G51716
	Exc. Hybrid Models Right	G57050 ⁴⁰	G51716
	Hybrid, Left	G56621	G57521 ⁴⁰
	Hybrid, Right	G56622	G57522 ⁴⁰	M56622
01-05	Base & Type S Models	143353 ⁵⁴
01-02	Exc. Hybrid Models Left	G57049 ⁴⁰
	Exc. Hybrid Models Right	G57050 ⁴⁰
02	Left	G51700	G57032 ⁴⁰	142230 ⁵³
	Right	G51700	G57033 ⁴⁰	142230 ⁵³
	Exc. Hatchback Left	G56621
	Exc. Hatchback Right	G56622	M56622

40 Complete Assembled Unit.;

51 Strut Cushion for use with the Strut/Cartridge/Shocks.;

54 Kit with Mount and Bearing. Hardware from O.E. Part may need to be reused.;



68 Mount Kit. Hardware from O.E. Part may need to be reused.;

47 w/ 14mm Lower Mounting Holes;

53 Hardware from O.E. Part may need to be reused.;

67 Mount Kit. Hardware from O.E. Part may need to be reused.;



















APPLICATION GUIDE

Year	Fitment Notes										
		Ultra	Ready Mounts	Max Control LTV ProGuard Guardian	Strut Cushion\ Strut Mount\ Dampers\ Stabilizer	HiJackers\ Load Carrier\ Classic	Ultra	Ready Mounts	Max Control LTV ProGuard Guardian	Strut Cushion\ Strut Mount\ Dampers\ Stabilizer	HiJackers\ Load Carrier\ Classic



HONDA

HONDA

































CIVIC (cont)

01	Left		G56621		G51700	G57032 ⁴⁰	142230 ⁵³
	Right		G56622	M56622		G51700	G57033 ⁴⁰	142230 ⁵³
96-00	Left		G56996 ⁴⁰	142230 ⁵³		G55910	G56998 ⁴⁰	142230 ⁵³ 143064 ⁵¹
	Right		G56997 ⁴⁰	142230 ⁵³		G55910	G56998 ⁴⁰	142230 ⁵³ 143064 ⁵¹
92-95	Left		G56993 ⁴⁰	M55802 ⁴⁶	142230 ⁵³		G56995 ⁴⁰	142230 ⁵³ 143064 ⁵¹
	Right		G56994 ⁴⁰	M55802 ⁴⁶	142230 ⁵³		G56995 ⁴⁰	142230 ⁵³ 143064 ⁵¹
89-91	All		142230 ⁵³		142230 ⁵³ 143064 ⁵¹
88	All		142230 ⁵³		142230 ⁵³
85-87	4WD, Wagon		143057 ⁵¹	

CIVIC DEL SOL

93-97	All		M55802 ⁴⁶	142230 ⁵³		142230 ⁵³ 143064 ⁵¹
-------	-----	---	------	------	----------------------	----------------------	------	---	------	------	------	--	------

CR-V

15-16	AWD, Left			G51972	G57792 ⁴⁰
	AWD, Right			G51972	G57793 ⁴⁰
12-16	FWD, Left		G57479 ⁴⁰		G57597 ⁴⁰
	FWD, Right		G57480 ⁴⁰		G57598 ⁴⁰
13-14	Left		G52187		G51972
	Right		G52188		G51972
12	Left		G52187		G51972	142230 ⁵³
	Right		G52188		G51972	142230 ⁵³
07-11	Left		G52187	G57331 ⁴⁰		G51879	G57416 ⁴⁰	142230 ⁵³
	Right		G52188	G57332 ⁴⁰		G51879	G57682 ⁴⁰	142230 ⁵³
03-06	Left		G56800		G57086 ⁴⁰	142230 ⁵³
	Right		G56799		G57087 ⁴⁰	142230 ⁵³
02-06	Automatic Left		G57084 ⁴⁰	
	Automatic Right		G57085 ⁴⁰	
	Base & Type S Models		143353 ⁵⁴	
02	Left		G56800		G57086 ⁴⁰



40 Complete Assembled Unit.;

51 Strut Cushion for use with the Strut/Cartridge/Shocks.;

46 Upper Mount orientation may be required.;

53 Hardware from O.E. Part may need to be reused.;

APPLICATION GUIDE

Year	Fitment Notes										
		Ultra	Ready Mounts	Max Control\ LTV\ ProGuard\ Guardian	Strut Cushion\ Strut Mount\ Dampers\ Stabilizer	HiJackers\ Load Carrier\ Classic	Ultra	Ready Mounts	Max Control\ LTV\ ProGuard\ Guardian	Strut Cushion\ Strut Mount\ Dampers\ Stabilizer	HiJackers\ Load Carrier\ Classic

HONDA

HONDA

CR-V (cont)

02	Right	G56799	G57087 ⁴⁰
97-01	All	142230 ⁵³ 143064 ⁵¹	142230 ⁵³ 143064 ⁵¹

CR-Z

11-16	All	G511037
-------	-----	------	------	------	------	------	------	---------	------	------	------

CRX

89-91	All	142230 ⁵³ 143064 ⁵¹	142230 ⁵³
88	All	142230 ⁵³	142230 ⁵³ 143064 ⁵¹

ELEMENT

03-11	Exc. SC Model Left	G52112
	Exc. SC Model Right	G52113
11	Left	G57222 ⁴⁰	G51858	G57424 ⁴⁰	142230 ⁵³
	Right	G57223 ⁴⁰	G51858	G57425 ⁴⁰	142230 ⁵³
07-10	All	G51858	142230 ⁵³
	Exc. SC Submodel Left	G57222 ⁴⁰	G57424 ⁴⁰
	Exc. SC Submodel Right	G57223 ⁴⁰	G57425 ⁴⁰
03-06	Left	G57222 ⁴⁰	G51858	G57424 ⁴⁰	142230 ⁵³
	Right	G57223 ⁴⁰	G51858	G57425 ⁴⁰	142230 ⁵³
	Base & Type S Models	143353 ⁵⁴

FIT

15-16	Exc. EV Left	G52152
	Exc. EV Right	G52153
09-14	Exc. EV Left	G52152	G51905
	Exc. EV Right	G52153	G51905
09-13	Left	G57603 ⁴⁰
	Right	G57604 ⁴⁰
07-08	CAN Left	G52282
	CAN Right	G52283
	USA Left	G52282
	USA Right	G52283



40 Complete Assembled Unit.;

53 Hardware from O.E. Part may need to be reused.;

51 Strut Cushion for use with the Strut/Cartridge/Shocks.;

54 Kit with Mount and Bearing. Hardware from O.E. Part may need to be reused.;





APPLICATION GUIDE

Year	Fitment Notes										
		Ultra	Ready Mounts	Max Control LTV ProGuard Guardian	Strut Cushion\ Strut Mount\ Dampers\ Stabilizer	HiJackers\ Load Carrier\ Classic	Ultra	Ready Mounts	Max Control LTV ProGuard Guardian	Strut Cushion\ Strut Mount\ Dampers\ Stabilizer	HiJackers\ Load Carrier\ Classic





HONDA

HONDA

















FIT (cont)

06-08	Left		G57541 ⁴⁰		70060
	Right		G57542 ⁴⁰		70060





INSIGHT

10-14	Left		G52152	G57603 ⁴⁰	
	Right		G52153	G57604 ⁴⁰	





















ODYSSEY

12-17	From Chassis/VIN CB088499		143305 ⁵⁴	
08-10	Left		G52253	G57564 ⁴⁰	143305 ⁵⁴		70010
	Right		G52254	G57565 ⁴⁰	143305 ⁵⁴		70010
05-07	Left		G57137 ⁴⁰	143305 ⁵⁴		70010
	Right		G57138 ⁴⁰	143305 ⁵⁴		70010
99-04	Left		G57011 ⁴⁰	143061 ⁵¹ 143315 ⁵⁴		69909
	Right		G57012 ⁴⁰	143061 ⁵¹ 143315 ⁵⁴		69909
95-98	All		M55877	142230 ⁵³ 143064 ⁵¹		G55821	142230 ⁵³ 143063 ⁵¹

PASSPORT

98-02	All		G63611	61593 81872		G63710	81911
94-97	All		G63611	61593 81872		G63610	61592 81937

PILOT

10-15	Left		G52360	G57695 ⁴⁰		G64104
	Right		G52361	G57696 ⁴⁰		G64104
09	Left		G52360		G64104
	Right		G52361		G64104
06-08	FWD, Left		G57605 ⁴⁰	
	FWD, Right		G57606 ⁴⁰	
03-08	Left		G56759	143315 ⁵⁴		G64003	61704	49236 ⁷
	Right		G56758	143315 ⁵⁴		G64003	61704	49236 ⁷
	AWD, Left		G57119 ⁴⁰	
	AWD, Right		G57120 ⁴⁰	



7 Pair Packs, Air hose kit included.;

51 Strut Cushion for use with the Strut/Cartridge/Shocks.;

40 Complete Assembled Unit.;

53 Hardware from O.E. Part may need to be reused.;

APPLICATION GUIDE

Year	Fitment Notes										
		Ultra	Ready Mounts	Max Control\ LTV\ ProGuard\ Guardian	Strut Cushion\ Strut Mount\ Dampers\ Stabilizer	HiJackers\ Load Carrier\ Classic	Ultra	Ready Mounts	Max Control\ LTV\ ProGuard\ Guardian	Strut Cushion\ Strut Mount\ Dampers\ Stabilizer	HiJackers\ Load Carrier\ Classic

HONDA

HONDA

PRELUDE

92-01	All		142230 ⁵³ 143064 ⁵¹				143064 ⁵¹
88-91	All		142230 ⁵³ 143064 ⁵¹
83-87	All		142230 ⁵³ 143059 ⁵¹				143059 ⁵¹
79-82	All		143059 ⁵¹

RIDGELINE

06-14	Left		G52150	G57333 ⁴⁰				G51880	G57414 ⁴⁰	142230 ⁵³
	Right		G52151	G57334 ⁴⁰				G51880	G57415 ⁴⁰	142230 ⁵³

S2000

08-09	All		142230 ⁵³
00-07	All		142230 ⁵³	142230 ⁵³

HUMMER

HUMMER

H2

03-09	All		G63817	61663 77817				G64000
-------	-----	--	--------	------	----------------	------	------	--	--	--	--------	------	------	------	------

H3

06-10	All		G64001				G63965
	w/ Off Road Package		77983

HYUNDAI

HYUNDAI

ACCENT

18-19	All					70231
12-17	Left		G52353				70095
	Right		G52354				70095
06-11	Left		G52154	G57275 ⁴⁰	143409 ⁵⁴				70036	142419 ⁶⁷
	Right		G52155	G57276 ⁴⁰	143410 ⁵⁴				70036	142419 ⁶⁷
00-05	Left		G57268 ⁴⁰	143059 ⁵¹	G57278 ⁴⁰
	Right		G57269 ⁴⁰	143059 ⁵¹	G57279 ⁴⁰
98-99	All		143059 ⁵¹
97	Mfg. to 6/97		143059 ⁵¹
95-96	All		143059 ⁵¹	143059 ⁵¹

AZERA

12-17	Left		G52437				70068
-------	------	--	--------	------	------	------	------	--	--	--	-------	------	------	------	------

40 Complete Assembled Unit.;



53 Hardware from O.E. Part may need to be reused.;

67 Mount Kit. Hardware from O.E. Part may need to be reused.;

51 Strut Cushion for use with the Strut/Cartridge/Shocks.;

54 Kit with Mount and Bearing. Hardware from O.E. Part may need to be reused.;







APPLICATION GUIDE

Year	Fitment Notes										
		Ultra	Ready Mounts	Max Control LTV ProGuard Guardian	Strut Cushion\ Strut Mount\ Dampers\ Stabilizer	HiJackers\ Load Carrier\ Classic	Ultra	Ready Mounts	Max Control LTV ProGuard Guardian	Strut Cushion\ Strut Mount\ Dampers\ Stabilizer	HiJackers\ Load Carrier\ Classic

HYUNDAI

HYUNDAI

AZERA (cont)

12-17	Right		G52438		70068
11	All		G57149 ⁴⁰	143342 ⁶⁷		70013
06-10	All		G51806	G57149 ⁴⁰	143342 ⁶⁷		70013



ELANTRA

14-16	All			70098
	Limited, SE, Left Mfg. to 10/16		G57742 ⁴⁰	
	Limited, SE, Right Mfg. to 10/16		G57743 ⁴⁰	
12-13	Left		G52439		70098
	Right		G52440		70098
13	GLS, Limited, Left		G57742 ⁴⁰	
	GLS, Limited, Right		G57743 ⁴⁰	
11-12	Sedan Left		G57803 ⁴⁰	
	Sedan Right		G57804 ⁴⁰	
11	All		143477 ⁶⁷		70098
07-10	Left		G52156	G57393 ⁴⁰	143477 ⁶⁷	
	Right		G52157	G57394 ⁴⁰	143477 ⁶⁷	
	Exc. Touring Models			70037
01-06	Left		G56539	142625 ⁵³		G56640	G57167 ⁴⁰
	Right		G56540	142625 ⁵³		G56641	G57168 ⁴⁰
00-06	Automatic Left		G57088 ⁴⁰	
	Automatic Right		G57089 ⁴⁰	
96-00	All		142625 ⁵³	
	Left Gas Charged Unit			G52335
	Right Gas Charged Unit			G52336
00	Left			G57167 ⁴⁰
	Left Mfg. from 5/00		G56539		G56640
	Right			G57168 ⁴⁰
	Right Mfg. from 5/00		G56540		G56641
92-95	Non-ABS		143057 ⁵¹		142419 ⁶⁷

40 Complete Assembled Unit;

51 Strut Cushion for use with the Strut/Cartridge/Shocks.;

APPLICATION GUIDE

Year	Fitment Notes										
		Ultra	Ready Mounts	Max Control\ LTV\ ProGuard\ Guardian	Strut Cushion\ Strut Mount\ Dampers\ Stabilizer	HiJackers\ Load Carrier\ Classic	Ultra	Ready Mounts	Max Control\ LTV\ ProGuard\ Guardian	Strut Cushion\ Strut Mount\ Dampers\ Stabilizer	HiJackers\ Load Carrier\ Classic

HYUNDAI

HYUNDAI

ELANTRA GT

14-17	Left Models w/ 16" or 17" Wheels; Mfg to 10/16	G57740 ⁴⁰
	Right Models w/ 16" or 17" Wheels; Mfg to 10/16	G57741 ⁴⁰

ENTOURAGE

09	All	143416 ⁵⁴
07-08	Left	G52257	143416 ⁵⁴	G64071
	Right	G52258	143416 ⁵⁴	G64071

EXCEL

90-94	All	143057 ⁵¹
86-89	All	143059 ⁵¹

SANTA FE

13-16	FWD	G64143
10-11	All	143416 ⁵⁴
07-09	Left	G52158	G57471 ⁴⁰	143416 ⁵⁴	G64048
	Right	G52159	G57472 ⁴⁰	143416 ⁵⁴	G64048
05-06	Left	G56562	G57139 ⁴⁰	69907
	Right	G56561	G57140 ⁴⁰	69907
01-04	Left	G56562	G57139 ⁴⁰	143087 ⁵³	69907
	Right	G56561	G57140 ⁴⁰	143087 ⁵³	69907

SONATA

11-14	All	70068
11	Mfg. to 7/22/10 Exc. Hybrid Left	G52329
	Mfg. to 7/22/10 Exc. Hybrid Right	G52330
06-10	All	G51806	143342 ⁵⁷	70013
	2.4L	G57149 ⁴⁰
01-05	Left	G51714	G57059 ⁴⁰	142419 ⁵⁷	G57090 ⁴⁰	142419 ⁵⁷
	Right	G51714	G57059 ⁴⁰	142419 ⁵⁷	G57091 ⁴⁰	142419 ⁵⁷
00	All	G56565	G57059 ⁴⁰	142419 ⁵⁷	142419 ⁵⁷
	Left	G57090 ⁴⁰
	Mfg. from 8/00	G51714

40 Complete Assembled Unit.;



53 Hardware from O.E. Part may need to be reused.;

67 Mount Kit. Hardware from O.E. Part may need to be reused.;;

51 Strut Cushion for use with the Strut/Cartridge/Shocks.;

54 Kit with Mount and Bearing. Hardware from O.E. Part may need to be reused.;

APPLICATION GUIDE

Year	Fitment Notes										
		Ultra	Ready Mounts	Max Control\ LTV\ ProGuard\ Guardian	Strut Cushion\ Strut Mount\ Dampers\ Stabilizer	HiJackers\ Load Carrier\ Classic	Ultra	Ready Mounts	Max Control\ LTV\ ProGuard\ Guardian	Strut Cushion\ Strut Mount\ Dampers\ Stabilizer	HiJackers\ Load Carrier\ Classic

HYUNDAI

HYUNDAI

SONATA (cont)

00	Right	G57091 ⁴⁰
99	All	G56565
89-94	All	143057 ⁵¹	...

TIBURON

03-08	Left	...	G57398 ⁴⁰	...	143397 ⁶⁷	G57400 ⁴⁰
	Right	...	G57399 ⁴⁰	...	143397 ⁶⁷	G57401 ⁴⁰
97-01	All	142625 ⁵³

TUCSON

10-15	Left	...	G57758 ⁴⁰
	Right	...	G57759 ⁴⁰
	AWD	G64216
05-09	Left	G56819	G57218 ⁴⁰	...	143087 ⁵³	...	G56822	G57343 ⁴⁰
	Right	G56820	G57219 ⁴⁰	...	143087 ⁵³	...	G56821	G57344 ⁴⁰

VELOSTER

12-17	All	G70095
-------	-----	-----	-----	-----	-----	-----	--------	-----	-----	-----	-----

VERACRUZ

12	All	G64048
07-11	All	143416 ⁵⁴	...	G64048

XG300

01	All	G51899	142419 ⁶⁷	...
----	-----	--------	-----	-----	-----	-----	-----	-----	-----	----------------------	-----

XG350

02-05	All	G51899	142419 ⁶⁷	...
-------	-----	--------	-----	-----	-----	-----	-----	-----	-----	----------------------	-----

INFINITI

INFINITI

FX35

03-08	All	142937 ⁵⁴
-------	-----	-----	-----	-----	----------------------	-----	-----	-----	-----	-----	-----

FX45

03-08	All	142937 ⁵⁴
-------	-----	-----	-----	-----	----------------------	-----	-----	-----	-----	-----	-----

G20

91-96	All	G56591	142547 ⁵³ 143057 ⁵¹
-------	-----	--------	-----	-----	--	-----	-----	-----	-----	-----	-----

G35

03-07	All	143455 ⁶⁷
-------	-----	-----	-----	-----	----------------------	-----	-----	-----	-----	-----	-----



40 Complete Assembled Unit.;

53 Hardware from O.E. Part may need to be reused.;

51 Strut Cushion for use with the Strut/Cartridge/Shocks.;

54 Kit with Mount and Bearing. Hardware from O.E. Part may need to be reused.;

APPLICATION GUIDE

Year	Fitment Notes										
		Ultra	Ready Mounts	Max Control\ LTV\ ProGuard\ Guardian	Strut Cushion\ Strut Mount\ Dampers\ Stabilizer	HiJackers\ Load Carrier\ Classic	Ultra	Ready Mounts	Max Control\ LTV\ ProGuard\ Guardian	Strut Cushion\ Strut Mount\ Dampers\ Stabilizer	HiJackers\ Load Carrier\ Classic

INFINITI

INFINITI

G35 (cont)

03-07	Coupe Left Sport Suspension	G51813
	Coupe Right Sport Suspension	G51814
03-06	Coupe Sport Suspension	G51812

I30

00-01	Left	142937 ⁵⁴	G51727	G57159 ⁴⁰
	Right	142937 ⁵⁴	G51727	G57160 ⁴⁰
96-99	Left	M55913	142546 ⁵⁴	G51087	G57057 ⁴⁰	142547 ⁵³
	Right	M55912	142546 ⁵⁴	G51087	G57058 ⁴⁰	142547 ⁵³

I35

04	Left	142937 ⁵⁴	G51727	G57159 ⁴⁰
	Right	142937 ⁵⁴	G51727	G57160 ⁴⁰
02-03	Left	G57157 ⁴⁰	142937 ⁵⁴	G51727	G57159 ⁴⁰
	Right	G57158 ⁴⁰	142937 ⁵⁴	G51727	G57160 ⁴⁰

M35

06-07	RWD, Left	G51925	143455 ⁵⁷
	RWD, Right	G51926	143455 ⁵⁷

M45

06-07	Left	G51925
	Right	G51926

Q45

97-01	All	G51930
-------	-----	------	------	------	------	------	--------	------	------	------	------

QX4

02-03	Left	G56687	G57144 ⁴⁰
	Right	G56688	G57145 ⁴⁰
99-03	Mfg. from 12/98	G63845
98-03	All	142938 ⁵³
99-01	Left Mfg. from 12/98	G56615
	Right Mfg. from 12/98	G56616
97-99	Mfg. to 11/98 Left	G57037 ⁴⁰
	Mfg. to 11/98 Right	G57038 ⁴⁰



40 Complete Assembled Unit.;

54 Kit with Mount and Bearing. Hardware from O.E. Part may need to be reused.;

53 Hardware from O.E. Part may need to be reused.;

67 Mount Kit. Hardware from O.E. Part may need to be reused.;

APPLICATION GUIDE

Year	Fitment Notes										
		Ultra	Ready Mounts	Max Control LTV ProGuard Guardian	Strut Cushion\ Strut Mount\ Dampers\ Stabilizer	HiJackers\ Load Carrier\ Classic	Ultra	Ready Mounts	Max Control LTV ProGuard Guardian	Strut Cushion\ Strut Mount\ Dampers\ Stabilizer	HiJackers\ Load Carrier\ Classic

INFINITI

INFINITI

QX4 (cont)

98	Mfg. to 12/98	○ G63712	81910
97	All	142938 ⁵³	○ G63712	81910

QX56

04-10	All	↑ G51715	143359 ⁶⁷
	4WD	↑	G57092 ⁴⁰
05-07	Exc. Air-Leveling Suspension	○ G63875

QX60

16-20	All	↑ ○ G511043
-------	-----	-------	-------	-------	-------	-------	-------------	-------	-------	-------	-------

INTERNATIONAL

INTERNATIONAL

100

74	Steering Stabilizer	○ ○	6802SE ⁸⁴								
----	---------------------	-----	----------------------	--	--	--	--	--	--	--	--

150

75	Steering Stabilizer	○ ○	6802SE ⁸⁴								
----	---------------------	-----	----------------------	--	--	--	--	--	--	--	--

200

74-75	Steering Stabilizer	○ ○	6802SE ⁸⁴								
-------	---------------------	-----	----------------------	--	--	--	--	--	--	--	--

908C

68-69	Single System Steering Stabilizer; 1/2 Ton, 3/4 Ton & Travelall	○ ○	6802SE ⁸⁴									
68	All	○ ○	82007	○ G63405	61500 81147	43048 ⁸ 49310 ⁷

1000C

68	All	○ ○	○	61500 81147	43048 ⁸ 49310 ⁷
	Exc. 166" Wheelbase	○ ○	○ G63405
	Single System Steering Stabilizer; 1/2 Ton, 3/4 Ton & Travelall	○ ○	6802SE ⁸⁴									

1000D

69-70	Single System Steering Stabilizer; 1/2 Ton, 3/4 Ton & Travelall	○ ○	6802SE ⁸⁴								
-------	---	-----	----------------------	--	--	--	--	--	--	--	--

1010

71-73	Single System Steering Stabilizer; 1/2 Ton, 3/4 Ton & Travelall	○ ○	6802SE ⁸⁴								
-------	---	-----	----------------------	--	--	--	--	--	--	--	--

1100C

68	All	○ ○	82007
	Exc. 166" Wheelbase	○ ○	G63405	61500 81147	43048 ⁸	○ G63405	61500 81147	43048 ⁸ 49310 ⁷
	Single System Steering Stabilizer; 1/2 Ton, 3/4 Ton & Travelall	○ ○	6802SE ⁸⁴									

1100D

69-70	Single System Steering Stabilizer; 1/2 Ton, 3/4 Ton & Travelall	○ ○	6802SE ⁸⁴								
-------	---	-----	----------------------	--	--	--	--	--	--	--	--

7 Pair Packs, Air hose kit included.;

40 Complete Assembled Unit.;



120 67 Mount Kit. Hardware from O.E. Part may need to be reused.;

8 Pair Packs.;

53 Hardware from O.E. Part may need to be reused.;

84 Replacement damper for vehicles with the Gabriel Aftermarket mounting kit;

APPLICATION GUIDE

Year	Fitment Notes										
		Ultra	Ready Mounts	Max Control\ LTV\ ProGuard\ Guardian	Strut Cushion\ Strut Mount\ Dampers\ Stabilizer	HiJackers\ Load Carrier\ Classic	Ultra	Ready Mounts	Max Control\ LTV\ ProGuard\ Guardian	Strut Cushion\ Strut Mount\ Dampers\ Stabilizer	HiJackers\ Load Carrier\ Classic

INTERNATIONAL

1110

71-73	Single System Steering Stabilizer; 1/2 Ton, 3/4 Ton & Travelall	OO	6802SE ⁸⁴							
-------	---	----	----------------------	--	--	--	--	--	--	--

1200C

68	Exc. 166" Wheelbase	OO	G63405	61500 81147	43048 ⁸ 82007	OO	G63405	61500 81147	43048 ⁸ 49310 ⁷
	Single System Steering Stabilizer; 1/2 Ton, 3/4 Ton & Travelall	OO	6802SE ⁸⁴										

1200D

69-70	Single System Steering Stabilizer; 1/2 Ton, 3/4 Ton & Travelall	OO	6802SE ⁸⁴										
-------	---	----	----------------------	--	--	--	--	--	--	--	--	--	--

1210

71-73	Single System Steering Stabilizer; 1/2 Ton, 3/4 Ton & Travelall	OO	6802SE ⁸⁴										
-------	---	----	----------------------	--	--	--	--	--	--	--	--	--	--

1300C

68	Exc. 166" Wheelbase	OO	G63405	61500 81147	43048 ⁸ 82007	OO	G63405	61500 81147	43048 ⁸ 49310 ⁷
	Single System Steering Stabilizer; 1/2 Ton, 3/4 Ton & Travelall	OO	6802SE ⁸⁴										

1300D

69-70	Single System Steering Stabilizer; 1/2 Ton, 3/4 Ton & Travelall	OO	6802SE ⁸⁴										
-------	---	----	----------------------	--	--	--	--	--	--	--	--	--	--

1310

71-73	Single System Steering Stabilizer; 1/2 Ton, 3/4 Ton & Travelall	OO	6802SE ⁸⁴										
-------	---	----	----------------------	--	--	--	--	--	--	--	--	--	--

SCOUT

69-71	Single System Steering Stabilizer	OO	6803SE ⁸⁴										
61-71	All	OO	82007	OO	82039
61-68	Single System Steering Stabilizer; 4WD; Scout 80, 800	OO	6802SE ⁸⁴										

SCOUT II

71-80	All	OO	G63350	61518 81242	43099 ⁸	OO
	Single System Steering Stabilizer	OO	6803SE ⁸⁴										

TRAVELALL

75	Single System Steering Stabilizer	OO	6803SE ⁸⁴										
	Steering Stabilizer	OO	6802SE ⁸⁴										

ISUZU

ISUZU

AMIGO

98-00	All	OO	G63611	61593 81872	OO	G63710	81911
89-94	All	OO	G63909	61508 77909 81507	OO	G63928	61506 81318	49311 ⁷

ASCENDER

03-08	All	OO	G51718 ⁴⁵	G57022 ⁴⁰	OO
-------	-----	----	----------------------	----------------------	------	------	------	----	------	------	------	------	------

7 Pair Packs, Air hose kit included.;



40 Complete Assembled Unit.;

84 Replacement damper for vehicles with the Gabriel Aftermarket mounting kit;

8 Pair Packs.;

45 Strut must be rotated to align notch with lower control arm.;

APPLICATION GUIDE

Year	Fitment Notes										
		Ultra	Ready Mounts	Max Control LTV ProGuard Guardian	Strut Cushion\ Strut Mount\ Dampers\ Stabilizer	HiJackers\ Load Carrier\ Classic	Ultra	Ready Mounts	Max Control LTV ProGuard Guardian	Strut Cushion\ Strut Mount\ Dampers\ Stabilizer	HiJackers\ Load Carrier\ Classic

ISUZU

ISUZU

ASCENDER (cont)

03-08	Coil(RearSpringType)		G63842	61717
-------	----------------------	--	------	------	------	------	------	--------	------	-------	------	------

AXIOM

02-04	All		G63611	61593 81872	G63710	81911
-------	-----	--	--------	------	----------------	------	------	--------	------	-------	------	------

HOMBRE

98-00	RWD, Exc. Sport Chassis		G63421	58421 61504 81750	34051 ⁸	
96-00	All		G63422	61528 77422 81482	43162 ⁸ 49213 ⁷
00	Sport Chassis		58423
	4WD		G63423	61531 77423 81516
99	Sport Chassis		G63423	58423
	4WD		61531 77423 81516
96-98	Sport Chassis		G63423	58423 61531 77423 81516
96-97	RWD, Exc. Sport Chassis		G63421	58421 61504 81750
	RWD; Exc. Sport Chassis		34051 ⁸	

I-280

06	All		43162 ⁸ 49213 ⁷
	Torsion Bar (FrontSpringType)		G63879
	Coil(FrontSpringType)		G63882	77422
	RWD, Coil(FrontSpringType)		77422
	RWD, Coil(FrontSpringType) Exc. Z71 Off Road Package		G51850

I-290

07-08	All		43162 ⁸ 49213 ⁷
	Coil(FrontSpringType)		G63882
	RWD, Coil(FrontSpringType) Exc. Z71 Off Road Package		G51850



I-350

06	Torsion Bar(FrontSpringType)		G63884
----	------------------------------	--	--------	------	------	------	------	--	------	------	------	------

I-370

07-08	All		43162 ⁸ 49213 ⁷
08	Coil(FrontSpringType)		G63882
	RWD, Coil(FrontSpringType) Exc. Z71 Off Road Package		G51850
07	RWD		G51850

APPLICATION GUIDE

Year	Fitment Notes										
		Ultra	Ready Mounts	Max Control\ LTV\ ProGuard\ Guardian	Strut Cushion\ Strut Mount\ Dampers\ Stabilizer	HiJackers\ Load Carrier\ Classic	Ultra	Ready Mounts	Max Control\ LTV\ ProGuard\ Guardian	Strut Cushion\ Strut Mount\ Dampers\ Stabilizer	HiJackers\ Load Carrier\ Classic

ISUZU

ISUZU

IMPULSE

90-92	All		143058 ⁵¹				143061 ⁵¹
83-89	All				81340	43140 ⁸

OASIS

96-99	All		M55877	142230 ⁵³ 143064 ⁵¹			G55821	142230 ⁵³ 143063 ⁵¹
-------	-----	--	-------	-------	--------	--	-------	--	--	--------	-------	--	-------

PICKUP

81-95	All					61506 81318	49311 ⁷
	4WD		G63909	61508 77909 81507			G63928
	RWD		G63902	61501 81478			G63492

RODEO

98-04	All		G63611	61593 81872			G63710	81911
91-97	All		G63611	61593 81872			G63610	61592 81937

STYLUS

91-93	All		143058 ⁵¹	143061 ⁵¹
-------	-----	--	-------	-------	-------	----------------------	-------	--	--	-------	-------	----------------------	-------

TROOPER

92-02	All		G63707			G63708	61608
89-91	4WD		G63495	61593 81553
84-91	Single System Steering Stabilizer		6802SE ⁸⁴										
87-88	4WD		G63495	61593 81553	82066
84-86	4WD		G63909	61508 77909 81507			G63928	61506 81318	49311 ⁷

VEHICROSS

99-01	All		G63707			G63708	61608
-------	-----	--	--------	-------	-------	-------	-------	--	--	--------	-------	-------	-------

JAGUAR

JAGUAR

S TYPE

00-05	Mfg. to 6/02 Exc. Computer Active Technology Suspension				G51773
-------	---	--	-------	-------	-------	-------	-------	--	--	--------	-------	-------	-------

X-TYPE

02-08	Exc. CATS Computer Active Technology Suspension		G52276
-------	---	--	--------	-------	-------	-------	-------	--	--	-------	-------	-------	-------

XJ6

72-86	All		G69677
-------	-----	--	--------	-------	-------	-------	-------	--	--	-------	-------	-------	-------

XJ12

81-92	All		G69677
73-79	All		G69677

XJS

76-96	All		G69677
-------	-----	--	--------	-------	-------	-------	-------	--	--	-------	-------	-------	-------

7 Pair Packs, Air hose kit included.;



51 Strut Cushion for use with the Strut/Cartridge/Shocks.;

84 Replacement damper for vehicles with the Gabriel Aftermarket mounting kit;

8 Pair Packs.;

53 Hardware from O.E. Part may need to be reused.;

APPLICATION GUIDE

Year	Fitment Notes										
		Ultra	Ready Mounts	Max Control LTV ProGuard Guardian	Strut Cushion\ Strut Mount\ Dampers\ Stabilizer	HiJackers\ Load Carrier\ Classic	Ultra	Ready Mounts	Max Control LTV ProGuard Guardian	Strut Cushion\ Strut Mount\ Dampers\ Stabilizer	HiJackers\ Load Carrier\ Classic

JAGUAR

JAGUAR

XKE

62-64	All	81270	49105 ⁷
-------	-----	-------	-------	-------	-------	-------	-------	-------	-------	--------------------

JEEP

JEEP

CHEROKEE

14-17	FWD	G511038
84-01	All	G63424	61535 81548	14040	G63425	61536 77425 81549
84-00	Single System Steering Stabilizer; with a factory mounting hole in the steering linkage.	6801SE ⁸⁰								
76-83	All	G63377	61519 81484	43058 ⁸	G63377	61519 81484
74-83	Single System Steering Stabilizer	6804SE ⁸⁰								
75	All	G63377	61519 81484	43058 ⁸
74	All	G63377	61519 81484	43058 ⁸	81676

CJ3

61-66	Exc. 5 Leaf Front Springs & Lift Kit	82007
59-66	All	81676	81676
65	Exc. Lift Kit	G63405

CJ5

82-83	All	G63377	43058 ⁸
	2" Lift Kit	G63443 ⁵⁰
	Exc. Lift Kit	61519 81484	G63405	61500 81147
66-83	Single System Steering Stabilizer	6802SE ⁸⁴								
72-81	All	81676	81676
	Exc. Lift Kit	G63299	82007	G63405	61500 81147
66-81	2 - 4" Lift Kit	G63443 ⁵⁰
69-71	All	61500 81676	43048 ⁸ 49310 ⁷
66-71	5 Leaf Front Springs; Exc. Lift Kit	81676	81676
	Exc. 5 Leaf Front Springs & Lift Kit	82007	81147
65-71	Exc. Lift Kit	G63405
66-68	All	81676	61500 81676	43048 ⁸ 49310 ⁷
61-65	Exc. 5 Leaf Front Springs & Lift Kit	82007
59-65	All	81676	81676
59-60	Single System Steering Stabilizer	6802SE ⁸⁴								

CJ6

72-75	All	81676	81676
	Exc. Lift Kit	G63299	82007	G63405	61500 81147
66-75	2 - 4" Lift Kit	G63443 ⁵⁰



7 Pair Packs, Air hose kit included.;

50 Bellows Kit No.141242 is recommended for use to protect piston rod from potentially harmful road debris.;

8 Pair Packs.;

80 Mounting bracket not required, install on O.E. Shock Mounts. See Ref. C for optional Steering Stabilizer Boots.;

APPLICATION GUIDE

Year	Fitment Notes										
		Ultra	Ready Mounts	Max Control\ LTV\ ProGuard\ Guardian	Strut Cushion\ Strut Mount\ Dampers\ Stabilizer	HiJackers\ Load Carrier\ Classic	Ultra	Ready Mounts	Max Control\ LTV\ ProGuard\ Guardian	Strut Cushion\ Strut Mount\ Dampers\ Stabilizer	HiJackers\ Load Carrier\ Classic

JEEP

JEEP

CJ6 (cont)

66-75	Single System Steering Stabilizer		6802SE ⁸⁴									
69-71	All		61500 81676	43048 ⁸ 49310 ⁷
66-71	5 Leaf Front Springs; Exc. Lift Kit		81676	81676
	Exc. 5 Leaf Front Springs & Lift Kit		82007
	Exc. Lift Kit		G63405	81147
66-68	All		81676	61500 81676	43048 ⁸ 49310 ⁷
59-65	All		81676	81676
65	Exc. Lift Kit		G63405
59-60	Single System Steering Stabilizer		6802SE ⁸⁴									

CJ7

82-86	All		G63377	43058 ⁸
	2" Lift Kit		G63443 ⁵⁰
	Exc. Lift Kit		61519 81484	G63405	61500 81147
76-86	Single System Steering Stabilizer		6802SE ⁸⁴									
76-81	All		81676
	2 - 4" Lift Kit		G63443 ⁵⁰
	Exc. Lift Kit		G63299	82007	G63405	61500 81147

COMANCHE

86-92	All		G63424	61535 81548	14040	G63492	61506 81318	49311 ⁷
	Single System Steering Stabilizer; with a factory mounting hole in the steering linkage.		6801SE ⁸⁰										

COMMANDER

06-10	All		G56807	143364 ⁵³	G64012	61715
	Exc. Performance		G57083 ⁴⁰

COMPASS

11-17	All		G57794 ⁴⁰
07-10	Left		G52081	G57464 ⁴⁰	143495 ⁵⁴	G51842	G57607 ⁴⁰	143496 ⁵⁷
	Right		G52082	G57463 ⁴⁰	143495 ⁵⁴	G51842	G57607 ⁴⁰	143496 ⁵⁷

DISPATCHER

61-67	All		81676	81676
-------	-----	--	------	------	-------	------	------	------	------	------	-------	------	------

DJ3

59-66	All		81676	81676
-------	-----	--	------	------	-------	------	------	------	------	------	-------	------	------

7 Pair Packs, Air hose kit included.;

40 Complete Assembled Unit.;

53 Hardware from O.E. Part may need to be reused.;

67 Mount Kit. Hardware from O.E. Part may need to be reused.;

84 Replacement damper for vehicles with the Gabriel Aftermarket mounting kit;



8 Pair Packs.;

50 Bellows Kit No.141242 is recommended for use to protect piston rod from potentially harmful road debris.;

54 Kit with Mount and Bearing. Hardware from O.E. Part may need to be reused.;

80 Mounting bracket not required, install on O.E. Shock Mounts. See Ref. C for optional Steering Stabilizer Boots.;

APPLICATION GUIDE

Year	Fitment Notes										
		Ultra	Ready Mounts	Max Control LTV ProGuard Guardian	Strut Cushion\ Strut Mount\ Dampers\ Stabilizer	HiJackers\ Load Carrier\ Classic	Ultra	Ready Mounts	Max Control LTV ProGuard Guardian	Strut Cushion\ Strut Mount\ Dampers\ Stabilizer	HiJackers\ Load Carrier\ Classic

JEEP

JEEP

DJ5

66-74	2 - 4" Lift Kit	⊙	G63443 ⁵⁰		
	Exc. Lift Kit	⊙	G63299	82007	⊙	G63405	61500 81147
65-74	All	⊙	81676	⊙

DJ6

66-68	All	⊙	81676	82007	⊙	61500 81147	43048 ⁸ 49310 ⁷
	2 - 4" Lift Kit	⊙	G63443 ⁵⁰	⊙
	Exc. Lift Kit	⊙	⊙	G63405
65	All	⊙	81676	⊙

FC150

61-65	All	⊙	82007	⊙	81676
57-60	All	⊙	81676	82007	⊙	G63405	61500 81147	43048 ⁸ 49310 ⁷

FC170

63-65	All	⊙	G63405	61500 81147	43048 ⁸	⊙	G63405	61500 81147	43048 ⁸ 49310 ⁷
-------	-----	---	--------	------	----------------	------	--------------------	---	--------	------	----------------	------	--

GLADIATOR

20-22	All	⊙	⊙	G63959	77412	43181 ⁸ 49235 ⁷
66-67	Exc. Independent Front Suspension	⊙	⊙	49311 ⁷
63-67	Single System Steering Stabilizer	⊙	6803SE ⁸⁴										
67	All	⊙	81318	⊙	61519 81484	43058 ⁸
64-66	Independent Front Suspension	⊙	⊙	G63405	61500	43048 ⁸ 49310 ⁷
66	All	⊙	81318	⊙	81147
64-65	All	⊙	⊙	81147
	Exc. Independent Front Suspension	⊙	81318	⊙	49311 ⁷
63	Independent Front Suspension	⊙	⊙	G63405	61500 81147	43048 ⁸ 49310 ⁷

GRAND CHEROKEE

11-22	Exc. Load Leveling Suspensions	⊙	⊙	G511000
11-15	Left	⊙	G57764 ⁴⁰	⊙
	Right	⊙	G57765 ⁴⁰	⊙
05-10	4WD; Exc. Performance 4.7L & 5.7L V8 Models	⊙	G57083 ⁴⁰	⊙
10	Left	⊙	G56807	G57764 ⁴⁰	143364 ⁵³	⊙	G64012	61715
	Right	⊙	G56807	G57765 ⁴⁰	143364 ⁵³	⊙	G64012	61715
05-09	All	⊙	G56807	143364 ⁵³	⊙	G64012	61715
99-04	All	⊙	81869	⊙	G63829	61676 77829 81926

7 Pair Packs, Air hose kit included.;

40 Complete Assembled Unit.;



53 Hardware from O.E. Part may need to be reused.;

8 Pair Packs.;

50 Bellows Kit No. 141242 is recommended for use to protect piston rod from potentially harmful road debris.;

84 Replacement damper for vehicles with the Gabriel Aftermarket mounting kit;

APPLICATION GUIDE

Year	Fitment Notes										
		Ultra	Ready Mounts	Max Control\ LTV\ ProGuard\ Guardian	Strut Cushion\ Strut Mount\ Dampers\ Stabilizer	HiJackers\ Load Carrier\ Classic	Ultra	Ready Mounts	Max Control\ LTV\ ProGuard\ Guardian	Strut Cushion\ Strut Mount\ Dampers\ Stabilizer	HiJackers\ Load Carrier\ Classic

JEEP

JEEP

GRAND CHEROKEE (cont)

99-04	Exc. Up Country Suspension	OE	G63847	61664 77847			
	Single System Steering Damper	OE	14071			
95-98	All	OE	G63424	61535 81548	OE	G63683	61575 77683 81891
93-98	Steering Stabilizer	OE	6853SE ⁸²										
93-94	All	OE	G63424	61535 81548	OE	61575 77683 81891

GRAND WAGONEER

93	All	OE	G63377	61519 81484	43058 ⁸	OE	G63377	61519 81484	43058 ⁸ 49127 ⁷
84-91	All	OE	G63377	61519 81484	43058 ⁸	OE	G63377	61519 81484	43058 ⁸ 49127 ⁷
	Single System Steering Stabilizer	OE	6804SE ⁸⁰										

J10 PICKUP

74-88	All	OE	G63377	61519 81484	43058 ⁸	OE	G63377	61519 81484	43058 ⁸ 49127 ⁷
	Single System Steering Stabilizer	OE	6804SE ⁸⁰										

J20 PICKUP

74-88	All	OE	G63377	61519 81484	43058 ⁸	OE	G63377	61519 81484	43058 ⁸ 49127 ⁷
	Single System Steering Stabilizer	OE	6804SE ⁸⁰										

J2500 PICKUP

68-73	All	OE	81318	OE	61519 81484	43058 ⁸ 49127 ⁷
-------	-----	----	------	------	-------	------	------	----	------	------	----------------	------	--

JEEPSTER

70-71	All	OE	82007	OE	G63405	61500 81147	43048 ⁸ 49310 ⁷
66-71	Single System Steering Stabilizer	OE	6802SE ⁸⁴										
67-69	All	OE	82007	OE	82007

LIBERTY

02-12	All	OE	G51728	OE	G63844
	Gas Left	OE	G57007 ⁴⁰	OE
	Gas Right	OE	G57008 ⁴⁰	OE

M151

60-68	All	OE	81676	OE
-------	-----	----	------	------	-------	------	------	----	------	------	------	------	------

PATRIOT

11-17	All	OE	OE	G57794 ⁴⁰
10	Left	OE	G52081	G57464 ⁴⁰	143495 ⁵⁴	OE	G51842	G57607 ⁴⁰
	Right	OE	G52082	G57463 ⁴⁰	143495 ⁵⁴	OE	G51842	G57607 ⁴⁰

7 Pair Packs, Air hose kit included.;

40 Complete Assembled Unit.;

80 Mounting bracket not required, install on O.E. Shock Mounts. See Ref. C for optional Steering Stabilizer Boots.;



84 Replacement damper for vehicles with the Gabriel Aftermarket mounting kit;

8 Pair Packs.;

54 Kit with Mount and Bearing. Hardware from O.E. Part may need to be reused.;

82 Use kit if listed, See Ref. C for optional Steering Stabilizer Boots.;





APPLICATION GUIDE

Year	Fitment Notes										
		Ultra	Ready Mounts	Max Control\ LTV\ ProGuard\ Guardian	Strut Cushion\ Strut Mount\ Dampers\ Stabilizer	HiJackers\ Load Carrier\ Classic	Ultra	Ready Mounts	Max Control\ LTV\ ProGuard\ Guardian	Strut Cushion\ Strut Mount\ Dampers\ Stabilizer	HiJackers\ Load Carrier\ Classic





JEEP

JEEP





PATRIOT (cont)

07-09	Left		G52081	G57464 ⁴⁰	143495 ⁵⁴		G51842	G57607 ⁴⁰	143496 ⁶⁷
	Right		G52082	G57463 ⁴⁰	143495 ⁵⁴		G51842	G57607 ⁴⁰	143496 ⁶⁷



RENEGADE

15-18	FWD, Left		G57768 ⁴⁰		G57795 ⁴⁰
	FWD, Right		G57769 ⁴⁰		G57796 ⁴⁰











SCRAMBLER / CJ8

82-85	All		G63377	61519 81484		G63405	61500 81147	43048 ⁸ 49310 ⁷
81-85	Single System Steering Stabilizer		6802SE ⁸⁴										
81	All		G63299	81676	82007		G63405	61500 81147	43048 ⁸ 49310 ⁷





















TRUCK

56-66	All		81676	
-------	-----	---	------	------	-------	------	------	---	------	------	------	------	------



UNIVERSAL

65-67	All		82007		61500 81147	43048 ⁸ 49310 ⁷
	2 - 4" Lift Kit		G63443 ⁵⁰	
	Exc. Lift Kit			G63405
61-67	5 Leaf Front Springs; Exc. Lift Kit		81676		81676
	Single System Steering Stabilizer		6802SE ⁸⁴										
61-64	All		82007		G63405	61500 81147	43048 ⁸ 49310 ⁷

WAGONEER

84-90	All		G63424	61535 81548		G63425	61536 77425 81549	49226 ⁷
76-83	All		G63377	61519 81484	43058 ⁸		G63377	61519 81484	43058 ⁸ 49127 ⁷
75	All		G63377	61519 81484	43058 ⁸	
74	All		G63377	61519 81484	43058 ⁸		G63299	81676
71-73	All		G63492	81318		G63299	81676	49311 ⁷
68-70	All		G63492	81318		81676	49311 ⁷
66-67	All		G63492	81318		G63299	81676	49311 ⁷
63-67	Exc. Independent Front Suspension		6802SE ⁸⁴										
63-65	All			G63299	81676
	Exc. Independent Front Suspension		G63492	81318		49311 ⁷
	Independent Front Suspension		81676	

WILLYS

43-58	All		81676		81676
-------	-----	---	------	------	-------	------	------	---	------	------	-------	------	------

7 Pair Packs, Air hose kit included.;

40 Complete Assembled Unit.;

54 Kit with Mount and Bearing. Hardware from O.E. Part may need to be reused.;



128 84 Replacement damper for vehicles with the Gabriel Aftermarket mounting kit;

8 Pair Packs.;

50 Bellows Kit No. 141242 is recommended for use to protect piston rod from potentially harmful road debris.;

67 Mount Kit. Hardware from O.E. Part may need to be reused.;

APPLICATION GUIDE

Year	Fitment Notes										
		Ultra	Ready Mounts	Max Control\ LTV\ ProGuard\ Guardian	Strut Cushion\ Strut Mount\ Dampers\ Stabilizer	HiJackers\ Load Carrier\ Classic	Ultra	Ready Mounts	Max Control\ LTV\ ProGuard\ Guardian	Strut Cushion\ Strut Mount\ Dampers\ Stabilizer	HiJackers\ Load Carrier\ Classic

JEEP

JEEP

WRANGLER

11-18	w/o Dust Boot	0	14040	
07-18	4WD, w/ Dust Boot	0	14074	
16-17	Models w/ 17" Wheels; w/Heavy Duty Suspension	0	G63967	61697	
07-17	Exc. Models w/ 17" Wheels	0	G63966	61696	
	4WD	0	77973	
13-15	Models w/ 17" Wheels	0	61697	
	Models w/ 17" Wheels; w/Heavy Duty Suspension	0	G63967	
11-12	All	1	G64008	61711 77981	
07-12	Models w/ 17" Wheels	0	G63967	61697	
07-10	All	1	G64008	61711 77981	14040	
97-06	Single System Steering Stabilizer; with a factory mounting hole in the steering linkage.	0	6801SE ⁸⁰										
	TJ(MfrBodyCode)	1	G63721	61615 81936	G63722	61616 81929
06	All	0	77978	14040	
97-05	All	0	77978	
94-95	Single System Steering Stabilizer; with a factory mounting hole in the steering linkage.	0	6801SE ⁸⁰										
87-95	All	0	43058 ⁸ 49127 ⁷
	YJ(MfrBodyCode)	1	81691	G63490	61541 81583
	YJ(MfrBodyCode) 4WD Quad Suspension Forward of Front Axle Non Quad Suspension	1	G63511
93	Single System Steering Stabilizer; w/ factory mounting hole in the steering linkage.	0	6801SE ⁸⁰										
87-92	Single System Steering Stabilizer; with a factory mounting hole in the steering linkage.	0	6801SE ⁸⁰										

KIA

KIA

AMANTI

07-09	All	1	143342 ⁶⁷	G51994
04-06	All	1	G51774	143419 ⁶⁷	G51825	143419 ⁶⁷

CADENZA

14-16	Left	1	G52437	70068
	Right	1	G52438	70068

FORTE

14-18	Hatchback	0	70208
11-13	Sedan	0	70102

FORTE KOUP

14-17	All	0	70208
-------	-----	---	-------	-------	-------	-------	-------	-------	-------	-------	-------	-------	-------



7 Pair Packs, Air hose kit included.;

67 Mount Kit. Hardware from O.E. Part may need to be reused.;;

8 Pair Packs.;

80 Mounting bracket not required, install on O.E. Shock Mounts. See Ref. C for optional Steering Stabilizer Boots.;

APPLICATION GUIDE

Year	Fitment Notes										
		Ultra	Ready Mounts	Max Control LTV ProGuard Guardian	Strut Cushion\ Strut Mount\ Dampers\ Stabilizer	HiJackers\ Load Carrier\ Classic	Ultra	Ready Mounts	Max Control LTV ProGuard Guardian	Strut Cushion\ Strut Mount\ Dampers\ Stabilizer	HiJackers\ Load Carrier\ Classic

KIA

KIA

FORTE5

14-18	All	70208
-------	-----	------	------	------	------	------	-------	------	------	------	------

MAGENTIS

07-10	Left	G52247	70049
	Right	G52248	70049
01-06	Left	G51714	G57090 ⁴⁰	142419 ⁶⁷
	Right	G51714	G57091 ⁴⁰	142419 ⁶⁷

OPTIMA

16	Hybrid, Hybrid EX, Hybrid EX Premium, Hybrid LX	70209
11-15	Exc. Hybrid Models	70068
15	Hybrid EX, Hybrid LX	70209
14	Hybrid EX, Hybrid EX Premium, Hybrid LX	70209
13	Hybrid, Hybrid EX, Hybrid LX, Hybrid Premium	70209
11-12	Hybrid	70209
07-10	Left	G52247	70049
	Right	G52248	70049
06	All	G51714	G57059 ⁴⁰	142419 ⁶⁷
	Left	G57090 ⁴⁰
	Left New Body Style	G52247
	Right	G57091 ⁴⁰
	Right New Body Style	G52248
01-05	Left	G51714	G57059 ⁴⁰	G57090 ⁴⁰	142419 ⁶⁷
	Right	G51714	G57059 ⁴⁰	G57091 ⁴⁰	142419 ⁶⁷

RIO

12-17	Left	G52353	70095
	Right	G52354	70095
06-11	Left	G52154	G57275 ⁴⁰	143409 ⁵⁴	70036	142419 ⁶⁷
	Right	G52155	G57276 ⁴⁰	143410 ⁵⁴	70036	142419 ⁶⁷
04-05	All	70001
01-03	All	143227 ⁵³	69585

RONDO

07-11	Left	G52247	70049
-------	------	--------	------	------	------	------	-------	------	------	------	------



40 Complete Assembled Unit;

53 Hardware from O.E. Part may need to be reused.;

130 54 Kit with Mount and Bearing. Hardware from O.E. Part may need to be reused.;

67 Mount Kit. Hardware from O.E. Part may need to be reused.;

APPLICATION GUIDE

Year	Fitment Notes										
		Ultra	Ready Mounts	Max Control\ LTV\ ProGuard\ Guardian	Strut Cushion\ Strut Mount\ Dampers\ Stabilizer	HiJackers\ Load Carrier\ Classic	Ultra	Ready Mounts	Max Control\ LTV\ ProGuard\ Guardian	Strut Cushion\ Strut Mount\ Dampers\ Stabilizer	HiJackers\ Load Carrier\ Classic

KIA

KIA

RONDO (cont)

07-11	Right	G52248	70049
-------	-------	--------	------	------	------	------	-------	------	------	------	------

SEDONA

14	Left	G52257	G64071
	Right	G52258	G64071
12	Left	G52257	G64071
	Right	G52258	G64071
06-11	Left	G52257	143416 ⁶⁴	G64071
	Right	G52258	143416 ⁶⁴	G64071
02-05	Left	G57489 ⁴⁰	143458 ⁶⁷	70000
	Right	G57490 ⁴⁰	143458 ⁶⁷	70000

SEPHIA

94-97	Left	G56637
	Right	G56571

SORENTO

14-15	AWD	70213
	FWD	70210
11-13	AWD, Left	G57689 ⁴⁰	70203
	AWD, Right	G57690 ⁴⁰	70203
07-09	Left Exc. HPD (High Performance Dampers)	G511054	70078
	Right Exc. HPD (High Performance Dampers)	G511055	70078
03-06	Exc. Self-Leveling Suspension	G64032
	Left	G52036
	Right	G52037

SOUL

14-19	All	70036
-------	-----	------	------	------	------	------	-------	------	------	------	------

SPECTRA



04-09	Left	G52160	G52162
	Right	G52161	G52163
02-03	Left	G56892	G52017
	Right	G56893	G52018

40 Complete Assembled Unit.;

67 Mount Kit. Hardware from O.E. Part may need to be reused.;

54 Kit with Mount and Bearing. Hardware from O.E. Part may need to be reused.;

APPLICATION GUIDE

Year	Fitment Notes										
		Ultra	Ready Mounts	Max Control\ LTV\ ProGuard\ Guardian	Strut Cushion\ Strut Mount\ Dampers\ Stabilizer	HiJackers\ Load Carrier\ Classic	Ultra	Ready Mounts	Max Control\ LTV\ ProGuard\ Guardian	Strut Cushion\ Strut Mount\ Dampers\ Stabilizer	HiJackers\ Load Carrier\ Classic

KIA

KIA

SPORTAGE

11-16	AWD
05-10	Left	G56819	G57218 ⁴⁰
	Right	G56820	G57219 ⁴⁰
00-02	All
95-99	All	143064 ⁵¹

LAND ROVER

LAND ROVER

DISCOVERY

94-99	Exc. Series II	G63506
-------	----------------	--------	------	------	------	------	------	------	------	------	------

RANGE ROVER

94-95	Air(RearSpringType)	G63506
95	All	G63615
94	Coil(RearSpringType)	G63615

LEISURE TRAVEL

LEISURE TRAVEL

WONDER

19-22	MotorHomes with Ford Transit-350 Chassis
-------	--	------	------	------	------	------	------	------	------	------	------

LEXUS

LEXUS

ES250

90-91	All	143061 ⁵¹ 143281 ⁵³	143061 ⁵¹
-------	-----	------	------	------	------	--	------	------	------	------	----------------------	------



ES300

02-03	Left	G57041 ⁴⁰	G57043 ⁴⁰	
	Right	G57042 ⁴⁰	G57044 ⁴⁰
03	Exc. Electronic Adjustable Suspension	143202 ⁵⁴	
02	All	143057 ⁵¹	
	Exc. Electronic Adjustable Suspension	143202 ⁵⁴	143057 ⁵¹	
	Left Exc. Electronic Adjustable Suspension	
	Right Exc. Electronic Adjustable Suspension	
97-01	All	143057 ⁵¹	143057 ⁵¹	
	Left Exc. Electronic Adjustable Suspension	G56506	G56930 ⁴⁰	142650 ⁵⁴	G56675	G56932 ⁴⁰
	Right Exc. Electronic Adjustable Suspension	G56514	G56931 ⁴⁰	142649 ⁵⁴	G56676	G56933 ⁴⁰
95-96	All	M56502	142836 ⁵⁴ 143057 ⁵¹	143057 ⁵¹	
	Left	G56675	

40 Complete Assembled Unit;

51 Strut Cushion for use with the Strut/Cartridge/Shocks.;

APPLICATION GUIDE

Year	Fitment Notes										
		Ultra	Ready Mounts	Max Control\ LTV\ ProGuard\ Guardian	Strut Cushion\ Strut Mount\ Dampers\ Stabilizer	HiJackers\ Load Carrier\ Classic	Ultra	Ready Mounts	Max Control\ LTV\ ProGuard\ Guardian	Strut Cushion\ Strut Mount\ Dampers\ Stabilizer	HiJackers\ Load Carrier\ Classic

LEXUS

LEXUS

ES300 (cont)

95-96	Right	G55676
92-96	Left Exc. Electronic Adjustable Suspension	G56932 ⁴⁰
	Right Exc. Electronic Adjustable Suspension	G56933 ⁴⁰
92-94	All	142561 ⁵⁴ 143057 ⁵¹	143057 ⁵¹
	Left Sealed OE Struts	G55675
	Right Sealed OE Struts	G55676

ES330

04-06	Exc. Adaptive Variable Suspension	143202 ⁵⁴
	Left	G57076 ⁴⁰	G57078 ⁴⁰
	Left Exc. Adaptive Variable Suspension	G56721	G56728
	Right	G57077 ⁴⁰	G57079 ⁴⁰
	Right Exc. Adaptive Variable Suspension	G56722	G56729

ES350

07-12	Left	G57190 ⁴⁰	G52103
	Right	G57191 ⁴⁰	G52104

GS300

98-05	All	G56598	143408 ⁶⁷
-------	-----	--------	-------	-------	-------	-------	-------	-------	-------	----------------------	-------

GS400

98-00	All	G56598	143408 ⁶⁷
-------	-----	--------	-------	-------	-------	-------	-------	-------	-------	----------------------	-------

GS430

01-05	All	G56598	143408 ⁶⁷
-------	-----	--------	-------	-------	-------	-------	-------	-------	-------	----------------------	-------

IS250

14-15	RWD, Left	G51920
	RWD, Right	G51921
06-13	RWD, Left	G51920	G51922
	RWD, Right	G51921	G51922

IS300

01-05	All	143408 ⁶⁷
-------	-----	-------	-------	-------	-------	-------	-------	-------	-------	----------------------	-------

IS350

14-15	RWD, Left	G51920
-------	-----------	--------	-------	-------	-------	-------	-------	-------	-------	-------	-------



40 Complete Assembled Unit.;

54 Kit with Mount and Bearing. Hardware from O.E. Part may need to be reused.;

51 Strut Cushion for use with the Strut/Cartridge/Shocks.;

67 Mount Kit. Hardware from O.E. Part may need to be reused.;



APPLICATION GUIDE

Year	Fitment Notes										
		Ultra	Ready Mounts	Max Control LTV ProGuard Guardian	Strut Cushion\ Strut Mount\ Dampers\ Stabilizer	HiJackers\ Load Carrier\ Classic	Ultra	Ready Mounts	Max Control LTV ProGuard Guardian	Strut Cushion\ Strut Mount\ Dampers\ Stabilizer	HiJackers\ Load Carrier\ Classic





LEXUS

LEXUS

IS350 (cont)

14-15	RWD, Right		G51921
06-13	RWD, Left		G51920	G51922
	RWD, Right		G51921	G51922

LS400

96-00	All	
	Exc. Rough Road Package		G57421 ⁴⁰
95	All		G57421 ⁴⁰	G57420 ⁴⁰
90-94	All		G57421 ⁴⁰
	Exc. Auto-Leveling System		143197 ⁵³



LS430

01-06	All		G51832	G51833
-------	-----	---	--------	------	------	------	------	------	--------	------

LX450

96-97	All		G63615	G63616
-------	-----	---	--------	------	------	------	------	------	--------	------





LX470

07	All		G63832	G63828
98-06	Torsion Bar(FrontSpringType)		G63832	G63828







NX200T

15-17	All		G64151
-------	-----	---	------	------	------	------	------	------	--------	------

RX300

99-03	Left		142650 ⁵⁴
	Right		142649 ⁵⁴
	FWD, Left		G57612 ⁴⁰
	FWD, Right		G57613 ⁴⁰

RX330

04-06	All		143202 ⁵⁴
	Left Exc. Air Suspension		G56730	143387 ⁶⁷
	Right Exc. Air Suspension		G56731	143388 ⁶⁷
	AWD, Left		G57150 ⁴⁰
	AWD, Left Exc. Air Suspension		G56732
	AWD, Left Non Japan built applications with a clevice mounting hole dimension of 15mm		G57152 ⁴⁰



40 Complete Assembled Unit;

53 Hardware from O.E. Part may need to be reused.;

134 54 Kit with Mount and Bearing. Hardware from O.E. Part may need to be reused.;

67 Mount Kit. Hardware from O.E. Part may need to be reused.;

APPLICATION GUIDE

Year	Fitment Notes										
		Ultra	Ready Mounts	Max Control\ LTV\ ProGuard\ Guardian	Strut Cushion\ Strut Mount\ Dampers\ Stabilizer	HiJackers\ Load Carrier\ Classic	Ultra	Ready Mounts	Max Control\ LTV\ ProGuard\ Guardian	Strut Cushion\ Strut Mount\ Dampers\ Stabilizer	HiJackers\ Load Carrier\ Classic

LEXUS

LEXUS

RX330 (cont)

04-06	AWD, Right	G57151 ⁴⁰
	AWD, Right Exc. Air Suspension	G56733
	AWD, Right Non Japan built applications with a clevice mounting hole dimension of 15mm	G57153 ⁴⁰
	FWD, Left	G57533 ⁴⁰
	FWD, Left Exc. Air Suspension	G56734
	FWD, Right	G57534 ⁴⁰
	FWD, Right Exc. Air Suspension	G56735

RX350

15-17	All	G64163
11-14	Left	G57562 ⁴⁰	G64163
	Right	G57563 ⁴⁰	G64163
10	Left	G57562 ⁴⁰
	Right	G57563 ⁴⁰
07-09	Left Exc. Air Suspension	G56730	143387 ⁶⁷
	Right Exc. Air Suspension	G56731	143388 ⁶⁷
	AWD, Left Non Japan built applications with a clevice mounting hole dimension of 15mm	G57152 ⁴⁰
	AWD, Right Non Japan built applications with a clevice mounting hole dimension of 15mm	G57153 ⁴⁰
	FWD, Left	G57150 ⁴⁰	G57533 ⁴⁰
	FWD, Left Exc. Air Suspension	G56734
	FWD, Right	G57151 ⁴⁰	G57534 ⁴⁰
FWD, Right Exc. Air Suspension	G56735	
07	AWD, Left Exc. Air Suspension	G56732
	AWD, Right Exc. Air Suspension	G56733

RX400H



08	Left	143387 ⁶⁷
	Right	143388 ⁶⁷
06-07	Left	143202 ⁵⁴	143387 ⁶⁷

40 Complete Assembled Unit.;

67 Mount Kit. Hardware from O.E. Part may need to be reused.;

54 Kit with Mount and Bearing. Hardware from O.E. Part may need to be reused.;

APPLICATION GUIDE

Year	Fitment Notes										
		Ultra	Ready Mounts	Max Control\ LTV\ ProGuard\ Guardian	Strut Cushion\ Strut Mount\ Dampers\ Stabilizer	HiJackers\ Load Carrier\ Classic	Ultra	Ready Mounts	Max Control\ LTV\ ProGuard\ Guardian	Strut Cushion\ Strut Mount\ Dampers\ Stabilizer	HiJackers\ Load Carrier\ Classic

LEXUS

LEXUS

RX400H (cont)

06-07	Right	↓	143202 ⁵⁴	↓	143388 ⁶⁷
06	FWD, Left	↓	↓	G57586 ⁴⁰
	FWD, Right	↓	↓	G57587 ⁴⁰

SC430

02-07	All	↓	G56598	↓
05	Mfg to 0/05; For Large Spring Seat Design 134MM or 5.275 Inches	↓	↓	G51995
02-04	For Large Spring Seat Design 134MM or 5.275 Inches	↓	↓	G51995

LINCOLN

LINCOLN

CAPRI

52-54	All	↓	82026	↓	61676 81481	49203 ⁷
-------	-----	---	------	------	------	------	-------	---	------	------	----------------	------	--------------------

CONTINENTAL

82-87	All	↓	143059 ⁵¹	↓
70-80	All	↓	69675 ⁵	81446	34073 ⁸	↓	69606	81495	43140 ⁸ 49205 ⁷
61-69	All	↓	82615	↓

COSMOPOLITAN

52-54	All	↓	82026	↓	61676 81481	49203 ⁷
-------	-----	---	------	------	------	------	-------	---	------	------	----------------	------	--------------------

MARK III

68-71	All	↓	69675 ⁵	81446	34073 ⁸	↓	69606	81495	43140 ⁸ 49205 ⁷
-------	-----	---	--------------------	------	-------	------	--------------------	---	-------	------	-------	------	--

MARK IV

73-76	All	↓	69675 ⁵	81446	34073 ⁸	↓
72	All	↓	69675 ⁵	81446	34073 ⁸	↓	69606	81495	43140 ⁸ 49205 ⁷

MARK LT

10-12	All	↓	↓	G64079
	AWD	↓	G51864	↓
06-08	4WD	↓	G51704	G57020 ⁴⁰	↓	G63867
	RWD	↓	G51703	G57021 ⁴⁰	↓	G63870

MARK V

77-79	All	↓	69675 ⁵	81446	34073 ⁸	↓
-------	-----	---	--------------------	------	-------	------	--------------------	---	------	------	------	------	------

MARK VI

80-83	All	↓	69675 ⁵	81446	34073 ⁸	↓	69606	81495	43140 ⁸ 49205 ⁷
-------	-----	---	--------------------	------	-------	------	--------------------	---	-------	------	-------	------	--

5 Use kit No. 140719 to replace O.E. hardware for lower shock absorber mounting when studs break or self-tapping screws are not longer useable.;

8 Pair Packs.;



51 Strut Cushion for use with the Strut/Cartridge/Shocks.;

7 Pair Packs, Air hose kit included.;

40 Complete Assembled Unit.;

54 Kit with Mount and Bearing. Hardware from O.E. Part may need to be reused.;

APPLICATION GUIDE

Year	Fitment Notes										
		Ultra	Ready Mounts	Max Control\ LTV\ ProGuard\ Guardian	Strut Cushion\ Strut Mount\ Dampers\ Stabilizer	HiJackers\ Load Carrier\ Classic	Ultra	Ready Mounts	Max Control\ LTV\ ProGuard\ Guardian	Strut Cushion\ Strut Mount\ Dampers\ Stabilizer	HiJackers\ Load Carrier\ Classic

LINCOLN

LINCOLN

MARK VII

84-92	All	143059 ⁵¹
-------	-----	-------	-------	-------	----------------------	-------	-------	-------	-------	-------

MKS

09-12	All	70096
	Left w/ Suspension Code A and B	G52398
	Right w/ Suspension Code A and B	G52399

MKT

10-17	All	G51996
-------	-----	-------	-------	-------	-------	-------	--------	-------	-------	-------

MKX

16-18	Left	G57752 ⁴⁰
	Right	G57753 ⁴⁰
15	Left	G52351	G64111
	Right	G52352	G64111
11-14	Left	G52351	G57582 ⁴⁰	G64111
	Right	G52352	G57583 ⁴⁰	G64111
10	Left	G56840	143415 ⁵³
	Right	G56841	143415 ⁵³
07-09	Left	G56840	143415 ⁵³	G64037
	Right	G56841	143415 ⁵³	G64037

MKZ

10-12	Left	G51896	G57427 ⁴⁰
	Right	G51897	G57427 ⁴⁰
07-12	FWD	69591
07-09	All	G51859

NAVIGATOR



14-20	Exc. Adaptive Suspension	G57683 ⁴⁰
17	Exc. Air Suspension	G51861	G57173 ⁴⁰
14-16	Exc. Air Suspension	G51861
10-16	4WD, RWD, Exc. Air Suspension	G57173 ⁴⁰
10-13	Exc. Air Suspension	G57172 ⁴⁰	G51861
07-13	All	G51860

40 Complete Assembled Unit.;

53 Hardware from O.E. Part may need to be reused.;

51 Strut Cushion for use with the Strut/Cartridge/Shocks.;

APPLICATION GUIDE

Year	Fitment Notes										
		Ultra	Ready Mounts	Max Control LTV ProGuard Guardian	Strut Cushion\ Strut Mount\ Dampers\ Stabilizer	HiJackers\ Load Carrier\ Classic	Ultra	Ready Mounts	Max Control LTV ProGuard Guardian	Strut Cushion\ Strut Mount\ Dampers\ Stabilizer	HiJackers\ Load Carrier\ Classic

LINCOLN

LINCOLN

NAVIGATOR (cont)

07-09	Exc. Air Suspension	↓	↓	G51861
06	All	↓	G57015 ⁴⁰	↓	G51729	G57016 ⁴⁰
03-05	All	↓	G57015 ⁴⁰	143244 ⁵³	↓	G51729	G57016 ⁴⁰
98-02	4WD, Air(RearSpringType)	↓	↓	G64002	61703
	Coil(FrontSpringType)	↓	61611	↓
	RWD	↓	G63714	58714 77714 81912	↓	G63717	61614 77717

TOWN CAR

03-11	Limo Models	↓	G51888	↓	69574
	Exc. Limo	↓	G51887	G57080 ⁴⁰	143357 ⁶⁷	↓	69575
81-02	All	↓	69675 ⁵	81446	↓	69606	81495	43140 ⁸ 49205 ⁷

VERSAILLES

77-80	All	↓	81491	↓	82130
-------	-----	---	------	------	-------	------	---	------	------	------	------	-------

ZEPHYR

06	All	↓	G51859	↓	69591
----	-----	---	--------	------	------	------	---	-------	------	------	------	------

MAZDA

MAZDA

2

11-14	All	↓	↓	70052
-------	-----	---	------	------	------	------	---	-------	------	------	------	------

3

14-17	All	↓	↓	70207
12-13	All	↓	↓	G51983
10-13	Mazdaspeed; Exc. Turbo Left	↓	G52449	↓
	Mazdaspeed; Exc. Turbo Right	↓	G52450	↓
13	Exc. Mazdaspeed Left	↓	G52005	↓
	Exc. Mazdaspeed Right	↓	G52006	↓
12	Exc. Mazdaspeed Left	↓	G52005	143365 ⁶⁷	↓
	Exc. Mazdaspeed Right	↓	G52006	143365 ⁶⁷	↓
10-11	All	↓	↓	G51983	143531 ⁵³
	Exc. Mazdaspeed Left	↓	G52005	143365 ⁵³	↓
	Exc. Mazdaspeed Right	↓	G52006	143365 ⁵³	↓
07-09	All	↓	↓	143531 ⁵³

5 Use kit No. 140719 to replace O.E. hardware for lower shock absorber mounting when studs break or self-tapping screws are not longer useable.;



8 Pair Packs.;

7 Pair Packs, Air hose kit included.;

40 Complete Assembled Unit.;

67 Mount Kit. Hardware from O.E. Part may need to be reused.;

APPLICATION GUIDE

Year	Fitment Notes										
		Ultra	Ready Mounts	Max Control\ LTV\ ProGuard\ Guardian	Strut Cushion\ Strut Mount\ Dampers\ Stabilizer	HiJackers\ Load Carrier\ Classic	Ultra	Ready Mounts	Max Control\ LTV\ ProGuard\ Guardian	Strut Cushion\ Strut Mount\ Dampers\ Stabilizer	HiJackers\ Load Carrier\ Classic

MAZDA

MAZDA

3 (cont)

07-09	Exc. Mazdaspeed	143365 ⁵³	IO	70003
	Exc. Mazdaspeed; Turbo w/17" Wheels Left	G52005
	Exc. Mazdaspeed; Turbo w/17" Wheels Right	G52006
	Mazdaspeed; Exc. Turbo w/17" Wheels Left	G52449
	Mazdaspeed; Exc. Turbo w/17" Wheels Right	G52450
05-06	All	IO	70003	143531 ⁵³
04-06	Exc. Mazdaspeed Left	G52005	143365 ⁵³
	Exc. Mazdaspeed Right	G52006	143365 ⁵³
04	All	IO	70003	143531 ⁶⁷

5

06-10	Left	G52005	143365 ⁶⁷	IO	70003	143531 ⁵³
	Right	G52006	143365 ⁶⁷	IO	70003	143531 ⁵³

6

09-13	Left	G57455 ⁴⁰
	Right	G57456 ⁴⁰
	i, Left	G57594 ⁴⁰
	i, Right	G57595 ⁴⁰
03-08	All	G57270 ⁴⁰	IO	69591

323

90-94	All	143057 ⁵¹	M55848
86-89	FWD	143058 ⁵¹	143058 ⁵¹

626

98-02	All	143218 ⁵³
93-97	All	143057 ⁵¹
88-92	Exc. Electronic Adjustable Suspension or 4 Wheel Steer	143057 ⁵¹
	Automatic Exc. Electronic Adjustable Suspension or 4 Wheel Steer	142569 ⁶¹ 142852 ⁵⁴
86-87	Automatic Exc. Electronic Adjustable Suspension	143057 ⁵¹	143057 ⁵¹
83-85	All	143057 ⁵¹	143057 ⁵¹

40 Complete Assembled Unit.;

53 Hardware from O.E. Part may need to be reused.;



61 Mount Kit includes Upper Spring Seat. Hardware from O.E. Part may need to be reused.;

51 Strut Cushion for use with the Strut/Cartridge/Shocks.;

54 Kit with Mount and Bearing. Hardware from O.E. Part may need to be reused.;

67 Mount Kit. Hardware from O.E. Part may need to be reused.;

APPLICATION GUIDE

Year	Fitment Notes										
		Ultra	Ready Mounts	Max Control\ LTV\ ProGuard\ Guardian	Strut Cushion\ Strut Mount\ Dampers\ Stabilizer	HiJackers\ Load Carrier\ Classic	Ultra	Ready Mounts	Max Control\ LTV\ ProGuard\ Guardian	Strut Cushion\ Strut Mount\ Dampers\ Stabilizer	HiJackers\ Load Carrier\ Classic

MAZDA

MAZDA

808

72-77	Wagon Exc. Models w/ Tokico OE Struts	⌚	⌚	81270
-------	---------------------------------------	---	-------	-------	-------	-------	---	-------	-------	-------	-------	-------

B1600

72-76	All	⌚	G63421	58421 61504 81750	⌚	82125
-------	-----	---	--------	-------	-------------------------	-------	-------	---	-------	-------	-------	-------	-------

B1800

77-78	All	⌚	G63421	58421 61504 81750	⌚	82125
-------	-----	---	--------	-------	-------------------------	-------	-------	---	-------	-------	-------	-------	-------

B2000

86-87	RWD	⌚	G63495	61593 81553	⌚	G63907	61500 77907 81147	43048 ⁸ 49310 ⁷
79-84	All	⌚	G63421	58421 61504 81750	⌚	82125

B2200

87-93	RWD	⌚	G63495	61593 81553	⌚	G63907	61500 77907 81147	43048 ⁸ 49310 ⁷
82-84	All	⌚	G63421	58421 61504 81750	⌚	82125

B2300

07-09	RWD, Coil(FrontSpringType)	⌚	⌚	G63773	81917
01-09	RWD	⌚	G63772	61626 77772 81916	⌚	61627 77525
01-06	RWD, Coil(FrontSpringType)	⌚	⌚	G63773	81917	43167 ⁸ 49223 ⁷
94-97	All	⌚	G63614	58929 61561 77614 81744 ⁸	34076 ⁸	⌚
	RWD	⌚	⌚	G63525	61627 77525 81730	49223 ⁷
	RWD, Coil(FrontSpringType)	⌚	⌚	G63773	81917
95-96	4WD	⌚	⌚	G63524	61573 77524 81905

B2500

98-01	Coil(FrontSpringType)	⌚	⌚	G63773	81917
	RWD	⌚	G63772	61626 77772 81916	⌚
	RWD, Coil(FrontSpringType)	⌚	⌚	61627 77525	43167 ⁸ 49223 ⁷



B2600

87-93	4WD	⌚	G63635	⌚
	RWD	⌚	G63495	61593 81553	⌚	G63907	61500 77907 81147	43048 ⁸ 49310 ⁷

B3000

98-07	RWD	⌚	G63772	61626 77772 81916	⌚
	Torsion Bar(FrontSpringType)	⌚	G63678	61623 77678 81893	⌚	G63775	61629 77524 81918

APPLICATION GUIDE

Year	Fitment Notes										
		Ultra	Ready Mounts	Max Control\ LTV\ ProGuard\ Guardian	Strut Cushion\ Strut Mount\ Dampers\ Stabilizer	HiJackers\ Load Carrier\ Classic	Ultra	Ready Mounts	Max Control\ LTV\ ProGuard\ Guardian	Strut Cushion\ Strut Mount\ Dampers\ Stabilizer	HiJackers\ Load Carrier\ Classic

MAZDA

MAZDA

B3000 (cont)

94-07	RWD; Coil (FrontSpringType)		OO	81917
07	RWD, Coil(FrontSpringType)		OO	G63773	61627 77525
03-06	RWD, Coil(FrontSpringType)		OO	G63773	61627 77525	43167 ⁸ 49223 ⁷
98-01	RWD, Coil(FrontSpringType)		OO	G63773	61627 77525	43167 ⁸ 49223 ⁷
94-97	All	IO	G63614	61561 81744 ⁴⁸	OO
	4WD		OO	G63524	81905
	RWD	IO	77614	OO	G63525	81730
	RWD, Coil(FrontSpringType)		OO	G63773	61627 77525

B4000

07-09	RWD	IO	61626 77772 81916	OO
98-09	RWD; Coil (FrontSpringType)		OO	61627 81917
	Torsion Bar(FrontSpringType)	IO	G63678	61623 77678 81893	OO	G63775	61629 77524 81918
98-06	RWD	IO	G63772	61626 77772 81916	OO
	RWD; Coil (FrontSpring Type)		OO	43167 ⁸ 49223 ⁷
94-00	RWD, Coil(FrontSpringType)		OO	G63773	77525
94-97	All	IO	G63614	81744 ⁴⁸	OO
	4WD		OO	G63524	81905
	RWD	IO	61561 77614	OO	G63525	61627
	RWD; Coil (FrontSpringType)		OO	81917

CX-5

13-18	All	IO	OO	G511078
-------	-----	----	------	------	------	------	----	---------	------	------	------	------

CX-7

07-10	Left		G52209	OO	G64056
	Right		G52210	OO	G64056



CX-9

07-15	Left		G52260
	Right		G52261

GLC

84-85	All		143057 ⁵¹
	Hatchback		143059 ⁵¹	
	Sedan		143059 ⁵¹	
81-83	Hatchback		143059 ⁵¹		143057 ⁵¹

APPLICATION GUIDE

Year	Fitment Notes										
		Ultra	Ready Mounts	Max Control LTV ProGuard Guardian	Strut Cushion\ Strut Mount\ Dampers\ Stabilizer	HiJackers\ Load Carrier\ Classic	Ultra	Ready Mounts	Max Control LTV ProGuard Guardian	Strut Cushion\ Strut Mount\ Dampers\ Stabilizer	HiJackers\ Load Carrier\ Classic

MAZDA

MAZDA

GLC (cont)

81-83	Sedan	↑	143059 ⁵¹	↑	143057 ⁵¹
79-83	Wagon	↑	↑	81270	49105 ⁷
78	All	↑	↑	81270	49105 ⁷

MIATA

04-05	Base, LS	↑	↑	G56597
03	Base, LS, SE	↑	↑	G56597
99-01	All	↑	↑	G56597
91-97	Non-ABS	↑	↑	143064 ⁵¹
90	All	↑	↑	143064 ⁵¹

MPV

00-06	All	↑	143061 ⁵¹	○	G63864
-------	-----	---	------	------	------	----------------------	------	---	--------	------	------	------	------

MX-5 MIATA

06-08	All	↑	143412 ⁶⁷	↑	143412 ⁶⁷
-------	-----	---	------	------	------	----------------------	------	---	------	------	------	----------------------	------

MX6

88-97	All	↑	↑	143057 ⁵¹
89-92	Automatic	↑	142569 ⁶¹	↑
88-92	Automatic Exc. Electronic Adjustable Suspension or 4 Wheel Steer	↑	142852 ⁵⁴	↑

NAVAJO

91-94	All	○	G63608	58929 61591 77608 81744 ⁴⁸	34076 ⁸	○	G63607	61590 77607
	Steering Stabilizer	○	6802SE ⁸⁴										

PROTG / PROTG5

02-03	Left	↑	↑	G56538
	Right	↑	↑	G56537
01-03	Exc. MP3 and Mazdaspeed Models Left	↑	↑	G56538
	Exc. MP3 and Mazdaspeed Models Right	↑	↑	G56537
00-03	All	↑	143057 ⁵¹	↑	143058 ⁵¹
	Left Mfg. from 10/00	↑	G56634	↑
	Right Mfg. from 10/00	↑	G56633	↑
00	Left	↑	↑	G56538

7 Pair Packs, Air hose kit included.;

48 Installation Hardware Included;

54 Kit with Mount and Bearing. Hardware from O.E. Part may need to be reused.;

142 67 Mount Kit. Hardware from O.E. Part may need to be reused.;



8 Pair Packs.;

51 Strut Cushion for use with the Strut/Cartridge/Shocks.;

61 Mount Kit includes Upper Spring Seat. Hardware from O.E. Part may need to be reused.;

84 Replacement damper for vehicles with the Gabriel Aftermarket mounting kit;

APPLICATION GUIDE

Year	Fitment Notes										
		Ultra	Ready Mounts	Max Control\ LTV\ ProGuard\ Guardian	Strut Cushion\ Strut Mount\ Dampers\ Stabilizer	HiJackers\ Load Carrier\ Classic	Ultra	Ready Mounts	Max Control\ LTV\ ProGuard\ Guardian	Strut Cushion\ Strut Mount\ Dampers\ Stabilizer	HiJackers\ Load Carrier\ Classic

MAZDA

MAZDA

PROTG / PROTG5 (cont)

00	Right			G56537
99	Left		143057 ⁵¹	G56538	143058 ⁵¹
	Right		143057 ⁵¹	G56537	143058 ⁵¹
92-98	All		143057 ⁵¹	143058 ⁵¹
90-94	FWD, Non-ABS		M55848
90-91	All		143057 ⁵¹
	FWD		143058 ⁵¹

RX3

75-76	Wagon Exc. Models w/ Tokico OE Struts		49105 ⁷
74-76	Wagon		81270
74	All		49105 ⁷
72-73	All		81270	49105 ⁷

RX4

74-78	All		81270	49105 ⁷
-------	-----	--	------	------	------	------	------	------	------	-------	------	--------------------

RX7

86-91	All		143059 ⁵¹	143063 ⁵¹
-------	-----	--	------	------	------	----------------------	------	------	------	------	----------------------	------

TRIBUTE

08-11	Left		G56601	G57045 ⁴⁰		G64047
	Right		G56568	G57046 ⁴⁰	G64047
01-06	Left		G56601	G57045 ⁴⁰	69900 G63862
	Right		G56568	G57046 ⁴⁰	69900 G63862

MERCEDES-BENZ

MERCEDES-BENZ

190SL

62-63	All		82069
-------	-----	--	------	------	------	------	------	------	------	------	------	-------

200D

68-73	All		69766
-------	-----	--	------	------	------	------	------	------	-------	------	------	------



220 / 220D

68-73	All		69766
-------	-----	--	------	------	------	------	------	------	-------	------	------	------

230

77-78	Exc. W115		69996
74-78	All		69766
68-69	All		69766

APPLICATION GUIDE

Year	Fitment Notes										
		Ultra	Ready Mounts	Max Control LTV ProGuard Guardian	Strut Cushion\ Strut Mount\ Dampers\ Stabilizer	HiJackers\ Load Carrier\ Classic	Ultra	Ready Mounts	Max Control LTV ProGuard Guardian	Strut Cushion\ Strut Mount\ Dampers\ Stabilizer	HiJackers\ Load Carrier\ Classic

MERCEDES-BENZ

MERCEDES-BENZ

240D

76-83	W123	69996	69766
74-83	All	69766

250

68-70	All	69766
-------	-----	-----	-----	-----	-----	-----	-------	-----	-----	-----	-----

260E

87-89	Exc. Hydromat Suspension	69996	69766
-------	--------------------------	-------	-----	-----	-----	-----	-------	-----	-----	-----	-----

280

76	All	69996	69766
----	-----	-------	-----	-----	-----	-----	-------	-----	-----	-----	-----

280C

73-76	All	69766
76	Exc. W115	69996

280CE / 280E / 280S / 280SE / 280SEL

77-81	All	69996	69766
75-80	Exc. Hydromat Suspension	69996	69766
73	Exc. Hydromat Suspension	69996	69766
72	Mfg. from 9/72; Exc. Hydromat Suspension	69996	69766

300CD

80-85	All	69996	69766
-------	-----	-------	-----	-----	-----	-----	-------	-----	-----	-----	-----

300D

76-84	W123	69996	69766
75	W123	69766

300SD / 300SDL / 300SE / 300SEL / 300TD / 350SD / 350SDL / 350SL / 380SE / 380SEC / 380SEL

78-91	Exc. Hydromat Suspension	69996	69766
79-85	All	69996
72	All	69766

380SL / 380SLC

81-85	All	69766
-------	-----	-----	-----	-----	-----	-----	-------	-----	-----	-----	-----

400E / 400SE / 400SEL / 420SEL / 450SE / 450SEL

86-91	Exc. Hydromat Suspension	69996	69766
73-80	Exc. Hydromat Suspension	69996	69766

450SL / 450SLC

74-80	All	69766
-------	-----	-----	-----	-----	-----	-----	-------	-----	-----	-----	-----



500SEC / 500SEL / 500SEC / 560SEC / 560SEL

84-91	Exc. Hydromat Suspension	69996	69766
-------	--------------------------	-------	-----	-----	-----	-----	-------	-----	-----	-----	-----

C230

02-07	All	70033
	RWD; Exc. Sport Suspension	G56791
	RWD; w/ Sport Suspension	G56792

APPLICATION GUIDE

Year	Fitment Notes										
		Ultra	Ready Mounts	Max Control\ LTV\ ProGuard\ Guardian	Strut Cushion\ Strut Mount\ Dampers\ Stabilizer	HiJackers\ Load Carrier\ Classic	Ultra	Ready Mounts	Max Control\ LTV\ ProGuard\ Guardian	Strut Cushion\ Strut Mount\ Dampers\ Stabilizer	HiJackers\ Load Carrier\ Classic

MERCEDES-BENZ

MERCEDES-BENZ

C240

01-05	RWD	70033
	RWD; Exc. Sport Suspension	G56791
	RWD; w/ Sport Suspension	G56792

C250

13-15	Exc. Electronic Suspension	70038
12	All	70038
	CGI(FuelDelSubType), Sedan	G52172
10-11	All	G52172	70038

C280

08-09	All	G52172	70038
06-07	RWD	70033
	RWD; Exc. Sport Suspension	G56791
	RWD; w/ Sport Suspension	G56792

C300

08-11	All	70038
11	Elegance, Luxury	G52172
10	Base, Classic, Elegance, Luxury	G52172
08-09	Base, Luxury	G52172



C320

01-05	RWD	70033
	RWD Sedan & Wagon; Exc. Sport Suspension	G56791
	RWD; w/ Sport Suspension	G56792

C350

12	Base	G52172
	CGI(FuelDelSubType)	70038
09-11	All	70038
10	Base	G52172
09	Base, Elegance	G52172
08	All	G52172	70038
	Base	G52172
06-07	Exc. AWD & Sport Suspension	G56791
	RWD	70033
	RWD; w/ Sport Suspension	G56792

APPLICATION GUIDE

Year	Fitment Notes										
		Ultra	Ready Mounts	Max Control LTV ProGuard Guardian	Strut Cushion\ Strut Mount\ Dampers\ Stabilizer	HiJackers\ Load Carrier\ Classic	Ultra	Ready Mounts	Max Control LTV ProGuard Guardian	Strut Cushion\ Strut Mount\ Dampers\ Stabilizer	HiJackers\ Load Carrier\ Classic

MERCEDES-BENZ

MERCEDES-BENZ

CLK320

03-05	All	70033
02-05	RWD; Exc. Sport Suspension	G56791
	RWD; w/ Sport Suspension	G56792
98-02	All	70064	70065

CLK350

06-09	All	70033
	RWD; Exc. Sport Suspension	G56791
	RWD; w/ Sport Suspension	G56792

CLK430

02-03	RWD; Exc. Sport Suspension	G56791
	RWD; w/ Sport Suspension	G56792
03	All	70033
02	All	70064
	Mfg. from 4/02	70033
	Mfg. to 4/02	70065
99-01	All	70064	70065

CLK500

03-06	All	70033
	RWD; Exc. Sport Suspension	G56791
	RWD; w/ Sport Suspension	G56792

CLK550

07-09	All	70033
	RWD; Exc. Sport Suspension	G56791

E55 AMG

00-02	All	69952
-------	-----	-------	-------	-------	-------	-------	-------	-------	-------	-------	-------

E300

96-99	Exc. Sport Suspension	69952
99	Exc. 4 Matic	69966
96-98	All	69966



E320

96-02	Sedan	69966
	Sedan Exc. Sport Suspension	69952

E420

97	All	69966
	Exc. 4 Matic & Sport Suspension	69952

APPLICATION GUIDE

Year	Fitment Notes										
		Ultra	Ready Mounts	Max Control\ LTV\ ProGuard\ Guardian	Strut Cushion\ Strut Mount\ Dampers\ Stabilizer	HiJackers\ Load Carrier\ Classic	Ultra	Ready Mounts	Max Control\ LTV\ ProGuard\ Guardian	Strut Cushion\ Strut Mount\ Dampers\ Stabilizer	HiJackers\ Load Carrier\ Classic

MERCEDES-BENZ

E430

98-02	All
	Exc. 4 Matic & Sport Suspension	69952

MERCEDES-BENZ

ML55 AMG

00-03	All	G64049
-------	-----	--------	-------	-------	-------	-------	-------	-------	-------	-------

ML320

98-03	All	G64049
-------	-----	--------	-------	-------	-------	-------	-------	-------	-------	-------

ML350

03-05	All	G64049
-------	-----	--------	-------	-------	-------	-------	-------	-------	-------	-------

ML430

99-01	All	G64049
-------	-----	--------	-------	-------	-------	-------	-------	-------	-------	-------

ML500

02-05	All	G64049
-------	-----	--------	-------	-------	-------	-------	-------	-------	-------	-------

S320 / S350 / S420 / S500 / S600

94-99	Exc. Electronic Ride Control
-------	------------------------------	-------	-------	-------	-------	-------	-------	-------	-------	-------

SLK230

98-04	All	70064
-------	-----	-------	-------	-------	-------	-------	-------	-------	-------	-------

SLK320

03-04	All	70064
01-02	170.465(MfrBodyCode)	70064

SPRINTER

07-10	All
04-06	All	G56778
	Exc. Dual Rear Wheels

SPRINTER 2500

10-18	All	G57802 ⁴⁰
-------	-----	-------	----------------------	-------	-------	-------	-------	-------	-------	-------

SPRINTER 3500

19-20	All
11-18	All	G57802 ⁴⁰
10	All	G57802 ⁴⁰

MERCURY

MERCURY

BOBCAT

75-80	All	82128
	Sedan	82004



BROUGHAM

67	All	69675 ⁵	81446	34073 ⁸	69606	81495	43140 ⁹ 49205 ⁷
----	-----	--------------------	-------	-------	-------	--------------------	-------	-------	-------	-------	--

5 Use kit No. 140719 to replace O.E. hardware for lower shock absorber mounting when studs break or self-tapping screws are not longer useable;
8 Pair Packs.;

7 Pair Packs, Air hose kit included.;
40 Complete Assembled Unit.;

APPLICATION GUIDE

Year	Fitment Notes										
		Ultra	Ready Mounts	Max Control\ LTV\ ProGuard\ Guardian	Strut Cushion\ Strut Mount\ Dampers\ Stabilizer	HiJackers\ Load Carrier\ Classic	Ultra	Ready Mounts	Max Control\ LTV\ ProGuard\ Guardian	Strut Cushion\ Strut Mount\ Dampers\ Stabilizer	HiJackers\ Load Carrier\ Classic

MERCURY

MERCURY

CAPRI

91-93	All	⌋	143057 ⁵¹	⌋	143059 ⁵¹
84-86	Position Rear	⊖	14039 ⁸⁵										
79-86	All	⌋	143059 ⁵¹	⌋

COLONY PARK

87-91	All	⌋	69675 ⁵	81446	34073 ⁸	⌋	69606	81495	43140 ⁸ 49205 ⁷
65-74	All	⌋	69675 ⁵	81446	34073 ⁸	⌋	69606	81495	43140 ⁸ 49205 ⁷
61-64	All	⌋	69625	34073 ⁸ 82099	⌋	82076
59-60	All	⌋	69625	34073 ⁸ 82099	⌋	81270	49105 ⁷
57-58	All	⌋	69625	34073 ⁸ 82099	⌋

COMET

71-77	All	⌋	81076	⊖	82130
68-69	All	⌋	82126	⌋	81270	49105 ⁷
66-67	All	⌋	82126	⌋
	Exc. Wagon	⌋	⌋	81270	49105 ⁷
	Wagon	⌋	⌋	69606	81495	43140 ⁸ 49205 ⁷
60-65	All	⌋	82126	⌋	81270	49105 ⁷

COMMUTER

65-68	All	⌋	69675 ⁵	81446	34073 ⁸	⌋	69606	81495	43140 ⁸ 49205 ⁷
64	All	⌋	69625	34073 ⁸ 82099	⌋	82076
61-62	All	⌋	69625	34073 ⁸ 82099	⌋	82076
59-60	All	⌋	69625	34073 ⁸ 82099	⌋	81270	49105 ⁷
57-58	All	⌋	69625	34073 ⁸ 82099	⌋

COUGAR

01-02	All	⌋	142843 ⁵⁴ 143061 ⁵¹	⌋	M55693	143058 ⁵¹
99-00	All	⌋	142843 ⁵⁴ 143061 ⁵¹	⌋	M55693	142402 ⁵³ 143058 ⁵¹
92-97	Exc. Electronic Adjustable Suspension	⌋	⌋	69845
84-88	Position Rear	⊖	14039 ⁸⁵										
80-88	All	⌋	143059 ⁵¹	⌋
74-79	All	⌋	69675 ⁵	81446	34073 ⁸	⌋	69606	81495	43140 ⁸ 49205 ⁷
71-73	All	⌋	81491	⌋	81270	49105 ⁷
67-70	All	⌋	81076	⌋	81270	49105 ⁷

5 Use kit No. 140719 to replace O.E. hardware for lower shock absorber mounting when studs break or self-tapping screws are not longer useable.;

8 Pair Packs.;



53 Hardware from O.E. Part may need to be reused.;

7 Pair Packs, Air hose kit included.;

51 Strut Cushion for use with the Strut/Cartridge/Shocks.;

54 Kit with Mount and Bearing. Hardware from O.E. Part may need to be reused.;

APPLICATION GUIDE

Year	Fitment Notes										
		Ultra	Ready Mounts	Max Control\ LTV\ ProGuard\ Guardian	Strut Cushion\ Strut Mount\ Dampers\ Stabilizer	HiJackers\ Load Carrier\ Classic	Ultra	Ready Mounts	Max Control\ LTV\ ProGuard\ Guardian	Strut Cushion\ Strut Mount\ Dampers\ Stabilizer	HiJackers\ Load Carrier\ Classic

MERCURY

MERCURY

COUNTRY CRUISER

63	All	⌋ ⊖	69625	34073 ⁸ 82099	⌋ ⊖	82076
59-60	All	⌋ ⊖	82099	⌋ ⊖	81270	49105 ⁷

CUSTOM

52-56	All	⌋ ⊖	82026	⌋ ⊖	82125
-------	-----	--------	------	------	------	------	-------	--------	------	------	------	------	------	-------

CYCLONE

68-71	All	⌋ ⊖	82126	⌋ ⊖	81270
-------	-----	--------	------	------	------	------	-------	--------	------	------	-------	------	------	------

GRAND MARQUIS

03-11	All	⌋ ⊖	G51887	G57080 ⁴⁰	143357 ⁶⁷	⌋ ⊖	69575
92-02	All	⌋ ⊖	69675 ⁵	81446	⌋ ⊖	69606	81495	43140 ⁸ 49205 ⁷
	Exc. Hydraulic Self-Leveling System	⌋ ⊖	34073 ⁸	⌋ ⊖
75-91	All	⌋ ⊖	69675 ⁵	81446	34073 ⁸	⌋ ⊖	69606	81495	43140 ⁸ 49205 ⁷

LN7

82-83	All	⌋ ⊖	143057 ⁵¹	⌋ ⊖	143059 ⁵¹
-------	-----	--------	------	------	------	------	----------------------	------	--------	------	------	------	----------------------	------

LYNX

81-87	All	⌋ ⊖	143057 ⁵¹	⌋ ⊖	143059 ⁵¹
-------	-----	--------	------	------	------	------	----------------------	------	--------	------	------	------	----------------------	------

MARAUDER

03-04	All	⌋ ⊖	G51888	G57080 ⁴⁰	⌋ ⊖	69575
69-70	All	⌋ ⊖	69675 ⁵	81446	34073 ⁸	⌋ ⊖	69606	81495	43140 ⁸ 49205 ⁷
65-67	All	⌋ ⊖	69675 ⁵	81446	34073 ⁸	⌋ ⊖	69606	81495	43140 ⁸ 49205 ⁷
63-64	All	⌋ ⊖	69625	34073 ⁸ 82099	⌋ ⊖	82076

MARINER

08-11	Left	⌋ ⊖	G56601	G57045 ⁴⁰	⌋ ⊖	G64047
	Right	⌋ ⊖	G56568	G57046 ⁴⁰	⌋ ⊖	G64047
05-07	Left	⌋ ⊖	G56601	G57045 ⁴⁰	⌋ ⊖	69900 G63862
	Right	⌋ ⊖	G56568	G57046 ⁴⁰	⌋ ⊖	69900 G63862

MARQUIS

83-86	All	⌋ ⊖	143059 ⁵¹	⌋ ⊖
67-82	All	⌋ ⊖	69675 ⁵	81446	34073 ⁸	⌋ ⊖	69606	81495	43140 ⁸ 49205 ⁷



MEDALIST

58	All	⌋ ⊖	69625	34073 ⁸ 82099	⌋ ⊖
56	All	⌋ ⊖	82026	⌋ ⊖	82125

5 Use kit No. 140719 to replace O.E. hardware for lower shock absorber mounting when studs break or self-tapping screws are not longer useable.;
8 Pair Packs.;
51 Strut Cushion for use with the Strut/Cartridge/Shocks.;

7 Pair Packs, Air hose kit included.;
40 Complete Assembled Unit.;
67 Mount Kit. Hardware from O.E. Part may need to be reused.;

APPLICATION GUIDE

Year	Fitment Notes										
		Ultra	Ready Mounts	Max Control LTV ProGuard Guardian	Strut Cushion\ Strut Mount\ Dampers\ Stabilizer	HiJackers\ Load Carrier\ Classic	Ultra	Ready Mounts	Max Control LTV ProGuard Guardian	Strut Cushion\ Strut Mount\ Dampers\ Stabilizer	HiJackers\ Load Carrier\ Classic

MERCURY

MERCURY

MERCURY

52	All	⊖	⊖	49311 ⁷
49-51	All	⊖	82026	⊖	81318	49311 ⁷ 82125

METEOR

62-63	All	⊖	82075	⊖	81270	49105 ⁷
-------	-----	---	------	------	------	-------	---	------	------	-------	------	--------------------

MILAN

10-11	Left	⊖	G51896	G57427 ⁴⁰	⊖
	Right	⊖	G51897	G57427 ⁴⁰	⊖
07-11	FWD	⊖	⊖	69591
07-09	AWD	⊖	G57148 ⁴⁰	⊖
06-09	All	⊖	G51859	⊖
06	FWD	⊖	G57148 ⁴⁰	⊖	69591

MONARCH

75-80	All	⊖	81491	⊖	82130
-------	-----	---	------	------	-------	------	------	---	------	------	------	-------

MONTCLAIR

65-68	All	⊖	69675 ⁵	81446	34073 ⁸	⊖	69606	81495	43140 ⁸ 49205 ⁷
64	All	⊖	69625	34073 ⁸ 82099	⊖	82076
59-60	All	⊖	69625	34073 ⁸ 82099	⊖	81270	49105 ⁷
57-58	All	⊖	69625	34073 ⁸ 82099	⊖
55-56	All	⊖	82026	⊖	82125

MONTEGO

05-07	Left	⊖	143341 ⁵³	⊖	143390 ⁵³
	Right	⊖	143341 ⁵³	⊖	143391 ⁵³
	FWD	⊖	⊖	G51849
72-76	All	⊖	69675 ⁵	81446	34073 ⁸	⊖	69606	43140 ⁸ 49205 ⁷
68-76	Wagon	⊖	⊖	81495
68-71	All	⊖	82126	⊖	69606
	Exc. Wagon	⊖	⊖	81270	49105 ⁷



MONTEREY

04-07	Mini Passenger Van	⊖	G56655	⊖	G63873
65-74	All	⊖	69675 ⁵	81446	34073 ⁸	⊖	69606	81495	43140 ⁸ 49205 ⁷
61-64	All	⊖	69625	34073 ⁸ 82099	⊖	82076
59-60	All	⊖	69625	34073 ⁸ 82099	⊖	81270	49105 ⁷

5 Use kit No. 140719 to replace O.E. hardware for lower shock absorber mounting when studs break or self-tapping screws are not longer useable.;
8 Pair Packs.;

7 Pair Packs, Air hose kit included.;
40 Complete Assembled Unit.;







APPLICATION GUIDE

Year	Fitment Notes										
		Ultra	Ready Mounts	Max Control\ LTV\ ProGuard\ Guardian	Strut Cushion\ Strut Mount\ Dampers\ Stabilizer	HiJackers\ Load Carrier\ Classic	Ultra	Ready Mounts	Max Control\ LTV\ ProGuard\ Guardian	Strut Cushion\ Strut Mount\ Dampers\ Stabilizer	HiJackers\ Load Carrier\ Classic









MERCURY

MERCURY



MONTEREY (cont)

57-58	All		69625	34073 ⁸ 82099	
52-56	All		82026		82125
50-51	All		82026		81318	49311 ⁷ 82125









MOUNTAINEER

06-10	All		G56838	G57095 ⁴⁰	143360 ⁵³		G56839	G57096 ⁴⁰	143361 ⁵³
04-05	All		G51723	G57019 ⁴⁰	143318 ⁵³		G51724	G57018 ⁴⁰	143319 ⁵³
02-03	All		G51722	G57017 ⁴⁰	143318 ⁵³		G51724	G57018 ⁴⁰	143319 ⁵³
97-01	Exc. Electronic Adjustable Suspension		G63678	61623 77678 81893		G63679	61624 77679 81890	43171 ⁸ 49232 ⁷





















MYSTIQUE

95-00	All		142843 ⁵⁴		M55693	142402 ⁵³
-------	-----	---	------	------	------	----------------------	------	---	------	------	--------	----------------------	------





PARKLANE

65-68	All		69675 ⁵	81446	34073 ⁸		69606	81495	43140 ⁸ 49205 ⁷
64	All		69625	34073 ⁸ 82099		82076
59-60	All		69625	82099		81270	49105 ⁷
58	All		69625	82099	

SABLE

08-09	FWD, Left		G52129	143415 ⁵³		G57449 ⁴⁰
	FWD, Right		G52130	143415 ⁵³		G57450 ⁴⁰
96-05	Left		G56934 ⁴⁰	142747 ⁵¹ 143059 ⁵¹	
	Right		G56937 ⁴⁰	142747 ⁵¹ 143059 ⁵¹	
	Sedan			G55901	G56936 ⁴⁰	M55901	143057 ⁵¹
	Wagon			69962
94-95	Sedan		142746 ⁵⁷		G55901	G56936 ⁴⁰	M55901	143057 ⁵¹
91-95	All		143059 ⁵¹	
91-93	Sedan		142746 ⁵⁷	
86-90	All		142746 ⁵⁷ 143059 ⁵¹	

TOPAZ

92-94	All			143059 ⁵¹
87-91	All		143059 ⁵¹		143059 ⁵¹

5 Use kit No. 140719 to replace O.E. hardware for lower shock absorber mounting when studs break or self-tapping screws are not longer useable.;

8 Pair Packs.;

51 Strut Cushion for use with the Strut/Cartridge/Shocks.;

54 Kit with Mount and Bearing. Hardware from O.E. Part may need to be reused.;

67 Mount Kit. Hardware from O.E. Part may need to be reused.;;



7 Pair Packs, Air hose kit included.;

40 Complete Assembled Unit.;

53 Hardware from O.E. Part may need to be reused.;

61 Mount Kit includes Upper Spring Seat. Hardware from O.E. Part may need to be reused.;

APPLICATION GUIDE

Year	Fitment Notes										
		Ultra	Ready Mounts	Max Control LTV ProGuard Guardian	Strut Cushion\ Strut Mount\ Dampers\ Stabilizer	HiJackers\ Load Carrier\ Classic	Ultra	Ready Mounts	Max Control LTV ProGuard Guardian	Strut Cushion\ Strut Mount\ Dampers\ Stabilizer	HiJackers\ Load Carrier\ Classic

MERCURY

MERCURY

TOPAZ (cont)

86	All						143059 ⁵¹
84-85	All		143057 ⁵¹				143059 ⁵¹

TRACER

97-99	FWD		143061 ⁵¹			M55848
91-96	FWD		143057 ⁵¹			M55848	143058 ⁵¹
87-89	FWD		143058 ⁵¹

TURNPIKE CRUISER

57	All		69625	34073 ⁸ 82099			
----	-----	--	-------	------	------	------	-----------------------------	--	--	--	------	------

VILLAGER

97-02	Non-ABS				G63299
93-98	Left		M55920	143057 ⁵¹
	Right		M55921	143057 ⁵¹
93-96	4-Wheel ABS				G63299
65-67	All		69675 ⁵	81446	34073 ⁸			69606	81495
62-64	All		69625	34073 ⁸ 82099		
												43140 ⁸ 49205 ⁷
												82076

VOYAGER

66-67	All		69675 ⁵	81446	34073 ⁸			69606	81495
59	All		69625	34073 ⁸ 82099			81270
57-58	All		69625	34073 ⁸ 82099		

ZEPHYR

78-83	All		143059 ⁵¹
-------	-----	--	------	------	------	----------------------	------	--	--	------	------	------

MINI

MINI

COOPER

13	Left		G52297			G51934
	Right		G52298			G51934
12	Left		G52297	143491 ⁵³			G51934
	Right		G52298	143491 ⁵³			G51934
07-11	Left		G52297	143405 ⁶⁷ 143491 ⁵³			G51934
	Right		G52298	143405 ⁶⁷ 143491 ⁵³			G51934
02-06	Left		G52164	143404 ⁵³ 143405 ⁶⁷			G51881

5 Use kit No. 140719 to replace O.E. hardware for lower shock absorber mounting when studs break or self-tapping screws are not longer useable.;



8 Pair Packs.;

7 Pair Packs, Air hose kit included.;

51 Strut Cushion for use with the Strut/Cartridge/Shocks.;



67 Mount Kit. Hardware from O.E. Part may need to be reused.;

APPLICATION GUIDE

Year	Fitment Notes										
		Ultra	Ready Mounts	Max Control\ LTV\ ProGuard\ Guardian	Strut Cushion\ Strut Mount\ Dampers\ Stabilizer	HiJackers\ Load Carrier\ Classic	Ultra	Ready Mounts	Max Control\ LTV\ ProGuard\ Guardian	Strut Cushion\ Strut Mount\ Dampers\ Stabilizer	HiJackers\ Load Carrier\ Classic



MINI

COOPER (cont)



02-06	Right		G52165	143404 ⁵³ 143405 ⁶⁷		G51881
-------	-------	---	--------	------	------	--	------	---	--------	------	------	------	------

MITSUBISHI



3000GT

91-99	All			142419 ⁶⁷
-------	-----	---	------	------	------	------	------	---	------	------	------	----------------------	------







CORDIA

83-88	All		143059 ⁵¹	
-------	-----	---	------	------	------	----------------------	------	---	------	------	------	------	------





















DIAMANTE

97-04	All		143087 ⁵³		142419 ⁶⁷
-------	-----	---	------	------	------	----------------------	------	---	------	------	------	----------------------	------



ECLIPSE

00-05	All		143059 ⁵¹ 143087 ⁵³		142419 ⁶⁷ 143059 ⁵¹
95-99	All		142419 ⁶⁷ 143059 ⁵¹		142419 ⁶⁷ 143059 ⁵¹
90-94	All		143057 ⁵¹		142419 ⁶⁷ 143064 ⁵¹









ENDEAVOR

10-11	AWD			G51933
11	Left		G52293	
	Right		G52294	
10	Left		G52293	143398 ⁵⁴	
	Right		G52294	143398 ⁵⁴	
09	Left		G52293	
	Right		G52294	
04-08	Left		G52293	143398 ⁵⁴	
	Right		G52294	143398 ⁵⁴	
	AWD			G51933

EXPO

92-95	All		143057 ⁵¹		142419 ⁶⁷
-------	-----	---	------	------	------	----------------------	------	---	------	------	------	----------------------	------

GALANT

12	SE, Left		G52168		G51883
	SE, Right		G52169		G51883
04-11	Exc. GT, LS, Sport, Ralliart Models Left		G52168		G51883
	Exc. GT, LS, Sport, Ralliart Models Right		G52169		G51883



51 Strut Cushion for use with the Strut/Cartridge/Shocks.;

54 Kit with Mount and Bearing. Hardware from O.E. Part may need to be reused.;

53 Hardware from O.E. Part may need to be reused.;

67 Mount Kit. Hardware from O.E. Part may need to be reused.;

APPLICATION GUIDE

Year	Fitment Notes										
		Ultra	Ready Mounts	Max Control LTV ProGuard Guardian	Strut Cushion\ Strut Mount\ Dampers\ Stabilizer	HiJackers\ Load Carrier\ Classic	Ultra	Ready Mounts	Max Control LTV ProGuard Guardian	Strut Cushion\ Strut Mount\ Dampers\ Stabilizer	HiJackers\ Load Carrier\ Classic

MITSUBISHI

GALANT (cont)

08-10	All	↑	143398 ⁵⁴	↑
04-07	All	↑	143398 ⁵⁴	↑	142419 ⁶⁷
99-03	Left	↑	G56636	143087 ⁵³	↑	142419 ⁶⁷
	Right	↑	G56635	143087 ⁵³	↑	142419 ⁶⁷
	GTZ	↑	↑	G57075 ⁴⁰
94-98	All	↑	G55820	142419 ⁶⁷ 143057 ⁵¹	↑	142419 ⁶⁷ 143057 ⁵¹
93	All	↑	143057 ⁵¹	↑	142419 ⁶⁷ 143063 ⁵¹
90-92	All	↑	143057 ⁵¹	↑	142419 ⁶⁷
	AWD	↑	↑	143063 ⁵¹
89	All	↑	143057 ⁵¹	↑	142419 ⁶⁷ 143063 ⁵¹
85-88	All	↑	↑	143064 ⁵¹
	Exc. Electronic Adjustable Suspension	↑	↑	142419 ⁶⁷

MITSUBISHI

LANCER

08-11	DE, ES	↑	↑	G51908
08-10	All	↑	↑	143394 ⁶⁷
02-07	All	↑	143088 ⁵³	↑	143394 ⁶⁷
	Exc. ES & Evolution Series	↑	G56894	↑	G51794

MIGHTY MAX

95-96	All	↑	↑	G63907	61500 77907 81147	43048 ⁸ 49310 ⁷
	RWD	↑	G63950	61556	↑
83-96	Single System Steering Stabilizer	↑	6802SE ⁸⁴										
83-94	4WD	↑	G63418	61529	↑	G63419
	RWD	↑	G63950	61556	↑	G63907	61500 77907 81147	43048 ⁸ 49310 ⁷

MIRAGE

97-02	All	↑	143059 ⁵¹	↑	142419 ⁶⁷ 143064 ⁵¹
	Mfg. from 4/97; with 6" or 7" Spring Left	↑	G56530	↑
	Mfg. from 4/97; with 6" or 7" Spring Right	↑	G56529	↑
96	All	↑	143057 ⁵¹	↑	143064 ⁵¹

7 Pair Packs, Air hose kit included.;

40 Complete Assembled Unit.;

53 Hardware from O.E. Part may need to be reused.;

154 67 Mount Kit. Hardware from O.E. Part may need to be reused.;



8 Pair Packs.;

51 Strut Cushion for use with the Strut/Cartridge/Shocks.;

54 Kit with Mount and Bearing. Hardware from O.E. Part may need to be reused.;

84 Replacement damper for vehicles with the Gabriel Aftermarket mounting kit;

APPLICATION GUIDE

Year	Fitment Notes										
		Ultra	Ready Mounts	Max Control\ LTV\ ProGuard\ Guardian	Strut Cushion\ Strut Mount\ Dampers\ Stabilizer	HiJackers\ Load Carrier\ Classic	Ultra	Ready Mounts	Max Control\ LTV\ ProGuard\ Guardian	Strut Cushion\ Strut Mount\ Dampers\ Stabilizer	HiJackers\ Load Carrier\ Classic

MITSUBISHI

MIRAGE (cont)

96	Mfg. to 5/96	G55911	142329 ⁵³	142419 ⁶⁷
95	All	G55911	143057 ⁵¹	143064 ⁵¹
	Sedan	142329 ⁵³	142419 ⁶⁷
93-94	All	G55911	142329 ⁵³ 143057 ⁵¹	142419 ⁶⁷ 143064 ⁵¹
89-92	All	143057 ⁵¹	142419 ⁶⁷ 143064 ⁵¹

MITSUBISHI

MONTERO

01-03	All	143464 ⁶⁷
92-00	All	G63782 ⁹
86-95	Single System Steering Stabilizer	6802SE ⁸⁴								
90-91	All	G63418	61529
89-91	3.0L 6Cyl
83-89	All	G63418	61529	81318	49311 ⁷
83-88	2.6L 4Cyl	61506

MONTERO SPORT

00-04	All	G64027
97-99	All	G63782 ⁹	61506	49311 ⁷

OUTLANDER

09-13	SE, XLS & GT Models w/ 3rd Row Seating Left	G52299
	SE, XLS & GT Models w/ 3rd Row Seating Right	G52300
08-11	All	143394 ⁶⁷
08	XLS, Left	G52299
	XLS, Right	G52300
07	Left	G52299	143394 ⁶⁷
	Right	G52300	143394 ⁶⁷
05-06	All	143088 ⁵³	143394 ⁶⁷
03-04	All	143088 ⁵³	143394 ⁶⁷

PRECIS

90-94	All	143057 ⁵¹
87-89	All	143059 ⁵¹

RAIDER

06-09	All	G51815	143385 ⁶⁷
-------	-----	--------	------	------	----------------------	------	------	------	------	------

7 Pair Packs, Air hose kit included.;

51 Strut Cushion for use with the Strut/Cartridge/Shocks.;



67 Mount Kit. Hardware from O.E. Part may need to be reused.;

9 See Ref. D for procedures to replace Elec Adj Susp with non-adj product.;

53 Hardware from O.E. Part may need to be reused.;

84 Replacement damper for vehicles with the Gabriel Aftermarket mounting kit;

APPLICATION GUIDE

Year	Fitment Notes										
		Ultra	Ready Mounts	Max Control\ LTV\ ProGuard\ Guardian	Strut Cushion\ Strut Mount\ Dampers\ Stabilizer	HiJackers\ Load Carrier\ Classic	Ultra	Ready Mounts	Max Control\ LTV\ ProGuard\ Guardian	Strut Cushion\ Strut Mount\ Dampers\ Stabilizer	HiJackers\ Load Carrier\ Classic

MITSUBISHI

RAIDER (cont)

06-09	4WD		G57146 ⁴⁰		G63891
	RWD		G57409 ⁴⁰		G63890

MITSUBISHI

SIGMA

89-90	Non-ABS		143064 ⁵¹
	Non-ABS Exc. Auto-Leveling System		142419 ⁶⁷

STARION

87-89	All		143057 ⁵¹	143058 ⁵¹
86	LE		143058 ⁵¹	143058 ⁵¹
84-85	LE, LS		143058 ⁵¹	143058 ⁵¹
83	All		143058 ⁵¹	143058 ⁵¹

TREDIA

83-88	All		143059 ⁵¹
-------	-----	--	------	------	------	----------------------	------	--	------	------	------	------	------

VAN

87-90	All		G63904	61593 81872		G63907	61500 77907 81147	43048 ⁸ 49310 ⁷
-------	-----	--	--------	------	----------------	------	------	--	--------	------	-------------------------	------	--

NISSAN

NISSAN

200SX

95-98	All		143057 ⁵¹
80-88	All		143059 ⁵¹

210

79-82	All		143059 ⁵¹
-------	-----	--	------	------	------	----------------------	------	--	------	------	------	------	------

240SX

89-94	All		143059 ⁵¹	143064 ⁵¹
-------	-----	--	------	------	------	----------------------	------	--	------	------	------	----------------------	------

240Z

70-73	All		143059 ⁵¹
-------	-----	--	------	------	------	------	------	--	------	------	------	----------------------	------

260Z

74-75	All		143059 ⁵¹
-------	-----	--	------	------	------	------	------	--	------	------	------	----------------------	------

280Z

75-78	All		143059 ⁵¹
-------	-----	--	------	------	------	------	------	--	------	------	------	----------------------	------

280ZX

79-83	All		143059 ⁵¹
-------	-----	--	------	------	------	----------------------	------	--	------	------	------	------	------



7 Pair Packs, Air hose kit included.;

40 Complete Assembled Unit.;

8 Pair Packs.;

51 Strut Cushion for use with the Strut/Cartridge/Shocks.;







APPLICATION GUIDE

Year	Fitment Notes										
		Ultra	Ready Mounts	Max Control\ LTV\ ProGuard\ Guardian	Strut Cushion\ Strut Mount\ Dampers\ Stabilizer	HiJackers\ Load Carrier\ Classic	Ultra	Ready Mounts	Max Control\ LTV\ ProGuard\ Guardian	Strut Cushion\ Strut Mount\ Dampers\ Stabilizer	HiJackers\ Load Carrier\ Classic



NISSAN

NISSAN









300ZX

90-96	2+2		143057 ⁵¹		143064 ⁵¹
87-89	All			69757
84-86	All		143057 ⁵¹		69757

310

79-82	All		143059 ⁵¹	
-------	-----	---	------	------	------	----------------------	------	---	------	------	------	------	------

350Z

06-08	All		143455 ⁵⁷	
03-05	Left		G51813	143455 ⁵⁷	
	Right		G51814	143455 ⁵⁷	
	Sport Suspension			G51812







410

64-65	All		69600	81494		43140 ⁹ 82155
-------	-----	---	-------	------	-------	------	------	---	------	------	------	------	-----------------------------



411

64-67	All		69600	81494		43140 ⁹ 82155
-------	-----	---	-------	------	-------	------	------	---	------	------	------	------	-----------------------------







510

78-81	All		143059 ⁵¹	
	Wagon			49310 ⁷ 82156
72	All			81340	43140 ⁹



521 PICKUP

69-72	All		G63902	61501 81478	
-------	-----	---	--------	------	----------------	------	------	---	------	------	------	------	------







610

75-76	Wagon			69604	81492	49152 ⁷
73-74	All			69604	49152 ⁷
	Wagon			81492





620 PICKUP

72-79	All		G63902	61501 81478	
-------	-----	---	--------	------	----------------	------	------	---	------	------	------	------	------



710

74-77	All			43140 ⁹
	Exc. Wagon			81340
	Wagon			69604	81492	43060 ⁹ 49152 ⁷

720 PICKUP

82-86	4WD			G63492	61506 81318	49311 ⁷
80-86	All		G63902	61501 81478	

APPLICATION GUIDE

Year	Fitment Notes										
		Ultra	Ready Mounts	Max Control LTV ProGuard Guardian	Strut Cushion\ Strut Mount\ Dampers\ Stabilizer	HiJackers\ Load Carrier\ Classic	Ultra	Ready Mounts	Max Control LTV ProGuard Guardian	Strut Cushion\ Strut Mount\ Dampers\ Stabilizer	HiJackers\ Load Carrier\ Classic



NISSAN

NISSAN

720 PICKUP (cont)

82	Single System Steering Stabilizer		6802SE ⁸⁴							
----	-----------------------------------	---	----------------------	--	--	--	--	--	--	--

810

81	All		143059 ⁵¹		
78-80	Wagon		69604	81492	43060 ⁸ 49152 ⁷
77	Wagon		81492

















1600

66-70	All		82130
-------	-----	---	------	------	------	------	------	------	------	------	------	-------



2000

68-70	All		82130
-------	-----	---	------	------	------	------	------	------	------	------	------	-------

ALTIMA

19-20	w/Rebound Spring		G51874
17-18	Left		G57817 ⁴⁰	G51874
	Right		G57818 ⁴⁰	G51874
14-16	Left		G57545 ⁴⁰	G51874
	Right		G57546 ⁴⁰	G51874
07-13	All		G51874
	Exc. Hybrid Models Left		G52121	G57161 ⁴⁰
13	Exc. Hybrid Models Right		G52122
07-12	Exc. Hybrid Models Right		G52122	G57162 ⁴⁰
07-11	Hybrid, Left		G57367 ⁴⁰
	Hybrid, Right		G57368 ⁴⁰
02-06	Left		G56671	G57030 ⁴⁰	142937 ⁵⁴
	Right		G56672	G57031 ⁴⁰	142937 ⁵⁴
00-01	Left		G57558 ⁴⁰	143057 ⁵¹	143059 ⁵¹
	Right		G57559 ⁴⁰	143057 ⁵¹	143059 ⁵¹
93-99	All		143277 ⁵³

ARMADA

10-15	4WD, Exc. Auto-Leveling System		G57092 ⁴⁰
05-15	Exc. Auto-Leveling System		G51715	G63875
05-11	All		143359 ⁶⁷

7 Pair Packs, Air hose kit included.;

40 Complete Assembled Unit.;

53 Hardware from O.E. Part may need to be reused.;

158 67 Mount Kit. Hardware from O.E. Part may need to be reused.;



8 Pair Packs.;

51 Strut Cushion for use with the Strut/Cartridge/Shocks.;

54 Kit with Mount and Bearing. Hardware from O.E. Part may need to be reused.;

84 Replacement damper for vehicles with the Gabriel Aftermarket mounting kit.;

APPLICATION GUIDE

Year	Fitment Notes										
		Ultra	Ready Mounts	Max Control\ LTV\ ProGuard\ Guardian	Strut Cushion\ Strut Mount\ Dampers\ Stabilizer	HiJackers\ Load Carrier\ Classic	Ultra	Ready Mounts	Max Control\ LTV\ ProGuard\ Guardian	Strut Cushion\ Strut Mount\ Dampers\ Stabilizer	HiJackers\ Load Carrier\ Classic

NISSAN

NISSAN

ARMADA (cont)

05-09	4WD	G57092 ⁴⁰
-------	-----	-------	----------------------	-------	-------	-------	-------	-------	-------	-------

AXCESS

90-94	All	143059 ⁵¹	143059 ⁵¹
-------	-----	-------	-------	-------	----------------------	-------	-------	-------	----------------------	-------

B210

74-78	All	143059 ⁵¹
-------	-----	-------	-------	-------	----------------------	-------	-------	-------	-------	-------

CUBE

09-14	Left	G57202 ⁴⁰
	Right	G57203 ⁴⁰

F10

76-78	All	143059 ⁵¹
	Wagon	82125

FRONTIER

20-21	Exc. Nismo Off Road	G51766
05-21	4WD	G57647 ⁴⁰
	RWD	G57646 ⁴⁰
18-19	All	G51766
05-19	Exc. Nismo Off-Road
05-17	Mfg. to 12/12; Exc. Nismo Off-Road	G51766
98-04	4WD	G63813	61662	49311 ⁷
	RWD, Exc. Desert Runner	G63909	61508 77909 81507	43048 ⁸ 49310 ⁷
	RWD; Crew Cab with Desert Runner	G63813	61662	49311 ⁷

JUKE

14-16	CVT Transmission	G511122
-------	------------------	-------	-------	-------	-------	-------	-------	-------	-------	---------

MAXIMA

15	Left	G57493 ⁴⁰
	Right	G57494 ⁴⁰
09-14	Left	G52382	G57493 ⁴⁰	70089
	Right	G52383	G57494 ⁴⁰	70089
04-08	Left	G56671	G57030 ⁴⁰	142937 ⁵⁴	G51802
	Right	G56672	G57031 ⁴⁰	142937 ⁵⁴	G51802

7 Pair Packs, Air hose kit included.;



40 Complete Assembled Unit.;

54 Kit with Mount and Bearing. Hardware from O.E. Part may need to be reused.;

8 Pair Packs.;

51 Strut Cushion for use with the Strut/Cartridge/Shocks.;

APPLICATION GUIDE

Year	Fitment Notes										
		Ultra	Ready Mounts	Max Control\ LTV\ ProGuard\ Guardian	Strut Cushion\ Strut Mount\ Dampers\ Stabilizer	HiJackers\ Load Carrier\ Classic	Ultra	Ready Mounts	Max Control\ LTV\ ProGuard\ Guardian	Strut Cushion\ Strut Mount\ Dampers\ Stabilizer	HiJackers\ Load Carrier\ Classic

NISSAN

NISSAN

MAXIMA (cont)

02-03	Left		G57157 ⁴⁰	142937 ⁵⁴		G51727	G57159 ⁴⁰
	Right		G57158 ⁴⁰	142937 ⁵⁴		G51727	G57160 ⁴⁰
00-01	Left		142937 ⁵⁴		G51727	G57159 ⁴⁰
	Right		142937 ⁵⁴		G51727	G57160 ⁴⁰
95-99	Left		M55913	142546 ⁵⁴		G51087	G57057 ⁴⁰	142547 ⁵³
	Right		M55912	142546 ⁵⁴		G51087	G57058 ⁴⁰	142547 ⁵³
89-94	All		143059 ⁵¹	143057 ⁵¹
86-88	Sedan		143059 ⁵¹
85	All		143059 ⁵¹
83-84	Wagon		49310 ⁷ 82156
82-84	All		143059 ⁵¹

MULTI

87-88	CAN		143057 ⁵¹
-------	-----	--	------	------	------	------	------	--	------	------	------	----------------------	------

MURANO

19	All			G51884
18	Left		G52524	G57772 ⁴⁰		G51884
	Right		G52525	G57773 ⁴⁰		G51884
15-17	Left		G52524	G57772 ⁴⁰
	Right		G52525	G57773 ⁴⁰
14-17	Exc. CrossCabriolet			G51884
14	Left		G57772 ⁴⁰
	Right		G57773 ⁴⁰
13	Mfg. to 12/12 Left		G52170		G51884
	Mfg. to 12/12 Right		G52171		G51884
08-12	All			G51884
	Mfg. to 12/12 Left		G52170
	Mfg. to 12/12 Right		G52171
03-07	Left		G52008	G57163 ⁴⁰	142937 ⁵⁴		G51798	143396 ⁶⁸
	Right		G52009	G57164 ⁴⁰	142937 ⁵⁴		G51798	143396 ⁶⁸

7 Pair Packs, Air hose kit included.;

51 Strut Cushion for use with the Strut/Cartridge/Shocks.;

40 Complete Assembled Unit.;

53 Hardware from O.E. Part may need to be reused.;

160 54 Kit with Mount and Bearing. Hardware from O.E. Part may need to be reused.;

68 Mount Kit. Hardware from O.E. Part may need to be reused.;

APPLICATION GUIDE

Year	Fitment Notes										
		Ultra	Ready Mounts	Max Control\ LTV\ ProGuard\ Guardian	Strut Cushion\ Strut Mount\ Dampers\ Stabilizer	HiJackers\ Load Carrier\ Classic	Ultra	Ready Mounts	Max Control\ LTV\ ProGuard\ Guardian	Strut Cushion\ Strut Mount\ Dampers\ Stabilizer	HiJackers\ Load Carrier\ Classic

NISSAN

NISSAN

NOTE

14-16	All	G51990
-------	-----	-------	-------	-------	-------	-------	--------	-------	-------	-------	-------

NV200

13-19	All	G64146
-------	-----	-------	-------	-------	-------	-------	--------	-------	-------	-------	-------

NV1500

12-19	All	G64164
-------	-----	-------	-------	-------	-------	-------	--------	-------	-------	-------	-------

NV2500

12-19	All	G64164
-------	-----	-------	-------	-------	-------	-------	--------	-------	-------	-------	-------

NV3500

12-19	All	G64164
-------	-----	-------	-------	-------	-------	-------	--------	-------	-------	-------	-------

NX

91-93	All	143057 ⁵¹
-------	-----	-------	-------	-------	----------------------	-------	-------	-------	-------	-------	-------

PATHFINDER

13-20	Left	G52524	G57772 ⁴⁰	G511043
	Right	G52525	G57773 ⁴⁰	G511043
05-13	Mfg. to 9/12	G64033
05-12	Mfg. to 8/12	G51765
05-11	4WD	G57118 ⁴⁰
02-04	Left	G57144 ⁴⁰
	Right	G57145 ⁴⁰
01-04	Left w/ OE 543034W925 or 543034W926	G56687
	Right w/ OE 543034W925 or 543034W926	G56688
04	All	G63845
02-03	All	142938 ⁵³	G63845
99-01	Left Mfg. from 12/98; w/ OE543034W985	G56615
	Mfg. from 12/98	G63845
	Right Mfg. from 12/98; w/ OE543034W985	G56616
96-01	All	142938 ⁵³
96-99	Mfg. to 11/98 Left	G57037 ⁴⁰
	Mfg. to 11/98 Right	G57038 ⁴⁰
	Mfg. to 12/98	G63712	81910
87-95	All	81872
	Exc. Electronic Adjustable Suspension	G63904 ⁹	61593 ⁹	G63492 ⁹	61506 ⁹ 81318 ⁹	49311 ⁷

7 Pair Packs, Air hose kit included.;



40 Complete Assembled Unit.;

53 Hardware from O.E. Part may need to be reused.;

9 See Ref. D for procedures to replace Elec Adj Susp with non-adj product.;

51 Strut Cushion for use with the Strut/Cartridge/Shocks.;

APPLICATION GUIDE

Year	Fitment Notes										
		Ultra	Ready Mounts	Max Control LTV ProGuard Guardian	Strut Cushion\ Strut Mount\ Dampers\ Stabilizer	HiJackers\ Load Carrier\ Classic	Ultra	Ready Mounts	Max Control LTV ProGuard Guardian	Strut Cushion\ Strut Mount\ Dampers\ Stabilizer	HiJackers\ Load Carrier\ Classic

NISSAN

NISSAN

PATHFINDER ARMADA

04	All	G51715	G57092 ⁴⁰	G63875
----	-----	--------	----------------------	------	------	------	--------	------	------	------	------

PICKUP

87-97	4WD	G63902	61501 81478	G63492	61506 81318	49311 ⁷
	RWD	G63909	61508 77909 81507	G63907	61500 77907 81147	43048 ⁸ 49310 ⁷
86	4WD, Mfg. from 8/86	G63902	61501 81478	G63492	61506 81318	49311 ⁷
	RWD, Mfg. from 8/86	G63909	61508 77909 81507	G63907	61500 77907 81147	43048 ⁸ 49310 ⁷

PULSAR / PULSAR NX

86-90	All	143057 ⁵¹	143059 ⁵¹
83-85	All	143057 ⁵¹

QUEST

14-17	Left	G52906
	Right	G52907
11-13	Left	G52355
	Right	G52356
04-09	Left	G52032	G57184 ⁴⁰	142937 ⁵⁴	G51803	143396 ⁶⁸
	Right	G52033	G57185 ⁴⁰	142937 ⁵⁴	G51803	143396 ⁶⁸
99-02	All	G63299
93-98	Left	M55920	143057 ⁵¹	G63299
	Right	M55921	143057 ⁵¹	G63299

ROGUE

14-20	Left	G52410
	Left New Body Style	G57774 ⁴⁰
	Right	G52411
	Right New Body Style	G57775 ⁴⁰
08-20	All	G64050
13-15	Left w/ OE #E4302JM00A	G57778 ⁴⁰
	Right w/ OE #E4302JM00A	G57779 ⁴⁰
13	Left Old Body Style	G57776 ⁴⁰
	Right Old Body Style	G57777 ⁴⁰

7 Pair Packs, Air hose kit included.;

40 Complete Assembled Unit.;



162 54 Kit with Mount and Bearing. Hardware from O.E. Part may need to be reused.;

8 Pair Packs.;

51 Strut Cushion for use with the Strut/Cartridge/Shocks.;

68 Mount Kit. Hardware from O.E. Part may need to be reused.;





APPLICATION GUIDE

Year	Fitment Notes										
		Ultra	Ready Mounts	Max Control\ LTV\ ProGuard\ Guardian	Strut Cushion\ Strut Mount\ Dampers\ Stabilizer	HiJackers\ Load Carrier\ Classic	Ultra	Ready Mounts	Max Control\ LTV\ ProGuard\ Guardian	Strut Cushion\ Strut Mount\ Dampers\ Stabilizer	HiJackers\ Load Carrier\ Classic



NISSAN

NISSAN















ROGUE (cont)

08-12	Left w/ OE# E4303JM00A		G52173
	Right w/ OE# E4302JM00A		G52174
08-10	Left		G57473 ⁴⁰
	Right		G57474 ⁴⁰





ROGUE SELECT

14-15	All	
	Left Old Body Style		G57776 ⁴⁰
	Right Old Body Style		G57777 ⁴⁰

SENTRA

13-15	All	
08-12	Left		G57200 ⁴⁰
	Right		G57201 ⁴⁰
07-12	Base, S and SL Models Left		G52094
	Base, S and SL Models Right		G52095
07	All	
	Exc. SE & SE-R Models Left		G57200 ⁴⁰
	Exc. SE & SE-R Models Right		G57201 ⁴⁰
02-06	All	
	Exc. SE-R & SE-R Spec V Models Left		G57034 ⁴⁰
	Exc. SE-R & SE-R Spec V Models Right		G57035 ⁴⁰
00-01	All	
91-99	All	
87-90	FWD	
82-86	All	

STANZA



90-92	All	
87-89	Sedan	
86	Sedan	
82-85	All	

40 Complete Assembled Unit.;

53 Hardware from O.E. Part may need to be reused.;

51 Strut Cushion for use with the Strut/Cartridge/Shocks.;

APPLICATION GUIDE

Year	Fitment Notes										
		Ultra	Ready Mounts	Max Control\ LTV\ ProGuard\ Guardian	Strut Cushion\ Strut Mount\ Dampers\ Stabilizer	HiJackers\ Load Carrier\ Classic	Ultra	Ready Mounts	Max Control\ LTV\ ProGuard\ Guardian	Strut Cushion\ Strut Mount\ Dampers\ Stabilizer	HiJackers\ Load Carrier\ Classic

NISSAN

NISSAN

TITAN

17-22	All		G51715		
	Exc. Off Road		G57092 ⁴⁰		
	4WD		G63878	77976	43181 ⁸ 49235 ⁷
	RWD		G63883
12-15	All		G51715	
07-15	4WD, Exc. Off Road		G57092 ⁴⁰	
	RWD		G57092 ⁴⁰	G63883
04-15	4WD		G63878	77976	43181 ⁸ 49235 ⁷
07-11	All		G51715	143359 ⁶⁷	
04-06	All		G51715	G57092 ⁴⁰	143359 ⁶⁷	
	RWD		G63883

TITAN XD

16-22	4WD; Exc. Pro 4-X		G63878	77976
-------	-------------------	--	------	------	------	------	------	--------	------	-------	------	------

VERSA

13-20	All		G51990
12	All		70041
07-11	Models S and SL		70041
	S & SL Models Left		G57202 ⁴⁰
	S & SL Models Right		G57203 ⁴⁰
09	Right		G57203 ⁴⁰

VERSA NOTE

17-19	All		G51990
-------	-----	--	------	------	------	------	------	--------	------	------	------	------

X-TRAIL

19-20	Left		G52410	G64050
	Right		G52411	G64050
10-12	Left		G52173	G64050
	Right		G52174	G64050
08	Left		G52173	G64050
	Right		G52174	G64050
02-07	All		143346 ⁵³



7 Pair Packs, Air hose kit included.;

40 Complete Assembled Unit.;

8 Pair Packs.;

53 Hardware from O.E. Part may need to be reused.;









APPLICATION GUIDE

Year	Fitment Notes										
		Ultra	Ready Mounts	Max Control\ LTV\ ProGuard\ Guardian	Strut Cushion\ Strut Mount\ Dampers\ Stabilizer	HiJackers\ Load Carrier\ Classic	Ultra	Ready Mounts	Max Control\ LTV\ ProGuard\ Guardian	Strut Cushion\ Strut Mount\ Dampers\ Stabilizer	HiJackers\ Load Carrier\ Classic

NISSAN

NISSAN













XTERRA

14-15	All		G51765
05-15	4WD		G57413 ⁴⁰
	4WD; Mfg. to 12/12		69595
	RWD; Mfg. to 12/12		69594
05-13	Mfg. to 12/12		G51765
00-04	All		G63813	61662	G63492
										61506
										49311 ⁷









OLDSMOBILE

OLDSMOBILE

88 SERIES

97-99	All		G56718 ⁹	M56718 ⁹	142530 ⁵⁴
92-99	Coil(RearSpringType) Exc. Electronic Adjustable Suspension		G56726 ⁴³
92-96	All		G56718 ⁹	M56718 ⁹
90-91	Late Design Front Strut without Spring Guard		G56718 ⁹	M56718 ⁹
86-91	Coil(RearSpringType)		G56726 ⁴³
86-90	Early Design Front Strut w/ Spring Guard		G56701	143061 ⁵¹
71-85	All		69675 ⁵	81446	34073 ⁸	69724
65-70	All		82110	69724
57-64	All		82079
										81514
										43049 ⁸ 49131 ³⁰
										43049 ⁸ 49128 ³⁰

98

91-96	CCR Computer Command Ride		G56718 ⁹	M56718 ⁹
85-96	Air(RearSpringType) Conventional Type Replacement		G56726 ⁴³
85-90	All		G56701	143061 ⁵¹
71-84	All		69675 ⁵	81446	34073 ⁸	69724
65-70	All		82110	69724
58-64	All		82079
56	All		49310 ⁷ 82156
55	All		82026	49310 ⁷ 82156
51-54	All		49310 ⁷ 82156

ACHIEVA

92-98	All		143059 ⁵¹
-------	-----	---	------	------	------	----------------------	------	------	------	------	------

5 Use kit No. 140719 to replace O.E. hardware for lower shock absorber mounting when studs break or self-tapping screws are not longer useable;

8 Pair Packs.;

30 For GM Vehicles equipped with factory installed leveling systems, see Ref A.;

43 Does not include springs due to vehicle design. See Ref. D for procedures to replace Elec Adj Susp with non-adj product.;

54 Kit with Mount and Bearing. Hardware from O.E. Part may need to be reused.;



7 Pair Packs, Air hose kit included.;

9 See Ref. D for procedures to replace Elec Adj Susp with non-adj product.;

40 Complete Assembled Unit.;

51 Strut Cushion for use with the Strut/Cartridge/Shocks.;

APPLICATION GUIDE

Year	Fitment Notes										
		Ultra	Ready Mounts	Max Control LTV ProGuard Guardian	Strut Cushion\ Strut Mount\ Dampers\ Stabilizer	HiJackers\ Load Carrier\ Classic	Ultra	Ready Mounts	Max Control LTV ProGuard Guardian	Strut Cushion\ Strut Mount\ Dampers\ Stabilizer	HiJackers\ Load Carrier\ Classic

OLDSMOBILE

ALERO

99-04	All	G56927 ⁴⁰	M55974	G56928 ⁴⁰	M56501	143057 ⁵¹
-------	-----	-------	----------------------	--------	-------	-------	-------	----------------------	--------	----------------------	-------

OLDSMOBILE

AURORA

01-03	All	G56509
	Exc. Electronic Adjustable Suspension	G57051 ⁴⁰
	With OE Style air fitting	49255 ⁷
	Without OE Style air fitting	49228 ³⁰
98-99	All	G56509
	Exc. Electronic Adjustable Suspension	G57051 ⁴⁰
95-99	With OE Style air fitting	49255 ⁷
	Without OE Style air fitting	49228 ³⁰
95-96	All	G56718 ⁹	M56718 ⁹

BRAVADA

02-04	All	G51718 ⁴⁵	G57022 ⁴⁰	61717 77971
	Coil(RearSpringType)	G63842
96-01	All	G63423	58423 61531 77423 81516	G63422	61528 77422 81482	43162 ⁸ 49213 ⁷
91-94	All	G63423	58423 61531 77423 81516	G63422	61528 77422 81482	43162 ⁸ 49213 ⁷

CUSTOM CRUISER

77-92	All	69675 ⁵	81446	34073 ⁸	69604	81492	43060 ⁸ 49152 ³⁰
71-76	All	69675 ⁵	81446	34073 ⁸	69604	81492

CUTLASS / CUTLASS SUPREME

99	All	G56927 ⁴⁰	M55974	M56501	143057 ⁵¹
98	All	G56927 ⁴⁰	143057 ⁵¹
	Rear Strut Lower Mounting holes at 2.4" Apart	M55974
	Second Design with Rear Strut Lower Mounting holes at 2.4" apart	M56501
97	All	G56927 ⁴⁰	M55974	143057 ⁵¹
	Exc. Rear Strut Lower Mounting holes at 3.2" apart	M56708
88-96	All	M56708
85-87	All	69600	81494	34051 ⁸	69604	81492	43060 ⁸ 49334 ³⁰ 49334 ⁷

5 Use kit No. 140719 to replace O.E. hardware for lower shock absorber mounting when studs break or self-tapping screws are not longer useable;

8 Pair Packs.;

30 For GM Vehicles equipped with factory installed leveling systems, see Ref A.;



7 Pair Packs, Air hose kit included.;

9 See Ref. D for procedures to replace Elec Adj Susp with non-adj product.;

40 Complete Assembled Unit.;

51 Strut Cushion for use with the Strut/Cartridge/Shocks.;

APPLICATION GUIDE

Year	Fitment Notes										
		Ultra	Ready Mounts	Max Control\ LTV\ ProGuard\ Guardian	Strut Cushion\ Strut Mount\ Dampers\ Stabilizer	HiJackers\ Load Carrier\ Classic	Ultra	Ready Mounts	Max Control\ LTV\ ProGuard\ Guardian	Strut Cushion\ Strut Mount\ Dampers\ Stabilizer	HiJackers\ Load Carrier\ Classic

OLDSMOBILE

OLDSMOBILE

CUTLASS / CUTLASS SUPREME (cont)

79-84	All	IE	69600	81494	34051 ⁸	OE	69604	81492	43060 ⁹ 49334 ³⁰
78-79	Vista Cruiser		OE	49334 ³⁰
76-78	All	IE	69600	81494	34051 ⁸	OE	69604	81492	43060 ⁹
76-77	Coupe		OE	49152 ³⁰
	Sedan		OE	49152 ³⁰
	Wagon		OE	49334 ³⁰
73-75	All	IE	69600	81494	34051 ⁸	OE	69604	81492	43060 ⁹ 49152 ³⁰
71-72	All	IE	69600	81494	34051 ⁸	OE	69604	81492	43060 ⁹
68-72	Heavy Duty Suspension		OE	69604
72	Base, S		OE	49152 ³⁰
	Exc. Cruiser		OE	81492
68-71	Exc. Vista Cruiser		OE	49152 ³⁰
68-70	All	IE	69600	81494	34051 ⁸	OE	81492	43060 ⁹
66-67	Exc. Heavy Duty Suspension		OE	69724	81514	43049 ⁹
	Base, Exc. Heavy Duty Suspension		OE	49131 ³⁰
64-67	Heavy Duty Suspension; Exc. Vista Cruiser		OE	49152 ³⁰
	Base, Holiday	IE	82138	
67	Heavy Duty Suspension		OE	81492	43060 ⁹
	Turnpike Cruiser	IE	82110		49128 ⁷
64-66	Heavy Duty Suspension		OE	69604	81492	43060 ⁹
64-65	Exc. Heavy Duty Suspension		OE	69724	81514	43049 ⁹ 49131 ³⁰

CUTLASS CALAIS

80-84	All	IE	69600	OE	69604
-------	-----	----	-------	------	------	------	------	----	-------	------	------	------	------

CUTLASS CLASSIC / CUTLASS CRUISER

80-83	All	IE	69600	81494	34051 ⁸	OE	69604	81492	43060 ⁹ 49334 ³⁰
-------	-----	----	-------	------	-------	------	--------------------	----	-------	------	-------	------	---

DYNAMIC 88

65-66	All	IO	82110	OE	69724	81514	49128 ³⁰
58-64	All	IO	82079	

F85

68-72	All	IE	69600	81494	OE	69604	81492	43060 ⁹ 49152 ³⁰
64-67	Exc. Heavy Duty Suspension		OE	69724	81514	43049 ⁹ 49131 ³⁰
	Heavy Duty Suspension		OE	69604	81492	43060 ⁹ 49152 ³⁰
61-67	All	IE	82138	
61-63	Exc. Heavy Duty Suspension		OE	69724	81514
	Heavy Duty Suspension		OE	69604	81492

FIESTA



57-63	All	OE	82079	
-------	-----	----	------	------	------	------	-------	--	------	------	------	------	------

7 Pair Packs, Air hose kit included.;

8 Pair Packs.;

30 For GM Vehicles equipped with factory installed leveling systems, see Ref A.;







APPLICATION GUIDE

Year	Fitment Notes										
		Ultra	Ready Mounts	Max Control LTV ProGuard Guardian	Strut Cushion\ Strut Mount\ Dampers\ Stabilizer	HiJackers\ Load Carrier\ Classic	Ultra	Ready Mounts	Max Control LTV ProGuard Guardian	Strut Cushion\ Strut Mount\ Dampers\ Stabilizer	HiJackers\ Load Carrier\ Classic



OLDSMOBILE

OLDSMOBILE





INTRIGUE

98-02	All		G55948	G57060 ⁴⁰	142526 ⁵⁴		G55949	143061 ⁵¹
	Left		G55948	G57060 ⁴⁰	142526 ⁵⁴		G55949	G56924 ⁴⁰	143073 ⁵³
	Right		G55948	G57060 ⁴⁰	142526 ⁵⁴		G55949	G56925 ⁴⁰	143074 ⁵³







JETFIRE

62-63	All		82079	
-------	-----	---	------	------	------	------	-------	---	------	------	------	------	------





LSS

96-99	All		G56718 ⁹	M56718 ⁹	142530 ⁵⁴	
	Coil(RearSpringType) Conventional Type Replacement for Air Assist Rear Suspension			G56726 ⁴³









OMEGA

78-79	All		69600	81494	34051 ⁸	
74-77	All		69600	81494	
73	Exc. Heavy Duty Suspension		69600	81494	







REGENCY

97-98	All		G56718 ⁹	M56718 ⁹	142530 ⁵⁴	
	Coil(RearSpringType)			G56726 ⁴³









SILHOUETTE

02-04	AWD, FWD			G63776	61659 81924
	FWD			49230 ⁷
97-04	All		G55948	G57060 ⁴⁰	142526 ⁵⁴	
97-01	FWD			G63776	61659 81924	49230 ⁷





STARFIRE

65-66	All		82110		69724	81514	43049 ⁸ 49128 ³⁰
61-64	All		82079	
57	All		82079	

TORONADO

71-78	All		82010		69604	81492	43060 ⁸ 49152 ³⁰
67-70	Vertically Mounted		82010		82034
66	Vertically Mounted		82010		49122 ⁷
	Vertically Mounted; Single Leaf Rear Springs			82040

VISTA CRUISER

73-75	All		69600	
68-72	All		69600		69606	81495	43140 ⁸ 49205 ⁷

7 Pair Packs, Air hose kit included.;

9 See Ref. D for procedures to replace Elec Adj Susp with non-adj product.;

40 Complete Assembled Unit.;

51 Strut Cushion for use with the Strut/Cartridge/Shocks.;

168 54 Kit with Mount and Bearing. Hardware from O.E. Part may need to be reused.;



8 Pair Packs.;

30 For GM Vehicles equipped with factory installed leveling systems, see Ref A.;

43 Does not include springs due to vehicle design. See Ref. D for procedures to replace Elec Adj Susp with non-adj product.;

53 Hardware from O.E. Part may need to be reused.;

APPLICATION GUIDE

Year	Fitment Notes										
		Ultra	Ready Mounts	Max Control\ LTV\ ProGuard\ Guardian	Strut Cushion\ Strut Mount\ Dampers\ Stabilizer	HiJackers\ Load Carrier\ Classic	Ultra	Ready Mounts	Max Control\ LTV\ ProGuard\ Guardian	Strut Cushion\ Strut Mount\ Dampers\ Stabilizer	HiJackers\ Load Carrier\ Classic

OLDSMOBILE

OLDSMOBILE

VISTA CRUISER (cont)

64-67	All	IO 69606	81495	43140 ⁹ 49205 ⁷
-------	-----	-------	-------	-------	-------	-------	----------	-------	-------	-------	--

OPEL

OPEL

OPEL

69-73	All	IO	82039
-------	-----	-------	-------	-------	-------	-------	----------	-------	-------	-------	-------

PACKARD

PACKARD

200

51-52	w/ Conventional Suspension	II	82026								
-------	----------------------------	----	-------	--	--	--	--	--	--	--	--

CARIBBEAN

55-56	w/ Torsion Bar Rear Suspension	IO	82066
-------	--------------------------------	-------	-------	-------	-------	-------	----------	-------	-------	-------	-------

CLIPPER

57	All	II	82087
55-56	w/ Torsion Bar Rear Suspension	IO	82066

EXECUTIVE

56	w/ Torsion Bar Rear Suspension	IO	82066
----	--------------------------------	----	-------	-------	-------	-------	-------	-------	-------	-------	-------

FOUR-HUNDRED

55-56	w/ Torsion Bar Rear Suspension	IO	82066
-------	--------------------------------	----	-------	-------	-------	-------	-------	-------	-------	-------	-------

HAWK

58	All	II	82087
----	-----	----	-------	-------	-------	-------	-------	-------	-------	-------	-------

PACKARD

58	All	II	82087
----	-----	----	-------	-------	-------	-------	-------	-------	-------	-------	-------

PATRICIAN

55-56	w/ Torsion Bar Rear Suspension LVA	IO	82066
-------	------------------------------------	----	-------	-------	-------	-------	-------	-------	-------	-------	-------

PEUGEOT

PEUGEOT

403

59-66	All	II	82125
-------	-----	----	-------	-------	-------	-------	-------	-------	-------	-------	-------

404

61-67	All	II	82125
-------	-----	----	-------	-------	-------	-------	-------	-------	-------	-------	-------

504 / 505 / 604

91	All	II	143061 ⁵¹
86-90	Sedan	II	143061 ⁵¹

PLYMOUTH

PLYMOUTH

ACCLAIM

89-95	All	II	142933 ⁵⁷ 143059 ⁵¹	IO 69632	49369 ⁷
-------	-----	----	-------	-------	-------	--	-------	----------	-------	-------	--------------------



ARROW

76-80	All	II	143059 ⁵¹	IO	81676
-------	-----	----	-------	-------	-------	----------------------	-------	----------	-------	-------	-------

7 Pair Packs, Air hose kit included.;
51 Strut Cushion for use with the Strut/Cartridge/Shocks.;





8 Pair Packs.;
67 Mount Kit. Hardware from O.E. Part may need to be reused.;

APPLICATION GUIDE

Year	Fitment Notes										
		Ultra	Ready Mounts	Max Control LTV ProGuard Guardian	Strut Cushion\ Strut Mount\ Dampers\ Stabilizer	HiJackers\ Load Carrier\ Classic	Ultra	Ready Mounts	Max Control LTV ProGuard Guardian	Strut Cushion\ Strut Mount\ Dampers\ Stabilizer	HiJackers\ Load Carrier\ Classic









PLYMOUTH

BARRACUDA











70-74	All		82090		49106 ⁷ 82131
64-69	All		82090		81469	49110 ⁷

PLYMOUTH



BELVEDERE

62-70	All		82090		49106 ⁷ 82131
57-61	All		82072		81469	49110 ⁷
55-56	All		81582		81469	49110 ⁷
53-54	All			81469	49110 ⁷









BREEZE

99-00	Exc. JA Mfr Body Code		G51267	
00	All		143064 ⁵¹		G51268	143063 ⁵¹
99	All		143030 ⁵³ 143064 ⁵¹		G51268	143063 ⁵¹
96-98	All		143030 ⁵³ 143064 ⁵¹		143063 ⁵¹
	Convertible			G57422 ⁴⁰



CAMBRIDGE

51-53	All			81469	49110 ⁷
-------	-----	---	------	------	------	------	------	---	------	------	-------	------	--------------------

















CARAVELLE

88	All		142933 ⁶⁷	
	FWD			69632	49369 ⁷
86-87	All		142933 ⁶⁷		69632	49369 ⁷
83-85	All			69632	49369 ⁷

CHAMP

79-82	All		143059 ⁵¹	
-------	-----	---	------	------	------	----------------------	------	---	------	------	------	------	------

COLT

93-94	Sedan		G55911	142329 ⁵³	
94	All			142419 ⁶⁷
92-93	All		143057 ⁵¹		142419 ⁶⁷
89-91	All			142419 ⁶⁷
	FWD, Hatchback		143057 ⁵¹	
84-91	Vista, Wagon		143059 ⁵¹	
80-83	Hatchback		143059 ⁵¹	
80	All			43048 ⁸ 49310 ⁷ 82156

7 Pair Packs, Air hose kit included.;

40 Complete Assembled Unit.;



170 53 Hardware from O.E. Part may need to be reused.;

8 Pair Packs.;

51 Strut Cushion for use with the Strut/Cartridge/Shocks.;

67 Mount Kit. Hardware from O.E. Part may need to be reused.;

APPLICATION GUIDE

Year	Fitment Notes										
		Ultra	Ready Mounts	Max Control\ LTV\ ProGuard\ Guardian	Strut Cushion\ Strut Mount\ Dampers\ Stabilizer	HiJackers\ Load Carrier\ Classic	Ultra	Ready Mounts	Max Control\ LTV\ ProGuard\ Guardian	Strut Cushion\ Strut Mount\ Dampers\ Stabilizer	HiJackers\ Load Carrier\ Classic

PLYMOUTH

COLT (cont)

76-79	All	81676	43048 ⁸ 49310 ⁷ 82156
	Sedan	143059 ⁵¹
	Wagon	143059 ⁵¹

PLYMOUTH

CONCORD

51-52	All	81469	49110 ⁷
-------	-----	-------	-------	-------	-------	-------	-------	-------	-------	--------------------

CRANBROOK

51-53	All	81469	49110 ⁷
-------	-----	-------	-------	-------	-------	-------	-------	-------	-------	--------------------

CUSTOM

58-61	All	82072	81469	49110 ⁷
-------	-----	-------	-------	-------	-------	-------	-------	-------	-------	--------------------

DUSTER

70-76	All	82090	81469	49110 ⁷
-------	-----	-------	-------	-------	-------	-------	-------	-------	-------	--------------------

EXPO

87-89	All	143057 ⁵¹	142173 ⁵³ 143059 ⁵¹
-------	-----	-------	-------	-------	----------------------	-------	-------	-------	--	-------

FLEET SPECIAL

62-63	All	82090	49106 ⁷ 82131
60-61	All	82072	81469	49110 ⁷



FURY

77-78	All	81153
	Police Package	49106 ⁷ 82131
75-76	All	81153	49106 ⁷ 82131
74	All	49106 ⁷ 82131
73	All	82011	81091
	Exc. Wagon	81091
	Exc. Wagon	49149 ⁷
	Wagon	49106 ⁷ 82131
70-72	All	82011	81091	49149 ⁷
65-69	All	82011	49106 ⁷ 82131
62-64	All	82090	49106 ⁷ 82131
57-61	All	82072	81469	49110 ⁷
56	All	81582	81469	49110 ⁷

GRAN FURY

80-81	All	81153
74-77	All	49106 ⁷ 82131
73	All	82011
	Hardtop	81091	49149 ⁷

APPLICATION GUIDE

Year	Fitment Notes										
		Ultra	Ready Mounts	Max Control LTV ProGuard Guardian	Strut Cushion\ Strut Mount\ Dampers\ Stabilizer	HiJackers\ Load Carrier\ Classic	Ultra	Ready Mounts	Max Control LTV ProGuard Guardian	Strut Cushion\ Strut Mount\ Dampers\ Stabilizer	HiJackers\ Load Carrier\ Classic

PLYMOUTH

GRAN FURY (cont)

73	Wagon	49106 ⁷ 82131
72	All	82011	81091	...	49149 ⁷

PLYMOUTH

GTX

71	All	49106 ⁷ 82131
67-70	All	82090	49106 ⁷ 82131

HORIZON

90	All	142173 ⁵³	...
	Hatchback	143059 ⁵¹
78-89	All	143057 ⁵¹	142173 ⁵³	...

LASER

90-94	All	143057 ⁵¹	142419 ⁶⁷ 143064 ⁵¹	...
-------	-----	-----	-----	-----	----------------------	-----	-----	-----	-----	--	-----

NEON

00-01	Left	G55892	G56975 ⁴⁰	M55892	142932 ⁶⁷	G56973 ⁴⁰	...	143256 ⁵³	...
	Right	G55892	G56975 ⁴⁰	M55892	142932 ⁶⁷	G56974 ⁴⁰	...	143256 ⁵³	...
95-99	All	143057 ⁵¹	143059 ⁵¹	...

PICKUP

79-82	All	G63950	...	61556	G63907	...	61500 77907 81147	...	43048 ⁸ 49310 ⁷
	Steering Stabilizer	6802SE ⁸⁴										

PLAZA

57-58	All	82072	81469	...	49110 ⁷
55-56	All	81582	81469	...	49110 ⁷
54	All	81469	...	49110 ⁷

RELIANT

86-89	All	142933 ⁶⁷	69632	49369 ⁷
84-85	All	69632	49369 ⁷
81-83	All	143057 ⁵¹	69632	49369 ⁷

ROAD RUNNER

73-75	All	81153	49106 ⁷ 82131
68-72	All	82090	49106 ⁷ 82131

SAPPORO

78-83	All	143059 ⁵¹
-------	-----	-----	-----	-----	----------------------	-----	-----	-----	-----	-----	-----

7 Pair Packs, Air hose kit included.;

40 Complete Assembled Unit.;



53 Hardware from O.E. Part may need to be reused.;

8 Pair Packs.;

51 Strut Cushion for use with the Strut/Cartridge/Shocks.;

67 Mount Kit. Hardware from O.E. Part may need to be reused.;

APPLICATION GUIDE

Year	Fitment Notes										
		Ultra	Ready Mounts	Max Control\ LTV\ ProGuard\ Guardian	Strut Cushion\ Strut Mount\ Dampers\ Stabilizer	HiJackers\ Load Carrier\ Classic	Ultra	Ready Mounts	Max Control\ LTV\ ProGuard\ Guardian	Strut Cushion\ Strut Mount\ Dampers\ Stabilizer	HiJackers\ Load Carrier\ Classic

PLYMOUTH

PLYMOUTH

SATELLITE

73-74	All	○	81153	49106 ⁷ 82131
65-72	All	○	82090	49106 ⁷ 82131

SAVOY

62-64	All	○	82090	49106 ⁷ 82131
57-61	All	○	82072	49110 ⁷
55-56	All	○	81582	81469	49110 ⁷
53-54	All	○	81469	49110 ⁷

SCAMP

83	All	○	143057 ⁵¹
71-76	All	○	82090	49110 ⁷

SPORT WAGON

60-61	All	○	82072	49110 ⁷
-------	-----	---	-------	-------	-------	-------	-------	-------	-------	-------	--------------------

SUBURBAN

57-61	All	○	82072	49110 ⁷
55-56	All	○	81582	81469	49110 ⁷
51-54	All	○	81469	49110 ⁷

SUNDANCE

87-94	All	○	142933 ⁶⁷	69632	49369 ⁷
-------	-----	---	-------	-------	-------	----------------------	-------	-------	-------	-------	--------------------

SUPERBIRD

70	All	○	82090	49106 ⁷ 82131
----	-----	---	-------	-------	-------	-------	-------	-------	-------	-------	-----------------------------

TRAILDUSTER

76-81	4WD	○	G63183	61632 81825	81342
74-81	Dual System Steering Stabilizer; Exc. Vacuum Servo Mounted on Drivers Side of Axle	○	6802SE ⁸⁴								
	Single System Steering Stabilizer	○	6803SE ⁸⁴								
81	All	○	34052 ⁸	49149 ⁷
	RWD	○	G63359 ³⁵	58359 ³⁵ 61523 ³⁵ 81096 ³⁵	G63353	81091
76-80	All	○	49149 ⁷
	RWD	○	G63359 ³⁵	58359 ³⁵ 61523 ³⁵ 81096 ³⁵	34052 ⁸	G63353	81091
75	All	○	G63353	49149 ⁷
	4WD	○	G63183	61632 81825
	RWD	○	G63359 ³⁵	58359 ³⁵ 61523 ³⁵ 81096 ³⁵	34052 ⁸	81091
74	All	○	G63183	61632 81825	G63353	49149 ⁷

7 Pair Packs, Air hose kit included.;

35 Slight grinding of control arm opening is required to install product made before Aug 1988.;



67 Mount Kit. Hardware from O.E. Part may need to be reused.;

8 Pair Packs.;

51 Strut Cushion for use with the Strut/Cartridge/Shocks.;

84 Replacement damper for vehicles with the Gabriel Aftermarket mounting kit;

APPLICATION GUIDE

Year	Fitment Notes										
		Ultra	Ready Mounts	Max Control LTV ProGuard Guardian	Strut Cushion\ Strut Mount\ Dampers\ Stabilizer	HiJackers\ Load Carrier\ Classic	Ultra	Ready Mounts	Max Control LTV ProGuard Guardian	Strut Cushion\ Strut Mount\ Dampers\ Stabilizer	HiJackers\ Load Carrier\ Classic

PLYMOUTH

TURISMO

85	All	↓	143057 ⁵¹	↓	142173 ⁵³
83	All	↓	143057 ⁵¹	↓	142173 ⁵³

PLYMOUTH

VALIANT

60-76	All	↓	82090	↓	81469	49110 ⁷
-------	-----	---	------	------	------	------	-------	---	------	------	-------	------	--------------------

VAN 1/2 TON, PB SERIES

74-83	All	↓	G63359 ³⁵	58359 ³⁵ 61523 ³⁵ 81096 ³⁵	34052 ⁸	↓	G63413	61522 ⁹ 81496	43085 ⁸ 49212 ⁷
-------	-----	---	----------------------	------	------	---	------	--------------------	---	--------	------	-----------------------------	------	--

VAN 3/4 TON, PB SERIES

74-83	All	↓	G63359 ³⁵	58359 ³⁵ 61523 ³⁵ 81096 ³⁵	34052 ⁸	↓	G63413	61522 ⁹ 81496	43085 ⁸ 49212 ⁷
-------	-----	---	----------------------	------	------	---	------	--------------------	---	--------	------	-----------------------------	------	--

VAN 1 TON, PB SERIES

74-83	All	↓	↓	G63413	61522 ⁹ 81496	43085 ⁸ 49212 ⁷
	4000# Front Axle	↓	G63360 ³⁵	81834	↓
	Exc. 4000# Front Axle	↓	G63359 ³⁵	58359 ³⁵ 61523 ³⁵ 81096 ³⁵	34052 ⁸	↓

VIP

67	All	↓	82011	↓	49106 ⁷ 82131
----	-----	---	------	------	------	------	-------	---	------	------	------	------	-----------------------------

VOYAGER / GRAND VOYAGER

96-00	All	↓	G55697	M55697	143059 ⁵¹	↓	
	Exc. Hydraulic Self-Leveling System	↓	↓	G63690 ¹⁰	61605 ³⁴ 81878
	Non-ABS	↓	143059 ⁵¹	↓	49236 ⁷	
86-95	All	↓	142933 ⁶⁷ 143059 ⁵¹	↓	G63426	49236 ⁷	
84-85	All	↓	143059 ⁵¹	↓	G63426	49236 ⁷	

PONTIAC

ACADIAN

76-87	All	↓	↓	81340	43140 ⁸
-------	-----	---	------	------	------	------	------	---	------	------	-------	------	--------------------

AZTEK

01-05	All	↓	G57274 ⁴⁰	142526 ⁵⁴	↓
	AWD	↓	↓	G63868	61777
	FWD	↓	↓	G63869

BONNEVILLE

00-05	All	↓	G56509	↓
-------	-----	---	--------	------	------	------	------	---	------	------	------	------	------

6 It is recommended that when replacing shocks on vehicles with "quad shocks" all 4 shocks should be matched by series.;

8 Pair Packs.;

34 If suspension spring contacts this unit, rotate suspension spring 180 degrees.;

40 Complete Assembled Unit.;

53 Hardware from O.E. Part may need to be reused.;

7 Pair Packs, Air hose kit included.;



10 The Nivomat leveling shocks are on the rear only. If suspension spring contacts units, rotate suspension spring 180 degrees.;

35 Slight grinding of control arm opening is required to install product made before Aug 1988.;

51 Strut Cushion for use with the Strut/Cartridge/Shocks.;

54 Kit with Mount and Bearing. Hardware from O.E. Part may need to be reused.;

APPLICATION GUIDE

Year	Fitment Notes										
		Ultra	Ready Mounts	Max Control\ LTV\ ProGuard\ Guardian	Strut Cushion\ Strut Mount\ Dampers\ Stabilizer	HiJackers\ Load Carrier\ Classic	Ultra	Ready Mounts	Max Control\ LTV\ ProGuard\ Guardian	Strut Cushion\ Strut Mount\ Dampers\ Stabilizer	HiJackers\ Load Carrier\ Classic

PONTIAC

PONTIAC

BONNEVILLE (cont)

00-05	Exc. Electronic Adjustable Suspension	↑	G57051 ⁴⁰
	Without OE Style air fitting	↑	49228 ³⁰
00-04	With OE Style air fitting	↑	49255 ⁷
97-99	All	↑	142530 ⁵⁴
94-99	Exc. CCR Computer Command Ride	↑	G56718 ⁹	M56718 ⁹
91-99	Coil(RearSpringType) Exc. Electronic Adjustable Suspension	↑	G56726 ⁴³
91-93	All	↑	G56718 ⁹	M56718 ⁹
87-90	Early Design Front Strut w/ Spring Guard	↑	G56701
	Coil(RearSpringType)	↑	G56726 ⁴³
90	Late Design Front Strut without Spring Guard	↑	G56718 ⁹	M56718 ⁹
87-89	All	↑	143061 ⁵¹
82-86	All	↑	69600	81494	34051 ⁸	69604	81492	43060 ⁸ 49334 ³⁰
71-81	All	↑	69675 ⁵	81446	34073 ⁸	69724	81514	43049 ⁸ 49131 ³⁰
65-70	All	↑	82110	69724	81514	43049 ⁸ 49128 ³⁰
63-64	All	↑	69625	34073 ⁸ 82099	69724	81514	43049 ⁸ 49128 ³⁰
61-62	All	↑	69625	34073 ⁸ 82099
58-60	All	↑	69625	34073 ⁸ 82099	81318	49310 ⁷ 82156
57	All	↑	82026	81318	49310 ⁷ 82156

CATALINA

77-81	Wagon	↑	69604	81492	49152 ³⁰
71-81	All	↑	69675 ⁵	81446	34073 ⁸
	Exc. Wagon	↑	69724	81514	43049 ⁸ 49131 ³⁰
74-75	Wagon	↑	69604	81492	49152 ³⁰
71-73	Wagon	↑	69604	81492
	Wagon Wagon	↑	49152 ³⁰
65-70	All	↑	82110	69724	81514	43049 ⁸ 49128 ³⁰
63-64	All	↑	69625	34073 ⁸ 82099	69724	81514	43049 ⁸ 49128 ³⁰
61-62	All	↑	69625	34073 ⁸ 82099
58-60	All	↑	69625	34073 ⁸ 82099	81318	49310 ⁷ 82156
50-57	All	↑	82026	49310 ⁷ 82156

5 Use kit No. 140719 to replace O.E. hardware for lower shock absorber mounting when studs break or self-tapping screws are not longer useable.;

8 Pair Packs.;

30 For GM Vehicles equipped with factory installed leveling systems, see Ref A.;

43 Does not include springs due to vehicle design. See Ref. D for procedures to replace Elec Adj Susp with non-adj product.;

54 Kit with Mount and Bearing. Hardware from O.E. Part may need to be reused.;



7 Pair Packs, Air hose kit included.;

9 See Ref. D for procedures to replace Elec Adj Susp with non-adj product.;

40 Complete Assembled Unit.;

51 Strut Cushion for use with the Strut/Cartridge/Shocks.;

APPLICATION GUIDE

Year	Fitment Notes										
		Ultra	Ready Mounts	Max Control LTV ProGuard Guardian	Strut Cushion\ Strut Mount\ Dampers\ Stabilizer	HiJackers\ Load Carrier\ Classic	Ultra	Ready Mounts	Max Control LTV ProGuard Guardian	Strut Cushion\ Strut Mount\ Dampers\ Stabilizer	HiJackers\ Load Carrier\ Classic

PONTIAC

PONTIAC

CHIEFTAIN

58	All	⊖	69625	34073 ⁸ 82099	⊖	81318	49310 ⁷ 82156
49-57	All	⊖	82026	⊖	49310 ⁷ 82156

EXECUTIVE

67-70	All	⊖	82110	⊖	69724	81514	43049 ⁸ 49128 ³⁰
-------	-----	---	------	------	------	------	-------	---	-------	------	-------	------	---

FIERO

84-88	All		⊖	143059 ⁵¹
-------	-----	--	------	------	------	------	------	---	------	------	------	----------------------	------

FIREBIRD

93-02	Left	⊖	G57107 ⁴⁰	⊖	69676	75676 81481	49203 ⁷
	Right	⊖	G57108 ⁴⁰	⊖	69676	75676 81481	49203 ⁷
82-92	All	⊖	G56700	⊖	69676	75676 81481	49203 ⁷
70-81	All	⊖	69675 ⁵	81446	34073 ⁸	⊖	69624	81095	49135 ³⁰
68-69	All	⊖	69600	81494	34051 ⁸	⊖	69606	81495	49205 ⁷
67-69	Multi-Leaf Springs		⊖	43140 ⁶
	Single Leaf Spring		⊖	49122 ⁷
67	All	⊖	69600	81494	34051 ⁸	⊖	49205 ⁷
	Single Leaf Rear Springs		⊖	82040

FIREFLY

95-99	All		⊖	G55772
	CAN		143059 ⁵¹	⊖	143057 ⁵¹
94	CAN		143059 ⁵¹	⊖	G55772	143057 ⁵¹
89-91	CAN		143059 ⁵¹	⊖	G55772	143057 ⁵¹

G3

09-10	Left	⊖	G56886	G57130 ⁴⁰	143239 ⁵³
	Right	⊖	G56887	G57131 ⁴⁰	143239 ⁵³
07-08	Left	⊖	G56886
	Right	⊖	G56887

G5

07-09	Left	⊖	G56810	G57047 ⁴⁰	143323 ⁵³	⊖	69587
	Right	⊖	G56810	G57048 ⁴⁰	143323 ⁵³	⊖	69587

5 Use kit No. 140719 to replace O.E. hardware for lower shock absorber mounting when studs break or self-tapping screws are not longer useable;

8 Pair Packs.;



40 Complete Assembled Unit.;

7 Pair Packs, Air hose kit included.;

30 For GM Vehicles equipped with factory installed leveling systems, see Ref A.;

51 Strut Cushion for use with the Strut/Cartridge/Shocks.;

APPLICATION GUIDE

Year	Fitment Notes										
		Ultra	Ready Mounts	Max Control\ LTV\ ProGuard\ Guardian	Strut Cushion\ Strut Mount\ Dampers\ Stabilizer	HiJackers\ Load Carrier\ Classic	Ultra	Ready Mounts	Max Control\ LTV\ ProGuard\ Guardian	Strut Cushion\ Strut Mount\ Dampers\ Stabilizer	HiJackers\ Load Carrier\ Classic

PONTIAC

PONTIAC

G6

06-10	Left	G57121 ⁴⁰	143354 ⁵³	69590
	Right	G57122 ⁴⁰	143355 ⁵³	69590
05-10	Exc. Convertible and 4Cyl Left	G57069 ⁴⁰
	Exc. Convertible and 4Cyl Right	G57070 ⁴⁰
	Maxx Models	143425 ⁶⁸
05	Left	143354 ⁵³	69590
	Right	143355 ⁵³	69590

GRAND AM

99-05	All	G56927 ⁴⁰	M55974	G56928 ⁴⁰	M56501	143057 ⁵¹
92-98	Exc. Electronic Adjustable Suspension	143059 ⁵¹
78-80	All	69600	81494	34051 ⁸	69604	81492	43060 ⁸ 49334 ³⁰
73-75	All	69600	81494	34051 ⁸	69604	81492	43060 ⁸ 49152 ³⁰

GRAND LEMANS

78-83	All	69600	81494	34051 ⁸	69604	81492	43060 ⁸ 49334 ³⁰
75-77	All	69600	81494	34051 ⁸	69604	81492	43060 ⁸ 49152 ³⁰

GRAND PRIX

04-08	All	G57141 ⁴⁰	142526 ⁵⁴
	Models w/ 17" or 18" Wheels	G52244
97-08	Exc. Models w/ 17" Wheels	G55949
	Left	143073 ⁵³
	Left Models w/ 16" Wheels	G56924 ⁴⁰
	Right	143074 ⁵³
	Right Models w/ 16" Wheels	G56925 ⁴⁰
97-03	All	G55948	G57060 ⁴⁰	142526 ⁵⁴
88-96	All	M56708
69-87	All	69600	81494	34051 ⁸	69604	81492	43060 ⁸ 49334 ³⁰
65-68	All	82110	69724	81514	49128 ³⁰
63-64	All	69625	34073 ⁸ 82099	69724	81514	49128 ³⁰
62	All	69625	34073 ⁸ 82099

8 Pair Packs.;

40 Complete Assembled Unit.;

53 Hardware from O.E. Part may need to be reused.;



68 Mount Kit. Hardware from O.E. Part may need to be reused.;

30 For GM Vehicles equipped with factory installed leveling systems, see Ref A.;

51 Strut Cushion for use with the Strut/Cartridge/Shocks.;

54 Kit with Mount and Bearing. Hardware from O.E. Part may need to be reused.;

APPLICATION GUIDE

Year	Fitment Notes										
		Ultra	Ready Mounts	Max Control LTV ProGuard Guardian	Strut Cushion\ Strut Mount\ Dampers\ Stabilizer	HiJackers\ Load Carrier\ Classic	Ultra	Ready Mounts	Max Control LTV ProGuard Guardian	Strut Cushion\ Strut Mount\ Dampers\ Stabilizer	HiJackers\ Load Carrier\ Classic

PONTIAC

GRAND SAFARI

71-78	All	⊕ 69675 ⁵	81446	34073 ⁸	⊕ 69604	81492	43060 ⁸ 49152 ³⁰
-------	-----	----------------------	------	-------	------	--------------------	---------	------	-------	------	---

GRANDVILLE

71-75	All	⊕ 69600	81494	34051 ⁸	⊕ 69604	81492	43060 ⁸ 49152 ³⁰
-------	-----	---------	------	-------	------	--------------------	---------	------	-------	------	---

GTO

04-06	All	⊕	143459 ⁶⁷	⊕
68-73	All	⊕ 69600	81494	⊕ 69604	81492	43060 ⁸ 49152 ³⁰
64-67	All	⊕	82138	⊕
	Exc. Heavy Duty Suspension	⊕	⊕ 69724	81514	43049 ⁸ 49131 ³⁰
	Heavy Duty Suspension	⊕	⊕ 69604	81492	43060 ⁸ 49152 ³⁰

LAURENTIAN

76-81	All	⊕ 69675 ⁵	81446	34073 ⁸	⊕ 69724	43049 ⁸ 49131 ³⁰
	CAN	⊕	⊕	81514

LEMANS

88-93	All	⊕	143057 ⁵¹	⊕
68-81	All	⊕ 69600	81494	34051 ⁸	⊕ 69604	81492	43060 ⁸ 49334 ³⁰
64-67	All	⊕	82138	⊕
	Exc. Heavy Duty Suspension	⊕	⊕ 69724	81514	43049 ⁸ 49131 ³⁰
	Heavy Duty Suspension	⊕	⊕ 69604	81492	43060 ⁸ 49152 ³⁰

MONTANA

07-09	CAN	⊕	⊕ G63776
05-09	SV6, Exc. Self-Leveling Suspension	⊕ G52025	⊕
	SV6, FWD	⊕	G57142 ⁴⁰	⊕
99-09	All	⊕	142526 ⁵⁴	⊕
06	FWD, Exc. Air-Leveling Suspension	⊕	⊕ G63776
99-05	Exc. Air-Leveling Suspension	⊕	⊕ G63776	61659 81924
	Base	⊕ G55948	G57060 ⁴⁰	⊕
	FWD, Exc. Air-Leveling Suspension & Independent Rear Suspension	⊕	⊕	49230 ⁷

PARISIENNE

76-86	All	⊕ 69675 ⁵	81446	34073 ⁸	⊕
	Sedan	⊕	⊕ 69724	81514	43049 ⁸ 49131 ³⁰
	Wagon	⊕	⊕ 69604	81492	43060 ⁸ 49152 ³⁰

5 Use kit No. 140719 to replace O.E. hardware for lower shock absorber mounting when studs break or self-tapping screws are not longer useable.;

8 Pair Packs.;

40 Complete Assembled Unit.;



7 Pair Packs, Air hose kit included.;

30 For GM Vehicles equipped with factory installed leveling systems, see Ref A.;

51 Strut Cushion for use with the Strut/Cartridge/Shocks.;

67 Mount Kit. Hardware from O.E. Part may need to be reused.;



APPLICATION GUIDE

Year	Fitment Notes										
		Ultra	Ready Mounts	Max Control\ LTV\ ProGuard\ Guardian	Strut Cushion\ Strut Mount\ Dampers\ Stabilizer	HiJackers\ Load Carrier\ Classic	Ultra	Ready Mounts	Max Control\ LTV\ ProGuard\ Guardian	Strut Cushion\ Strut Mount\ Dampers\ Stabilizer	HiJackers\ Load Carrier\ Classic





PONTIAC

PONTIAC



PHOENIX

77-79	All	 69600	81494	34051 ⁸	
-------	-----	---	------	-------	------	--------------------	---	------	------	------	------	------











PURSUIT

05-06	Left	 G56810	G57047 ⁴⁰	143323 ⁵³		69587
	Right	 G56810	G57048 ⁴⁰	143323 ⁵³		69587



SAFARI

87-89	All	 69675 ⁵	81446	34073 ⁸		69604	81492	43060 ⁹ 49152 ³⁰
-------	-----	--	------	-------	------	--------------------	---	-------	------	-------	------	---



STAR CHIEF

65-66	All		82110		69724	81514	49128 ³⁰
63-64	All	 69625	34073 ⁸ 82099		69724	81514	49128 ³⁰
61-62	All	 69625	34073 ⁸ 82099	
58-60	All	 69625	34073 ⁸ 82099		81318	49310 ⁷ 82156
54-57	All		82026		49310 ⁷ 82156





STREAMLINER

49-52	All		82026		49310 ⁷ 82156
-------	-----	---	------	------	------	-------	---	------	------	------	------	-----------------------------

SUNBURST

85-88	CAN		143058 ⁵¹	
-------	-----	---	------	------	----------------------	------	---	------	------	------	------	------





SUNFIRE

99-05	All	 G55698	G56951 ⁴⁰	143057 ⁵¹		G55825	G56938 ⁴⁰
95-98	All	 G55698	143057 ⁵¹		G55825	G56938 ⁴⁰



SUNRUNNER

94-97	All			G63799	61560 81904
-------	-----	---	------	------	------	------	---	--------	------	----------------	------	------









SUPER CHIEF

58	All	 69625	34073 ⁸ 82099		81318	49310 ⁷ 82156
57	All		82026		49310 ⁷ 82156

T1000

81-87	All			81340	43140 ⁹
-------	-----	---	------	------	------	------	---	------	------	-------	------	--------------------

TEMPEST

68-70	All	 69600	81494		69604	81492	43060 ⁹ 49152 ³⁰
64-67	All		82138	
	Exc. Heavy Duty Suspension			69724	81514	43049 ⁸ 49131 ³⁰
	Heavy Duty Suspension			69604	81492	43060 ⁹ 49152 ³⁰

5 Use kit No. 140719 to replace O.E. hardware for lower shock absorber mounting when studs break or self-tapping screws are not longer useable.;

8 Pair Packs.;

40 Complete Assembled Unit.;



53 Hardware from O.E. Part may need to be reused.;

7 Pair Packs, Air hose kit included.;

30 For GM Vehicles equipped with factory installed leveling systems, see Ref A.;

51 Strut Cushion for use with the Strut/Cartridge/Shocks.;

APPLICATION GUIDE

Year	Fitment Notes										
		Ultra	Ready Mounts	Max Control\ LTV\ ProGuard\ Guardian	Strut Cushion\ Strut Mount\ Dampers\ Stabilizer	HiJackers\ Load Carrier\ Classic	Ultra	Ready Mounts	Max Control\ LTV\ ProGuard\ Guardian	Strut Cushion\ Strut Mount\ Dampers\ Stabilizer	HiJackers\ Load Carrier\ Classic

PONTIAC

PONTIAC

TORRENT

07-09	All	OO	G64015	61718	
	Left Exc. Models w/ 19" Wheels	↓	G57197 ⁴⁰	↓	
	Left Exc. Sport Suspension	↓	G52127	↓	
	Left Models w/ 19" Wheels	↓	G57322 ⁴⁰	↓	
	Right Exc. Models w/ 19" Wheels	↓	G57198 ⁴⁰	↓	
	Right Exc. Sport Suspension	↓	G52128	↓	
	Right Models w/ 19" Wheels	↓	G57323 ⁴⁰	↓	
06	Left	↓	G56773	G57535 ⁴⁰	143363 ⁵³	OO	G64015	61718
	Right	↓	G56774	G57536 ⁴⁰	143363 ⁵³	OO	G64015	61718

TRANS SPORT

99	All	↓	G55948	G57060 ⁴⁰	142526 ⁵⁴	OO	G63776
97-98	All	↓	G55948	G57060 ⁴⁰	142526 ⁵⁴	OO	G63776	61659 81924	49230 ⁷

VENTURA

73-77	All	⊕	69600	81494	34051 ⁸	⊕
73	Heavy Duty Suspension	⊕	⊕	69724	81514	49157 ⁷
71-72	All	⊕	69600	81494	⊕	43049 ⁸
	Leaf(RearSpringType)	⊕	⊕	69724	81514
	Multi-Leaf Rear Spring	⊕	⊕	49157 ⁷
61	All	⊕	69625	34073 ⁸ 82099	⊕
60	All	⊕	69625	34073 ⁸ 82099	⊕	81318	49310 ⁷ 82156

VIBE

09-10	Left	↓	G52245	↓
	Right	↓	G52246	↓
	AWD, Left 10MM Stud Only	↓	G57329 ⁴⁰	↓
	AWD, Right 10MM Stud Only	↓	G57330 ⁴⁰	↓
	FWD, Left	↓	G57566 ⁴⁰	↓	G51898
	FWD, Right	↓	G57567 ⁴⁰	↓	G51898
03-08	All	↓	↓	143094 ⁵³
	FWD, Left	↓	G52013	G57357 ⁴⁰	↓	G51736	G57067 ⁴⁰
	FWD, Right	↓	G52014	G57358 ⁴⁰	↓	G51736	G57068 ⁴⁰



7 Pair Packs, Air hose kit included.;

40 Complete Assembled Unit.;

8 Pair Packs.;

53 Hardware from O.E. Part may need to be reused.;

APPLICATION GUIDE

Year	Fitment Notes										
		Ultra	Ready Mounts	Max Control\ LTV\ ProGuard\ Guardian	Strut Cushion\ Strut Mount\ Dampers\ Stabilizer	HiJackers\ Load Carrier\ Classic	Ultra	Ready Mounts	Max Control\ LTV\ ProGuard\ Guardian	Strut Cushion\ Strut Mount\ Dampers\ Stabilizer	HiJackers\ Load Carrier\ Classic



PONTIAC

PONTIAC

VIBE (cont)

08	Left		G52013
----	------	---	--------	------	------	------	------	------	------	------



WAVE

05-08	Left		G56886	G57130 ⁴⁰	143239 ⁵³
	Right		G56887	G57131 ⁴⁰	143239 ⁵³

PORSCHE

PORSCHE

924

87-88	All		143058 ⁵¹
77-82	All		143058 ⁵¹





944

83-88	All		143058 ⁵¹
-------	-----	---	------	------	------	----------------------	------	------	------	------





RAM

RAM







1500 CLASSIC

19-20	All		77412
	4WD		G63675
	4WD, Old Body Style		G51856	G57147 ⁴⁰
	RWD, Old Body Style		G64043





1500 (SEE DODGE RAM 1500)

16-18	4WD, Exc. Air Suspension		G51856	G57147 ⁴⁰
	RWD, Exc. Air Suspension		G64043
11-18	All		G63675	77412
11-15	4WD		G51856	G57147 ⁴⁰
	RWD		G64043

2500 (SEE DODGE RAM 2500)

14-20	4WD		G64009	77948
	RWD		77949
	RWD, Standard Cab Pickup		G64043
11-13	All		77950
	4WD		G64009	77948	G64013	61716
	RWD, Standard Cab Pickup		G64043	77949

3500 (SEE DODGE RAM 3500)



21-24	4WD		G63673
20-24	All		G64121	77976
11-20	4WD		G63673	77948
	RWD		77949

40 Complete Assembled Unit.;

53 Hardware from O.E. Part may need to be reused.;

51 Strut Cushion for use with the Strut/Cartridge/Shocks.;

APPLICATION GUIDE

Year	Fitment Notes										
		Ultra	Ready Mounts	Max Control LTV ProGuard Guardian	Strut Cushion\ Strut Mount\ Dampers\ Stabilizer	HiJackers\ Load Carrier\ Classic	Ultra	Ready Mounts	Max Control LTV ProGuard Guardian	Strut Cushion\ Strut Mount\ Dampers\ Stabilizer	HiJackers\ Load Carrier\ Classic

RAM

RAM

3500 (SEE DODGE RAM 3500) (cont)

11-20	RWD, Crew Cab Pickup
	RWD, Standard Cab Pickup	G64043
11-13	All	77950

C/V

12-15	All	G57206 ⁴⁰
	Exc. Load Leveling	G64042

DAKOTA

11	4WD	G63891
	RWD	G63890

PROMASTER 1500

14-25	Left	G57800 ⁴⁰
	Right	G57801 ⁴⁰

PROMASTER 2500

14-25	Left	G57800 ⁴⁰
	Right	G57801 ⁴⁰

PROMASTER 3500

14-25	Left	G57800 ⁴⁰
	Right	G57801 ⁴⁰

PROMASTER CITY

15-21	Left	G57852 ⁴⁰
	Right	G57853 ⁴⁰

SAAB

SAAB

9-3

03-11	Left	G52175
	Right	G52176
	FWD	70039
99-02	Exc. Viggen	70020

9-7X

05-09	All	G51718 ⁴⁵	G57022 ⁴⁰	G63842	61717 77971
-------	-----	----------------------	----------------------	-------	-------	-------	-------	--------	-------	----------------	-------	-------



93

56-57	All	81676
-------	-----	-------	-------	-------	-------	-------	-------	-------	-------	-------	-------	-------

93B

58-59	All	81676
-------	-----	-------	-------	-------	-------	-------	-------	-------	-------	-------	-------	-------

APPLICATION GUIDE

Year	Fitment Notes										
		Ultra	Ready Mounts	Max Control\ LTV\ ProGuard\ Guardian	Strut Cushion\ Strut Mount\ Dampers\ Stabilizer	HiJackers\ Load Carrier\ Classic	Ultra	Ready Mounts	Max Control\ LTV\ ProGuard\ Guardian	Strut Cushion\ Strut Mount\ Dampers\ Stabilizer	HiJackers\ Load Carrier\ Classic



SAAB

SAAB



99

69-78	All		81270	49105 ⁷
-------	-----	--	------	------	------	------	------	------	-------	------	--------------------

900

94-98	Turbocharged(Eng Asp)		G44461 ⁹⁸
86-98	All		143057 ⁵¹
93	Turbocharged(Eng Asp) Mfg. from 6/30/93		G44461 ⁹⁸

9000

88-98	All		143061 ⁵¹
86-87	All		143058 ⁵¹

GT750

58-59	All		81676
-------	-----	--	------	------	------	------	------	------	-------	------	------

GT850

63	All		81676
----	-----	--	------	------	------	------	------	------	-------	------	------











SATURN

SATURN







ASTRA

08-09	All		69587
-------	-----	--	------	------	------	------	------	------	-------	------	------

AURA

08-09	XE, Left		G57121 ⁴⁰
07-09	Left		143354 ⁵³
	Right		143355 ⁵³
	4Cyl: Exc. Hybrid Models Right		G57122 ⁴⁰
	Exc. Hybrid Models		69590
	Maxx Models		143425 ⁶⁸
09	4Cyl: Exc. Classic and Hybrid Models Left		G57121 ⁴⁰
07-08	4Cyl: Exc. Hybrid Models Left		G57121 ⁴⁰
	Exc. Hybrid Models & 4Cyl Left		G57069 ⁴⁰
	Exc. Hybrid Models & 4Cyl Right		G57070 ⁴⁰

ION

04-07	Left		G56809	G57099 ⁴⁰	143089 ⁵³		69587
	Right		G56809	G57100 ⁴⁰	143089 ⁵³		69587
03	Left		G56809	G57099 ⁴⁰	143089 ⁵⁴		69587

7 Pair Packs, Air hose kit included.;

51 Strut Cushion for use with the Strut/Cartridge/Shocks.;

54 Kit with Mount and Bearing. Hardware from O.E. Part may need to be reused.;



98 Notice:The level of difficulty to install this product is moderately high. Please review the installation instructions carefully before proceeding;

40 Complete Assembled Unit.;

53 Hardware from O.E. Part may need to be reused.;

68 Mount Kit. Hardware from O.E. Part may need to be reused.;



APPLICATION GUIDE

Year	Fitment Notes										
		Ultra	Ready Mounts	Max Control\ LTV\ ProGuard\ Guardian	Strut Cushion\ Strut Mount\ Dampers\ Stabilizer	HiJackers\ Load Carrier\ Classic	Ultra	Ready Mounts	Max Control\ LTV\ ProGuard\ Guardian	Strut Cushion\ Strut Mount\ Dampers\ Stabilizer	HiJackers\ Load Carrier\ Classic



SATURN

SATURN







ION (cont)

03	Right		G56809	G57100 ⁴⁰	143089 ⁵⁴		G69587
----	-------	---	--------	----------------------	------	----------------------	------	---	--------	------	------	------	------













L / LS / LW SERIES

00-05	All			G51759
-------	-----	---	------	------	------	------	------	---	--------	------	------	------	------



OUTLOOK

07-10	All		G52125	143366 ⁵³		G64040
	AWD		G57109 ⁴⁰	
	FWD		G57314 ⁴⁰	



















RELAY

05-07	Air-Leveling Suspension, Exc. Independent Rear Suspension			49230 ⁷
	Exc. Auto-Leveling System		G52025	
	FWD		142526 ⁵⁴	
	FWD, Exc. Air-Leveling Suspension			G63776
07	1, 2, 3, FWD		G57142 ⁴⁰	
05-06	2, 3, FWD		G57142 ⁴⁰	

SC / SL / SW SERIES

91-02	All		G57013 ⁴⁰	143057 ⁵¹		G57014 ⁴⁰	142245 ⁵³ 143059 ⁵¹
-------	-----	---	------	----------------------	------	----------------------	------	---	------	----------------------	------	--	------





VUE

08-10	All			G63872
	Left		G52127	
	Left Exc. Models w/ 19" Wheels		G57197 ⁴⁰	
	Left Models w/ 19" Wheels		G57322 ⁴⁰	
	Right		G52128	
	Right Exc. Models w/ 19" Wheels		G57198 ⁴⁰	
	Right Models w/ 19" Wheels		G57323 ⁴⁰	
02-07	Left		G52026		G63872
	Right		G52027		G63872

SCION

SCION

TC

05-10	Left		G52096	G57369 ⁴⁰	143406 ⁵³		G51852	G57428 ⁴⁰	143094 ⁵³
	Right		G52097	G57370 ⁴⁰	143406 ⁵³		G51852	G57429 ⁴⁰	143094 ⁵³



7 Pair Packs, Air hose kit included.;

51 Strut Cushion for use with the Strut/Cartridge/Shocks.;

40 Complete Assembled Unit.;

53 Hardware from O.E. Part may need to be reused.;



APPLICATION GUIDE

Year	Fitment Notes										
		Ultra	Ready Mounts	Max Control\ LTV\ ProGuard\ Guardian	Strut Cushion\ Strut Mount\ Dampers\ Stabilizer	HiJackers\ Load Carrier\ Classic	Ultra	Ready Mounts	Max Control\ LTV\ ProGuard\ Guardian	Strut Cushion\ Strut Mount\ Dampers\ Stabilizer	HiJackers\ Load Carrier\ Classic





SCION

SCION



XA

04-06	All		G52098		70028
-------	-----	---	--------	------	------	------	------	---	-------	------	------	------	------

XB

08-15	Left		G52264	G57722 ⁴⁰		70053
	Right		G52265	G57723 ⁴⁰		70053
04-06	All		G52098		70028



XD

08-10	All			70055
-------	-----	---	------	------	------	------	------	---	-------	------	------	------	------





STUDEBAKER

STUDEBAKER



AVANTI

63-64	All		82087		82103
-------	-----	---	------	------	------	------	-------	---	------	------	------	------	-------



CHAMPION

57-58	All		82087		82151
50	All		82026		82060



COMMANDER

57-58	All		82087		82151
-------	-----	---	------	------	------	------	-------	---	------	------	------	------	-------



GOLDEN HAWK

57-58	All		82087		82151
-------	-----	---	------	------	------	------	-------	---	------	------	------	------	-------



HAWK

60-62	All		82087		82151
-------	-----	---	------	------	------	------	-------	---	------	------	------	------	-------





LARK

59-62	All		82087		82151
-------	-----	---	------	------	------	------	-------	---	------	------	------	------	-------



POWER HAWK

56	All		82026		82060
----	-----	---	------	------	------	------	-------	---	------	------	------	------	-------



PRESIDENT

57-58	All		82087		82151
55-56	All		82026		82060

SILVER HAWK

57-59	All		82087		82151
-------	-----	---	------	------	------	------	-------	---	------	------	------	------	-------



SKY HAWK

56	All		82026		82060
----	-----	---	------	------	------	------	-------	---	------	------	------	------	-------



SUBARU

SUBARU



BAJA

03-06	All			G51767
-------	-----	---	------	------	------	------	------	---	--------	------	------	------	------

BRAT

80-87	All		143061 ⁵¹	
-------	-----	---	------	------	------	----------------------	------	---	------	------	------	------	------

APPLICATION GUIDE

Year	Fitment Notes										
		Ultra	Ready Mounts	Max Control LTV ProGuard Guardian	Strut Cushion\ Strut Mount\ Dampers\ Stabilizer	HiJackers\ Load Carrier\ Classic	Ultra	Ready Mounts	Max Control LTV ProGuard Guardian	Strut Cushion\ Strut Mount\ Dampers\ Stabilizer	HiJackers\ Load Carrier\ Classic

SUBARU

SUBARU

DL

85-89	All	143061 ⁵¹
-------	-----	-------	-------	-------	----------------------	-------	-------	-------	-------	-------

FORESTER

11-13	Left	G52374	G57704 ⁴⁰	143492 ⁵³	G51961	G57706 ⁴⁰
	Right	G52375	G57705 ⁴⁰	143492 ⁵³	G51961	G57706 ⁴⁰
09-10	Left	G52374	143492 ⁵³	G51961	G57706 ⁴⁰
	Right	G52375	143492 ⁵³	G51961	G57706 ⁴⁰
	AWD, Left	G57628 ⁴⁰
	AWD, Right	G57629 ⁴⁰
06-08	Manual Left	143492 ⁵³	G52182
	Manual Right	143492 ⁵³	G52183
04-05	2.5L Left	G57459 ⁴⁰
	2.5L Right	G57460 ⁴⁰
03-05	All	143492 ⁵³
98-02	All	143057 ⁵¹ 143492 ⁵³	143057 ⁵¹

GL

85-89	Hatchback	143061 ⁵¹
-------	-----------	-------	-------	-------	----------------------	-------	-------	-------	-------	-------



IMPREZA

12-14	All	G57703 ⁴⁰
	Exc. Sti	143492 ⁵³
08-14	Sport, Left	G57701 ⁴⁰
	Sport, Right	G57702 ⁴⁰
08-11	All	143492 ⁵³	G57703 ⁴⁰
	Exc. Sport Left	G57644 ⁴⁰
	Exc. Sport Right	G57645 ⁴⁰
04-07	Exc. Sti	143492 ⁵³
02-03	Left	143492 ⁵³	143465 ⁵³
	Right	143492 ⁵³	143466 ⁵³
	RS, Left	G57634 ⁴⁰
	RS, Right	G57635 ⁴⁰

40 Complete Assembled Unit;

51 Strut Cushion for use with the Strut/Cartridge/Shocks.;

APPLICATION GUIDE

Year	Fitment Notes										
		Ultra	Ready Mounts	Max Control\ LTV\ ProGuard\ Guardian	Strut Cushion\ Strut Mount\ Dampers\ Stabilizer	HiJackers\ Load Carrier\ Classic	Ultra	Ready Mounts	Max Control\ LTV\ ProGuard\ Guardian	Strut Cushion\ Strut Mount\ Dampers\ Stabilizer	HiJackers\ Load Carrier\ Classic

SUBARU

SUBARU

IMPREZA (cont)

93-01	All		143492 ⁵³
-------	-----	--	-------	-------	-------	----------------------	-------	--	-------	-------	-------	-------	-------

LEGACY

10-13	All		143492 ⁵³
10-12	Exc. GT Submodel Left		G57673 ⁴⁰	G57675 ⁴⁰
	Exc. GT Submodel Right		G57674 ⁴⁰	G57675 ⁴⁰
05-09	Left		G57345 ⁴⁰	143492 ⁵³	G57423 ⁴⁰
	Right		G57346 ⁴⁰	143492 ⁵³	G57423 ⁴⁰
03-04	Left		G57515 ⁴⁰	143492 ⁵³
	Right		G57516 ⁴⁰	143492 ⁵³
00-02	All		143492 ⁵³
90-99	All		143057 ⁵¹ 143492 ⁵³	143057 ⁵¹

LOYALE

90-94	All		143061 ⁵¹	143064 ⁵¹
-------	-----	--	-------	-------	-------	----------------------	-------	--	-------	-------	-------	----------------------	-------

OUTBACK

15-16	All		G57799 ⁴⁰
13-14	Left		G57780 ⁴⁰	143492 ⁵³	G57799 ⁴⁰
	Right		G57781 ⁴⁰	143492 ⁵³	G57799 ⁴⁰
10-12	All		143492 ⁵³
05-09	Left		G57339 ⁴⁰	143492 ⁵³		G51910
	Right		G57340 ⁴⁰	143492 ⁵³		G51910
00-04	Left		G57341 ⁴⁰	143492 ⁵³		G51767
	Right		G57342 ⁴⁰	143492 ⁵³		G51767

XT

85-91	FWD, Coil(RearSpringType)		143064 ⁵¹
-------	---------------------------	--	-------	-------	-------	-------	-------	--	-------	-------	-------	----------------------	-------

SUZUKI

SUZUKI

AERIO

02-07	All		143401 ⁶⁷	143418 ⁶³
-------	-----	--	-------	-------	-------	----------------------	-------	--	-------	-------	-------	----------------------	-------

EQUATOR

09-12	All		G51765	G57413 ⁴⁰		OO	G64031
-------	-----	--	--------	----------------------	-------	-------	-------	--	----	--------	-------	-------	-------



40 Complete Assembled Unit.;

53 Hardware from O.E. Part may need to be reused.;

51 Strut Cushion for use with the Strut/Cartridge/Shocks.;

67 Mount Kit. Hardware from O.E. Part may need to be reused.;

APPLICATION GUIDE

Year	Fitment Notes										
		Ultra	Ready Mounts	Max Control LTV ProGuard Guardian	Strut Cushion\ Strut Mount\ Dampers\ Stabilizer	HiJackers\ Load Carrier\ Classic	Ultra	Ready Mounts	Max Control LTV ProGuard Guardian	Strut Cushion\ Strut Mount\ Dampers\ Stabilizer	HiJackers\ Load Carrier\ Classic

SUZUKI

SUZUKI

ESTEEM

95-02	All	↓	143057 ⁵¹	↓	143057 ⁵¹
-------	-----	---	-------	-------	-------	----------------------	-------	---	-------	-------	-------	----------------------	-------

FORENZA

04-08	Left	↓	G57126 ⁴⁰	143349 ⁶⁷	↓	G57128 ⁴⁰
	Right	↓	G57127 ⁴⁰	143349 ⁶⁷	↓	G57129 ⁴⁰

GRAND VITARA

06-13	Left	↓	G52184	↓	G64052
	Right	↓	G52185	↓	G64052
05	All	↓	↓	G63799	61560 81904
99-04	All	↓	143204 ⁵³	↓	G63799	61560 81904

RENO

05-08	Left	↓	G57126 ⁴⁰	143349 ⁶⁷	↓	G57128 ⁴⁰
	Right	↓	G57127 ⁴⁰	143349 ⁶⁷	↓	G57129 ⁴⁰

SAMURAI

86-95	All	↓	81675	↓	61550 81676
	Single System Steering Stabilizer	↓	6802SE ⁸⁴										

SIDEKICK

89-98	Non-ABS	↓	↓	G63799	61560 81904
-------	---------	---	-------	-------	-------	-------	-------	---	--------	-------	----------------	-------	-------

SWIFT

07-09	Left	↓	G56886	G57130 ⁴⁰	143059 ⁵¹	↓
	Right	↓	G56887	G57131 ⁴⁰	143059 ⁵¹	↓
04-06	Left	↓	G56886	G57130 ⁴⁰	↓
	Right	↓	G56887	G57131 ⁴⁰	↓
89-01	All	↓	143059 ⁵¹	↓	G55772	143057 ⁵¹

VITARA

99-04	Non-ABS	↓	143204 ⁵³	↓	G63799	61560 81904
-------	---------	---	-------	-------	-------	----------------------	-------	---	--------	-------	----------------	-------	-------

X-90

96-98	All	↓	↓	G63799	61560 81904
-------	-----	---	-------	-------	-------	-------	-------	---	--------	-------	----------------	-------	-------

XL-7

07-09	Exc. 3rd Row Seating	↓	↓	G64015	61718
	Left	↓	G52127	↓
	Left Exc. Models w/ 19" Wheels	↓	G57197 ⁴⁰	↓



40 Complete Assembled Unit;

53 Hardware from O.E. Part may need to be reused;

51 Strut Cushion for use with the Strut/Cartridge/Shocks.;

67 Mount Kit. Hardware from O.E. Part may need to be reused;;

APPLICATION GUIDE

Year	Fitment Notes										
		Ultra	Ready Mounts	Max Control\ LTV\ ProGuard\ Guardian	Strut Cushion\ Strut Mount\ Dampers\ Stabilizer	HiJackers\ Load Carrier\ Classic	Ultra	Ready Mounts	Max Control\ LTV\ ProGuard\ Guardian	Strut Cushion\ Strut Mount\ Dampers\ Stabilizer	HiJackers\ Load Carrier\ Classic

SUZUKI

SUZUKI

XL-7 (cont)

07-09	Left Models w/ 19" Wheels	G57322 ⁴⁰
	Right	G52128
	Right Exc. Models w/ 19" Wheels	G57198 ⁴⁰
	Right Models w/ 19" Wheels	G57323 ⁴⁰
02-06	All	143204 ⁵³

THOR MOTOR COACH

THOR MOTOR COACH

DAZZLE

25	2JB, Left	G57800 ⁴⁰
	2JB, Right	G57801 ⁴⁰

FOUR WINDS 282

25	All	G63622
	
	
	MotorHomes with Ford E350 or E450 Chassis	58622
.....	77614

SCOPE

24	18M, Left	G57800 ⁴⁰
	18M, Right	G57801 ⁴⁰

TOYOTA

TOYOTA

4RUNNER



17-18	All	G51739
	RWD, Left Exc. Kinetic Suspension	G57133 ⁴⁰
	RWD, Right Exc. Kinetic Suspension	G57134 ⁴⁰
13-16	All	G51739
03-16	Left Exc. X-Reas Suspension; Exc. Sport Models	G57133 ⁴⁰
	Right Exc. X-Reas Suspension; Exc. Sport Models	G57134 ⁴⁰
03-12	All	G51739
	Exc. X-REAS Suspension; Exc. Sport Models
96-02	Left	G57065 ⁴⁰	49387 ⁷
	Right	G57066 ⁴⁰	49387 ⁷
	4WD	G51077	143325 ⁵³

7 Pair Packs, Air hose kit included.;

40 Complete Assembled Unit.;

53 Hardware from O.E. Part may need to be reused.;







APPLICATION GUIDE

Year	Fitment Notes										
		Ultra	Ready Mounts	Max Control LTV ProGuard Guardian	Strut Cushion\ Strut Mount\ Dampers\ Stabilizer	HiJackers\ Load Carrier\ Classic	Ultra	Ready Mounts	Max Control LTV ProGuard Guardian	Strut Cushion\ Strut Mount\ Dampers\ Stabilizer	HiJackers\ Load Carrier\ Classic

































TOYOTA

TOYOTA













4RUNNER (cont)

90-95	All		G63547	61552 77479 81870		G63548	77726	49388 ⁷
86-89	All		G63479	61552 77479 81870		G63494	61510 77494 81871
84-85	All		G63404		G63494	61510 77494 81871
	Single System Steering Stabilizer		6803SE ⁶⁴										

AVALON

12	Left		G57539 ⁴⁰	
	Right		G57540 ⁴⁰	
07-11	Left		G57539 ⁴⁰		G57192 ⁴⁰
	Left Mfg. from 1/06			G52103
	Right		G57540 ⁴⁰		G57193 ⁴⁰
	Right Mfg. from 1/06			G52104
06	Left Mfg. from 1/06		G57539 ⁴⁰		G52103	G57192 ⁴⁰
	Right Mfg. from 1/06		G57540 ⁴⁰		G52104	G57193 ⁴⁰
04	All		142556 ⁶⁷	
	Left		142650 ⁵⁴	
	Right		142649 ⁵⁴	
97-03	All		142556 ⁶⁷ 143057 ⁵¹		143057 ⁵¹
	Left		G56506	G56930 ⁴⁰	142650 ⁵⁴		G55675	G56932 ⁴⁰	143057 ⁵¹
	Right		G56514	G56931 ⁴⁰	142649 ⁵⁴		G55676	G56933 ⁴⁰	143057 ⁵¹
95-96	Left		M56502	142556 ⁶⁷ 142836 ⁵⁴ 143057 ⁵¹		G55675	G56932 ⁴⁰	143057 ⁵¹
	Right		M56502	142556 ⁶⁷ 142836 ⁵⁴ 143057 ⁵¹		G55676	G56933 ⁴⁰	143057 ⁵¹

CAMRY

14-17	SE, Left			G57499 ⁴⁰
	SE, Right			G57500 ⁴⁰
12-13	Left			G57499 ⁴⁰
	Right			G57500 ⁴⁰
07-11	Left		G57190 ⁴⁰		G52103	G57192 ⁴⁰
	Right		G57191 ⁴⁰		G52104	G57193 ⁴⁰

7 Pair Packs, Air hose kit included.;

51 Strut Cushion for use with the Strut/Cartridge/Shocks.;



190 67 Mount Kit. Hardware from O.E. Part may need to be reused.;

40 Complete Assembled Unit.;

54 Kit with Mount and Bearing. Hardware from O.E. Part may need to be reused.;

84 Replacement damper for vehicles with the Gabriel Aftermarket mounting kit;

APPLICATION GUIDE

Year	Fitment Notes										
		Ultra	Ready Mounts	Max Control\ LTV\ ProGuard\ Guardian	Strut Cushion\ Strut Mount\ Dampers\ Stabilizer	HiJackers\ Load Carrier\ Classic	Ultra	Ready Mounts	Max Control\ LTV\ ProGuard\ Guardian	Strut Cushion\ Strut Mount\ Dampers\ Stabilizer	HiJackers\ Load Carrier\ Classic



TOYOTA

TOYOTA







CAMRY (cont)

06	Left		G56721	143202 ⁵⁴		G56728	G57078 ⁴⁰
	Right		G56722	143202 ⁵⁴		G56729	G57079 ⁴⁰
	4Cyl Left		G57076 ⁴⁰	
	4Cyl Right		G57077 ⁴⁰	
05	Left		G56721	G57076 ⁴⁰	143202 ⁵⁴		G56728	G57078 ⁴⁰
	Right		G56722	G57077 ⁴⁰	143202 ⁵⁴		G56729	G57079 ⁴⁰
04	Left		G56721	143202 ⁵⁴		G56728	G57078 ⁴⁰
	Right		G56722	143202 ⁵⁴		G56729	G57079 ⁴⁰
	4Cyl Left		G57076 ⁴⁰	
	4Cyl Right		G57077 ⁴⁰	
02-03	Left		G57041 ⁴⁰	143202 ⁵⁴		G57043 ⁴⁰
	Right		G57042 ⁴⁰	143202 ⁵⁴		G57044 ⁴⁰
97-01	All		142556 ⁶⁷ 143057 ⁵¹		143057 ⁵¹
	Left		G56506	G56930 ⁴⁰	142650 ⁵⁴		G55675	G56932 ⁴⁰	143057 ⁵¹
	Right		G56514	G56931 ⁴⁰	142649 ⁵⁴		G55676	G56933 ⁴⁰	143057 ⁵¹
95-96	Left		M56502	142556 ⁶⁷ 142836 ⁵⁴ 143057 ⁵¹		G55675	G56932 ⁴⁰	143057 ⁵¹
	Right		M56502	142556 ⁶⁷ 142836 ⁵⁴ 143057 ⁵¹		G55676	G56933 ⁴⁰	143057 ⁵¹
92-94	All		142561 ⁵⁴ 143057 ⁵¹		143057 ⁵¹
	Left Sealed OE Struts			G55675	G56932 ⁴⁰
	Right Sealed OE Struts			G55676	G56933 ⁴⁰
87-91	All		143057 ⁵¹		143057 ⁵¹
83-86	All		143058 ⁵¹	

CARINA

72-73	All		143059 ⁵¹	
-------	-----	---	------	------	------	----------------------	------	---	------	------	------	------	------

CELICA

00-05	All		143201 ⁵³		143094 ⁵³
94-99	All		142556 ⁶⁷	
92-93	All			143057 ⁵¹

40 Complete Assembled Unit.;



53 Hardware from O.E. Part may need to be reused.;

67 Mount Kit. Hardware from O.E. Part may need to be reused.;

51 Strut Cushion for use with the Strut/Cartridge/Shocks.;

54 Kit with Mount and Bearing. Hardware from O.E. Part may need to be reused.;

APPLICATION GUIDE

Year	Fitment Notes										
		Ultra	Ready Mounts	Max Control LTV ProGuard Guardian	Strut Cushion\ Strut Mount\ Dampers\ Stabilizer	HiJackers\ Load Carrier\ Classic	Ultra	Ready Mounts	Max Control LTV ProGuard Guardian	Strut Cushion\ Strut Mount\ Dampers\ Stabilizer	HiJackers\ Load Carrier\ Classic

TOYOTA

TOYOTA

CELICA (cont)

92-93	GT, GTS, ST	↑	143059 ⁵¹
90-91	AWD	↑	143059 ⁵¹	143059 ⁵¹
88-89	All	↑	143059 ⁵¹
	GT, GTS, ST	↑	142249 ⁵³
86-87	All	↑	143059 ⁵¹	142249 ⁵³
78-85	All	↑	143057 ⁵¹	81416
75-77	All	↑	143057 ⁵¹



COROLLA

14-17	Left	↑	G57543 ⁴⁰	G51898
	Right	↑	G57544 ⁴⁰	G51898
13	Left	↑	G52245	G51898
	Right	↑	G52246	G51898
09-12	All	↑	G51898
	Left	↑	G52245
	Left 10MM Stud Only	↑	G57329 ⁴⁰
	Right	↑	G52246
	Right 10MM Stud Only	↑	G57330 ⁴⁰
09-10	XRS, Left	↑	G57451 ⁴⁰
	XRS, Left AWD	↑	G57572 ⁴⁰
	XRS, Right	↑	G57452 ⁴⁰
	XRS, Right AWD	↑	G57573 ⁴⁰
03-08	Left	↑	G56661	G57114 ⁴⁰	143201 ⁵³	G51736	G57067 ⁴⁰	143094 ⁵³
	Right	↑	G56660	G57115 ⁴⁰	143201 ⁵³	G51736	G57068 ⁴⁰	143094 ⁵³
98-02	Left	↑	G55999	G56948 ⁴⁰	143057 ⁵¹ 143281 ⁵³	G55661	G56949 ⁴⁰	143057 ⁵¹
	Right	↑	G55999	G56948 ⁴⁰	143057 ⁵¹ 143281 ⁵³	G55662	G56950 ⁴⁰	143057 ⁵¹
93-97	Left	↑	G55999	143057 ⁵¹ 143281 ⁵³	G55661	G56949 ⁴⁰	143057 ⁵¹
	Right	↑	G55999	143057 ⁵¹ 143281 ⁵³	G55662	G56950 ⁴⁰	143057 ⁵¹
89-92	All	↑	143059 ⁵¹ 143281 ⁵³

40 Complete Assembled Unit;

51 Strut Cushion for use with the Strut/Cartridge/Shocks.;

















APPLICATION GUIDE

Year	Fitment Notes										
		Ultra	Ready Mounts	Max Control\ LTV\ ProGuard\ Guardian	Strut Cushion\ Strut Mount\ Dampers\ Stabilizer	HiJackers\ Load Carrier\ Classic	Ultra	Ready Mounts	Max Control\ LTV\ ProGuard\ Guardian	Strut Cushion\ Strut Mount\ Dampers\ Stabilizer	HiJackers\ Load Carrier\ Classic

















TOYOTA

TOYOTA

COROLLA (cont)

88-92	FWD		G55591	143058 ⁵¹	...
88	All		143281 ⁵³
	DLX, GTS, LE, SR5		143059 ⁵¹
	FX, FX16		143057 ⁵¹
84-87	All		143057 ⁵¹
	FWD		143058 ⁵¹
82-83	All		143057 ⁵¹
80-83	Wagon		81416
80-81	All		143057 ⁵¹
76-79	Coupe		81340
75-79	Wagon		81416
72-79	All		43140 ⁵
	Sedan		81340
75-78	Hardtop		81340
72-74	Coupe		81340
74	Mfg. from 8/74		143057 ⁵¹
	Mfg. from 8/74; Wagon		81416



CORONA

79-82	All		143059 ⁵¹
	Exc. Wagon		81416
79-81	Wagon		81340
74-78	Wagon		49310 ⁷ 82156
78	All		69600	81494
73-77	Mfg. from 8/73		69600
67-77	All		81494
74-76	Exc. Wagon		81340	82155
72-73	Exc. Wagon		81340	43140 ⁵ 82155
73	Wagon		49310 ⁷
	Wagon Mfg. from 8/73		82156
69-72	Mark II		69600
68-71	Exc. Wagon		43140 ⁵ 82155
71	Mark II, Wagon		49310 ⁷
	Mark II, Wagon Exc. Wagon		82156
69-70	Mark II, Wagon		49310 ⁷ 82156

7 Pair Packs, Air hose kit included.;
51 Strut Cushion for use with the Strut/Cartridge/Shocks.;

8 Pair Packs.;
53 Hardware from O.E. Part may need to be reused.;

APPLICATION GUIDE

Year	Fitment Notes										
		Ultra	Ready Mounts	Max Control LTV ProGuard Guardian	Strut Cushion\ Strut Mount\ Dampers\ Stabilizer	HiJackers\ Load Carrier\ Classic	Ultra	Ready Mounts	Max Control LTV ProGuard Guardian	Strut Cushion\ Strut Mount\ Dampers\ Stabilizer	HiJackers\ Load Carrier\ Classic

TOYOTA

TOYOTA

CRESSIDA

78-92	All	↑	143059 ⁵¹	↑
85-88	Sedan Exc. Electronic Adjustable Suspension	↑	↑	81440
81-87	Wagon	↑	↑	81416
83-84	Sedan	↑	↑	81440
81-82	Sedan Exc. Electronic Adjustable Suspension	↑	↑	81440
79-80	Wagon	↑	↑	81340	43140 ⁸
78-80	Sedan	↑	↑	81440
78	Wagon	↑	↑	81340

CROWN

67	All	↑	69625	34073 ⁸	↑
	Mfg. to 9/67	↑	82099	↑
65-66	All	↑	69625	34073 ⁸ 82099	↑
	Wagon	↑	↑	49310 ⁷
	Wagon Wagon	↑	↑	82156

ECHO

00-05	All	↑	G57397 ⁴⁰	↑	69450
	Only fits OE P/N's 48609-52011 & 48609-52050	↑	143194 ⁵³	↑

FJ CRUISER

11-14	4WD	↑	↑	G64030
07-14	Left	↑	G51739	G57133 ⁴⁰	↑
	Right	↑	G51739	G57134 ⁴⁰	↑
	RWD	↑	↑	G64029
07-09	4WD	↑	↑	G64030

HIGHLANDER

14-18	Left	↑	G57782 ⁴⁰	↑	G64186
	Right	↑	G57783 ⁴⁰	↑	G64186
11-13	AWD, Left	↑	↑	G57658 ⁴⁰
	AWD, Right	↑	↑	G57659 ⁴⁰
	FWD, Left	↑	G57720 ⁴⁰	↑	G52203	G57790 ⁴⁰
	FWD, Right	↑	G57721 ⁴⁰	↑	G52204	G57791 ⁴⁰
08-10	Left	↑	G52201	↑
	Right	↑	G52202	↑



7 Pair Packs, Air hose kit included.;

40 Complete Assembled Unit.;

8 Pair Packs.;

51 Strut Cushion for use with the Strut/Cartridge/Shocks.;

APPLICATION GUIDE

Year	Fitment Notes										
		Ultra	Ready Mounts	Max Control\ LTV\ ProGuard\ Guardian	Strut Cushion\ Strut Mount\ Dampers\ Stabilizer	HiJackers\ Load Carrier\ Classic	Ultra	Ready Mounts	Max Control\ LTV\ ProGuard\ Guardian	Strut Cushion\ Strut Mount\ Dampers\ Stabilizer	HiJackers\ Load Carrier\ Classic

TOYOTA

TOYOTA

HIGHLANDER (cont)

08-10	AWD, Left w/o 3rd Row Seat	G57658 ⁴⁰
	AWD, Right w/o 3rd Row Seat	G57659 ⁴⁰
	AWD; Exc. 3.5L Left	G57481 ⁴⁰
	AWD; Exc. 3.5L Right	G57482 ⁴⁰
	FWD, Left	G52203	G57483 ⁴⁰
	FWD, Right	G52204	G57484 ⁴⁰
04-07	Left	G56730	143202 ⁵⁴	143387 ⁶⁷
	Right	G56731	143202 ⁵⁴	143388 ⁶⁷
	AWD, Left	G56732	G57152 ⁴⁰
	AWD, Right	G56733	G57153 ⁴⁰
	FWD, Left	G56734	G57533 ⁴⁰
	FWD, Right	G56735	G57534 ⁴⁰
01-03	Left	G56679	143202 ⁵⁴
	Right	G56680	143202 ⁵⁴
	AWD, Left	G57648 ⁴⁰
	AWD, Right	G57649 ⁴⁰

LAND CRUISER

98-07	All	G63832	G63828
93-97	All	G63615	G63616
91-92	All	G63615
	FJ80(MfrBodyCode)	G63616
88-90	All	G63432	G63510
84-87	All	49311 ⁷
	Sport Utility, FJ60(MfrBodyCode)	G63432	G63492	61506 81318
81-83	Sport Utility, FJ60(MfrBodyCode)	G63432
80-83	All	G63492	61506 81318	49311 ⁷
	FJ40(MfrBodyCode)	G63299	82007
79	All	G63492	81318	43140 ⁸ 49311 ⁷
	FJ40(MfrBodyCode)	G63299	82007	61506
	Sport Utility, FJ55(MfrBodyCode)	81340	61506
76-78	All	G63492	61506 81318	43140 ⁸ 49311 ⁷

7 Pair Packs, Air hose kit included.;



40 Complete Assembled Unit.;

67 Mount Kit. Hardware from O.E. Part may need to be reused.;

8 Pair Packs.;

54 Kit with Mount and Bearing. Hardware from O.E. Part may need to be reused.;

APPLICATION GUIDE

Year	Fitment Notes										
		Ultra	Ready Mounts	Max Control LTV ProGuard Guardian	Strut Cushion\ Strut Mount\ Dampers\ Stabilizer	HiJackers\ Load Carrier\ Classic	Ultra	Ready Mounts	Max Control LTV ProGuard Guardian	Strut Cushion\ Strut Mount\ Dampers\ Stabilizer	HiJackers\ Load Carrier\ Classic

TOYOTA

TOYOTA

LAND CRUISER (cont)

76-78	FJ40(MfrBodyCode)		G63299	82007		
75-78	Sport Utility, FJ55(MfrBodyCode)		81340	
75	All		81318	43140 ⁶
	Mfg. from 1/75			G63492	49311 ⁷
	FJ40(MfrBodyCode) Mfg. from 1/75		61506
	FJ40(MfrBodyCode) Mfg. to 2/75		G63299	82007	
	Sport Utility, FJ55(MfrBodyCode) Mfg. from 1/75		61506
69-74	All		G63299	81340	82007		G63492	43140 ⁶
	Exc. Wagon		61500	49310 ⁷
	Wagon		81318	49311 ⁷
67-68	All		G63299	82007		61500 81147	49310 ⁷

MATRIX

09-14	Left		G52245
	Right		G52246
14	FWD			G51898
09-13	AWD, Left 10MM Stud Only		G57329 ⁴⁰
	AWD, Right 10MM Stud Only		G57330 ⁴⁰
	FWD, Left		G57566 ⁴⁰		G51898	G57451 ⁴⁰
	FWD, Right		G57567 ⁴⁰		G51898	G57452 ⁴⁰
	S, AWD, Left		G57572 ⁴⁰
	S, AWD, Right		G57573 ⁴⁰
03-08	Left		G52013	143094 ⁵³
	Right		G52014	143094 ⁵³
	FWD, Left		G57357 ⁴⁰		G51736	G57067 ⁴⁰
	FWD, Right		G57358 ⁴⁰		G51736	G57068 ⁴⁰

MR2

92-95	All		143059 ⁵¹
85-89	All		143059 ⁵¹

PASEO

95-99	All		143059 ⁵¹	143064 ⁵¹
92-94	All		143059 ⁵¹		G55804	143064 ⁵¹



7 Pair Packs, Air hose kit included.;

40 Complete Assembled Unit.;

8 Pair Packs.;

51 Strut Cushion for use with the Strut/Cartridge/Shocks.;































APPLICATION GUIDE

Year	Fitment Notes										
		Ultra	Ready Mounts	Max Control\ LTV\ ProGuard\ Guardian	Strut Cushion\ Strut Mount\ Dampers\ Stabilizer	HiJackers\ Load Carrier\ Classic	Ultra	Ready Mounts	Max Control\ LTV\ ProGuard\ Guardian	Strut Cushion\ Strut Mount\ Dampers\ Stabilizer	HiJackers\ Load Carrier\ Classic



TOYOTA

TOYOTA





















PICKUP

93-95	RWD, Exc. 1 Ton		G63903	61509 81541		G63907	61500 77907 81147	49310 ⁷
86-95	4WD, Exc. Lift Kit		G63479	61552 77479 81870		G63494	61510 77494 81871
85-95	RWD			43048 ⁸
79-95	Single System Steering Stabilizer		6802SE ⁸⁴										
85-92	RWD, 1 Ton		61509		G63492	61506 81318	49311 ⁷
	RWD, Exc. 1 Ton		G63903	81541		G63907	61500 77907 81147	49310 ⁷
84-85	4WD, Exc. Lift Kit		G63404		G63494	61510 77494 81871
80-85	4WD; Single System Steering Stabilizer; with OE Shock Mounts		6803SE ⁸⁴										
84	RWD		G63903	61509 81541		77907	43048 ⁸ 49310 ⁷
	RWD, Exc. 1 Ton			81147
	RWD; Mojave			G63907	61500
80-83	4WD, Exc. Lift Kit		G63404		G63492	61506 81318	49311 ⁷
75-83	RWD		34051 ⁸	
73-83	RWD; Mojave		61504 81750		G63907	61500 77907 81147	43048 ⁸
70-72	RWD			43048 ⁸
	RWD; Mojave		61504 81750		G63907	61500 77907 81147

PREVIA

91-97	All		143061 ⁵¹		G63620
-------	-----	---	------	------	------	----------------------	------	---	--------	------	------	------	------

PRIUS

11-15	Right		G57739 ⁴⁰	
	Mfg. to 12/11 Left		G52331		G70053
	Mfg. to 12/11 Right		G52332		G70053
10-15	Left		G57738 ⁴⁰	
10	Right		G52332	G57739 ⁴⁰	
	Mfg. to 12/11			G70053
	Mfg. to 12/11 Left		G52331	
04-09	Left		G57404 ⁴⁰	143201 ⁵³		G51795	143094 ⁵³
	Right		G57405 ⁴⁰	143201 ⁵³		G51795	143094 ⁵³
01-03	All			G57444 ⁴⁰	143094 ⁵³

7 Pair Packs, Air hose kit included.;

40 Complete Assembled Unit.;



53 Hardware from O.E. Part may need to be reused.;

8 Pair Packs.;

51 Strut Cushion for use with the Strut/Cartridge/Shocks.;

84 Replacement damper for vehicles with the Gabriel Aftermarket mounting kit;

APPLICATION GUIDE

Year	Fitment Notes										
		Ultra	Ready Mounts	Max Control LTV ProGuard Guardian	Strut Cushion\ Strut Mount\ Dampers\ Stabilizer	HiJackers\ Load Carrier\ Classic	Ultra	Ready Mounts	Max Control LTV ProGuard Guardian	Strut Cushion\ Strut Mount\ Dampers\ Stabilizer	HiJackers\ Load Carrier\ Classic

TOYOTA

TOYOTA

PRIUS C

17	All	70055
15-16	Models w/ 15" or 16" Wheels	70055
12-14	All	70055

RAV4

13-17	All	G64151
	Left Exc. Japan Manufactured	...	G57784 ⁴⁰
	Right Exc. Japan Manufactured	...	G57785 ⁴⁰
06-12	All	G64026
	Left	...	G57204 ⁴⁰
	Left	G52004
	Right	...	G57205 ⁴⁰
	Right	G52007
01-05	Left	G56582	143367 ⁵³	...	G63860
	Right	G56581	143367 ⁵³	...	G63860
	FWD, Left	...	G57349 ⁴⁰
	FWD, Right	...	G57350 ⁴⁰
00-05	AWD, Automatic Left Mfg. from 5/00	...	G57105 ⁴⁰
	AWD, Automatic Right Mfg. from 5/00	...	G57106 ⁴⁰
00	All	143367 ⁵³	...	G63860
	Left Mfg. from 5/00	G56582
	Mfg. from 5/00	G69813
	Mfg. to 5/00	61651
	Right Mfg. from 5/00	G56581
96-99	All	143367 ⁵³	...	G63860	...	61651



SEQUOIA

17-22	All	143340 ⁶⁷
17	Exc. Air Suspension	G51937	143339 ⁶⁷
12-16	Exc. Air Suspension	143339 ⁶⁷
08-16	All	G51937	143340 ⁶⁷
08-15	Left	...	G57454 ⁴⁰

⁴⁰ Complete Assembled Unit.;

⁵³ Hardware from O.E. Part may need to be reused.;

APPLICATION GUIDE

Year	Fitment Notes										
		Ultra	Ready Mounts	Max Control\ LTV\ ProGuard\ Guardian	Strut Cushion\ Strut Mount\ Dampers\ Stabilizer	HiJackers\ Load Carrier\ Classic	Ultra	Ready Mounts	Max Control\ LTV\ ProGuard\ Guardian	Strut Cushion\ Strut Mount\ Dampers\ Stabilizer	HiJackers\ Load Carrier\ Classic

TOYOTA

TOYOTA

SEQUOIA (cont)

08-15	Right	G57453 ⁴⁰
08-11	Exc. Air Suspension	143339 ⁵³
01-07	All	G51477	G57027 ⁴⁰	143325 ⁵³	G64087

SIENNA



15-18	AWD	G51805
	FWD	G51804
11-14	2.7L 4Cyl Left	G57730 ⁴⁰
	2.7L 4Cyl Right	G57731 ⁴⁰
	2.7L 4Cyl; AWD	G511007
	AWD, Left	G57734 ⁴⁰	G51805
	AWD, Right	G57735 ⁴⁰	G51805
	FWD, Left	G57732 ⁴⁰	G51992
	FWD, Right	G57733 ⁴⁰	G51992
	07-10	AWD, Left	G57375 ⁴⁰	G51805
AWD, Right		G57376 ⁴⁰	G51805
FWD, Left w/ 7 Passenger Seating		G52107	G57663 ⁴⁰
FWD, Left w/ 8 Passenger Seating		G57665 ⁴⁰
FWD, Right w/ 7 Passenger Seating		G52108	G57664 ⁴⁰
FWD, Right w/ 8 Passenger Seating		G57666 ⁴⁰
06-10	Left 8 Passenger	G52105
	Right 8 Passenger	G52106
04-10	FWD, 7 Passenger	G51804
	FWD, 8 Passenger	G51805
04-08	All	143202 ⁵⁴
05-06	FWD, Left Mfg from 7/05 w/ 7 Passenger Seating	G57663 ⁴⁰
	FWD, Left Mfg to 6/05 w/ 7 Passenger Seating	G56798	G57372 ⁴⁰
	FWD, Right Mfg from 7/05 w/ 7 Passenger Seating	G57664 ⁴⁰
	FWD, Right Mfg to 6/05 w/ 7 Passenger Seating	G56797	G57373 ⁴⁰
04-06	AWD	G51805
06	FWD, Left w/ 7 Passenger Seating	G52107

40 Complete Assembled Unit.;

54 Kit with Mount and Bearing. Hardware from O.E. Part may need to be reused.;

53 Hardware from O.E. Part may need to be reused.;

APPLICATION GUIDE

Year	Fitment Notes										
		Ultra	Ready Mounts	Max Control LTV ProGuard Guardian	Strut Cushion\ Strut Mount\ Dampers\ Stabilizer	HiJackers\ Load Carrier\ Classic	Ultra	Ready Mounts	Max Control LTV ProGuard Guardian	Strut Cushion\ Strut Mount\ Dampers\ Stabilizer	HiJackers\ Load Carrier\ Classic

TOYOTA

TOYOTA

SIENNA (cont)

06	FWD, Right w/ 7 Passenger Seating	↓	G52108	
05	Left Mfg. from 7/05; w/ 8 Passenger Seating	↓	G52105	
	Right Mfg. from 7/05; w/ 8 Passenger Seating	↓	G52106	
	FWD, Left Mfg. from 7/05; w/ 7 Passenger Seating	↓	G52107	
	FWD, Right Mfg. from 7/05; w/ 7 Passenger Seating	↓	G52108	
04	FWD, Left w/ 7 Passenger Seating	↓	G56798	G57372 ⁴⁰	
	FWD, Right w/ 7 Passenger Seating	↓	G56797	G57373 ⁴⁰	
98-03	Left	↓	G55993	142650 ⁵⁴	↓	G63610	61592 81937	49205 ⁷
	Right	↓	G55994	↓	G63610	61592 81937	49205 ⁷
	Mfg. to 12/02 Left	↓	G57097 ⁴⁰	↓
	Mfg. to 12/02 Right	↓	G57098 ⁴⁰	142649 ⁵⁴	↓

SOLARA

07-08	Left	↓	G56721	G57076 ⁴⁰	143202 ⁵⁴	↓
	Right	↓	G56722	G57077 ⁴⁰	143202 ⁵⁴	↓
04-06	Left	↓	G56721	G57076 ⁴⁰	143202 ⁵⁴	↓	G56728	G57078 ⁴⁰
	Right	↓	G56722	G57077 ⁴⁰	143202 ⁵⁴	↓	G56729	G57079 ⁴⁰
99-03	All	↓	143057 ⁵¹	↓
	Left	↓	G56506	G56930 ⁴⁰	142650 ⁵⁴	↓	G55675	G56932 ⁴⁰
	Right	↓	G56514	G56931 ⁴⁰	142649 ⁵⁴	↓	G55676	G56933 ⁴⁰

STARLET

81-84	All	↓	143059 ⁵¹	↓	81440
-------	-----	---	------	------	------	----------------------	------	---	------	------	-------	------	------

SUPRA

87-91	All	↓	↓	143057 ⁵¹
86	All	↓	143057 ⁵¹	↓	143057 ⁵¹

T100

93-98	4WD	↓	G63479	61552 77479 81870	↓	61582
	RWD	↓	G63903	61509 81541	↓	G63173	61506

TACOMA

18-21	4WD	↓	G51739	G57786 ⁴⁰	↓
-------	-----	---	--------	----------------------	------	------	------	---	------	------	------	------	------



7 Pair Packs, Air hose kit included.;

40 Complete Assembled Unit.;

200 51 Strut Cushion for use with the Strut/Cartridge/Shocks.;

54 Kit with Mount and Bearing. Hardware from O.E. Part may need to be reused.;

APPLICATION GUIDE

Year	Fitment Notes										
		Ultra	Ready Mounts	Max Control\ LTV\ ProGuard\ Guardian	Strut Cushion\ Strut Mount\ Dampers\ Stabilizer	HiJackers\ Load Carrier\ Classic	Ultra	Ready Mounts	Max Control\ LTV\ ProGuard\ Guardian	Strut Cushion\ Strut Mount\ Dampers\ Stabilizer	HiJackers\ Load Carrier\ Classic



TOYOTA

TOYOTA

TACOMA (cont)

21	Edicion Especial, Limited, Nightshade, SR, Sport, TRD Off-Road, TRD Sport, Trail, 4WD			 O	G64006
18-20	Edicion Especial, Limited, SR, Sport, TRD Off-Road, TRD Sport, 4WD			 O	G64006
17	4WD; Exc. TRD Pro Model		G51739	 O	G64006
16	4WD		G51739
	4WD; Exc. TRD Pro Model		 O	G64006
14-15	4WD, Exc. Off Road		G51739	 O	G64006
10-15	RWD; Base & Pre-Runner Left		G51853
	RWD; Base & Pre-Runner Right		G51854
05-15	4WD, Left Exc. Off Road & Sport Models		G57133 ⁴⁰
	4WD, Right Exc. Off Road & Sport Models		G57134 ⁴⁰
	Base, Pre Runner, RWD		 O	G63889
	Pre Runner, Left 4WD		G51739	G57133 ⁴⁰
	Pre Runner, Right 4WD		G51739	G57134 ⁴⁰
13	4WD		G51739
	4WD, Exc. Off Road		 O	G64006
05-12	4WD		G51739	 O	G64006
05-09	RWD; Base & X-Runner Models Left		G51853
	RWD; Base & X-Runner Models Right		G51854
01-04	All		 O O	43048 ⁸
	Pre Runner, Left	 E	G63937	61606	 O	G63689	61699	43048 ⁸ 49310 ⁷
	Pre Runner, Right	 E	G63937	61606	 O	G63689	61700	43048 ⁸ 49310 ⁷
	S-Runner	 E	G63937	61606	 O	G63689	61510	49310 ⁷
98-04	4WD		143325 ⁵³
	Pre Runner, 4WD, RWD, Exc. Heavy Duty Upgrade		 O	G63494
04	Base, 4WD		 O O	61510 77494
	Base, RWD	 E	G63937	61606	 O	G63689	61500	43048 ⁸ 49310 ⁷
	Pre Runner, 4WD, RWD		G51077	G57010 ⁴⁰	81871
	Pre Runner, RWD		 O	77494
98-03	Pre Runner, 4WD, RWD		G51077	G57010 ⁴⁰	 O	77494 81871
95-03	DLX, 4WD		 O	61510
	DLX, RWD	 E	G63937	61606	 O	G63689	61500	43048 ⁸ 49310 ⁷

APPLICATION GUIDE

Year	Fitment Notes										
		Ultra	Ready Mounts	Max Control LTV ProGuard Guardian	Strut Cushion\ Strut Mount\ Dampers\ Stabilizer	HiJackers\ Load Carrier\ Classic	Ultra	Ready Mounts	Max Control LTV ProGuard Guardian	Strut Cushion\ Strut Mount\ Dampers\ Stabilizer	HiJackers\ Load Carrier\ Classic

TOYOTA

TOYOTA

TACOMA (cont)

98-00	Limited	61510
	Pre Runner, Left	61699
	Pre Runner, Right	61700
	SR5, 4WD	61500
95-97	4WD	G51077	G57010 ⁴⁰	...	143325 ⁵³	77494 81871
	4WD, Exc. Heavy Duty Upgrade	G63494

TERCEL

95-99	All	143059 ⁵¹	143064 ⁵¹	...
91-94	All	143059 ⁵¹	...	G55804	...	143064 ⁵¹	...
87-90	All	143059 ⁵¹
	Hatchback	143064 ⁵¹	...
	Sedan	143064 ⁵¹	...
88	Wagon	143057 ⁵¹	...
87	Wagon	142249 ⁵³ 143057 ⁵¹	...
83-86	All	143059 ⁵¹	142249 ⁵³	...
	Wagon	143057 ⁵¹	...
80-82	All	143059 ⁵¹

TUNDRA

07-21	w/ Off Road Package	143340 ⁶⁷	...
21	All	49237 ⁷
07-20	All	G51855	G64038	49237 ⁷
	4WD, Left	...	G57220 ⁴⁰
	4WD, Right	...	G57221 ⁴⁰
	RWD, Left	...	G57123 ⁴⁰
	RWD, Right	...	G57124 ⁴⁰
00-06	All	...	G57027 ⁴⁰	...	143325 ⁵³	...	G63815	...	77815	...
	Exc. Air Suspension	G51477

VAN

84-89	RWD	61529
84-88	Leaf(RearSpringType)	G63907	...	61500 77907 81147	43048 ⁸ 49310 ⁷

7 Pair Packs, Air hose kit included.;

40 Complete Assembled Unit.;





202 53 Hardware from O.E. Part may need to be reused.;

8 Pair Packs.;

51 Strut Cushion for use with the Strut/Cartridge/Shocks.;

67 Mount Kit. Hardware from O.E. Part may need to be reused.;







APPLICATION GUIDE

Year	Fitment Notes										
		 Ultra	Ready Mounts	Max Control\ LTV\ ProGuard\ Guardian	Strut Cushion\ Strut Mount\ Dampers\ Stabilizer	HiJackers\ Load Carrier\ Classic	 Ultra	Ready Mounts	Max Control\ LTV\ ProGuard\ Guardian	Strut Cushion\ Strut Mount\ Dampers\ Stabilizer	HiJackers\ Load Carrier\ Classic













TOYOTA

TOYOTA









VAN WAGON

88	All			43048 ⁸ 49310 ⁷
	Leaf(RearSpringType)			G63907	61500
	RWD		61529
	RWD; Leaf(RearSpringType)			81147

VENZA

09-14	Left		G57676 ⁴⁰	
	Right		G57677 ⁴⁰	
	AWD, Left			G57658 ⁴⁰
	AWD, Right			G57659 ⁴⁰
	FWD, Left			G57483 ⁴⁰
	FWD, Right			G57484 ⁴⁰

















YARIS

06-14	All			70055
07-11	Exc. Dust Boot			G51783
	Left		G56842	G57353 ⁴⁰	
	Right		G56843	G57354 ⁴⁰	



VOLKSWAGEN

VOLKSWAGEN



BEETLE

12-13	4Cyl		G57277 ⁴⁰	
98-10	All		G56606	G57039 ⁴⁰	142651 ⁵⁴		69945	81934
67-77	All		14004		49307 ⁷ 82001
66	All		14004		49307 ⁷
	Exc. 1300 and 1500		
	1300 & 1500		
59-65	All		14004		49307 ⁷ 82001
52-58	All			49307 ⁷ 82001



BORA

06-09	All		G56899		G51799
-------	-----	---	--------	------	------	------	---	--------	------	------	------	------	------

CABRIOLET

85-93	All		143058 ⁵¹		142252 ⁵³
-------	-----	---	------	------	------	----------------------	---	------	------	------	------	------	----------------------

CC

09-17	All		G56899	G57156 ⁴⁰	143344 ⁵³		G51799	143345 ⁵³
-------	-----	---	--------	----------------------	------	----------------------	---	--------	------	------	------	------	----------------------

7 Pair Packs, Air hose kit included.;

40 Complete Assembled Unit.;



53 Hardware from O.E. Part may need to be reused.;

8 Pair Packs.;

51 Strut Cushion for use with the Strut/Cartridge/Shocks.;

54 Kit with Mount and Bearing. Hardware from O.E. Part may need to be reused.;

APPLICATION GUIDE

Year	Fitment Notes										
		Ultra	Ready Mounts	Max Control LTV ProGuard Guardian	Strut Cushion\ Strut Mount\ Dampers\ Stabilizer	HiJackers\ Load Carrier\ Classic	Ultra	Ready Mounts	Max Control LTV ProGuard Guardian	Strut Cushion\ Strut Mount\ Dampers\ Stabilizer	HiJackers\ Load Carrier\ Classic

VOLKSWAGEN CORRADO

92-94	VR6		142444 ⁵⁴
90-92	All		143061 ⁵¹	142252 ⁵³ 143063 ⁵¹

VOLKSWAGEN

EOS

12-14	All		G56899
07-11	All		G56899	143344 ⁵³	143345 ⁵³
	4Cyl		G57277 ⁴⁰

FASTBACK

69-73	All		82001	49307 ⁷ 82001
66-68	All		82001	82001

FOX

87-93	All		143057 ⁵¹	143063 ⁵¹
-------	-----	--	------	------	------	----------------------	------	--	------	------	------	----------------------

GOLF

11-14	Exc. R Models		G56899		G51799
10-12	4Cyl		G57277 ⁴⁰
10-11	All		143344 ⁵³	143345 ⁵³
99-06	All		G57039 ⁴⁰
	A4(MfrBodyCode)		G56606	142651 ⁵⁴		69945	81934
97-98	All		G57006 ⁴⁰	142444 ⁵⁴ 143058 ⁵¹	142252 ⁵³ 143063 ⁵¹
93-96	All		G57005 ⁴⁰	142444 ⁵⁴ 143058 ⁵¹	142252 ⁵³ 143063 ⁵¹
85-92	All		G57005 ⁴⁰	143058 ⁵¹	142252 ⁵³ 143063 ⁵¹

GTI

10-14	All		G56899	G57680 ⁴⁰	143344 ⁵³		G51799	143345 ⁵³
06-09	All		G56899	143344 ⁵³		G51799	143345 ⁵³



JETTA

12-17	All		143344 ⁵³	143345 ⁵³
12-14	Wagon		G56899 ⁴⁹
10-11	All		G56899 ⁴⁹	143344 ⁵³	143345 ⁵³
06-10	GLI		G57277 ⁴⁰
06-09	All		G56899 ⁴⁹	143344 ⁵³		G51799	143345 ⁵³

7 Pair Packs, Air hose kit included.;
49 55mm Outer Tube;

40 Complete Assembled Unit.;
51 Strut Cushion for use with the Strut/Cartridge/Shocks.;

APPLICATION GUIDE

Year	Fitment Notes										
		Ultra	Ready Mounts	Max Control\ LTV\ ProGuard\ Guardian	Strut Cushion\ Strut Mount\ Dampers\ Stabilizer	HiJackers\ Load Carrier\ Classic	Ultra	Ready Mounts	Max Control\ LTV\ ProGuard\ Guardian	Strut Cushion\ Strut Mount\ Dampers\ Stabilizer	HiJackers\ Load Carrier\ Classic

VOLKSWAGEN

JETTA (cont)

01-05	All	G57039 ⁴⁰
	Sedan	G56606	142651 ⁵⁴	69945	81934
99-00	All	G56606	G57039 ⁴⁰	142651 ⁵⁴	69945
97-98	All	G57006 ⁴⁰	142444 ⁵⁴ 143058 ⁵¹	142252 ⁵³ 143063 ⁵¹
94-96	All	G57005 ⁴⁰	142444 ⁵⁴ 143058 ⁵¹	142252 ⁵³ 143063 ⁵¹
85-93	All	G57005 ⁴⁰	143058 ⁵¹	142252 ⁵³ 143063 ⁵¹
80-84	All	143058 ⁵¹	142252 ⁵³

VOLKSWAGEN

KARMANN GHIA

67-74	All	82005	82001
-------	-----	-------	-------	-------	-------	-------	-------	-------	-------	-------

PASSAT

12-17	All	G57156 ⁴⁰
12-13	Mfg to 10/12	143345 ⁵³
10	All	G56899	G57156 ⁴⁰	143344 ⁵³	G51799	143345 ⁵³
	Mfg to 10/12	143345 ⁵³
06-09	All	G56899	143344 ⁵³	G51799	143345 ⁵³
	2.0T	G57156 ⁴⁰
02-05	Left	G57135 ⁴⁰
	Right	G57136 ⁴⁰
	FWD	143380 ⁵³
	FWD, From VIN# 3B300001 through VIN# 3B300000	69946
99-05	AWD, Exc. VIN# 3B300001 through VIN# 3B300000	G51742
98-01	FWD, From VIN# 3B300001 through VIN# 3B300000	G51097	69946
01	Left	G57135 ⁴⁰	143058 ⁵¹	142653 ⁵³ 143063 ⁵¹
	Right	G57136 ⁴⁰	143058 ⁵¹	142653 ⁵³ 143063 ⁵¹
98-00	All	143058 ⁵¹	142653 ⁵³ 143063 ⁵¹
98	AWD; Exc. VIN# 3B300001 through VIN# 3B300000	G51742
90-97	All	142444 ⁵⁴ 143058 ⁵¹

QUANTUM

82-88	All	142195 ⁵³ 143057 ⁵¹	143063 ⁵¹
-------	-----	-------	-------	-------	--	-------	-------	-------	-------	----------------------



40 Complete Assembled Unit.;

53 Hardware from O.E. Part may need to be reused.;

51 Strut Cushion for use with the Strut/Cartridge/Shocks.;

54 Kit with Mount and Bearing. Hardware from O.E. Part may need to be reused.;

APPLICATION GUIDE

Year	Fitment Notes										
		Ultra	Ready Mounts	Max Control LTV ProGuard Guardian	Strut Cushion\ Strut Mount\ Dampers\ Stabilizer	HiJackers\ Load Carrier\ Classic	Ultra	Ready Mounts	Max Control LTV ProGuard Guardian	Strut Cushion\ Strut Mount\ Dampers\ Stabilizer	HiJackers\ Load Carrier\ Classic

VOLKSWAGEN

VOLKSWAGEN

R32

08	All		143344 ⁵³	143345 ⁵³
----	-----	--	------	------	------	----------------------	------	--	------	------	------	----------------------	------

RABBIT

06-09	All		G56899	143344 ⁵³		G51799	143345 ⁵³
75-84	All		143058 ⁵¹	142252 ⁵³

RABBIT PICKUP

80-83	All		143058 ⁵¹
-------	-----	--	------	------	------	----------------------	------	--	------	------	------	------	------

ROUTAN

09-14	All		G57206 ⁴⁰
	Exc. Self-Leveling Suspension		G52131		G64042

SCIROCCO

75-89	All		143058 ⁵¹	142252 ⁵³ 143063 ⁵¹
-------	-----	--	------	------	------	----------------------	------	--	------	------	------	--	------

SQUAREBACK

66-73	All		82001		49307 ⁷ 82001
-------	-----	--	------	------	------	------	-------	--	------	------	------	------	-----------------------------

SUPER BEETLE

76-79	All		142251 ⁵³ 143057 ⁵¹	49307 ⁷ 82001
74-75	All		14005 142251 ⁵³ 143057 ⁵¹	49307 ⁷ 82001
71-73	3 Bolt Flange-Type Lower Mount		49307 ⁷ 82001
73	All		14005 142251 ⁵³ 143057 ⁵¹
71-72	All		14005 143057 ⁵¹

THING

73-74	All		14004	82005		49307 ⁷ 82001
-------	-----	--	------	------	------	-------	-------	--	------	------	------	------	-----------------------------

TIGUAN

12-17	All			G51993	143345 ⁵³
09-11	All		G52301	143344 ⁵³		G51993	143345 ⁵³

TIGUAN LIMITED

18	All			G51993	143345 ⁵³
----	-----	--	------	------	------	------	------	--	--------	------	------	----------------------	------

TOUAREG

04-10	Left Exc. Air Suspension		G52348		G51928
	Right Exc. Air Suspension		G52349		G51928

TRANSPORTER

70-79	All		82032
68-69	All		82001		82032



7 Pair Packs, Air hose kit included.;

40 Complete Assembled Unit.;

206 51 Strut Cushion for use with the Strut/Carrier/Shocks.;

53 Hardware from O.E. Part may need to be reused.;



APPLICATION GUIDE

Year	Fitment Notes										
		Ultra	Ready Mounts	Max Control\ LTV\ ProGuard\ Guardian	Strut Cushion\ Strut Mount\ Dampers\ Stabilizer	HiJackers\ Load Carrier\ Classic	Ultra	Ready Mounts	Max Control\ LTV\ ProGuard\ Guardian	Strut Cushion\ Strut Mount\ Dampers\ Stabilizer	HiJackers\ Load Carrier\ Classic



VOLKSWAGEN

VOLKSWAGEN

TRANSPORTER (cont)

56-67	All		82001		82001
-------	-----	---	------	------	------	------	-------	---	------	------	------	------	-------



VANAGON

86-89	4WD			G63454	61539	49215 ⁷
-------	-----	---	------	------	------	------	------	---	--------	------	-------	------	--------------------





VOLVO

VOLVO



122

59-68	All		82026		81270	49105 ⁷
-------	-----	---	------	------	------	------	-------	---	------	------	-------	------	--------------------



142 / 144 / 145 / 164

75	All		69600	81494		69787 ⁵¹
68-74	All		69600	81494	



240 / 242 / 244 / 245 / 262 / 264 / 265

75-93	All		143057 ⁵¹		69787 ⁵¹
-------	-----	---	------	------	------	----------------------	------	---	---------------------	------	------	------	------



740 / 745 / 760 / 780

84-92	All		143058 ⁵¹	
-------	-----	---	------	------	------	----------------------	------	---	------	------	------	------	------



850

93-97	Exc. Hydraulic Self Leveling System		G57040 ⁴⁰	143191 ⁵³		69901
-------	-------------------------------------	---	------	----------------------	------	----------------------	------	---	-------	------	------	------	------



940

91-95	Exc. Hydraulic Self Leveling System		143058 ⁵¹	
-------	-------------------------------------	---	------	------	------	----------------------	------	---	------	------	------	------	------





960

92-95	All		143058 ⁵¹	
-------	-----	---	------	------	------	----------------------	------	---	------	------	------	------	------











1800

61-73	All		82026	
-------	-----	---	------	------	------	------	-------	---	------	------	------	------	------



C30

07-13	Left		G52274		70056
	Right		G52275		70056

C70

08-13	Left		G52274	
	Right		G52275	
06-07	Left		G52274	143191 ⁵³	
	Right		G52275	143191 ⁵³	
98-04	All		G57040 ⁴⁰	143191 ⁵³		69901

DL

84	Exc. Hydraulic Self-Leveling System			69787 ⁵¹
----	-------------------------------------	---	------	------	------	------	------	---	---------------------	------	------	------	------

7 Pair Packs, Air hose kit included.;



40 Complete Assembled Unit.;

53 Hardware from O.E. Part may need to be reused.;

51 With Nivomat Self-Leveling Suspension replace spring with Volvo No. 1229052/4.;

51 Strut Cushion for use with the Strut/Cartridge/Shocks.;

APPLICATION GUIDE

Year	Fitment Notes										
		Ultra	Ready Mounts	Max Control LTV ProGuard Guardian	Strut Cushion\ Strut Mount\ Dampers\ Stabilizer	HiJackers\ Load Carrier\ Classic	Ultra	Ready Mounts	Max Control LTV ProGuard Guardian	Strut Cushion\ Strut Mount\ Dampers\ Stabilizer	HiJackers\ Load Carrier\ Classic

VOLVO

VOLVO

GLE

84	Exc. Hydraulic Self-Leveling System	69787 ³¹
----	-------------------------------------	------	------	------	------	------	---------------------	------	------	------	------

S40

05-12	Left	G52274	70056
	Right	G52275	70056
00-04	All	143422 ⁶⁷
	Mfg. from 4/00	G51841
04	Mfg to 04/00	70056
	T5, Left	G52274
	T5, Right Mfg. to 4/00	G52275

S60

08-09	All	G56802
04-09	FWD	70040
04-07	All	G56802	143191 ⁵³
01-03	All	G56802	143191 ⁵³	70040

S70

98-00	All	G57040 ⁴⁰	143191 ⁵³	69901
-------	-----	------	----------------------	------	----------------------	------	-------	------	------	------	------

S80

07-15	Left	G57337 ⁴⁰
	Right	G57338 ⁴⁰
99-06	All	G56802	70040
	Exc. Nivomat Rear Suspension	143191 ⁵³
06	Left Mfg. from 3/06	G57337 ⁴⁰
	Right Mfg. from 3/06	G57338 ⁴⁰
99-05	Left	G57335 ⁴⁰
	Right	G57336 ⁴⁰

V40



00-04	All	143422 ⁶⁷
	Mfg. from 4/00	G51841

V50

05-11	Left	G52274	70056
	Right	G52275	70056

31 With Nivomat Self-Leveling Suspension replace spring with Volvo No. 1229052/4.; 40 Complete Assembled Unit.;

APPLICATION GUIDE

Year	Fitment Notes										
		Ultra	Ready Mounts	Max Control\ LTV\ ProGuard\ Guardian	Strut Cushion\ Strut Mount\ Dampers\ Stabilizer	HiJackers\ Load Carrier\ Classic	Ultra	Ready Mounts	Max Control\ LTV\ ProGuard\ Guardian	Strut Cushion\ Strut Mount\ Dampers\ Stabilizer	HiJackers\ Load Carrier\ Classic

VOLVO

VOLVO

V70

01-07	Exc. Electronic Suspension / Nivomat	↓	↓	○	70040
98-07	Exc. XC70, XC Cross Country and Exc. Auto-Leveling System	↓	143191 ⁵³	↓	○
00-06	Mfg. from 3/00 and Exc. XC70, XC Cross Country and Auto Leveling	↓	G56802	↓	○
98-00	Mfg. to 3/00 and Exc. XC70, XC Cross Country	↓	G57040 ⁴⁰	↓	○	69901

XC90

07-08	All	↓	G52295	↓	○
04-06	All	↓	G52295	143191 ⁵³	↓	○
03	All	↓	G52295	↓	○
	AWD	↓	143191 ⁵³	↓	○

WINNEBAGO

WINNEBAGO

ACCESS

07-13	MotorHomes with Ford E350 or E450 Chassis	↓	○	G63622	↓	○
		↓	○	↓	○	G63623

ACCESS PREMIER

14	MotorHomes with Ford E350 or E450 Chassis	↓	○	G63622	↓	○
		↓	○	↓	○	G63623

Numerical listing

Steering Dampers, Axle Shaft Damper, Steering Stabilizer

Numerical listing

Shock	POP	Alternative No.	MTG Acc. Supplied
Pos.	Year	Application	

Steering Dampers

14004	A		
F	59-77	VOLKSWAGEN BEETLE	All
F	73-74	THING	All

14005	C		
F	71-75	VOLKSWAGEN SUPER BEETLE	All

14017	A		142387
F	87-91	CHEVROLET BLAZER 4WD	
F	75-86	BLAZER	All
F	73-86	PICKUP 1/2 TON, K10	All
F	87	PICKUP 1/2 TON, V10	All
F	77-86	PICKUP 1 TON, K30	All
F	73-74	PICKUP 1 TON, K30	All
F	89-91	PICKUP 1 TON, R3500	All
F	87-88	PICKUP 1 TON, V30	All
F	89-91	PICKUP 1 TON, V3000 / V3500	All
F	73-86	PICKUP 3/4 TON, K20	All
F	87	PICKUP 3/4 TON, V20	All
F	73-86	SUBURBAN 1/2 TON, K10	All
F	87-88	SUBURBAN 1/2 TON, R10	All
F	73-86	SUBURBAN 3/4 TON, K20	All
F	87-88	SUBURBAN 3/4 TON, V20	All
F	89-91	SUBURBAN 3/4 TON, V2500	All
F	73-91	GMC JIMMY	All Replacement damper for vehicles w/ OE stabilizer
F	73-86	PICKUP 1/2 TON, K15 / K1500	All
F	87	PICKUP 1/2 TON, V1500	All
F	77-86	PICKUP 1 TON, K35 / K3500	All
F	73-74	PICKUP 1 TON, K35 / K3500	All
F	87-91	PICKUP 1 TON, V3000 / V3500	All
F	73-86	PICKUP 3/4 TON, K25 / K2500	All
F	87	PICKUP 3/4 TON, V2500	All
F	73-86	SUBURBAN 1/2 TON, K15 / K1500	All
F	87-91	SUBURBAN 1/2 TON, V1500	All
F	73-86	SUBURBAN 3/4 TON, K25 / K2500	All
F	87-91	SUBURBAN 3/4 TON, V2500	All

14018	A		141264
F	76-79	CADILLAC SEVILLE	All

14040	A		500498
F	84-01	JEEP CHEROKEE	All
F	86-92	COMANCHE	All
F	11-18	WRANGLER	All w/o Dust Boot
F	06-10	WRANGLER	All

14071	D		
F	99-04	JEEP GRAND CHEROKEE	All Single System Steering Damper

14072	A		
F	08-24	FORD PICKUP 1 TON, F-350 / SUPERDUTY 4WD	
F	08-24	PICKUP 3/4 TON, F-250 / SUPERDUTY 4WD	

14074	A		
F	07-18	JEEP WRANGLER 4WD w/ Dust Boot	

Axle Shaft Damper

14039	A		
F	84-04	FORD MUSTANG / MUSTANG II	All Position Rear
F	84-88	THUNDERBIRD	All Position Rear
F	84-86	MERCURY CAPRI	All Position Rear
F	84-88	COUGAR	All Position Rear

Steering Stabilizer

6801SE	A		500498,142037
F	83-94	CHEVROLET BLAZER, S MODELS	All Single System Steering Stabilizer; w/ factory mounting hole in the steering linkage.
F	79-82	LUV PICKUP 4WD	Single System Steering Stabilizer; w/ factory mounting hole in the steering linkage.
F	83-04	S10 4WD	Single System Steering Stabilizer; w/ factory mounting hole in the steering linkage.
F	83-91	GMC S15 JIMMY	All Single System Steering Stabilizer; w/ factory mounting hole in the steering linkage.
F	91-93	SONOMA / S15	All Single System Steering Stabilizer; w/ factory mounting hole in the steering linkage.

Shock	POP	Alternative No.	MTG Acc. Supplied
Pos.	Year	Application	

6801SE	A (cont)		500498,142037
F	82-90	SONOMA / S15 RWD	Single System Steering Stabilizer; w/ factory mounting hole in the steering linkage.
F	91	SYCLONE	All Single System Steering Stabilizer; w/ factory mounting hole in the steering linkage.
F	84-00	JEEP CHEROKEE	All Single System Steering Stabilizer; w/ factory mounting hole in the steering linkage.
F	86-92	COMANCHE	All Single System Steering Stabilizer; w/ factory mounting hole in the steering linkage.
F	97-06	WRANGLER TJ (MfrBodyCode)	Single System Steering Stabilizer; w/ factory mounting hole in the steering linkage.
F	87-95	WRANGLER YJ (MfrBodyCode)	Single System Steering Stabilizer; w/ factory mounting hole in the steering linkage.

6802SE	B		141998
---------------	---	--	---------------

F	79-86	CHEVROLET BLAZER 4WD	Dual System Steering Stabilizer All models with factory frame bracket. Kit 143168 required to install to linkage.
F	79-84	BLAZER RWD	Dual System Steering Stabilizer All models with factory frame bracket. Kit 143168 required to install to linkage.
F	50-58	PICKUP Truck	Single System Steering Stabilizer; w/ I-Beam Axle All models with factory frame bracket. Kit 143168 required to install to linkage.
F	73-86	PICKUP 1/2 TON, C10	All Single System Steering Stabilizer All models with factory frame bracket. Kit 143168 required to install to linkage.
F	67-86	PICKUP 1/2 TON, K10	All Dual System Steering Stabilizer All models with factory frame bracket. Kit 143168 required to install to linkage.
F	87	PICKUP 1/2 TON, R10	All Single System Steering Stabilizer All models with factory frame bracket. Kit 143168 required to install to linkage.
F	87	PICKUP 1/2 TON, V10	All Dual System Steering Stabilizer All models with factory frame bracket. Kit 143168 required to install to linkage.
F	82-86	PICKUP 1 TON, C30 6.2L 8Cyl V (379), 3.98 101.0(Bore)3.82 97.0(Stroke)	Single System Steering Stabilizer; w/ Cooler All models with factory frame bracket. Kit 143168 required to install to linkage.
F	75-86	PICKUP 1 TON, C30 4.8L 6Cyl L (292), 3.88 98.4(Bore)4.13 104.8(Stroke)	Single System Steering Stabilizer; w/ Cooler All models with factory frame bracket. Kit 143168 required to install to linkage.
F	75-86	PICKUP 1 TON, C30 5.7L 8Cyl V (350), 4.00 101.6(Bore)3.48 88.5(Stroke)	Single System Steering Stabilizer; w/ Cooler All models with factory frame bracket. Kit 143168 required to install to linkage.
F	80	PICKUP 1 TON, C30 4.1L 6Cyl L (250), 3.68 93.5(Bore)3.91 99.3(Stroke)	Single System Steering Stabilizer; w/ Cooler All models with factory frame bracket. Kit 143168 required to install to linkage.
F	79	PICKUP 1 TON, C30 4.1L 6Cyl L (250)	Single System Steering Stabilizer; w/ Cooler All models with factory frame bracket. Kit 143168 required to install to linkage.

Shock	POP	Alternative No.	MTG Acc. Supplied
Pos.	Year	Application	

6802SE	B (cont)		141998
F	76-78	PICKUP 1 TON, C30 6.6L 8Cyl V (400), 4.13 104.8(Bore)3.76 95.5(Stroke)	Single System Steering Stabilizer; w/ Cooler All models with factory frame bracket. Kit 143168 required to install to linkage.
F	78	PICKUP 1 TON, C30 4.1L 6Cyl L (250), 3.68 93.5(Bore)3.91 99.3(Stroke)	Single System Steering Stabilizer; w/ Cooler All models with factory frame bracket. Kit 143168 required to install to linkage.
F	78	PICKUP 1 TON, C30 5.0L 8Cyl V (305), 3.74 94.9(Bore)3.48 88.4(Stroke)	Single System Steering Stabilizer; w/ Cooler All models with factory frame bracket. Kit 143168 required to install to linkage.
F	75	PICKUP 1 TON, C30 4.1L 6Cyl L (250), 3.68 93.5(Bore)3.91 99.3(Stroke)	Single System Steering Stabilizer; w/ Cooler All models with factory frame bracket. Kit 143168 required to install to linkage.
F	73-74	PICKUP 1 TON, C30	All Single System Steering Stabilizer; w/ Cooler All models with factory frame bracket. Kit 143168 required to install to linkage.
F	61-72	PICKUP 1 TON, C30	All Single System Steering Stabilizer All models with factory frame bracket. Kit 143168 required to install to linkage.
F	77-86	PICKUP 1 TON, K30	All Dual System Steering Stabilizer All models with factory frame bracket. Kit 143168 required to install to linkage.
F	87-88	PICKUP 1 TON, R30 4.8L 6Cyl L (292), 3.88 98.4(Bore)4.13 104.8(Stroke)	Single System Steering Stabilizer; w/ Cooler All models with factory frame bracket. Kit 143168 required to install to linkage.
F	87-88	PICKUP 1 TON, R30 5.7L 8Cyl V (350), 4.00 101.6(Bore)3.48 88.5(Stroke)	Single System Steering Stabilizer; w/ Cooler All models with factory frame bracket. Kit 143168 required to install to linkage.
F	87-88	PICKUP 1 TON, R30 6.2L 8Cyl V (379), 3.98 101.0(Bore)3.82 97.0(Stroke)	Single System Steering Stabilizer; w/ Cooler All models with factory frame bracket. Kit 143168 required to install to linkage.
F	89-91	PICKUP 1 TON, R3500 5.7L 8Cyl V (350), 4.00 101.6(Bore)3.48 88.5(Stroke)	Single System Steering Stabilizer; w/ Cooler All models with factory frame bracket. Kit 143168 required to install to linkage.
F	63-86	PICKUP 3/4 TON, C20	All Single System Steering Stabilizer All models with factory frame bracket. Kit 143168 required to install to linkage.
F	67-86	PICKUP 3/4 TON, K20	All Dual System Steering Stabilizer All models with factory frame bracket. Kit 143168 required to install to linkage.
F	87-88	PICKUP 3/4 TON, R20	All Single System Steering Stabilizer All models with factory frame bracket. Kit 143168 required to install to linkage.
F	89	PICKUP 3/4 TON, R2500	All Single System Steering Stabilizer All models with factory frame bracket. Kit 143168 required to install to linkage.
F	87	PICKUP 3/4 TON, V20	All Dual System Steering Stabilizer All models with factory frame bracket. Kit 143168 required to install to linkage.
F	82-03	S10 RWD	Single System Steering Stabilizer All models with factory frame bracket. Kit 143168 required to install to linkage.

Numerical listing

Shock	POP	Alternative No.	MTG Acc. Supplied
Pos.	Year	Application	
6802SE	B (cont)	141998	
F	68-86	SUBURBAN 1/2 TON, C10 All Single System Steering Stabilizer All models with factory frame bracket. Kit 143168 required to install to linkage.	
F	68-86	SUBURBAN 1/2 TON, K10 All Dual System Steering Stabilizer All models with factory frame bracket. Kit 143168 required to install to linkage.	
F	87-88	SUBURBAN 1/2 TON, R10 All Dual System Steering Stabilizer All models with factory frame bracket. Kit 143168 required to install to linkage.	
F	89-91	SUBURBAN 1/2 TON, R1500 All Single System Steering Stabilizer All models with factory frame bracket. Kit 143168 required to install to linkage.	
F	68-86	SUBURBAN 3/4 TON, C20 All Single System Steering Stabilizer All models with factory frame bracket. Kit 143168 required to install to linkage.	
F	68-86	SUBURBAN 3/4 TON, K20 All Dual System Steering Stabilizer All models with factory frame bracket. Kit 143168 required to install to linkage.	
F	87-88	SUBURBAN 3/4 TON, R20 All Single System Steering Stabilizer All models with factory frame bracket. Kit 143168 required to install to linkage.	
F	89-91	SUBURBAN 3/4 TON, R2500 All Single System Steering Stabilizer All models with factory frame bracket. Kit 143168 required to install to linkage.	
F	87-88	SUBURBAN 3/4 TON, V20 All Dual System Steering Stabilizer All models with factory frame bracket. Kit 143168 required to install to linkage.	
F	89-91	SUBURBAN 3/4 TON, V2500 All Dual System Steering Stabilizer All models with factory frame bracket. Kit 143168 required to install to linkage.	
F	70-95	VAN 1/2 TON, G / EXPRESS All Single System Steering Stabilizer All models with factory frame bracket. Kit 143168 required to install to linkage.	
F	71-95	VAN 1 TON, G / EXPRESS All Single System Steering Stabilizer All models with factory frame bracket. Kit 143168 required to install to linkage.	
F	70-95	VAN 3/4 TON, G / EXPRESS All Single System Steering Stabilizer All models with factory frame bracket. Kit 143168 required to install to linkage.	
F	70	DODGE A100 TRUCK All Dual System Steering Stabilizer; w/ I-Beam Axle All models with factory frame bracket. Kit 143168 required to install to linkage.	
F	64-69	A100 TRUCK All Dual System Steering Stabilizer All models with factory frame bracket. Kit 143168 required to install to linkage.	
F	86-89	PICKUP 1/2 TON, D100 SERIES All Single System Steering Stabilizer All models with factory frame bracket. Kit 143168 required to install to linkage.	
F	72-79	PICKUP 1/2 TON, D100 SERIES All Single System Steering Stabilizer All models with factory frame bracket. Kit 143168 required to install to linkage.	
F	60-71	PICKUP 1/2 TON, D100 SERIES All Single System Steering Stabilizer; w/ I-Beam Axle All models with factory frame bracket. Kit 143168 required to install to linkage.	
F	90-93	PICKUP 1/2 TON, W100 SERIES All Single System Steering Stabilizer All models with factory frame bracket. Kit 143168 required to install to linkage.	

Steering Stabilizer

Shock	POP	Alternative No.	MTG Acc. Supplied
Pos.	Year	Application	
6802SE	B (cont)	141998	
F	60-86	PICKUP 1/2 TON, W100 SERIES All Dual System Steering Stabilizer; Exc. Vacuum Servo Mounted on Drivers Side of Axle All models with factory frame bracket. Kit 143168 required to install to linkage.	
F	75-93	PICKUP 1 TON, D300 SERIES All Single System Steering Stabilizer All models with factory frame bracket. Kit 143168 required to install to linkage.	
F	72-74	PICKUP 1 TON, D300 SERIES All Single System Steering Stabilizer; w/ Coil Spring Front Suspension All models with factory frame bracket. Kit 143168 required to install to linkage.	
F	60-71	PICKUP 1 TON, D300 SERIES All Single System Steering Stabilizer; w/ I-Beam Axle All models with factory frame bracket. Kit 143168 required to install to linkage.	
F	90-93	PICKUP 1 TON, W300 SERIES All Single System Steering Stabilizer All models with factory frame bracket. Kit 143168 required to install to linkage.	
F	60-86	PICKUP 1 TON, W300 SERIES All Dual System Steering Stabilizer; Exc. Vacuum Servo Mounted on Drivers Side of Axle All models with factory frame bracket. Kit 143168 required to install to linkage.	
F	73-93	PICKUP 3/4 TON, D200 SERIES All Single System Steering Stabilizer All models with factory frame bracket. Kit 143168 required to install to linkage.	
F	60-71	PICKUP 3/4 TON, D200 SERIES All Single System Steering Stabilizer; w/ I-Beam Axle All models with factory frame bracket. Kit 143168 required to install to linkage.	
F	90-93	PICKUP 3/4 TON, W200 SERIES All Single System Steering Stabilizer All models with factory frame bracket. Kit 143168 required to install to linkage.	
F	60-86	PICKUP 3/4 TON, W200 SERIES All Dual System Steering Stabilizer; Exc. Vacuum Servo Mounted on Drivers Side of Axle All models with factory frame bracket. Kit 143168 required to install to linkage.	
F	83-93	PICKUP, RAM 50 RWD Single System Steering Stabilizer All models with factory frame bracket. Kit 143168 required to install to linkage.	
F	87-93	RAMCHARGER RWD Single System Steering Stabilizer All models with factory frame bracket. Kit 143168 required to install to linkage.	
F	74-86	RAMCHARGER All Dual System Steering Stabilizer; Exc. Vacuum Servo Mounted on Drivers Side of Axle All models with factory frame bracket. Kit 143168 required to install to linkage.	
F	71	VAN 1/2 TON, A / B SERIES / RAM All Single System Steering Stabilizer; w/ I-Beam Axle All models with factory frame bracket. Kit 143168 required to install to linkage.	
F	71	VAN 1 TON, A / B SERIES / RAM All Single System Steering Stabilizer; w/ I-Beam Axle All models with factory frame bracket. Kit 143168 required to install to linkage.	
F	71	VAN 3/4 TON, A / B SERIES / RAM All Single System Steering Stabilizer; w/ I-Beam Axle All models with factory frame bracket. Kit 143168 required to install to linkage.	
F	92-96	FORD BRONCO All Single System Steering Stabilizer All models with factory frame bracket. Kit 143168 required to install to linkage.	
F	78-91	BRONCO All Dual System Steering Stabilizer; Exc. Sway Bar All models with factory frame bracket. Kit 143168 required to install to linkage.	

Numerical listing

Shock	POP	Alternative No.	MTG Acc. Supplied
Pos.	Year	Application	
6802SE	B (cont)	141998	
F	84-90	BRONCO II All Single System Steering Stabilizer All models with factory frame bracket. Kit 143168 required to install to linkage.	
F	61-67	ECONOLINE VAN Van Single System Steering Stabilizer All models with factory frame bracket. Kit 143168 required to install to linkage.	
F	91-94	EXPLORER All Single System Steering Stabilizer All models with factory frame bracket. Kit 143168 required to install to linkage.	
F	80-83	PICKUP 1/2 TON, F-100 All Single System Steering Stabilizer All models with factory frame bracket. Kit 143168 required to install to linkage.	
F	77-79	PICKUP 1/2 TON, F-100 All Dual System Steering Stabilizer; Exc. Sway Bar All models with factory frame bracket. Kit 143168 required to install to linkage.	
F	77-79	PICKUP 1/2 TON, F-100 All Single System Steering Stabilizer; w/ Twin I-Beam Axle All models with factory frame bracket. Kit 143168 required to install to linkage.	
F	75-76	PICKUP 1/2 TON, F-100 4WD Dual System Steering Stabilizer; Exc. Sway Bar All models with factory frame bracket. Kit 143168 required to install to linkage.	
F	75-76	PICKUP 1/2 TON, F-100 RWD Single System Steering Stabilizer; w/ Twin I-Beam Axle All models with factory frame bracket. Kit 143168 required to install to linkage.	
F	73-74	PICKUP 1/2 TON, F-100 RWD Single System Steering Stabilizer w/ Twin I Beam Axle All models with factory frame bracket. Kit 143168 required to install to linkage.	
F	65-72	PICKUP 1/2 TON, F-100 All RWD; Single System Steering Stabilizer w/ Twin I Beam Axle All models with factory frame bracket. Kit 143168 required to install to linkage.	
F	61-64	PICKUP 1/2 TON, F-100 All RWD; Single Steering Stabilizer; w/ I Beam Axle All models with factory frame bracket. Kit 143168 required to install to linkage.	
F	60	PICKUP 1/2 TON, F-100 All Single Steering Stabilizer; w/ I Beam Axle All models with factory frame bracket. Kit 143168 required to install to linkage.	
F	94-96	PICKUP 1/2 TON, F-150 4WD Single System Steering Stabilizer; w/ Twin Traction Beam All models with factory frame bracket. Kit 143168 required to install to linkage.	
F	80-93	PICKUP 1/2 TON, F-150 All Single System Steering Stabilizer All models with factory frame bracket. Kit 143168 required to install to linkage.	
F	77-79	PICKUP 1/2 TON, F-150 All Dual System Steering Stabilizer; Exc. Sway Bar All models with factory frame bracket. Kit 143168 required to install to linkage.	
F	75-76	PICKUP 1/2 TON, F-150 RWD Single System Steering Stabilizer All models with factory frame bracket. Kit 143168 required to install to linkage.	
F	92-97	PICKUP 1 TON, F-350 / SUPERDUTY RWD Dual System Steering Stabilizer All models with factory frame bracket. Kit 143168 required to install to linkage.	
F	89-91	PICKUP 1 TON, F-350 / SUPERDUTY RWD Single System Steering Stabilizer All models with factory frame bracket. Kit 143168 required to install to linkage.	
F	82-88	PICKUP 1 TON, F-350 / SUPERDUTY RWD Single System Steering Stabilizer; Exc. Anti-Sway Bar All models with factory frame bracket. Kit 143168 required to install to linkage.	

Numerical listing

Shock	POP	Alternative No.	MTG Acc. Supplied
Pos.	Year	Application	
6802SE	B	(cont)	141998
F	79-81	PICKUP 1 TON, F-350 / SUPERDUTY RWD Dual System Steering Stabilizer All models with factory frame bracket. Kit 143168 required to install to linkage.	
F	75-78	PICKUP 1 TON, F-350 / SUPERDUTY All Dual System Steering Stabilizer All models with factory frame bracket. Kit 143168 required to install to linkage.	
F	65-74	PICKUP 1 TON, F-350 / SUPERDUTY All Single System Steering Stabilizer; w/ Twin I Beam Axle All models with factory frame bracket. Kit 143168 required to install to linkage.	
F	60-64	PICKUP 1 TON, F-350 / SUPERDUTY All Single System Steering Stabilizer w/ I Beam Axle All models with factory frame bracket. Kit 143168 required to install to linkage.	
F	80-96	PICKUP 3/4 TON, F-250 / SUPERDUTY 4WD Single System Steering Stabilizer All models with factory frame bracket. Kit 143168 required to install to linkage.	
F	75-79	PICKUP 3/4 TON, F-250 / SUPERDUTY RWD Single System Steering Stabilizer All models with factory frame bracket. Kit 143168 required to install to linkage.	
F	65-67	PICKUP P100 All Single System Steering Stabilizer All models with factory frame bracket. Kit 143168 required to install to linkage.	
F	83-97	RANGER All Single System Steering Stabilizer All models with factory frame bracket. Kit 143168 required to install to linkage.	
F	69-74	VAN 1/2 TON, ECONOLINE / CLUB WAGON All Single System Steering Stabilizer; w/ Twin I-Beam Axle All models with factory frame bracket. Kit 143168 required to install to linkage.	
F	69-74	VAN 3/4 TON, ECONOLINE / CLUB WAGON / SUPERDUTY All Single System Steering Stabilizer; w/ Twin I-Beam Axle All models with factory frame bracket. Kit 143168 required to install to linkage.	
F	73-91	GMC JIMMY All Replacement damper for vehicles w/ Gabriel aftermarket mounting kit All models with factory frame bracket. Kit 143168 required to install to linkage.	
F	70-72	JIMMY All K5 Dual System Steering Stabilizer All models with factory frame bracket. Kit 143168 required to install to linkage.	
F	57-59	PICKUP All Single System Steering Stabilizer; w/ I-Beam Axle All models with factory frame bracket. Kit 143168 required to install to linkage.	
F	53-56	PICKUP Truck Single System Steering Stabilizer; w/ I-Beam Axle All models with factory frame bracket. Kit 143168 required to install to linkage.	
F	73-86	PICKUP 1/2 TON, C15 / C1500 All Single System Steering Stabilizer All models with factory frame bracket. Kit 143168 required to install to linkage.	
F	69-86	PICKUP 1/2 TON, K15 / K1500 All Dual System Steering Stabilizer All models with factory frame bracket. Kit 143168 required to install to linkage.	
F	87	PICKUP 1/2 TON, R1500 All Single System Steering Stabilizer All models with factory frame bracket. Kit 143168 required to install to linkage.	
F	87	PICKUP 1/2 TON, V1500 All Dual System Steering Stabilizer All models with factory frame bracket. Kit 143168 required to install to linkage.	

Steering Stabilizer

Shock	POP	Alternative No.	MTG Acc. Supplied
Pos.	Year	Application	
6802SE	B	(cont)	141998
F	75-86	PICKUP 1 TON, C35/3500 Crew Cab Pickup Single System Steering Stabilizer All models with factory frame bracket. Kit 143168 required to install to linkage.	
F	72-74	PICKUP 1 TON, C35/3500 All Single System Steering Stabilizer All models with factory frame bracket. Kit 143168 required to install to linkage.	
F	67-86	PICKUP 3/4 TON, C25 / C2500 All Single System Steering Stabilizer All models with factory frame bracket. Kit 143168 required to install to linkage.	
F	67-86	PICKUP 3/4 TON, K25 / K2500 All Dual System Steering Stabilizer All models with factory frame bracket. Kit 143168 required to install to linkage.	
F	87-89	PICKUP 3/4 TON, R2500 All Single System Steering Stabilizer All models with factory frame bracket. Kit 143168 required to install to linkage.	
F	87	PICKUP 3/4 TON, V2500 All AN49 All models with factory frame bracket. Kit 143168 required to install to linkage.	
F	82-93	SONOMA / S15 RWD Single System Steering Stabilizer All models with factory frame bracket. Kit 143168 required to install to linkage.	
F	68-86	SUBURBAN 1/2 TON, C15 / C1500 All Single System Steering Stabilizer All models with factory frame bracket. Kit 143168 required to install to linkage.	
F	68-86	SUBURBAN 1/2 TON, K15 / K1500 All Dual System Steering Stabilizer All models with factory frame bracket. Kit 143168 required to install to linkage.	
F	87-91	SUBURBAN 1/2 TON, R1500 All Single System Steering Stabilizer All models with factory frame bracket. Kit 143168 required to install to linkage.	
F	87-91	SUBURBAN 1/2 TON, V1500 All Dual System Steering Stabilizer All models with factory frame bracket. Kit 143168 required to install to linkage.	
F	68-86	SUBURBAN 3/4 TON, C25 / C2500 All Single System Steering Stabilizer All models with factory frame bracket. Kit 143168 required to install to linkage.	
F	68-86	SUBURBAN 3/4 TON, K25 / K2500 All Dual System Steering Stabilizer All models with factory frame bracket. Kit 143168 required to install to linkage.	
F	87-91	SUBURBAN 3/4 TON, R2500 All Single System Steering Stabilizer All models with factory frame bracket. Kit 143168 required to install to linkage.	
F	87-91	SUBURBAN 3/4 TON, V2500 All Dual System Steering Stabilizer All models with factory frame bracket. Kit 143168 required to install to linkage.	
F	70-95	VAN 1/2 TON, G / SAVANA All Single System Steering Stabilizer All models with factory frame bracket. Kit 143168 required to install to linkage.	
F	71-95	VAN 1 TON, G / SAVANA All Single System Steering Stabilizer All models with factory frame bracket. Kit 143168 required to install to linkage.	
F	70-95	VAN 3/4 TON, G / SAVANA All Single System Steering Stabilizer All models with factory frame bracket. Kit 143168 required to install to linkage.	
F	74	INTERNATIONAL 100 All Single System Steering Stabilizer All models with factory frame bracket. Kit 143168 required to install to linkage.	

Numerical listing

Shock	POP	Alternative No.	MTG Acc. Supplied
Pos.	Year	Application	
6802SE	B	(cont)	141998
F	75	150 All Single System Steering Stabilizer All models with factory frame bracket. Kit 143168 required to install to linkage.	
F	74-75	200 All Single System Steering Stabilizer All models with factory frame bracket. Kit 143168 required to install to linkage.	
F	68-69	908C All Single System Steering Stabilizer; 1/2 Ton, 3/4 Ton & Travelall All models with factory frame bracket. Kit 143168 required to install to linkage.	
F	68	1000C All Single System Steering Stabilizer; 1/2 Ton, 3/4 Ton & Travelall All models with factory frame bracket. Kit 143168 required to install to linkage.	
F	69-70	1000D All Single System Steering Stabilizer; 1/2 Ton, 3/4 Ton & Travelall All models with factory frame bracket. Kit 143168 required to install to linkage.	
F	71-73	1010 All Single System Steering Stabilizer; 1/2 Ton, 3/4 Ton & Travelall All models with factory frame bracket. Kit 143168 required to install to linkage.	
F	68	1100C All Single System Steering Stabilizer; 1/2 Ton, 3/4 Ton & Travelall All models with factory frame bracket. Kit 143168 required to install to linkage.	
F	69-70	1100D All Single System Steering Stabilizer; 1/2 Ton, 3/4 Ton & Travelall All models with factory frame bracket. Kit 143168 required to install to linkage.	
F	71-73	1110 All Single System Steering Stabilizer; 1/2 Ton, 3/4 Ton & Travelall All models with factory frame bracket. Kit 143168 required to install to linkage.	
F	68	1200C All Single System Steering Stabilizer; 1/2 Ton, 3/4 Ton & Travelall All models with factory frame bracket. Kit 143168 required to install to linkage.	
F	69-70	1200D All Single System Steering Stabilizer; 1/2 Ton, 3/4 Ton & Travelall All models with factory frame bracket. Kit 143168 required to install to linkage.	
F	71-73	1210 All Single System Steering Stabilizer; 1/2 Ton, 3/4 Ton & Travelall All models with factory frame bracket. Kit 143168 required to install to linkage.	
F	68	1300C All Single System Steering Stabilizer; 1/2 Ton, 3/4 Ton & Travelall All models with factory frame bracket. Kit 143168 required to install to linkage.	
F	69-70	1300D All Single System Steering Stabilizer; 1/2 Ton, 3/4 Ton & Travelall All models with factory frame bracket. Kit 143168 required to install to linkage.	
F	71-73	1310 All Single System Steering Stabilizer; 1/2 Ton, 3/4 Ton & Travelall All models with factory frame bracket. Kit 143168 required to install to linkage.	
F	61-68	SCOUT All Single System Steering Stabilizer; 4WD; Scout 80, 800 All models with factory frame bracket. Kit 143168 required to install to linkage.	
F	75	TRAVELALL RWD Single System Steering Stabilizer All models with factory frame bracket. Kit 143168 required to install to linkage.	
F	84-91	ISUZU TROOPER 4WD Single System Steering Stabilizer All models with factory frame bracket. Kit 143168 required to install to linkage.	
F	66-83	JEEP CJ5 All Single System Steering Stabilizer All models with factory frame bracket. Kit 143168 required to install to linkage.	

Numerical listing

Shock	POP	Alternative No.	MTG Acc. Supplied
Pos.	Year	Application	
6802SE	B (cont)		141998
F	59-60	CJ5 All Single System Steering Stabilizer All models with factory frame bracket. Kit 143168 required to install to linkage.	
F	66-75	CJ6 All Single System Steering Stabilizer All models with factory frame bracket. Kit 143168 required to install to linkage.	
F	59-60	CJ6 All Single System Steering Stabilizer All models with factory frame bracket. Kit 143168 required to install to linkage.	
F	76-86	CJ7 All Single System Steering Stabilizer All models with factory frame bracket. Kit 143168 required to install to linkage.	
F	66-71	JEEPSTER All Single System Steering Stabilizer All models with factory frame bracket. Kit 143168 required to install to linkage.	
F	81-85	SCRAMBLER / CJ8 All Single System Steering Stabilizer All models with factory frame bracket. Kit 143168 required to install to linkage.	
F	61-67	UNIVERSAL All Single System Steering Stabilizer All models with factory frame bracket. Kit 143168 required to install to linkage.	
F	63-67	WAGONEER All Exc. Independent Front Suspension All models with factory frame bracket. Kit 143168 required to install to linkage.	
F	91-94	MAZDA NAVAJO All Single System Steering Stabilizer All models with factory frame bracket. Kit 143168 required to install to linkage.	
F	95-96	MINI MIGHTY MAX All Single System Steering Stabilizer All models with factory frame bracket. Kit 143168 required to install to linkage.	
F	83-94	MIGHTY MAX RWD Single System Steering Stabilizer All models with factory frame bracket. Kit 143168 required to install to linkage.	
F	86-95	MONTERO All Single System Steering Stabilizer All models with factory frame bracket. Kit 143168 required to install to linkage.	
F	82	NISSAN 720 PICKUP All Single System Steering Stabilizer All models with factory frame bracket. Kit 143168 required to install to linkage.	
F	79-82	PLYMOUTH PICKUP All Single System Steering Stabilizer All models with factory frame bracket. Kit 143168 required to install to linkage.	
F	74-81	TRAILDUSTER All Dual System Steering Stabilizer; Exc. Vacuum Servo Mounted on Drivers Side of Axle All models with factory frame bracket. Kit 143168 required to install to linkage.	
F	86-95	SUZUKI SAMURAI All Single System Steering Stabilizer All models with factory frame bracket. Kit 143168 required to install to linkage.	
F	86-95	TOYOTA PICKUP All Single System Steering Stabilizer All models with factory frame bracket. Kit 143168 required to install to linkage.	
F	79-85	PICKUP RWD Single System Steering Stabilizer All models with factory frame bracket. Kit 143168 required to install to linkage.	
6803SE	W		141998
F	69-72	CHEVROLET BLAZER All Single System Steering Stabilizer	
F	60	PICKUP Truck Dana 60 Axle up to 3 1/2" O.D. or Napco axle up to 3 3/8" O.D.	
F	57-58	PICKUP Truck Dana 60 Axle up to 3 1/2" O.D. or Napco axle up to 3 3/8" O.D.	
F	61-72	PICKUP 1/2 TON, K10 All Single System Steering Stabilizer	
F	61-72	PICKUP 3/4 TON, K20 All Single System Steering Stabilizer	

Steering Stabilizer

Shock	POP	Alternative No.	MTG Acc. Supplied
Pos.	Year	Application	
6803SE	W (cont)		141998
F	01-09	PICKUP 3/4 TON, SILVERADO 2500 HD All 9200# GVW w/o OE Unit - 15059138 15155638	
F	68-72	SUBURBAN 1/2 TON, K10 All Single System Steering Stabilizer	
F	68-72	SUBURBAN 3/4 TON, K20 All Single System Steering Stabilizer	
F	70	DODGE A100 TRUCK All Single System Steering Stabilizer; w/ I-Beam Axle	
F	60-89	PICKUP 1/2 TON, W100 SERIES All Single System Steering Stabilizer	
F	60-89	PICKUP 1 TON, W300 SERIES All Single System Steering Stabilizer	
F	69-89	PICKUP 3/4 TON, W200 SERIES All Single System Steering Stabilizer	
F	60-67	PICKUP 3/4 TON, W200 SERIES All Single System Steering Stabilizer	
F	75-93	RAMCHARGER 4WD Single System Steering Stabilizer	
F	74	RAMCHARGER All Single System Steering Stabilizer	
F	71-87	VAN 1/2 TON, A / B SERIES / RAM All Single System Steering Stabilizer	
F	71-87	VAN 1 TON, A / B SERIES / RAM All Single System Steering Stabilizer	
F	80-87	VAN 3/4 TON, A / B SERIES / RAM All Single System Steering Stabilizer	
F	78-79	VAN 3/4 TON, A / B SERIES / RAM All Van Charger Special	
F	71-77	VAN 3/4 TON, A / B SERIES / RAM All Single System Steering Stabilizer	
F	70-79	FORD BRONCO All Single System Steering Stabilizer	
F	77-79	PICKUP 1/2 TON, F-100 All 4WD; Single System Steering Stabilizer	
F	73-76	PICKUP 1/2 TON, F-100 4WD Single System Steering Stabilizer	
F	70-72	PICKUP 1/2 TON, F-100 4WD 4WD; Single System Steering Stabilizer	
F	60-69	PICKUP 1/2 TON, F-100 All 4WD; Single System Steering Stabilizer	
F	76-79	PICKUP 1/2 TON, F-150 4WD Single System Steering Stabilizer	
F	75	PICKUP 1/2 TON, F-150 All 4WD	
F	75-77	PICKUP 1 TON, F-350 / SUPERDUTY Manual Steering Single System Steering Stabilizer	
F	60-74	PICKUP 1 TON, F-350 / SUPERDUTY All Single System Steering Stabilizer	
F	75-77	PICKUP 3/4 TON, F-250 / SUPERDUTY 4WD, Manual Steering Single System Steering Stabilizer	
F	60-74	PICKUP 3/4 TON, F-250 / SUPERDUTY All Single System Steering Stabilizer	
F	74-79	VAN 3/4 TON, ECONOLINE / CLUB WAGON / SUPERDUTY All QuadraVan Special	
F	71-72	GMC JIMMY 4WD 4WD; K-5 Single System Steering Stabilizer	
F	70	JIMMY All K-5 Single System Steering Stabilizer	
F	69-72	PICKUP 1/2 TON, K15 / K1500 All Single System Steering Stabilizer	
F	67-72	PICKUP 3/4 TON, K25 / K2500 All Single System Steering Stabilizer	
F	68-72	SUBURBAN 1/2 TON, K15 / K1500 All Single System Steering Stabilizer	
F	68-72	SUBURBAN 3/4 TON, K25 / K2500 All Single System Steering Stabilizer	
F	69-71	INTERNATIONAL SCOUT All Single System Steering Stabilizer	
F	71-80	SCOUT II All Single System Steering Stabilizer	
F	75	TRAVELALL 4WD Single System Steering Stabilizer	
F	63-67	JEEP GLADIATOR All Single System Steering Stabilizer	
F	75-81	PLYMOUTH TRAILDUSTER 4WD Single System Steering Stabilizer	
F	74	TRAILDUSTER All Single System Steering Stabilizer	
F	84-85	TOYOTA 4RUNNER All Single System Steering Stabilizer	
F	80-85	PICKUP 4WD Single System Steering Stabilizer; w/ OE Stock Mounts	

Numerical listing

Shock	POP	Alternative No.	MTG Acc. Supplied
Pos.	Year	Application	
6804SE	A		500498,141397
F	80-88	AMERICAN MOTORS EAGLE All Single System Steering Stabilizer	
F	75-86	CHEVROLET BLAZER All Single System Steering Stabilizer	
F	73-86	PICKUP 1/2 TON, K10 All Single System Steering Stabilizer	
F	87	PICKUP 1/2 TON, V10 All Single System Steering Stabilizer	
F	77-86	PICKUP 1 TON, K30 All Single System Steering Stabilizer	
F	73-86	PICKUP 3/4 TON, K20 All Single System Steering Stabilizer	
F	87	PICKUP 3/4 TON, V20 All Single System Steering Stabilizer	
F	73-86	SUBURBAN 1/2 TON, K10 All Single System Steering Stabilizer	
F	87-88	SUBURBAN 1/2 TON, R10 All Single System Steering Stabilizer	
F	73-86	SUBURBAN 3/4 TON, K20 All Single System Steering Stabilizer	
F	87-88	SUBURBAN 3/4 TON, V20 All Single System Steering Stabilizer	
F	89-91	SUBURBAN 3/4 TON, V2500 All Single System Steering Stabilizer	
F	94-95	VAN 1 TON, G / EXPRESS All Single System Steering Stabilizer; HD w/ Straight Front Axle & Tilt Hood	
F	85-93	VAN 1 TON, P SERIES All Single System Steering Stabilizer; w/ I-Beam Front Suspension	
F	87-94	DODGE DAKOTA 4WD Single System Steering Stabilizer	
F	94-97	PICKUP 1/2 TON, RAM 1500 (SEE RAM 1500) 4WD With OEM 52038276	
F	94-97	PICKUP 1 TON, RAM 3500 (SEE RAM 3500) 4WD With OEM 52038276	
F	94-97	PICKUP 1 TON, RAM 3500 (SEE RAM 3500) RWD w/ OEM 52038276 Solid Front Axle	
F	94-97	PICKUP 3/4 TON, RAM 2500 (SEE RAM 2500) 4WD With OEM 52038276	
F	66-69	FORD BRONCO All Single System Steering Stabilizer	
F	73-91	GMC JIMMY All Heavy Duty replacement damper for vehicles w/ OE stabilizer	
F	73-86	PICKUP 1/2 TON, K15 / K1500 All Single System Steering Stabilizer	
F	87	PICKUP 1/2 TON, V1500 All Single System Steering Stabilizer	
F	73-86	PICKUP 3/4 TON, K25 / K2500 All Single System Steering Stabilizer	
F	87	PICKUP 3/4 TON, V2500 All Single System Steering Stabilizer	
F	73-86	SUBURBAN 1/2 TON, K15 / K1500 All Single System Steering Stabilizer	
F	87-91	SUBURBAN 1/2 TON, V1500 All Single System Steering Stabilizer	
F	73-86	SUBURBAN 3/4 TON, K25 / K2500 All Single System Steering Stabilizer	
F	87-91	SUBURBAN 3/4 TON, V2500 All Single System Steering Stabilizer	
F	94-95	VAN 1 TON, G / SAVANA All Single System Steering Stabilizer; HD w/ Straight Front Axle & Tilt Hood	
F	75-83	JEEP CHEROKEE 4WD Single System Steering Stabilizer	
F	74	CHEROKEE All Single System Steering Stabilizer	
F	84-91	GRAND WAGONEER All Single System Steering Stabilizer	
F	74-88	J10 PICKUP All Single System Steering Stabilizer	
F	74-88	J20 PICKUP All Single System Steering Stabilizer	
6828SE	D		142718
F	96-99	FORD ECONOLINE SUPER DUTY All Single System Steering Stabilizer	
F	99-10	PICKUP 1 TON, F-350 / SUPERDUTY RWD Single System Steering Stabilizer	
F	92-97	PICKUP 1 TON, F-350 / SUPERDUTY RWD Single System Steering Stabilizer	
F	99-10	PICKUP 3/4 TON, F-250 / SUPERDUTY RWD Single System Steering Stabilizer	

Numerical listing

Shock	POP	Alternative No.	MTG Acc. Supplied
Pos.	Year	Application	
43049	A (cont)		140630
R	73-74	CAPRICE Sedan Police and Taxi Models	
R	71-72	CAPRICE All Police and Taxi Models	
R	66-70	CAPRICE All	
R	64-67	CHEVELLE All Exc. Heavy Duty Suspension	
R	68	CHEVY II All	
R	64-67	EL CAMINO All	
R	94-96	IMPALA All	
R	83-85	IMPALA All	
R	65-82	IMPALA Sedan	
R	74-81	IMPALA Coupe	
R	73	IMPALA Hardtop	
R	69-70	KINGSWOOD All	
R	64-67	MALIBU All Exc. Heavy Duty Suspension	
R	69-72	NOVA All Multi-Leaf Rear Spring	
R	69-70	TOWNSMAN All	
R	65-85	OLDSMOBILE 88 SERIES All	
R	71-84	98 All	
R	64-67	CUTLASS / CUTLASS SUPREME All Exc. Heavy Duty Suspension	
R	64-67	F85 All Exc. Heavy Duty Suspension	
R	65-66	STARFIRE All	
R	63-81	PONTIAC BONNEVILLE All	
R	75-81	CATALINA Coupe	
R	71-81	CATALINA Sedan	
R	71-74	CATALINA Hardtop	
R	63-70	CATALINA All	
R	67-70	EXECUTIVE All	
R	64-67	GTO All Exc. Heavy Duty Suspension	
R	76-81	LAURENTIAN All	
R	64-67	LEMANS All Exc. Heavy Duty Suspension	
R	76-86	PARISIENNE Sedan	
R	64-67	TEMPEST All Exc. Heavy Duty Suspension	
R	71-72	VENTURA All	
43058	C		140739
R	78-79	FORD BRONCO All	
R	66-77	BRONCO All From Serial #830001	
R	65-69	PICKUP 1/2 TON, F-100 All RWD	
R	75-79	PICKUP 1 TON, F-350 / SUPERDUTY Standard Cab Pickup, RWD	
R	73-74	PICKUP 1 TON, F-350 / SUPERDUTY Standard Cab Pickup RWD	
R	75-79	PICKUP 3/4 TON, F-250 / SUPERDUTY Cab & Chassis, RWD	
R	75-79	PICKUP 3/4 TON, F-250 / SUPERDUTY Extended Cab Pickup, RWD	
R	73-74	PICKUP 3/4 TON, F-250 / SUPERDUTY RWD	
R	65-72	PICKUP 3/4 TON, F-250 / SUPERDUTY All RWD	
R	69-74	VAN 1/2 TON, ECONOLINE / CLUB WAGON All	
R	69-74	VAN 1 TON, ECONOLINE / CLUB WAGON / SUPERDUTY All	
R	69-74	VAN 3/4 TON, ECONOLINE / CLUB WAGON / SUPERDUTY All	
R	76-83	JEEP CHEROKEE All	
F	74-83	CHEROKEE All	
F	82-83	CJ5 All	
F	82-86	CJ7 All	
R	67	GLADIATOR All	
F	93	GRAND WAGONEER All	
R	93	GRAND WAGONEER All	
F	84-91	GRAND WAGONEER All	
R	84-91	GRAND WAGONEER All	
F	74-88	J10 PICKUP All	
R	74-88	J10 PICKUP All	
F	74-88	J20 PICKUP All	
R	74-88	J20 PICKUP All	
R	68-73	J2500 PICKUP All	
R	76-83	WAGONEER All	
F	74-83	WAGONEER All	
R	87-95	WRANGLER All	
43060	A		140630
R	73-81	BUICK CENTURY All	
R	71-83	ESTATE WAGON All	
R	65-67	GRAN SPORT All	
R	68-72	GS / GS350 / GS400 / GS455 All	
R	73-87	REGAL All	
R	91-96	ROADMASTER Wagon	
R	68-72	SKYLARK All	
R	64-67	SKYLARK All Heavy Duty Suspension	

Rear Load Carrier

Shock	POP	Alternative No.	MTG Acc. Supplied
Pos.	Year	Application	
43060	A (cont)		140630
R	68-69	SPECIAL All	
R	64-67	SPECIAL All Heavy Duty Suspension	
R	70-72	SPORTWAGON All	
R	77-96	CHEVROLET CAPRICE Wagon	
R	68-73	CHEVELLE All	
R	64-67	CHEVELLE All Heavy Duty Suspension	
R	68-87	EL CAMINO All	
R	71-82	IMPALA Wagon	
R	73-83	MALIBU All	
R	64-67	MALIBU All Heavy Duty Suspension	
R	70-88	MONTE CARLO All	
R	78-87	GMC SPRINT / CABALLERO RWD	
R	71-77	SPRINT / CABALLERO All	
R	74-77	NISSAN 710 Wagon	
R	78-80	Oldsmobile Custom Cruiser	
R	77-92	OLDSMOBILE CUSTOM CRUISER All	
R	68-87	CUTLASS / CUTLASS SUPREME All	
R	64-67	CUTLASS / CUTLASS SUPREME All Heavy Duty Suspension	
R	80-83	CUTLASS CLASSIC / CUTLASS CRUISER All	
R	68-72	F85 All	
R	64-67	F85 All Heavy Duty Suspension	
R	71-78	TORONADO All	
R	82-86	PONTIAC BONNEVILLE All	
R	78-80	GRAND AM All	
R	73-75	GRAND AM All	
R	75-83	GRAND LEMANS All	
R	69-87	GRAND PRIX All	
R	71-78	GRAND SAFARI All	
R	71-75	GRANDVILLE All	
R	68-73	GTO All	
R	64-67	GTO All Heavy Duty Suspension	
R	68-81	LEMANS All	
R	64-67	LEMANS All Heavy Duty Suspension	
R	80-86	PARISIENNE Wagon	
R	76-79	PARISIENNE All Wagon	
R	87-89	SAFARI All	
R	68-70	TEMPEST All	
R	64-67	TEMPEST All Heavy Duty Suspension	
43085	C		140724
R	84-86	DODGE MINI RAM All	
R	99-03	VAN 1/2 TON, A / B SERIES / RAM 109.3 / 277.6 (WheelBase) Exc. 7000# GVW	
R	81-98	VAN 1/2 TON, A / B SERIES / RAM 109.6 / 278.4 (WheelBase) Exc. 7000# GVW	
R	71-80	VAN 1/2 TON, A / B SERIES / RAM All	
R	71-03	VAN 1 TON, A / B SERIES / RAM All	
R	71-03	VAN 3/4 TON, A / B SERIES / RAM All	
R	74-80	VAN, CB300 All	
R	74-83	PLYMOUTH VAN 1/2 TON, PB SERIES All	
R	74-83	VAN 1 TON, PB SERIES All	
R	74-83	VAN 3/4 TON, PB SERIES All	
43099	B		140126
R	62-67	CHEVROLET CHEVY II All	
R	66	FORD BRONCO All Thru Serial #830000	
R	75-79	PICKUP 1/2 TON, F-100 RWD	
R	70-74	PICKUP 1/2 TON, F-100 RWD Exc. Supercab	
R	75-79	PICKUP 1/2 TON, F-150 Standard Cab Pickup, RWD	
R	75-79	PICKUP 1 TON, F-350 / SUPERDUTY Cab & Chassis, RWD	
R	75-79	PICKUP 1 TON, F-350 / SUPERDUTY Extended Cab Pickup, RWD	
R	74	PICKUP 1 TON, F-350 / SUPERDUTY RWD Supercab	
R	75-79	PICKUP 3/4 TON, F-250 / SUPERDUTY Standard Cab Pickup, RWD	
R	73-74	PICKUP 3/4 TON, F-250 / SUPERDUTY RWD Standard Cab Pickup	
R	70-72	PICKUP 3/4 TON, F-250 / SUPERDUTY All RWD; Standard Cab Pickup	
R	75-91	VAN 1/2 TON, ECONOLINE / CLUB WAGON All	
F	71-80	INTERNATIONAL SCOUT II All	

Numerical listing

Shock	POP	Alternative No.	MTG Acc. Supplied
Pos.	Year	Application	
43111	C		140702
R	87-91	CHEVROLET BLAZER 4WD Full Size; Exc. Lift Kit	
R	85-86	BLAZER 4WD	
R	75-84	BLAZER All	
R	73-74	BLAZER All Exc. Lift Kit	
R	73-86	PICKUP 1/2 TON, C10 All	
R	73-86	PICKUP 1/2 TON, K10 All	
R	87	PICKUP 1/2 TON, R10 All	
R	87	PICKUP 1/2 TON, V10 All Exc. Lift Kit	
R	75-86	PICKUP 3/4 TON, C20 Standard Cab Pickup	
R	73-74	PICKUP 3/4 TON, C20 All Standard Cab Pickup	
R	73-86	PICKUP 3/4 TON, K20 All Exc. Lift Kit	
R	87	PICKUP 3/4 TON, R20 Standard Cab Pickup	
R	87	PICKUP 3/4 TON, V20 All Exc. Quad Suspension and Lift Kit	
R	73-86	SUBURBAN 1/2 TON, C10 All	
R	73-86	SUBURBAN 1/2 TON, K10 All Exc. Lift Kit	
R	87-88	SUBURBAN 1/2 TON, R10 All	
R	89-91	SUBURBAN 1/2 TON, R1500 All	
R	89-91	SUBURBAN 1/2 TON, V1500 All Exc. Lift Kit	
R	73-86	SUBURBAN 3/4 TON, C20 All	
R	73-86	SUBURBAN 3/4 TON, K20 All Exc. Lift Kit	
R	87-88	SUBURBAN 3/4 TON, R20 All	
R	89-91	SUBURBAN 3/4 TON, R2500 All	
R	87-88	SUBURBAN 3/4 TON, V20 All Exc. Quad Suspension and Lift Kit	
R	89-91	SUBURBAN 3/4 TON, V2500 All Exc. Lift Kit	
R	73	VAN 1/2 TON, P SERIES All	
R	73-78	VAN 3/4 TON, P SERIES All	
R	73-91	GMC JIMMY All Exc. Lift Kit	
R	73-86	PICKUP 1/2 TON, C15 / C1500 All	
R	77-86	PICKUP 1/2 TON, K15 / K1500 All	
R	76	PICKUP 1/2 TON, K15 / K1500 All Exc. Lift Kit	
R	75	PICKUP 1/2 TON, K15 / K1500 All	
R	87	PICKUP 1/2 TON, R1500 All	
R	87	PICKUP 1/2 TON, V1500 All Exc. Lift Kit	
R	75-86	PICKUP 3/4 TON, C25 / C2500 Cab & Chassis	
R	75-86	PICKUP 3/4 TON, C25 / C2500 Standard Cab Pickup	
R	73-74	PICKUP 3/4 TON, C25 / C2500 All	
R	73-86	PICKUP 3/4 TON, K25 / K2500 All Exc. Lift Kit	
R	88-89	PICKUP 3/4 TON, R2500 All Exc. Crew Cab & Bonus Cab	
R	87	PICKUP 3/4 TON, R2500 Cab & Chassis Exc. Crew Cab & Bonus Cab	
R	87	PICKUP 3/4 TON, R2500 Standard Cab Pickup Exc. Crew Cab & Bonus Cab	
R	87	PICKUP 3/4 TON, V2500 All Exc. Lift Kit	
R	73-86	SUBURBAN 1/2 TON, C15 / C1500 All	
R	73-86	SUBURBAN 1/2 TON, K15 / K1500 All	
R	87-91	SUBURBAN 1/2 TON, R1500 All	
R	87-91	SUBURBAN 1/2 TON, V1500 All Exc. Lift Kit	
R	73-86	SUBURBAN 3/4 TON, C25 / C2500 All	
R	73-86	SUBURBAN 3/4 TON, K25 / K2500 All Exc. Lift Kit	
R	87-91	SUBURBAN 3/4 TON, R2500 All	
R	87-91	SUBURBAN 3/4 TON, V2500 All Exc. Lift Kit	
R	73	VAN 1/2 TON, P SERIES All	
R	73-78	VAN 3/4 TON, P SERIES All	
43140	A		141150
R	67-74	AMERICAN MOTORS AMBASSADOR All	
R	59-68	AMERICAN All	
R	68-70	AMX All	
R	80-88	EAGLE All	
R	68-74	JAVELIN All	
R	67	MARLIN All	
R	71-78	MATADOR All	
R	69	RAMBLER All	
R	59-60	RAMBLER All	
R	59-60	BUICK ELECTRA All Exc. Air Suspension	

Numerical listing

Shock	POP	Alternative No.	MTG Acc. Supplied
Pos.	Year	Application	
49178	B (cont)	140126,141099	
R	77-79	PICKUP 3/4 TON, F-250 / SUPERDUTY Standard Cab Pickup, 4WD All From Serial No. Y20001	
R	92-14	VAN 1/2 TON, ECONOLINE / CLUB WAGON All	
R	21-24	VAN 1 TON, ECONOLINE / CLUB WAGON / SUPERDUTY All	
R	77-19	VAN 1 TON, ECONOLINE / CLUB WAGON / SUPERDUTY All	
R	07	VAN 1 TON, ECONOLINE / CLUB WAGON / SUPERDUTY All Exc. Cutaway Chassis	
R	75-91	VAN 1 TON, ECONOLINE / CLUB WAGON / SUPERDUTY All Exc. Cutaway Chassis	
R	75-14	VAN 3/4 TON, ECONOLINE / CLUB WAGON / SUPERDUTY All	
49203	D	142261,141099	
R	70-74	AMERICAN MOTORS AMBASSADOR All	
R	70	AMX All	
R	80-88	EAGLE All	
R	70-74	JAVELIN All	
R	71-78	MATADOR All	
R	82-02	CHEVROLET CAMARO All	
R	55-58	PICKUP 3800	
R	54	PICKUP All	
R	49-52	STYLELINE DELUXE All	
R	49-52	STYLELINE SPECIAL All	
R	54	TWO-TEN SERIES All	
R	61-62	VAN 1 TON, P SERIES All	
R	61-62	VAN 3/4 TON, P SERIES All	
R	56-60	FORD PICKUP 3/4 TON, F-250 / SUPERDUTY All	
R	53-54	GMC PICKUP All 1/2 and 3/4 Ton	
R	52-54	LINCOLN CAPRI All	
R	52-54	COSMOPOLITAN All	
R	82-02	PONTIAC FIREBIRD All	
49205	D	141150,141099	
R	67-69	AMERICAN MOTORS AMBASSADOR All	
R	61-68	AMERICAN All	
R	68-69	JAVELIN All	
R	67	MARLIN All	
R	69	RAMBLER All	
R	59-60	RAMBLER All	
R	61-63	BUICK SKYLARK All	
R	61-63	SPECIAL All	
R	64-69	SPORTWAGON All	
R	67-69	CHEVROLET CAMARO All Multi-Leaf Springs	
R	49-52	FLEETLINE All	
R	49-52	FLEETLINE TRUCK All	
R	65-74	FORD COUNTRY SEDAN All	
R	87-91	COUNTRY SQUIRE All	
R	65-74	COUNTRY SQUIRE All	
R	92-02	CROWN VICTORIA All Rear Air Springs	
R	65-72	CUSTOM All	
R	68-77	CUSTOM 500 All	
R	75-76	ELITE All	
R	66-70	FALCON All Wagon	
R	65-67	GALAXIE All	
R	68-74	GALAXIE 500 All	
R	64-66	GALAXIE 500 All	
R	01-02	GRAND MARQUIS All	
R	87-91	LTD / COUNTRY SEDAN / COUNTRY SQUIRE / CROWN VICTORIA All	
R	67-82	LTD / COUNTRY SEDAN / COUNTRY SQUIRE / CROWN VICTORIA All	
R	77-79	LTD II All	
R	72-79	RANCHERO All	
R	65-74	RANCH WAGON All	
R	77-79	THUNDERBIRD All	
R	67-72	THUNDERBIRD All	
R	72-76	TORINO All	
R	70-80	LINCOLN CONTINENTAL All	
R	68-71	MARK III All	
R	72	MARK IV All	
R	80-83	MARK VI All	
R	81-02	TOWN CAR All	
R	67	MERCURY BROUGHAM All	
R	87-91	COLONY PARK All	
R	65-74	COLONY PARK All	
R	66-67	COMET Wagon	
R	65-68	COMMUTER All	
R	74-79	COUGAR All	
R	75-02	GRAND MARQUIS All	
R	69-70	MARAUDER All	
R	65-67	MARAUDER All	

HiJackers

Shock	POP	Alternative No.	MTG Acc. Supplied
Pos.	Year	Application	
49205	D (cont)	141150,141099	
R	67-82	MARQUIS All	
R	65-68	MONTCLAIR All	
R	72-76	MONTEGO All	
R	65-74	MONTEREY All	
R	65-68	PARKLANE All	
R	65-67	VILLAGER All	
R	66-67	VOYAGER All	
R	64-72	OLDSMOBILE VISTA CRUISER All	
R	67-69	PONTIAC FIREBIRD All	
R	98-03	TOYOTA SIENNA All	
49212	C	141099	
R	78-95	CHEVROLET VAN 1/2 TON, G / EXPRESS All	
R	78-95	VAN 1 TON, G / EXPRESS Cutaway Van	
R	78-95	VAN 3/4 TON, G / EXPRESS All Exc. 8600# GVW	
R	84-86	DODGE MINI RAM All	
R	99-03	VAN 1/2 TON, A / B SERIES / RAM 109.3 / 277.6 (WheelBase) Exc. 7000# GVW	
R	82-98	VAN 1/2 TON, A / B SERIES / RAM 109.6 / 278.4 (WheelBase) Exc. 7000# GVW	
R	71-80	VAN 1/2 TON, A / B SERIES / RAM All	
R	71-03	VAN 1 TON, A / B SERIES / RAM All	
R	71-03	VAN 3/4 TON, A / B SERIES / RAM All	
R	78-80	VAN, CB300 All	
R	77	VAN, CB300 All Over 8300# GVW	
R	75-76	VAN, CB300 All	
R	74	VAN, CB300 All Over 8300# GVW	
R	78-95	GMC VAN 1/2 TON, G / SAVANA All	
R	85-95	VAN 1 TON, G / SAVANA Extended Cargo Van	
R	85-95	VAN 1 TON, G / SAVANA Extended Passenger Van	
R	79-95	VAN 1 TON, G / SAVANA Standard Cargo Van	
R	79-95	VAN 1 TON, G / SAVANA Standard Passenger Van	
R	78	VAN 1 TON, G / SAVANA Cutaway Van	
R	78-95	VAN 3/4 TON, G / SAVANA All Exc. 8600# GVW	
R	74-83	PLYMOUTH VAN 1/2 TON, PB SERIES All	
R	74-83	VAN 1 TON, PB SERIES All	
R	74-83	VAN 3/4 TON, PB SERIES All	
49213	A	141099	
R	05	CHEVROLET BLAZER Base, 4WD	
R	05	BLAZER Base, RWD	
R	96-04	BLAZER LS, 4WD	
R	96-04	BLAZER LS, RWD	
R	95-02	BLAZER LT, RWD	
R	95-01	BLAZER LT, 4WD	
R	95-99	BLAZER Base, 4WD	
R	95-99	BLAZER Base, RWD	
R	95-97	BLAZER Deluxe, RWD	
R	83-94	BLAZER, S MODELS All	
R	04-12	COLORADO Torsion Bar (FrontSpringType)	
R	99-04	S10 LS, 4WD	
R	99-03	S10 Base, 4WD	
R	99-03	S10 Base, RWD	
R	99-03	S10 LS, RWD	
R	94-98	S10 LS	
R	82-98	S10 Base	
R	92-93	S10 EL	
R	83-92	S10 Tahoe	
R	88-90	S10 Durango	
R	82-86	S10 Durango	
R	04-12	GMC CANYON RWD, Torsion Bar (FrontSpringType)	
R	05	JIMMY 4WD	
R	92-04	JIMMY All	
R	83-91	S15 JIMMY All	
R	82-04	SONOMA / S15 All	
R	91	SYCLONE All	
R	92-93	TYPHOON All	
R	96-00	ISUZU HOMBRE All	
R	06	I-280 All	
R	07-08	I-290 All	
R	07-08	I-370 All	
R	96-01	OLDSMOBILE BRAVADA All	
R	91-94	BRAVADA All	
49215	C	141099	
R	90-05	CHEVROLET ASTRO All	
R	85-89	ASTRO RWD	
R	90-05	GMC SAFARI All	

Numerical listing

Shock	POP	Alternative No.	MTG Acc. Supplied
Pos.	Year	Application	
49215	C (cont)	141099	
R	85-89	SAFARI RWD	
R	86-89	VOLKSWAGEN VANAGON 4WD	
49218	A	141099	
R	88-02	CHEVROLET PICKUP 1/2 TON, C15 / C1500 All	
R	88-99	PICKUP 1/2 TON, K15 / K1500 All	
R	91-00	PICKUP 1 TON, C35/3500 All	
R	88-90	PICKUP 1 TON, C35/3500 Extended Cab Pickup	
R	88-90	PICKUP 1 TON, C35/3500 Standard Cab Pickup	
R	88-00	PICKUP 1 TON, K35 / K3500 All	
R	88-00	PICKUP 3/4 TON, C25 / C2500 All	
R	88-00	PICKUP 3/4 TON, K25 / K2500 All	
R	88-99	GMC PICKUP 1/2 TON, C15 / C1500 All	
R	88-99	PICKUP 1/2 TON, K15 / K1500 All	
R	92-00	PICKUP 1 TON, C35/3500 Cab & Chassis Exc. HD Straight Front Axle	
R	88-91	PICKUP 1 TON, C35/3500 All Exc. HD Straight Front Axle	
R	88-00	PICKUP 1 TON, K35 / K3500 All	
R	88-00	PICKUP 3/4 TON, C25 / C2500 All	
R	88-00	PICKUP 3/4 TON, K25 / K2500 All	
49221	W	141099	
R	89-97	FORD AEROSTAR All	
49223	W	141099	
R	90	FORD BRONCO II All	
R	89	BRONCO II All Mfg. from 2/89; Vehicles w/ 12mm bolt in rear lower mount	
R	06	RANGER RWD, Coil (FrontSpringType)	
R	98-05	RANGER XL, RWD	
R	98-05	RANGER XLT, RWD	
R	05	RANGER STX, RWD	
R	04	RANGER Tremor, RWD	
R	02	RANGER Postal, RWD	
R	90-97	RANGER RWD	
R	89	RANGER RWD Mfg. from 2/89; Vehicles w/ 12mm bolt in rear lower mount	
R	01-06	MAZDA B2300 RWD, Coil (FrontSpringType)	
R	94-97	B2300 RWD	
R	98-01	B2500 RWD, Coil (FrontSpringType)	
R	03-06	B3000 RWD, Coil (FrontSpringType)	
R	98-01	B3000 RWD, Coil (FrontSpringType)	
R	01-06	B4000 RWD Coil (FrontSpringType)	
R	98-00	B4000 RWD, Coil (FrontSpringType)	
49226	D	141099	
R	84-01	JEEP CHEROKEE All	
R	84-90	WAGONEER All	
49228	A	143331,141248,141099	
R	00-05	BUICK LESABRE All Without OE Style air fitting	
R	06-11	LUCERNE All Exc. Magnetic Ride Control Suspension	
R	97-05	PARK AVENUE All Without OE Style air fitting	
R	95-99	RIVIERA All Without OE Style air fitting	
R	00-05	CADILLAC DEVILLE All Exc. Electronic Adjustable Suspension	
R	06-11	DTS All Exc. Magnetic Ride Control Suspension	
R	98-04	SEVILLE All Without OE Style air fitting	
R	01-03	OLDSMOBILE AURORA All Without OE Style air fitting	
R	95-99	AURORA All Without OE Style air fitting	
R	00-05	PONTIAC BONNEVILLE All Without OE Style air fitting	
49230	B	141099	
R	05-07	BUICK TERRAZA FWD Exc. Air-Leveling Suspension	
R	05-08	CHEVROLET UPLANDER FWD Exc. Auto-Leveling System & Independent Rear Suspension	
R	97-05	VENTURE FWD	
R	97-04	OLDSMOBILE SILHOUETTE FWD	

Numerical listing

Shock	POP	Alternative No.	MTG Acc. Supplied
Pos.	Year	Application	
G51759	W		
R	00-05	SATURN L / LS / LW SERIES All	
G51760	W		
F	05-10	CHRYSLER 300 RWD Right Exc. Performance Suspension	
F	06-10	DODGE CHARGER RWD Right Exc. Police Models	
F	05-08	MAGNUM RWD Right Exc. Performance Suspension	
G51761	W		
F	05-10	CHRYSLER 300 RWD Left Exc. Performance Suspension	
F	06-10	DODGE CHARGER RWD Left Exc. Police Models	
F	05-08	MAGNUM RWD Left Exc. Performance Suspension	
G51765	W		
F	12	NISSAN PATHFINDER All Mfg. to 8/12	
F	05-11	PATHFINDER All	
F	13-15	XTERRA All	
F	12	XTERRA All Mfg. to 12/12	
F	05-11	XTERRA All	
F	09-12	SUZUKI EQUATOR All	
G51766	W		
F	20-21	NISSAN FRONTIER All Exc. Nismo Off Road	
F	17-19	FRONTIER All	
F	13-16	FRONTIER PRO-4X	
F	13-16	FRONTIER SL	
F	11-16	FRONTIER S	
F	11-16	FRONTIER SV	
F	13-15	FRONTIER LE	
F	05-15	FRONTIER XE	
F	12	FRONTIER LE Mfg. to 12/12	
F	12	FRONTIER PRO-4X Mfg. to 12/12	
F	12	FRONTIER SL Mfg. to 12/12	
F	09-11	FRONTIER PRO-4X	
F	05-11	FRONTIER LE	
F	11	FRONTIER SL	
F	05-10	FRONTIER SE	
G51767	W		
R	03-06	SUBARU BAJA All	
R	00-04	OUTBACK All	
G51773	W		
R	00-05	JAGUAR S TYPE All Mfg. to 6/02 Exc. Computer Active Technology Suspension	
G51774	W		
F	04-06	KIA AMANTI All	
G51794	W		
R	02-07	NISSAN LANCER LS	
R	07	LANCER LS Diamond	
R	04-06	LANCER Ralliart	
R	02-06	LANCER OZ Rally	
R	06	LANCER DE	
R	06	LANCER SE	
R	04	LANCER DE	
R	04	LANCER Sportback	
G51795	W		
R	04-09	TOYOTA PRIUS All	
G51806	W		
F	06-10	HYUNDAI AZERA All	
F	06-10	SONATA All	
G51813	W		
F	03-07	INFINITI G35 Coupe Left Sport Suspension	
F	03-05	NISSAN 350Z All Left	
G51814	W		
F	03-07	INFINITI G35 Coupe Right Sport Suspension	
F	03-05	NISSAN 350Z All Right	
G51815	W		
F	05-09	DODGE DAKOTA All	
F	06-09	NISSAN RAIDER All	
G51825	W		
R	04-06	KIA AMANTI All	
G51832	W		
F	01-06	LEXUS LS430 All	
G51833	W		
R	01-06	LEXUS LS430 All	

Ultra Struts

Shock	POP	Alternative No.	MTG Acc. Supplied
Pos.	Year	Application	
G51838	W		
R	03-04	NISSAN OUTLANDER All	
G51842	W		
R	07-12	DODGE CALIBER All	
R	07-10	JEEP COMPASS All	
R	07-10	PATRIOT All	
G51847	W		
R	04-08	ACURA TSX All	
G51848	W		
R	09-10	DODGE JOURNEY FWD	
G51849	W		
R	05-07	FORD FIVE HUNDRED FWD	
R	05-07	MERCURY MONTEGO FWD	
G51850	W		
F	04-12	CHEVROLET COLORADO RWD, Coil (FrontSpringType) D Standard Suspension; Exc. Z71 Off Road Package	
F	04-11	GMC CANYON RWD, Coil (FrontSpringType) Exc. Z71 Off Road Package	
F	06	ISUZU I-280 RWD, Coil (FrontSpringType) Exc. Z71 Off Road Package	
F	07-08	I-290 RWD, Coil (FrontSpringType) Exc. Z71 Off Road Package	
F	08	I-370 RWD, Coil (FrontSpringType) Exc. Z71 Off Road Package	
F	07	I-370 RWD	
G51852	W		
R	05-10	SCION TC All	
G51853	W		
F	05-15	TOYOTA TACOMA Base, RWD Left	
F	05-15	TACOMA Pre Runner, RWD Left	
G51854	W		
F	05-15	TOYOTA TACOMA Base, RWD Right	
F	05-15	TACOMA Pre Runner, RWD Right	
G51855	W		
F	07-20	TOYOTA TUNDRA All	
G51856	C		
F	09-10	DODGE PICKUP 1/2 TON, RAM 1500 (SEE RAM 1500) 4WD	
F	16-18	RAM 1500 (SEE DODGE RAM 1500) 4WD Exc. Air Suspension	
F	11-15	1500 (SEE DODGE RAM 1500) 4WD	
F	19-20	1500 CLASSIC 4WD Old Body Style	
G51858	W		
R	03-11	HONDA ELEMENT All	
G51859	W		
F	06-09	FORD FUSION All	
F	07-09	LINCOLN MKZ All	
F	06	ZEPHYR All	
F	06-09	MERCURY MILAN All	
G51860	W		
F	07-13	FORD EXPEDITION Coil (RearSpringType) Exc. Air Suspension	
F	07-13	LINCOLN NAVIGATOR All	
G51861	D		
R	17-21	FORD EXPEDITION All	
R	07-16	EXPEDITION Coil (FrontSpringType) Exc. Air Suspension	
R	07-17	LINCOLN NAVIGATOR All Exc. Air Suspension	
G51863	W		
R	14	CHRYSLER 200 All	
R	11-13	200 All Standard Suspension	
R	07-10	SEBRING All	
R	08-14	DODGE AVENGER All	
G51864	W		
F	09-13	FORD LOBO 4WD	
F	09-13	PICKUP 1/2 TON, F-150 4WD	
F	10-12	LINCOLN MARK LT 4WD	
G51865	W		
F	09-13	FORD LOBO RWD	
F	09-13	PICKUP 1/2 TON, F-150 RWD	

Numerical listing

Shock	POP	Alternative No.	MTG Acc. Supplied
Pos.	Year	Application	
G51870	D		
F	08-13	CHEVROLET PICKUP 1/2 TON, SILVERADO 1500 All Exc. Electronic Adjustable Suspension	
F	07	PICKUP 1/2 TON, SILVERADO 1500 Base Exc. Electronic Adjustable Suspension	
F	07	PICKUP 1/2 TON, SILVERADO 1500 LT Exc. Electronic Adjustable Suspension	
F	07	PICKUP 1/2 TON, SILVERADO 1500 LTZ Exc. Electronic Adjustable Suspension	
F	07	PICKUP 1/2 TON, SILVERADO 1500 WT Exc. Electronic Adjustable Suspension	
F	08-13	GMC SIERRA 1500 All Exc. Electronic Adjustable Suspension	
F	07	SIERRA 1500 SLE Exc. Electronic Adjustable Suspension	
F	07	SIERRA 1500 SLT Exc. Electronic Adjustable Suspension	
F	07	SIERRA 1500 WT Exc. Electronic Adjustable Suspension	
G51877	W		
F	08-12	HONDA ACCORD All Left	
G51878	W		
F	08-12	HONDA ACCORD All Right	
G51879	W		
R	07-11	HONDA CR-V All	
G51880	W		
R	06-14	HONDA RIDGELINE All	
G51881	W		
R	02-06	MINI COOPER All	
G51883	W		
R	10-12	NISSAN GALANT SE	
R	04-11	GALANT ES	
R	04-08	GALANT DE	
R	05-07	GALANT SE	
G51887	W		
F	10-11	FORD CROWN VICTORIA Base	
F	07-11	CROWN VICTORIA LX	
F	03-08	CROWN VICTORIA Base	
F	04-06	CROWN VICTORIA LX Sport	
F	05	CROWN VICTORIA Special Edition	
F	03	CROWN VICTORIA LWB	
F	03	CROWN VICTORIA S	
F	03-11	LINCOLN TOWN CAR All Exc. Limo	
F	03-11	MERCURY GRAND MARQUIS All	
G51888	W		
F	03-11	FORD CROWN VICTORIA Police Interceptor	
F	03-11	LINCOLN TOWN CAR All Limo Models	
F	03-04	MERCURY MARAUDER All	
G51891	C		
F	07-13	CHEVROLET AVALANCHE 1500 All Exc. Z55 or ZW7 Ride Suspension	
F	07-14	SUBURBAN 1/2 TON, 1500 All Exc. Z55 or ZW7 Ride Suspension	
F	07-14	TAHOE All Exc. Z55 or ZW7 Ride Suspension	
F	07-14	GMC YUKON All Exc. Z55 or ZW7 Ride Suspension	
F	07-14	YUKON XL 1/2 TON All Exc. Z55 or ZW7 Ride Suspension	
G51892	D		
R	15-17	HONDA ACCORD All	
R	13-14	ACCORD Sedan	
R	08-12	ACCORD All	
G51896	W		
F	10-12	FORD FUSION All Left	
F	10-12	LINCOLN MKZ All Left	
F	10-11	MERCURY MILAN All Left	
G51897	W		
F	10-12	FORD FUSION All Right	
F	10-12	LINCOLN MKZ All Right	
F	10-11	MERCURY MILAN All Right	
G51898	D		
R	09-10	PONTIAC VIBE FWD	
R	09-17	TOYOTA COROLLA All	
R	09-14	MATRIX FWD	

Numerical listing

Shock	POP	Alternative No.	MTG Acc. Supplied
Pos.	Year	Application	
G51899	W		
F 01		HYUNDAI	XG300 All
F 02-05			XG350 All
G51900	W		
R 04-08		BMW	525i All
R 04-08			530i All
G51901	D		
F 08-11		CADILLAC	CTS All Exc. Magnetic Ride Control Suspension
G51908	W		
R 08-11		MITSUBISHI	LANCER DE
R 08-11			LANCER ES
G51910	W		
R 05-09		SUBARU	OUTBACK All
G51911	W		
F 05-12		ACURA	RL All
G51914	W		
R 05-06		ACURA	RSX All
G51916	W		
R 10-15		CHEVROLET	CAMARO 3.6L 6Cyl V (217)
G51919	W		
R 09-14		ACURA	TL All
R 09-14			TSX All
G51920	W		
F 06-15		LEXUS	IS250 RWD Left
F 06-15			IS350 RWD Left
G51921	W		
F 06-15		LEXUS	IS250 RWD Right
F 06-15			IS350 RWD Right
G51922	W		
R 06-13		LEXUS	IS250 RWD
R 06-13			IS350 RWD
G51925	W		
F 06-07		INFINITI	M35 RWD Left
F 06-07			M45 All Left
G51926	W		
F 06-07		INFINITI	M35 RWD Right
F 06-07			M45 All Right
G51928	W		
R 04-10		VOLKSWAGEN	TOUAREG All Exc. Air Suspension
G51933	W		
R 10-11		MITSUBISHI	ENDEAVOR AWD
R 04-08			ENDEAVOR AWD
G51934	W		
R 07-13		MINI	COOPER All
G51937	W		
F 17		TOYOTA	SEQUOIA All Exc. Air Suspension
F 08-16			SEQUOIA All
G51947	W		
F 05-10		CHRYSLER	300 RWD Left Performance Suspension
F 08-10		DODGE	CHALLENGER All Left
F 06-10		CHARGER	RWD Left Police Package
F 05-08		MAGNUM	RWD Left Performance Suspension
G51948	W		
F 05-10		CHRYSLER	300 RWD Right Performance Suspension
F 08-10		DODGE	CHALLENGER All Right
F 06-10		CHARGER	RWD Right Police Package
F 05-08		MAGNUM	RWD Right Performance Suspension
G51949	B		
F 14-18		CHEVROLET	PICKUP 1/2 TON, SILVERADO 1500 All
F 15-20			SUBURBAN 1/2 TON, 1500 All Old Body Style
F 15-20			TAHOE All Old Body Style
F 14-18		GMC	SIERRA 1500 All
F 15-20			YUKON All Old Body Style
F 15-20			YUKON XL All Old Body Style

Ultra Struts

Shock	POP	Alternative No.	MTG Acc. Supplied
Pos.	Year	Application	
G51961	W		
R 09-13		SUBARU	FORESTER All
G51995	B		
R 05		LEXUS	SC430 All Mfg to 0/05; For Large Spring Seat Design 134MM or 5.275 Inches
R 02-04			SC430 All For Large Spring Seat Design 134MM or 5.275 Inches
G52004	W		
F 06-12		TOYOTA	RAV4 All Left
G52005	W		
F 12-13		MAZDA	3 GS-SKY Left
F 10-13			3 GT Left
F 10-13			3 GX Left
F 10-13			3 i Left
F 10-13			3 S Left
F 13			3 Grand Touring Left
F 13			3 I Touring Left
F 10-12			3 GS Left
F 11			3 Sport GS Left
F 11			3 Sport GT Left
F 11			3 Sport GX Left
F 08-09			3 GS Left Exc. Turbo, Exc. Models w/ 17" Wheels
F 08-09			3 GT Left Exc. Turbo, Exc. Models w/ 17" Wheels
F 08-09			3 GX Left Exc. Turbo, Exc. Models w/ 17" Wheels
F 07-09			3 i Left Exc. Turbo, Exc. Models w/ 17" Wheels
F 07-09			3 S Left Exc. Turbo, Exc. Models w/ 17" Wheels
F 04-06			3 All Left
F 06-10			5 All Left
G52006	W		
F 12-13		MAZDA	3 GS-SKY Right
F 10-13			3 GT Right
F 10-13			3 GX Right
F 10-13			3 i Right
F 10-13			3 S Right
F 13			3 Grand Touring Right
F 13			3 I Touring Right
F 10-12			3 GS Right
F 11			3 Sport GS Right
F 11			3 Sport GT Right
F 11			3 Sport GX Right
F 08-09			3 GS Right Exc. Turbo, Exc. Models w/ 17" Wheels
F 08-09			3 GT Right Exc. Turbo, Exc. Models w/ 17" Wheels
F 08-09			3 GX Right Exc. Turbo, Exc. Models w/ 17" Wheels
F 07-09			3 i Right Exc. Turbo, Exc. Models w/ 17" Wheels
F 07-09			3 S Right Exc. Turbo, Exc. Models w/ 17" Wheels
F 04-06			3 All Right
F 06-10			5 All Right
G52007	W		
F 06-12		TOYOTA	RAV4 All Right
G52008	W		
F 03-07		NISSAN	MURANO All Left
G52009	W		
F 03-07		NISSAN	MURANO All Right
G52013	W		
F 03-08		PONTIAC	VIBE FWD Left
F 08			VIBE All Left
F 03-08		TOYOTA	MATRIX All Left
G52014	W		
F 03-08		PONTIAC	VIBE FWD Right
F 03-08		TOYOTA	MATRIX All Right
G52017	W		
R 02-03		KIA	SPECTRA All Left
G52018	W		
R 02-03		KIA	SPECTRA All Right
G52025	W		
F 05-07		BUICK	TERRAZA FWD Exc. Auto-Leveling System
F 05-09		CHEVROLET	UPLANDER All Exc. Auto-Leveling System
F 05-09		PONTIAC	MONTANA SV6 Exc. Self-Leveling Suspension
F 05-07		SATURN	RELAY All Exc. Auto-Leveling System

Numerical listing

Shock	POP	Alternative No.	MTG Acc. Supplied
Pos.	Year	Application	
G52026	W		
F 02-07		SATURN	VUE All Left
G52027	W		
F 02-07		SATURN	VUE All Right
G52032	W		
F 04-09		NISSAN	QUEST All Left
G52033	W		
F 04-09		NISSAN	QUEST All Right
G52036	W		
F 03-06		KIA	SORENTO All Left
G52037	W		
F 03-06		KIA	SORENTO All Right
G52081	W		
F 07-12		DODGE	CALIBER All Left
F 07-10		JEEP	COMPASS All Left
F 07-10		PATRIOT	All Left
G52082	W		
F 07-12		DODGE	CALIBER All Right
F 07-10		JEEP	COMPASS All Right
F 07-10		PATRIOT	All Right
G52094	W		
F 07-12		NISSAN	SENTRA Base Left
F 07-12			SENTRA S Left
F 07-12			SENTRA SL Left
G52095	W		
F 07-12		NISSAN	SENTRA Base Right
F 07-12			SENTRA S Right
F 07-12			SENTRA SL Right
G52096	W		
F 05-10		SCION	TC All Left
G52097	W		
F 05-10		SCION	TC All Right
G52098	W		
F 04-06		SCION	XA All
F 04-06			XB All
G52103	W		
R 07-12		LEXUS	ES350 All Left
R 06-11		TOYOTA	AVALON All Left Mfg. from 1/06
R 07-11			CAMRY All Left
G52104	W		
R 07-12		LEXUS	ES350 All Right
R 06-11		TOYOTA	AVALON All Right Mfg. from 1/06
R 07-11			CAMRY All Right
G52105	W		
F 06-10		TOYOTA	SIENNA All Left 8 Passenger
F 05			SIENNA All Left Mfg. from 7/05; w/ 8 Passenger Seating
G52106	W		
F 06-10		TOYOTA	SIENNA All Right 8 Passenger
F 05			SIENNA All Right Mfg. from 7/05; w/ 8 Passenger Seating
G52107	W		
F 06-10		TOYOTA	SIENNA FWD Left w/ 7 Passenger Seating
F 05			SIENNA FWD Left Mfg. from 7/05; w/ 7 Passenger Seating
G52108	W		
F 06-10		TOYOTA	SIENNA FWD Right w/ 7 Passenger Seating
F 05			SIENNA FWD Right Mfg. from 7/05; w/ 7 Passenger Seating
G52110	W		
F 05-07		FORD	FREESTYLE All Left
G52111	W		
F 05-07		FORD	FREESTYLE All Right
G52112	W		
F 11		HONDA	ELEMENT All Left
F 04-10			ELEMENT LX Left
F 03-10			ELEMENT EX Left
F 03-04			ELEMENT DX Left
G52113	W		
F 11		HONDA	ELEMENT All Right

Numerical listing

Shock	POP	Alternative No.	MTG Acc. Supplied
Pos.	Year	Application	
G52113 W (cont)			
F	04-10	ELEMENT LX Right	
F	03-10	ELEMENT EX Right	
F	03-04	ELEMENT DX Right	
G52116 W			
F	06-11	BUICK LUCERNE All Exc. Magnetic Ride Control Suspension	
F	06-11	CADILLAC DTS All Exc. Magnetic Ride Control Suspension	
G52117 W			
F	11-14	CHRYSLER 200 All Left	
F	08-10	SEBRING All Left	
F	08-14	DODGE AVENGER All Left	
G52118 W			
F	14	CHRYSLER 200 All Right	
F	11-13	200 All Right Standard Suspension	
F	08-10	SEBRING All Right	
F	08-14	DODGE AVENGER All Right	
G52121 W			
F	07-13	NISSAN ALTIMA Base Left	
F	07-13	ALTIMA S Left	
F	07-13	ALTIMA SL Left	
F	13	ALTIMA Advance Left	
F	13	ALTIMA Exclusive Left	
F	13	ALTIMA Sense Left	
F	13	ALTIMA SV Left	
F	10-12	ALTIMA SR Left	
F	08-09	ALTIMA Coupe Left	
F	07-09	ALTIMA SE Left	
G52122 W			
F	07-13	NISSAN ALTIMA Base Right	
F	07-13	ALTIMA S Right	
F	07-13	ALTIMA SL Right	
F	13	ALTIMA Advance Right	
F	13	ALTIMA Exclusive Right	
F	13	ALTIMA Sense Right	
F	13	ALTIMA SV Right	
F	10-12	ALTIMA SR Right	
F	08-09	ALTIMA Coupe Right	
F	07-09	ALTIMA SE Right	
G52125 W			
F	08-12	BUICK ENCLAVE All	
F	09-12	CHEVROLET TRAVERSE All	
F	07-12	GMC ACADIA All	
F	07-10	SATURN OUTLOOK All	
G52127 D			
F	07-17	CHEVROLET EQUINOX All Left Exc. Sport Suspension	
F	10-16	GMC TERRAIN All Left	
F	07-09	PONTIAC TORRENT All Left Exc. Sport Suspension	
F	08-10	SATURN VUE All Left	
F	07-09	SUZUKI XL-7 All Left	
G52128 D			
F	07-17	CHEVROLET EQUINOX All Right Exc. Sport Suspension	
F	10-16	GMC TERRAIN All Right	
F	07-09	PONTIAC TORRENT All Right Exc. Sport Suspension	
F	08-10	SATURN VUE All Right	
F	07-09	SUZUKI XL-7 All Right	
G52129 W			
F	08-09	FORD TAURUS FWD Left	
F	08-09	MERCURY SABLE FWD Left	
G52130 W			
F	08-09	FORD TAURUS FWD Right	
F	08-09	MERCURY SABLE FWD Right	
G52131 D			
F	15-16	CHRYSLER TOWN & COUNTRY Touring Piel	
F	13-16	TOWN & COUNTRY Li	
F	13-16	TOWN & COUNTRY Limited	
F	13-16	TOWN & COUNTRY LX	
F	13-16	TOWN & COUNTRY Touring	
F	13-16	TOWN & COUNTRY Touring L	
F	16	TOWN & COUNTRY Limited Platinum	
F	16	TOWN & COUNTRY Premium	
F	14	TOWN & COUNTRY 30th Anniversary Edition	
F	14	TOWN & COUNTRY Base	
F	08-12	TOWN & COUNTRY All Exc. Self-Leveling Suspension	
F	18-20	DODGE CARAVAN / GRAND CARAVAN Canada Value Package	

Ultra Struts

Shock	POP	Alternative No.	MTG Acc. Supplied
Pos.	Year	Application	
G52131 D (cont)			
F	18-20	CARAVAN / GRAND CARAVAN Crew	
F	18-20	CARAVAN / GRAND CARAVAN Crew Plus	
F	17-20	CARAVAN / GRAND CARAVAN SXT Plus	
F	13-20	CARAVAN / GRAND CARAVAN SE	
F	12-20	CARAVAN / GRAND CARAVAN SXT	
F	20	CARAVAN / GRAND CARAVAN Premium Plus	
F	20	CARAVAN / GRAND CARAVAN SE Plus	
F	18-19	CARAVAN / GRAND CARAVAN SXT Premium Plus	
F	14-16	CARAVAN / GRAND CARAVAN American Value Package	
F	14-16	CARAVAN / GRAND CARAVAN SE Plus	
F	12-14	CARAVAN / GRAND CARAVAN Crew	
F	12-14	CARAVAN / GRAND CARAVAN Crew Plus	
F	14	CARAVAN / GRAND CARAVAN 30th Anniversary Edition	
F	14	CARAVAN / GRAND CARAVAN SE 30th Anniversary Edition	
F	14	CARAVAN / GRAND CARAVAN SE Canada Value Package	
F	14	CARAVAN / GRAND CARAVAN SXT 30th Anniversary Edition	
F	14	CARAVAN / GRAND CARAVAN SXT Plus	
F	13	CARAVAN / GRAND CARAVAN Canada Value Package	
F	12	CARAVAN / GRAND CARAVAN Canada Value Package Exc. Self-Leveling Suspension	
F	12	CARAVAN / GRAND CARAVAN SE Exc. Self-Leveling Suspension	
F	08-11	CARAVAN / GRAND CARAVAN All Exc. Self-Leveling Suspension	
F	09-14	VOLKSWAGEN ROUTAN All Exc. Self-Leveling Suspension	
G52140 W			
F	03-06	ACURA MDX All Left	
G52141 W			
F	03-06	ACURA MDX All Right	
G52142 W			
F	08-13	BMW 128i All Left Exc. Sport Suspension	
F	08-13	135i All Left Exc. Sport Suspension	
F	07-11	323i All Left Exc. Sport Suspension	
F	06	325i All Left Mfg. to 9/01; Sport Suspension	
F	07-13	328i All Left	
F	06	330i All Left	
F	09-11	335D All Left	
F	07-13	335i All Left	
F	11-13	335iS All Left	
G52143 W			
F	08-13	BMW 128i All Right Exc. Sport Suspension	
F	08-13	135i All Right Exc. Sport Suspension	
F	07-11	323i All Right Exc. Sport Suspension	
F	06	325i All Right Mfg. to 9/01; Sport Suspension	
F	07-13	328i All Right	
F	06	330i All Right	
F	09-11	335D All Right	
F	07-13	335i All Right	
F	11-13	335iS All Right	
G52144 W			
F	00-06	BMW X5 Coil (FrontSpringType) Left	
G52145 W			
F	00-06	BMW X5 Coil (FrontSpringType) Right	
G52148 D			
F	20	DODGE JOURNEY All Left	
F	18-19	JOURNEY Sport Left	
F	17-19	JOURNEY Canada Value Package Left	
F	17-19	JOURNEY Crossroad Left	
F	17-19	JOURNEY SE Left	
F	17-19	JOURNEY SXT Left	

Numerical listing

Shock	POP	Alternative No.	MTG Acc. Supplied
Pos.	Year	Application	
G52148 D (cont)			
F	19	JOURNEY SE Blacktop Left	
F	19	JOURNEY SE Plus Left	
F	19	JOURNEY Sport Plus Left	
F	17-18	JOURNEY SXT Lujo Left	
F	17	JOURNEY SE Plus Left	
F	17	JOURNEY SXT Sport Left	
F	09-16	JOURNEY All Left	
G52149 D			
F	20	DODGE JOURNEY All Right	
F	18-19	JOURNEY Sport Right	
F	17-19	JOURNEY Canada Value Package Right	
F	17-19	JOURNEY Crossroad Right	
F	17-19	JOURNEY SE Right	
F	17-19	JOURNEY SXT Right	
F	19	JOURNEY SE Blacktop Right	
F	19	JOURNEY SE Plus Right	
F	19	JOURNEY Sport Plus Right	
F	17-18	JOURNEY SXT Lujo Right	
F	17	JOURNEY SE Plus Right	
F	17	JOURNEY SXT Sport Right	
F	09-16	JOURNEY All Right	
G52150 W			
F	06-14	HONDA RIDGELINE All Left	
G52151 W			
F	06-14	HONDA RIDGELINE All Right	
G52152 W			
F	10-12	HONDA CITY All Left	
F	15-16	FIT All Left	
F	13-14	FIT DX Left	
F	13-14	FIT EX Left	
F	13-14	FIT LX Left	
F	13-14	FIT Sport Left	
F	13	FIT Base Left	
F	09-12	FIT All Left	
F	10-14	INSIGHT All Left	
G52153 W			
F	10-12	HONDA CITY All Right	
F	15-16	FIT All Right	
F	13-14	FIT DX Right	
F	13-14	FIT EX Right	
F	13-14	FIT LX Right	
F	13-14	FIT Sport Right	
F	13	FIT Base Right	
F	09-12	FIT All Right	
F	10-14	INSIGHT All Right	
G52154 W			
F	06-11	DODGE ATTITUDE All Left	
F	06-11	HYUNDAI ACCENT All Left	
F	06-11	KIA RIO All Left	
F	06-11	RIO All Left	
G52155 W			
F	06-11	DODGE ATTITUDE All Right	
F	06-11	HYUNDAI ACCENT All Right	
F	06-11	KIA RIO All Right	
F	06-11	RIO All Right	
G52156 W			
F	07-10	HYUNDAI ELANTRA All Left	
G52157 W			
F	07-10	HYUNDAI ELANTRA All Right	
G52158 W			
F	07-09	HYUNDAI SANTA FE All Left	
G52159 W			
F	07-09	HYUNDAI SANTA FE All Right	
G52160 W			
F	05-09	KIA SPECTRA All Left	
F	04-09	SPECTRA All Left	
G52161 W			
F	05-09	KIA SPECTRA All Right	
F	04-09	SPECTRA All Right	
G52162 W			
R	05-09	KIA SPECTRA All Left	
R	04-09	SPECTRA All Left	
G52163 W			
R	05-09	KIA SPECTRA All Right	
R	04-09	SPECTRA All Right	
G52164 W			
F	02-06	MINI COOPER All Left	

Numerical listing

Shock	POP	Alternative No.	MTG Acc. Supplied
Pos.	Year	Application	
G52165	W		
F	02-06	MINI COOPER All Right	
G52168	W		
F	10-12	MITSUBISHI GALANT SE Left	
F	04-11	GALANT ES Left	
F	04-08	GALANT DE Left	
F	05-07	GALANT SE Left	
G52169	W		
F	10-12	MITSUBISHI GALANT SE Right	
F	04-11	GALANT ES Right	
F	04-08	GALANT DE Right	
F	05-07	GALANT SE Right	
G52170	W		
F	13	NISSAN MURANO All Left	
F	12	MURANO All Left Mfg. to 12/12	
F	08-11	MURANO All Left	
G52171	W		
F	13	NISSAN MURANO All Right	
F	12	MURANO All Right Mfg. to 12/12	
F	08-11	MURANO All Right	
G52172	W		
F	12	MERCEDES-BENZ C250 Sedan, CGI (FuelDelSubType)	
F	10-11	C250 All	
F	08-09	C280 All	
F	10-11	C300 Elegance	
F	08-11	C300 Luxury	
F	08-10	C300 Base	
F	10	C300 Classic	
F	12	C350 Base	
F	08-10	C350 Base	
F	09	C350 Elegance	
F	08	C350 All	
G52173	W		
F	08-12	NISSAN ROGUE All Left w/ OE# E4303JM00A	
F	10-12	X-TRAIL All Left	
F	08	X-TRAIL All Left	
G52174	W		
F	08-12	NISSAN ROGUE All Right w/ OE# E4302JM00A	
F	10-12	X-TRAIL All Right	
F	08	X-TRAIL All Right	
G52175	W		
F	03-11	SAAB 9-3 All Left	
G52176	W		
F	03-11	SAAB 9-3 All Right	
G52182	W		
R	06-08	SUBARU FORESTER Manual Left	
G52183	W		
R	06-08	SUBARU FORESTER Manual Right	
G52184	W		
F	06-13	SUZUKI GRAND VITARA All Left	
G52185	W		
F	06-13	SUZUKI GRAND VITARA All Right	
G52187	W		
F	07-12	ACURA RDX All Left	
F	07-14	HONDA CR-V All Left	
G52188	W		
F	07-12	ACURA RDX All Right	
F	07-14	HONDA CR-V All Right	
G52199	W		
F	04-10	BMW X3 All Left	
G52200	W		
F	04-10	BMW X3 All Right	
G52201	W		
F	08-10	TOYOTA HIGHLANDER All Left	
G52202	W		
F	08-10	TOYOTA HIGHLANDER All Right	
G52203	W		
R	08-13	TOYOTA HIGHLANDER FWD Left	
G52204	W		
R	08-13	TOYOTA HIGHLANDER FWD Right	
G52209	W		
F	07-10	MAZDA CX-7 All Left	

Ultra Struts

Shock	POP	Alternative No.	MTG Acc. Supplied
Pos.	Year	Application	
G52210	W		
F	07-10	MAZDA CX-7 All Right	
G52237	W		
F	00	BMW 323CI Coupe Left Exc. Sport Suspension	
F	00	323i Sedan Left Exc. Sport Suspension	
F	01-06	325CI All Left Exc. Sport Suspension	
F	01-05	325i Sedan Left Exc. Sport Suspension	
F	00	328CI Coupe Left Exc. Sport Suspension	
F	01-06	330CI All Left Exc. Sport Suspension	
G52238	W		
F	00	BMW 323CI Coupe Right Exc. Sport Suspension	
F	00	323i Sedan Right Exc. Sport Suspension	
F	01-06	325CI All Right Exc. Sport Suspension	
F	01-05	325i Sedan Right Exc. Sport Suspension	
F	00	328CI Coupe Right Exc. Sport Suspension	
F	01-06	330CI All Right Exc. Sport Suspension	
G52244	W		
R	05-09	BUICK ALLURE All Models w/ 17" or 18" Wheels	
R	05-09	LACROSSE All Models w/ 17" or 18" Wheels	
R	04-11	CHEVROLET IMPALA All Models w/ 17" or 18" Wheels	
R	05-07	MONTE CARLO All Models w/ 17" or 18" Wheels	
R	04-08	PONTIAC GRAND PRIX All Models w/ 17" or 18" Wheels	
G52245	D		
F	09-10	PONTIAC VIBE All Left	
F	09-13	TOYOTA COROLLA All Left	
F	09-14	MATRIX All Left	
G52246	D		
F	09-10	PONTIAC VIBE All Right	
F	09-13	TOYOTA COROLLA All Right	
F	09-14	MATRIX All Right	
G52247	W		
F	07-10	KIA MAGENTIS All Left	
F	07-10	OPTIMA All Left	
F	06	OPTIMA All Left New Body Style	
F	07-11	RONDO All Left	
G52248	W		
F	07-10	KIA MAGENTIS All Right	
F	07-10	OPTIMA All Right	
F	06	OPTIMA All Right New Body Style	
F	07-11	RONDO All Right	
G52249	W		
F	07-13	ACURA MDX All Left Exc. Active Suspension	
F	10-13	ZDX All Left Exc. Electronic Suspension	
G52250	W		
F	07-13	ACURA MDX All Right Exc. Active Suspension	
F	10-13	ZDX All Right Exc. Electronic Suspension	
G52253	W		
F	08-10	HONDA ODYSSEY All Left	
G52254	W		
F	08-10	HONDA ODYSSEY All Right	
G52255	W		
F	11-13	FORD FIESTA All Left	
G52256	W		
F	11-13	FORD FIESTA All Right	
G52257	W		
F	07-08	HYUNDAI ENTOURAGE All Left	
F	14	KIA SEDONA All Left	
F	06-12	SEDONA All Left	
G52258	W		
F	07-08	HYUNDAI ENTOURAGE All Right	
F	14	KIA SEDONA All Right	

Numerical listing

Shock	POP	Alternative No.	MTG Acc. Supplied
Pos.	Year	Application	
G52258	W (cont)		
F	06-12	SEDONA All Right	
G52260	W		
F	07-15	MAZDA CX-9 All Left	
G52261	W		
F	07-15	MAZDA CX-9 All Right	
G52264	W		
F	08-15	SCION XB All Left	
G52265	W		
F	08-15	SCION XB All Right	
G52274	W		
F	07-13	VOLVO C30 All Left	
F	06-13	C70 All Left	
F	05-12	S40 All Left	
F	04	S40 T5 Left	
F	05-11	V50 All Left	
G52275	W		
F	07-13	VOLVO C30 All Right	
F	06-13	C70 All Right	
F	05-12	S40 All Right	
F	04	S40 T5 Right Mfg. to 4/00	
F	05-11	V50 All Right	
G52276	W		
F	02-08	JAGUAR X-TYPE All Exc. CATS Computer Active Technology Suspension	
G52278	W		
F	10	BUICK ALLURE FWD Left Exc. Electronic Suspension	
F	10-16	LACROSSE FWD Left Exc. Electronic Suspension	
G52279	W		
F	10	BUICK ALLURE FWD Right Exc. Electronic Suspension	
F	10-16	LACROSSE FWD Right Exc. Electronic Suspension	
G52280	W		
F	10-13	CHEVROLET CAMARO 3.6L 6Cyl V (217) Left	
G52281	W		
F	10-13	CHEVROLET CAMARO 3.6L 6Cyl V (217) Right	
G52282	W		
F	07-08	HONDA FIT CAN Left	
F	07-08	FIT USA Left	
G52283	W		
F	07-08	HONDA FIT CAN Right	
F	07-08	FIT USA Right	
G52293	W		
F	04-11	MITSUBISHI ENDEAVOR All Left	
G52294	W		
F	04-11	MITSUBISHI ENDEAVOR All Right	
G52295	W		
F	03-08	VOLVO XC90 All	
G52297	W		
F	07-13	MINI COOPER All Left	
G52298	W		
F	07-13	MINI COOPER All Right	
G52299	W		
F	09-13	MITSUBISHI OUTLANDER SE Left w/ 3rd Row Seating	
F	09-13	OUTLANDER XLS Left w/ 3rd Row Seating	
F	10-12	OUTLANDER GT Left w/ 3rd Row Seating	
F	08	OUTLANDER XLS Left	
F	07	OUTLANDER All Left	
G52300	W		
F	10-13	MITSUBISHI OUTLANDER GT Right w/ 3rd Row Seating	
F	09-13	OUTLANDER SE Right w/ 3rd Row Seating	
F	09-13	OUTLANDER XLS Right w/ 3rd Row Seating	
F	08	OUTLANDER XLS Right	
F	07	OUTLANDER All Right	

Numerical listing

Shock	POP	Alternative No.	MTG Acc. Supplied
Pos.	Year	Application	
G52301	W		
F	09-11	VOLKSWAGEN TIGUAN All	
G52314	W		
F	04-07	BMW 525i All	
F	08-10	528i All	
F	04-07	530i All	
F	08-10	535i All	
F	04-05	545i All	
F	06-10	550i All	
G52329	W		
F	11	HYUNDAI SONATA 2.0T Left Mfg. to 7/22/10	
F	11	SONATA 2.0T Limited Left Mfg. to 7/22/10	
F	11	SONATA GL Left Mfg. to 7/22/10	
F	11	SONATA GLS Left Mfg. to 7/22/10	
F	11	SONATA Limited Left Mfg. to 7/22/10	
F	11	SONATA SE Left Mfg. to 7/22/10	
G52330	W		
F	11	HYUNDAI SONATA 2.0T Limited Right Mfg. to 7/22/10	
F	11	SONATA 2.0T Right Mfg. to 7/22/10	
F	11	SONATA GL Right Mfg. to 7/22/10	
F	11	SONATA GLS Right Mfg. to 7/22/10	
F	11	SONATA Limited Right Mfg. to 7/22/10	
F	11	SONATA SE Right Mfg. to 7/22/10	
G52331	W		
F	12-15	TOYOTA PRIUS All Left	
F	11	PRIUS All Left Mfg. to 12/11	
F	10	PRIUS All Left	
G52332	W		
F	13-15	TOYOTA PRIUS All Right	
F	11-12	PRIUS All Right Mfg. to 12/11	
F	10	PRIUS All Right	
G52335	W		
R	96-00	HYUNDAI ELANTRA All Left Gas Charged Unit	
G52336	W		
R	96-00	HYUNDAI ELANTRA All Right Gas Charged Unit	
G52348	W		
F	04-10	VOLKSWAGEN TOUAREG All Left Exc. Air Suspension	
G52349	W		
F	04-10	VOLKSWAGEN TOUAREG All Right Exc. Air Suspension	
G52351	W		
F	11-14	FORD EDGE All Left	
F	11-15	LINCOLN MKX All Left	
G52352	W		
F	11-14	FORD EDGE All Right	
F	11-15	LINCOLN MKX All Right	
G52353	W		
F	12-14	DODGE ATTITUDE All Left	
F	12-17	HYUNDAI ACCENT All Left	
F	12-17	KIA RIO All Left	
G52354	W		
F	12-14	DODGE ATTITUDE All Right	
F	12-17	HYUNDAI ACCENT All Right	
F	12-17	KIA RIO All Right	
G52355	W		
F	11-13	NISSAN QUEST All Left	
G52356	W		
F	11-13	NISSAN QUEST All Right	
G52360	W		
F	09-15	HONDA PILOT All Left	
G52361	W		
F	09-15	HONDA PILOT All Right	
G52374	W		
F	09-13	SUBARU FORESTER All Left	
G52375	W		
F	09-13	SUBARU FORESTER All Right	
G52382	W		
F	09-14	NISSAN MAXIMA All Left	

Ultra Struts

Shock	POP	Alternative No.	MTG Acc. Supplied
Pos.	Year	Application	
G52383	W		
F	09-14	NISSAN MAXIMA All Right	
G52395	W		
F	10-15	CHEVROLET CAMARO SS Left	
G52396	W		
F	10-15	CHEVROLET CAMARO SS Right	
G52398	W		
F	10-12	FORD TAURUS All Left w/ Suspension Code A and B	
F	09-12	LINCOLN MKS All Left w/ Suspension Code A and B	
G52399	W		
F	10-12	FORD TAURUS All Right w/ Suspension Code A and B	
F	09-12	LINCOLN MKS All Right w/ Suspension Code A and B	
G52406	W		
F	11-14	FORD MUSTANG / MUSTANG II All	
G52410	W		
F	14-20	NISSAN ROGUE All Left	
F	19-20	X-TRAIL All Left	
G52411	W		
F	14-20	NISSAN ROGUE All Right	
F	19-20	X-TRAIL All Right	
G52437	W		
F	12-17	HYUNDAI AZERA All Left	
F	14-16	KIA CADENZA All Left	
G52438	W		
F	12-17	HYUNDAI AZERA All Right	
F	14-16	KIA CADENZA All Right	
G52439	W		
F	12-13	HYUNDAI ELANTRA All Left	
G52440	W		
F	12-13	HYUNDAI ELANTRA All Right	
G52449	W		
F	10-13	MAZDA 3 Mazdaspeed Left Exc. Turbo	
F	07-09	3 Mazdaspeed Left Exc. Turbo, Exc. Models w/ 17" Wheels	
G52450	W		
F	10-13	MAZDA 3 Mazdaspeed Right Exc. Turbo	
F	07-09	3 Mazdaspeed Right Exc. Turbo, Exc. Models w/ 17" Wheels	
G52494	W		
F	13-22	BUICK ENCORE All Left	
F	13-22	CHEVROLET TRAX All Left	
G52495	W		
F	13-22	BUICK ENCORE All Right	
F	13-22	CHEVROLET TRAX All Right	
G52524	W		
F	15-18	NISSAN MURANO All Left	
F	13-20	PATHFINDER All Left	
G52525	W		
F	15-18	NISSAN MURANO All Right	
F	13-20	PATHFINDER All Right	
G52906	W		
F	14-17	NISSAN QUEST All Left	
G52907	W		
F	14-17	NISSAN QUEST All Right	
G55551	W	141306	
F	84-93	FORD MUSTANG / MUSTANG II GT, 5.0L 8Cyl V (302), 4.00 101.6(Bore)3.00 76.2(Stroke) 3/4" Clevis Opening	
G55591	W	142024	
F	89-92	GEO PRIZM All	
F	88-92	TOYOTA COROLLA FWD	
G55661	W		
R	98-02	CHEVROLET PRIZM All Left	
R	93-97	GEO PRIZM All Left	
R	93-02	TOYOTA COROLLA All Left	
G55662	W		
R	98-02	CHEVROLET PRIZM All Right	
R	93-97	GEO PRIZM All Right	

Numerical listing

Shock	POP	Alternative No.	MTG Acc. Supplied
Pos.	Year	Application	
G55662	W (cont)		
R	93-02	TOYOTA COROLLA All Right	
G55675	W		
R	97-02	LEXUS ES300 All Left Exc. Electronic Adjustable Suspension	
R	95-96	ES300 All Left	
R	92-94	ES300 All Left Sealed OE Struts	
R	95-03	TOYOTA AVALON All Left	
R	95-01	CAMRY All Left	
R	92-94	CAMRY All Left Sealed OE Struts	
R	99-03	SOLARA All Left	
G55676	W		
R	97-02	LEXUS ES300 All Right Exc. Electronic Adjustable Suspension	
R	95-96	ES300 All Right	
R	92-94	ES300 All Right Sealed OE Struts	
R	95-03	TOYOTA AVALON All Right	
R	95-01	CAMRY All Right	
R	92-94	CAMRY All Right Sealed OE Struts	
R	99-03	SOLARA All Right	
G55681	W		
F	03-04	FORD MUSTANG / MUSTANG II Mach 1	
F	94-04	MUSTANG / MUSTANG II Base	
F	94-04	MUSTANG / MUSTANG II GT	
F	04	MUSTANG / MUSTANG II GT Base	
F	04	MUSTANG / MUSTANG II GT Equipado	
F	01	MUSTANG / MUSTANG II GT Bullitt	
F	95	MUSTANG / MUSTANG II GTS	
G55697	W	143004	
F	96-00	CHRYSLER TOWN & COUNTRY All	
F	00	VOYAGER / GRAND VOYAGER All	
F	00	VOYAGER / GRAND VOYAGER Non-ABS	
F	96-00	DODGE CARAVAN / GRAND CARAVAN All Exc. Hydraulic Self-Leveling System	
F	96-00	PLYMOUTH VOYAGER / GRAND VOYAGER All	
G55698	W		
F	95-05	CHEVROLET CAVALIER All	
F	95-05	PONTIAC SUNFIRE All	
G55772	W		
R	98-01	CHEVROLET METRO Non-ABS	
R	89-91	SPRINT All	
R	89-97	GEO METRO Non-ABS	
R	95-99	PONTIAC FIREFLY All	
R	94	FIREFLY CAN	
R	89-91	FIREFLY CAN	
R	89-01	SUZUKI SWIFT All	
G55774	W	141544	
F	90-93	HONDA ACCORD All	
G55804	W	142099	
R	92-94	TOYOTA PASEO All	
R	91-94	TERCEL All	
G55820	W	142094	
F	95-00	CHRYSLER SEBRING Coupe	
F	95-00	DODGE AVENGER All	
F	94-98	MITSUBISHI GALANT All	
G55821	W	142372	
R	95-98	HONDA ODYSSEY All	
R	96-99	ISUZU OASIS All	
G55825	W	142609	
R	95-05	CHEVROLET CAVALIER All	
R	95-05	PONTIAC SUNFIRE All	
G55856	W		
R	99-04	CHRYSLER 300M All	
R	98-04	CONCORDE All	
R	98-04	INTREPID All	
R	99-01	LHS All	
R	98-04	DODGE INTREPID All	
G55892	W		
F	00-02	CHRYSLER NEON All	
F	03-05	DODGE NEON SXT	
F	00-05	NEON SE	
F	01-04	NEON R/T	
F	00-03	NEON LE	
F	01-02	NEON ACR	
F	01-02	NEON Base	
F	00-02	NEON ES	
F	00-02	NEON LX	
F	00	NEON High Line	

Numerical listing

Shock	POP	Alternative No.	MTG Acc. Supplied
Pos.	Year	Application	
G55892	W (cont)		
F	00-01	PLYMOUTH NEON All	
G55896	W		
F	01-10	CHRYSLER PT CRUISER All	
G55901	W		142169
R	94-07	FORD TAURUS Sedan	
R	94-05	MERCURY SABLE Sedan	
G55910	W		141544
R	97-00	ACURA EL All	
R	96-00	HONDA CIVIC All	
G55911	W		142462
F	93-95	DODGE COLT All	
F	93-96	EAGLE SUMMIT Coupe	
F	93-96	SUMMIT Sedan	
F	96	MITSUBISHI MIRAGE All Mfg. to 5/96	
F	93-95	MIRAGE All	
F	93-94	PLYMOUTH COLT Sedan	
G55948	C		142169
F	05-09	BUICK ALLURE All	
F	97-05	CENTURY All	
F	05-09	LACROSSE All	
F	97-04	REGAL All	
F	05-06	TERRAZA AWD	
F	00-13	CHEVROLET IMPALA All	
F	14-16	IMPALA LIMITED All	
F	00-07	MONTE CARLO All	
F	02-05	VENTURE All	
F	97-01	VENTURE FWD	
F	98-02	OLDSMOBILE INTRIGUE All	
F	97-04	SILHOUETTE All	
F	97-03	PONTIAC GRAND PRIX All	
F	99-05	MONTANA Base	
F	97-99	TRANS SPORT All	
G55949	W		142169
R	05-09	BUICK ALLURE All Exc. Models w/ 17" Wheels	
R	97-05	CENTURY All	
R	05-09	LACROSSE All Exc. Models w/ 17" Wheels	
R	97-04	REGAL All	
R	00-13	CHEVROLET IMPALA All Exc. Models w/ 17" Wheels	
R	14-16	IMPALA LIMITED All Exc. Models w/ 17" Wheels	
R	00-07	MONTE CARLO All Exc. Models w/ 17" Wheels	
R	98-02	OLDSMOBILE INTRIGUE All	
R	97-08	PONTIAC GRAND PRIX All Exc. Models w/ 17" Wheels	
G55993	W		
F	98-03	TOYOTA SIENNA All Left	
G55994	W		
F	98-03	TOYOTA SIENNA All Right	
G55999	W		141309
F	98-02	CHEVROLET PRIZM All	
F	93-97	GEO PRIZM All	
F	93-02	TOYOTA COROLLA All	
G56506	W		
F	97-01	LEXUS ES300 All Left Exc. Electronic Adjustable Suspension	
F	97-03	TOYOTA AVALON All Left	
F	97-01	CAMRY All Left	
F	99-03	SOLARA All Left	
G56509	D		141572
F	00-05	BUICK LESABRE All Exc. Electronic Adjustable Suspension	
F	00-05	CADILLAC DEVILLE All Exc. Electronic Adjustable Suspension	
F	98-04	SEVILLE All Exc. Electronic Adjustable Suspension	
F	01-03	OLDSMOBILE AURORA All	
F	98-99	AURORA All	
F	00-05	PONTIAC BONNEVILLE All	
G56514	W		
F	97-01	LEXUS ES300 All Right Exc. Electronic Adjustable Suspension	
F	97-03	TOYOTA AVALON All Right	
F	97-01	CAMRY All Right	
F	99-03	SOLARA All Right	
G56516	W		
F	00-05	FORD FOCUS All Left	

Ultra Struts

Shock	POP	Alternative No.	MTG Acc. Supplied
Pos.	Year	Application	
G56517	W		141682
F	00-05	FORD FOCUS All Right	
G56529	W		141682
F	98-02	MITSUBISHI MIRAGE 1.8L 4Cyl L (112), 3.19 81.0(Bore)3.50 88.8(Stroke) Right w/ 6" or 7" Spring	
F	97	MIRAGE 1.8L 4Cyl L (112), 3.19 81.0(Bore)3.50 88.8(Stroke) Right Mfg. from 4/97; w/ 6" or 7" Spring	
G56530	W		141682
F	98-02	MITSUBISHI MIRAGE 1.8L 4Cyl L (112), 3.19 81.0(Bore)3.50 88.8(Stroke) Left w/ 6" or 7" Spring	
F	97	MIRAGE 1.8L 4Cyl L (112), 3.19 81.0(Bore)3.50 88.8(Stroke) Left Mfg. from 4/97; w/ 6" or 7" Spring	
G56537	W		141682
R	02-03	MAZDA PROT G / PROT G5 All Right	
R	02-03	PROT G / PROT G5 SE Right	
R	01-03	PROT G / PROT G5 DX Right	
R	01-03	PROT G / PROT G5 ES Right	
R	01-03	PROT G / PROT G5 LX Right	
R	99-00	PROT G / PROT G5 All Right	
G56538	W		141682
R	02-03	MAZDA PROT G / PROT G5 All Left	
R	02-03	PROT G / PROT G5 SE Left	
R	01-03	PROT G / PROT G5 DX Left	
R	01-03	PROT G / PROT G5 ES Left	
R	01-03	PROT G / PROT G5 LX Left	
R	99-00	PROT G / PROT G5 All Left	
G56539	W		
F	01-06	HYUNDAI ELANTRA All Left	
F	00	ELANTRA All Left Mfg. from 5/00	
G56540	W		
F	01-06	HYUNDAI ELANTRA All Right	
F	00	ELANTRA All Right Mfg. from 5/00	
G56561	W		141682
F	01-06	HYUNDAI SANTA FE All Right	
G56562	W		141682
F	01-06	HYUNDAI SANTA FE All Left	
G56565	W		141716
F	99-00	HYUNDAI SONATA All	
G56568	W		
F	01-12	FORD ESCAPE All Right	
F	08-11	MAZDA TRIBUTE All Right	
F	01-06	TRIBUTE All Right	
F	05-11	MERCURY MARINER All Right	
G56571	W		
R	94-97	KIA SEPHIA All Right	
G56581	W		141309
F	01-05	TOYOTA RAV4 All Right	
F	00	RAV4 All Right Mfg. from 5/00	
G56582	W		141309
F	01-05	TOYOTA RAV4 All Left	
F	00	RAV4 All Left Mfg. from 5/00	
G56591	W		
F	91-96	INFINITI G20 All	
G56597	W		
R	03-05	MAZDA MIATA Base	
R	03-05	MIATA LS	
R	03	MIATA SE	
R	99-01	MIATA All	
G56598	C		
F	98-05	LEXUS GS300 All	
F	98-00	GS400 All	
F	01-05	GS430 All	
F	02-07	SC430 All	
G56601	W		
F	01-12	FORD ESCAPE All Left	
F	08-11	MAZDA TRIBUTE All Left	
F	01-06	TRIBUTE All Left	
F	05-11	MERCURY MARINER All Left	
G56606	W		
F	98-10	VOLKSWAGEN BEETLE All	
F	99-06	GOLF A4 (MfrBodyCode)	
F	01-05	JETTA Sedan	
F	99-00	JETTA All	

Numerical listing

Shock	POP	Alternative No.	MTG Acc. Supplied
Pos.	Year	Application	
G56615	W		141682
F	99-01	INFINITI QX4 All Left Mfg. from 12/98	
F	99-01	NISSAN PATHFINDER All Left Mfg. from 12/98; w/ OE543034W985	
G56616	W		141682
F	99-01	INFINITI QX4 All Right Mfg. from 12/98	
F	99-01	NISSAN PATHFINDER All Right Mfg. from 12/98; w/ OE543034W985	
G56620	W		143004
F	01-07	CHRYSLER TOWN & COUNTRY All	
F	01-07	VOYAGER / GRAND VOYAGER All	
F	01-07	DODGE CARAVAN / GRAND CARAVAN All	
G56621	W		141682
F	01-03	ACURA EL All Left	
F	03-05	HONDA CIVIC Hybrid Left	
F	02	CIVIC Coupe Left	
F	02	CIVIC Sedan Left	
F	01	CIVIC All Left	
G56622	W		141682
F	01-03	ACURA EL All Right	
F	03-05	HONDA CIVIC Hybrid Right	
F	02	CIVIC Coupe Right	
F	02	CIVIC Sedan Right	
F	01	CIVIC All Right	
G56633	W		141682
F	00-03	MAZDA PROT G / PROT G5 All Right Mfg. from 10/00	
G56634	W		141682
F	00-03	MAZDA PROT G / PROT G5 All Left Mfg. from 10/00	
G56635	W		
F	99-03	MITSUBISHI GALANT All Right	
G56636	W		141682
F	99-03	MITSUBISHI GALANT All Left	
G56637	W		
R	94-97	KIA SEPHIA All Left	
G56640	W		141682
R	01-06	HYUNDAI ELANTRA All Left	
R	00	ELANTRA All Left Mfg. from 5/00	
G56641	W		141682
R	01-06	HYUNDAI ELANTRA All Right	
R	00	ELANTRA All Right Mfg. from 5/00	
G56655	W		142098
F	04-07	FORD FREESTAR All	
F	04-07	MERCURY MONTEREY Mini Passenger Van	
G56660	W		
F	03-08	TOYOTA COROLLA All Right	
G56661	W		141309
F	03-08	TOYOTA COROLLA All Left	
G56671	W		
F	02-06	NISSAN ALTIMA All Left	
F	04-08	MAXIMA All Left	
G56672	W		
F	02-06	NISSAN ALTIMA All Right	
F	04-08	MAXIMA All Right	
G56679	W		
F	01-03	TOYOTA HIGHLANDER All Left	
G56680	W		
F	01-03	TOYOTA HIGHLANDER All Right	
G56687	W		141682
F	02-03	INFINITI QX4 All Left	
F	01-04	NISSAN PATHFINDER All Left w/ OE 543034W925 or 543034W926	
G56688	W		141682
F	02-03	INFINITI QX4 All Right	
F	01-04	NISSAN PATHFINDER All Right w/ OE 543034W925 or 543034W926	
G56700	C		141156
F	82-92	CHEVROLET CAMARO All	
F	82-92	PONTIAC FIREBIRD All	

Numerical listing

Shock	POP	Alternative No.	MTG Acc. Supplied
Pos.	Year	Application	
G56701	W		141313
F	85-90	BUICK ELECTRA All	
F	90	LESABRE All Early Design Front Strut w/ Spring Guard	
F	86-89	LESABRE All	
F	85-90	CADILLAC COMMERCIAL CHASSIS All	
F	85-90	DEVILLE All	
F	85-90	FLEETWOOD All	
F	86-90	OLDSMOBILE 88 SERIES All Early Design Front Strut w/ Spring Guard	
F	85-90	98 All	
F	87-90	PONTIAC BONNEVILLE All Early Design Front Strut w/ Spring Guard	
G56718	W		141683
F	91-99	BUICK LESABRE All	
F	90	LESABRE All Late Design Front Strut without Spring Guard	
F	91-96	PARK AVENUE All	
F	95-96	RIVIERA All	
F	93	CADILLAC 60 SPECIAL All	
F	92-93	COMMERCIAL CHASSIS FWD	
F	91	COMMERCIAL CHASSIS All	
F	91-93	DEVILLE All Exc. Electronic Adjustable Suspension	
F	91-93	FLEETWOOD All	
F	92-99	OLDSMOBILE 88 SERIES All	
F	90-91	88 SERIES All Late Design Front Strut without Spring Guard	
F	91-96	98 All CCR Computer Command Ride	
F	95-96	AURORA All	
F	96-99	LSS All	
F	97-98	REGENCY All	
F	94-99	PONTIAC BONNEVILLE All Exc. CCR Computer Command Ride	
F	91-93	BONNEVILLE All	
F	90	BONNEVILLE All Late Design Front Strut without Spring Guard	
G56721	W		141309
F	04-06	LEXUS ES330 All Left Exc. Adaptive Variable Suspension	
F	04-06	TOYOTA CAMRY All Left	
F	04-08	SOLARA All Left	
G56722	W		141309
F	04-06	LEXUS ES330 All Right Exc. Adaptive Variable Suspension	
F	04-06	TOYOTA CAMRY All Right	
F	04-08	SOLARA All Right	
G56728	W		
R	04-06	LEXUS ES330 All Left Exc. Adaptive Variable Suspension	
R	04-06	TOYOTA CAMRY All Left	
R	04-06	SOLARA All Left	
G56729	W		
R	04-06	LEXUS ES330 All Right Exc. Adaptive Variable Suspension	
R	04-06	TOYOTA CAMRY All Right	
R	04-06	SOLARA All Right	
G56730	W		
F	04-06	LEXUS RX330 All Left Exc. Air Suspension	
F	07-09	RX350 All Left Exc. Air Suspension	
F	04-07	TOYOTA HIGHLANDER All Left	
G56731	W		
F	04-06	LEXUS RX330 All Right Exc. Air Suspension	
F	07-09	RX350 All Right Exc. Air Suspension	
F	04-07	TOYOTA HIGHLANDER All Right	
G56732	W		
R	04-06	LEXUS RX330 AWD Left Exc. Air Suspension	
R	07	RX350 AWD Left Exc. Air Suspension	
R	04-07	TOYOTA HIGHLANDER AWD Left	
G56733	W		
R	04-06	LEXUS RX330 AWD Right Exc. Air Suspension	
R	07	RX350 AWD Right Exc. Air Suspension	
R	04-07	TOYOTA HIGHLANDER AWD Right	
G56734	W		
R	04-06	LEXUS RX330 FWD Left Exc. Air Suspension	

Ultra Struts

Shock	POP	Alternative No.	MTG Acc. Supplied
Pos.	Year	Application	
G56734	W (cont)		
R	07-09	RX350 FWD Left Exc. Air Suspension	
R	04-07	TOYOTA HIGHLANDER FWD Left	
G56735	W		
R	04-06	LEXUS RX330 FWD Right Exc. Air Suspension	
R	07-09	RX350 FWD Right Exc. Air Suspension	
R	04-07	TOYOTA HIGHLANDER FWD Right	
G56758	W		
F	01-02	ACURA MDX All Right	
F	03-08	HONDA PILOT All Right	
G56759	W		
F	01-02	ACURA MDX All Left	
F	03-08	HONDA PILOT All Left	
G56773	W		141309
F	05-06	CHEVROLET EQUINOX All Left	
F	06	PONTIAC TORRENT All Left	
G56774	W		
F	05-06	CHEVROLET EQUINOX All Right	
F	06	PONTIAC TORRENT All Right	
G56778	W		143172
F	03-06	DODGE SPRINTER 2500 All	
F	03-06	SPRINTER 3500 All	
F	02-06	FREIGHTLINER SPRINTER 2500 All	
F	04-06	MERCEDES-BENZ SPRINTER All	
G56791	W		
F	06-07	MERCEDES-BENZ C230 All Exc. Sport Suspension	
F	03-05	C230 Coupe Exc. Sport Suspension	
F	02	C230 Coupe, RWD Exc. Sport Suspension	
F	01-05	C240 RWD Exc. Sport Suspension	
F	06-07	C280 RWD Exc. Sport Suspension	
F	01-05	C320 Sedan, RWD Exc. Sport Suspension	
F	02-04	C320 Wagon, RWD Exc. Sport Suspension	
F	06-07	C350 RWD Exc. Sport Suspension	
F	02-05	CLK320 RWD Exc. Sport Suspension	
F	06-09	CLK350 RWD Exc. Sport Suspension	
F	02-03	CLK430 RWD Exc. Sport Suspension	
F	03-06	CLK500 RWD Exc. Sport Suspension	
F	07-09	CLK550 Coupe, RWD Exc. Sport Suspension	
G56792	W		
F	06-07	MERCEDES-BENZ C230 RWD Sport Suspension	
F	02-05	C230 Coupe Sport Suspension	
F	01-05	C240 RWD Sport Suspension	
F	06-07	C280 RWD Sport Suspension	
F	01-05	C320 RWD Sport Suspension	
F	06-07	C350 RWD Sport Suspension	
F	02-05	CLK320 RWD Sport Suspension	
F	06-09	CLK350 RWD Sport Suspension	
F	02-03	CLK430 RWD Sport Suspension	
F	03-06	CLK500 RWD Sport Suspension	
G56797	W		141118
F	05-06	TOYOTA SIENNA FWD Right Mfg to 6/05 w/ 7 Passenger Seating	
F	04	SIENNA FWD Right w/ 7 Passenger Seating	
G56798	W		141118
F	05-06	TOYOTA SIENNA FWD Left Mfg to 6/05 w/ 7 Passenger Seating	
F	04	SIENNA FWD Left w/ 7 Passenger Seating	
G56799	W		141198
F	02-06	HONDA CR-V All Right	
G56800	W		141198
F	02-06	HONDA CR-V All Left	
G56802	W		142098
F	01-09	VOLVO S60 All	
F	99-06	S80 All	
F	05-06	V70 R Mfg. from 3/00 and Exc. XC70, XC Cross Country and Auto-Leveling	

Numerical listing

Shock	POP	Alternative No.	MTG Acc. Supplied
Pos.	Year	Application	
G56802	W (cont)		142098
F	04-06	V70 2.4 Mfg. from 3/00 and Exc. XC70, XC Cross Country and Auto-Leveling	
F	04-06	V70 2.5T Mfg. from 3/00 and Exc. XC70, XC Cross Country and Auto-Leveling	
F	00-05	V70 T5 Mfg. from 3/00 and Exc. XC70, XC Cross Country and Auto-Leveling	
F	04	V70 2.5T AWD Mfg. from 3/00 and Exc. XC70, XC Cross Country and Auto-Leveling	
F	00-03	V70 2.4T Mfg. from 3/00 and Exc. XC70, XC Cross Country and Auto-Leveling	
F	00-03	V70 Base Mfg. from 3/00 and Exc. XC70, XC Cross Country and Auto-Leveling	
F	00	V70 2.4T SE Mfg. from 3/00 and Exc. XC70, XC Cross Country and Auto-Leveling	
F	00	V70 GLT Mfg. from 3/00 and Exc. XC70, XC Cross Country and Auto-Leveling	
F	00	V70 GLT SE Mfg. from 3/00 and Exc. XC70, XC Cross Country and Auto-Leveling	
G56807	A		141727
F	06-10	JEEP COMMANDER All	
F	05-10	GRAND CHEROKEE All	
G56809	W		141156
F	03-07	SATURN ION All	
G56810	W		
F	05-10	CHEVROLET COBALT LS	
F	05-10	COBALT LT	
F	10	COBALT Base	
F	10	COBALT LT Team Canada	
F	06-07	COBALT LTZ	
F	05	COBALT Base	
F	11	HHR All	
F	08-10	HHR LS Panel	
F	08-10	HHR LT Panel	
F	06-10	HHR LS	
F	06-10	HHR LT	
F	06-08	HHR Comfort LT	
F	06-08	HHR Elegance LT	
F	07	HHR Edicion Especial	
F	07-09	PONTIAC G5 All	
F	05-06	PURSUIT All	
G56817	W		142169
F	05-10	FORD MUSTANG / MUSTANG II All	
G56819	W		
F	05-09	HYUNDAI TUCSON All Left	
F	05-10	KIA SPORTAGE All Left	
G56820	W		
F	05-09	HYUNDAI TUCSON All Right	
F	05-10	KIA SPORTAGE All Right	
G56821	W		
R	05-09	HYUNDAI TUCSON All Right	
R	05-10	KIA SPORTAGE All Right	
G56822	W		
R	05-09	HYUNDAI TUCSON All Left	
R	05-10	KIA SPORTAGE All Left	
G56836	W		142081
F	06-11	FORD FOCUS All Left	
G56837	W		142081
F	06-11	FORD FOCUS All Right	
G56838	W		141727
F	06-10	FORD EXPLORER All	
F	06-10	MERCURY MOUNTAINEER All	
G56839	W		141727
R	06-10	FORD EXPLORER All	
R	06-10	MERCURY MOUNTAINEER All	
G56840	W		142169
F	07-10	FORD EDGE All Left	
F	07-10	LINCOLN MKX All Left	
G56841	W		142169
F	07-10	FORD EDGE All Right	
F	07-10	LINCOLN MKX All Right	
G56842	W		
F	07-11	TOYOTA YARIS All Left	

Numerical listing

Shock	POP	Alternative No.	MTG Acc. Supplied
Pos.	Year	Application	
G56843	W		
F	07-11	TOYOTA YARIS All Right	
G56886	W		
F	09-11	CHEVROLET AVEO All Left	
F	04-11	AVEO All Left	
F	07-10	PONTIAC G3 All Left	
F	05-08	WAVE All Left	
F	04-09	SUZUKI SWIFT All Left	
G56887	W		
F	09-11	CHEVROLET AVEO All Right	
F	04-11	AVEO All Right	
F	07-10	PONTIAC G3 All Right	
F	05-08	WAVE All Right	
F	04-09	SUZUKI SWIFT All Right	
G56892	W		
F	02-03	KIA SPECTRA All Left	
G56893	W		
F	02-03	KIA SPECTRA All Right	
G56894	W		
F	02-07	MINI COOPER S All	
F	07	LANCER LS Diamond	
F	04-06	LANCER Ralliart	
F	02-06	LANCER OZ Rally	
F	06	LANCER DE	
F	06	LANCER SE	
F	04	LANCER DE	
F	04	LANCER Sportback	
G56899	W		
F	06-09	VOLKSWAGEN BORA All	
F	09-17	CC All	
F	07-14	EOS All	
F	12-14	GOLF Comfortline TDI	
F	12-14	GOLF Highline TDI	
F	11-14	GOLF Base	
F	11-14	GOLF Comfortline	
F	11-14	GOLF TDI	
F	11-14	GOLF Trendline	
F	14	GOLF Trendline TDI	
F	11-13	GOLF Sportline	
F	13	GOLF GTI	
F	11-12	GOLF Highline	
F	11	GOLF TDI Comfortline	
F	06-14	GTI All	
F	12-14	JETTA Wagon	
F	06-11	JETTA All	
F	06-10	PASSAT All	
F	06-09	RABBIT All	
G511003	W		
R	13-14	HONDA ACCORD Coupe	
G511054	W		
F	07-09	KIA SORENTO All Left Exc. HPD (High Performance Dampers)	
G511055	W		
F	07-09	KIA SORENTO All Right Exc. HPD (High Performance Dampers)	
Guardian Struts			
M55693	W		141682
R	95-00	FORD CONTOUR All	
R	99-02	MERCURY COUGAR All	
R	95-00	MYSTIQUE All	
M55697	W		143004
F	96-00	CHRYSLER TOWN & COUNTRY All	
F	00	VOYAGER / GRAND VOYAGER All	
F	00	VOYAGER / GRAND VOYAGER Non-ABS	
F	96-00	DODGE CARAVAN / GRAND CARAVAN All Exc. Hydraulic Self-Leveling System	
F	96-00	PLYMOUTH VOYAGER / GRAND VOYAGER All	
M55786	W		141544
R	97-99	ACURA CL All	
R	90-97	HONDA ACCORD All	
M55802	W		141544
F	97-01	ACURA INTEGRA GS	
F	94-01	INTEGRA GS-R	
F	94-01	INTEGRA LS	
F	95-96	INTEGRA Special Edition	
F	92-95	HONDA CIVIC All	
F	93-97	CIVIC DEL SOL All	

Ultra Struts, Guardian Struts, Ultra ReadyMount

Shock	POP	Alternative No.	MTG Acc. Supplied
Pos.	Year	Application	
M55848	W		
R	91-03	FORD ESCORT All	
R	90-94	MAZDA 323 All	
R	90-94	PROTG / PROTG5 FWD, Non-ABS	
R	91-99	MERCURY TRACER FWD	
M55871	W		141544
R	01-03	ACURA CL All	
R	99-03	TL All	
R	98-02	HONDA ACCORD All	
M55877	W		141544
F	97-99	ACURA CL All	
F	94-97	HONDA ACCORD All	
F	95-98	ODYSSEY All	
F	96-99	ISUZU OASIS All	
M55892	W		
F	00-02	CHRYSLER NEON All	
F	03-05	DODGE NEON SXT	
F	00-05	NEON SE	
F	01-04	NEON R/T	
F	00-03	NEON LE	
F	01-02	NEON ACR	
F	01-02	NEON Base	
F	00-02	NEON ES	
F	00-02	NEON LX	
F	00	NEON High Line	
F	00-01	PLYMOUTH NEON All	
M55896	W		
F	01-10	CHRYSLER PT CRUISER All	
M55901	W		142169
R	94-07	FORD TAURUS Sedan	
R	94-05	MERCURY SABLE Sedan	
M55912	W		142081
F	96-99	INFINITI I30 All Right	
F	95-99	NISSAN MAXIMA All Right	
M55913	W		142081
F	96-99	INFINITI I30 All Left	
F	95-99	NISSAN MAXIMA All Left	
M55920	W		142081
F	93-98	MERCURY VILLAGER All Left	
F	93-98	NISSAN QUEST All Left	
M55921	W		142081
F	93-98	MERCURY VILLAGER All Right	
F	93-98	NISSAN QUEST All Right	
M55974	W		142169
F	04-05	CHEVROLET CLASSIC All	
F	97-03	MALIBU All	
F	99-04	OLDSMOBILE ALERO All	
F	99	CUTLASS / CUTLASS SUPREME All	
F	98	CUTLASS / CUTLASS SUPREME All Rear Strut Lower Mounting holes at 2.4" Apart	
F	97	CUTLASS / CUTLASS SUPREME All	
F	99-05	PONTIAC GRAND AM All	
M56501	W		142169
R	04-05	CHEVROLET CLASSIC All	
R	98-03	MALIBU All Rear Strut Lower Mounting holes at 2.4" Apart	
R	99-04	OLDSMOBILE ALERO All	
R	99	CUTLASS / CUTLASS SUPREME All	
R	98	CUTLASS / CUTLASS SUPREME All Second Design with Rear Strut Lower Mounting holes at 2.4" apart	
R	99-05	PONTIAC GRAND AM All	
M56502	W		
F	95-96	LEXUS ES300 All	
F	95-96	TOYOTA AVALON All	
F	95-96	CAMRY All	
M56622	W		
F	01-03	ACURA EL All Right	
F	03-05	HONDA CIVIC Hybrid Right	
F	02	CIVIC Coupe Right	
F	02	CIVIC Sedan Right	
F	01	CIVIC All Right	
M56708	W		
R	88-96	BUICK REGAL All	
R	90-94	CHEVROLET LUMINA All	
R	97	OLDSMOBILE CUTLASS / CUTLASS SUPREME All Exc. Rear Strut Lower Mounting holes at 3.2" apart	

Numerical listing

Shock	POP	Alternative No.	MTG Acc. Supplied
Pos.	Year	Application	
M56708	W (cont)		
R	88-96	CUTLASS / CUTLASS SUPREME All	
R	88-96	PONTIAC GRAND PRIX All	
M56718	W		
F	91-99	BUICK LESABRE All	
F	90	LESABRE All Late Design Front Strut without Spring Guard	
F	91-96	PARK AVENUE All	
F	95-96	RIVIERA All	
F	93	CADILLAC 60 SPECIAL All	
F	91-93	COMMERCIAL CHASSIS FWD	
F	91-93	DEVILLE All Exc. Electronic Adjustable Suspension	
F	91-93	FLEETWOOD All	
F	92-99	OLDSMOBILE 88 SERIES All	
F	90-91	88 SERIES All Late Design Front Strut without Spring Guard	
F	91-96	98 All CCR Computer Command Ride	
F	95-96	AURORA All	
F	96-99	LSS All	
F	97-98	REGENCY All	
F	94-99	PONTIAC BONNEVILLE All Exc. CCR Computer Command Ride	
F	91-93	BONNEVILLE All	
F	90	BONNEVILLE All Late Design Front Strut without Spring Guard	
Ultra ReadyMount			
G56726	W		
R	85-90	BUICK ELECTRA Air (RearSpringType) Conventional Replacement for Air Assist Rear Susp. Strut w/Upper Mount	
R	86-99	LESABRE Coil (RearSpringType)	
R	91-96	PARK AVENUE Air (RearSpringType) Conventional Replacement for Air Assist Susp; Exc. Elec. Adj. Susp.	
R	93	CADILLAC 60 SPECIAL Coil (RearSpringType) Conventional Type Replacement for Air Assist Rear Suspension	
R	85-93	DEVILLE Air (RearSpringType) Conventional Type Replacement for Air Assist Rear Suspension	
R	85-93	FLEETWOOD All Conventional Type Replacement for Air Assist Rear Suspension	
R	92-99	OLDSMOBILE 88 SERIES Coil (RearSpringType) Exc. Electronic Adjustable Suspension	
R	86-91	88 SERIES Coil (RearSpringType)	
R	85-96	98 Air (RearSpringType) Conventional Type Replacement	
R	96-99	LSS Coil (RearSpringType) Conventional Type Replacement for Air Assist Rear Suspension	
R	97-98	REGENCY Coil (RearSpringType)	
R	91-99	PONTIAC BONNEVILLE Coil (RearSpringType) Exc. Electronic Adjustable Suspension	
R	87-90	BONNEVILLE Coil (RearSpringType)	
G56924	B		
R	05-09	BUICK ALLURE All Left Models w/ 16" Wheels	
R	97-05	CENTURY All Left	
R	05-09	LACROSSE All Left Models w/ 16" Wheels	
R	97-04	REGAL All Left	
R	00-13	CHEVROLET IMPALA All Left Models w/ 16" Wheels	
R	00-07	MONTE CARLO All Left Models w/ 16" Wheels	
R	98-02	OLDSMOBILE INTRIGUE All Left	
R	97-08	PONTIAC GRAND PRIX All Left Models w/ 16" Wheels	
G56925	B		
R	05-09	BUICK ALLURE All Right Models w/ 16" Wheels	
R	97-05	CENTURY All Right	
R	05-09	LACROSSE All Right Models w/ 16" Wheels	
R	97-04	REGAL All Right	
R	00-13	CHEVROLET IMPALA All Right Models w/ 16" Wheels	
R	00-07	MONTE CARLO All Right Models w/ 16" Wheels	
R	98-02	OLDSMOBILE INTRIGUE All Right	

Numerical listing

Shock	POP	Alternative No.	MTG Acc. Supplied
Pos.	Year	Application	
G56925	B (cont)		
R	97-08	PONTIAC	GRAND PRIX All Right Models w/ 16" Wheels
G56927	W		
F	04-05	CHEVROLET	CLASSIC All
F	97-03	MALIBU	All
F	99-04	OLDSMOBILE	ALERO All
F	97-99	CUTLASS / CUTLASS SUPREME	All
F	99-05	PONTIAC	GRAND AM All
G56928	W		
R	04-05	CHEVROLET	CLASSIC All
R	98-03	MALIBU	All Rear Strut Lower Mounting holes at 2.4" Apart
R	99-04	OLDSMOBILE	ALERO All
R	99-05	PONTIAC	GRAND AM All
G56929	W		
F	98-05	BUICK	PARK AVENUE All
F	98-99	RIVIERA	All
G56930	W		
F	97-01	LEXUS	ES300 All Left Exc. Electronic Adjustable Suspension
F	97-03	TOYOTA	AVALON All Left
F	97-01	CAMRY	All Left
F	99-03	SOLARA	All Left
G56931	W		
F	97-01	LEXUS	ES300 All Right Exc. Electronic Adjustable Suspension
F	97-03	TOYOTA	AVALON All Right
F	97-01	CAMRY	All Right
F	99-03	SOLARA	All Right
G56932	B		
R	92-01	LEXUS	ES300 All Left Exc. Electronic Adjustable Suspension
R	95-03	TOYOTA	AVALON All Left
R	95-01	CAMRY	All Left
R	92-94	CAMRY	All Left Sealed OE Struts
R	99-03	SOLARA	All Left
G56933	B		
R	92-01	LEXUS	ES300 All Right Exc. Electronic Adjustable Suspension
R	95-03	TOYOTA	AVALON All Right
R	95-01	CAMRY	All Right
R	92-94	CAMRY	All Right Sealed OE Struts
R	99-03	SOLARA	All Right
G56934	W		
F	96-07	FORD	TAURUS All Left
F	96-05	MERCURY	SABLE All Left
G56935	W		
F	95-03	FORD	WINDSTAR All
G56936	W		
R	94-07	FORD	TAURUS Sedan
R	94-05	MERCURY	SABLE Sedan
G56937	W		
F	96-07	FORD	TAURUS All Right
F	96-05	MERCURY	SABLE All Right
G56938	W		
R	95-05	CHEVROLET	CAVALIER All
R	95-05	PONTIAC	SUNFIRE All
G56943	C		
R	01-03	ACURA	CL All
R	99-03	TL	Base
R	98-02	HONDA	ACCORD All
G56948	W		
F	98-02	CHEVROLET	PRIZM All
F	98-02	TOYOTA	COROLLA All
G56949	W		
R	98-02	CHEVROLET	PRIZM All Left
R	93-97	GEO	PRIZM All Left
R	93-02	TOYOTA	COROLLA All Left
G56950	W		
R	98-02	CHEVROLET	PRIZM All Right
R	93-97	GEO	PRIZM All Right
R	93-02	TOYOTA	COROLLA All Right
G56951	W		143035
F	99-05	CHEVROLET	CAVALIER All
F	99-05	PONTIAC	SUNFIRE All
G56956	W		
F	01-07	CHRYSLER	TOWN & COUNTRY All Left

Ultra ReadyMount

Shock	POP	Alternative No.	MTG Acc. Supplied
Pos.	Year	Application	
G56956	W (cont)		
F	01-07	VOYAGER / GRAND VOYAGER	All Left
F	01-07	DODGE CARAVAN / GRAND CARAVAN	All Left
G56957	W		
F	01-07	CHRYSLER TOWN & COUNTRY	All Right
F	01-07	VOYAGER / GRAND VOYAGER	All Right
F	01-07	DODGE CARAVAN / GRAND CARAVAN	All Right
G56962	W		
F	99-04	CHRYSLER	300M All Left
F	98-04	CONCORDE	All Left
F	98-04	INTREPID	All Left
F	99-01	LHS	All Left
F	98-04	DODGE	INTREPID All Left
G56963	W		
F	99-04	CHRYSLER	300M All Right
F	98-04	CONCORDE	All Right
F	98-04	INTREPID	All Right
F	99-01	LHS	All Right
F	98-04	DODGE	INTREPID All Right
G56964	W		
R	99-04	CHRYSLER	300M All
R	98-04	CONCORDE	All
R	99-01	LHS	All
R	98-04	DODGE	INTREPID All
G56965	W		
F	01-10	CHRYSLER	PT CRUISER All
G56973	W		
R	00-02	CHRYSLER	NEON All Left
R	03-05	DODGE	NEON SXT Left
R	00-05	NEON	SE Left
R	01-04	NEON	R/T Left
R	00-03	NEON	LE Left
R	01-02	NEON	ACR Left
R	01-02	NEON	Base Left
R	00-02	NEON	ES Left
R	00-02	NEON	LX Left
R	00	NEON	High Line Left
R	00-01	PLYMOUTH	NEON All Left
G56974	W		
R	00-02	CHRYSLER	NEON All Right
R	03-05	DODGE	NEON SXT Right
R	00-05	NEON	SE Right
R	01-04	NEON	R/T Right
R	00-03	NEON	LE Right
R	01-02	NEON	ACR Right
R	01-02	NEON	Base Right
R	00-02	NEON	ES Right
R	00-02	NEON	LX Right
R	00	NEON	High Line Right
R	00-01	PLYMOUTH	NEON All Right
G56975	W		
F	00-02	CHRYSLER	NEON All
F	03-05	DODGE	NEON SXT
F	00-05	NEON	SE
F	01-04	NEON	R/T
F	00-03	NEON	LE
F	01-02	NEON	ACR
F	01-02	NEON	Base
F	00-02	NEON	ES
F	00-02	NEON	LX
F	00	NEON	High Line
F	00-01	PLYMOUTH	NEON All
G56991	W		
F	01-03	ACURA	CL All Left
F	99-03	TL	All Left
F	98-02	HONDA	ACCORD 2.3L 4Cyl L (2254), 3.39 86.0(Bore)3.82 97.0(Stroke) Left
G56992	W		
F	01-03	ACURA	CL All Right
F	99-03	TL	All Right
F	98-02	HONDA	ACCORD 2.3L 4Cyl L (2254), 3.39 86.0(Bore)3.82 97.0(Stroke) Right
G56993	W		
F	97-01	ACURA	INTEGRA GS Left
F	94-01	INTEGRA	GS-R Left
F	94-01	INTEGRA	LS Left
F	94-98	INTEGRA	RS Left
F	95-96	INTEGRA	Special Edition Left
F	92-95	HONDA	CIVIC All Left

Numerical listing

Shock	POP	Alternative No.	MTG Acc. Supplied
Pos.	Year	Application	
G56994	W		
F	97-01	ACURA	INTEGRA GS Right
F	94-01	INTEGRA	GS-R Right
F	94-01	INTEGRA	LS Right
F	94-98	INTEGRA	RS Right
F	95-96	INTEGRA	Special Edition Right
F	92-95	HONDA	CIVIC All Right
G56995	C		
R	97-01	ACURA	INTEGRA GS
R	94-01	INTEGRA	GS-R
R	94-01	INTEGRA	LS
R	94-98	INTEGRA	RS
R	95-96	INTEGRA	Special Edition
R	92-95	HONDA	CIVIC All
G56996	W		
F	97-00	ACURA	EL All Left
F	96-00	HONDA	CIVIC All Left
G56997	W		
F	97-00	ACURA	EL All Right
F	96-00	HONDA	CIVIC All Right
G56998	W		
R	97-00	ACURA	EL All
R	96-00	HONDA	CIVIC All
G57000	A		
F	07-18	CHEVROLET	PICKUP 1/2 TON, SILVERADO 1500 4WD
F	19	SILVERADO	1500 LD 4WD
F	07-18	GMC	SIERRA 1500 4WD
G57005	D		
F	85-96	VOLKSWAGEN	GOLF All
F	85-96	JETTA	All
G57006	W		
F	97-98	VOLKSWAGEN	GOLF 2.0L 4Cyl L (121), 3.25 82.5(Bore)3.65 92.8(Stroke)
F	97-98	JETTA	2.0L 4Cyl L (121), 3.25 82.5(Bore)3.65 92.8(Stroke)
G57007	D		
F	07-11	DODGE	NITRO All Left
F	07-12	JEEP	LIBERTY All Left
F	05-06	LIBERTY	GAS Left
F	02-04	LIBERTY	All Left
G57008	D		
F	07-11	DODGE	NITRO All Right
F	07-12	JEEP	LIBERTY All Right
F	05-06	LIBERTY	GAS Right
F	02-04	LIBERTY	All Right
G57010	C		
F	98-04	TOYOTA	TACOMA Pre Runner, RWD
F	95-04	TACOMA	4WD
G57011	W		
F	99-04	HONDA	ODYSSEY All Left
G57012	W		
F	99-04	HONDA	ODYSSEY All Right
G57013	W		
F	91-02	SATURN	SC / SL / SW SERIES All
G57014	W		
R	91-02	SATURN	SC / SL / SW SERIES All
G57015	W		
F	03-06	FORD	EXPEDITION 4WD
F	03-06	LINCOLN	NAVIGATOR All
G57016	W		
R	03-06	FORD	EXPEDITION All
R	03-06	LINCOLN	NAVIGATOR All
G57017	W		
F	02-03	FORD	EXPLORER Eddie Bauer
F	02-03	EXPLORER	Limited
F	02-03	EXPLORER	Postal
F	02-03	EXPLORER	XLS
F	02-03	EXPLORER	XLT
F	02-03	MERCURY	MOUNTAINEER All
G57018	W		
R	02-05	FORD	EXPLORER Eddie Bauer
R	02-05	EXPLORER	Limited
R	02-05	EXPLORER	XLS
R	02-05	EXPLORER	XLT
R	04	EXPLORER	NBX
R	02-03	EXPLORER	Postal
R	02-05	MERCURY	MOUNTAINEER All

Numerical listing

Shock	POP	Alternative No.	MTG Acc. Supplied
Pos.	Year	Application	
G57060 A (cont)			
F	98-02	OLDSMOBILE	INTRIGUE All
F	97-04	SILHOUETTE	All
F	97-03	PONTIAC	GRAND PRIX All
F	99-05	MONTANA	Base
F	97-99	TRANS SPORT	All
G57061 D			
R	03-05	HONDA	CIVIC All Left
G57062 D			
R	03-05	HONDA	CIVIC All Right
G57063 W			
F	00-05	FORD	FOCUS All Left
G57064 W			
F	00-05	FORD	FOCUS All Right
G57065 A			
F	96-02	TOYOTA	4RUNNER All Left
G57066 A			
F	96-02	TOYOTA	4RUNNER All Right
G57067 C			
R	03-08	PONTIAC	VIBE FWD Left
R	03-08	TOYOTA	COROLLA All Left
R	03-08	MATRIX	FWD Left
G57068 C			
R	03-08	PONTIAC	VIBE FWD Right
R	03-08	TOYOTA	COROLLA All Right
R	03-08	MATRIX	FWD Right
G57069 A			
F	11-12	CHEVROLET	MALIBU All Left
F	08-10	MALIBU LS, 3.5L 6Cyl V (213), 3.90 99.0(Bore)2.99 76.0(Stroke) Left	
F	08-10	MALIBU LTZ, 3.6L 6Cyl V (217), 3.70 94.0(Bore)3.37 85.6(Stroke) Left	
F	10	MALIBU LT, 3.6L 6Cyl V (217), 3.70 94.0(Bore)3.37 85.6(Stroke) Left	
F	09	MALIBU LT, 3.5L 6Cyl V (213), 3.90 99.0(Bore)2.99 76.0(Stroke) Left	
F	08	MALIBU Classic LS, 3.5L 6Cyl V (213), 3.90 99.0(Bore)2.99 76.0(Stroke) Left	
F	08	MALIBU Classic LT, 3.5L 6Cyl V (213), 3.90 99.0(Bore)2.99 76.0(Stroke) Left	
F	08	MALIBU LT, 3.5L 6Cyl V (213), 3.70 94.0(Bore)3.31 84.0(Stroke) Left	
F	06-07	MALIBU LTZ Left	
F	06-07	MALIBU SS Left	
F	04-07	MALIBU Base Left	
F	04-07	MALIBU LS Left	
F	04-07	MALIBU LT Left	
F	04-07	MALIBU Maxx LS Left	
F	04-07	MALIBU Maxx LT Left	
F	04	MALIBU Maxx Left	
F	07-10	PONTIAC	G6 Sedan, 3.5L 6Cyl V (213), 3.90 99.0(Bore)2.99 76.0(Stroke) Left
F	07-09	G6 Coupe, 3.5L 6Cyl V (213), 3.90 99.0(Bore)2.99 76.0(Stroke) Left	
F	06-09	G6 Coupe, 3.9L 6Cyl V (237), 3.90 99.0(Bore)3.31 84.0(Stroke) Left	
F	05-09	G6 Sedan, 3.5L 6Cyl V (213), 3.70 94.0(Bore)3.31 84.0(Stroke) Left	
F	07-08	SATURN	AURA XE, 3.5L 6Cyl V (213), 3.90 99.0(Bore)2.99 76.0(Stroke) Left
G57070 A			
F	11-12	CHEVROLET	MALIBU All Right
F	08-10	MALIBU LS, 3.5L 6Cyl V (213), 3.90 99.0(Bore)2.99 76.0(Stroke) Right	
F	08-10	MALIBU LTZ, 3.6L 6Cyl V (217), 3.70 94.0(Bore)3.37 85.6(Stroke) Right	
F	10	MALIBU LT, 3.6L 6Cyl V (217), 3.70 94.0(Bore)3.37 85.6(Stroke) Right	
F	09	MALIBU LT, 3.5L 6Cyl V (213), 3.90 99.0(Bore)2.99 76.0(Stroke) Right	
F	08	MALIBU Classic LS, 3.5L 6Cyl V (213), 3.90 99.0(Bore)2.99 76.0(Stroke) Right	
F	08	MALIBU Classic LT, 3.5L 6Cyl V (213), 3.90 99.0(Bore)2.99 76.0(Stroke) Right	
F	08	MALIBU LT, 3.5L 6Cyl V (213), 3.70 94.0(Bore)3.31 84.0(Stroke) Right	
F	06-07	MALIBU LTZ Right	
F	06-07	MALIBU Maxx LTZ Right	

Ultra ReadyMount

Shock	POP	Alternative No.	MTG Acc. Supplied
Pos.	Year	Application	
G57070 A (cont)			
F	06-07	MALIBU	SS Right
F	04-07	MALIBU	Base Right
F	04-07	MALIBU	LS Right
F	04-07	MALIBU	LT Right
F	04-07	MALIBU	Maxx LS Right
F	04-07	MALIBU	Maxx LT Right
F	04	MALIBU	Maxx Right
F	07-10	PONTIAC	G6 Sedan, 3.5L 6Cyl V (213), 3.90 99.0(Bore)2.99 76.0(Stroke) Right
F	07-09	G6 Coupe, 3.5L 6Cyl V (213), 3.90 99.0(Bore)2.99 76.0(Stroke) Right	
F	06-09	G6 Coupe, 3.9L 6Cyl V (237), 3.90 99.0(Bore)3.31 84.0(Stroke) Right	
F	05-09	G6 Sedan, 3.5L 6Cyl V (213), 3.70 94.0(Bore)3.31 84.0(Stroke) Right	
F	07-08	SATURN	AURA XE, 3.5L 6Cyl V (213), 3.90 99.0(Bore)2.99 76.0(Stroke) Right
G57071 B			
F	05-10	CHRYSLER	300 RWD, 5.7L 8Cyl V (345), 3.92 99.57(Bore)3.58 90.93(Stroke) Left
F	06-10	DODGE	CHARGER RWD, 5.7L 8Cyl V (345), 3.92 99.57(Bore)3.58 90.93(Stroke) Left
F	05-08	MAGNUM RWD, 5.7L 8Cyl V (345), 3.92 99.57(Bore)3.58 90.93(Stroke) Left	
G57072 B			
F	05-10	CHRYSLER	300 RWD, 5.7L 8Cyl V (345), 3.92 99.57(Bore)3.58 90.93(Stroke) Right
F	06-10	DODGE	CHARGER RWD, 5.7L 8Cyl V (345), 3.92 99.57(Bore)3.58 90.93(Stroke) Right
F	05-08	MAGNUM RWD, 5.7L 8Cyl V (345), 3.92 99.57(Bore)3.58 90.93(Stroke) Right	
G57075 W			
R	01-05	CHRYSLER	SEBRING ST (MfrBodyCode), Coupe
R	99-00	SEBRING	Coupe
R	01-05	DODGE	STRATUS Coupe
R	99-03	MIITSUBISHI	GALANT GTZ
G57076 C			
F	04-06	LEXUS	ES330 All Left
F	04-06	TOYOTA	CAMRY 2.4L 4Cyl L (2362), 3.48 88.5(Bore)3.78 96.0(Stroke) Left
F	04-08	SOLARA 2.4L 4Cyl L (2362), 3.48 88.5(Bore)3.78 96.0(Stroke) Left	
G57077 C			
F	04-06	LEXUS	ES330 All Right
F	04-06	TOYOTA	CAMRY 2.4L 4Cyl L (2362), 3.48 88.5(Bore)3.78 96.0(Stroke) Right
F	04-08	SOLARA 2.4L 4Cyl L (2362), 3.48 88.5(Bore)3.78 96.0(Stroke) Right	
G57078 A			
R	04-06	LEXUS	ES330 All Left
R	04-06	TOYOTA	CAMRY All Left
R	04-06	SOLARA	All Left
G57079 A			
R	04-06	LEXUS	ES330 All Right
R	04-06	TOYOTA	CAMRY All Right
R	04-06	SOLARA	All Right
G57080 D			
F	10-11	FORD	CROWN VICTORIA Base
F	03-11	CROWN VICTORIA	LX
F	03-08	CROWN VICTORIA	Base
F	06	CROWN VICTORIA	LX Sport
F	05	CROWN VICTORIA	S
F	03	CROWN VICTORIA	LWB
F	03	CROWN VICTORIA	S
F	03-11	LINCOLN	TOWN CAR All Exc. Limo
F	03-11	MERCURY	GRAND MARQUIS All
F	03-04	MARAUDER	All
G57081 C			
F	06-11	FORD	FOCUS All Left
G57082 C			
F	06-11	FORD	FOCUS All Right

Numerical listing

Shock	POP	Alternative No.	MTG Acc. Supplied
Pos.	Year	Application	
G57083 W			
F	06-10	JEEP	COMMANDER 3.7L 6Cyl V (226) Exc. Performance
F	05-10	GRAND CHEROKEE AWD, 5.7L 8Cyl V (345), 3.92 99.57(Bore)3.58 90.93(Stroke) Exc. Performance	
G57084 W			
F	02-06	HONDA	CR-V Automatic Left
G57085 W			
F	02-06	HONDA	CR-V Automatic Right
G57086 C			
R	02-06	HONDA	CR-V All Left
G57087 C			
R	02-06	HONDA	CR-V All Right
G57088 W			
F	00-06	HYUNDAI	ELANTRA Automatic Left
G57089 W			
F	00-06	HYUNDAI	ELANTRA Automatic Right
G57090 W			
R	00-05	HYUNDAI	SONATA All Left
R	01-06	KIA	MAGENTIS All Left
R	01-06	OPTIMA	All Left
G57091 W			
R	00-05	HYUNDAI	SONATA All Right
R	01-06	KIA	MAGENTIS All Right
R	01-06	OPTIMA	All Right
G57092 A			
F	04-10	INFINITI	QX56 4WD
F	10-15	NISSAN	ARMADA 4WD Exc. Auto-Leveling System
F	05-09	ARMADA	4WD
F	04	PATHFINDER	ARMADA All
F	17-22	TITAN	All Exc. Off Road
F	07-15	TITAN	4WD Exc. Off Road
F	07-15	TITAN	RWD
F	04-06	TITAN	All
G57095 W			
F	06-10	FORD	EXPLORER All
F	06-10	MERCURY	MOUNTAINEER All
G57096 W			
R	06-10	FORD	EXPLORER All
R	06-10	MERCURY	MOUNTAINEER All
G57097 W			
F	03	TOYOTA	SIENNA All Left
F	02	SIENNA	All Left Mfg. to 12/02
F	98-01	SIENNA	All Left
G57098 W			
F	03	TOYOTA	SIENNA All Right
F	02	SIENNA	All Right Mfg. to 12/02
F	98-01	SIENNA	All Right
G57099 D			
F	03-07	SATURN	ION All Left
G57100 D			
F	03-07	SATURN	ION All Right
G57103 D			
F	09-13	FORD	LOBO Extended Cab Pickup, 4WD Exc. Sport Suspension
F	09-13	PICKUP 1/2 TON, F-150 Extended Cab Pickup, 4WD Exc. Sport Suspension	
G57105 W			
F	00-05	TOYOTA	RAV4 AWD, Automatic Left Mfg. from 5/00
G57106 W			
F	00-05	TOYOTA	RAV4 AWD, Automatic Right Mfg. from 5/00
G57107 A			
F	93-02	CHEVROLET	CAMARO All Left
F	93-02	PONTIAC	FIREBIRD All Left
G57108 A			
F	93-02	CHEVROLET	CAMARO All Right
F	93-02	PONTIAC	FIREBIRD All Right
G57109 A			
F	08-12	BUICK	ENCLAVE AWD
F	09-12	CHEVROLET	TRAVERSE AWD
F	07-12	GMC	ACADIA AWD

Numerical listing

Shock	POP	Alternative No.	MTG Acc. Supplied
Pos.	Year	Application	
G57109	A (cont)		
F	07-10	SATURN OUTLOOK AWD	
G57110	W		
F	05-06	CHEVROLET EQUINOX All Left	
G57111	W		
F	05-06	CHEVROLET EQUINOX All Right	
G57112	W		
F	04-08	CHRYSLER PACIFICA All Left	
G57113	W		
F	04-08	CHRYSLER PACIFICA All Right	
G57114	C		
F	03-08	TOYOTA COROLLA All Left	
G57115	C		
F	03-08	TOYOTA COROLLA All Right	
G57118	D		
F	05-11	NISSAN PATHFINDER 4WD	
G57119	C		
F	01-02	ACURA MDX All Left	
F	03-08	HONDA PILOT AWD Left	
G57120	C		
F	01-02	ACURA MDX All Right	
F	03-08	HONDA PILOT AWD Right	
G57121	W		
F	08-10	CHEVROLET MALIBU LS, 2.4L 4Cyl L (145), 3.46 88.0(Bore)3.86 98.0(Stroke) Left	
F	08-10	MALIBU LT, 2.4L 4Cyl L (145), 3.46 88.0(Bore)3.86 98.0(Stroke) Left	
F	08-10	MALIBU LTZ, 2.4L 4Cyl L (145), 3.46 88.0(Bore)3.86 98.0(Stroke) Left	
F	09	MALIBU Base, 2.4L 4Cyl L (145), 3.46 88.0(Bore)3.86 98.0(Stroke) Left	
F	06-10	PONTIAC G6 2.4L 4Cyl L (145), 3.46 88.0(Bore)3.86 98.0(Stroke) Left	
F	08-09	SATURN AURA XE, 2.4L 4Cyl L (145), 3.46 88.0(Bore)3.86 98.0(Stroke) Left	
F	09	AURA XR, 2.4L 4Cyl L (145), 3.46 88.0(Bore)3.86 98.0(Stroke) Left	
F	07-08	AURA Green Line Left	
G57122	W		
F	08-10	CHEVROLET MALIBU LS, 2.4L 4Cyl L (145), 3.46 88.0(Bore)3.86 98.0(Stroke) Right	
F	08-10	MALIBU LT, 2.4L 4Cyl L (145), 3.46 88.0(Bore)3.86 98.0(Stroke) Right	
F	08-10	MALIBU LTZ, 2.4L 4Cyl L (145), 3.46 88.0(Bore)3.86 98.0(Stroke) Right	
F	09	MALIBU Base, 2.4L 4Cyl L (145), 3.46 88.0(Bore)3.86 98.0(Stroke) Right	
F	06-10	PONTIAC G6 2.4L 4Cyl L (145), 3.46 88.0(Bore)3.86 98.0(Stroke) Right	
F	08-09	SATURN AURA XE, 2.4L 4Cyl L (145), 3.46 88.0(Bore)3.86 98.0(Stroke) Right	
F	09	AURA XR, 2.4L 4Cyl L (145), 3.46 88.0(Bore)3.86 98.0(Stroke) Right	
F	07-08	AURA Green Line Right	
G57123	C		
F	07-20	TOYOTA TUNDRA RWD Left	
G57124	C		
F	07-20	TOYOTA TUNDRA RWD Right	
G57125	A		
F	07-13	CHEVROLET AVALANCHE 1500 All Exc. Z55 or ZW7 Ride Suspension	
F	07-14	SUBURBAN 1/2 TON, 1500 All Exc. Z55 or ZW7 Ride Suspension	
F	07-14	TAHOE All Exc. Z55 or ZW7 Ride Suspension	
F	07-14	GMC YUKON All Exc. Z55 or ZW7 Ride Suspension	
F	07-14	YUKON XL 1/2 TON All Exc. Z55 or ZW7 Ride Suspension	
G57126	W		
F	04-08	SUZUKI FORENZA All Left	
F	05-08	RENO All Left	

Ultra ReadyMount

Shock	POP	Alternative No.	MTG Acc. Supplied
Pos.	Year	Application	
G57127	W		
F	04-08	SUZUKI FORENZA All Right	
F	05-08	RENO All Right	
G57128	W		
R	04-08	SUZUKI FORENZA All Left	
R	05-08	RENO All Left	
G57129	W		
R	04-08	SUZUKI FORENZA All Right	
R	05-08	RENO All Right	
G57130	C		
F	06-11	CHEVROLET AVEO All Left	
F	04-11	AVEO All Left	
F	09-10	PONTIAC G3 All Left	
F	05-08	WAVE All Left	
F	04-09	SUZUKI SWIFT All Left	
G57131	C		
F	06-11	CHEVROLET AVEO All Right	
F	04-11	AVEO All Right	
F	09-10	PONTIAC G3 All Right	
F	05-08	WAVE All Right	
F	04-09	SUZUKI SWIFT All Right	
G57132	W		
F	09-13	FORD LOBO RWD	
F	09-13	PICKUP 1/2 TON, F-150 RWD	
G57133	B		
F	17-18	TOYOTA 4RUNNER RWD Left Exc. Kinetic Suspension	
F	03-16	4RUNNER All Left Exc. X-Reas Suspension; Exc. Sport Models	
F	07-14	FJ CRUISER All Left	
F	05-15	TACOMA 4WD Left Exc. Off Road & Sport Models	
F	05-15	TACOMA Pre Runner Left 4WD	
G57134	B		
F	17-18	TOYOTA 4RUNNER RWD Right Exc. Kinetic Suspension	
F	03-16	4RUNNER All Right Exc. X-Reas Suspension; Exc. Sport Models	
F	07-14	FJ CRUISER All Right	
F	05-15	TACOMA 4WD Right Exc. Off Road & Sport Models	
F	05-15	TACOMA Pre Runner Right 4WD	
G57135	W		
F	00-04	AUDI A6 All Left Exc. Sport Suspension	
F	00-04	A6 QUATTRO All Left Exc. Sport Suspension	
F	01-05	VOLKSWAGEN PASSAT All Left	
G57136	W		
F	00-04	AUDI A6 All Right Exc. Sport Suspension	
F	00-04	A6 QUATTRO All Right Exc. Sport Suspension	
F	01-05	VOLKSWAGEN PASSAT All Right	
G57137	W		
F	05-07	HONDA ODYSSEY All Left	
G57138	W		
F	05-07	HONDA ODYSSEY All Right	
G57139	W		
F	01-06	HYUNDAI SANTA FE All Left	
G57140	W		
F	01-06	HYUNDAI SANTA FE All Right	
G57141	W		
F	04-08	PONTIAC GRAND PRIX All	
G57142	W		
F	05-07	BUICK TERRAZA FWD	
F	05-09	CHEVROLET UPLANDER FWD Exc. Auto-Leveling System	
F	05-09	PONTIAC MONTANA SV6, FWD	
F	05-07	SATURN RELAY 2, FWD	
F	05-07	RELAY 3, FWD	
F	07	RELAY 1, FWD	
G57144	W		
F	02-03	INFINITI QX4 All Left	
F	02-04	NISSAN PATHFINDER All Left	
G57145	W		
F	02-03	INFINITI QX4 All Right	
F	02-04	NISSAN PATHFINDER All Right	
G57146	W		
F	05-09	DODGE DAKOTA 4WD	

Numerical listing

Shock	POP	Alternative No.	MTG Acc. Supplied
Pos.	Year	Application	
G57146	W (cont)		
F	06-09	MITSUBISHI RAIDER 4WD	
G57147	C		
F	09-10	DODGE PICKUP 1/2 TON, RAM 1500 (SEE RAM 1500) 4WD	
F	16-18	RAM 1500 (SEE DODGE RAM 1500) 4WD Exc. Air Suspension	
F	11-15	1500 (SEE DODGE RAM 1500) 4WD	
F	19-20	1500 CLASSIC 4WD Old Body Style	
G57148	W		
F	06-09	FORD FUSION All	
F	07-09	MERCURY MILAN AWD	
F	06	MILAN FWD	
G57149	W		
F	06-11	HYUNDAI AZERA All	
F	06-10	SONATA 2.4L 4Cyl L (2359), 3.46 88.0(Bore)3.82 97.0(Stroke)	
G57150	C		
F	04-06	LEXUS RX330 AWD Left	
F	07-09	RX350 FWD Left	
G57151	C		
F	04-06	LEXUS RX330 AWD Right	
F	07-09	RX350 FWD Right	
G57152	C		
R	04-06	LEXUS RX330 AWD Left Non Japan built applications with a clevice mounting hole dimension of 15mm	
R	07-09	RX350 AWD Left Non Japan built applications with a clevice mounting hole dimension of 15mm	
R	04-07	TOYOTA HIGHLANDER AWD Left	
G57153	C		
R	04-06	LEXUS RX330 AWD Right Non Japan built applications with a clevice mounting hole dimension of 15mm	
R	07-09	RX350 AWD Right Non Japan built applications with a clevice mounting hole dimension of 15mm	
R	04-07	TOYOTA HIGHLANDER AWD Right	
G57156	A		
F	09-17	VOLKSWAGEN CC All	
F	12-17	PASSAT All	
F	10	PASSAT All	
F	06-09	PASSAT 2.0T	
G57157	W		
F	02-03	INFINITI I35 All Left	
F	02-03	NISSAN MAXIMA All Left	
G57158	W		
F	02-03	INFINITI I35 All Right	
F	02-03	NISSAN MAXIMA All Right	
G57159	W		
R	00-01	INFINITI I30 All Left	
R	02-04	I35 All Left	
R	00-03	NISSAN MAXIMA All Left	
G57160	W		
R	00-01	INFINITI I30 All Right	
R	02-04	I35 All Right	
R	00-03	NISSAN MAXIMA All Right	
G57161	C		
F	13	NISSAN ALTIMA Coupe Left	
F	10-12	ALTIMA SR Left	
F	07-12	ALTIMA Base Left	
F	07-12	ALTIMA S Left	
F	07-12	ALTIMA SL Left	
F	08-09	ALTIMA Coupe Left	
F	07-09	ALTIMA SE Left	
G57162	C		
F	10-12	NISSAN ALTIMA SR Right	
F	07-12	ALTIMA Base Right	
F	07-12	ALTIMA S Right	
F	07-12	ALTIMA SL Right	
F	08-09	ALTIMA Coupe Right	
F	07-09	ALTIMA SE Right	
G57163	W		
F	03-07	NISSAN MURANO All Left	
G57164	W		
F	03-07	NISSAN MURANO All Right	

Numerical listing

Shock	POP	Alternative No.	MTG Acc. Supplied
Pos.	Year	Application	
G57167	W		
R	00-06	HYUNDAI ELANTRA	All Left
G57168	W		
R	00-06	HYUNDAI ELANTRA	All Right
G57172	W		
F	07-13	FORD EXPEDITION	All Exc. Air Suspension
F	10-13	LINCOLN NAVIGATOR	All Exc. Air Suspension
G57173	D		
R	17	FORD EXPEDITION	All Exc. Air Suspension
R	15-16	EXPEDITION 4WD	Exc. Air Suspension
R	15-16	EXPEDITION RWD	Exc. Air Suspension
R	07-14	EXPEDITION	All Exc. Air Suspension
R	17	LINCOLN NAVIGATOR	All Exc. Air Suspension
R	10-16	NAVIGATOR 4WD	Exc. Air Suspension
R	10-16	NAVIGATOR RWD	Exc. Air Suspension
G57176	C		
F	07-12	DODGE CALIBER	All Left
G57177	C		
F	07-12	DODGE CALIBER	All Right
G57178	W		
R	07-12	DODGE CALIBER	All
G57184	W		
F	04-09	NISSAN QUEST	All Left
G57185	W		
F	04-09	NISSAN QUEST	All Right
G57190	B		
F	07-12	LEXUS ES350	All Left
F	07-11	TOYOTA CAMRY	All Left
G57191	B		
F	07-12	LEXUS ES350	All Right
F	07-11	TOYOTA CAMRY	All Right
G57192	W		
R	07-11	TOYOTA AVALON	All Left
R	06	AVALON	All Left Mfg. from 1/06
R	07-11	CAMRY	All Left
G57193	W		
R	07-11	TOYOTA AVALON	All Right
R	06	AVALON	All Right Mfg. from 1/06
R	07-11	CAMRY	All Right
G57194	W		
F	06-10	CHRYSLER 300 RWD	3.5L 6Cyl V (215), 3.78 96.0(Bore)3.19 81.0(Stroke) Left
F	06-10	DODGE CHARGER RWD	3.5L 6Cyl V (215), 3.78 96.0(Bore)3.19 81.0(Stroke) Left
F	05-08	MAGNUM RWD	3.5L 6Cyl V (215), 3.78 96.0(Bore)3.19 81.0(Stroke) Left
G57195	W		
F	06-10	CHRYSLER 300 RWD	3.5L 6Cyl V (215), 3.78 96.0(Bore)3.19 81.0(Stroke) Right
F	06-10	DODGE CHARGER RWD	3.5L 6Cyl V (215), 3.78 96.0(Bore)3.19 81.0(Stroke) Right
F	05-08	MAGNUM RWD	3.5L 6Cyl V (215), 3.78 96.0(Bore)3.19 81.0(Stroke) Right
G57197	A		
F	07-17	CHEVROLET EQUINOX	All Left Exc. Models w/ 19" Wheels
F	10-16	GMC TERRAIN	All Left Exc. Models w/ 19" Wheels
F	07-09	PONTIAC TORRENT	All Left Exc. Models w/ 19" Wheels
F	08-10	SATURN VUE	All Left Exc. Models w/ 19" Wheels
F	07-09	SUZUKI XL-7	All Left Exc. Models w/ 19" Wheels

Ultra ReadyMount

Shock	POP	Alternative No.	MTG Acc. Supplied
Pos.	Year	Application	
G57198	A		
F	07-17	CHEVROLET EQUINOX	All Right Exc. Models w/ 19" Wheels
F	10-16	GMC TERRAIN	All Right Exc. Models w/ 19" Wheels
F	07-09	PONTIAC TORRENT	All Right Exc. Models w/ 19" Wheels
F	08-10	SATURN VUE	All Right Exc. Models w/ 19" Wheels
F	07-09	SUZUKI XL-7	All Right Exc. Models w/ 19" Wheels
G57200	B		
F	07-12	NISSAN SENTRA	All Left
G57201	B		
F	07-12	NISSAN SENTRA	All Right
G57202	W		
F	09-14	NISSAN CUBE	All Left
F	09-11	VERSA S	Left
F	09-11	VERSA SL	Left
F	07-08	VERSA	All Left
G57203	W		
F	09-14	NISSAN CUBE	All Right
F	09-11	VERSA S	Right
F	09-11	VERSA SL	Right
F	07-08	VERSA	All Right
G57204	A		
F	09-12	TOYOTA RAV4	All Left w/o 3rd Row Seat
F	06-08	RAV4	All Left
G57205	A		
F	09-12	TOYOTA RAV4	All Right w/o 3rd Row Seat
F	06-08	RAV4	All Right
G57206	B		
F	08-16	CHRYSLER TOWN & COUNTRY	All
F	08-20	DODGE CARAVAN / GRAND CARAVAN	All
F	12-15	RAM C/V	All
F	09-14	VOLKSWAGEN ROUTAN	All
G57207	W		
F	08-12	HONDA ACCORD	Automatic Left
G57208	W		
F	08-12	HONDA ACCORD	Automatic Right
G57212	W		
F	03-06	FORD EXPEDITION	RWD
G57218	W		
F	05-09	HYUNDAI TUCSON	All Left
F	05-10	KIA SPORTAGE	All Left
G57219	W		
F	05-09	HYUNDAI TUCSON	All Right
F	05-10	KIA SPORTAGE	All Right
G57220	C		
F	07-20	TOYOTA TUNDRA	4WD Left
G57221	C		
F	07-20	TOYOTA TUNDRA	4WD Right
G57222	W		
F	11	HONDA ELEMENT	All Left
F	07-10	ELEMENT EX	Left
F	07-10	ELEMENT LX	Left
F	03-06	ELEMENT	All Left
G57223	W		
F	11	HONDA ELEMENT	All Right
F	07-10	ELEMENT EX	Right
F	07-10	ELEMENT LX	Right
F	03-06	ELEMENT	All Right
G57266	A		
F	20	DODGE JOURNEY	FWD Left
F	18-19	JOURNEY Sport	FWD Left
F	14-19	JOURNEY	Canada Value Package, FWD Left
F	14-19	JOURNEY	Crossroad, FWD Left
F	14-19	JOURNEY SE Plus	FWD Left
F	14-19	JOURNEY SE	FWD Left
F	14-19	JOURNEY SXT	FWD Left
F	19	JOURNEY SE Blacktop	FWD Left
F	19	JOURNEY Sport Plus	FWD Left
F	17-18	JOURNEY SXT Lujo	FWD Left
F	17	JOURNEY SXT Sport	FWD Left
F	14-15	JOURNEY Limited	FWD Left

Numerical listing

Shock	POP	Alternative No.	MTG Acc. Supplied
Pos.	Year	Application	
G57266	A (cont)		
F	15	JOURNEY AVP	FWD Left
F	14	JOURNEY Base	FWD Left
F	09-13	JOURNEY	FWD Left
G57267	A		
F	20	DODGE JOURNEY	FWD Right
F	18-19	JOURNEY Sport	FWD Right
F	14-19	JOURNEY	Canada Value Package, FWD Right
F	14-19	JOURNEY	Crossroad, FWD Right
F	14-19	JOURNEY SE Plus	FWD Right
F	14-19	JOURNEY SE	FWD Right
F	14-19	JOURNEY SXT	FWD Right
F	19	JOURNEY SE Blacktop	FWD Right
F	19	JOURNEY Sport Plus	FWD Right
F	17-18	JOURNEY SXT Lujo	FWD Right
F	17	JOURNEY SXT Sport	FWD Right
F	14-15	JOURNEY Limited	FWD Right
F	15	JOURNEY AVP	FWD Right
F	14	JOURNEY Base	FWD Right
F	09-13	JOURNEY	FWD Right
G57268	W		
F	00-05	HYUNDAI ACCENT	All Left
G57269	W		
F	00-05	HYUNDAI ACCENT	All Right
G57270	W		
F	03-08	MAZDA 6	All
G57271	D		
F	05-10	FORD MUSTANG / MUSTANG II	All
G57274	W		
F	02-07	BUICK RENDEZVOUS	All Exc. Hydraulic Self-Leveling System
F	01-05	PONTIAC AZTEK	All
G57275	W		
F	06-11	HYUNDAI ACCENT	All Left
F	06-11	KIA RIO	All Left
G57276	W		
F	06-11	HYUNDAI ACCENT	All Right
F	06-11	KIA RIO	All Right
G57277	D		
F	06-13	AUDI A3	All
F	04-13	A3 QUATTRO	All
F	12-13	VOLKSWAGEN BEETLE	All
F	07-11	EOS	All
F	10-12	GOLF	All
F	06-10	JETTA GLI	
G57278	W		
R	00-05	HYUNDAI ACCENT	All Left
G57279	W		
R	00-05	HYUNDAI ACCENT	All Right
G57282	D		
F	04-12	CHEVROLET COLORADO	RWD
F	04-12	GMC CANYON	RWD
G57314	A		
F	08-12	BUICK ENCLAVE	FWD
F	09-11	CHEVROLET TRAVERSE	FWD
F	07-11	GMC ACADIA	FWD
F	07-10	SATURN OUTLOOK	FWD
G57322	D		
F	07-12	CHEVROLET EQUINOX	All Left Models w/ 19" Wheels
F	10-12	GMC TERRAIN	All Left Models w/ 19" Wheels
F	07-09	PONTIAC TORRENT	All Left Models w/ 19" Wheels
F	08-10	SATURN VUE	All Left Models w/ 19" Wheels
F	07-09	SUZUKI XL-7	All Left Models w/ 19" Wheels
G57323	D		
F	07-12	CHEVROLET EQUINOX	All Right Models w/ 19" Wheels
F	10-12	GMC TERRAIN	All Right Models w/ 19" Wheels
F	07-09	PONTIAC TORRENT	All Right Models w/ 19" Wheels
F	08-10	SATURN VUE	All Right Models w/ 19" Wheels
F	07-09	SUZUKI XL-7	All Right Models w/ 19" Wheels

Numerical listing

Shock	POP	Alternative No.	MTG Acc. Supplied
Pos.	Year	Application	
G57324	B		
F	06-11	BUICK LUCERNE	All Exc. Magnetic Ride Control Suspension
F	06-11	CADILLAC DTS	All Exc. Magnetic Ride Control Suspension
G57329	C		
F	09-10	PONTIAC VIBE	AWD Left 10MM Stud Only
F	09-12	TOYOTA COROLLA	All Left 10MM Stud Only
F	09-13	MATRIX	AWD Left 10MM Stud Only
G57330	C		
F	09-10	PONTIAC VIBE	AWD Right 10MM Stud Only
F	09-12	TOYOTA COROLLA	All Right 10MM Stud Only
F	09-13	MATRIX	AWD Right 10MM Stud Only
G57331	A		
F	07-11	HONDA CR-V	All Left
G57332	A		
F	07-11	HONDA CR-V	All Right
G57333	C		
F	06-14	HONDA RIDGELINE	All Left
G57334	C		
F	06-14	HONDA RIDGELINE	All Right
G57335	W		
F	99-05	VOLVO S80	All Left
G57336	W		
F	99-05	VOLVO S80	All Right
G57337	W		
F	07-15	VOLVO S80	All Left
F	06	S80	All Left Mfg. from 3/06
G57338	W		
F	07-15	VOLVO S80	All Right
F	06	S80	All Right Mfg. from 3/06
G57339	D		
F	05-09	SUBARU OUTBACK	All Left
G57340	D		
F	05-09	SUBARU OUTBACK	All Right
G57341	W		
F	00-04	SUBARU OUTBACK	All Left
G57342	W		
F	00-04	SUBARU OUTBACK	All Right
G57343	W		
R	05-09	HYUNDAI TUCSON	All Left
R	05-10	KIA SPORTAGE	All Left
G57344	W		
R	05-09	HYUNDAI TUCSON	All Right
R	05-10	KIA SPORTAGE	All Right
G57345	W		
F	05-09	SUBARU LEGACY	All Left
G57346	W		
F	05-09	SUBARU LEGACY	All Right
G57349	W		
F	01-05	TOYOTA RAV4	FWD Left
G57350	W		
F	01-05	TOYOTA RAV4	FWD Right
G57353	W		
F	07-11	TOYOTA YARIS	All Left
G57354	W		
F	07-11	TOYOTA YARIS	All Right
G57357	W		
F	03-08	PONTIAC VIBE	FWD Left
F	03-08	TOYOTA MATRIX	FWD Left
G57358	W		
F	03-08	PONTIAC VIBE	FWD Right
F	03-08	TOYOTA MATRIX	FWD Right
G57359	W		
F	08-09	FORD TAURUS X	All Left
G57360	W		
F	08-09	FORD TAURUS X	All Right

Ultra ReadyMount

Shock	POP	Alternative No.	MTG Acc. Supplied
Pos.	Year	Application	
G57363	C		
F	08-13	BMW 128i	All Left Exc. Sport Suspension
F	08-13	135i	All Left Exc. Sport Suspension
F	06	325i	All Left Exc. Sport Suspension
F	07-13	328i	All Left Exc. Sport Suspension
F	06	330i	All Left Exc. Sport Suspension
F	07-13	335i	All Left Exc. Sport Suspension
G57364	C		
F	08-13	BMW 128i	All Right Exc. Sport Suspension
F	08-13	135i	All Right Exc. Sport Suspension
F	06	325i	All Right Exc. Sport Suspension
F	07-13	328i	All Right Exc. Sport Suspension
F	06	330i	All Right Exc. Sport Suspension
F	07-13	335i	All Right Exc. Sport Suspension
G57367	W		
F	07-11	NISSAN ALTIMA	Hybrid Left
G57368	W		
F	07-11	NISSAN ALTIMA	Hybrid Right
G57369	D		
F	05-10	SCION TC	All Left
G57370	D		
F	05-10	SCION TC	All Right
G57372	W		
F	05-06	TOYOTA SIENNA	FWD Left Mfg to 6/05 w/ 7 Passenger Seating
F	04	SIENNA	FWD Left w/ 7 Passenger Seating
G57373	W		
F	05-06	TOYOTA SIENNA	FWD Right Mfg to 6/05 w/ 7 Passenger Seating
F	04	SIENNA	FWD Right w/ 7 Passenger Seating
G57375	W		
F	07-10	TOYOTA SIENNA	AWD Left
G57376	W		
F	07-10	TOYOTA SIENNA	AWD Right
G57377	A		
F	12-17	BUICK VERANO	All Left
F	10-15	CHEVROLET CRUZE	All Left
F	16	CRUZE LIMITED	All Left Exc. 3 Stud Mounts
F	12-15	VOLT	All Left
G57378	A		
F	12-17	BUICK VERANO	All Right
F	10-15	CHEVROLET CRUZE	All Right
F	16	CRUZE LIMITED	All Right Exc. 3 Stud Mounts
F	12-15	VOLT	All Right
G57390	C		
F	06-11	ACURA CSX	All Left
F	09-11	HONDA CIVIC	Hybrid-L Left
F	09-11	CIVIC LX-S	Left
F	08-11	CIVIC DX-G	Left
F	08-11	CIVIC EX-L	Left
F	06-11	CIVIC DX	Left
F	06-11	CIVIC EX	Left
F	06-11	CIVIC Hybrid	Left
F	06-11	CIVIC LX	Left
F	11	CIVIC Base	Left
F	09-10	CIVIC Sport	Left
F	08	CIVIC MUGEN Si	Left
F	06-07	CIVIC EXS	Left
F	06-07	CIVIC LXS	Left
G57391	C		
F	06-11	ACURA CSX	All Right
F	09-11	HONDA CIVIC	Hybrid-L Right
F	09-11	CIVIC LX-S	Right
F	08-11	CIVIC DX-G	Right
F	08-11	CIVIC EX-L	Right
F	06-11	CIVIC DX	Right
F	06-11	CIVIC EX	Right
F	06-11	CIVIC Hybrid	Right
F	06-11	CIVIC LX	Right
F	11	CIVIC Base	Right
F	09-10	CIVIC Sport	Right
F	08	CIVIC MUGEN Si	Right
F	06-07	CIVIC EXS	Right

Numerical listing

Shock	POP	Alternative No.	MTG Acc. Supplied
Pos.	Year	Application	
G57391	C (cont)		
F	06-07	CIVIC LXS	Right
G57393	W		
F	07-10	HYUNDAI ELANTRA	All Left
G57394	W		
F	07-10	HYUNDAI ELANTRA	All Right
G57397	W		
F	00-05	TOYOTA ECHO	All
G57398	W		
F	03-08	HYUNDAI TIBURON	All Left
G57399	W		
F	03-08	HYUNDAI TIBURON	All Right
G57400	W		
R	03-08	HYUNDAI TIBURON	All Left
G57401	W		
R	03-08	HYUNDAI TIBURON	All Right
G57404	C		
F	04-09	TOYOTA PRIUS	All Left
G57405	C		
F	04-09	TOYOTA PRIUS	All Right
G57409	W		
F	05-09	DODGE DAKOTA RWD	
F	06-09	MITSUBISHI RAIDER RWD	
G57413	D		
F	05-15	NISSAN XTERRA 4WD	
F	09-12	SUZUKI EQUATOR	All
G57414	D		
R	06-14	HONDA RIDGELINE	All Left
G57415	D		
R	06-14	HONDA RIDGELINE	All Right
G57416	B		
R	07-11	HONDA CR-V	All Left
G57417	W		
F	08-12	HONDA ACCORD	Manual Left
G57418	W		
F	08-12	HONDA ACCORD	Manual Right
G57419	C		
R	08-12	HONDA ACCORD	All
G57420	D		
R	95-00	LEXUS LS400	All
G57421	D		
F	96-00	LEXUS LS400	All Exc. Rough Road Package
F	90-95	LS400	All
G57422	W		
R	95-98	CHRYSLER CIRRUS	All Convertible
R	01-06	SEBRING	Convertible
R	95-98	DODGE STRATUS	All Convertible
R	96-98	PLYMOUTH BREEZE	All Convertible
G57423	W		
R	05-09	SUBARU LEGACY	All
G57424	W		
R	11	HONDA ELEMENT	All Left
R	07-10	ELEMENT EX	Left
R	07-10	ELEMENT LX	Left
R	03-06	ELEMENT	All Left
G57425	W		
R	11	HONDA ELEMENT	All Right
R	07-10	ELEMENT EX	Right
R	07-10	ELEMENT LX	Right
R	03-06	ELEMENT	All Right
G57427	C		
F	10-12	FORD FUSION	All
F	10-12	LINCOLN MKZ	All
F	10-11	MERCURY MILAN	All
G57428	W		
R	05-10	SCION TC	All Left
G57429	W		
R	05-10	SCION TC	All Right

Numerical listing

Shock	POP	Alternative No.	MTG Acc. Supplied
Pos.	Year	Application	
G57444	W		
R	01-03	TOYOTA PRIUS All	
G57447	D		
R	11-14	CHRYSLER 200 Sedan	
R	08-10	SEBRING Sedan	
R	08-14	DODGE AVENGER FWD	
G57449	W		
R	08-09	FORD TAURUS FWD Left	
R	08-09	MERCURY SABLE FWD Left	
G57450	W		
R	08-09	FORD TAURUS FWD Right	
R	08-09	MERCURY SABLE FWD Right	
G57451	W		
R	09-10	TOYOTA COROLLA XRS Left	
R	09-13	MATRIX FWD Left	
G57452	W		
R	09-10	TOYOTA COROLLA XRS Right	
R	09-13	MATRIX FWD Right	
G57453	W		
F	08-15	TOYOTA SEQUOIA All Right	
G57454	W		
F	08-15	TOYOTA SEQUOIA All Left	
G57455	W		
F	09-13	MAZDA 6 All Left	
G57456	W		
F	09-13	MAZDA 6 All Right	
G57459	D		
F	04-05	SUBARU FORESTER All Left	
G57460	D		
F	04-05	SUBARU FORESTER All Right	
G57463	W		
F	07-10	JEEP COMPASS All Right	
F	07-10	PATRIOT All Right	
G57464	W		
F	07-10	JEEP COMPASS All Left	
F	07-10	PATRIOT All Left	
G57465	D		
F	11-14	CHRYSLER 200 Sedan Left	
F	08-10	SEBRING Sedan Left	
F	08-14	DODGE AVENGER All Left	
G57466	D		
F	11-14	CHRYSLER 200 Sedan Right	
F	08-10	SEBRING Sedan Right	
F	08-14	DODGE AVENGER All Right	
G57471	W		
F	07-09	HYUNDAI SANTA FE All Left	
G57472	W		
F	07-09	HYUNDAI SANTA FE All Right	
G57473	D		
F	08-10	NISSAN ROGUE All Left	
G57474	D		
F	08-10	NISSAN ROGUE All Right	
G57479	D		
F	12-16	HONDA CR-V FWD Left	
G57480	D		
F	12-16	HONDA CR-V FWD Right	
G57481	D		
F	09-10	TOYOTA HIGHLANDER AWD, 2.7L 4Cyl L (163), 3.54 90.0(Bore)4.13 105.0(Stroke) Left	
F	08-10	HIGHLANDER 3.3L 6Cyl V (202), 3.62 91.95(Bore)3.27 83.06(Stroke) Left	
G57482	D		
F	09-10	TOYOTA HIGHLANDER AWD, 2.7L 4Cyl L (163), 3.54 90.0(Bore)4.13 105.0(Stroke) Right	
F	08-10	HIGHLANDER 3.3L 6Cyl V (202), 3.62 91.95(Bore)3.27 83.06(Stroke) Right	
G57483	C		
R	08-10	TOYOTA HIGHLANDER FWD Left	
R	09-14	VENZA FWD Left	

Ultra ReadyMount

Shock	POP	Alternative No.	MTG Acc. Supplied
Pos.	Year	Application	
G57484	C		
R	08-10	TOYOTA HIGHLANDER FWD Right	
R	09-14	VENZA FWD Right	
G57489	W		
F	02-05	KIA SEDONA All Left	
G57490	W		
F	02-05	KIA SEDONA All Right	
G57493	C		
F	09-15	NISSAN MAXIMA All Left	
G57494	C		
F	09-15	NISSAN MAXIMA All Right	
G57495	D		
F	10-11	FORD FLEX All Left	
F	09	FLEX All Left Mfg from 7/09	
G57496	D		
F	10-11	FORD FLEX All Right	
F	09	FLEX All Right Mfg from 7/09	
G57497	D		
F	10-12	FORD TAURUS All Left	
F	09	TAURUS FWD Left	
G57498	D		
F	10-12	FORD TAURUS All Right	
F	09	TAURUS FWD Right	
G57499	C		
R	14-17	TOYOTA CAMRY SE Left	
R	12-13	CAMRY All Left	
G57500	C		
R	14-17	TOYOTA CAMRY SE Right	
R	12-13	CAMRY All Right	
G57515	W		
F	03-04	SUBARU LEGACY All Left	
G57516	W		
F	03-04	SUBARU LEGACY All Right	
G57517	D		
F	13-16	FORD ESCAPE All Left	
G57518	D		
F	13-16	FORD ESCAPE All Right	
G57521	W		
F	01-03	ACURA EL All Left	
F	03-05	HONDA CIVIC Hybrid Left	
G57522	W		
F	01-03	ACURA EL All Right	
F	03-05	HONDA CIVIC Hybrid Right	
G57533	D		
R	04-06	LEXUS RX330 FWD Left	
R	07-09	RX350 FWD Left	
R	04-07	TOYOTA HIGHLANDER FWD Left	
G57534	D		
R	04-06	LEXUS RX330 FWD Right	
R	07-09	RX350 FWD Right	
R	04-07	TOYOTA HIGHLANDER FWD Right	
G57535	W		
F	06	PONTIAC TORRENT All Left	
G57536	W		
F	06	PONTIAC TORRENT All Right	
G57539	W		
F	07-12	TOYOTA AVALON All Left	
F	06	AVALON All Left Mfg. from 1/06	
G57540	W		
F	07-12	TOYOTA AVALON All Right	
F	06	AVALON All Right Mfg. from 1/06	
G57541	A		
F	06-08	HONDA FIT All Left	
G57542	A		
F	06-08	HONDA FIT All Right	
G57543	D		
F	14-17	TOYOTA COROLLA All Left	
G57544	D		
F	14-17	TOYOTA COROLLA All Right	
G57545	C		
F	14-16	NISSAN ALTIMA All Left	

Numerical listing

Shock	POP	Alternative No.	MTG Acc. Supplied
Pos.	Year	Application	
G57546	C		
F	14-16	NISSAN ALTIMA All Right	
G57549	W		
F	12-15	CHEVROLET CAPTIVA SPORT All Left	
G57550	W		
F	12-15	CHEVROLET CAPTIVA SPORT All Right	
G57558	W		
F	00-01	NISSAN ALTIMA All Left	
G57559	W		
F	00-01	NISSAN ALTIMA All Right	
G57560	W		
F	07-13	ACURA MDX All Left Exc. Active Suspension	
G57561	W		
F	07-13	ACURA MDX All Right Exc. Active Suspension	
G57562	D		
F	10-14	LEXUS RX350 All Left	
G57563	D		
F	10-14	LEXUS RX350 All Right	
G57564	C		
F	08-10	HONDA ODYSSEY All Left	
G57565	C		
F	08-10	HONDA ODYSSEY All Right	
G57566	W		
F	09-10	PONTIAC VIBE FWD Left	
F	09-13	TOYOTA MATRIX FWD Left	
G57567	W		
F	09-10	PONTIAC VIBE FWD Right	
F	09-13	TOYOTA MATRIX FWD Right	
G57572	W		
R	09-10	TOYOTA COROLLA XRS Left AWD	
R	09-13	MATRIX S, AWD Left	
G57573	W		
R	09-10	TOYOTA COROLLA XRS Right AWD	
R	09-13	MATRIX S, AWD Right	
G57577	W		
F	11-14	CHRYSLER 200 Convertible Left	
F	08-10	SEBRING Convertible Left	
G57578	W		
F	11-14	CHRYSLER 200 Convertible Right	
F	08-10	SEBRING Convertible Right	
G57579	W		
R	11-14	CHRYSLER 200 Convertible	
R	08-10	SEBRING Convertible	
G57582	A		
F	07-14	FORD EDGE All Left	
F	11-14	LINCOLN MKX All Left	
G57583	A		
F	07-14	FORD EDGE All Right	
F	11-14	LINCOLN MKX All Right	
G57586	W		
R	06	LEXUS RX400H FWD Left	
G57587	W		
R	06	LEXUS RX400H FWD Right	
G57594	W		
F	09-13	MAZDA 6 i Left	
G57595	W		
F	09-13	MAZDA 6 i Right	
G57597	W		
R	12-16	HONDA CR-V FWD Left	
G57598	W		
R	12-16	HONDA CR-V FWD Right	
G57603	A		
F	09-13	HONDA FIT All Left	
F	10-14	INSIGHT All Left	
G57604	A		
F	09-13	HONDA FIT All Right	
F	10-14	INSIGHT All Right	

Numerical listing

Shock	POP	Alternative No.	MTG Acc. Supplied
Pos.	Year	Application	
G57605	D		
F	06-08	HONDA PILOT FWD Left	
G57606	D		
F	06-08	HONDA PILOT FWD Right	
G57607	W		
R	07-10	JEEP COMPASS All	
R	07-10	PATRIOT All	
G57612	W		
R	99-03	LEXUS RX300 FWD Left	
G57613	W		
R	99-03	LEXUS RX300 FWD Right	
G57628	C		
F	09-10	SUBARU FORESTER AWD Left	
G57629	C		
F	09-10	SUBARU FORESTER AWD Right	
G57634	W		
R	02-03	SUBARU IMPREZA RS Left	
G57635	W		
R	02-03	SUBARU IMPREZA RS Right	
G57644	W		
F	10-11	SUBARU IMPREZA 2.5i Premium Left	
F	10-11	IMPREZA WRX Limited Left	
F	09-11	IMPREZA R Left	
F	08-11	IMPREZA 2.5i Left	
F	08-11	IMPREZA WRX Left	
F	11	IMPREZA XV Left	
F	09-10	IMPREZA 2.5 GT Left	
F	10	IMPREZA 2.5i Limited Left	
F	10	IMPREZA WRX GT Left	
F	10	IMPREZA WRX STI Special Edition Left	
F	08	IMPREZA 2.0R Left	
G57645	W		
F	10-11	SUBARU IMPREZA 2.5i Premium Right	
F	10-11	IMPREZA WRX Limited Right	
F	09-11	IMPREZA R Right	
F	08-11	IMPREZA 2.5i Right	
F	08-11	IMPREZA WRX Right	
F	11	IMPREZA XV Right	
F	09-10	IMPREZA 2.5 GT Right	
F	10	IMPREZA 2.5i Limited Right	
F	10	IMPREZA WRX GT Right	
F	10	IMPREZA WRX STI Special Edition Right	
F	08	IMPREZA 2.0R Right	
G57646	D		
F	05-21	NISSAN FRONTIER RWD	
G57647	D		
F	05-21	NISSAN FRONTIER 4WD	
G57648	W		
F	01-03	TOYOTA HIGHLANDER AWD Left	
G57649	W		
F	01-03	TOYOTA HIGHLANDER AWD Right	
G57658	B		
R	11-13	TOYOTA HIGHLANDER AWD Left	
R	08-10	HIGHLANDER AWD Left w/o 3rd Row Seat	
R	09-14	VENZA AWD Left	
G57659	B		
R	11-13	TOYOTA HIGHLANDER AWD Right	
R	08-10	HIGHLANDER AWD Right w/o 3rd Row Seat	
R	09-14	VENZA AWD Right	
G57663	W		
F	07-10	TOYOTA SIENNA FWD Left w/ 7 Passenger Seating	
F	05-06	SIENNA FWD Left Mfg from 7/05 w/ 7 Passenger Seating	
G57664	W		
F	07-10	TOYOTA SIENNA FWD Right w/ 7 Passenger Seating	
F	05-06	SIENNA FWD Right Mfg from 7/05 w/ 7 Passenger Seating	

Ultra ReadyMount

Shock	POP	Alternative No.	MTG Acc. Supplied
Pos.	Year	Application	
G57665	W		
F	07-10	TOYOTA SIENNA FWD Left w/ 8 Passenger Seating	
G57666	W		
F	07-10	TOYOTA SIENNA FWD Right w/ 8 Passenger Seating	
G57673	W		
F	10-12	SUBARU LEGACY 2.5i Left	
F	10-12	LEGACY 2.5i Limited Left	
F	10-12	LEGACY 2.5i Premium Left	
F	10-12	LEGACY 3.6R Left	
F	10-12	LEGACY 3.6R Limited Left	
F	10-12	LEGACY 3.6R Premium Left	
F	10-12	LEGACY Base Left	
F	10-12	LEGACY Sport Left	
F	12	LEGACY 2.5i Touring Left	
G57674	W		
F	10-12	SUBARU LEGACY 2.5i Limited Right	
F	10-12	LEGACY 2.5i Premium Right	
F	10-12	LEGACY 2.5i Right	
F	10-12	LEGACY 3.6R Limited Right	
F	10-12	LEGACY 3.6R Premium Right	
F	10-12	LEGACY 3.6R Right	
F	10-12	LEGACY Base Right	
F	10-12	LEGACY Sport Right	
F	12	LEGACY 2.5i Touring Right	
G57675	W		
R	10-12	SUBARU LEGACY 2.5i	
R	10-12	LEGACY 2.5i Limited	
R	10-12	LEGACY 2.5i Premium	
R	10-12	LEGACY 3.6R	
R	10-12	LEGACY 3.6R Limited	
R	10-12	LEGACY 3.6R Premium	
R	10-12	LEGACY Base	
R	10-12	LEGACY Sport	
R	12	LEGACY 2.5i Touring	
G57676	B		
F	09-14	TOYOTA VENZA All Left	
G57677	B		
F	09-14	TOYOTA VENZA All Right	
G57680	W		
F	10-14	VOLKSWAGEN GTI All	
G57682	B		
R	07-11	HONDA CR-V All Right	
G57683	A		
F	14-21	FORD EXPEDITION 4WD	
F	14-22	LOBO 4WD	
F	23-24	PICKUP 1/2 TON, F-150 Raptor R, 4WD	
F	22-24	PICKUP 1/2 TON, F-150 King Ranch, 4WD	
F	22-24	PICKUP 1/2 TON, F-150 Lariat, 4WD	
F	22-24	PICKUP 1/2 TON, F-150 Platinum, 4WD	
F	22-24	PICKUP 1/2 TON, F-150 Police Responder, 4WD	
F	22-24	PICKUP 1/2 TON, F-150 Raptor, 4WD	
F	22-24	PICKUP 1/2 TON, F-150 SSV, 4WD	
F	22-24	PICKUP 1/2 TON, F-150 XL, 4WD	
F	22-24	PICKUP 1/2 TON, F-150 XLT, 4WD	
F	22-23	PICKUP 1/2 TON, F-150 Limited, 4WD	
F	14-21	PICKUP 1/2 TON, F-150 4WD	
F	14-20	LINCOLN NAVIGATOR All Exc. Adaptive Suspension	
G57689	W		
F	11-13	KIA SORENTO AWD Left	
G57690	W		
F	11-13	KIA SORENTO AWD Right	
G57691	W		
F	11-13	FORD EXPLORER AWD Left Mfg. to 9/4/12	
G57692	W		
F	11-13	FORD EXPLORER AWD Right Mfg. to 9/4/12	
G57693	W		
F	13	FORD EXPLORER FWD Left Mfg. to 9/4/12	
F	11-12	EXPLORER FWD Left	

Numerical listing

Shock	POP	Alternative No.	MTG Acc. Supplied
Pos.	Year	Application	
G57694	W		
F	13	FORD EXPLORER FWD Right Mfg. to 9/4/12	
F	11-12	EXPLORER FWD Right	
G57695	C		
F	10-15	HONDA PILOT All Left	
G57696	C		
F	10-15	HONDA PILOT All Right	
G57697	D		
F	13-15	FORD EXPLORER AWD Left Mfg from 9/5/12	
G57698	D		
F	13-15	FORD EXPLORER AWD Right Mfg from 9/5/12	
G57699	W		
F	13-15	FORD EXPLORER FWD Left Mfg from 9/5/12	
G57700	W		
F	13-15	FORD EXPLORER FWD Right Mfg from 9/5/12	
G57701	W		
F	08-14	SUBARU IMPREZA Sport Left	
G57702	W		
F	08-14	SUBARU IMPREZA Sport Right	
G57703	D		
R	08-14	SUBARU IMPREZA All	
G57704	D		
F	11-13	SUBARU FORESTER All Left	
G57705	D		
F	11-13	SUBARU FORESTER All Right	
G57706	C		
R	09-13	SUBARU FORESTER All	
G57709	C		
F	13-17	BUICK ENCLAVE All	
F	13-17	CHEVROLET TRAVERSE All	
F	13-17	GMC ACADIA All	
G57712	D		
F	12-15	HONDA CIVIC Sedan, 1.8L 4Cyl L (1799), 3.19 81.0(Bore)3.44 87.3(Stroke) Left w/ 14mm Lower Mounting Holes	
G57713	D		
F	12-15	HONDA CIVIC Sedan, 1.8L 4Cyl L (1799), 3.19 81.0(Bore)3.44 87.3(Stroke) Right w/ 14mm Lower Mounting Holes	
G57716	A		
F	14-20	CHEVROLET IMPALA All Left	
G57717	A		
F	14-20	CHEVROLET IMPALA All Right	
G57720	W		
F	11-13	TOYOTA HIGHLANDER FWD Left	
G57721	W		
F	11-13	TOYOTA HIGHLANDER FWD Right	
G57722	W		
F	08-15	SCION XB All Left	
G57723	W		
F	08-15	SCION XB All Right	
G57724	B		
F	17-18	FORD FOCUS All Left Exc. Electric; Standard Suspension	
F	16	FOCUS All Left Standard Suspension	
F	12-15	FOCUS All Left Exc. Electric; Standard Suspension	
G57725	B		
F	12-18	FORD FOCUS All Right Exc. Electric; Standard Suspension	
G57726	D		
F	13-18	FORD FOCUS BATTERY EV (EV/BEV) Left Heavy Duty Suspension	
F	12	FOCUS BATTERY EV (EV/BEV) Left	

Numerical listing

Shock	POP	Alternative No.	MTG Acc. Supplied
Pos.	Year	Application	
G57727	D		
F	12-18	FORD FOCUS All Right Heavy Duty Suspension	
G57730	W		
F	14	TOYOTA SIENNA All Left 2.7L 4Cyl	
F	11-13	SIENNA 2.7L 4Cyl L (163) Left	
G57731	W		
F	14	TOYOTA SIENNA All Right 2.7L 4Cyl	
F	11-13	SIENNA 2.7L 4Cyl L (163) Right	
G57732	D		
F	11-14	TOYOTA SIENNA FWD, 3.5L 6Cyl V (3456), 3.70 94.0(Bore)3.27 83.0(Stroke) Left	
G57733	D		
F	11-14	TOYOTA SIENNA FWD, 3.5L 6Cyl V (3456), 3.70 94.0(Bore)3.27 83.0(Stroke) Right	
G57734	W		
F	11-14	TOYOTA SIENNA AWD, 3.5L 6Cyl V (3456), 3.70 94.0(Bore)3.27 83.0(Stroke) Left	
G57735	W		
F	11-14	TOYOTA SIENNA AWD, 3.5L 6Cyl V (3456), 3.70 94.0(Bore)3.27 83.0(Stroke) Right	
G57738	W		
F	10-15	TOYOTA PRIUS All Left	
G57739	W		
F	10-15	TOYOTA PRIUS All Right	
G57740	W		
F	14-17	HYUNDAI ELANTRA GT All Left Models w/ 16" or 17" Wheels; Mfg to 10/16	
G57741	W		
F	14-17	HYUNDAI ELANTRA GT All Right Models w/ 16" or 17" Wheels; Mfg to 10/16	
G57742	W		
F	14-16	HYUNDAI ELANTRA Limited Left Mfg. to 10/16	
F	14-16	ELANTRA SE Left Mfg. to 10/16	
F	13	ELANTRA GLS Left	
F	13	ELANTRA Limited Left	
G57743	W		
F	14-16	HYUNDAI ELANTRA Limited Right Mfg. to 10/16	
F	14-16	ELANTRA SE Right Mfg. to 10/16	
F	13	ELANTRA GLS Right	
F	13	ELANTRA Limited Right	
G57744	W		
F	13-19	FORD POLICE INTERCEPTOR SEDAN All Left	
F	13-19	TAURUS All Left Police Interceptor	
G57745	W		
F	13-19	FORD POLICE INTERCEPTOR SEDAN All Right	
F	13-19	TAURUS All Right Police Interceptor	
G57746	D		
F	13-19	FORD TAURUS All Left	
G57747	D		
F	13-19	FORD TAURUS All Right	
G57748	C		
F	21-22	CHEVROLET COLORADO LT	
F	21-22	COLORADO WT	
F	21-22	COLORADO Z71	
F	21-22	COLORADO Z71 LT	
F	15-20	COLORADO All Exc. ZR2	
F	23	GMC CANYON All Exc. ZR2	
F	15-20	CANYON All Exc. ZR2	
G57749	A		
F	11-15	DODGE DURANGO All Left	
G57750	D		
F	20	DODGE JOURNEY All Left AWD	
F	11-19	JOURNEY AWD Left	
G57751	D		
F	20	DODGE JOURNEY All Right AWD	
F	11-19	JOURNEY AWD Right	

Ultra ReadyMount, LTV Severe Duty

Shock	POP	Alternative No.	MTG Acc. Supplied
Pos.	Year	Application	
G57752	C		
F	15-18	FORD EDGE All Left	
F	16-18	LINCOLN MKX All Left	
G57753	C		
F	15-18	FORD EDGE All Right	
F	16-18	LINCOLN MKX All Right	
G57758	W		
F	10-15	HYUNDAI TUCSON All Left	
G57759	W		
F	10-15	HYUNDAI TUCSON All Right	
G57764	A		
F	10-15	JEEP GRAND CHEROKEE All Left	
G57765	A		
F	10-15	JEEP GRAND CHEROKEE All Right	
G57768	W		
F	15-18	JEEP RENEGADE FWD Left	
G57769	W		
F	15-18	JEEP RENEGADE FWD Right	
G57772	B		
F	14-18	NISSAN MURANO All Left	
F	13-20	PATHFINDER All Left	
G57773	B		
F	14-18	NISSAN MURANO All Right	
F	13-20	PATHFINDER All Right	
G57774	C		
F	14-20	NISSAN ROGUE All Left New Body Style	
G57775	C		
F	14-20	NISSAN ROGUE All Right New Body Style	
G57776	W		
F	13	NISSAN ROGUE All Left Old Body Style	
F	14-15	ROGUE SELECT All Left Old Body Style	
G57777	W		
F	13	NISSAN ROGUE All Right Old Body Style	
F	14-15	ROGUE SELECT All Right Old Body Style	
G57778	W		
F	13-15	NISSAN ROGUE All Left w/ OE #E4302JM00A	
G57779	W		
F	13-15	NISSAN ROGUE All Right w/ OE #E4302JM00A	
G57780	W		
F	13-14	SUBARU OUTBACK All Left	
G57781	W		
F	13-14	SUBARU OUTBACK All Right	
G57782	B		
F	14-18	TOYOTA HIGHLANDER All Left	
G57783	B		
F	14-18	TOYOTA HIGHLANDER All Right	
G57784	D		
F	13-17	TOYOTA RAV4 All Left Exc. Japan Manufactured	
G57785	D		
F	13-17	TOYOTA RAV4 All Right Exc. Japan Manufactured	
G57786	W		
F	18-21	TOYOTA TACOMA 4WD	
G57790	W		
R	11-13	TOYOTA HIGHLANDER FWD Left	
G57791	W		
R	11-13	TOYOTA HIGHLANDER FWD Right	
G57792	W		
R	15-16	HONDA CR-V AWD Left	
G57793	W		
R	15-16	HONDA CR-V AWD Right	

Numerical listing

Shock	POP	Alternative No.	MTG Acc. Supplied
Pos.	Year	Application	
G57794	W		
R	11-17	JEEP COMPASS All	
R	11-17	PATRIOT All	
G57795	W		
R	15-18	JEEP RENEGADE FWD Left	
G57796	W		
R	15-18	JEEP RENEGADE FWD Right	
G57799	W		
R	13-16	SUBARU OUTBACK All	
G57800	A		
F	25	COACHMEN NOVA 20C Left	
F	14-25	RAM PROMASTER 1500 All Left	
F	14-25	PROMASTER 2500 All Left	
F	14-25	PROMASTER 3500 All Left	
F	25	THOR MOTOR COACH DAZZLE 2JB Left	
F	24	SCOPE 18M Left	
G57801	A		
F	25	COACHMEN NOVA 20C Right	
F	14-25	RAM PROMASTER 1500 All Right	
F	14-25	PROMASTER 2500 All Right	
F	14-25	PROMASTER 3500 All Right	
F	25	THOR MOTOR COACH DAZZLE 2JB Right	
F	24	SCOPE 18M Right	
G57802	W		
F	07-09	DODGE SPRINTER 2500 All	
F	07-09	SPRINTER 3500 All	
F	07-18	FREIGHTLINER SPRINTER 2500 All	
F	07-18	SPRINTER 3500 All	
F	10-18	MERCEDES-BENZ SPRINTER 2500 All	
F	10-18	SPRINTER 3500 All	
G57803	W		
F	11-12	HYUNDAI ELANTRA Sedan Left	
G57804	W		
F	11-12	HYUNDAI ELANTRA Sedan Right	
G57812	W		
F	13-20	FORD FUSION All	
G57816	D		
F	15-22	FORD TRANSIT-150 All	
F	15-22	TRANSIT-250 All	
F	15-22	TRANSIT-350 All	
G57817	W		
F	17-18	NISSAN ALTIMA All Left	
G57818	W		
F	17-18	NISSAN ALTIMA All Right	
G57819	B		
F	16-19	FORD EXPLORER All Left	
F	16-19	POLICE INTERCEPTOR UTILITY All Left	
G57820	B		
F	16-19	FORD EXPLORER All Right	
F	16-19	POLICE INTERCEPTOR UTILITY All Right	
G57825	A		
F	11-15	DODGE DURANGO All Right	
G57852	W		
F	15-21	RAM PROMASTER CITY All Left	
G57853	W		
F	15-21	RAM PROMASTER CITY All Right	
LTV Severe Duty			
58357	C		
F	71-95	CHEVROLET VAN 1/2 TON, G / EXPRESS All	
F	70	VAN 1/2 TON, G / EXPRESS All Independent Front Suspension	
F	78-96	VAN 1 TON, G / EXPRESS All	
F	96	VAN 1 TON, G / EXPRESS Cutaway Van	
F	75	VAN 1 TON, G / EXPRESS 146.0 / 370.8 (WheelBase)	
F	71-74	VAN 1 TON, G / EXPRESS All	
F	78-95	VAN 3/4 TON, G / EXPRESS All Exc. 8600# GVW	
F	70-77	VAN 3/4 TON, G / EXPRESS All	
F	70-95	GMC VAN 1/2 TON, G / SAVANA All	
F	76-96	VAN 1 TON, G / SAVANA All	

Numerical listing

Shock	POP	Alternative No.	MTG Acc. Supplied
Pos.	Year	Application	
58357 C (cont)			
F	75	VAN 1 TON, G / SAVANA 110.0 / 279.4 (WheelBase)	
F	75	VAN 1 TON, G / SAVANA 125.0 / 317.5 (WheelBase)	
F	71-74	VAN 1 TON, G / SAVANA All	
F	78-95	VAN 3/4 TON, G / SAVANA All Exc. 8600# GVW	
F	71-77	VAN 3/4 TON, G / SAVANA All	
F	70	VAN 3/4 TON, G / SAVANA All Independent Front Suspension	
58359 D 140126			
F	84-86	DODGE MINI RAM All	
F	72-93	PICKUP 1/2 TON, D100 SERIES All	
F	72-93	PICKUP 3/4 TON, D200 SERIES All Exc. Heavy Duty Package	
F	75-93	RAMCHARGER RWD	
F	99-03	VAN 1/2 TON, A / B SERIES / RAM 109.3 / 277.6 (WheelBase) Exc. 7000# GVW	
F	81-98	VAN 1/2 TON, A / B SERIES / RAM 109.6 / 278.4 (WheelBase) Exc. 7000# GVW	
F	71-80	VAN 1/2 TON, A / B SERIES / RAM All	
F	95-03	VAN 1 TON, A / B SERIES / RAM All	
F	71-94	VAN 1 TON, A / B SERIES / RAM All Exc. 4000# Front Axle	
F	71-03	VAN 3/4 TON, A / B SERIES / RAM All	
F	78-80	VAN, CB300 All Exc. 4000# Front Axle	
F	74-77	VAN, CB300 All Up through 8300# GVW	
F	75-81	PLYMOUTH TRAILDUSTER RWD	
F	74-83	VAN 1/2 TON, PB SERIES All	
F	74-83	VAN 1 TON, PB SERIES All Exc. 4000# Front Axle	
F	74-83	VAN 3/4 TON, PB SERIES All	
58403 D			
R	79-95	CHEVROLET VAN 1 TON, G / EXPRESS Cutaway Van	
F	85	VAN 1 TON, P SERIES All Motorhome Chassis w/ I-Beam Front Suspension	
R	97-04	DODGE DAKOTA All	
R	01-03	DURANGO 4WD	
R	01-03	DURANGO RWD	
R	98-00	DURANGO All	
R	79-95	GMC VAN 1 TON, G / SAVANA Cutaway Van	
F	85	VAN 1 TON, P SERIES All Motorhome Chassis w/ I-Beam Front Suspension	
58412 A			
R	99-07	CHEVROLET PICKUP 1/2 TON, SILVERADO 1500 4WD Exc. Electronic Adjustable Suspension	
R	07	PICKUP 1/2 TON, SILVERADO 1500 4WD Old Body Style; Exc. Electronic Adjustable Suspension	
R	05-06	PICKUP 1/2 TON, SILVERADO 1500 HD All	
R	01-03	PICKUP 1/2 TON, SILVERADO 1500 HD All	
R	77-86	PICKUP 1 TON, K30 All	
R	90-91	PICKUP 1 TON, R3500 All	
R	89	PICKUP 1 TON, R3500 Cab & Chassis	
R	89	PICKUP 1 TON, R3500 Crew Cab Pickup	
R	01-09	PICKUP 1 TON, SILVERADO 3500 All	
R	07-10	PICKUP 1 TON, SILVERADO 3500 HD All	
R	87-88	PICKUP 1 TON, V30 All	
R	89-91	PICKUP 1 TON, V3000 / V3500 All	
R	99-08	PICKUP 3/4 TON, SILVERADO 2500 All	
R	01-10	PICKUP 3/4 TON, SILVERADO 2500 HD All	
R	07	SILVERADO 1500 HD CLASSIC All	
R	07	SILVERADO 2500 HD CLASSIC All	
R	07	SILVERADO 3500 CLASSIC All	
R	06-10	DODGE PICKUP 1/2 TON, RAM 1500 (SEE RAM 1500) All Exc. Mega Cab	
R	02-05	PICKUP 1/2 TON, RAM 1500 (SEE RAM 1500) All	
R	77-86	GMC PICKUP 1 TON, K35 / K3500 All	
R	87-91	PICKUP 1 TON, V3000 / V3500 All	

LTV Severe Duty

Shock	POP	Alternative No.	MTG Acc. Supplied
Pos.	Year	Application	
58412 A (cont)			
R	07	SIERRA 1500 4WD Old Body Style; Exc. Electronic Adjustable Suspension	
R	99-06	SIERRA 1500 4WD Exc. Electronic Adjustable Suspension	
R	05-06	SIERRA 1500 HD All	
R	01-03	SIERRA 1500 HD All	
R	07	SIERRA 1500 HD CLASSIC All	
R	99-04	SIERRA 2500 All	
R	01-10	SIERRA 2500 HD All	
R	07	SIERRA 2500 HD CLASSIC All	
R	01-06	SIERRA 3500 All	
R	07	SIERRA 3500 CLASSIC All	
R	07-10	SIERRA 3500 HD All	
R	11-18	RAM 1500 (SEE DODGE RAM 1500) All	
R	19-22	1500 CLASSIC All Old Body Style	
58421 A 140455			
F	05	CHEVROLET BLAZER Base, RWD	
F	96-04	BLAZER LS, RWD	
F	95-02	BLAZER LT, RWD	
F	95-99	BLAZER Base, RWD	
F	95-97	BLAZER Deluxe, RWD	
F	83-94	BLAZER, S MODELS RWD	
F	94-03	S10 LS, RWD	
F	82-03	S10 Base, RWD	
F	92-93	S10 EL, RWD	
F	83-92	S10 Tahoe, RWD	
F	88-90	S10 Durango, RWD	
F	82-86	S10 Durango, RWD	
F	72-82	FORD COURIER All	
F	92-04	GMC JIMMY RWD	
F	83-91	S15 JIMMY RWD	
F	04	SONOMA / S15 All RWD	
F	82-03	SONOMA / S15 RWD	
F	78-87	SPRINT / CABALLERO RWD	
F	71-77	SPRINT / CABALLERO All	
F	96-00	ISUZU HOMBRE RWD Exc. Sport Chassis	
F	72-76	MAZDA B1600 All	
F	77-78	B1800 All	
F	79-84	B2000 All	
F	82-84	B2200 All	
58422 A			
R	05	CHEVROLET BLAZER Base, 4WD	
R	05	BLAZER Base, RWD	
R	96-04	BLAZER LS, 4WD	
R	96-04	BLAZER LS, RWD	
R	95-02	BLAZER LT, RWD	
R	95-01	BLAZER LT, 4WD	
R	95-99	BLAZER Base, 4WD	
R	95-99	BLAZER Base, RWD	
R	95-97	BLAZER Deluxe, RWD	
R	83-94	BLAZER, S MODELS All	
R	94-04	S10 LS, 4WD	
R	99-03	S10 Base, RWD	
R	99-03	S10 LS, RWD	
R	83-03	S10 Base, 4WD	
R	92-93	S10 EL, 4WD	
R	83-92	S10 Tahoe, 4WD	
R	88-90	S10 Durango, 4WD	
R	83-86	S10 Durango, 4WD	
R	05	GMC JIMMY 4WD	
R	92-04	JIMMY All	
R	83-91	S15 JIMMY All	
R	82-04	SONOMA / S15 All	
R	91	SYCLONE All	
R	92-93	TYPHOON All	
R	96-00	ISUZU HOMBRE All	
R	96-01	OLDSMOBILE BRAVADA All	
R	91-94	BRAVADA All	
58423 B			
F	05	CHEVROLET BLAZER Base, 4WD	
F	96-04	BLAZER LS, 4WD	
F	95-01	BLAZER LT, 4WD	
F	95-99	BLAZER Base, 4WD	
F	83-94	BLAZER, S MODELS 4WD	
F	94-04	S10 LS, 4WD	
F	83-03	S10 Base, 4WD	
F	92-93	S10 EL, 4WD	
F	83-92	S10 Tahoe, 4WD	
F	88-90	S10 Durango, 4WD	
F	88	S10 Sport, 4WD	
F	83-86	S10 Durango, 4WD	
F	92-05	GMC JIMMY 4WD	
F	83-91	S15 JIMMY 4WD	
F	83-04	SONOMA / S15 4WD	
F	91	SYCLONE All	
F	92-93	TYPHOON All	
F	96-00	ISUZU HOMBRE All Sport Chassis	
F	96-01	OLDSMOBILE BRAVADA All	

Numerical listing

Shock	POP	Alternative No.	MTG Acc. Supplied
Pos.	Year	Application	
58423 B (cont)			
F	91-94	BRAVADA All	
58488 A			
R	91-02	CHEVROLET C3500HD All Solid Front Axle	
R	88-02	PICKUP 1/2 TON, C15 / C1500 All	
R	88-99	PICKUP 1/2 TON, K15 / K1500 All	
R	88-90	PICKUP 1 TON, C35/3500 Extended Cab Pickup Exc. HD Straight Front Axle	
R	88-90	PICKUP 1 TON, C35/3500 Standard Cab Pickup Exc. HD Straight Front Axle	
R	88-00	PICKUP 1 TON, K35 / K3500 All	
R	88-00	PICKUP 3/4 TON, C25 / C2500 All	
R	88-00	PICKUP 3/4 TON, K25 / K2500 All	
R	91-02	GMC C3500HD All Solid Front Axle	
R	88-99	PICKUP 1/2 TON, C15 / C1500 All	
R	88-99	PICKUP 1/2 TON, K15 / K1500 All	
R	88-99	PICKUP 1 TON, C35/3500 Cab & Chassis Exc. I Beam Front Axle	
R	88-97	PICKUP 1 TON, C35/3500 All Exc. I Beam Front Axle	
R	88-00	PICKUP 1 TON, K35 / K3500 All	
R	88-00	PICKUP 3/4 TON, C25 / C2500 All	
R	88-00	PICKUP 3/4 TON, K25 / K2500 All	
58489 A 141537			
F	88-02	CHEVROLET PICKUP 1/2 TON, C15 / C1500 All	
F	92-00	PICKUP 1 TON, C35/3500 Crew Cab Pickup Exc. HD Straight Front Axle	
F	88-00	PICKUP 1 TON, C35/3500 Extended Cab Pickup Exc. HD Straight Front Axle	
F	88-00	PICKUP 1 TON, C35/3500 Standard Cab Pickup Exc. HD Straight Front Axle	
F	88-00	PICKUP 3/4 TON, C25 / C2500 All	
F	92-99	SUBURBAN 1/2 TON, C15 / C1500 All	
F	92-99	SUBURBAN 3/4 TON, C25 / C2500 All	
F	95-00	TAHOE RWD Old Body Style	
F	88-99	GMC PICKUP 1/2 TON, C15 / C1500 All	
F	92-00	PICKUP 1 TON, C35/3500 Crew Cab Pickup Exc. HD Straight Front Axle	
F	88-00	PICKUP 1 TON, C35/3500 Extended Cab Pickup Exc. HD Straight Front Axle	
F	88-00	PICKUP 1 TON, C35/3500 Standard Cab Pickup Exc. HD Straight Front Axle	
F	88-00	PICKUP 3/4 TON, C25 / C2500 All	
F	92-99	SUBURBAN 1/2 TON, C15 / C1500 All	
F	92-99	SUBURBAN 3/4 TON, C25 / C2500 All	
F	92-99	YUKON RWD	
58609 A 140780			
F	99-00	CADILLAC ESCALADE All	
F	90-05	CHEVROLET ASTRO AWD	
F	92-94	BLAZER 4WD Full Size	
F	88-00	PICKUP 1 TON, K35 / K3500 All	
F	88-00	PICKUP 3/4 TON, K25 / K2500 All	
F	92-99	SUBURBAN 1/2 TON, K15 / K1500 All	
F	92-99	SUBURBAN 3/4 TON, K25 / K2500 All	
F	88-00	GMC PICKUP 1 TON, K35 / K3500 All	
F	88-00	PICKUP 3/4 TON, K25 / K2500 All	
F	90-05	SAFARI AWD	
F	92-99	SUBURBAN 1/2 TON, K15 / K1500 All	
F	92-99	SUBURBAN 3/4 TON, K25 / K2500 All	
58622 W 142617			
F	00-06	FORD ECONOLINE All	
F	21-24	VAN 1 TON, ECONOLINE / CLUB WAGON / SUPERDUTY All	
F	12-19	VAN 1 TON, ECONOLINE / CLUB WAGON / SUPERDUTY All	
F	04-11	VAN 1 TON, ECONOLINE / CLUB WAGON / SUPERDUTY All Exc. Cutaway Chassis	
F	07-08	VAN 1 TON, ECONOLINE / CLUB WAGON / SUPERDUTY All Cutaway Chassis	

Numerical listing

Shock	POP	Alternative No.	MTG Acc. Supplied
Pos.	Year	Application	
58622 W (cont) 142617			
F	92-05	VAN 1 TON, ECONOLINE / CLUB WAGON / SUPERDUTY All Cutaway Chassis	
F	99-03	VAN 1 TON, ECONOLINE / CLUB WAGON / SUPERDUTY All	
F	92-14	VAN 3/4 TON, ECONOLINE / CLUB WAGON / SUPERDUTY All	
F	25	THOR MOTOR COACH FOUR WINDS 282	
58623 D 142617			
R	00-06	FORD ECONOLINE All	
R	10-14	VAN 1/2 TON, ECONOLINE / CLUB WAGON All	
R	21-24	VAN 1 TON, ECONOLINE / CLUB WAGON / SUPERDUTY All	
R	04-19	VAN 1 TON, ECONOLINE / CLUB WAGON / SUPERDUTY All Exc. Cutaway Chassis	
R	07-08	VAN 1 TON, ECONOLINE / CLUB WAGON / SUPERDUTY All Cutaway Chassis	
R	92-05	VAN 1 TON, ECONOLINE / CLUB WAGON / SUPERDUTY All Cutaway Chassis	
R	99-03	VAN 1 TON, ECONOLINE / CLUB WAGON / SUPERDUTY All	
R	92-14	VAN 3/4 TON, ECONOLINE / CLUB WAGON / SUPERDUTY All	
R	25	THOR MOTOR COACH FOUR WINDS 282	
58638 A			
R	99-00	CADILLAC ESCALADE All	
R	92-94	CHEVROLET BLAZER 4WD Full Size	
R	92-99	SUBURBAN 1/2 TON, C15 / C1500 All	
R	92-99	SUBURBAN 1/2 TON, K15 / K1500 All	
R	92-99	SUBURBAN 3/4 TON, C25 / C2500 All	
R	92-99	SUBURBAN 3/4 TON, K25 / K2500 All	
R	95-00	TAHOE All Old Body Style	
R	96-14	VAN 1/2 TON, G / EXPRESS All	
R	23-24	VAN 1 TON, G / EXPRESS All	
R	10-12	VAN 1 TON, G / EXPRESS All	
R	03-06	VAN 1 TON, G / EXPRESS All	
R	23-24	VAN 3/4 TON, G / EXPRESS All	
R	07-09	VAN 3/4 TON, G / EXPRESS All	
R	96-02	VAN 3/4 TON, G / EXPRESS All Exc. 8600# GVW	
R	92-99	GMC SUBURBAN 1/2 TON, C15 / C1500 All	
R	92-99	SUBURBAN 1/2 TON, K15 / K1500 All	
R	92-99	SUBURBAN 3/4 TON, C25 / C2500 All	
R	92-99	SUBURBAN 3/4 TON, K25 / K2500 All	
R	08-14	VAN 1/2 TON, G / SAVANA All	
R	96-06	VAN 1/2 TON, G / SAVANA All	
R	23-24	VAN 1 TON, G / SAVANA All	
R	96-02	VAN 1 TON, G / SAVANA All Exc. 8600# GVW	
R	23-24	VAN 3/4 TON, G / SAVANA All	
R	96-02	VAN 3/4 TON, G / SAVANA All Exc. 8600# GVW	
R	92-99	YUKON All	
58662 C			
R	99-07	CHEVROLET PICKUP 1/2 TON, SILVERADO 1500 RWD Exc. Electronic Adjustable Suspension	
R	94-01	DODGE PICKUP 1/2 TON, RAM 1500 (SEE RAM 1500) All	
R	94-02	PICKUP 1 TON, RAM 3500 (SEE RAM 3500) RWD Exc. Solid Front Axle	
R	94-02	PICKUP 3/4 TON, RAM 2500 (SEE RAM 2500) All Exc. 8800# GVW	
R	99-07	GMC SIERRA 1500 RWD Exc. Electronic Adjustable Suspension	
58714 W 142731			
F	97-02	FORD EXPEDITION RWD Exc. Front Air- Leveling	
F	97-03	LOBO RWD	
F	97-04	PICKUP 1/2 TON, F-150 RWD	
F	96-99	PICKUP 3/4 TON, F-250 / SUPERDUTY RWD Up through 8500# GVW	
F	98-02	LINCOLN NAVIGATOR RWD	

LTV Severe Duty, ProGuard

Shock	POP	Alternative No.	MTG Acc. Supplied
Pos.	Year	Application	
58803 A 141665			
F	02-06	CADILLAC ESCALADE All	
F	02-04	ESCALADE EXT All	
F	02-06	CHEVROLET AVALANCHE 1500 All Exc. Electronic Ride Control	
F	07	PICKUP 1/2 TON, SILVERADO 1500 4WD Old Body Style; Exc. Electronic Adjustable Suspension	
F	99-06	PICKUP 1/2 TON, SILVERADO 1500 4WD Exc. Electronic Adjustable Suspension	
F	00-06	SUBURBAN 1/2 TON, 1500 All Exc. Z55 Auto Ride Suspension	
F	02-06	TAHOE All Exc. Z55 Auto Ride Suspension	
F	00-01	TAHOE All New Body Style; Exc. Z55 Auto Ride Suspension	
F	07	GMC SIERRA 1500 4WD Old Body Style; Exc. Electronic Adjustable Suspension	
F	99-06	SIERRA 1500 4WD Exc. Electronic Adjustable Suspension	
F	00-06	YUKON All Exc. Z55 Auto Ride Suspension	
F	00-06	YUKON XL 1/2 TON All Exc. Z55 Auto Ride Suspension	
58807 C 142617			
F	22-24	FORD PICKUP 1 TON, F-350 / SUPERDUTY RWD	
F	13-16	PICKUP 1 TON, F-350 / SUPERDUTY All	
F	99-16	PICKUP 1 TON, F-350 / SUPERDUTY RWD	
F	99-24	PICKUP 3/4 TON, F-250 / SUPERDUTY RWD	
58808 W			
R	99-04	FORD PICKUP 1 TON, F-350 / SUPERDUTY RWD	
R	99-04	PICKUP 3/4 TON, F-250 / SUPERDUTY RWD	
58809 B			
F	99-04	FORD PICKUP 1 TON, F-350 / SUPERDUTY 4WD	
F	99-04	PICKUP 3/4 TON, F-250 / SUPERDUTY 4WD	
58810 C			
R	99-04	FORD PICKUP 1 TON, F-350 / SUPERDUTY 4WD	
R	99-04	PICKUP 3/4 TON, F-250 / SUPERDUTY 4WD	
58817 A 141665			
F	02-06	CHEVROLET AVALANCHE 2500 All Exc. Electronic Ride Control	
F	05-06	PICKUP 1/2 TON, SILVERADO 1500 HD All	
F	01-03	PICKUP 1/2 TON, SILVERADO 1500 HD All	
F	01-09	PICKUP 1 TON, SILVERADO 3500 All	
F	07-10	PICKUP 1 TON, SILVERADO 3500 HD All	
F	05-08	PICKUP 3/4 TON, SILVERADO 2500 All	
F	99-04	PICKUP 3/4 TON, SILVERADO 2500 4WD	
F	01-10	PICKUP 3/4 TON, SILVERADO 2500 HD All 9200# GVW	
F	07	SILVERADO 1500 HD CLASSIC All	
F	07	SILVERADO 2500 HD CLASSIC All 9200# GVW	
F	07	SILVERADO 3500 CLASSIC All Heavy Duty	
F	00-13	SUBURBAN 3/4 TON, 2500 All Exc. Z55 Auto Ride Suspension and Quadrateer	
F	05-06	GMC SIERRA 1500 HD All	
F	01-03	SIERRA 1500 HD All	
F	07	SIERRA 1500 HD CLASSIC All	
F	99-04	SIERRA 2500 All	
F	01-10	SIERRA 2500 HD All	
F	01-06	SIERRA 3500 All	
F	07	SIERRA 3500 CLASSIC All	
F	07-10	SIERRA 3500 HD Torsion Bar (FrontSpringType)	
F	00-06	YUKON XL 3/4 TON All Exc. Hydraulic Self-Leveling System	
58901 C			
F	88-99	CHEVROLET PICKUP 1/2 TON, K15 / K1500 All	
F	95-00	TAHOE 4WD Old Body Style	

Numerical listing

Shock	POP	Alternative No.	MTG Acc. Supplied
Pos.	Year	Application	
58901 C (cont)			
F	88-99	GMC PICKUP 1/2 TON, K15 / K1500 All	
F	92-99	YUKON 4WD	
58929 D 140780			
F	90	FORD BRONCO II All	
F	91-94	EXPLORER All	
F	90-97	RANGER All	
F	92-14	VAN 1/2 TON, ECONOLINE / CLUB WAGON All	
F	94-97	MAZDA B2300 All	
F	91-94	NAVAJO All	
58930 A			
R	02-13	CADILLAC ESCALADE All Exc. Electronic Ride Control	
R	07-13	CHEVROLET AVALANCHE 1500 All Exc. Z55 or ZW7 Ride Suspension	
R	02-06	AVALANCHE 1500 All Exc. Electronic Ride Control	
R	02-06	AVALANCHE 2500 All Exc. Electronic Ride Control	
R	75-86	PICKUP 1 TON, C30 All	
R	88-91	PICKUP 1 TON, C35/3500 Cab & Chassis Exc. HD Solid Front Axle	
R	87-88	PICKUP 1 TON, R30 All	
R	89	PICKUP 1 TON, R3500 Standard Cab Pickup	
R	75-86	PICKUP 3/4 TON, C20 Crew Cab Pickup	
R	87-88	PICKUP 3/4 TON, R20 Crew Cab Pickup	
R	89	PICKUP 3/4 TON, R2500 All	
R	07-11	SUBURBAN 1/2 TON, 1500 All Exc. Z55 or ZW7 Ride Suspension	
R	00-06	SUBURBAN 1/2 TON, 1500 All Exc. Z55 Auto Ride Suspension	
R	00-13	SUBURBAN 3/4 TON, 2500 All Exc. Z55 Auto Ride Suspension and Quadrateer	
R	07-11	TAHOE All Exc. Z55 or ZW7 Ride Suspension	
R	02-06	TAHOE All Exc. Z55 Auto Ride Suspension	
R	00-01	TAHOE All New Body Style; Exc. Z55 Auto Ride Suspension	
R	74-80	VAN 1/2 TON, P SERIES All	
R	73-99	VAN 1 TON, P SERIES All	
R	79-89	VAN 3/4 TON, P SERIES All	
R	07-11	GMC YUKON All Exc. Z55 or ZW7 Ride Suspension	
R	00-06	YUKON All Exc. Z55 Auto Ride Suspension	
R	07-11	YUKON XL 1/2 TON All Exc. Z55 or ZW7 Ride Suspension	
R	00-06	YUKON XL 1/2 TON All Exc. Z55 Auto Ride Suspension and Quadrateer	
61500 A			
R	75-80	CHEVROLET LUV PICKUP All	
R	72-74	LUV PICKUP All	
F	55-56	PICKUP 3800	
F	55	PICKUP 3100	
R	87-93	DODGE PICKUP, RAM 50 RWD	
R	83-86	PICKUP, RAM 50 All	
F	48-52	FORD F-1 All	
F	48-52	F-2 All	
F	48-52	F-3 All	
R	61-64	PICKUP 1/2 TON, F-100 All	
R	61-66	PICKUP 1 TON, F-350 / SUPERDUTY All	
R	61-64	PICKUP 3/4 TON, F-250 / SUPERDUTY All	
R	68	INTERNATIONAL 908C All	
R	68	1000C All	
F	68	1100C All Exc. 166" Wheelbase	
R	68	1100C All Exc. 166" Wheelbase	
F	68	1200C All Exc. 166" Wheelbase	
R	68	1200C All Exc. 166" Wheelbase	
F	68	1300C All Exc. 166" Wheelbase	
R	68	1300C All Exc. 166" Wheelbase	
R	72-83	JEEP CJ5 All Exc. Lift Kit	
R	66-71	CJ5 All	
R	72-75	CJ6 All Exc. Lift Kit	
R	66-71	CJ6 All	
R	76-86	CJ7 All Exc. Lift Kit	
R	66-74	DJ5 All Exc. Lift Kit	
R	66-68	DJ6 All	
R	57-60	FC150 All	
F	63-65	FC170 All	

Numerical listing

Shock	POP	Alternative No.	MTG Acc. Supplied
Pos.	Year	Application	
61500 A (cont) 141137			
R	63-65	FC170 All	
R	63-66	GLADIATOR All Independent Front Suspension	
R	70-71	JEEPSTER All	
R	81-85	SCRAMBLER / CJ8 All	
R	61-67	UNIVERSAL All	
R	86-87	MAZDA B2000 RWD	
R	87-93	B2200 RWD	
R	87-93	B2600 RWD	
R	95-96	MITSUBISHI MIGHTY MAX All	
R	83-94	MIGHTY MAX RWD	
R	87-90	VAN All	
R	98-04	NISSAN FRONTIER RWD Exc. Desert Runner	
R	87-97	PICKUP RWD	
R	86	PICKUP RWD Mfg. from 8/86	
R	79-82	PLYMOUTH PICKUP All	
R	69-74	TOYOTA LAND CRUISER All Exc. Wagon	
R	67-68	LAND CRUISER All	
R	85-95	PICKUP RWD Exc. 1 Ton	
R	84	PICKUP RWD	
R	75-83	PICKUP RWD Mojave	
R	70-74	PICKUP All RWD	
R	04	TACOMA Base, RWD	
R	95-03	TACOMA DLX, RWD	
R	98-00	TACOMA SR5, 4WD	
R	84-88	VAN Leaf (RearSpringType)	
R	88	VAN WAGON All Leaf(RearSpringType)	
61501 D 140857			
F	81-82	CHEVROLET LUV PICKUP RWD	
F	81-95	ISUZU PICKUP RWD	
F	69-72	NISSAN 521 PICKUP All	
F	72-79	620 PICKUP All	
F	80-86	720 PICKUP All	
F	87-97	PICKUP 4WD	
F	86	PICKUP 4WD Mfg. from 8/86	
61504 A 140455			
F	05	CHEVROLET BLAZER Base, RWD	
F	96-04	BLAZER LS, RWD	
F	95-02	BLAZER LT, RWD	
F	95-99	BLAZER Base, RWD	
F	95-97	BLAZER Deluxe, RWD	
F	83-94	BLAZER, S MODELS RWD	
F	68-87	EL CAMINO All	
F	94-03	S10 LS, RWD	
F	82-03	S10 Base, RWD	
F	92-93	S10 EL, RWD	
F	83-92	S10 Tahoe, RWD	
F	88-90	S10 Durango, RWD	
F	82-86	S10 Durango, RWD	
F	72-82	FORD COURIER All	
F	92-04	GMC JIMMY RWD	
F	83-91	S15 JIMMY RWD	
F	04	SONOMA / S15 All RWD	
F	82-03	SONOMA / S15 RWD	
F	71-87	SPRINT / CABALLERO All	
F	96-00	ISUZU HOMBRE RWD Exc. Sport Chassis	
F	72-76	MAZDA B1600 All	
F	77-78	B1800 All	
F	79-84	B2000 All	
F	82-84	B2200 All	
F	75-83	TOYOTA PICKUP RWD Mojave	
F	70-74	PICKUP All RWD	
61506 A 141137			
R	81-82	CHEVROLET LUV PICKUP All	
R	61-67	FORD ECONOLINE All	
R	89-94	ISUZU AMIGO All	
R	81-95	PICKUP All	
R	84-86	TROOPER 4WD	
R	86-92	JEEP COMANCHE All	
R	83-88	MITSUBISHI MONTERO 2.6L 4Cyl L (156), 3.59 91.1(Bore)3.86 98.0(Stroke)	
R	97-99	MONTERO SPORT All	
R	82-86	NISSAN 720 PICKUP 4WD	
R	00-04	FRONTIER Crew Cab Pickup, RWD w/ Desert Runner	
R	98-04	FRONTIER 4WD	
R	98-99	FRONTIER RWD Crew Cab; w/ Desert Runner Package	
R	87-95	PATHFINDER All Exc. Electronic Adjustable Suspension	
R	87-97	PICKUP 4WD	
R	86	PICKUP 4WD Mfg. from 8/86	
R	00-04	XTERRA All	
R	84-87	TOYOTA LAND CRUISER FJ60 (MfrBodyCode), Sport Utility	
R	80-83	LAND CRUISER All	

ProGuard

Shock	POP	Alternative No.	MTG Acc. Supplied
Pos.	Year	Application	
61506 A (cont) 141137			
R	79	LAND CRUISER FJ40 (MfrBodyCode)	
R	79	LAND CRUISER FJ55 (MfrBodyCode), Sport Utility	
R	76-78	LAND CRUISER All	
R	75	LAND CRUISER FJ40 (MfrBodyCode) Mfg. from 1/75	
R	75	LAND CRUISER FJ55 (MfrBodyCode), Sport Utility Mfg. from 1/75	
R	85-92	PICKUP RWD 1 Ton	
R	80-83	PICKUP 4WD Exc. Lift Kit	
R	93-98	T100 RWD	
61508 B 140857			
F	81-82	CHEVROLET LUV PICKUP 4WD	
F	75-80	LUV PICKUP All	
F	72-74	LUV PICKUP All	
F	89-94	ISUZU AMIGO All	
F	81-95	PICKUP 4WD	
F	84-86	TROOPER 4WD	
F	98-04	NISSAN FRONTIER RWD Exc. Desert Runner	
F	87-97	PICKUP RWD	
F	86	PICKUP RWD Mfg. from 8/86	
61509 C 140455			
F	93-95	TOYOTA PICKUP RWD Exc. 1 Ton	
F	85-92	PICKUP RWD 1 Ton	
F	84	PICKUP RWD	
F	93-98	T100 RWD	
61510 C 140149			
R	84-89	TOYOTA 4RUNNER All	
R	84-95	PICKUP 4WD Exc. Lift Kit	
R	01-04	TACOMA S-Runner	
R	04	TACOMA Base, 4WD	
R	95-03	TACOMA DLX, 4WD	
R	98-00	TACOMA Limited	
61512 A 140126			
F	87-04	DODGE DAKOTA RWD	
F	99-03	DURANGO RWD	
61516 C			
F	69-91	CHEVROLET BLAZER 4WD Exc. Quad Suspension	
F	81-86	PICKUP 1/2 TON, K10 All Quad Suspension Short Shock; Exc. Lift Kit	
F	69-80	PICKUP 1/2 TON, K10 All Exc. Lift Kit	
F	87	PICKUP 1/2 TON, V10 All Quad Suspension Short Shock; Exc. Lift Kit	
F	81-86	PICKUP 3/4 TON, K20 All Quad Suspension Short Shock; Exc. Lift Kit	
F	69-80	PICKUP 3/4 TON, K20 All Exc. Lift Kit	
F	87	PICKUP 3/4 TON, V20 All Exc. Quad Suspension and Lift Kit	
F	67-72	SUBURBAN 1/2 TON, C10 All 4WD	
F	81-86	SUBURBAN 1/2 TON, K10 All Quad Suspension Short Shock; Exc. Lift Kit	
F	69-80	SUBURBAN 1/2 TON, K10 All Exc. Lift Kit	
F	87-88	SUBURBAN 1/2 TON, V10 All Quad Suspension Short Shock; Exc. Lift Kit	
F	89-91	SUBURBAN 1/2 TON, V1500 All Exc. Quad Suspension and Lift Kit	
F	81-86	SUBURBAN 3/4 TON, K20 All Quad Suspension Short Shock; Exc. Lift Kit	
F	69-80	SUBURBAN 3/4 TON, K20 All Exc. Lift Kit	
F	87-88	SUBURBAN 3/4 TON, V20 All Quad Suspension Short Shock; Exc. Lift Kit	
F	89-91	SUBURBAN 3/4 TON, V2500 All Quad Suspension Short Shock; Exc. Lift Kit	
F	85-91	GMC JIMMY 4WD Exc. Quad Suspension	
F	83-84	JIMMY 4WD Exc. Quad Suspension and Lift Kit	
F	82	JIMMY 4WD Exc. Quad Suspension	
F	79-81	JIMMY 4WD Exc. Quad Suspension and Lift Kit	
F	78	JIMMY 4WD Exc. Quad Suspension	
F	77	JIMMY 4WD Exc. Quad Suspension and Lift Kit	
F	75-76	JIMMY 4WD Exc. Quad Suspension	

Numerical listing

Shock	POP	Alternative No.	MTG Acc. Supplied
Pos.	Year	Application	
61516 C (cont)			
F	70-74	JIMMY All 4WD; Exc. Quad Suspension	
F	69-86	PICKUP 1/2 TON, K15 / K1500 All Exc. Quad Suspension	
F	87	PICKUP 1/2 TON, V1500 All Quad Suspension Short Shock	
F	69-86	PICKUP 3/4 TON, K25 / K2500 All Exc. Quad Suspension and Lift Kit	
F	87	PICKUP 3/4 TON, V2500 All Quad Suspension Short Shock; Exc. Lift Kit	
F	69-86	SUBURBAN 1/2 TON, K15 / K1500 All Exc. Quad Suspension	
F	87-91	SUBURBAN 1/2 TON, V1500 All Quad Suspension Short Shock	
F	69-86	SUBURBAN 3/4 TON, K25 / K2500 All Exc. Quad Suspension and Lift Kit	
F	87-91	SUBURBAN 3/4 TON, V2500 All Quad Suspension Short Shock; Exc. Lift Kit	
61517 C			
F	71-95	CHEVROLET VAN 1/2 TON, G / EXPRESS All	
F	70	VAN 1/2 TON, G / EXPRESS All Independent Front Suspension	
F	78-96	VAN 1 TON, G / EXPRESS All	
F	75	VAN 1 TON, G / EXPRESS 146.0 / 370.8 (WheelBase)	
F	71-74	VAN 1 TON, G / EXPRESS All	
F	78-95	VAN 3/4 TON, G / EXPRESS All Exc. 8600# GVW	
F	71-77	VAN 3/4 TON, G / EXPRESS All	
F	70	VAN 3/4 TON, G / EXPRESS All Independent Front Suspension	
F	71-95	GMC VAN 1/2 TON, G / SAVANA All	
F	70	VAN 1/2 TON, G / SAVANA All Independent Front Suspension	
F	76-95	VAN 1 TON, G / SAVANA All	
F	75	VAN 1 TON, G / SAVANA 110.0 / 279.4 (WheelBase)	
F	75	VAN 1 TON, G / SAVANA 125.0 / 317.5 (WheelBase)	
F	71-74	VAN 1 TON, G / SAVANA All	
F	78-95	VAN 3/4 TON, G / SAVANA All Exc. 8600# GVW	
F	71-77	VAN 3/4 TON, G / SAVANA All	
F	70	VAN 3/4 TON, G / SAVANA All Independent Front Suspension	
61518 C 140126			
R	66	FORD BRONCO All Thru Serial #830000	
R	70-79	PICKUP 1/2 TON, F-100 RWD	
R	75-79	PICKUP 1/2 TON, F-150 RWD	
R	75-79	PICKUP 1 TON, F-350 / SUPERDUTY Extended Cab Pickup, RWD	
R	67-74	PICKUP 1 TON, F-350 / SUPERDUTY RWD Extended Cab	
R	75-79	PICKUP 3/4 TON, F-250 / SUPERDUTY Crew Cab Pickup, RWD	
R	70-74	PICKUP 3/4 TON, F-250 / SUPERDUTY RWD	
R	65-69	PICKUP 3/4 TON, F-250 / SUPERDUTY All RWD	
R	75-91	VAN 1/2 TON, ECONOLINE / CLUB WAGON All	
F	71-80	INTERNATIONAL SCOUT II All	
61519 A 141137			
R	78-79	FORD BRONCO All	
R	66-77	BRONCO All From Serial #830001	
R	65-69	PICKUP 1/2 TON, F-100 All RWD	
R	75-79	PICKUP 1 TON, F-350 / SUPERDUTY Standard Cab Pickup, RWD	
R	73-74	PICKUP 1 TON, F-350 / SUPERDUTY All RWD; Exc. Supercab	
R	75-79	PICKUP 3/4 TON, F-250 / SUPERDUTY Extended Cab Pickup, RWD	
R	73-74	PICKUP 3/4 TON, F-250 / SUPERDUTY RWD Supercab	
R	65-72	PICKUP 3/4 TON, F-250 / SUPERDUTY All RWD; Supercab	
R	69-74	VAN 1/2 TON, ECONOLINE / CLUB WAGON All	
R	69-74	VAN 1 TON, ECONOLINE / CLUB WAGON / SUPERDUTY All	

Numerical listing

Shock	POP	Alternative No.	MTG Acc. Supplied
Pos.	Year	Application	
61519	A (cont)		141137
R	69-74	VAN 3/4 TON, ECONOLINE / CLUB WAGON / SUPERDUTY All	
R	76-83	JEEP CHEROKEE All	
F	74-83	CHEROKEE All	
F	82-83	CJ5 All Exc. Lift Kit	
F	82-86	CJ7 All Exc. Lift Kit	
R	67	GLADIATOR All	
F	93	GRAND WAGONEER All	
R	93	GRAND WAGONEER All	
F	84-91	GRAND WAGONEER All	
R	84-91	GRAND WAGONEER All	
F	74-88	J10 PICKUP All	
R	74-88	J10 PICKUP All	
F	74-88	J20 PICKUP All	
R	74-88	J20 PICKUP All	
R	68-73	J2500 PICKUP All	
F	82-85	SCRAMBLER / CJ8 All	
R	76-83	WAGONEER All	
F	74-83	WAGONEER All	
61520	A		140780
F	80-96	FORD BRONCO All Rearward of Front Axle; Exc. Lift Kit	
F	89	BRONCO II All Mfg. to 2/89; Vehicles w/ 10mm & 12mm bolt in rear lower mount	
F	84-88	BRONCO II All w/ 10mm Bolt In Rear Lower Mount	
F	97	F-250 HD RWD	
F	80-83	PICKUP 1/2 TON, F-100 RWD	
F	80-96	PICKUP 1/2 TON, F-150 4WD Rearward of Front Axle; Exc. Lift Kit	
F	80-96	PICKUP 1/2 TON, F-150 RWD	
F	80-97	PICKUP 1 TON, F-350 / SUPERDUTY RWD	
F	97	PICKUP 3/4 TON, F-250 / SUPERDUTY RWD Over 8500# GVW	
F	80-96	PICKUP 3/4 TON, F-250 / SUPERDUTY RWD	
F	87-89	RANGER All Exc. High Ryder Option	
F	83-86	RANGER All	
61521	B		140780
F	78-79	FORD BRONCO All Quad Suspension Rearward, Non Quad Suspension Right	
F	66-77	BRONCO All From Serial #830001; Exc. Lift Kit RWD, 4WD Quad Suspension Rearward of Front Axle, Non Quad Suspension	
F	69-79	PICKUP 1/2 TON, F-100 All Quad Suspension Rearward, Non Quad Suspension Right	
F	65-68	PICKUP 1/2 TON, F-100 All Quad Suspension Rearward of Front Axle	
F	75-79	PICKUP 1/2 TON, F-150 All Quad Suspension Rearward, Non Quad Suspension Right	
F	68-79	PICKUP 1 TON, F-350 / SUPERDUTY RWD Quad Suspension Rearward of Front Axle	
F	67	PICKUP 1 TON, F-350 / SUPERDUTY All Quad Suspension Rearward of Front Axle	
F	70-79	PICKUP 3/4 TON, F-250 / SUPERDUTY RWD Quad Suspension Rearward of Front Axle	
F	65-69	PICKUP 3/4 TON, F-250 / SUPERDUTY All RWD; Quad Suspension Rearward of Front Axle	
F	75-91	VAN 1 TON, ECONOLINE / CLUB WAGON / SUPERDUTY All Exc. Cutaway Chassis RWD, 4WD Quad Suspension Rearward of Front Axle, Non Quad Suspension	
F	75-91	VAN 3/4 TON, ECONOLINE / CLUB WAGON / SUPERDUTY All RWD, 4WD Quad Suspension Rearward of Front Axle, Non Quad Suspension	
61522	A		
F	87-91	CHEVROLET BLAZER 4WD Full Size; Quad Suspension Long Shock; Exc. Lift Kit	
F	81-86	BLAZER 4WD Quad Suspension Long Shock; Exc. Lift Kit	
F	81-86	PICKUP 1/2 TON, K10 All Quad Suspension Long Shock; Exc. Lift Kit	
F	87	PICKUP 1/2 TON, V10 All Quad Suspension Long Shock; Exc. Lift Kit	
F	81-86	PICKUP 3/4 TON, K20 All Quad Suspension Long Shock; Exc. Lift Kit	

ProGuard

Shock	POP	Alternative No.	MTG Acc. Supplied
Pos.	Year	Application	
61522	A (cont)		
F	87	PICKUP 3/4 TON, V20 All Quad Suspension Long Shock; Exc. Lift Kit	
F	81-86	SUBURBAN 1/2 TON, K10 All Quad Suspension Long Shock; Exc. Lift Kit	
F	87-88	SUBURBAN 1/2 TON, V10 All Quad Suspension Long Shock; Exc. Lift Kit	
F	81-86	SUBURBAN 3/4 TON, K20 All Quad Suspension Long Shock; Exc. Lift Kit	
F	87-88	SUBURBAN 3/4 TON, V20 All Quad Suspension Long Shock; Exc. Lift Kit	
F	89-91	SUBURBAN 3/4 TON, V2500 All Quad Suspension Long Shock; Exc. Lift Kit	
R	78-95	VAN 1/2 TON, G / EXPRESS All	
R	78-95	VAN 1 TON, G / EXPRESS Cutaway Van	
R	78-95	VAN 3/4 TON, G / EXPRESS All Exc. 8600# GVW	
R	84-86	DODGE MINI RAM All	
R	99-03	VAN 1/2 TON, A / B SERIES / RAM 109.3 / 277.6 (WheelBase) Exc. 7000# GVW	
R	81-98	VAN 1/2 TON, A / B SERIES / RAM 109.6 / 278.4 (WheelBase) Exc. 7000# GVW	
R	71-80	VAN 1/2 TON, A / B SERIES / RAM All	
R	71-03	VAN 1 TON, A / B SERIES / RAM All	
R	71-03	VAN 3/4 TON, A / B SERIES / RAM All	
R	74-80	VAN, CB300 All	
F	75-91	GMC JIMMY 4WD Quad Suspension Long Shock	
F	73-74	JIMMY All 4WD; Quad Suspension Long Shock	
F	81-86	PICKUP 1/2 TON, K15 / K1500 All Quad Suspension Long Shock	
F	87	PICKUP 1/2 TON, V1500 All Quad Suspension Long Shock	
F	81-86	PICKUP 3/4 TON, K25 / K2500 All Quad Suspension Long Shock; Exc. Lift Kit	
F	87	PICKUP 3/4 TON, V2500 All Quad Suspension Long Shock; Exc. Lift Kit	
F	81-86	SUBURBAN 1/2 TON, K15 / K1500 All Quad Suspension Long Shock	
F	87-91	SUBURBAN 1/2 TON, V1500 All Quad Suspension Long Shock	
F	81-86	SUBURBAN 3/4 TON, K25 / K2500 All Quad Suspension Long Shock; Exc. Lift Kit	
F	87-91	SUBURBAN 3/4 TON, V2500 All Quad Suspension Long Shock; Exc. Lift Kit	
R	78-95	VAN 1/2 TON, G / SAVANA All	
R	85-96	VAN 1 TON, G / SAVANA Extended Cargo Van	
R	85-96	VAN 1 TON, G / SAVANA Extended Passenger Van	
R	79-96	VAN 1 TON, G / SAVANA Standard Cargo Van	
R	79-96	VAN 1 TON, G / SAVANA Standard Passenger Van	
R	78	VAN 1 TON, G / SAVANA Cutaway Van	
R	78-95	VAN 3/4 TON, G / SAVANA All Exc. 8600# GVW	
R	74-83	PLYMOUTH VAN 1/2 TON, PB SERIES All	
R	74-83	VAN 1 TON, PB SERIES All	
R	74-83	VAN 3/4 TON, PB SERIES All	
61523	B		140126
F	84-86	DODGE MINI RAM All	
F	72-93	PICKUP 1/2 TON, D100 SERIES All	
F	72-93	PICKUP 3/4 TON, D200 SERIES All Exc. Heavy Duty Package	
F	75-93	RAMCHARGER RWD	
F	99-03	VAN 1/2 TON, A / B SERIES / RAM 109.3 / 277.6 (WheelBase) Exc. 7000# GVW	
F	81-98	VAN 1/2 TON, A / B SERIES / RAM 109.6 / 278.4 (WheelBase) Exc. 7000# GVW	
F	71-80	VAN 1/2 TON, A / B SERIES / RAM All	
F	95-03	VAN 1 TON, A / B SERIES / RAM All	
F	71-94	VAN 1 TON, A / B SERIES / RAM All Exc. 4000# Front Axle	
F	71-03	VAN 3/4 TON, A / B SERIES / RAM All	
F	74-80	VAN, CB300 All Exc. 4000# Front Axle	
F	75-81	PLYMOUTH TRAILDUSTER RWD	

Numerical listing

Shock	POP	Alternative No.	MTG Acc. Supplied
Pos.	Year	Application	
61523	B (cont)		140126
F	74-83	VAN 1/2 TON, PB SERIES All	
F	74-83	VAN 1 TON, PB SERIES All Exc. 4000# Front Axle	
F	74-83	VAN 3/4 TON, PB SERIES All	
61524	B		140357
R	87-91	CHEVROLET BLAZER 4WD Full Size	
R	75-86	BLAZER 4WD	
R	73-74	BLAZER All	
R	73-86	PICKUP 1/2 TON, C10 All	
R	75-86	PICKUP 1/2 TON, K10 All	
R	74	PICKUP 1/2 TON, K10 All Exc. Lift Kit	
R	73	PICKUP 1/2 TON, K10 All	
R	87	PICKUP 1/2 TON, R10 All	
R	87	PICKUP 1/2 TON, V10 All Exc. Lift Kit	
R	75-86	PICKUP 3/4 TON, C20 Standard Cab Pickup	
R	73-74	PICKUP 3/4 TON, C20 All Standard Cab Pickup	
R	73-86	PICKUP 3/4 TON, K20 All Exc. Lift Kit	
R	87	PICKUP 3/4 TON, R20 Standard Cab Pickup	
R	87	PICKUP 3/4 TON, V20 All Exc. Quad Suspension and Lift Kit	
R	73-86	SUBURBAN 1/2 TON, C10 All	
R	73-86	SUBURBAN 1/2 TON, K10 All	
R	87-88	SUBURBAN 1/2 TON, R10 All	
R	89-91	SUBURBAN 1/2 TON, R1500 All	
R	89-91	SUBURBAN 1/2 TON, V1500 All Exc. Lift Kit	
R	73-86	SUBURBAN 3/4 TON, C20 All	
R	73-86	SUBURBAN 3/4 TON, K20 All Exc. Lift Kit	
R	87-88	SUBURBAN 3/4 TON, R20 All	
R	89-91	SUBURBAN 3/4 TON, R2500 All	
R	87-88	SUBURBAN 3/4 TON, V20 All Exc. Quad Suspension and Lift Kit	
R	89-91	SUBURBAN 3/4 TON, V2500 All Exc. Lift Kit	
R	73	VAN 1/2 TON, P SERIES All	
R	73-78	VAN 3/4 TON, P SERIES All	
R	73-91	GMC JIMMY All	
R	73-86	PICKUP 1/2 TON, C15 / C1500 All	
R	73-86	PICKUP 1/2 TON, K15 / K1500 All	
R	87	PICKUP 1/2 TON, R1500 All	
R	87	PICKUP 1/2 TON, V1500 All Exc. Lift Kit	
R	75-86	PICKUP 3/4 TON, C25 / C2500 Cab & Chassis	
R	75-86	PICKUP 3/4 TON, C25 / C2500 Standard Cab Pickup	
R	73-74	PICKUP 3/4 TON, C25 / C2500 All Exc. Crew Cab & Bonus Cab	
R	73-86	PICKUP 3/4 TON, K25 / K2500 All Exc. Lift Kit	
R	88-89	PICKUP 3/4 TON, R2500 All Exc. Crew Cab & Bonus Cab	
R	87	PICKUP 3/4 TON, R2500 Cab & Chassis Exc. Crew Cab & Bonus Cab	
R	87	PICKUP 3/4 TON, R2500 Standard Cab Pickup Exc. Crew Cab & Bonus Cab	
R	87	PICKUP 3/4 TON, V2500 All Exc. Lift Kit	
R	73-86	SUBURBAN 1/2 TON, C15 / C1500 All	
R	73-86	SUBURBAN 1/2 TON, K15 / K1500 All	
R	87-91	SUBURBAN 1/2 TON, R1500 All	
R	87-91	SUBURBAN 1/2 TON, V1500 All Exc. Lift Kit	
R	75-86	SUBURBAN 3/4 TON, C25 / C2500 All	
R	73-74	SUBURBAN 3/4 TON, C25 / C2500 All Exc. Crew Cab & Bonus Cab	
R	73-86	SUBURBAN 3/4 TON, K25 / K2500 All Exc. Lift Kit	
R	87-91	SUBURBAN 3/4 TON, R2500 All	
R	87-91	SUBURBAN 3/4 TON, V2500 All Exc. Lift Kit	
R	73	VAN 1/2 TON, P SERIES All	
R	73-78	VAN 3/4 TON, P SERIES All	
61525	A		140702
F	75-84	CHEVROLET BLAZER RWD	
F	69-74	BLAZER All RWD	
F	63-67	C10 PANEL All	
F	63-86	PICKUP 1/2 TON, C10 All	
F	87	PICKUP 1/2 TON, R10 All	

Numerical listing

Table with columns: Shock, POP, Alternative No., MTG Acc. Supplied, Pos., Year, Application. Includes entries for 61525 (A), 61528 (A), and 61529 (W).

ProGuard

Table with columns: Shock, POP, Alternative No., MTG Acc. Supplied, Pos., Year, Application. Includes entries for 61529 (W), 61530 (A), 61531 (B), 61533 (W), 61535 (B), 61536 (C), 61539 (W), 61541 (W), and 61542 (A).

Numerical listing

Table with columns: Shock, POP, Alternative No., MTG Acc. Supplied, Pos., Year, Application. Includes entries for 61542 (A), 61543 (A), 61544 (A), 61546 (C), and 61547 (A).

Numerical listing

Shock	POP	Alternative No.	MTG Acc. Supplied
Pos.	Year	Application	
61550 W 140524			
R	48-52	FORD F-1 All	
R	48-52	F-2 All	
R	48-52	F-3 All	
F	53-55	PICKUP 1/2 TON, F-100 All	
R	53-55	PICKUP 1/2 TON, F-100 All	
F	53-55	PICKUP 1 TON, F-350 / SUPERDUTY All	
R	53-55	PICKUP 1 TON, F-350 / SUPERDUTY All	
F	53-55	PICKUP 3/4 TON, F-250 / SUPERDUTY All	
R	53-55	PICKUP 3/4 TON, F-250 / SUPERDUTY All	
R	86-95	SUZUKI SAMURAI All	
61552 D 140524			
F	86-95	TOYOTA 4RUNNER All	
F	86-95	PICKUP 4WD Exc. Lift Kit	
F	93-98	T100 4WD	
61554 C			
R	80-96	FORD BRONCO All Exc. Lift Kit	
R	80-83	PICKUP 1/2 TON, F-100 RWD	
R	80-84	PICKUP 1/2 TON, F-150 RWD	
R	80-97	PICKUP 1 TON, F-350 / SUPERDUTY RWD Dual Rear Wheels	
61555 B 142615			
F	85-05	CHEVROLET ASTRO RWD	
F	81	BEL AIR Sedan Police and Taxi Models	
F	71-75	BEL AIR Sedan Police and Taxi Models	
F	71-72	BISCAYNE All Police and Taxi Models	
F	73-96	CAPRICE Sedan Police and Taxi Models	
F	71-72	CAPRICE All Police and Taxi Models	
F	83-85	IMPALA All Police and Taxi Models	
F	71-82	IMPALA Sedan Police and Taxi Models	
F	96-02	VAN 1/2 TON, G / EXPRESS All	
F	96-02	VAN 1 TON, G / EXPRESS All	
F	96-02	VAN 3/4 TON, G / EXPRESS All Exc. 8600# GVW	
F	93-02	FORD CROWN VICTORIA Police Interceptor	
F	85-05	GMC SAFARI RWD	
F	96-02	VAN 1/2 TON, G / SAVANA All	
F	96-02	VAN 1 TON, G / SAVANA All	
F	96-02	VAN 3/4 TON, G / SAVANA All Exc. 8600# GVW	
61556 W 140455			
F	83-93	DODGE PICKUP, RAM 50 RWD	
F	83-96	MITSUBISHI MIGHTY MAX RWD	
F	79-82	PLYMOUTH PICKUP All	
61560 W 141514			
R	92-93	ASUNA SUNRUNNER All	
R	98-04	CHEVROLET TRACKER Non-ABS	
R	89-97	GEO TRACKER All	
R	94-97	PONTIAC SUNRUNNER All	
R	99-05	SUZUKI GRAND VITARA All	
R	89-98	SIDEKICK Non-ABS	
R	99-04	VITARA Non-ABS	
R	96-98	X-90 All	
61561 C 140780			
F	90	FORD BRONCO II All	
F	90-97	RANGER All	
F	94-97	MAZDA B2300 All	
F	94-97	B3000 All	
F	94-97	B4000 RWD	
61565 C			
R	99-00	CADILLAC ESCALADE All	
R	92-94	CHEVROLET BLAZER 4WD Full Size	
R	92-99	SUBURBAN 1/2 TON, C15 / C1500 All	
R	92-99	SUBURBAN 1/2 TON, K15 / K1500 All	
R	92-99	SUBURBAN 3/4 TON, C25 / C2500 All	
R	92-99	SUBURBAN 3/4 TON, K25 / K2500 All	
R	95-00	TAHOE All Old Body Style	
R	03-11	VAN 1/2 TON, G / EXPRESS All Exc. Upfitter Package and Cutaway Chassis	
R	96-02	VAN 1/2 TON, G / EXPRESS All	
R	97-02	VAN 1 TON, G / EXPRESS All	

ProGuard

Shock	POP	Alternative No.	MTG Acc. Supplied
Pos.	Year	Application	
61565 C (cont)			
R	96	VAN 1 TON, G / EXPRESS All Exc. 8600# GVW	
R	96-02	VAN 3/4 TON, G / EXPRESS All Exc. 8600# GVW	
R	92-99	GMC SUBURBAN 1/2 TON, C15 / C1500 All	
R	92-99	SUBURBAN 1/2 TON, K15 / K1500 All	
R	92-99	SUBURBAN 3/4 TON, C25 / C2500 All	
R	92-99	SUBURBAN 3/4 TON, K25 / K2500 All	
R	03-11	VAN 1/2 TON, G / SAVANA All Exc. Upfitter Package and Cutaway Chassis	
R	96-02	VAN 1/2 TON, G / SAVANA All	
R	96-02	VAN 1 TON, G / SAVANA All Exc. 8600# GVW	
R	96-02	VAN 3/4 TON, G / SAVANA All Exc. 8600# GVW	
R	92-99	YUKON All	
61573 W			
R	90-97	FORD RANGER 4WD	
R	89	RANGER 4WD High Ryder Option	
R	95-96	MAZDA B2300 4WD	
61575 W			
R	93-98	JEEP GRAND CHEROKEE All	
61582 W			
R	93-98	TOYOTA T100 4WD	
61584 D			
R	87-96	DODGE DAKOTA 4WD	
61590 W 140719			
R	91-94	FORD EXPLORER All	
R	91-94	MAZDA NAVAJO All	
61591 D 140780			
F	91-94	FORD EXPLORER All	
F	92-14	VAN 1/2 TON, ECONOLINE / CLUB WAGON All	
F	92-11	VAN 1 TON, ECONOLINE / CLUB WAGON / SUPERDUTY All	
F	92-02	VAN 3/4 TON, ECONOLINE / CLUB WAGON / SUPERDUTY All	
F	91-94	MAZDA NAVAJO All	
61592 W 142389			
R	49-52	CHEVROLET FLEETLINE All	
R	49-52	FLEETLINE TRUCK All	
R	94-97	HONDA PASSPORT All	
R	91-97	ISUZU RODEO All	
R	98-03	TOYOTA SIENNA All	
61593 C 140524			
F	94-02	HONDA PASSPORT All	
F	98-00	ISUZU AMIGO All	
F	02-04	AXIOM All	
F	91-04	RODEO All	
F	87-91	TROOPER 4WD	
F	86-87	MAZDA B2000 RWD	
F	87-93	B2200 RWD	
F	87-93	B2600 RWD	
F	87-90	MITSUBISHI VAN All	
F	87-95	NISSAN PATHFINDER All Exc. Electronic Adjustable Suspension	
61595 W 140780			
R	92-11	FORD VAN 1/2 TON, ECONOLINE / CLUB WAGON All	
61599 B 143000			
F	94-01	DODGE PICKUP 1/2 TON, RAM 1500 (SEE RAM 1500) RWD	
F	94-02	PICKUP 1 TON, RAM 3500 (SEE RAM 3500) RWD Exc. Solid Front Axle	
F	94-02	PICKUP 3/4 TON, RAM 2500 (SEE RAM 2500) RWD	
61600 A			
R	99-07	CHEVROLET PICKUP 1/2 TON, SILVERADO 1500 RWD Exc. Electronic Adjustable Suspension	
R	94-01	DODGE PICKUP 1/2 TON, RAM 1500 (SEE RAM 1500) All	
R	94-02	PICKUP 1 TON, RAM 3500 (SEE RAM 3500) RWD Exc. Solid Front Axle	
R	94-03	PICKUP 3/4 TON, RAM 2500 (SEE RAM 2500) All Exc. 8800# GVW	
R	99-07	GMC SIERRA 1500 RWD Exc. Electronic Adjustable Suspension	

Numerical listing

Shock	POP	Alternative No.	MTG Acc. Supplied
Pos.	Year	Application	
61601 B 140126			
F	97-04	DODGE DAKOTA 4WD	
F	98-03	DURANGO 4WD	
61605 A			
R	96-07	CHRYSLER TOWN & COUNTRY All Exc. Hydraulic Self-Leveling System	
R	00-03	VOYAGER / GRAND VOYAGER All Exc. Hydraulic Self-Leveling System	
R	00	VOYAGER / GRAND VOYAGER Non-ABS Exc. Hydraulic Self-Leveling System	
R	96-07	DODGE CARAVAN / GRAND CARAVAN All Exc. Hydraulic Self-Leveling System	
R	96-00	PLYMOUTH VOYAGER / GRAND VOYAGER All Exc. Hydraulic Self-Leveling System	
61606 W 140673			
F	01-04	TOYOTA TACOMA S-Runner	
F	04	TACOMA Base, RWD	
F	95-03	TACOMA DLX, RWD	
61608 W 140169			
R	96-99	ACURA SLX All	
R	92-02	ISUZU TROOPER All	
R	99-01	VEHICROSS All	
61611 B 142731			
F	97-02	FORD EXPEDITION RWD Exc. Front Air-Leveling	
F	97-03	LOBO RWD	
F	97-04	PICKUP 1/2 TON, F-150 RWD	
F	96-99	PICKUP 3/4 TON, F-250 / SUPERDUTY RWD Up through 8500# GVW	
F	98-02	LINCOLN NAVIGATOR Coil (FrontSpringType)	
61612 C 142700			
R	98-03	FORD LOBO 4WD	
R	97-04	PICKUP 1/2 TON, F-150 4WD	
R	97-99	PICKUP 3/4 TON, F-250 / SUPERDUTY 4WD Up through 8500# GVW	
61613 B 142731			
F	97-02	FORD EXPEDITION 4WD Exc. Front Air-Leveling	
F	98-03	LOBO 4WD	
F	04	PICKUP 1/2 TON, F-150 4WD Exc. 7000# GVW	
F	97-03	PICKUP 1/2 TON, F-150 4WD	
F	97-99	PICKUP 3/4 TON, F-250 / SUPERDUTY 4WD Up through 8500# GVW	
61614 D			
R	97-02	FORD EXPEDITION All	
F	97	F-250 HD 4WD	
F	86-97	PICKUP 1 TON, F-350 / SUPERDUTY 4WD	
F	97-98	PICKUP 3/4 TON, F-250 / SUPERDUTY 4WD Over 8500# GVW	
F	87-96	PICKUP 3/4 TON, F-250 / SUPERDUTY 4WD	
R	98-02	LINCOLN NAVIGATOR RWD	
61615 B 141665			
F	97-06	JEEP WRANGLER TJ (MfrBodyCode)	
61616 B			
R	97-06	JEEP WRANGLER TJ (MfrBodyCode)	
61623 A 142277			
F	95-01	FORD EXPLORER All Exc. Adjustable Suspension	
F	01-05	EXPLORER SPORT TRAC All	
F	98-11	RANGER Torsion Bar (FrontSpringType)	
F	98-07	MAZDA B3000 Torsion Bar (FrontSpringType)	
F	98-09	B4000 Torsion Bar (FrontSpringType)	
F	97-01	MERCURY MOUNTAINEER All Exc. Electronic Adjustable Suspension	
61624 W 140719			
R	95-01	FORD EXPLORER All Exc. Adjustable Suspension	
R	01-05	EXPLORER SPORT TRAC All	

Numerical listing

Shock	POP	Alternative No.	MTG Acc. Supplied
Pos.	Year	Application	
61624	W (cont)		140719
R	97-01	MERCURY MOUNTAINEER All Exc. Electronic Adjustable Suspension	
61625	W		
R	95-03	FORD WINDSTAR Coil (RearSpringType)	
61626	A		141665
F	06-11	FORD RANGER RWD, Coil (FrontSpringType)	
F	01-05	RANGER XL , RWD, Coil (FrontSpringType)	
F	01-05	RANGER XLT , RWD, Coil (FrontSpringType)	
F	01-02	RANGER EV , RWD Coil (FrontSpringType)	
F	98-00	RANGER XL , RWD	
F	98-00	RANGER XLT , RWD	
F	01-09	MAZDA B2300 RWD	
F	98-01	B2500 RWD	
F	98-07	B3000 RWD	
F	98-09	B4000 RWD	
61627	A		
R	90	FORD BRONCO II All	
R	89	BRONCO II All Mfg. from 2/89; Vehicles w/ 12mm bolt in rear lower mount	
R	98-11	RANGER RWD, Coil (FrontSpringType)	
R	90-97	RANGER RWD	
R	89	RANGER RWD Mfg. from 2/89; Vehicles w/ 12mm bolt in rear lower mount	
R	01-09	MAZDA B2300 RWD	
R	94-97	B2300 RWD	
R	98-01	B2500 RWD, Coil (FrontSpringType)	
R	03-07	B3000 RWD, Coil (FrontSpringType)	
R	94-01	B3000 RWD, Coil (FrontSpringType)	
R	01-09	B4000 RWD Coil (FrontSpringType)	
R	98-00	B4000 RWD, Coil (FrontSpringType)	
R	94-97	B4000 RWD	
61629	A		
R	98-11	FORD RANGER Torsion Bar (FrontSpringType)	
R	98-07	MAZDA B3000 Torsion Bar (FrontSpringType)	
R	98-09	B4000 Torsion Bar (FrontSpringType)	
61632	W		
F	81-93	DODGE PICKUP 1/2 TON, W100 SERIES All Exc. Lift Kit	
F	61-80	PICKUP 1/2 TON , W100 SERIES All	
F	81-93	PICKUP 1 TON , W300 SERIES All Exc. Quad Suspension and Lift Kit	
F	61-80	PICKUP 1 TON , W300 SERIES All	
R	61-71	PICKUP 1 TON , W300 SERIES All	
F	90-93	PICKUP 3/4 TON , W200 SERIES Extended Cab Pickup Exc. Lift Kit	
F	88-93	PICKUP 3/4 TON , W200 SERIES Cab & Chassis Exc. Lift Kit	
F	81-93	PICKUP 3/4 TON , W200 SERIES Standard Cab Pickup Exc. Lift Kit	
F	86	PICKUP 3/4 TON , W200 SERIES Cab & Chassis Exc. Lift Kit	
F	81-83	PICKUP 3/4 TON , W200 SERIES Cab & Chassis Exc. Lift Kit	
F	81-82	PICKUP 3/4 TON , W200 SERIES Extended Cab Pickup Exc. Lift Kit	
F	69-80	PICKUP 3/4 TON , W200 SERIES All	
F	61-67	PICKUP 3/4 TON , W200 SERIES All	
F	75-93	RAMCHARGER 4WD	
F	74	RAMCHARGER All 4WD	
F	75-81	PLYMOUTH TRAILDUSTER 4WD	
F	74	TRAILDUSTER All	
61634	W		142731
F	94-01	DODGE PICKUP 1/2 TON, RAM 1500 (SEE RAM 1500) 4WD	
F	94-02	PICKUP 3/4 TON , RAM 2500 (SEE RAM 2500) 4WD Exc. 8800# GVW	
61635	C		142731
F	94-02	DODGE PICKUP 1 TON, RAM 3500 (SEE RAM 3500) 4WD	
F	94-02	PICKUP 1 TON , RAM 3500 (SEE RAM 3500) RWD Solid Front Axle	

ProGuard

Shock	POP	Alternative No.	MTG Acc. Supplied
Pos.	Year	Application	
61635	C (cont)		142731
F	94-02	PICKUP 3/4 TON , RAM 2500 (SEE RAM 2500) 4WD 8800# GVW	
61638	C		142700
R	00-03	FORD LOBO Harley-Davidson Edition, RWD	
R	00-03	LOBO XLT , RWD	
R	00	LOBO Base , RWD	
R	00	LOBO Lariat , RWD	
R	97-98	LOBO RWD	
R	04	PICKUP 1/2 TON , F-150 RWD	
R	00-03	PICKUP 1/2 TON , F-150 Harley-Davidson Edition, RWD	
R	99-03	PICKUP 1/2 TON , F-150 Lariat, RWD	
R	99-03	PICKUP 1/2 TON , F-150 XL, RWD	
R	99-03	PICKUP 1/2 TON , F-150 XLT, RWD	
R	00	PICKUP 1/2 TON , F-150 Base, RWD	
R	97-98	PICKUP 1/2 TON , F-150 RWD	
R	97-99	PICKUP 3/4 TON , F-250 / SUPERDUTY RWD Up through 8500# GVW	
61641	A		141665
F	99-07	CHEVROLET PICKUP 1/2 TON, SILVERADO 1500 RWD Exc. Electronic Adjustable Suspension	
F	99-04	PICKUP 3/4 TON , SILVERADO 2500 RWD Exc. Electronic Adjustable Suspension	
F	01-04	PICKUP 3/4 TON , SILVERADO 2500 HD RWD	
F	99-07	GMC SIERRA 1500 RWD Exc. Electronic Adjustable Suspension	
F	99-04	SIERRA 2500 RWD Exc. Electronic Adjustable Suspension	
F	01-04	SIERRA 2500 HD RWD	
61642	A		
R	07	CHEVROLET PICKUP 1/2 TON, SILVERADO 1500 4WD Old Body Style; Exc. Electronic Adjustable Suspension	
R	99-06	PICKUP 1/2 TON , SILVERADO 1500 4WD Exc. Electronic Adjustable Suspension	
R	05-06	PICKUP 1/2 TON , SILVERADO 1500 HD All	
R	01-03	PICKUP 1/2 TON , SILVERADO 1500 HD All	
R	77-86	PICKUP 1 TON , K30 All	
R	90-91	PICKUP 1 TON , R3500 All	
R	89	PICKUP 1 TON , R3500 Cab & Chassis, RWD	
R	89	PICKUP 1 TON , R3500 Crew Cab Pickup, RWD	
R	01-09	PICKUP 1 TON , SILVERADO 3500 All	
R	07-10	PICKUP 1 TON , SILVERADO 3500 HD All	
R	87-88	PICKUP 1 TON , V30 All	
R	89-91	PICKUP 1 TON , V3000 / V3500 All	
R	99-08	PICKUP 3/4 TON , SILVERADO 2500 All	
R	01-10	PICKUP 3/4 TON , SILVERADO 2500 HD All	
R	07	SILVERADO 1500 HD CLASSIC 4WD	
R	07	SILVERADO 2500 HD CLASSIC All	
R	94-02	DODGE PICKUP 1 TON, RAM 3500 (SEE RAM 3500) 4WD	
R	94-02	PICKUP 1 TON , RAM 3500 (SEE RAM 3500) RWD Solid Front Axle	
R	94-02	PICKUP 3/4 TON , RAM 2500 (SEE RAM 2500) 4WD 8800# GVW	
R	77-86	GMC PICKUP 1 TON, K35 / K3500 All	
R	87-91	PICKUP 1 TON , V3000 / V3500 All	
R	07	SIERRA 1500 4WD Old Body Style; Exc. Electronic Adjustable Suspension	
R	99-06	SIERRA 1500 4WD Exc. Electronic Adjustable Suspension	
R	05-06	SIERRA 1500 HD All	
R	01-03	SIERRA 1500 HD All	
R	07	SIERRA 1500 HD CLASSIC All	
R	99-04	SIERRA 2500 All	
R	01-10	SIERRA 2500 HD All	
R	01-06	SIERRA 3500 All	
R	07	SIERRA 3500 CLASSIC All	
R	07-10	SIERRA 3500 HD All	
61643	A		141665
F	02-06	CHEVROLET AVALANCHE 1500 All Exc. Electronic Ride Control	

Numerical listing

Shock	POP	Alternative No.	MTG Acc. Supplied
Pos.	Year	Application	
61643	A (cont)		141665
F	07	PICKUP 1/2 TON , SILVERADO 1500 4WD Old Body Style; Exc. Electronic Adjustable Suspension	
F	99-06	PICKUP 1/2 TON , SILVERADO 1500 4WD Exc. Electronic Adjustable Suspension	
F	00-06	SUBURBAN 1/2 TON , 1500 All Exc. Z55 Auto Ride Suspension	
F	02-06	TAHOE All Exc. Z55 Auto Ride Suspension	
F	00-01	TAHOE All New Body Style; Exc. Z55 Auto Ride Suspension	
F	07	GMC SIERRA 1500 4WD Old Body Style; Exc. Electronic Adjustable Suspension	
F	99-06	SIERRA 1500 4WD Exc. Electronic Adjustable Suspension	
F	00-06	YUKON All Exc. Z55 Auto Ride Suspension	
F	00-06	YUKON XL 1/2 TON All Exc. Z55 Auto Ride Suspension	
61646	W		142617
R	00-06	FORD ECONOLINE All	
R	12-14	VAN 1/2 TON , ECONOLINE / CLUB WAGON All	
R	21-24	VAN 1 TON , ECONOLINE / CLUB WAGON / SUPERDUTY All	
R	12-19	VAN 1 TON , ECONOLINE / CLUB WAGON / SUPERDUTY All	
R	04-11	VAN 1 TON , ECONOLINE / CLUB WAGON / SUPERDUTY All Exc. Cutaway Chassis	
R	92-05	VAN 1 TON , ECONOLINE / CLUB WAGON / SUPERDUTY All	
R	92-14	VAN 3/4 TON , ECONOLINE / CLUB WAGON / SUPERDUTY All	
R	25	THOR MOTOR COACH FOUR WINDS 282	
61651	D		142389
R	00	TOYOTA RAV4 All Mfg. to 5/00	
R	96-99	RAV4 All	
61654	W		
R	99-04	FORD PICKUP 1 TON, F-350 / SUPERDUTY RWD	
R	99-04	PICKUP 3/4 TON , F-250 / SUPERDUTY RWD	
61655	B		
F	99-04	FORD PICKUP 1 TON, F-350 / SUPERDUTY 4WD	
F	99-04	PICKUP 3/4 TON , F-250 / SUPERDUTY 4WD	
61656	C		
R	99-04	FORD PICKUP 1 TON, F-350 / SUPERDUTY 4WD	
R	99-04	PICKUP 3/4 TON , F-250 / SUPERDUTY 4WD	
61658	B		
R	97-04	DODGE DAKOTA All	
R	98-03	DURANGO 4WD	
R	98-03	DURANGO RWD	
61659	W		
R	02-05	CHEVROLET VENTURE All	
R	97-01	VENTURE FWD	
R	02-04	OLDSMOBILE SILHOUETTE AWD	
R	97-04	SILHOUETTE FWD	
R	99-05	PONTIAC MONTANA All Exc. Air-Leveling Suspension	
R	97-98	TRANS SPORT All	
61662	B		142389
F	00-04	NISSAN FRONTIER Crew Cab Pickup, RWD w/ Desert Runner	
F	98-04	FRONTIER 4WD	
F	98-99	FRONTIER RWD Crew Cab; w/ Desert Runner Package	
F	00-04	XTERRA All	
61663	A		141665
F	02-06	CHEVROLET AVALANCHE 2500 All Exc. Electronic Ride Control	
F	05-06	PICKUP 1/2 TON , SILVERADO 1500 HD All	
F	01-03	PICKUP 1/2 TON , SILVERADO 1500 HD All	
F	01-09	PICKUP 1 TON , SILVERADO 3500 All	
F	07-10	PICKUP 1 TON , SILVERADO 3500 HD All	

Numerical listing

Shock	POP	Alternative No.	MTG Acc. Supplied
Pos.	Year	Application	
61663	A (cont)		141665
F	05-08	PICKUP 3/4 TON, SILVERADO 2500 All	
F	99-04	PICKUP 3/4 TON, SILVERADO 2500 4WD	
F	05-10	PICKUP 3/4 TON, SILVERADO 2500 HD All 9200# GVW	
F	01-04	PICKUP 3/4 TON, SILVERADO 2500 HD 4WD 9200# GVW	
F	07	SILVERADO 1500 HD CLASSIC All	
F	07	SILVERADO 2500 HD CLASSIC All	
F	00-13	SUBURBAN 3/4 TON, 2500 All Exc. Z55 Auto Ride Suspension and Quadrateer	
F	16-19	SUBURBAN 3500 HD All	
F	05-06	GMC SIERRA 1500 HD All	
F	06	SIERRA 1500 HD 4WD, Torsion Bar (FrontSpringType)	
F	01-03	SIERRA 1500 HD All	
F	07	SIERRA 1500 HD CLASSIC All	
F	99-04	SIERRA 2500 4WD	
F	01-10	SIERRA 2500 HD 4WD	
F	01-06	SIERRA 3500 All	
F	07	SIERRA 3500 CLASSIC All	
F	07-10	SIERRA 3500 HD Torsion Bar (FrontSpringType)	
F	00-06	YUKON XL 3/4 TON All Exc. Hydraulic Self-Leveling System	
F	03-09	HUMMER H2 All	
61664	A		141353
F	99-04	JEEP GRAND CHEROKEE All Exc. Up Country Suspension	
61675	A		
R	02-13	CADILLAC ESCALADE All Exc. Electronic Ride Control	
R	03-10	ESCALADE ESV All Exc. Electronic Ride Control	
R	02-10	ESCALADE EXT All Exc. Electronic Ride Control	
R	07-13	CHEVROLET AVALANCHE 1500 All Exc. Z55 or ZW7 Ride Suspension	
R	02-06	AVALANCHE 1500 All Exc. Electronic Ride Control	
R	02-06	AVALANCHE 2500 All Exc. Electronic Ride Control	
R	07-11	SUBURBAN 1/2 TON, 1500 All Exc. Z55 or ZW7 Ride Suspension	
R	00-06	SUBURBAN 1/2 TON, 1500 All Exc. Z55 Auto Ride Suspension	
R	00-13	SUBURBAN 3/4 TON, 2500 All Exc. Z55 Auto Ride Suspension and Quadrateer	
R	07-11	TAHOE All Exc. Z55 or ZW7 Ride Suspension	
R	02-06	TAHOE All Exc. Z55 Auto Ride Suspension	
R	00-01	TAHOE All New Body Style; Exc. Z55 Auto Ride Suspension	
R	07-11	GMC YUKON All Exc. Z55 or ZW7 Ride Suspension	
R	00-06	YUKON All Exc. Z55 Auto Ride Suspension	
R	07-11	YUKON XL 1/2 TON All Exc. Z55 or ZW7 Ride Suspension	
R	00-06	YUKON XL 1/2 TON All Exc. Z55 Auto Ride Suspension	
R	00-11	YUKON XL 3/4 TON All Exc. Z55 Auto Ride Suspension and Quadrateer	
61676	C		
R	99-04	JEEP GRAND CHEROKEE All	
R	52-54	LINCOLN CAPRI All	
R	52-54	COSMOPOLITAN All	
61679	D		140126
F	87-96	DODGE DAKOTA 4WD	
61680	A		142731
F	05-24	FORD PICKUP 1 TON, F-350 / SUPERDUTY 4WD	
F	11-16	PICKUP 1 TON, F-350 / SUPERDUTY All	
F	99-09	PICKUP 1 TON, F-350 / SUPERDUTY All	
F	01-24	PICKUP 3/4 TON, F-250 / SUPERDUTY 4WD	
F	99	PICKUP 3/4 TON, F-250 / SUPERDUTY 4WD	
61682	B		
R	13-16	FORD PICKUP 1 TON, F-350 / SUPERDUTY 4WD w/ Off Road Package	

ProGuard

Shock	POP	Alternative No.	MTG Acc. Supplied
Pos.	Year	Application	
61682	B (cont)		
R	05-12	PICKUP 1 TON, F-350 / SUPERDUTY Crew Cab Pickup, 4WD Single Rear Wheels	
R	05-12	PICKUP 1 TON, F-350 / SUPERDUTY Extended Cab Pickup, 4WD Single Rear Wheels	
R	05-12	PICKUP 1 TON, F-350 / SUPERDUTY Standard Cab Pickup, 4WD Single Rear Wheels	
R	12-16	PICKUP 3/4 TON, F-250 / SUPERDUTY RWD w/ Off Road Package	
R	05-16	PICKUP 3/4 TON, F-250 / SUPERDUTY 4WD	
61683	W		143276
F	10-14	CHEVROLET VAN 1/2 TON, G / EXPRESS AWD, Torsion Bar (FrontSpringType)	
F	03-09	VAN 1/2 TON, G / EXPRESS Torsion Bar (FrontSpringType)	
F	06-12	VAN 3/4 TON, G / EXPRESS All Torsion Bar (FrontSpringType)	
F	03-05	VAN 3/4 TON, G / EXPRESS Torsion Bar (FrontSpringType)	
F	10-14	GMC VAN 1/2 TON, G / SAVANA AWD, Torsion Bar (FrontSpringType)	
F	04-09	VAN 1/2 TON, G / SAVANA Torsion Bar (FrontSpringType)	
F	03	VAN 1/2 TON, G / SAVANA Torsion Bar (FrontSpringType) Torsion Bar (FrontSpringType)	
F	06-12	VAN 3/4 TON, G / SAVANA All Torsion Bar (FrontSpringType)	
F	03-05	VAN 3/4 TON, G / SAVANA AWD, Torsion Bar (FrontSpringType)	
61684	D		143276
F	03-14	CHEVROLET VAN 1/2 TON, G / EXPRESS RWD, Coil (FrontSpringType)	
F	03-14	GMC VAN 1/2 TON, G / SAVANA RWD, Coil (FrontSpringType)	
61685	A		143078
F	10-24	CHEVROLET VAN 1 TON, G / EXPRESS All	
F	10-24	VAN 3/4 TON, G / EXPRESS All	
F	10-24	GMC VAN 1 TON, G / SAVANA All	
F	10-24	VAN 3/4 TON, G / SAVANA All	
61687	A		
R	25	CHEVROLET VAN 1 TON, G / EXPRESS All	
R	13-23	VAN 1 TON, G / EXPRESS All	
R	03-12	VAN 1 TON, G / EXPRESS All Single Rear Wheels	
R	03-24	VAN 3/4 TON, G / EXPRESS All	
R	25	GMC VAN 1 TON, G / SAVANA All	
R	13-23	VAN 1 TON, G / SAVANA All	
R	03-12	VAN 1 TON, G / SAVANA All Single Rear Wheels	
R	25	VAN 3/4 TON, G / SAVANA All	
R	03-23	VAN 3/4 TON, G / SAVANA All	
61690	A		
R	22-24	CHEVROLET PICKUP 1/2 TON, SILVERADO 1500 All Exc. Electronic Adaptable Suspension	
R	08-21	PICKUP 1/2 TON, SILVERADO 1500 All	
R	07	PICKUP 1/2 TON, SILVERADO 1500 Base Exc. Electronic Adjustable Suspension	
R	07	PICKUP 1/2 TON, SILVERADO 1500 LT Exc. Electronic Adjustable Suspension	
R	07	PICKUP 1/2 TON, SILVERADO 1500 LTZ Exc. Electronic Adjustable Suspension	
R	07	PICKUP 1/2 TON, SILVERADO 1500 WT Exc. Electronic Adjustable Suspension	
R	22-24	GMC SIERRA 1500 All Exc. Electronic Adaptable Suspension	
R	08-21	SIERRA 1500 All	
R	07	SIERRA 1500 Denali Exc. Electronic Adjustable Suspension	
R	07	SIERRA 1500 SLE Exc. Electronic Adjustable Suspension	
R	07	SIERRA 1500 SLT Exc. Electronic Adjustable Suspension	
R	07	SIERRA 1500 WT Exc. Electronic Adjustable Suspension	

Numerical listing

Shock	POP	Alternative No.	MTG Acc. Supplied
Pos.	Year	Application	
61691	B		
R	06-08	DODGE PICKUP 1/2 TON, RAM 1500 (SEE RAM 1500) Crew Cab Pickup, 4WD	
R	06-08	PICKUP 1/2 TON, RAM 1500 (SEE RAM 1500) Standard Cab Pickup, 4WD	
R	02-05	PICKUP 1/2 TON, RAM 1500 (SEE RAM 1500) 4WD	
61692	C		
R	06-08	DODGE PICKUP 1/2 TON, RAM 1500 (SEE RAM 1500) Crew Cab Pickup, RWD	
R	06-08	PICKUP 1/2 TON, RAM 1500 (SEE RAM 1500) Standard Cab Pickup, RWD	
R	02-05	PICKUP 1/2 TON, RAM 1500 (SEE RAM 1500) RWD	
61696	C		
R	07-17	JEEP WRANGLER All Exc. Models w/ 17" Wheels	
61697	B		
R	16-17	JEEP WRANGLER All Models w/ 17" Wheels; w/Heavy Duty Suspension	
R	07-15	WRANGLER All Models w/ 17" Wheels	
61699	W		140149
R	98-04	TOYOTA TACOMA Pre Runner Left	
61700	W		140149
R	98-04	TOYOTA TACOMA Pre Runner Right	
61703	W		
R	98-02	LINCOLN NAVIGATOR 4WD, Air (RearSpringType)	
61704	A		
R	01-06	ACURA MDX All	
R	03-08	HONDA PILOT All	
61710	W		
R	03-07	DODGE PICKUP 1 TON, RAM 3500 (SEE RAM 3500) Crew Cab Pickup, RWD	
R	03-10	PICKUP 3/4 TON, RAM 2500 (SEE RAM 2500) Crew Cab Pickup, RWD	
61711	B		142973
F	07-12	JEEP WRANGLER All	
61712	W		142731
F	06-08	DODGE PICKUP 1/2 TON, RAM 1500 (SEE RAM 1500) 4WD Mega Cab	
61713	D		
R	05-16	FORD PICKUP 1 TON, F-350 / SUPERDUTY RWD Exc. Off Road	
R	05-16	PICKUP 3/4 TON, F-250 / SUPERDUTY RWD Exc. Off Road	
61714	D		142731
F	04-10	DODGE PICKUP 3/4 TON, RAM 2500 (SEE RAM 2500) 4WD	
61715	B		
R	06-10	JEEP COMMANDER All	
R	05-10	GRAND CHEROKEE All	
61716	C		
R	03-10	DODGE PICKUP 3/4 TON, RAM 2500 (SEE RAM 2500) 4WD	
R	11-13	RAM 2500 (SEE DODGE RAM 2500) 4WD	
61717	B		
R	04-07	BUICK RAINIER All	
R	06-09	CHEVROLET TRAILBLAZER Air (RearSpringType)	
R	02-05	TRAILBLAZER All Air(RearSpringType)	
R	02-09	GMC ENVOY All	
R	03-08	ISUZU ASCENDER Coil (RearSpringType)	
R	02-04	OLDSMOBILE BRAVADA All	
R	05-09	SAAB 9-7X All	
61718	A		
R	05-13	CHEVROLET EQUINOX All	
R	10-13	GMC TERRAIN All	
R	06-09	PONTIAC TORRENT All	

Numerical listing

Shock	POP	Alternative No.	MTG Acc. Supplied
Pos.	Year	Application	
61718	A (cont)		
R	07-09	SUZUKI XL-7 All Exc. 3rd Row Seating	
61720	C		
F	07-09	CHRYSLER ASPEN All	
F	04-09	DODGE DURANGO All	
61734	D		
R	04-09	DODGE DURANGO All	
61777	W		
R	02-07	BUICK RENDEZVOUS All Exc. Hydraulic Self-Leveling System	
R	01-05	PONTIAC AZTEK AWD	
Ultra Truck Shock			
G63173	W		
R	93-98	TOYOTA T100 RWD	
G63183	W		
R	74	DODGE M300 All	
F	81-93	PICKUP 1/2 TON, W100 SERIES All Exc. Lift Kit	
F	61-80	PICKUP 1/2 TON, W100 SERIES All	
F	81-93	PICKUP 1 TON, W300 SERIES All Exc. Quad Suspension and Lift Kit	
F	61-80	PICKUP 1 TON, W300 SERIES All	
R	61-71	PICKUP 1 TON, W300 SERIES All	
F	90-93	PICKUP 3/4 TON, W200 SERIES Extended Cab Pickup Exc. Lift Kit	
F	88-93	PICKUP 3/4 TON, W200 SERIES Cab & Chassis Exc. Lift Kit	
F	81-93	PICKUP 3/4 TON, W200 SERIES Standard Cab Pickup Exc. Lift Kit	
F	86	PICKUP 3/4 TON, W200 SERIES Cab & Chassis Exc. Lift Kit	
F	81-83	PICKUP 3/4 TON, W200 SERIES Cab & Chassis Exc. Lift Kit	
F	81-82	PICKUP 3/4 TON, W200 SERIES Extended Cab Pickup Exc. Lift Kit	
F	69-80	PICKUP 3/4 TON, W200 SERIES All	
F	61-67	PICKUP 3/4 TON, W200 SERIES All	
F	75-93	RAMCHARGER 4WD	
F	74	RAMCHARGER All 4WD	
F	78-80	RD200 All	
F	75-81	PLYMOUTH TRAILDUSTER 4WD	
F	74	TRAILDUSTER All	
G63299	W		140885
R	61-67	FORD ECONOLINE All	
F	72-81	JEEP CJ5 All Exc. Lift Kit	
F	72-75	CJ6 All Exc. Lift Kit	
F	76-81	CJ7 All Exc. Lift Kit	
F	66-74	DJ5 All Exc. Lift Kit	
F	81	SCRAMBLER / CJ8 All	
R	71-74	WAGONEER All	
R	63-67	WAGONEER All	
R	97-02	MERCURY VILLAGER Non-ABS	
R	93-96	VILLAGER 4-Wheel ABS	
R	93-02	NISSAN QUEST All	
F	76-83	TOYOTA LAND CRUISER FJ40 (MfrBodyCode)	
F	75	LAND CRUISER FJ40 (MfrBodyCode) Mfg. to 2/75	
F	67-74	LAND CRUISER All	
G63306	C		
R	69-72	CHEVROLET BLAZER RWD	
R	63-67	C10 PANEL All Leaf (Rear Spring Type)	
R	67	K20 PANEL All	
R	63-72	PICKUP 1/2 TON, C10 All Leaf(RearSpringType)	
R	67-72	PICKUP 1/2 TON, K10 All	
R	67-72	PICKUP 1 TON, C30 All Exc. 11,000# Rear Axle	
R	63-72	PICKUP 3/4 TON, C20 All	
R	67-72	PICKUP 3/4 TON, K20 All	
R	63-66	SUBURBAN 1/2 TON, 1500 All	
R	67-77	VAN 1/2 TON, G / EXPRESS All	
R	63-66	VAN 1/2 TON, P SERIES All	
R	76-77	VAN 1 TON, G / EXPRESS All	
R	75	VAN 1 TON, G / EXPRESS 110.0 / 279.4 (WheelBase)	
R	75	VAN 1 TON, G / EXPRESS 125.0 / 317.5 (WheelBase)	
R	71-74	VAN 1 TON, G / EXPRESS All	
R	68-72	VAN 1 TON, P SERIES All Exc. 11,000# Rear Axle	
R	67-77	VAN 3/4 TON, G / EXPRESS All	
R	68-72	VAN 3/4 TON, P SERIES All	
R	70-72	GMC JIMMY All RWD	
R	68-72	PICKUP 1/2 TON, C15 / C1500 All RWD	

ProGuard, Ultra Truck Shock

Shock	POP	Alternative No.	MTG Acc. Supplied
Pos.	Year	Application	
G63306	C (cont)		
R	67	PICKUP 1/2 TON, C15 / C1500 All	
R	67-72	PICKUP 1 TON, C35/3500 All Exc. 11,000# Rear Axle	
R	72	PICKUP 3/4 TON, C25 / C2500 All Leaf(RearSpringType)	
R	71	PICKUP 3/4 TON, C25 / C2500 All	
R	67-70	PICKUP 3/4 TON, C25 / C2500 All Leaf(RearSpringType)	
R	63-65	PICKUP 1000 SERIES All	
R	63-65	PICKUP 1500 SERIES All	
R	67-77	VAN 1/2 TON, G / SAVANA All	
R	67	VAN 1/2 TON, P SERIES All	
R	76-77	VAN 1 TON, G / SAVANA All	
R	75	VAN 1 TON, G / SAVANA 110.0 / 279.4 (WheelBase)	
R	75	VAN 1 TON, G / SAVANA 125.0 / 317.5 (WheelBase)	
R	71-74	VAN 1 TON, G / SAVANA All	
R	68-72	VAN 1 TON, P SERIES All Exc. 11,000# Rear Axle	
R	67-77	VAN 3/4 TON, G / SAVANA All	
R	68-72	VAN 3/4 TON, P SERIES All	
R	63-65	VAN, PB 1000 SERIES All	
G63347	C		
F	76-91	CHEVROLET BLAZER 4WD Exc. Quad Suspension	
F	75	BLAZER 4WD	
F	69-74	BLAZER 4WD Exc. Quad Suspension	
F	73-86	PICKUP 1/2 TON, K10 All Exc. Lift Kit	
F	69-72	PICKUP 1/2 TON, K10 All	
F	87	PICKUP 1/2 TON, V10 All Exc. Lift Kit	
F	69-86	PICKUP 3/4 TON, K20 All Exc. Lift Kit	
F	87	PICKUP 3/4 TON, V20 All Exc. Quad Suspension and Lift Kit	
F	67-72	SUBURBAN 1/2 TON, C10 All 4WD	
F	69-86	SUBURBAN 1/2 TON, K10 All Exc. Lift Kit	
F	69-86	SUBURBAN 3/4 TON, K20 All Exc. Lift Kit	
F	87-88	SUBURBAN 3/4 TON, V20 All Exc. Quad Suspension and Lift Kit	
F	89-91	SUBURBAN 3/4 TON, V2500 All Exc. Lift Kit	
F	75-91	GMC JIMMY 4WD	
F	70-74	JIMMY All 4WD	
F	69-86	PICKUP 1/2 TON, K15 / K1500 All Exc. Quad Suspension	
F	87	PICKUP 1/2 TON, V1500 All Exc. Lift Kit	
F	69-86	PICKUP 3/4 TON, K25 / K2500 All Exc. Quad Suspension and Lift Kit	
F	87	PICKUP 3/4 TON, V2500 All Exc. Lift Kit	
G63349	A		140357
R	87-91	CHEVROLET BLAZER 4WD Full Size	
R	85-86	BLAZER 4WD	
R	73-84	BLAZER All	
R	75-86	PICKUP 1/2 TON, C10 All	
R	73-86	PICKUP 1/2 TON, K10 All Exc. Lift Kit	
R	87	PICKUP 1/2 TON, R10 All	
R	87	PICKUP 1/2 TON, V10 All Exc. Lift Kit	
R	75-86	PICKUP 3/4 TON, C20 Standard Cab Pickup	
R	75-86	PICKUP 3/4 TON, K20 All Exc. Lift Kit	
R	87	PICKUP 3/4 TON, R20 Standard Cab Pickup	
R	87	PICKUP 3/4 TON, V20 All Exc. Quad Suspension and Lift Kit	
R	73-86	SUBURBAN 1/2 TON, C10 All	
R	73-86	SUBURBAN 1/2 TON, K10 All Exc. Lift Kit	
R	87-88	SUBURBAN 1/2 TON, R10 All	
R	89-91	SUBURBAN 1/2 TON, R1500 All	
R	89-91	SUBURBAN 1/2 TON, V1500 All Exc. Lift Kit	

Numerical listing

Shock	POP	Alternative No.	MTG Acc. Supplied
Pos.	Year	Application	
G63349	A (cont)		140357
R	73-86	SUBURBAN 3/4 TON, C20 All	
R	73-86	SUBURBAN 3/4 TON, K20 All Exc. Lift Kit	
R	87-88	SUBURBAN 3/4 TON, R20 All	
R	89-91	SUBURBAN 3/4 TON, R2500 All	
R	87-88	SUBURBAN 3/4 TON, V20 All Exc. Quad Suspension and Lift Kit	
R	89-91	SUBURBAN 3/4 TON, V2500 All Exc. Lift Kit	
R	73	VAN 1/2 TON, P SERIES All	
R	73-78	VAN 3/4 TON, P SERIES All	
R	73-91	GMC JIMMY All	
R	73-86	PICKUP 1/2 TON, C15 / C1500 All	
R	73-86	PICKUP 1/2 TON, K15 / K1500 All	
R	87	PICKUP 1/2 TON, R1500 All	
R	87	PICKUP 1/2 TON, V1500 All Exc. Lift Kit	
R	75-86	PICKUP 3/4 TON, C25 / C2500 Cab & Chassis	
R	75-86	PICKUP 3/4 TON, C25 / C2500 Standard Cab Pickup	
R	73-74	PICKUP 3/4 TON, C25 / C2500 All Exc. Crew Cab & Bonus Cab	
R	73-86	PICKUP 3/4 TON, K25 / K2500 All Exc. Lift Kit	
R	88-89	PICKUP 3/4 TON, R2500 All Exc. Crew Cab & Bonus Cab	
R	87	PICKUP 3/4 TON, R2500 Cab & Chassis Exc. Crew Cab & Bonus Cab	
R	87	PICKUP 3/4 TON, R2500 Standard Cab Pickup Exc. Crew Cab & Bonus Cab	
R	87	PICKUP 3/4 TON, V2500 All Exc. Lift Kit	
R	73-86	SUBURBAN 1/2 TON, C15 / C1500 All	
R	73-86	SUBURBAN 1/2 TON, K15 / K1500 All	
R	87-91	SUBURBAN 1/2 TON, R1500 All	
R	87-91	SUBURBAN 1/2 TON, V1500 All Exc. Lift Kit	
R	75-86	SUBURBAN 3/4 TON, C25 / C2500 All	
R	73-74	SUBURBAN 3/4 TON, C25 / C2500 All Exc. Crew Cab & Bonus Cab	
R	73-86	SUBURBAN 3/4 TON, K25 / K2500 All Exc. Lift Kit	
R	87-91	SUBURBAN 3/4 TON, R2500 All	
R	87-91	SUBURBAN 3/4 TON, V2500 All Exc. Lift Kit	
R	73	VAN 1/2 TON, P SERIES All	
R	73-78	VAN 3/4 TON, P SERIES All	
G63350	C		140126
R	66	FORD BRONCO All Thru Serial #830000	
R	70-79	PICKUP 1/2 TON, F-100 RWD	
R	75-79	PICKUP 1/2 TON, F-150 RWD	
R	75-79	PICKUP 1 TON, F-350 / SUPERDUTY Extended Cab Pickup, RWD	
R	67-74	PICKUP 1 TON, F-350 / SUPERDUTY RWD Supercab	
R	75-79	PICKUP 3/4 TON, F-250 / SUPERDUTY Cab & Chassis, RWD	
R	75-79	PICKUP 3/4 TON, F-250 / SUPERDUTY Standard Cab Pickup, RWD	
R	65-74	PICKUP 3/4 TON, F-250 / SUPERDUTY All RWD; Exc. Supercab	
R	75-91	VAN 1/2 TON, ECONOLINE / CLUB WAGON All	
F	71-80	INTERNATIONAL SCOUT II All	
G63353	C		
R	72-93	DODGE PICKUP 1/2 TON, D100 SERIES All	
R	72-93	PICKUP 1 TON, D300 SERIES All	
R	72-93	PICKUP 3/4 TON, D200 SERIES All	
R	75-93	RAMCHARGER RWD	
R	74	RAMCHARGER All	
R	76-81	PLYMOUTH TRAILDUSTER RWD	
R	74-75	TRAILDUSTER All	
G63355	A		140702
F	75-84	CHEVROLET BLAZER RWD	
F	69-74	BLAZER All RWD	
F	63-67	C10 PANEL All	
F	63-86	PICKUP 1/2 TON, C10 All	
F	87	PICKUP 1/2 TON, R10 All	
F	63-86	PICKUP 1 TON, C30 All	

Numerical listing

Shock	POP	Alternative No.	MTG Acc. Supplied
Pos.	Year	Application	
G63355 A (cont) 140702			
F	88-91	PICKUP 1 TON, C35/3500 Cab & Chassis Exc. HD Solid Front Axle	
F	87-88	PICKUP 1 TON, R30 All	
F	89	PICKUP 1 TON, R3500 Standard Cab Pickup	
F	63-86	PICKUP 3/4 TON, C20 All	
F	87-88	PICKUP 3/4 TON, R20 All	
F	89	PICKUP 3/4 TON, R2500 All	
F	63-66	SUBURBAN 1/2 TON, 1500 All	
F	67-86	SUBURBAN 1/2 TON, C10 All RWD	
F	87-88	SUBURBAN 1/2 TON, R10 All	
F	89-91	SUBURBAN 1/2 TON, R1500 All	
F	68-86	SUBURBAN 3/4 TON, C20 All	
F	87-88	SUBURBAN 3/4 TON, R20 All	
F	89-91	SUBURBAN 3/4 TON, R2500 All	
F	63-80	VAN 1/2 TON, P SERIES All	
F	68-90	VAN 1 TON, P SERIES All Cutaway Chassis	
F	68-89	VAN 3/4 TON, P SERIES All	
F	75-84	GMC JIMMY RWD	
F	70-74	JIMMY All RWD	
F	67-86	PICKUP 1/2 TON, C15 / C1500 All	
F	87	PICKUP 1/2 TON, R1500 All	
F	88-90	PICKUP 1 TON, C35/3500 Cab & Chassis Exc. HD Solid Front Axle	
F	67-78	PICKUP 1 TON, C35/3500 All	
F	87-91	PICKUP 1 TON, R3500 All	
F	85-86	PICKUP 3/4 TON, C25 / C2500 Crew Cab Pickup	
F	75-86	PICKUP 3/4 TON, C25 / C2500 Cab & Chassis	
F	75-86	PICKUP 3/4 TON, C25 / C2500 Standard Cab Pickup	
F	75-83	PICKUP 3/4 TON, C25 / C2500 Crew Cab Pickup	
F	67-74	PICKUP 3/4 TON, C25 / C2500 All	
F	87-89	PICKUP 3/4 TON, R2500 All Exc. Crew Cab & Bonus Cab	
F	63-66	PICKUP 1000 SERIES All	
F	63-66	PICKUP 1500 SERIES All	
F	66	PICKUP 2500 SERIES All	
F	68-86	SUBURBAN 1/2 TON, C15 / C1500 All	
F	87-91	SUBURBAN 1/2 TON, R1500 All	
F	68-86	SUBURBAN 3/4 TON, C25 / C2500 All	
F	87-91	SUBURBAN 3/4 TON, R2500 All	
F	67-80	VAN 1/2 TON, P SERIES All	
F	75-90	VAN 1 TON, P SERIES All Cutaway Chassis	
F	73-74	VAN 1 TON, P SERIES Base Cutaway Chassis	
F	68-72	VAN 1 TON, P SERIES All	
F	68-89	VAN 3/4 TON, P SERIES All	
F	63-65	VAN, PB 1000 SERIES All	
G63357 C			
F	71-95	CHEVROLET VAN 1/2 TON, G / EXPRESS All	
F	70	VAN 1/2 TON, G / EXPRESS All Independent Front Suspension	
F	76-96	VAN 1 TON, G / EXPRESS All	
F	75	VAN 1 TON, G / EXPRESS 146.0 / 370.8 (WheelBase)	
F	71-74	VAN 1 TON, G / EXPRESS All	
F	71-95	VAN 3/4 TON, G / EXPRESS All	
F	70	VAN 3/4 TON, G / EXPRESS All Independent Front Suspension	
F	71-95	GMC VAN 1/2 TON, G / SAVANA All	
F	70	VAN 1/2 TON, G / SAVANA All Independent Front Suspension	
F	76-95	VAN 1 TON, G / SAVANA All	
F	75	VAN 1 TON, G / SAVANA 146.0 / 370.8 (WheelBase)	
F	71-74	VAN 1 TON, G / SAVANA All	
F	78-95	VAN 3/4 TON, G / SAVANA All Exc. 8600# GVW	
F	71-77	VAN 3/4 TON, G / SAVANA All	
F	70	VAN 3/4 TON, G / SAVANA All Independent Front Suspension	
G63359 B 140126			
F	84-86	DODGE MINI RAM All	
F	72-93	PICKUP 1/2 TON, D100 SERIES All	
F	72-93	PICKUP 3/4 TON, D200 SERIES All Exc. Heavy Duty Package	
F	75-93	RAMCHARGER RWD	
F	99-03	VAN 1/2 TON, A / B SERIES / RAM 109.3 / 277.6 (WheelBase) Exc. 7000# GVW	
F	81-98	VAN 1/2 TON, A / B SERIES / RAM 109.6 / 278.4 (WheelBase) Exc. 7000# GVW	

Ultra Truck Shock

Shock	POP	Alternative No.	MTG Acc. Supplied
Pos.	Year	Application	
G63359 B (cont) 140126			
F	71-80	VAN 1/2 TON, A / B SERIES / RAM All Exc. 4000# Front Axle	
F	95-03	VAN 1 TON, A / B SERIES / RAM All	
F	71-94	VAN 1 TON, A / B SERIES / RAM All Exc. 4000# Front Axle	
F	81-03	VAN 3/4 TON, A / B SERIES / RAM All	
F	71-80	VAN 3/4 TON, A / B SERIES / RAM All Exc. 4000# Front Axle	
F	74-80	VAN, CB300 All Exc. 4000# Front Axle	
F	75-81	PLYMOUTH TRAILDUSTER RWD	
F	74-83	VAN 1/2 TON, PB SERIES All	
F	74-83	VAN 1 TON, PB SERIES All Exc. 4000# Front Axle	
F	74-83	VAN 3/4 TON, PB SERIES All	
G63360 D 140126			
F	72-93	DODGE PICKUP 1 TON, D300 SERIES All Heavy Duty Package	
F	72-93	PICKUP 3/4 TON, D200 SERIES All Heavy Duty Package	
F	71-93	VAN 1 TON, A / B SERIES / RAM All 4000# Front Axle	
F	74-80	VAN, CB300 All 4000# Front Axle	
F	74-83	PLYMOUTH VAN 1 TON, PB SERIES All 4000# Front Axle	
G63366 A			
R	75-86	CHEVROLET PICKUP 1 TON, C30 All	
R	88-91	PICKUP 1 TON, C35/3500 Cab & Chassis Exc. HD Solid Front Axle	
R	87-88	PICKUP 1 TON, R30 All	
R	89	PICKUP 1 TON, R3500 Standard Cab Pickup	
R	75-86	PICKUP 3/4 TON, C20 Crew Cab Pickup	
R	87-88	PICKUP 3/4 TON, R20 Crew Cab Pickup	
R	89	PICKUP 3/4 TON, R2500 All	
R	74-80	VAN 1/2 TON, P SERIES All	
R	73-99	VAN 1 TON, P SERIES All	
R	79-89	VAN 3/4 TON, P SERIES All	
R	88-91	GMC PICKUP 1 TON, C35/3500 Cab & Chassis Exc. HD Solid Front Axle	
R	73-78	PICKUP 1 TON, C35/3500 All	
R	87-91	PICKUP 1 TON, R3500 All	
R	85-86	PICKUP 3/4 TON, C25 / C2500 Crew Cab Pickup	
R	75-83	PICKUP 3/4 TON, C25 / C2500 Crew Cab Pickup	
R	73-74	PICKUP 3/4 TON, C25 / C2500 All Crew Cab	
R	87-89	PICKUP 3/4 TON, R2500 Crew Cab Pickup	
R	74-80	VAN 1/2 TON, P SERIES All	
R	73-99	VAN 1 TON, P SERIES All	
R	79-89	VAN 3/4 TON, P SERIES All	
G63375 A 140780,142615			
F	85-05	CHEVROLET ASTRO RWD	
F	81	BEL AIR Sedan Police and Taxi Models	
F	71-75	BEL AIR Sedan Police and Taxi Models	
F	71-72	BISCAYNE All	
F	73-96	CAPRICE Sedan Police and Taxi Models	
F	71-72	CAPRICE All Police and Taxi Models	
F	83-85	IMPALA All Police and Taxi Models	
F	71-82	IMPALA Sedan Police and Taxi Models	
F	96-02	VAN 1/2 TON, G / EXPRESS All	
F	96-02	VAN 1 TON, G / EXPRESS All	
F	96-02	VAN 3/4 TON, G / EXPRESS All Exc. 8600# GVW	
F	93-02	FORD CROWN VICTORIA Police Interceptor	
F	85-05	GMC SAFARI RWD	
F	96-02	VAN 1/2 TON, G / SAVANA RWD	
F	96-02	VAN 1 TON, G / SAVANA All	
F	96-02	VAN 3/4 TON, G / SAVANA All Exc. 8600# GVW	
G63377 B 141137			
R	78-79	FORD BRONCO All	
R	66-77	BRONCO All From Serial #830001	
R	65-69	PICKUP 1/2 TON, F-100 All RWD	
R	75-79	PICKUP 1 TON, F-350 / SUPERDUTY Standard Cab Pickup, RWD	
R	73-74	PICKUP 1 TON, F-350 / SUPERDUTY All RWD; Supercab	

Numerical listing

Shock	POP	Alternative No.	MTG Acc. Supplied
Pos.	Year	Application	
G63377 B (cont) 141137			
R	75-79	PICKUP 3/4 TON, F-250 / SUPERDUTY Extended Cab Pickup, RWD	
R	65-74	PICKUP 3/4 TON, F-250 / SUPERDUTY All RWD; Supercab	
R	69-74	VAN 1/2 TON, ECONOLINE / CLUB WAGON All	
R	69-74	VAN 1 TON, ECONOLINE / CLUB WAGON / SUPERDUTY All	
R	69-74	VAN 3/4 TON, ECONOLINE / CLUB WAGON / SUPERDUTY All	
R	76-83	JEEP CHEROKEE All	
F	74-83	CHEROKEE All	
F	82-83	CJ5 All	
F	82-86	CJ7 All	
F	93	GRAND WAGONEER All	
R	93	GRAND WAGONEER All	
F	84-91	GRAND WAGONEER All	
R	84-91	GRAND WAGONEER All	
F	74-88	J10 PICKUP All	
F	74-88	J10 PICKUP All	
F	74-88	J20 PICKUP All	
F	82-85	SCRAMBLER / CJ8 All	
R	76-83	WAGONEER All	
F	74-83	WAGONEER All	
G63386 C 140780			
F	66-77	FORD BRONCO All From Serial #830001; Exc. Lift Kit RWD, 4WD Quad Suspension Rearward of Front Axle, Non Quad Suspension	
F	75-79	PICKUP 1/2 TON, F-100 RWD RWD, 4WD Quad Suspension Rearward of Front Axle, Non Quad Suspension	
F	65-74	PICKUP 1/2 TON, F-100 All RWD, 4WD Quad Suspension Rearward of Front Axle, Non Quad Suspension	
F	75-79	PICKUP 1/2 TON, F-150 RWD RWD, 4WD Quad Suspension Rearward of Front Axle, Non Quad Suspension	
F	75-79	PICKUP 1 TON, F-350 / SUPERDUTY RWD RWD, 4WD Quad Suspension Rearward of Front Axle, Non Quad Suspension	
F	67-74	PICKUP 1 TON, F-350 / SUPERDUTY All RWD, 4WD Quad Suspension Rearward of Front Axle, Non Quad Suspension	
F	75-79	PICKUP 3/4 TON, F-250 / SUPERDUTY RWD RWD, 4WD Quad Suspension Rearward of Front Axle, Non Quad Suspension	
F	65-74	PICKUP 3/4 TON, F-250 / SUPERDUTY All RWD, 4WD Quad Suspension Rearward of Front Axle, Non Quad Suspension	
F	75-91	VAN 1 TON, ECONOLINE / CLUB WAGON / SUPERDUTY All Cutaway Chassis RWD, 4WD Quad Suspension Rearward of Front Axle, Non Quad Suspension	
F	75-91	VAN 3/4 TON, ECONOLINE / CLUB WAGON / SUPERDUTY All RWD, 4WD Quad Suspension Rearward of Front Axle, Non Quad Suspension	
G63387 D 140126			
R	70-76	FORD PICKUP 1/2 TON, F-100 4WD	
R	76-79	PICKUP 1/2 TON, F-150 4WD	
R	79	PICKUP 1 TON, F-350 / SUPERDUTY 4WD	
R	77-79	PICKUP 3/4 TON, F-250 / SUPERDUTY Cab & Chassis, 4WD All From Serial No. Y20001	
R	77-79	PICKUP 3/4 TON, F-250 / SUPERDUTY Standard Cab Pickup, 4WD All From Serial No. Y20001	
R	75-91	VAN 1 TON, ECONOLINE / CLUB WAGON / SUPERDUTY All Cutaway Chassis	
R	75-91	VAN 3/4 TON, ECONOLINE / CLUB WAGON / SUPERDUTY All	
G63394 D 140702			
F	85-99	CHEVROLET VAN 1 TON, P SERIES All Motorhome Chassis w/ Independent Front Suspension	
F	74-84	VAN 1 TON, P SERIES All Motorhome Chassis	

Numerical listing

Shock	POP	Alternative No.	MTG Acc. Supplied
Pos.	Year	Application	
G63394	D (cont)		140702
F 85-99	GMC	VAN 1 TON, P SERIES All Motorhome Chassis w/ Independent Front Suspension	
F 75-84	VAN	1 TON, P SERIES All Motorhome Chassis	
F 74	VAN	1 TON, P SERIES Motorhome	
G63403	B		
R 79-91	CHEVROLET	VAN 1 TON, G / EXPRESS All 9200# GVW	
F 85	VAN	1 TON, P SERIES All Motorhome Chassis w/ I-Beam Front Suspension	
R 97-04	DODGE	DAKOTA All	
R 98-03	DURANGO	All	
R 93-96	GMC	VAN 1 TON, G / SAVANA Cutaway Van 9200# GVW	
R 79-91	VAN	1 TON, G / SAVANA Cutaway Van 9200# GVW	
F 85	VAN	1 TON, P SERIES All Motorhome Chassis w/ I-Beam Front Suspension	
G63404	W		141349
F 84-85	TOYOTA	4RUNNER All	
F 80-85	PICKUP	4WD Exc. Lift Kit	
G63405	D		140884
F 55-56	CHEVROLET	PICKUP All	
F 48-52	FORD	F-1 All	
F 48-52	F-2	All	
F 48-52	F-3	All	
R 61-64	PICKUP	1/2 TON, F-100 All	
R 61-66	PICKUP	1 TON, F-350 / SUPERDUTY All	
R 61-64	PICKUP	3/4 TON, F-250 / SUPERDUTY All	
R 68	INTERNATIONAL	908C All	
R 68	1000C	All Exc. 166" Wheelbase	
F 68	1100C	All Exc. 166" Wheelbase	
F 68	1100C	All Exc. 166" Wheelbase	
F 68	1200C	All Exc. 166" Wheelbase	
F 68	1200C	All Exc. 166" Wheelbase	
F 68	1300C	All Exc. 166" Wheelbase	
F 68	1300C	All Exc. 166" Wheelbase	
R 65	JEEP	CJ3 All Exc. Lift Kit	
R 65-83	CJ5	All Exc. Lift Kit	
R 65-75	CJ6	All Exc. Lift Kit	
R 76-86	CJ7	All Exc. Lift Kit	
R 66-74	DJ5	All Exc. Lift Kit	
R 66-68	DJ6	All Exc. Lift Kit	
R 57-60	FC150	All	
F 63-65	FC170	All	
R 63-65	FC170	All	
R 63-66	GLADIATOR	All Independent Front Suspension	
R 70-71	JEEPSTER	All	
R 81-85	SCRAMBLER	/ CJ8 All	
R 65-67	UNIVERSAL	All Exc. Lift Kit	
R 61-64	UNIVERSAL	All	
G63409	W		
R 80-96	FORD	BRONCO All Exc. Lift Kit	
R 80-83	PICKUP	1/2 TON, F-100 RWD	
R 80-84	PICKUP	1/2 TON, F-150 RWD	
R 80-97	PICKUP	1 TON, F-350 / SUPERDUTY RWD Dual Rear Wheels	
G63410	D		141047
F 80-96	FORD	BRONCO All Quad Suspension; Forward of Front Axle; Exc. Lift Kit	
F 80-96	PICKUP	1/2 TON, F-150 4WD Quad Suspension; Forward of Front Axle; Exc. Lift Kit	
F 80-81	PICKUP	1 TON, F-350 / SUPERDUTY 4WD	
F 80-82	PICKUP	3/4 TON, F-250 / SUPERDUTY Standard Cab Pickup, 4WD	
G63411	C		
F 77-86	CHEVROLET	PICKUP 1 TON, K30 All	
F 90-91	PICKUP	1 TON, R3500 All	
F 89	PICKUP	1 TON, R3500 Cab & Chassis	
F 89	PICKUP	1 TON, R3500 Crew Cab Pickup	
F 87-88	PICKUP	1 TON, V30 All	
F 89-91	PICKUP	1 TON, V3000 / V3500 All	
F 77-86	GMC	PICKUP 1 TON, K35 / K3500 All	
F 87-91	PICKUP	1 TON, V3000 / V3500 All	

Ultra Truck Shock

Shock	POP	Alternative No.	MTG Acc. Supplied
Pos.	Year	Application	
G63413	B		
R 78-95	CHEVROLET	VAN 1/2 TON, G / EXPRESS All	
R 85-95	VAN	1 TON, G / EXPRESS Extended Cargo Van	
R 85-95	VAN	1 TON, G / EXPRESS Extended Passenger Van	
R 78-95	VAN	1 TON, G / EXPRESS Standard Cargo Van	
R 78-95	VAN	1 TON, G / EXPRESS Standard Passenger Van	
R 78	VAN	1 TON, G / EXPRESS Extended Cargo Van	
R 78-95	VAN	3/4 TON, G / EXPRESS All Exc. 8600# GVW	
R 84-86	DODGE	MINI RAM All	
R 99-03	VAN	1/2 TON, A / B SERIES / RAM 109.3 / 277.6 (WheelBase) Exc. 7000# GVW	
R 81-98	VAN	1/2 TON, A / B SERIES / RAM 109.6 / 278.4 (WheelBase) Exc. 7000# GVW	
R 71-80	VAN	1/2 TON, A / B SERIES / RAM All	
R 95-03	VAN	1 TON, A / B SERIES / RAM All	
R 94	VAN	1 TON, A / B SERIES / RAM All Exc. 4000# Front Axle	
R 71-93	VAN	1 TON, A / B SERIES / RAM All	
R 71-03	VAN	3/4 TON, A / B SERIES / RAM All	
R 74-80	VAN	CB300 All	
R 78-95	GMC	VAN 1/2 TON, G / SAVANA All	
R 85-96	VAN	1 TON, G / SAVANA Extended Cargo Van	
R 85-96	VAN	1 TON, G / SAVANA Extended Passenger Van	
R 79-96	VAN	1 TON, G / SAVANA Standard Cargo Van	
R 79-96	VAN	1 TON, G / SAVANA Standard Passenger Van	
R 78	VAN	1 TON, G / SAVANA Cutaway Van	
R 78-95	VAN	3/4 TON, G / SAVANA All Exc. 8600# GVW	
R 74-83	PLYMOUTH	VAN 1/2 TON, PB SERIES All	
R 74-83	VAN	1 TON, PB SERIES All	
R 74-83	VAN	3/4 TON, PB SERIES All	
G63414	A		140780
F 80-96	FORD	BRONCO All Rearward of Front Axle; Exc. Lift Kit	
F 89	BRONCO	II All Mfg. to 2/89; Vehicles w/ 10mm & 12mm bolt in rear lower mount	
F 84-88	BRONCO	II All w/ 10mm Bolt In Rear Lower Mount	
F 97	F-250	HD RWD	
F 80-83	PICKUP	1/2 TON, F-100 RWD	
F 80-96	PICKUP	1/2 TON, F-150 4WD Rearward of Front Axle; Exc. Lift Kit	
F 80-96	PICKUP	1/2 TON, F-150 RWD	
F 80-97	PICKUP	1 TON, F-350 / SUPERDUTY RWD	
F 97	PICKUP	3/4 TON, F-250 / SUPERDUTY RWD Over 8500# GVW	
F 80-96	PICKUP	3/4 TON, F-250 / SUPERDUTY RWD	
F 87-89	RANGER	All Exc. High Ryder Option	
F 83-86	RANGER	All	
G63418	W		141356
F 83-86	DODGE	PICKUP, RAM 50 4WD	
F 83-94	MITSUBISHI	MIGHTY MAX 4WD	
F 83-91	MONTERO	All	
G63419	W		
R 87-93	DODGE	PICKUP, RAM 50 4WD	
R 83-94	MITSUBISHI	MIGHTY MAX 4WD	
G63421	A		140455
F 05	CHEVROLET	BLAZER Base, RWD	
F 96-04	BLAZER	LS, RWD	
F 95-02	BLAZER	LT, RWD	
F 95-99	BLAZER	Base, RWD	
F 95-97	BLAZER	Deluxe, RWD	
F 83-94	BLAZER	, S MODELS RWD	
F 94-03	S10	LS, RWD	
F 82-03	S10	Base, RWD	
F 99	S10	Xtreme, RWD	
F 92-93	S10	EL, RWD	
F 83-92	S10	Tahoe, RWD	
F 88-90	S10	Durango, RWD	
F 82-86	S10	Durango, RWD	

Numerical listing

Shock	POP	Alternative No.	MTG Acc. Supplied
Pos.	Year	Application	
G63421	A (cont)		140455
F 72-82	FORD	COURIER All	
F 92-04	GMC	JIMMY RWD	
F 83-91	S15	JIMMY RWD	
F 04	SONOMA	/ S15 All RWD	
F 82-03	SONOMA	/ S15 RWD	
F 78-87	SPRINT	/ CABALLERO RWD	
F 71-77	SPRINT	/ CABALLERO All	
F 96-00	ISUZU	HOMBRE RWD Exc. Sport Chassis	
F 72-76	MAZDA	B1600 All	
F 77-78	B1800	All	
F 79-84	B2000	All	
F 82-84	B2200	All	
G63422	A		
R 05	CHEVROLET	BLAZER Base, 4WD	
R 05	BLAZER	Base, RWD	
R 96-04	BLAZER	LS, 4WD	
R 96-04	BLAZER	LS, RWD	
R 95-02	BLAZER	LT, RWD	
R 95-01	BLAZER	LT, 4WD	
R 95-99	BLAZER	Base, 4WD	
R 95-99	BLAZER	Base, RWD	
R 95-97	BLAZER	Deluxe, RWD	
R 83-94	BLAZER	, S MODELS All	
R 94-04	S10	LS, 4WD	
R 83-03	S10	Base, 4WD	
R 92-93	S10	EL, 4WD	
R 83-92	S10	Tahoe, 4WD	
R 88-90	S10	Durango, 4WD	
R 83-86	S10	Durango, 4WD	
R 05	GMC	JIMMY 4WD	
R 92-04	JIMMY	All	
R 83-91	S15	JIMMY All	
R 82-04	SONOMA	/ S15 All	
R 91	SYCLONE	All	
R 92-93	TYPHOON	All	
R 96-00	ISUZU	HOMBRE All	
R 96-01	OLDSMOBILE	BRAVADA All	
R 91-94	BRAVADA	All	
G63423	A		
F 05	CHEVROLET	BLAZER Base, 4WD	
F 96-04	BLAZER	LS, 4WD	
F 95-01	BLAZER	LT, 4WD	
F 95-99	BLAZER	Base, 4WD	
F 83-94	BLAZER	, S MODELS 4WD	
F 94-04	S10	LS, 4WD	
F 83-03	S10	Base, 4WD	
F 92-93	S10	EL, 4WD	
F 83-92	S10	Tahoe, 4WD	
F 88-90	S10	Durango, 4WD	
F 83-86	S10	Durango, 4WD	
F 92-05	GMC	JIMMY 4WD	
F 83-91	S15	JIMMY 4WD	
F 83-04	SONOMA	/ S15 4WD	
F 91	SYCLONE	All	
F 92-93	TYPHOON	All	
F 00	ISUZU	HOMBRE 4WD	
F 96-99	HOMBRE	All Sport Chassis	
F 96-01	OLDSMOBILE	BRAVADA All	
F 91-94	BRAVADA	All	
G63424	B		141353,142592
F 84-01	JEEP	CHEROKEE All	
F 86-92	COMANCHE	All	
F 93-98	GRAND	CHEROKEE All	
F 84-90	WAGONEER	All	
G63425	C		
R 84-01	JEEP	CHEROKEE All	
R 84-90	WAGONEER	All	
G63426	W		
R 90-95	CHRYSLER	TOWN & COUNTRY All	
R 84-95	DODGE	CARAVAN / GRAND CARAVAN All	
R 87-88	MINI	RAM All	
R 84-95	PLYMOUTH	VOYAGER / GRAND VOYAGER All	
G63432	W		141349,140169
F 88-90	TOYOTA	LAND CRUISER All	
F 81-87	LAND CRUISER	FJ60 (MfrBodyCode), Sport Utility	
G63443	C		
R 82-83	JEEP	CJ5 All 2" Lift Kit	
F 66-81	CJ5	All 2 - 4" Lift Kit	
F 66-75	CJ6	All 2 - 4" Lift Kit	
R 82-86	CJ7	All 2" Lift Kit	
F 76-81	CJ7	All 2 - 4" Lift Kit	
F 66-74	DJ5	All 2 - 4" Lift Kit	
F 66-68	DJ6	All 2 - 4" Lift Kit	

Numerical listing

Shock	POP	Alternative No.	MTG Acc. Supplied
Pos.	Year	Application	
G63443	C (cont)		141277
F	65-67	UNIVERSAL All 2 - 4" Lift Kit	
G63454	B		
R	90-05	CHEVROLET ASTRO All	
R	85-89	ASTRO RWD	
R	90-05	GMC SAFARI All	
R	85-89	SAFARI RWD	
R	86-89	VOLKSWAGEN VANAGON 4WD	
G63455	C		
F	97	FORD F-250 HD 4WD	
F	86-97	PICKUP 1 TON, F-350 / SUPERDUTY 4WD	
F	97-98	PICKUP 3/4 TON, F-250 / SUPERDUTY 4WD Over 8500# GVW	
F	87-96	PICKUP 3/4 TON, F-250 / SUPERDUTY 4WD	
G63456	W		
R	86-97	FORD PICKUP 1 TON, F-350 / SUPERDUTY 4WD Exc. Dual Rear Wheels	
G63461	B		
R	97	FORD F-250 HD 4WD	
R	80-96	PICKUP 1/2 TON, F-150 4WD Exc. Lift Kit	
R	86-97	PICKUP 1 TON, F-350 / SUPERDUTY 4WD Dual Rear Wheels	
R	82-85	PICKUP 1 TON, F-350 / SUPERDUTY 4WD Clevis Type Lower Front Mount; Exc. Dual Rear Wheels or Lift Kit	
R	80-81	PICKUP 1 TON, F-350 / SUPERDUTY 4WD	
R	97	PICKUP 3/4 TON, F-250 / SUPERDUTY 4WD Over 8500# GVW	
R	86-96	PICKUP 3/4 TON, F-250 / SUPERDUTY 4WD	
R	82-85	PICKUP 3/4 TON, F-250 / SUPERDUTY 4WD Clevis Type Lower Front Mount; Exc. Dual Rear Wheels or Lift Kit	
R	80-81	PICKUP 3/4 TON, F-250 / SUPERDUTY 4WD	
G63479	W		140524
F	86-89	TOYOTA 4RUNNER All	
F	86-95	PICKUP 4WD Exc. Lift Kit	
F	93-98	T100 4WD	
G63488	A		
R	88-02	CHEVROLET PICKUP 1/2 TON, C15 / C1500 All	
R	88-99	PICKUP 1/2 TON, K15 / K1500 All	
R	92-00	PICKUP 1 TON, C35/3500 Crew Cab Pickup Exc. HD Straight Front Axle	
R	92-00	PICKUP 1 TON, C35/3500 Standard Cab Pickup Exc. HD Straight Front Axle	
R	88-00	PICKUP 1 TON, C35/3500 Extended Cab Pickup Exc. HD Straight Front Axle	
R	88-90	PICKUP 1 TON, C35/3500 Standard Cab Pickup Exc. HD Straight Front Axle	
R	88-00	PICKUP 1 TON, K35 / K3500 All	
R	88-00	PICKUP 3/4 TON, C25 / C2500 All	
R	88-00	PICKUP 3/4 TON, K25 / K2500 All	
R	88-99	GMC PICKUP 1/2 TON, C15 / C1500 All	
R	88-99	PICKUP 1/2 TON, K15 / K1500 All	
R	92-00	PICKUP 1 TON, C35/3500 Crew Cab Pickup Exc. HD Straight Front Axle	
R	88-00	PICKUP 1 TON, C35/3500 Extended Cab Pickup Exc. HD Straight Front Axle	
R	88-00	PICKUP 1 TON, C35/3500 Standard Cab Pickup Exc. HD Straight Front Axle	
R	88-00	PICKUP 1 TON, K35 / K3500 All	
R	88-00	PICKUP 3/4 TON, C25 / C2500 All	
R	88-00	PICKUP 3/4 TON, K25 / K2500 All	
G63489	A		141277
F	88-02	CHEVROLET PICKUP 1/2 TON, C15 / C1500 All	
F	92-00	PICKUP 1 TON, C35/3500 Crew Cab Pickup Exc. HD Straight Front Axle	

Ultra Truck Shock

Shock	POP	Alternative No.	MTG Acc. Supplied
Pos.	Year	Application	
G63489	A (cont)		141277
F	88-00	PICKUP 1 TON, C35/3500 Extended Cab Pickup Exc. HD Straight Front Axle	
F	88-00	PICKUP 1 TON, C35/3500 Standard Cab Pickup Exc. HD Straight Front Axle	
F	88-00	PICKUP 3/4 TON, C25 / C2500 All	
F	92-99	SUBURBAN 1/2 TON, C15 / C1500 All	
F	92-99	SUBURBAN 3/4 TON, C25 / C2500 All	
F	95-00	TAHOE RWD Old Body Style	
F	88-99	GMC PICKUP 1/2 TON, C15 / C1500 All	
F	92-00	PICKUP 1 TON, C35/3500 Crew Cab Pickup Exc. HD Straight Front Axle	
F	88-00	PICKUP 1 TON, C35/3500 Extended Cab Pickup Exc. HD Straight Front Axle	
F	88-00	PICKUP 1 TON, C35/3500 Standard Cab Pickup Exc. HD Straight Front Axle	
F	88-00	PICKUP 3/4 TON, C25 / C2500 All	
F	92-99	SUBURBAN 1/2 TON, C15 / C1500 All	
F	92-99	SUBURBAN 3/4 TON, C25 / C2500 All	
F	92-99	YUKON RWD	
G63490	W		
R	86-88	FORD AEROSTAR RWD	
R	87-95	JEEP WRANGLER YJ (MfrBodyCode)	
G63492	A		141137
R	81-82	CHEVROLET LUV PICKUP All	
R	61-67	FORD ECONOLINE All	
F	81-95	ISUZU PICKUP RWD	
R	86-92	JEEP COMANCHE All	
F	66-73	WAGONEER All	
F	63-65	WAGONEER All Exc. Independent Front Suspension	
R	83-89	MINIBUS MONTERO 2.6L 4Cyl L (156)	
R	97-99	MONTERO SPORT All	
R	82-86	NISSAN 720 PICKUP 4WD	
R	00-04	FRONTIER Crew Cab Pickup, RWD w/ Desert Runner	
R	98-04	FRONTIER 4WD	
R	98-99	FRONTIER RWD Crew Cab; w/ Desert Runner Package	
R	87-95	PATHFINDER All Exc. Electronic Adjustable Suspension	
R	87-97	PICKUP 4WD	
R	86	PICKUP 4WD Mfg. from 8/86	
R	00-04	XTERRA All	
R	84-87	TOYOTA LAND CRUISER FJ60 (MfrBodyCode), Sport Utility	
R	76-83	LAND CRUISER All	
R	75	LAND CRUISER All Mfg. from 1/75	
R	69-74	LAND CRUISER All	
R	85-92	PICKUP RWD 1 Ton	
R	80-83	PICKUP 4WD Exc. Lift Kit	
G63494	B		140149
R	84-89	TOYOTA 4RUNNER All	
R	84-95	PICKUP 4WD Exc. Lift Kit	
R	98-04	TACOMA Pre Runner, RWD Exc. Heavy Duty Upgrade	
R	95-04	TACOMA 4WD Exc. Heavy Duty Upgrade	
G63495	W		141350
F	87-91	ISUZU TROOPER 4WD	
F	86-87	MAZDA B2000 RWD	
F	87-93	B2200 RWD	
F	87-93	B2600 RWD	
G63506	W		141448
F	99	LAND ROVER DISCOVERY SD	
F	99	DISCOVERY SE7	
F	94-98	DISCOVERY All	
F	94-95	RANGE ROVER Air (RearSpringType)	
G63510	W		140149
R	88-90	TOYOTA LAND CRUISER All	
G63511	C		141353
F	78-79	FORD BRONCO All Quad Suspension Forward, Non Quad Suspension Left	

Numerical listing

Shock	POP	Alternative No.	MTG Acc. Supplied
Pos.	Year	Application	
G63511	C (cont)		141353
F	78-79	PICKUP 1/2 TON, F-150 Custom, 4WD Quad Suspension Forward, Non Quad Suspension Left	
F	78-79	PICKUP 1/2 TON, F-150 Ranger Lariat, 4WD Quad Suspension Forward, Non Quad Suspension Left	
F	78-79	PICKUP 1/2 TON, F-150 Ranger, 4WD Quad Suspension Forward, Non Quad Suspension Left	
F	78	PICKUP 1/2 TON, F-150 Base, 4WD Quad Suspension Forward, Non Quad Suspension Left	
F	78	PICKUP 1/2 TON, F-150 Northland, 4WD Quad Suspension Forward, Non Quad Suspension Left	
F	87-95	JEEP WRANGLER YJ (MfrBodyCode) 4WD Quad Suspension Forward of Front Axle Non Quad Suspension	
G63524	W		
R	89-97	FORD RANGER 4WD	
R	95-96	MAZDA B2300 4WD	
R	94-97	B3000 4WD	
R	94-97	B4000 4WD	
G63525	B		
R	90	FORD BRONCO II All	
R	89	BRONCO II All Mfg. from 2/89; Vehicles w/ 12mm bolt in rear lower mount	
R	90-97	RANGER RWD	
R	89	RANGER RWD Mfg. from 2/89; Vehicles w/ 12mm bolt in rear lower mount	
R	94-97	MAZDA B2300 RWD	
R	94-97	B3000 RWD	
R	94-97	B4000 RWD	
G63547	W		141350
F	90-95	TOYOTA 4RUNNER All	
G63548	D		140921
R	90-95	TOYOTA 4RUNNER All	
G63604	W		
R	89-91	MITSUBISHI MONTERO 3.0L 6Cyl V (181), 3.59 91.1(Bore)2.99 76.0(Stroke)	
G63605	W		140169
F	74	DODGE M300 All	
F	74	M350 All	
G63607	W		140719
R	00-05	FORD EXCURSION RWD	
R	91-94	EXPLORER All	
R	91-94	MAZDA NAVAJO All	
G63608	W		140780
F	91-94	FORD EXPLORER All	
F	91-94	MAZDA NAVAJO All	
G63609	A		
F	99-00	CADILLAC ESCALADE All	
F	92-94	CHEVROLET BLAZER 4WD Full Size	
F	88-00	PICKUP 1 TON, K35 / K3500 All	
F	88-00	PICKUP 3/4 TON, K25 / K2500 All	
F	92-99	SUBURBAN 1/2 TON, K15 / K1500 All	
F	92-99	SUBURBAN 3/4 TON, K25 / K2500 All	
F	95-00	TAHOE 4WD Old Body Style	
F	88-00	GMC PICKUP 1 TON, K35 / K3500 All	
F	88-00	PICKUP 3/4 TON, K25 / K2500 All	
F	92-99	SUBURBAN 1/2 TON, K15 / K1500 All	
F	92-99	SUBURBAN 3/4 TON, K25 / K2500 All	
F	92-99	YUKON 4WD	
G63610	C		142389
F	49-52	CHEVROLET FLEETLINE All	
F	49-52	FLEETLINE TRUCK All	
R	94-97	HONDA PASSPORT All	
R	91-97	ISUZU RODEO All	
R	98-03	TOYOTA SIENNA All	
G63611	D		140524
F	90-92	DAIHATSU ROCKY All	
F	94-02	HONDA PASSPORT All	
F	98-00	ISUZU AMIGO All	
F	02-04	AXIOM All	
F	91-04	RODEO All	

Numerical listing

Shock	POP	Alternative No.	MTG Acc. Supplied
Pos.	Year	Application	
G63614	B		140780
F 90		FORD BRONCO II All	
F 00-05		EXCURSION RWD	
F 90-97		RANGER All	
F 94-97		MAZDA B2300 All	
F 94-97		B3000 All	
F 94-97		B4000 All	
G63615	W		142657
F 95		LAND ROVER RANGE ROVER All	
F 94		RANGE ROVER Coil (RearSpringType)	
F 96-97		LEXUS LX450 All	
F 91-97		TOYOTA LAND CRUISER All	
G63616	W		140169,142656
R 96-97		LEXUS LX450 All	
R 93-97		TOYOTA LAND CRUISER All	
R 91-92		LAND CRUISER FJ80 (MfrBodyCode)	
G63620	D		141405
R 91-97		TOYOTA PREVIA All	
G63622	A		142617
F 03-24		COACH HOUSE PLATINUM All Motorhomes with Ford E450 Chassis	
F 23-24		PLATINUM IV All Motorhomes with Ford E450 Chassis	
F 23-24		COACHMEN CONCORD All MotorHomes with Ford E350 or E450 Chassis	
F 07-19		CONCORD All MotorHomes with Ford E350 or E450 Chassis	
F 09		FREEDOM EXPRESS All MotorHomes with Ford E350 or E450 Chassis	
F 08-24		FREELANDER All MotorHomes with Ford E350 or E450 Chassis	
F 11-24		LEPRECHAUN All MotorHomes with Ford E350 or E450 Chassis	
F 08-09		LEPRECHAUN All MotorHomes with Ford E350 or E450 Chassis	
F 00-06		FORD ECONOLINE All	
F 99-24		PICKUP 1 TON, F-350 / SUPERDUTY RWD	
F 11-16		PICKUP 1 TON, F-350 / SUPERDUTY All Exc. Off Road	
F 99-09		PICKUP 1 TON, F-350 / SUPERDUTY All Exc. Off Road	
F 23-24		PICKUP 3/4 TON, F-250 / SUPERDUTY RWD	
F 11-22		PICKUP 3/4 TON, F-250 / SUPERDUTY RWD Exc. Off Road	
F 99-10		PICKUP 3/4 TON, F-250 / SUPERDUTY RWD	
F 99-09		PICKUP 3/4 TON, F-250 / SUPERDUTY RWD Exc. Off Road	
F 08-14		VAN 1/2 TON, ECONOLINE / CLUB WAGON All	
F 21-24		VAN 1 TON, ECONOLINE / CLUB WAGON / SUPERDUTY All	
F 08-19		VAN 1 TON, ECONOLINE / CLUB WAGON / SUPERDUTY All	
F 07		VAN 1 TON, ECONOLINE / CLUB WAGON / SUPERDUTY All Exc. Cutaway Chassis	
F 99-06		VAN 1 TON, ECONOLINE / CLUB WAGON / SUPERDUTY All	
F 92-05		VAN 1 TON, ECONOLINE / CLUB WAGON / SUPERDUTY All Cutaway Chassis	
F 92-14		VAN 3/4 TON, ECONOLINE / CLUB WAGON / SUPERDUTY All	
F 25		THOR MOTOR COACH FOUR WINDS 282	
F 07-13		WINNEBAGO ACCESS All MotorHomes with Ford E350 or E450 Chassis	
F 14		ACCESS PREMIER All MotorHomes with Ford E350 or E450 Chassis	
G63623	A		142617
R 03-24		COACH HOUSE PLATINUM All Motorhomes with Ford E450 Chassis	
R 23-24		PLATINUM IV All Motorhomes with Ford E450 Chassis	
R 23-24		COACHMEN CONCORD All MotorHomes with Ford E350 or E450 Chassis	
R 07-19		CONCORD All MotorHomes with Ford E350 or E450 Chassis	
R 09		FREEDOM EXPRESS All MotorHomes with Ford E350 or E450 Chassis	

Ultra Truck Shock

Shock	POP	Alternative No.	MTG Acc. Supplied
Pos.	Year	Application	
G63623	A (cont)		142617
R 08-24		FREELANDER All MotorHomes with Ford E350 or E450 Chassis	
R 11-24		LEPRECHAUN All MotorHomes with Ford E350 or E450 Chassis	
R 08-09		LEPRECHAUN All MotorHomes with Ford E350 or E450 Chassis	
R 00-06		FORD ECONOLINE All	
R 08-14		VAN 1/2 TON, ECONOLINE / CLUB WAGON All	
R 21-24		VAN 1 TON, ECONOLINE / CLUB WAGON / SUPERDUTY All	
R 12-19		VAN 1 TON, ECONOLINE / CLUB WAGON / SUPERDUTY All	
R 04-11		VAN 1 TON, ECONOLINE / CLUB WAGON / SUPERDUTY All Exc. Cutaway Chassis	
R 92-05		VAN 1 TON, ECONOLINE / CLUB WAGON / SUPERDUTY All Cutaway Chassis	
R 99-03		VAN 1 TON, ECONOLINE / CLUB WAGON / SUPERDUTY All	
R 92-14		VAN 3/4 TON, ECONOLINE / CLUB WAGON / SUPERDUTY All	
R 25		THOR MOTOR COACH FOUR WINDS 282	
R 07-13		WINNEBAGO ACCESS All MotorHomes with Ford E350 or E450 Chassis	
R 14		ACCESS PREMIER All MotorHomes with Ford E350 or E450 Chassis	
G63624	W		140780
R 92-07		FORD VAN 1/2 TON, ECONOLINE / CLUB WAGON All	
G63625	C		140702
F 86-99		CHEVROLET VAN 1 TON, P SERIES All Motorhome Chassis w/ I-Beam Front Suspension	
F 86-99		GMC VAN 1 TON, P SERIES All Motorhome Chassis w/ I-Beam Front Suspension	
G63635	W		140524
F 87-93		MAZDA B2600 4WD	
G63638	A		
R 99-00		CADILLAC ESCALADE All	
R 92-94		CHEVROLET BLAZER 4WD Full Size	
R 92-99		SUBURBAN 1/2 TON, K15 / K1500 All	
R 92-99		SUBURBAN 3/4 TON, K25 / K2500 All	
R 95-00		TAHOE 4WD Old Body Style	
R 97-02		VAN 1 TON, G / EXPRESS All Exc. 8600# GVW	
R 96-02		VAN 3/4 TON, G / EXPRESS All Exc. 8600# GVW	
R 92-99		GMC SUBURBAN 1/2 TON, K15 / K1500 All	
R 92-99		SUBURBAN 3/4 TON, K25 / K2500 All	
R 96-02		VAN 1 TON, G / SAVANA All Exc. 8600# GVW	
R 96-02		VAN 3/4 TON, G / SAVANA All Exc. 8600# GVW	
G63661	C		143000
F 94-01		DODGE PICKUP 1/2 TON, RAM 1500 (SEE RAM 1500) RWD	
F 94-02		PICKUP 1 TON, RAM 3500 (SEE RAM 3500) RWD Exc. Solid Front Axle	
F 94-02		PICKUP 3/4 TON, RAM 2500 (SEE RAM 2500) RWD	
G63662	A		
R 99-07		CHEVROLET PICKUP 1/2 TON, SILVERADO 1500 RWD Exc. Electronic Adjustable Suspension	
R 94-01		DODGE PICKUP 1/2 TON, RAM 1500 (SEE RAM 1500) All	
R 94-02		PICKUP 1 TON, RAM 3500 (SEE RAM 3500) RWD Exc. Solid Front Axle	
R 94-03		PICKUP 3/4 TON, RAM 2500 (SEE RAM 2500) All Exc. 8800# GVW	
R 99-07		GMC SIERRA 1500 RWD Exc. Electronic Adjustable Suspension	
G63671	W		
R 92-96		CHEVROLET VAN 1 TON, G / EXPRESS Cutaway Van	

Numerical listing

Shock	POP	Alternative No.	MTG Acc. Supplied
Pos.	Year	Application	
G63671	W (cont)		
R 92-96		GMC VAN 1 TON, G / SAVANA Cutaway Van	
G63673	B		143000
F 94-01		DODGE PICKUP 1/2 TON, RAM 1500 (SEE RAM 1500) 4WD	
F 03-10		PICKUP 1 TON, RAM 3500 (SEE RAM 3500) 4WD	
F 94-02		PICKUP 3/4 TON, RAM 2500 (SEE RAM 2500) 4WD Exc. 8800# GVW	
F 11-24		RAM 3500 (SEE DODGE RAM 3500) 4WD	
G63674	D		142731
F 94-02		DODGE PICKUP 1 TON, RAM 3500 (SEE RAM 3500) 4WD	
F 94-02		PICKUP 1 TON, RAM 3500 (SEE RAM 3500) RWD Solid Front Axle	
F 94-02		PICKUP 3/4 TON, RAM 2500 (SEE RAM 2500) 4WD 8800# GVW	
G63675	A		
R 07		CHEVROLET PICKUP 1/2 TON, SILVERADO 1500 4WD Old Body Style; Exc. Electronic Adjustable Suspension	
R 99-06		PICKUP 1/2 TON, SILVERADO 1500 4WD Exc. Electronic Adjustable Suspension	
R 05-06		PICKUP 1/2 TON, SILVERADO 1500 HD All	
R 01-03		PICKUP 1/2 TON, SILVERADO 1500 HD All	
R 77-86		PICKUP 1 TON, K30 All	
R 90-91		PICKUP 1 TON, R3500 All	
R 89		PICKUP 1 TON, R3500 Cab & Chassis, RWD	
R 89		PICKUP 1 TON, R3500 Crew Cab Pickup, RWD	
R 01-09		PICKUP 1 TON, SILVERADO 3500 All	
R 07-10		PICKUP 1 TON, SILVERADO 3500 HD All	
R 87-88		PICKUP 1 TON, V30 All	
R 89-91		PICKUP 1 TON, V3000 / V3500 All	
R 99-08		PICKUP 3/4 TON, SILVERADO 2500 All	
R 01-10		PICKUP 3/4 TON, SILVERADO 2500 HD All	
R 07		SILVERADO 1500 HD CLASSIC All	
R 07		SILVERADO 2500 HD CLASSIC All	
R 02-05		DODGE PICKUP 1/2 TON, RAM 1500 (SEE RAM 1500) All	
R 94-02		PICKUP 1 TON, RAM 3500 (SEE RAM 3500) 4WD	
R 94-02		PICKUP 1 TON, RAM 3500 (SEE RAM 3500) RWD Solid Front Axle	
R 94-02		PICKUP 3/4 TON, RAM 2500 (SEE RAM 2500) 4WD 8800# GVW	
R 77-86		GMC PICKUP 1 TON, K35 / K3500 All	
R 87-91		PICKUP 1 TON, V3000 / V3500 All	
R 07		SIERRA 1500 4WD Old Body Style; Exc. Electronic Adjustable Suspension	
R 99-06		SIERRA 1500 4WD Exc. Electronic Adjustable Suspension	
R 05-06		SIERRA 1500 HD All	
R 01-03		SIERRA 1500 HD All	
R 07		SIERRA 1500 HD CLASSIC All	
R 99-04		SIERRA 2500 All	
R 01-10		SIERRA 2500 HD All	
R 01-06		SIERRA 3500 All	
R 07-10		SIERRA 3500 HD All	
R 11-18		RAM 1500 (SEE DODGE RAM 1500) All	
R 19-20		1500 CLASSIC 4WD	
G63676	W		
R 95-03		FORD WINDSTAR Coil (RearSpringType)	
G63678	A		142277
F 95-01		FORD EXPLORER All Exc. Adjustable Suspension	
F 01-05		EXPLORER SPORT TRAC All	
F 98-11		RANGER Torsion Bar (FrontSpringType)	
F 98-07		MAZDA B3000 Torsion Bar (FrontSpringType)	
F 98-09		B4000 Torsion Bar (FrontSpringType)	
F 97-01		MERCURY MOUNTAINEER All Exc. Electronic Adjustable Suspension	

Numerical listing

Shock	POP	Alternative No.	MTG Acc. Supplied
Pos.	Year	Application	
G63679	C		140719
R	95-01	FORD EXPLORER All Exc. Adjustable Suspension	
R	01-05	EXPLORER SPORT TRAC All	
R	97-01	MERCURY MOUNTAINEER All Exc. Electronic Adjustable Suspension	
G63683	D		
R	95-98	JEEP GRAND CHEROKEE All	
G63689	W		
R	01-04	TOYOTA TACOMA S-Runner	
R	04	TACOMA Base, RWD	
R	95-03	TACOMA DLX, RWD	
G63690	C		
R	96-07	CHRYSLER TOWN & COUNTRY All Exc. Hydraulic Self-Leveling System	
R	00-03	VOYAGER / GRAND VOYAGER All Exc. Hydraulic Self-Leveling System	
R	96-07	DODGE CARAVAN / GRAND CARAVAN All Exc. Hydraulic Self-Leveling System	
R	05	CARAVAN / GRAND CARAVAN All	
R	96-00	PLYMOUTH VOYAGER / GRAND VOYAGER All Exc. Hydraulic Self-Leveling System	
G63694	W		141448
R	99	LAND ROVER DISCOVERY SD	
R	99	DISCOVERY SE7	
R	94-98	DISCOVERY All	
R	94-95	RANGE ROVER Air (RearSpringType)	
G63707	W		141354
F	96-99	ACURA SLX All	
F	92-02	ISUZU TROOPER All	
F	99-01	VEHICROSS All	
G63708	W		140169
R	96-99	ACURA SLX All	
R	92-02	ISUZU TROOPER All	
R	99-01	VEHICROSS All	
G63710	D		140524
R	98-02	HONDA PASSPORT All	
R	98-00	ISUZU AMIGO All	
R	02-04	AXIOM All	
R	98-04	RODEO All	
G63712	W		141137
R	98	INFINITI QX4 All Mfg. to 12/98	
R	97	QX4 All	
R	98-99	NISSAN PATHFINDER All Mfg. to 12/98	
R	96-97	PATHFINDER All	
G63714	B		142731
F	97-02	FORD EXPEDITION RWD Exc. Front Air- Leveling	
F	97-04	LOBO RWD	
F	97-04	PICKUP 1/2 TON, F-150 RWD	
F	97-99	PICKUP 3/4 TON, F-250 / SUPERDUTY RWD Up through 8500# GVW	
F	98-02	LINCOLN NAVIGATOR RWD	
G63715	B		142700
R	98-03	FORD LOBO 4WD	
R	97-04	PICKUP 1/2 TON, F-150 4WD	
R	97-99	PICKUP 3/4 TON, F-250 / SUPERDUTY 4WD Up through 8500# GVW	
G63716	B		142731
F	97-02	FORD EXPEDITION 4WD Exc. Front Air- Leveling	
F	98-03	LOBO 4WD	
F	04	PICKUP 1/2 TON, F-150 4WD Exc. 7000# GVW	
F	97-03	PICKUP 1/2 TON, F-150 4WD	
F	97-99	PICKUP 3/4 TON, F-250 / SUPERDUTY 4WD Up through 8500# GVW	
G63717	W		
R	97-02	FORD EXPEDITION All	
R	98-02	LINCOLN NAVIGATOR RWD	
G63720	W		140800
R	95-02	KIA SPORTAGE All	

Ultra Truck Shock

Shock	POP	Alternative No.	MTG Acc. Supplied
Pos.	Year	Application	
G63721	C		141665
F	97-06	JEEP WRANGLER TJ (MfrBodyCode)	
G63722	D		
R	97-06	JEEP WRANGLER TJ (MfrBodyCode)	
G63726	D		140921
R	96-02	TOYOTA 4RUNNER All	
G63772	B		141665
F	06-11	FORD RANGER RWD , Coil (FrontSpringType)	
F	01-05	RANGER XL, RWD, Coil (FrontSpringType)	
F	01-05	RANGER XLT, RWD, Coil (FrontSpringType)	
F	02	RANGER EV, Torsion Bar (FrontSpringType) 4WD	
F	01	RANGER EV Coil (FrontSpringType)	
F	98-00	RANGER XL, RWD	
F	98-00	RANGER XLT, RWD	
F	01-09	MAZDA B2300 RWD	
F	98-01	B2500 RWD	
F	98-07	B3000 RWD	
F	98-06	B4000 RWD	
G63773	B		
R	98-11	FORD RANGER RWD , Coil (FrontSpringType)	
R	01-09	MAZDA B2300 RWD, Coil (FrontSpringType)	
R	94-97	B2300 RWD, Coil (FrontSpringType)	
R	98-01	B2500 Coil (FrontSpringType)	
R	03-07	B3000 RWD, Coil (FrontSpringType)	
R	94-01	B3000 RWD, Coil (FrontSpringType)	
R	94-00	B4000 RWD, Coil (FrontSpringType)	
G63775	B		
R	98-11	FORD RANGER Torsion Bar (FrontSpringType)	
R	98-07	MAZDA B3000 Torsion Bar (FrontSpringType)	
R	98-09	B4000 Torsion Bar (FrontSpringType)	
G63776	C		
R	05-07	BUICK TERRAZA FWD Exc. Air-Leveling Suspension	
R	05-09	CHEVROLET UPLANDER FWD Exc. Auto-Leveling System	
R	02-05	VENTURE All	
R	97-01	VENTURE FWD	
R	02-04	OLDSMOBILE SILHOUETTE AWD	
R	97-04	SILHOUETTE FWD	
R	07-09	PONTIAC MONTANA CAN	
R	06	MONTANA FWD Exc. Air-Leveling Suspension	
R	99-05	MONTANA All Exc. Air-Leveling Suspension	
R	97-99	TRANS SPORT All	
R	05-07	SATURN RELAY FWD Exc. Air-Leveling Suspension	
G63778	C		142700
R	00-03	FORD LOBO Harley-Davidson Edition, RWD	
R	00-03	LOBO XLT, RWD	
R	00	LOBO Base, RWD	
R	00	LOBO Lariat, RWD	
R	97-98	LOBO RWD	
R	04	PICKUP 1/2 TON, F-150 RWD	
R	00-03	PICKUP 1/2 TON, F-150 Harley-Davidson Edition, RWD	
R	99-03	PICKUP 1/2 TON, F-150 Lariat, RWD	
R	99-03	PICKUP 1/2 TON, F-150 XL, RWD	
R	99-03	PICKUP 1/2 TON, F-150 XLT, RWD	
R	00	PICKUP 1/2 TON, F-150 Base, RWD	
R	97-98	PICKUP 1/2 TON, F-150 RWD	
R	97-99	PICKUP 3/4 TON, F-250 / SUPERDUTY RWD Up through 8500# GVW	
G63781	W		141350
R	92-00	MITSUBISHI MONTERO All	
G63782	W		141350
F	92-00	MITSUBISHI MONTERO All	
F	97-99	MONTERO SPORT All	

Numerical listing

Shock	POP	Alternative No.	MTG Acc. Supplied
Pos.	Year	Application	
G63783	A		141665
F	99-07	CHEVROLET PICKUP 1/2 TON , SILVERADO 1500 RWD Exc. Electronic Adjustable Suspension	
F	99-04	PICKUP 3/4 TON, SILVERADO 2500 RWD Exc. Electronic Adjustable Suspension	
F	01-04	PICKUP 3/4 TON, SILVERADO 2500 HD RWD	
F	99-07	GMC SIERRA 1500 RWD Exc. Electronic Adjustable Suspension	
F	99-04	SIERRA 2500 RWD Exc. Electronic Adjustable Suspension	
F	01-04	SIERRA 2500 HD RWD	
G63799	W		141514
R	92-93	ASUNA SUNRUNNER All	
R	98-04	CHEVROLET TRACKER Non-ABS	
R	89-97	GEO TRACKER All	
R	94-97	PONTIAC SUNRUNNER All	
R	99-05	SUZUKI GRAND VITARA All	
R	89-98	SIDEKICK Non-ABS	
R	99-04	VITARA Non-ABS	
R	96-98	X-90 All	
G63803	A		141665
F	02-06	CHEVROLET AVALANCHE 1500 All Exc. Electronic Ride Control	
F	07	PICKUP 1/2 TON, SILVERADO 1500 4WD Old Body Style; Exc. Electronic Adjustable Suspension	
F	99-06	PICKUP 1/2 TON, SILVERADO 1500 4WD Exc. Electronic Adjustable Suspension	
F	00-06	SUBURBAN 1/2 TON, 1500 All Exc. Z55 Auto Ride Suspension	
F	02-06	TAHOE All Exc. Z55 Auto Ride Suspension	
F	00-01	TAHOE All New Body Style; Exc. Z55 Auto Ride Suspension	
F	07	GMC SIERRA 1500 4WD Old Body Style; Exc. Electronic Adjustable Suspension	
F	99-06	SIERRA 1500 4WD Exc. Electronic Adjustable Suspension	
F	00-06	YUKON All Exc. Z55 Auto Ride Suspension	
F	00-06	YUKON XL 1/2 TON All Exc. Z55 Auto Ride Suspension	
G63808	W		
R	99-04	FORD PICKUP 1 TON , F-350 / SUPERDUTY RWD	
R	99-04	PICKUP 3/4 TON, F-250 / SUPERDUTY RWD	
G63809	A		
F	00-05	FORD EXCURSION 4WD	
R	97	F-250 HD RWD	
R	85-96	PICKUP 1/2 TON, F-150 RWD	
F	99-04	PICKUP 1 TON, F-350 / SUPERDUTY 4WD	
R	80-97	PICKUP 1 TON, F-350 / SUPERDUTY RWD Exc. Dual Rear Wheels	
F	99-04	PICKUP 3/4 TON, F-250 / SUPERDUTY 4WD	
R	97	PICKUP 3/4 TON, F-250 / SUPERDUTY RWD Over 8500# GVW	
R	80-96	PICKUP 3/4 TON, F-250 / SUPERDUTY RWD	
G63810	C		
R	99-04	FORD PICKUP 1 TON , F-350 / SUPERDUTY 4WD	
R	99-04	PICKUP 3/4 TON, F-250 / SUPERDUTY 4WD	
G63813	B		142389
F	00-04	NISSAN FRONTIER Crew Cab Pickup, RWD w/ Desert Runner	
F	98-04	FRONTIER 4WD	
F	98-99	FRONTIER RWD Crew Cab; w/ Desert Runner Package	
F	00-04	XTERRA All	
G63815	C		142389
R	00-06	TOYOTA TUNDRA All	
G63817	A		141665
F	02-06	CHEVROLET AVALANCHE 2500 All Exc. Electronic Ride Control	
F	05-06	PICKUP 1/2 TON, SILVERADO 1500 HD All	

Numerical listing

Shock	POP	Alternative No.	MTG Acc. Supplied
Pos.	Year	Application	
G63817	A (cont)		141665
F	01-03	PICKUP 1/2 TON, SILVERADO 1500 HD All	
F	01-09	PICKUP 1 TON, SILVERADO 3500 All	
F	07-10	PICKUP 1 TON, SILVERADO 3500 HD All	
F	05-08	PICKUP 3/4 TON, SILVERADO 2500 All	
F	99-04	PICKUP 3/4 TON, SILVERADO 2500 4WD	
F	05-10	PICKUP 3/4 TON, SILVERADO 2500 HD All 9200# GVW	
F	01-04	PICKUP 3/4 TON, SILVERADO 2500 HD 4WD 9200# GVW	
F	07	SILVERADO 1500 HD CLASSIC All	
F	07	SILVERADO 2500 HD CLASSIC All	
F	00-13	SUBURBAN 3/4 TON, 2500 All Exc. Z55 Auto Ride Suspension and Quadrasteer	
F	05-06	GMC SIERRA 1500 HD All	
F	01-03	SIERRA 1500 HD All	
F	07	SIERRA 1500 HD CLASSIC All	
F	99-04	SIERRA 2500 4WD	
F	01-10	SIERRA 2500 HD 4WD	
F	01-06	SIERRA 3500 All	
F	07-10	SIERRA 3500 HD Torsion Bar (FrontSpringType)	
F	00-06	YUKON XL 3/4 TON All Exc. Hydraulic Self-Leveling System	
F	03-09	HUMMER H2 All	
G63818	A		
F	90-05	CHEVROLET ASTRO AWD	
F	88-99	PICKUP 1/2 TON, K15 / K1500 All	
F	88-99	GMC PICKUP 1/2 TON, K15 / K1500 All	
F	90-05	SAFARI AWD	
G63828	W		142976
R	07	LEXUS LX470 All	
R	98-06	LX470 Torsion Bar (FrontSpringType)	
R	98-07	TOYOTA LAND CRUISER All	
G63829	C		
R	99-04	JEEP GRAND CHEROKEE All	
G63832	D		142976
F	07	LEXUS LX470 All	
F	98-06	LX470 Torsion Bar (FrontSpringType)	
F	98-07	TOYOTA LAND CRUISER All	
G63837	W		
R	00-05	FORD EXCURSION 4WD	
G63842	A		
R	04-07	BUICK RAINIER Coil (FrontSpringType)	
R	03-06	CHEVROLET SSR All	
R	02-09	TRAILBLAZER Coil (RearSpringType)	
R	02-09	GMC ENVOY Coil (RearSpringType)	
R	03-08	ISUZU ASCENDER Coil (RearSpringType)	
R	02-04	OLDSMOBILE BRAVADA Coil (RearSpringType)	
R	05-09	SAAB 9-7X All	
G63844	C		
R	07-11	DODGE NITRO All	
R	02-12	JEEP LIBERTY All	
G63845	D		
R	99-03	INFINITI QX4 All Mfg. from 12/98	
R	02-04	NISSAN PATHFINDER All	
R	99-01	PATHFINDER All Mfg. from 12/98	
G63847	W		141353,142592
F	99-04	JEEP GRAND CHEROKEE All Exc. Up Country Suspension	
G63848	C		142731
F	02-05	DODGE PICKUP 1/2 TON, RAM 1500 (SEE RAM 1500) 4WD	
G63860	D		140455
R	96-05	TOYOTA RAV4 All	
G63862	W		141041
R	01-07	FORD ESCAPE All	
R	01-06	MAZDA TRIBUTE All	
R	05-07	MERCURY MARINER All	
G63864	W		
R	00-06	MAZDA MPV All	

Ultra Truck Shock

Shock	POP	Alternative No.	MTG Acc. Supplied
Pos.	Year	Application	
G63866	A		
R	02-13	CADILLAC ESCALADE All Exc. Electronic Ride Control	
R	07-13	CHEVROLET AVALANCHE 1500 All Exc. Z55 or ZW7 Ride Suspension	
R	02-06	AVALANCHE 1500 All Exc. Electronic Ride Control	
R	02-06	AVALANCHE 2500 All Exc. Electronic Ride Control	
R	21-22	COLORADO Z71 LT	
R	15-22	COLORADO LT	
R	15-22	COLORADO WT	
R	15-22	COLORADO Z71	
R	15-20	COLORADO Base	
R	15	COLORADO LTZ	
R	07-11	SUBURBAN 1/2 TON, 1500 All Exc. Z55 or ZW7 Ride Suspension	
R	00-06	SUBURBAN 1/2 TON, 1500 All Exc. Z55 Auto Ride Suspension	
R	00-13	SUBURBAN 3/4 TON, 2500 All Exc. Z55 Auto Ride Suspension and Quadrasteer	
R	07-11	TAHOE All Exc. Z55 or ZW7 Ride Suspension	
R	02-06	TAHOE All Exc. Z55 Auto Ride Suspension	
R	00-01	TAHOE All New Body Style; Exc. Z55 Auto Ride Suspension	
R	15-22	GMC CANYON All Exc. ZR2 Package	
R	07-11	YUKON All Exc. Z55 or ZW7 Ride Suspension	
R	00-06	YUKON All Exc. Z55 Auto Ride Suspension	
R	00-11	YUKON XL 1/2 TON All Exc. Z55 Auto Ride Suspension	
R	00-11	YUKON XL 3/4 TON All Exc. Z55 Auto Ride Suspension and Quadrasteer	
G63867	C		
R	09-10	FORD LOBO RWD	
R	04-08	LOBO 4WD	
R	09-10	PICKUP 1/2 TON, F-150 RWD	
R	04-08	PICKUP 1/2 TON, F-150 4WD	
R	06-08	LINCOLN MARK LT 4WD	
G63868	W		
R	02-07	BUICK RENDEZVOUS All Exc. Hydraulic Self-Leveling System	
R	01-05	PONTIAC AZTEK AWD	
G63869	W		
R	01-05	PONTIAC AZTEK FWD	
G63870	C		
R	05-08	FORD LOBO RWD	
R	04	LOBO XLT, RWD	
R	05-08	PICKUP 1/2 TON, F-150 RWD	
R	04	PICKUP 1/2 TON, F-150 Lariat, RWD	
R	04	PICKUP 1/2 TON, F-150 STX, RWD	
R	04	PICKUP 1/2 TON, F-150 XL, RWD	
R	04	PICKUP 1/2 TON, F-150 XLT, RWD	
R	19-24	RANGER RWD	
R	06-08	LINCOLN MARK LT RWD	
G63872	D		
R	02-10	SATURN VUE All	
G63873	W		
R	04-07	FORD FREESTAR All	
R	04-07	MERCURY MONTEREY Mini Passenger Van	
G63875	D		
R	04-08	CHEVROLET TORNADO All	
R	05-07	INFINITI QX56 All Exc. Air-Leveling Suspension	
R	05-15	NISSAN ARMADA All Exc. Auto-Leveling System	
R	04	PATHFINDER ARMADA All	
G63878	C		
R	17-22	NISSAN TITAN 4WD	
R	04-15	TITAN 4WD	
R	20-22	TITAN XD Platinum Reserve	
R	20-22	TITAN XD S	
R	20-22	TITAN XD SV	
R	20-21	TITAN XD SL	
R	16-19	TITAN XD Platinum Reserve, 4WD	
R	16-19	TITAN XD S, 4WD	
R	16-19	TITAN XD SL, 4WD	
R	16-19	TITAN XD SV, 4WD	

Numerical listing

Shock	POP	Alternative No.	MTG Acc. Supplied
Pos.	Year	Application	
G63879	A		
R	04-12	CHEVROLET COLORADO Torsion Bar (FrontSpringType)	
R	04-12	GMC CANYON Torsion Bar (FrontSpringType)	
R	06	ISUZU I-280 All Torsion Bar (FrontSpringType)	
G63882	W		
R	04-12	CHEVROLET COLORADO RWD, Coil (FrontSpringType) D Standard Suspension; Exc. Z71 Off Road Package	
R	04-12	GMC CANYON RWD, Coil (FrontSpringType) D Standard Suspension; Exc. Z71 Off Road Package	
R	06	ISUZU I-280 Coil (FrontSpringType)	
R	07-08	I-290 Coil (FrontSpringType)	
R	08	I-370 Coil (FrontSpringType)	
G63883	W		
R	17-22	NISSAN TITAN RWD	
R	04-15	TITAN RWD	
G63884	B		143312
F	04-12	CHEVROLET COLORADO Torsion Bar (FrontSpringType)	
F	04-08	GMC CANYON Torsion Bar (FrontSpringType)	
F	06	ISUZU I-350 Torsion Bar (FrontSpringType)	
G63885	D		142280
R	17-18	TOYOTA 4RUNNER RWD Exc. Kinetic Suspension	
R	10-16	4RUNNER All	
R	03-09	4RUNNER Limited	
R	03-09	4RUNNER SR5	
G63886	A		142731
F	17-24	FORD PICKUP 1 TON, F-350 / SUPERDUTY 4WD	
F	13-16	PICKUP 1 TON, F-350 / SUPERDUTY 4WD Exc. Off Road	
F	11-16	PICKUP 1 TON, F-350 / SUPERDUTY All	
F	05-12	PICKUP 1 TON, F-350 / SUPERDUTY 4WD	
F	99-09	PICKUP 1 TON, F-350 / SUPERDUTY All	
F	01-24	PICKUP 3/4 TON, F-250 / SUPERDUTY 4WD	
F	12-16	PICKUP 3/4 TON, F-250 / SUPERDUTY RWD w/ Off Road Package	
F	99-09	PICKUP 3/4 TON, F-250 / SUPERDUTY RWD w/ Off Road Package	
F	99	PICKUP 3/4 TON, F-250 / SUPERDUTY 4WD	
G63888	D		
R	13-16	FORD PICKUP 1 TON, F-350 / SUPERDUTY 4WD	
R	05-12	PICKUP 1 TON, F-350 / SUPERDUTY Crew Cab Pickup, 4WD Single Rear Wheels	
R	05-12	PICKUP 1 TON, F-350 / SUPERDUTY Extended Cab Pickup, 4WD Single Rear Wheels	
R	05-12	PICKUP 1 TON, F-350 / SUPERDUTY Standard Cab Pickup, 4WD Single Rear Wheels	
R	13-16	PICKUP 3/4 TON, F-250 / SUPERDUTY RWD	
R	05-12	PICKUP 3/4 TON, F-250 / SUPERDUTY 4WD	
G63889	C		141041
R	05-15	TOYOTA TACOMA Base, RWD	
R	05-15	TACOMA Pre Runner, RWD	
G63890	W		
R	05-10	DODGE DAKOTA RWD	
R	06-09	MITSUBISHI RAIDER RWD	
R	11	RAM DAKOTA RWD	
G63891	C		
R	05-10	DODGE DAKOTA 4WD	
R	06-09	MITSUBISHI RAIDER 4WD	
R	11	RAM DAKOTA 4WD	
G63892	D		
R	07-09	CHRYSLER ASPEN All	
R	04-09	DODGE DURANGO All	

Numerical listing

Shock	POP	Alternative No.	MTG Acc. Supplied
Pos.	Year	Application	
G63893 C 143276			
F	10-14	CHEVROLET VAN 1/2 TON, G / EXPRESS AWD, Torsion Bar (FrontSpringType)	
F	03-09	VAN 1/2 TON, G / EXPRESS Torsion Bar (FrontSpringType)	
F	03-12	VAN 1 TON, G / EXPRESS All Torsion Bar (FrontSpringType)	
F	06-12	VAN 3/4 TON, G / EXPRESS All Torsion Bar (FrontSpringType)	
F	03-05	VAN 3/4 TON, G / EXPRESS Torsion Bar (FrontSpringType)	
F	10-14	GMC VAN 1/2 TON, G / SAVANA AWD, Torsion Bar (FrontSpringType)	
F	03-09	VAN 1/2 TON, G / SAVANA Torsion Bar (FrontSpringType)	
F	03-12	VAN 1 TON, G / SAVANA All Torsion Bar (FrontSpringType)	
F	04-12	VAN 3/4 TON, G / SAVANA All Torsion Bar (FrontSpringType)	
F	03	VAN 3/4 TON, G / SAVANA Torsion Bar (FrontSpringType)	
G63894 B 143276			
F	03-14	CHEVROLET VAN 1/2 TON, G / EXPRESS RWD, Coil (FrontSpringType)	
F	03-14	GMC VAN 1/2 TON, G / SAVANA RWD, Coil (FrontSpringType)	
G63895 A 143276			
F	17-24	CHEVROLET VAN 1 TON, G / EXPRESS All (FrontSpringType)	
F	03-16	VAN 1 TON, G / EXPRESS Coil (FrontSpringType)	
F	17-24	VAN 3/4 TON, G / EXPRESS All (FrontSpringType)	
F	03-16	VAN 3/4 TON, G / EXPRESS Coil (FrontSpringType)	
F	17-24	GMC VAN 1 TON, G / SAVANA All (FrontSpringType)	
F	03-16	VAN 1 TON, G / SAVANA Coil (FrontSpringType)	
F	17-24	VAN 3/4 TON, G / SAVANA All (FrontSpringType)	
F	03-16	VAN 3/4 TON, G / SAVANA Coil (FrontSpringType)	
G63896 B			
R	92-99	CHEVROLET SUBURBAN 1/2 TON, C15 / C1500 All	
R	92-99	SUBURBAN 3/4 TON, C25 / C2500 All	
R	95-00	TAHOE RWD Old Body Style	
R	96-14	VAN 1/2 TON, G / EXPRESS All	
R	93-99	GMC SUBURBAN 1/2 TON, C15 / C1500 All	
R	92	SUBURBAN 1/2 TON, C15 / C1500 All Old Body Style	
R	92-99	SUBURBAN 3/4 TON, C25 / C2500 All	
R	96-14	VAN 1/2 TON, G / SAVANA All	
R	00	YUKON Denali	
R	92-99	YUKON All	
G63897 A			
R	13-24	CHEVROLET VAN 1 TON, G / EXPRESS All	
R	03-12	VAN 1 TON, G / EXPRESS All Single Rear Wheels	
R	03-24	VAN 3/4 TON, G / EXPRESS All	
R	13-24	GMC VAN 1 TON, G / SAVANA All	
R	03-12	VAN 1 TON, G / SAVANA All Single Rear Wheels	
R	03-24	VAN 3/4 TON, G / SAVANA All	
G63902 C 140857			
F	81-82	CHEVROLET LUV PICKUP RWD	
F	81-95	ISUZU PICKUP RWD	
F	69-72	NISSAN 521 PICKUP All	
F	72-79	620 PICKUP All	
F	80-86	720 PICKUP All	
F	87-97	PICKUP 4WD	
F	86	PICKUP 4WD Mfg. from 8/86	
G63903 C 141376			
F	85-95	TOYOTA PICKUP RWD Exc. 1 Ton	
F	84	PICKUP RWD	
F	93-98	T100 RWD	
G63904 W 141356			
F	87-90	MIITSUBISHI VAN All	
F	87-95	NISSAN PATHFINDER All Exc. Electronic Adjustable Suspension	
G63905 B 140126			
F	97-04	DODGE DAKOTA 4WD	
F	98-03	DURANGO 4WD	

Ultra Truck Shock

Shock	POP	Alternative No.	MTG Acc. Supplied
Pos.	Year	Application	
G63907 A			
R	75-80	CHEVROLET LUV PICKUP All	
R	72-74	LUV PICKUP All	
R	87-93	DODGE PICKUP, RAM 50 RWD	
R	83-86	PICKUP, RAM 50 All	
R	86-87	MAZDA B2000 RWD	
R	87-93	B2200 RWD	
R	87-93	B2600 RWD	
R	95-96	MIITSUBISHI MIGHTY MAX All	
R	83-94	MIGHTY MAX RWD	
R	87-90	VAN All	
R	98-04	NISSAN FRONTIER RWD Exc. Desert Runner	
R	87-97	PICKUP RWD	
R	86	PICKUP RWD Mfg. from 8/86	
R	79-82	PLYMOUTH PICKUP All	
R	85-95	TOYOTA PICKUP RWD Exc. 1 Ton	
R	75-84	PICKUP RWD Mojave	
R	70-74	PICKUP All RWD	
R	84-88	VAN Leaf (RearSpringType)	
R	88	VAN WAGON All Leaf(RearSpringType)	
G63909 A 141368			
F	81-82	CHEVROLET LUV PICKUP 4WD	
F	75-80	LUV PICKUP All	
F	72-74	LUV PICKUP All	
F	89-94	ISUZU AMIGO All	
F	81-95	PICKUP 4WD	
F	84-86	TROOPER 4WD	
F	98-04	NISSAN FRONTIER RWD Exc. Desert Runner	
F	87-97	PICKUP RWD	
F	86	PICKUP RWD Mfg. from 8/86	
G63915 B 140126			
F	87-04	DODGE DAKOTA RWD	
F	99-03	DURANGO RWD	
G63918 W			
R	07-09	DODGE SPRINTER 2500 All Single Rear Wheels	
R	03-06	SPRINTER 2500 All Exc. Dual Rear Wheels	
R	07-09	SPRINTER 3500 All Single Rear Wheels	
R	03-06	SPRINTER 3500 All Exc. Dual Rear Wheels	
R	02-06	FREIGHTLINER SPRINTER 2500 All	
R	04-06	MERCEDES-BENZ SPRINTER All Exc. Dual Rear Wheels	
G63928 W			
R	89-94	ISUZU AMIGO All	
R	81-95	PICKUP 4WD	
R	84-86	TROOPER 4WD	
G63929 W 140780			
F	92-07	FORD VAN 1/2 TON, ECONOLINE / CLUB WAGON All	
G63937 W 140673			
F	01-04	TOYOTA TACOMA S-Runner	
F	04	TACOMA Base, RWD	
F	95-03	TACOMA DLX, RWD	
G63950 W 140455			
F	83-93	DODGE PICKUP, RAM 50 RWD	
F	83-96	MIITSUBISHI MIGHTY MAX RWD	
F	79-82	PLYMOUTH PICKUP All	
G63958 B 143276			
F	06-08	DODGE PICKUP 1/2 TON, RAM 1500 (SEE RAM 1500) Crew Cab Pickup, RWD	
F	06-08	PICKUP 1/2 TON, RAM 1500 (SEE RAM 1500) Standard Cab Pickup, RWD	
F	02-05	PICKUP 1/2 TON, RAM 1500 (SEE RAM 1500) RWD	
G63959 A			
R	23-24	CHEVROLET PICKUP 1/2 TON, SILVERADO 1500 All Exc. Z45 Adaptable Ride Control (22 Inch Wheels)	
R	22	PICKUP 1/2 TON, SILVERADO 1500 All Exc. Electronic Adaptable Suspension	
R	19-21	PICKUP 1/2 TON, SILVERADO 1500 All Exc. Z45 Adaptable Ride Control (22 Inch Wheels)	
R	08-18	PICKUP 1/2 TON, SILVERADO 1500 All	

Numerical listing

Shock	POP	Alternative No.	MTG Acc. Supplied
Pos.	Year	Application	
G63959 A (cont)			
R	07	PICKUP 1/2 TON, SILVERADO 1500 Base Exc. Electronic Adjustable Suspension	
R	07	PICKUP 1/2 TON, SILVERADO 1500 LT Exc. Electronic Adjustable Suspension	
R	07	PICKUP 1/2 TON, SILVERADO 1500 LTZ Exc. Electronic Adjustable Suspension	
R	07	PICKUP 1/2 TON, SILVERADO 1500 WT Exc. Electronic Adjustable Suspension	
R	19-24	GMC SIERRA 1500 All Exc. Z45 Adaptable Ride Control (22 Inch Wheels)	
R	08-18	SIERRA 1500 All	
R	07	SIERRA 1500 SLE Exc. Electronic Adjustable Suspension	
R	07	SIERRA 1500 SLT Exc. Electronic Adjustable Suspension	
R	07	SIERRA 1500 WT Exc. Electronic Adjustable Suspension	
R	20-22	JEEP GLADIATOR All	
G63961 W			
R	06-08	DODGE PICKUP 1/2 TON, RAM 1500 (SEE RAM 1500) 4WD Exc. Mega Cab	
G63962 W			
R	06-08	DODGE PICKUP 1/2 TON, RAM 1500 (SEE RAM 1500) RWD Exc. Mega Cab	
G63965 C			
R	09-10	HUMMER H3 All	
R	06-10	H3 All	
G63966 W			
R	07-17	JEEP WRANGLER All Exc. Models w/ 17" Wheels	
G63967 D			
R	13-17	JEEP WRANGLER All Models w/ 17" Wheels, w/Heavy Duty Suspension	
R	07-12	WRANGLER All Models w/ 17" Wheels	
G63971 W			
R	03-10	DODGE PICKUP 1 TON, RAM 3500 (SEE RAM 3500) Crew Cab Pickup, RWD	
R	03-10	PICKUP 3/4 TON, RAM 2500 (SEE RAM 2500) Crew Cab Pickup, RWD	
R	11-20	RAM 3500 (SEE DODGE RAM 3500) Crew Cab Pickup, RWD	
G64000 D			
R	16-19	CHEVROLET SUBURBAN 3500 HD All	
R	03-09	HUMMER H2 All	
G64001 C 143276			
F	09-10	HUMMER H3 All	
F	06-10	H3 All	
G64002 W			
R	98-02	LINCOLN NAVIGATOR 4WD, Air (RearSpringType)	
G64003 C			
R	01-06	ACURA MDX All	
R	03-08	HONDA PILOT All	
G64006 B 141041			
R	17-21	TOYOTA TACOMA Edicion Especial, 4WD	
R	17-21	TACOMA Sport, 4WD	
R	16-21	TACOMA Limited, 4WD	
R	16-21	TACOMA SR, 4WD	
R	16-21	TACOMA TRD Off-Road, 4WD	
R	16-21	TACOMA TRD Sport, 4WD	
R	21	TACOMA Nightshade, 4WD	
R	21	TACOMA Trail, 4WD	
R	16-17	TACOMA SR5, 4WD	
R	13-15	TACOMA 4WD Exc. Off Road	
R	05-12	TACOMA 4WD	
G64008 D 142973			
F	07-12	JEEP WRANGLER All	
G64009 W 142731			
F	11-20	RAM 2500 (SEE DODGE RAM 2500) 4WD	

Numerical listing

Shock	POP	Alternative No.	MTG Acc. Supplied
Pos.	Year	Application	
G64010	D		
R	05-16	FORD PICKUP 1 TON, F-350 / SUPERDUTY RWD	
R	11-16	PICKUP 3/4 TON, F-250 / SUPERDUTY RWD Exc. Off Road	
R	05-10	PICKUP 3/4 TON, F-250 / SUPERDUTY RWD	
G64011	W		142731
F	04-10	DODGE PICKUP 3/4 TON, RAM 2500 (SEE RAM 2500) 4WD	
G64012	D		
R	06-10	JEEP COMMANDER All	
R	05-10	GRAND CHEROKEE All	
G64013	W		
R	03-10	DODGE PICKUP 3/4 TON, RAM 2500 (SEE RAM 2500) 4WD 8800# GVW	
R	11-13	RAM 2500 (SEE DODGE RAM 2500) 4WD	
G64014	W		
R	06-09	CHEVROLET TRAILBLAZER Air (RearSpringType)	
R	02-05	TRAILBLAZER All Air(RearSpringType)	
R	03-06	GMC ENVOY Air (RearSpringType)	
G64015	B		
R	05-13	CHEVROLET EQUINOX All	
R	10-13	GMC TERRAIN All	
R	06-09	PONTIAC TORRENT All	
R	07-09	SUZUKI XL-7 All Exc. 3rd Row Seating	
G64016	C		
F	07-09	CHRYSLER ASPEN All	
F	04-09	DODGE DURANGO All	
G64026	A		
R	06-12	TOYOTA RAV4 All	
G64027	W		
F	00-04	MITSUBISHI MONTERO SPORT All	
G64028	W		
R	00-04	MITSUBISHI MONTERO SPORT All	
G64029	W		142731
R	07-14	TOYOTA FJ CRUISER RWD	
G64030	W		142731
R	11-14	TOYOTA FJ CRUISER 4WD	
R	07-09	FJ CRUISER 4WD	
G64031	B		
R	20-21	NISSAN FRONTIER All Exc. Nismo Off Road	
R	14-19	FRONTIER All	
R	09-13	FRONTIER All Exc. Nismo Off Road	
R	05-08	FRONTIER LE	
R	05-08	FRONTIER SE	
R	05-08	FRONTIER XE	
R	09-12	SUZUKI EQUATOR All	
G64032	W		
R	03-06	KIA SORENTO All Exc. Self-Leveling Suspension	
G64033	C		
R	12-13	NISSAN PATHFINDER All Mfg. to 9/12	
R	05-11	PATHFINDER All	
G64037	D		
R	07-10	FORD EDGE All	
R	07-09	LINCOLN MKX All	
G64038	B		143340
R	07-20	TOYOTA TUNDRA All	
G64040	A		
R	08-17	BUICK ENCLAVE All	
R	09-17	CHEVROLET TRAVERSE All	
R	07-16	GMC ACADIA All	
R	17	ACADIA LIMITED All	
R	07-10	SATURN OUTLOOK All	
G64042	A		
R	08-16	CHRYSLER TOWN & COUNTRY All Exc. Self-Leveling Suspension	
R	19-20	DODGE CARAVAN / GRAND CARAVAN All	
R	17-18	CARAVAN / GRAND CARAVAN SE	
R	17-18	CARAVAN / GRAND CARAVAN SXT	

Ultra Truck Shock

Shock	POP	Alternative No.	MTG Acc. Supplied
Pos.	Year	Application	
G64042	A (cont)		
R	17-18	CARAVAN / GRAND CARAVAN SXT Plus	
R	18	CARAVAN / GRAND CARAVAN Blacktop	
R	18	CARAVAN / GRAND CARAVAN Canada Value Package	
R	18	CARAVAN / GRAND CARAVAN Crew	
R	18	CARAVAN / GRAND CARAVAN Crew Plus	
R	18	CARAVAN / GRAND CARAVAN SXT Premium Plus	
R	08-16	CARAVAN / GRAND CARAVAN All Exc. Self-Leveling Suspension	
R	12-15	RAM C/V All Exc. Load Leveling	
R	09-14	VOLKSWAGEN ROUTAN All Exc. Self-Leveling Suspension	
G64043	C		
F	09-10	DODGE PICKUP 1/2 TON, RAM 1500 (SEE RAM 1500) RWD	
F	16-18	RAM 1500 (SEE DODGE RAM 1500) RWD Exc. Air Suspension	
F	11-15	1500 (SEE DODGE RAM 1500) RWD	
F	19-20	1500 CLASSIC RWD Old Body Style	
F	11-20	2500 (SEE DODGE RAM 2500) Standard Cab Pickup, RWD	
F	11-20	3500 (SEE DODGE RAM 3500) Standard Cab Pickup, RWD	
G64046	W		
R	00-06	BMW X5 All	
G64047	D		
R	08-12	FORD ESCAPE All	
R	08-11	MAZDA TRIBUTE All	
R	08-11	MERCURY MARINER All	
G64048	D		
R	07-09	HYUNDAI SANTA FE All	
R	07-12	VERACRUZ All	
G64049	W		
F	00-03	MERCEDES-BENZ ML55 AMG All	
F	98-03	ML320 All	
F	03-05	ML350 All	
F	99-01	ML430 All	
F	02-05	ML500 All	
G64050	B		
R	08-20	NISSAN ROGUE All	
R	14-15	ROGUE SELECT All	
R	19-20	X-TRAIL All	
R	10-12	X-TRAIL All	
R	08	X-TRAIL All	
G64052	W		
R	06-13	SUZUKI GRAND VITARA All	
G64056	W		
R	07-10	MAZDA CX-7 All	
G64063	W		
R	07-10	FORD TRANSIT All	
G64071	D		
R	07-08	HYUNDAI ENTOURAGE All	
R	14	KIA SEDONA All	
R	06-12	SEDONA All	
G64079	A		
R	09-21	FORD LOBO 4WD	
R	09-24	PICKUP 1/2 TON, F-150 4WD	
R	10-12	LINCOLN MARK LT All	
G64080	C		
R	07-13	ACURA MDX All Exc. Active Suspension	
R	10-13	ZDX All Exc. Electronic Suspension	
G64087	D		143426
R	01-07	TOYOTA SEQUOIA All	
G64089	W		
R	07-20	FREIGHTLINER SPRINTER 3500 All	
R	07-10	MERCEDES-BENZ SPRINTER All	
R	11-20	SPRINTER 3500 All	
G64101	A		
R	63-67	CHEVROLET C10 PANEL All	
R	20	SUBURBAN 1/2 TON, 1500 All Old Body Style	
R	12-19	SUBURBAN 1/2 TON, 1500 All	

Numerical listing

Shock	POP	Alternative No.	MTG Acc. Supplied
Pos.	Year	Application	
G64101	A (cont)		
R	11-19	TAHOE All Exc. Police Package	
R	12-20	GMC YUKON All Old Body Style	
R	15-20	YUKON XL All Old Body Style	
R	12-14	YUKON XL 1/2 TON All	
G64104	C		
R	09-15	HONDA PILOT All	
G64111	D		
R	11-14	FORD EDGE All	
R	11-15	LINCOLN MKX All	
G64121	A		
R	15-18	CHEVROLET PICKUP 1 TON, SILVERADO 3500 All	
R	11-13	PICKUP 1 TON, SILVERADO 3500 All	
R	11-24	PICKUP 1 TON, SILVERADO 3500 HD All	
R	11-18	PICKUP 3/4 TON, SILVERADO 2500 All	
R	11-24	PICKUP 3/4 TON, SILVERADO 2500 HD All	
R	11-24	GMC SIERRA 2500 HD All	
R	11-24	SIERRA 3500 HD All	
R	20-24	RAM 3500 (SEE DODGE RAM 3500) All	
G64140	C		
R	14-17	CHEVROLET EQUINOX All	
R	14-17	GMC TERRAIN All	
G64143	W		
R	13-16	HYUNDAI SANTA FE FWD	
G64146	W		
R	15-18	CHEVROLET CITY EXPRESS All	
R	13-19	NISSAN NV200 All	
G64148	A		
F	11-24	CHEVROLET PICKUP 1 TON, SILVERADO 3500 HD All	
F	11-24	PICKUP 3/4 TON, SILVERADO 2500 HD All	
F	11-24	GMC SIERRA 2500 HD All	
F	11-24	SIERRA 3500 HD All	
G64151	D		
R	15-17	LEXUS NX200T All	
R	13-17	TOYOTA RAV4 All	
G64157	B		
R	11-20	FORD LOBO RWD	
R	11-24	PICKUP 1/2 TON, F-150 RWD	
G64163	W		
R	11-17	LEXUS RX350 All	
G64164	W		
R	12-19	NISSAN NV1500 All	
R	12-19	NV2500 All	
R	12-19	NV3500 All	
G64177	W		
R	19-22	COACH HOUSE PLATINUM III All MotorHomes with Ford Transit-350 Chassis	
R	19-22	COACHMEN BEYOND All MotorHomes with Ford Transit-350 Chassis	
R	21-22	CROSS TRAIL TRANSIT All MotorHomes with Ford Transit-350 Chassis	
R	25	FORD TRANSIT-150	
R	15-24	TRANSIT-150 All	
R	25	TRANSIT-250	
R	15-24	TRANSIT-250 All	
R	25	TRANSIT-350	
R	15-24	TRANSIT-350 All	
R	19-22	LEISURE TRAVEL WONDER All MotorHomes with Ford Transit-350 Chassis	
G64186	D		
R	14-18	TOYOTA HIGHLANDER All	
G64216	W		
R	10-15	HYUNDAI TUCSON AWD	
R	11-16	KIA SPORTAGE AWD	
G64268	W		
R	17-24	FORD PICKUP 1 TON, F-350 / SUPERDUTY 4WD	
R	17-23	PICKUP 3/4 TON, F-250 / SUPERDUTY 4WD	

Numerical listing

Shock	POP	Alternative No.	MTG Acc. Supplied
Pos.	Year	Application	
G64269	W		
R	17-24	FORD PICKUP 1 TON, F-350 / SUPERDUTY RWD	
R	17-24	PICKUP 3/4 TON, F-250 / SUPERDUTY RWD	
Ultra Shock			
69420	W		
R	00-06	AUDI TT All	
69450	W		
R	00-05	TOYOTA ECHO All	
69464	W	142950	
R	08-11	FORD FOCUS All	
R	00-07	FOCUS Hatchback	
R	00-07	FOCUS Sedan	
69465	W		
R	00-07	FORD FOCUS Wagon	
69473	C		
R	01-10	CHRYSLER PT CRUISER All	
69574	D	140505	
R	03-11	FORD CROWN VICTORIA Police Interceptor	
R	03-11	LINCOLN TOWN CAR All Limo Models	
69575	A	140505	
R	10-11	FORD CROWN VICTORIA Base Exc. Police and Taxi Models	
R	03-11	CROWN VICTORIA LX Exc. Police and Taxi Models	
R	03-08	CROWN VICTORIA Base Exc. Police and Taxi Models	
R	04-06	CROWN VICTORIA LX Sport Exc. Police and Taxi Models	
R	05	CROWN VICTORIA S Exc. Police and Taxi Models	
R	05	CROWN VICTORIA Special Edition Exc. Police and Taxi Models	
R	03	CROWN VICTORIA LWB Exc. Police and Taxi Models	
R	03	CROWN VICTORIA S Exc. Police and Taxi Models	
R	03-11	LINCOLN TOWN CAR All	
R	03-11	MERCURY GRAND MARQUIS All	
R	03-04	MARAUDER All	
69585	W		
R	01-03	KIA RIO All	
69586	W	142155	
R	01-08	AUDI A4 All	
R	01-08	A4 QUATTRO All Mfg. from 11/00; Exc. Sport Suspension	
69587	A		
R	05-10	CHEVROLET COBALT LS	
R	05-10	COBALT LT	
R	10	COBALT Base	
R	10	COBALT LT Team Canada	
R	06-07	COBALT LTZ	
R	05	COBALT Base	
R	11	HHR All	
R	08-10	HHR LS Panel	
R	08-10	HHR LT Panel	
R	06-10	HHR LS	
R	06-10	HHR LT	
R	06-08	HHR Comfort LT	
R	06-08	HHR Elegance LT	
R	07	HHR Edicion Especial	
R	07-09	PONTIAC G5 All	
R	05-06	PURSUIT All	
R	08-09	SATURN ASTRA All	
R	03-07	ION All	
69589	D		
R	08	CHEVROLET MALIBU Classic LS	
R	08	MALIBU Classic LT	
R	06-07	MALIBU LTZ	
R	06-07	MALIBU SS	
R	04-07	MALIBU LS	
R	04-07	MALIBU LT	
R	04-05	MALIBU Base	
69590	A	143269	
R	09-12	CHEVROLET MALIBU All	
R	08	MALIBU Hybrid	
R	08	MALIBU LS	
R	08	MALIBU LT	
R	08	MALIBU LTZ	
R	04-07	MALIBU Maxx LS	
R	04-07	MALIBU Maxx LT	

Ultra Truck Shock, Ultra Shock

Shock	POP	Alternative No.	MTG Acc. Supplied
Pos.	Year	Application	
69590	A (cont)		143269
R	04	MALIBU Maxx	
R	05-10	PONTIAC G6 All	
R	07-09	SATURN AURA XE	
R	07-09	AURA XR	
69591	B		
R	06-12	FORD FUSION FWD	
R	07-12	LINCOLN MKZ FWD	
R	06	ZEPHYR All	
R	03-08	MAZDA 6 All	
R	06-11	MERCURY MILAN FWD	
69592	C	140524	
R	05-14	FORD MUSTANG / MUSTANG II Coupe	
69593	W	140524	
R	05-14	FORD MUSTANG / MUSTANG II Convertible	
69594	W		
R	13-15	NISSAN XTERRA RWD	
R	12	XTERRA RWD Mfg. to 12/12	
R	05-11	XTERRA RWD	
69595	C		
R	13-15	NISSAN XTERRA 4WD	
R	12	XTERRA 4WD Mfg. to 12/12	
R	05-11	XTERRA 4WD	
69600	A	140455	
F	87-91	AVANTI II All	
F	73-75	BUICK APOLLO All	
F	73-81	CENTURY All	
F	68-72	GS / GS350 / GS400 / GS455 All	
F	73-87	REGAL All	
F	75-79	SKYLARK All	
F	68-72	SKYLARK All	
F	68-69	SPECIAL All	
F	68-72	SPORTWAGON All	
F	76-79	CADILLAC SEVILLE All	
F	67-69	CHEVROLET CAMARO All	
F	68-73	CHEVELLE All	
F	68	CHEVY II All	
F	73-83	MALIBU All	
F	70-88	MONTE CARLO All	
F	69-79	NOVA All	
F	64-65	NISSAN 410 All	
F	64-67	411 All	
F	68-87	OLDSMOBILE CUTLASS / CUTLASS SUPREME All	
F	80-84	CUTLASS CALAIS All	
F	80-83	CUTLASS CLASSIC / CUTLASS CRUISER All	
F	68-72	F85 All	
F	74-79	OMEGA All	
F	73	OMEGA All Exc. Heavy Duty Suspension	
F	68-75	VISTA CRUISER All	
F	82-86	PONTIAC BONNEVILLE All	
F	67-69	FIREBIRD All	
F	78-80	GRAND AM All	
F	73-75	GRAND AM All	
F	75-83	GRAND LEMANS All	
F	69-87	GRAND PRIX All	
F	71-75	GRANDVILLE All	
F	68-73	GTO All	
F	68-81	LEMANS All	
F	77-79	PHOENIX All	
F	68-70	TEMPEST All	
F	71-77	VENTURA All	
F	78	TOYOTA CORONA All	
F	73-77	CORONA All Mfg. from 8/73	
F	69-72	CORONA Mark II	
F	68-75	VOLVO 142 / 144 / 145 / 164 All	
69604	A	140629	
R	87-88	AVANTI II All	
R	73-81	BUICK CENTURY All	
R	71-83	ESTATE WAGON All	
R	65-67	GRAN SPORT All	
R	68-72	GS / GS350 / GS400 / GS455 All	
R	73-87	REGAL All	
R	91-96	ROADMASTER Wagon	
R	68-72	SKYLARK All	
R	64-67	SKYLARK All Heavy Duty Suspension	
R	68-69	SPECIAL All	
R	64-67	SPECIAL All Heavy Duty Suspension	
R	70-72	SPORTWAGON All	
R	71-72	CHEVROLET BROOKWOOD All	
R	71-96	CAPRICE Wagon	
R	68-73	CHEVELLE All	

Numerical listing

Shock	POP	Alternative No.	MTG Acc. Supplied
Pos.	Year	Application	
69604	A (cont)		140629
R	64-67	CHEVELLE All Heavy Duty Suspension	
R	71-82	IMPALA Wagon	
R	71-72	KINGSWOOD All	
R	73-83	MALIBU All	
R	64-67	MALIBU All Heavy Duty Suspension	
R	70-88	MONTE CARLO All	
R	71-72	TOWNSMAN All	
R	75-76	NISSAN 610 Wagon	
R	73-74	610 All	
R	74-77	710 Wagon	
R	78-80	810 Wagon	
R	71-92	OLDSMOBILE CUSTOM CRUISER All	
R	71-87	CUTLASS / CUTLASS SUPREME All	
R	68-72	CUTLASS / CUTLASS SUPREME All Heavy Duty Suspension	
R	64-66	CUTLASS / CUTLASS SUPREME All Heavy Duty Suspension	
R	80-84	CUTLASS CALAIS All	
R	80-83	CUTLASS CLASSIC / CUTLASS CRUISER All	
R	68-72	F85 All	
R	61-67	F85 All Heavy Duty Suspension	
R	71-78	TORONADO All	
R	82-86	PONTIAC BONNEVILLE All	
R	77-81	CATALINA Wagon	
R	71-75	CATALINA Wagon	
R	78-80	GRAND AM All	
R	73-75	GRAND AM All	
R	75-83	GRAND LEMANS All	
R	69-87	GRAND PRIX All	
R	71-78	GRAND SAFARI All	
R	71-75	GRANDVILLE All	
R	68-73	GTO All	
R	64-67	GTO All Heavy Duty Suspension	
R	68-81	LEMANS All	
R	64-67	LEMANS All Heavy Duty Suspension	
R	80-86	PARISIENNE Wagon	
R	76-79	PARISIENNE All Wagon	
R	87-89	SAFARI All	
R	68-70	TEMPEST All	
R	64-67	TEMPEST All Heavy Duty Suspension	
69606	A	141150	
R	64-69	BUICK SPORTWAGON All	
R	68-69	CHEVROLET CAMARO All Multi-Leaf Springs	
R	65-74	FORD COUNTRY SEDAN All	
R	87-91	COUNTRY SQUIRE All	
R	65-74	COUNTRY SQUIRE All	
R	92-02	CROWN VICTORIA All	
R	65-72	CUSTOM All	
R	68-77	CUSTOM 500 All	
R	75-76	ELITE All	
R	66-70	FAIRLANE All Wagon; Multi-Leaf Rear Spring	
R	66-70	FALCON All Wagon; Multi-Leaf Rear Spring	
R	65-67	GALAXIE All	
R	68-74	GALAXIE 500 All	
R	64-66	GALAXIE 500 All	
R	01-02	GRAND MARQUIS All	
R	87-91	LTD / COUNTRY SEDAN / COUNTRY SQUIRE / CROWN VICTORIA All	
R	65-82	LTD / COUNTRY SEDAN / COUNTRY SQUIRE / CROWN VICTORIA All	
R	77-79	LTD II All	
R	66-79	RANCHERO All	
R	65-74	RANCH WAGON All	
R	77-79	THUNDERBIRD All	
R	67-72	THUNDERBIRD All	
R	68-76	TORINO All	
R	70-80	LINCOLN CONTINENTAL All	
R	68-71	MARK III All	
R	72	MARK IV All	
R	80-83	MARK VI All	
R	81-02	TOWN CAR All	
R	67	MERCURY BROUGHAM All	
R	87-91	COLONY PARK All	
R	65-74	COLONY PARK All	
R	66-67	COMET Wagon	
R	65-68	COMMUTER All	
R	74-79	COUGAR All	
R	75-02	GRAND MARQUIS All	
R	69-70	MARAUDER All	
R	65-67	MARAUDER All	
R	67-82	MARQUIS All	
R	65-68	MONTCLEAR All	

Numerical listing

Shock	POP	Alternative No.	MTG Acc. Supplied
Pos.	Year	Application	
69606		A (cont)	141150
R	68-76	MONTEGO All	
R	65-74	MONTEREY All	
R	65-68	PARKLANE All	
R	65-67	VILLAGER All	
R	66-67	VOYAGER All	
R	64-72	OLDSMOBILE VISTA CRUISER All	
R	68-69	PONTIAC FIREBIRD All	
69622		A	
R	63-82	CHEVROLET CORVETTE All	
69624		A	140524
R	70-81	CHEVROLET CAMARO All	
R	57-59	FORD COUNTRY SQUIRE All	
R	57-58	COURIER SEDAN DELIVERY All	
R	57-58	DEL RIO WAGON All	
R	57-58	RANCH WAGON All	
R	57-58	SKYLARK All	
R	57-58	SUNLINER All	
R	70-81	PONTIAC FIREBIRD All	
69625		A	140877
F	58-60	CADILLAC DEVILLE All	
F	56	DEVILLE All	
F	56-60	FLEETWOOD / 60 SERIES / 70 SERIES All	
F	55-57	CHEVROLET BEL AIR All	
F	60-64	CORVAIR All	
F	61-64	CORVAIR TRUCK All	
F	63-82	CORVETTE All	
F	55-57	ONE-FIFTY SERIES All	
F	55-57	TWO-TEN SERIES All	
F	58	EDSEL BERMUDA All	
F	58	CITATION All	
F	58-59	CORSAIR All	
F	58	PACER All	
F	58	ROUNDUP All	
F	58-60	VILLAGER All	
F	57-64	FORD COUNTRY SEDAN All	
F	57-64	COUNTRY SQUIRE All	
F	57-60	COURIER SEDAN DELIVERY All	
F	64-66	CUSTOM All	
F	57	CUSTOM All	
F	58-60	CUSTOM 300 All	
F	57-58	DEL RIO WAGON All	
F	57-61	FAIRLANE All	
F	59-64	GALAXIE All	
F	59	RANCHERO All	
F	57-64	RANCH WAGON All	
F	57-59	SKYLARK All	
F	60	STARLINER All	
F	57-60	SUNLINER All	
F	57-60	THUNDERBIRD All	
F	57-60	VICTORIA All	
F	57-64	MERCURY COLONY PARK All	
F	64	COMMUTER All	
F	57-62	COMMUTER All	
F	63	COUNTRY CRUISER All	
F	63-64	MARAUDER All	
F	58	MEDALIST All	
F	64	MONTCLAIR All	
F	57-60	MONTCLAIR All	
F	57-64	MONTEREY All	
F	64	PARKLANE All	
F	58-60	PARKLANE All	
F	57	TURNPIKE CRUISER All	
F	62-64	VILLAGER All	
F	57-59	VOYAGER All	
F	58-64	PONTIAC BONNEVILLE All	
F	58-64	CATALINA All	
F	58	CHIEFTAIN All	
F	62-64	GRAND PRIX All	
F	58-64	STAR CHIEF All	
F	58	SUPER CHIEF All	
F	60-61	VENTURA All	
F	65-67	TOYOTA CROWN All	
69632		W	
R	84-93	CHRYSLER DAYTONA All	
R	83-84	E CLASS All	
R	85	EXECUTIVE LIMOUSINE All	
R	83-84	EXECUTIVE SEDAN All	
R	90-93	IMPERIAL All Exc. Hydraulic Self-Leveling System	
R	84-86	LASER All	
R	81-95	LEBARON All	
R	88-93	NEW YORKER All Exc. Hydraulic Self-Leveling System	
R	83-87	NEW YORKER All	
R	92-95	SPIRIT All	
R	82-88	TOWN & COUNTRY All	
R	82-83	DODGE 400 All	
R	83-88	600 All	
R	81-89	ARIES All	
R	92-93	DAYTONA Iroc R/T	

Ultra Shock

Shock	POP	Alternative No.	MTG Acc. Supplied
Pos.	Year	Application	
69632		W (cont)	
R	91-93	DAYTONA Iroc	
R	89-93	DAYTONA ES	
R	89-90	DAYTONA ES Turbo	
R	87-88	DAYTONA Pacifica	
R	86	DAYTONA Turbo Z	
R	84-85	DAYTONA Turbo	
R	85-89	LANCER All	
R	87-94	SHADOW All	
R	89-95	SPIRIT All	
R	89-95	PLYMOUTH ACCLAIM All	
R	88	CARAVELLE FWD	
R	83-87	CARAVELLE All	
R	81-89	RELIANT All	
R	87-94	SUNDANCE All	
69675		A	141041
F	71-73	BUICK CENTURION All	
F	91-96	COMMERCIAL CHASSIS All	
F	71-84	ELECTRA All	
F	71-83	ESTATE WAGON All	
F	71-85	LESABRE All	
F	71-78	RIVIERA All	
F	92-96	ROADMASTER All	
F	91	ROADMASTER Wagon	
F	87-92	CADILLAC BROUGHAM All	
F	92-96	COMMERCIAL CHASSIS RWD	
F	77-84	COMMERCIAL CHASSIS All	
F	77-84	DEVILLE All	
F	93-96	FLEETWOOD RWD	
F	77-86	FLEETWOOD RWD	
F	81	CHEVROLET BEL AIR Sedan Exc. Police and Taxi Models	
F	65-75	BEL AIR Sedan Exc. Police and Taxi Models	
F	71-72	BISCAYNE All	
F	69-72	BROOKWOOD All	
F	70-81	CAMARO All	
F	66-96	CAPRICE All	
F	94-96	IMPALA All	
F	65-85	IMPALA All	
F	69-72	KINGSWOOD All	
F	69-72	TOWNSMAN All	
F	65-74	FORD COUNTRY SEDAN All	
F	87-91	COUNTRY SQUIRE All	
F	65-74	COUNTRY SQUIRE All	
F	92-02	CROWN VICTORIA All	
F	67-72	CUSTOM All	
F	68-77	CUSTOM 500 All	
F	75-76	ELITE All	
F	65-67	GALAXIE All	
F	68-74	GALAXIE 500 All	
F	64-66	GALAXIE 500 All	
F	01-02	GRAND MARQUIS All	
F	87-91	LTD / COUNTRY SEDAN / COUNTRY SQUIRE / CROWN VICTORIA All	
F	65-82	LTD / COUNTRY SEDAN / COUNTRY SQUIRE / CROWN VICTORIA All	
F	77-79	LTD II All	
F	65-74	RANCH WAGON All	
F	67-79	THUNDERBIRD All	
F	72-76	TORINO All	
F	70-80	LINCOLN CONTINENTAL All	
F	68-71	MARK III All	
F	72-76	MARK IV All	
F	77-79	MARK V All	
F	80-83	MARK VI All	
F	81-02	TOWN CAR All	
F	67	MERCURY BROUGHAM All	
F	87-91	COLONY PARK All	
F	65-74	COLONY PARK All	
F	65-68	COMMUTER All	
F	74-79	COUGAR All	
F	75-02	GRAND MARQUIS All	
F	69-70	MARAUDER All	
F	65-67	MARAUDER All	
F	67-82	MARQUIS All	
F	65-68	MONTCLAIR All	
F	72-76	MONTEGO All	
F	65-74	MONTEREY All	
F	65-68	PARKLANE All	
F	65-67	VILLAGER All	
F	66-67	VOYAGER All	
F	71-85	OLDSMOBILE 88 SERIES All	
F	71-84	98 All	
F	71-92	CUSTOM CRUISER All	
F	71-81	PONTIAC BONNEVILLE All	
F	71-81	CATALINA All	
F	70-81	FIREBIRD All	
F	71-78	GRAND SAFARI All	
F	76-81	LAURENTIAN All	
F	76-86	PARISIENNE All	
F	87-89	SAFARI All	

Numerical listing

Shock	POP	Alternative No.	MTG Acc. Supplied
Pos.	Year	Application	
69676		A	142261
R	82-02	CHEVROLET CAMARO All	
R	82-02	PONTIAC FIREBIRD All	
69677		W	141350
F	72-86	JAGUAR XJ6 All	
F	81-92	XJ12 All	
F	73-79	XJ12 All	
F	76-96	XJS All	
69714		B	141147
F	84-87	CHEVROLET CORVETTE All	
69715		B	
R	84-87	CHEVROLET CORVETTE All	
69724		A	140629
R	89-91	AVANTI II All	
R	73	BUICK APOLLO All Heavy Duty Suspension	
R	71-73	CENTURION All	
R	71-84	ELECTRA All	
R	70	ESTATE WAGON All	
R	71-85	LESABRE All	
R	71-78	RIVIERA All	
R	92-96	ROADMASTER Sedan	
R	64-67	SKYLARK All Exc. Heavy Duty Suspension	
R	64-67	SPECIAL All Exc. Heavy Duty Suspension	
R	87-92	CADILLAC BROUGHAM All	
R	92-96	COMMERCIAL CHASSIS RWD	
R	77-84	COMMERCIAL CHASSIS All	
R	77-84	DEVILLE All	
R	93-96	FLEETWOOD RWD	
R	77-86	FLEETWOOD RWD	
R	81	CHEVROLET BEL AIR Sedan	
R	65-75	BEL AIR All	
R	65-72	BISCAYNE All	
R	69-70	BROOKWOOD All	
R	73-96	CAPRICE Sedan Police and Taxi Models	
R	71-72	CAPRICE Hardtop Police and Taxi Models	
R	66-70	CAPRICE All	
R	64-67	CHEVELLE All Exc. Heavy Duty Suspension	
R	68	CHEVY II All	
R	64-67	EL CAMINO All Exc. Heavy Duty Suspension	
R	94-96	IMPALA Sedan	
R	65-85	IMPALA Sedan	
R	69-70	KINGSWOOD All	
R	64-67	MALIBU All Exc. Heavy Duty Suspension	
R	73	NOVA All Heavy Duty Suspension	
R	69-72	NOVA All	
R	69-70	TOWNSMAN All	
R	65-85	OLDSMOBILE 88 SERIES All	
R	65-84	98 All	
R	64-67	CUTLASS / CUTLASS SUPREME All Exc. Heavy Duty Suspension	
R	65-66	DYNAMIC 88 All	
R	61-67	F85 All Exc. Heavy Duty Suspension	
R	65-66	STARFIRE All	
R	63-81	PONTIAC BONNEVILLE All	
R	75-81	CATALINA Coupe	
R	71-81	CATALINA Sedan	
R	71-74	CATALINA Hardtop	
R	63-70	CATALINA All	
R	67-70	EXECUTIVE All	
R	63-68	GRAND PRIX All	
R	64-67	GTO All Exc. Heavy Duty Suspension	
R	76-81	LAURENTIAN All	
R	64-67	LEMANS All Exc. Heavy Duty Suspension	
R	76-86	PARISIENNE Sedan	
R	63-66	STAR CHIEF All	
R	64-67	TEMPEST All Exc. Heavy Duty Suspension	
R	73	VENTURA All Heavy Duty Suspension	
R	71-72	VENTURA All Leaf(RearSpringType)	
69725		W	140814
R	91	BMW 318i All	
R	84-85	318i All	
R	91	318iS All	
R	86-88	325 All	
R	84-87	325E All	
R	87-92	325i E30 (MfrBodyCode) Exc. Sport Suspension	
R	87-92	325iS All	

Numerical listing

Shock	POP	Alternative No.	MTG Acc. Supplied
Pos.	Year	Application	
69725	W (cont)		140814
R	88-91	M3 All	
69755	A		141301
R	87-93	FORD MUSTANG / MUSTANG II GT, 5.0L 8Cyl V (302), 4.00 101.6(Bore)3.00 76.2(Stroke)	
R	84-86	MUSTANG / MUSTANG II SVO	
R	82-86	MUSTANG / MUSTANG II GT	
69757	D		140045
R	84-89	NISSAN 300ZX All	
69766	W		140800
R	68-73	MERCEDES-BENZ 200D All	
R	68-73	220 / 220D All	
R	74-78	230 All	
R	68-69	230 All	
R	74-83	240D All	
R	68-70	250 All	
R	87-89	260E All Exc. Hydromat Suspension	
R	76	280 All	
R	73-76	280C All	
R	77-81	280CE / 280E / 280S / 280SE / 280SEL All	
R	75-80	280CE / 280E / 280S / 280SE / 280SEL All Exc. Hydromat Suspension	
R	73	280CE / 280E / 280S / 280SE / 280SEL All Exc. Hydromat Suspension	
R	72	280CE / 280E / 280S / 280SE / 280SEL All Mfg. from 9/72; Exc. Hydromat Suspension	
R	80-85	300CD All	
R	75-84	300D All W123	
R	78-91	300SD / 300SDL / 300SE / 300SEL / 300TD / 350SD / 350SDL / 350SL / 380SE / 380SEC / 380SEL All Exc. Hydromat Suspension	
R	72	300SD / 300SDL / 300SE / 300SEL / 300TD / 350SD / 350SDL / 350SL / 380SE / 380SEC / 380SEL All	
R	81-85	380SL / 380SLC All	
R	86-91	400E / 400SE / 400SEL / 420SEL / 450SE / 450SEL All Exc. Hydromat Suspension	
R	73-80	400E / 400SE / 400SEL / 420SEL / 450SE / 450SEL All Exc. Hydromat Suspension	
R	74-80	450SL / 450SLC All	
R	84-91	500SEC / 500SEL / 500SEC / 560SEC / 560SEL All Exc. Hydromat Suspension	
69787	W		
R	75	VOLVO 142 / 144 / 145 / 164 All	
R	75-93	240 / 242 / 244 / 245 / 262 / 264 / 265 All	
R	84	DL All Exc. Hydraulic Self-Leveling System	
R	84	GLE All Exc. Hydraulic Self-Leveling System	
69795	C		141666
R	88-96	CHEVROLET CORVETTE All Exc. Electronic Adjustable Suspension	
69811	B		141665
F	89-96	CHEVROLET CORVETTE All Exc. Electronic Adjustable Suspension	
69813	C		140455
R	01-05	TOYOTA RAV4 All	
R	00	RAV4 All Mfg. from 5/00	
69845	W		141743
R	92-97	FORD THUNDERBIRD All Exc. Electronic Adjustable Suspension	
R	92-97	MERCURY COUGAR All Exc. Electronic Adjustable Suspension	
69863	W		142155
R	92-99	BMW 318i All	
R	92-98	318IS All	
R	00	323CI All	
R	00	323i Wagon	
R	98-99	323i All	
R	98-99	323IS All	
R	01-06	325CI All	
R	01-05	325i All	
R	92-95	325i E36 (MfrBodyCode)	
R	00	328CI All	
R	96-00	328i All	
R	96-99	328IS All	
R	01-06	330CI All	

Ultra Shock

Shock	POP	Alternative No.	MTG Acc. Supplied
Pos.	Year	Application	
69863	W (cont)		142155
R	01-05	330I All	
69898	A		140126
R	03-04	FORD MUSTANG / MUSTANG II Mach 1	
R	94-04	MUSTANG / MUSTANG II Base	
R	94-04	MUSTANG / MUSTANG II GT	
R	04	MUSTANG / MUSTANG II GT Base	
R	04	MUSTANG / MUSTANG II GT Equipado	
R	01	MUSTANG / MUSTANG II GT Bullitt	
R	95	MUSTANG / MUSTANG II GTS	
69900	D		140455
R	01-07	FORD ESCAPE All	
R	01-06	MAZDA TRIBUTE All	
R	05-07	MERCURY MARINER All	
69901	W		
R	93-97	VOLVO 850 All Exc. Hydraulic Self-Leveling System	
R	98-04	C70 All	
R	98-00	S70 All	
R	98-00	V70 All Mfg. to 3/00; Exc. XC Cross Country	
69903	W		
R	95-99	BMW 318TI All	
69907	W		141716
R	01-06	HYUNDAI SANTA FE All	
69909	D		
R	99-04	HONDA ODYSSEY All	
69945	C		142155
R	98-10	VOLKSWAGEN BEETLE All	
R	99-06	GOLF A4 (MfrBodyCode)	
R	01-05	JETTA Sedan	
R	99-00	JETTA All	
69946	W		141191
R	98-04	AUDI A6 All	
R	98-05	VOLKSWAGEN PASSAT FWD From VIN# 3B300001 through VIN# 3B300000	
69952	W		
F	00-02	MERCEDES-BENZ E55 AMG All	
F	96-99	E300 All Exc. Sport Suspension	
F	96-02	E320 Sedan Exc. Sport Suspension	
F	97	E420 All Exc. 4 Matic & Sport Suspension	
F	98-02	E430 All Exc. 4 Matic & Sport Suspension	
69962	W		141727,141354
R	96-05	FORD TAURUS Wagon	
R	96-05	MERCURY SABLE Wagon	
69966	W		
R	99	MERCEDES-BENZ E300 All Exc. 4 Matic	
R	96-98	E300 All	
R	96-02	E320 Sedan	
R	97	E420 All	
R	98-02	E430 All	
69996	W		140800,142628
F	77-78	MERCEDES-BENZ 230 All Exc. W115	
F	76-83	240D All W123	
F	87-89	260E All Exc. Hydromat Suspension	
F	76	280 All	
F	76	280C All Exc. W115	
F	77-81	280CE / 280E / 280S / 280SE / 280SEL All	
F	75-80	280CE / 280E / 280S / 280SE / 280SEL All Exc. Hydromat Suspension	
F	73	280CE / 280E / 280S / 280SE / 280SEL All Exc. Hydromat Suspension	
F	72	280CE / 280E / 280S / 280SE / 280SEL All Mfg. from 9/72; Exc. Hydromat Suspension	
F	80-85	300CD All	
F	77-84	300D All	
F	76	300D All W123	
F	78-91	300SD / 300SDL / 300SE / 300SEL / 300TD / 350SD / 350SDL / 350SL / 380SE / 380SEC / 380SEL All Exc. Hydromat Suspension	
F	79-85	300SD / 300SDL / 300SE / 300SEL / 300TD / 350SD / 350SDL / 350SL / 380SE / 380SEC / 380SEL All	

Numerical listing

Shock	POP	Alternative No.	MTG Acc. Supplied
Pos.	Year	Application	
69996	W (cont)		140800,142628
F	86-91	400E / 400SE / 400SEL / 420SEL / 450SE / 450SEL All Exc. Hydromat Suspension	
F	73-80	400E / 400SE / 400SEL / 420SEL / 450SE / 450SEL All Exc. Hydromat Suspension	
F	84-91	500SEC / 500SEL / 500SEC / 560SEC / 560SEL All Exc. Hydromat Suspension	
69998	W		
R	01-03	BMW 525i Wagon Exc. Electronic Adjustable Suspension	
R	99-00	528i Wagon	
R	00-03	540i Wagon Exc. Electronic Adjustable Suspension	
70000	W		
R	02-05	KIA SEDONA All	
70001	W		
R	04-05	KIA RIO All	
70003	W		
R	08-09	MAZDA 3 GS	
R	08-09	3 GT	
R	08-09	3 GX	
R	07-09	3 i	
R	07-09	3 S	
R	04-06	3 All	
R	06-10	5 All	
70010	D		
R	05-10	HONDA ODYSSEY All	
70013	D		
R	06-11	HYUNDAI AZERA All	
R	06-10	SONATA All	
70020	W		142154
R	01-02	SAAB 9-3 Turbo	
R	99-02	9-3 SE	
R	99-01	9-3 Base	
70024	D		
R	94-99	MERCEDES-BENZ S320 / S350 / S420 / S500 / S600 All Exc. Electronic Ride Control	
70027	B		
R	07-12	NISSAN SENTRA All	
70028	W		
R	04-06	SCION XA All	
R	04-06	XB All	
70031	W		
R	03-07	CADILLAC CTS All Exc. Magnetic Ride Control Suspension	
70033	W		
R	02-07	MERCEDES-BENZ C230 All	
R	03-05	C240 RWD	
R	01-02	C240 All	
R	06-07	C280 RWD	
R	03-05	C320 RWD	
R	01-02	C320 All	
R	06-07	C350 RWD	
R	03-05	CLK320 All	
R	06-09	CLK350 All	
R	03	CLK430 All	
R	02	CLK430 All Mfg. from 4/02	
R	03-06	CLK500 All	
R	07-09	CLK550 All	
70034	D		
R	04-10	BMW X3 All	
70036	B		
R	06-11	DODGE ATTITUDE All	
R	06-11	HYUNDAI ACCENT All	
R	06-11	KIA RIO All	
R	06-11	RIO All	
R	14-19	SOUL All	
70037	W		
R	09-10	HYUNDAI ELANTRA GL	
R	09-10	ELANTRA GLS	
R	09-10	ELANTRA L	
R	09-10	ELANTRA Limited	
R	09-10	ELANTRA SE	
R	10	ELANTRA Blue	
R	07-08	ELANTRA All Exc. Touring Models	

Numerical listing

Shock	POP	Alternative No.	MTG Acc. Supplied
Pos.	Year	Application	
70038 C			
R	13-15	MERCEDES-BENZ C250 All Exc. Electronic Suspension	
R	10-12	C250 All	
R	08-09	C280 All	
R	08-11	C300 All	
R	12	C350 CGI (FuelDelSubType)	
R	08-11	C350 All	
70039 W			
R	08-11	SAAB 9-3 FWD	
R	03-07	9-3 All	
70040 W			
R	04-09	VOLVO S60 FWD	
R	01-03	S60 All	
R	99-06	S80 All	
R	01-07	V70 All Exc. Electronic Suspension / Nivomat	
70041 W			
R	12	NISSAN VERSA All	
R	07-11	VERSA S	
R	07-11	VERSA SL	
70045 C			
R	08-13	BMW 128i All	
R	12-13	135i All Exc. Sport Suspension	
R	08-11	135i All	
R	06	325i All	
R	14	328D All	
R	14	328D XDRIVE All	
R	07-14	328i All Exc. F30 Suspension	
R	07-08	328XI All	
R	06	330i All	
R	07-13	335i All	
R	11-13	335iS All	
70049 W			
R	07-10	KIA MAGENTIS All	
R	07-10	OPTIMA All	
R	07-11	RONDO All	
70052 A			
R	11-19	FORD FIESTA All	
R	11-14	MAZDA 2 All	
70053 D			
R	08-15	SCION XB All	
R	10-15	TOYOTA PRIUS All Models w/ 17" Wheels	
70055 C			
R	08-10	SCION XD All	
R	17	TOYOTA PRIUS C All	
R	15-16	PRIUS C All Models w/ 15" or 16" Wheels	
R	12-14	PRIUS C All	
R	06-14	YARIS All	
70056 W			
R	07-13	VOLVO C30 All	
R	05-12	S40 All	
R	04	S40 All Mfg. to 04/00	
R	05-11	V50 All	
70059 B			
R	10	BUICK ALLURE FWD Exc. Electronic Suspension	
R	10-16	LACROSSE FWD Exc. Electronic Suspension	
70060 C			
R	06-08	HONDA FIT All	
70064 D			
F	04-08	CHRYSLER CROSSFIRE All	
F	98-02	MERCEDES-BENZ CLK320 All	
F	99-02	CLK430 All	
F	98-04	SLK230 All	
F	03-04	SLK320 All	
F	01-02	SLK320 170.465 (MfrBodyCode)	
70065 D			
R	04-08	CHRYSLER CROSSFIRE All	
R	98-02	MERCEDES-BENZ CLK320 All	
R	02	CLK430 All Mfg. to 4/02	
R	99-01	CLK430 All	
R	98-04	SLK230 All	
R	03-04	SLK320 All	
R	01-02	SLK320 170.465 (MfrBodyCode)	
70068 C			
R	12-17	HYUNDAI AZERA All	
R	11-14	SONATA All	
R	14-16	KIA CADENZA All	
R	14-15	OPTIMA Limited	

Ultra Shock

Shock	POP	Alternative No.	MTG Acc. Supplied
Pos.	Year	Application	
70068 C (cont)			
R	14-15	OPTIMA SX Turbo	
R	14-15	OPTIMA SXL Turbo	
R	13-15	OPTIMA EX Luxury	
R	11-15	OPTIMA EX	
R	11-15	OPTIMA LX	
R	11-15	OPTIMA SX	
R	13	OPTIMA SXL	
70078 W			
R	07-09	KIA SORENTO All Exc. HPD (High Performance Dampers)	
70086 W			
R	05-10	CHRYSLER 300 AWD Exc. Nivomat Suspension	
R	07-10	DODGE CHARGER AWD Exc. Nivomat Suspension	
70089 D			
R	09-14	NISSAN MAXIMA All	
70095 B			
R	12-14	DODGE ATTITUDE All	
R	12-17	HYUNDAI ACCENT All	
R	12-17	VELOSTER All	
R	12-17	KIA RIO All	
70096 D			
R	16-19	FORD POLICE INTERCEPTOR SEDAN All	
R	18-19	TAURUS All	
R	10-17	TAURUS Limited w/ Suspension Code A and B	
R	10-17	TAURUS SE w/ Suspension Code A and B	
R	10-17	TAURUS SEL w/ Suspension Code A and B	
R	09-12	LINCOLN MKS All	
70098 B			
R	11-16	HYUNDAI ELANTRA All	
70102 W			
R	11-13	KIA FORTE Sedan	
70203 C			
R	11-13	KIA SORENTO All	
70204 W			
R	14-20	CHEVROLET IMPALA All	
70207 W			
R	14-17	MAZDA 3 All	
70208 W			
R	14-18	KIA FORTE5 All	
R	17-18	FORTE Hatchback	
R	14-16	FORTE All Hatchback	
R	14-17	FORTE KOUP All	
70209 W			
R	13-16	KIA OPTIMA Hybrid EX	
R	13-16	OPTIMA Hybrid LX	
R	16	OPTIMA Hybrid	
R	16	OPTIMA Hybrid EX Premium	
R	14	OPTIMA Hybrid EX Premium	
R	11-13	OPTIMA Hybrid	
R	13	OPTIMA Hybrid Premium	
70210 W			
R	14-15	KIA SORENTO FWD	
70213 W			
R	14-15	KIA SORENTO AWD	
70231 W			
R	18-19	HYUNDAI ACCENT All	
G51721 C			
R	11-22	CHRYSLER 300 RWD	
R	05-10	300 RWD Exc. Nivomat Suspension	
R	11-22	DODGE CHALLENGER RWD Exc. Nivomat Suspension	
R	07-22	CHARGER RWD Exc. Nivomat Suspension	
R	06	CHARGER All Exc. Nivomat Suspension	
R	05-08	MAGNUM All Exc. Nivomat Suspension	
G51783 D			
R	07-11	TOYOTA YARIS All Exc. Dust Boot	
G51798 W			
R	03-07	NISSAN MURANO All	

Numerical listing

Shock	POP	Alternative No.	MTG Acc. Supplied
Pos.	Year	Application	
G51799 C			
R	06-13	AUDI A3 All Exc. Electronic Suspension	
R	06-13	A3 QUATTRO All Exc. Electronic Suspension	
R	06-09	VOLKSWAGEN BORA All	
R	09-17	CC All	
R	12-14	GOLF Comfortline TDI	
R	12-14	GOLF Highline TDI	
R	11-14	GOLF Base	
R	11-14	GOLF Comfortline	
R	11-14	GOLF TDI	
R	11-14	GOLF Trendline	
R	14	GOLF Trendline TDI	
R	11-13	GOLF Sportline	
R	13	GOLF GTI	
R	11-12	GOLF Highline	
R	11	GOLF TDI Comfortline	
R	11	GOLF TDI Highline	
R	06-14	GTI All	
R	06-09	JETTA All	
R	06-10	PASSAT All	
R	06-09	RABBIT All	
G51802 W			
R	04-08	NISSAN MAXIMA All	
G51803 W			
R	04-09	NISSAN QUEST All	
G51804 C			
R	15-18	TOYOTA SIENNA FWD	
R	04-10	SIENNA FWD 7 Passenger	
G51805 C			
R	14-18	TOYOTA SIENNA AWD	
R	11-13	SIENNA AWD, 3.5L 6Cyl V (3456)	
R	04-10	SIENNA AWD	
R	04-10	SIENNA FWD 8 Passenger	
G51807 C			
R	06-11	ACURA CSX All	
R	06-11	HONDA CIVIC All	
G51812 W			
R	03-06	INFINITI G35 Coupe Sport Suspension	
R	03-05	NISSAN 350Z All Sport Suspension	
G51841 W			
R	01-04	VOLVO S40 All	
R	00	S40 All Mfg. from 4/00	
R	01-04	V40 All	
R	00	V40 All Mfg. from 4/00	
G51871 B			
R	97-13	CHEVROLET CORVETTE All Exc. Electronic Adjustable Suspension	
G51874 A			
R	19-20	NISSAN ALTIMA All w/Rebound Spring	
R	07-18	ALTIMA All	
G51884 B			
R	17-19	NISSAN MURANO All	
R	15-16	MURANO Platinum	
R	14-16	MURANO S	
R	14-16	MURANO SL	
R	14-16	MURANO SV	
R	14	MURANO Exclusive	
R	14	MURANO LE	
R	08-13	MURANO All	
G51904 A			
F	97-13	CHEVROLET CORVETTE All Exc. Electronic Adjustable Suspension	
G51905 D			
R	10-12	HONDA CITY All	
R	13-14	FIT DX	
R	13-14	FIT EX	
R	13-14	FIT LX	
R	13-14	FIT Sport	
R	13	FIT Base	
R	09-12	FIT All	
G51930 D			
R	97-01	INFINITI Q45 All	
G51965 C			
R	13-20	FORD FUSION All	
G51966 D			
R	07-12	ACURA RDX All	

Numerical listing

Shock	POP	Alternative No.	MTG Acc. Supplied
Pos.	Year	Application	
G51971	B		
R	10-15	CHEVROLET	CRUZE All
R	16		CRUZE LIMITED All
G51972	W		
R	12-16	HONDA	CR-V All
G51975	W		
R	10-12	CHEVROLET	CAMARO SS
G51980	A		
R	11-19	FORD	EXPLORER All
R	13-19		POLICE INTERCEPTOR UTILITY All
G51982	D		
R	11-17	BUICK	REGAL FWD Exc. Active Suspension
G51983	B		
R	10-13	MAZDA	3 All
G51990	D		
R	14-16	NISSAN	NOTE All
R	13-20		VERSA All
R	17-19		VERSA NOTE All
G51992	W		
R	11-14	TOYOTA	SIENNA FWD, 3.5L 6Cyl V (3456)
G51993	D		
R	09-17	VOLKSWAGEN	TIGUAN All
R	18		TIGUAN LIMITED All
G51994	W		
R	07-09	KIA	AMANTI All
G51996	B		
R	09-19	FORD	FLEX All
R	10-17	LINCOLN	MKT All
G511000	B		
R	11-21	DODGE	DURANGO All
R	11-22	JEEP	GRAND CHEROKEE All Exc. Load Leveling Suspensions
G511001	C		
R	12-19	FORD	ESCAPE All
G511002	W		
R	13-14	FORD	FOCUS All Exc. Heavy Duty Suspension; Naturally Aspirated Vehicles
R	12		FOCUS All Exc. Heavy Duty Suspension
G511004	W		
R	12-13	MINI	OUTLANDER GT
R	12-13		OUTLANDER SE
R	12-13		OUTLANDER XLS
R	10-11		OUTLANDER GT w/ 3rd Row Seating
R	09-11		OUTLANDER SE w/ 3rd Row Seating
R	09-11		OUTLANDER XLS w/ 3rd Row Seating
R	08		OUTLANDER XLS
R	07		OUTLANDER All
G511007	W		
R	14	TOYOTA	SIENNA AWD 2.7L
R	11-13		SIENNA AWD, 2.7L 4Cyl L (163)
G511030	D		
R	13-22	BUICK	ENCORE All
R	13-22	CHEVROLET	TRAX All
G511037	W		
R	11-16	HONDA	CR-Z All
G511038	D		
R	14-17	JEEP	CHEROKEE FWD
G511043	C		
R	16-20	INFINITI	QX60 All
R	13-20	NISSAN	PATHFINDER All
G511044	D		
R	13-15	NISSAN	SENTRA All
G511078	W		
R	13-18	MAZDA	CX-5 All
G511092	B		
R	12-15	HONDA	CIVIC All

Ultra Shock, Max Control

Shock	POP	Alternative No.	MTG Acc. Supplied
Pos.	Year	Application	
G511122	W		143429
R	14-16	NISSAN	JUKE Automatic CVT
G511134	W		
R	13-18	FORD	FOCUS BATTERY EV (EV/BEV) Exc. Sport Suspension
R	12		FOCUS BATTERY EV (EV/BEV) Exc. Sport Suspension; Electric Vehicles
G511135	W		
R	13-18	FORD	FOCUS EcoBoost w/ Sport Suspension
G511142	C		
R	13-16	DODGE	DART All Sport Suspension
Max Control			
75676	D		142261
R	82-02	CHEVROLET	CAMARO All
R	82-02	PONTIAC	FIREBIRD All
77375	C		140780
F	85-05	CHEVROLET	ASTRO RWD
F	81		BEL AIR All
F	71-75		BEL AIR All
F	71-72		BISCAYNE All
F	73-96		CAPRICE Sedan Police and Taxi Models
F	71-72		CAPRICE All Sedan; Police and Taxi Models
F	83-85		IMPALA All Police and Taxi Models
F	71-82		IMPALA Sedan Police and Taxi Models
F	96-02		VAN 1/2 TON, G / EXPRESS All
F	96-02		VAN 1 TON, G / EXPRESS All
F	96-02		VAN 3/4 TON, G / EXPRESS All Exc. 8600# GVW
F	93-02	FORD	CROWN VICTORIA Police Interceptor
F	85-05	GMC	SAFARI RWD
F	96-02		VAN 1/2 TON, G / SAVANA RWD
F	96-02		VAN 1 TON, G / SAVANA All
F	96-02		VAN 3/4 TON, G / SAVANA All Exc. 8600# GVW
77403	D		
R	79-95	CHEVROLET	VAN 1 TON, G / EXPRESS All 9200# GVW
F	85		VAN 1 TON, P SERIES All Motorhome Chassis w/ I-Beam Front Suspension
R	97-04	DODGE	DAKOTA All
R	98-03		DURANGO All
R	79-95	GMC	VAN 1 TON, G / SAVANA Cutaway Van 9200# GVW
F	85		VAN 1 TON, P SERIES All Motorhome Chassis w/ I-Beam Front Suspension
77412	A		
R	18-24	CHEVROLET	PICKUP 1/2 TON, SILVERADO 1500 All Exc. Z45 Adaptable Ride Control (22 Inch Wheels)
R	07		PICKUP 1/2 TON, SILVERADO 1500 4WD Old Body Style; Exc. Electronic Adjustable Suspension
R	99-06		PICKUP 1/2 TON, SILVERADO 1500 4WD Exc. Electronic Adjustable Suspension
R	05-06		PICKUP 1/2 TON, SILVERADO 1500 HD All
R	01-03		PICKUP 1/2 TON, SILVERADO 1500 HD All
R	77-86		PICKUP 1 TON, K30 All
R	90-91		PICKUP 1 TON, R3500 All
R	89		PICKUP 1 TON, R3500 Cab & Chassis, RWD
R	89		PICKUP 1 TON, R3500 Crew Cab Pickup, RWD
R	01-09		PICKUP 1 TON, SILVERADO 3500 All
R	08-10		PICKUP 1 TON, SILVERADO 3500 HD All
R	07		PICKUP 1 TON, SILVERADO 3500 HD All Classic
R	87-88		PICKUP 1 TON, V30 All
R	89-91		PICKUP 1 TON, V3000 / V3500 All
R	99-08		PICKUP 3/4 TON, SILVERADO 2500 All
R	01-10		PICKUP 3/4 TON, SILVERADO 2500 HD All

Numerical listing

Shock	POP	Alternative No.	MTG Acc. Supplied
Pos.	Year	Application	
77412	A (cont)		
R	07		SILVERADO 1500 HD CLASSIC 4WD
R	19		SILVERADO 1500 LD All
R	07		SILVERADO 2500 HD CLASSIC All
R	08-10	DODGE	PICKUP 1/2 TON, RAM 1500 (SEE RAM 1500) All
R	06-07		PICKUP 1/2 TON, RAM 1500 (SEE RAM 1500) All Exc. Mega Cab
R	02-05		PICKUP 1/2 TON, RAM 1500 (SEE RAM 1500) All
R	77-86	GMC	PICKUP 1 TON, K35 / K3500 All
R	87-91		PICKUP 1 TON, V3000 / V3500 All
R	19-24		SIERRA 1500 All Exc. Z45 Adaptable Ride Control (22 Inch Wheels)
R	18		SIERRA 1500 All
R	07		SIERRA 1500 4WD Old Body Style; Exc. Electronic Adjustable Suspension
R	99-06		SIERRA 1500 4WD Exc. Electronic Adjustable Suspension
R	05-06		SIERRA 1500 HD All
R	01-03		SIERRA 1500 HD All
R	07		SIERRA 1500 HD CLASSIC All
R	19		SIERRA 1500 LIMITED All
R	99-04		SIERRA 2500 All
R	01-10		SIERRA 2500 HD All
R	07		SIERRA 2500 HD CLASSIC 4WD
R	01-06		SIERRA 3500 All
R	07		SIERRA 3500 CLASSIC All
R	07-10		SIERRA 3500 HD All
R	20-22	JEEP	GLADIATOR All
R	11-18	RAM	1500 (SEE DODGE RAM 1500) All
R	19-20		1500 CLASSIC All
77414	C		140780
F	80-96	FORD	BRONCO All Rearward of Front Axle; Exc. Lift Kit
F	89		BRONCO II All Mfg. from 2/89; Vehicles w/ 12mm bolt in rear lower mount
F	84-88		BRONCO II All w/ 10mm Bolt In Rear Lower Mount
F	97		F-250 HD 4WD
F	80-83		PICKUP 1/2 TON, F-100 RWD
F	80-96		PICKUP 1/2 TON, F-150 4WD Rearward of Front Axle; Exc. Lift Kit
F	80-96		PICKUP 1/2 TON, F-150 RWD
F	80-97		PICKUP 1 TON, F-350 / SUPERDUTY RWD
F	97		PICKUP 3/4 TON, F-250 / SUPERDUTY RWD Over 8500# GVW
F	80-96		PICKUP 3/4 TON, F-250 / SUPERDUTY RWD
F	87-89		RANGER All Exc. High Ryder Option
F	83-86		RANGER All
77422	C		
R	05	CHEVROLET	BLAZER Base, 4WD
R	05		BLAZER Base, RWD
R	96-04		BLAZER LS, 4WD
R	96-04		BLAZER LS, RWD
R	95-02		BLAZER LT, RWD
R	95-01		BLAZER LT, 4WD
R	95-99		BLAZER Base, 4WD
R	95-99		BLAZER Base, RWD
R	95-97		BLAZER Deluxe, RWD
R	83-94		BLAZER, S MODELS All
R	04-12		COLORADO Torsion Bar (FrontSpringType)
R	94-04		S10 LS, 4WD
R	02-03		S10 Base, RWD
R	02-03		S10 LS, RWD
R	83-03		S10 Base, 4WD
R	99-00		S10 Base, RWD
R	99-00		S10 LS, RWD
R	92-93		S10 EL, 4WD
R	83-92		S10 Tahoe, 4WD
R	88-90		S10 Durango, 4WD
R	83-86		S10 Durango, 4WD
R	04-12	GMC	CANYON RWD, Torsion Bar (FrontSpringType)
R	05		JIMMY 4WD
R	92-04		JIMMY All
R	83-91		S15 JIMMY All
R	82-04		SONOMA / S15 All
R	91		SYCLONE All
R	92-93		TYPHOON All
R	96-00	ISUZU	HOMBRE All
R	06		I-280 Coil (FrontSpringType)

Numerical listing

Shock	POP	Alternative No.	MTG Acc. Supplied
Pos.	Year	Application	
77422	C	(cont)	
R 06	I-280 RWD, Coil (FrontSpringType)		
R 96-01	OLDSMOBILE BRAVADA All		
R 91-94	BRAVADA All		
77423	D		
F 05	CHEVROLET BLAZER Base, 4WD Exc. ZR2		
F 03-04	BLAZER LS, 4WD Exc. ZR2		
F 02	BLAZER LS, 4WD		
F 96-01	BLAZER LS, 4WD Exc. ZR2		
F 01	BLAZER LT, 4WD		
F 95-00	BLAZER LT, 4WD Exc. ZR2		
F 98-99	BLAZER Base, 4WD Exc. ZR2		
F 97	BLAZER Base, 4WD		
F 95-96	BLAZER Base, 4WD Exc. ZR2		
F 83-94	BLAZER, S MODELS 4WD		
F 02-04	S10 LS, 4WD Exc. ZR2, ZR5 or Sport Chassis		
F 02-03	S10 Base, 4WD Exc. ZR2, ZR5 or Sport Chassis		
F 01	S10 4WD Exc. ZR2, ZR5 or Sport Chassis		
F 94-00	S10 LS, 4WD Exc. ZR2, ZR5 or Sport Chassis		
F 83-00	S10 Base, 4WD Exc. ZR2, ZR5 or Sport Chassis		
F 92-93	S10 EL, 4WD Exc. ZR2, ZR5 or Sport Chassis		
F 83-92	S10 Tahoe, 4WD Exc. ZR2, ZR5 or Sport Chassis		
F 88-90	S10 Durango, 4WD Exc. ZR2, ZR5 or Sport Chassis		
F 83-86	S10 Durango, 4WD Exc. ZR2, ZR5 or Sport Chassis		
F 92-05	GMC JIMMY 4WD		
F 83-91	S15 JIMMY 4WD		
F 83-04	SONOMA / S15 4WD		
F 91	SYCLONE All		
F 92-93	TYPHOON All		
F 99-00	ISUZU HOMBRE 4WD		
F 96-98	HOMBRE All Sport Chassis		
F 96-01	OLDSMOBILE BRAVADA All		
F 91-94	BRAVADA All		
77425	W		
R 84-01	JEEP CHEROKEE All		
R 84-90	WAGONEER All		
77454	W		
R 90-05	CHEVROLET ASTRO All		
R 85-89	ASTRO RWD		
R 90-05	GMC SAFARI All		
R 85-89	SAFARI RWD		
77455	C		
F 86-97	FORD PICKUP 1 TON, F-350 / SUPERDUTY 4WD		
F 97-98	PICKUP 3/4 TON, F-250 / SUPERDUTY 4WD Over 8500# GVW		
F 87-96	PICKUP 3/4 TON, F-250 / SUPERDUTY 4WD		
77461	B		
R 97	FORD F-250 HD 4WD		
R 80-96	PICKUP 1/2 TON, F-150 4WD Exc. Lift Kit		
R 86-97	PICKUP 1 TON, F-350 / SUPERDUTY 4WD Dual Rear Wheels		
R 82-85	PICKUP 1 TON, F-350 / SUPERDUTY 4WD Clevis Type Lower Front Mount; Exc. Dual Rear Wheels or Lift Kit		
R 80-81	PICKUP 1 TON, F-350 / SUPERDUTY 4WD		
R 97	PICKUP 3/4 TON, F-250 / SUPERDUTY 4WD Over 8500# GVW		
R 87-96	PICKUP 3/4 TON, F-250 / SUPERDUTY 4WD		
R 82-86	PICKUP 3/4 TON, F-250 / SUPERDUTY 4WD Clevis Type Lower Front Mount; Exc. Dual Rear Wheels or Lift Kit		
R 80-81	PICKUP 3/4 TON, F-250 / SUPERDUTY 4WD		
77479	W	140524	
F 86-95	TOYOTA 4RUNNER All		
F 86-95	PICKUP 4WD Exc. Lift Kit		
F 93-98	T100 4WD		

Max Control

Shock	POP	Alternative No.	MTG Acc. Supplied
Pos.	Year	Application	
77488	B		
R 88-02	CHEVROLET PICKUP 1/2 TON, C15 / C1500 All		
R 88-99	PICKUP 1/2 TON, K15 / K1500 All		
R 91-00	PICKUP 1 TON, C35/3500 All		
R 89-90	PICKUP 1 TON, C35/3500 Extended Cab Pickup		
R 89-90	PICKUP 1 TON, C35/3500 Standard Cab Pickup		
R 88	PICKUP 1 TON, C35/3500 Extended Cab Pickup Exc. HD Straight Front Axle		
R 88	PICKUP 1 TON, C35/3500 Standard Cab Pickup Exc. HD Straight Front Axle		
R 88-00	PICKUP 1 TON, K35 / K3500 All		
R 88-00	PICKUP 3/4 TON, C25 / C2500 All		
R 88-00	PICKUP 3/4 TON, K25 / K2500 All		
R 88-99	GMC PICKUP 1/2 TON, C15 / C1500 All		
R 88-99	PICKUP 1/2 TON, K15 / K1500 All		
R 91-00	PICKUP 1 TON, C35/3500 All		
R 88-90	PICKUP 1 TON, C35/3500 Extended Cab Pickup Exc. HD Straight Front Axle		
R 88-90	PICKUP 1 TON, C35/3500 Standard Cab Pickup Exc. HD Straight Front Axle		
R 88-00	PICKUP 1 TON, K35 / K3500 All		
R 88-00	PICKUP 3/4 TON, C25 / C2500 All		
R 88-00	PICKUP 3/4 TON, K25 / K2500 All		
77489	C		
F 88-02	CHEVROLET PICKUP 1/2 TON, C15 / C1500 All		
F 98-00	PICKUP 1 TON, C35/3500 All Exc. HD Straight Front Axle		
F 92-97	PICKUP 1 TON, C35/3500 Crew Cab Pickup Exc. HD Straight Front Axle		
F 88-97	PICKUP 1 TON, C35/3500 Extended Cab Pickup Exc. HD Straight Front Axle		
F 88-97	PICKUP 1 TON, C35/3500 Standard Cab Pickup Exc. HD Straight Front Axle		
F 88-00	PICKUP 3/4 TON, C25 / C2500 All		
F 92-99	SUBURBAN 1/2 TON, C15 / C1500 All		
F 92-99	SUBURBAN 3/4 TON, C25 / C2500 All		
F 95-00	TAHOE RWD Old Body Style		
F 88-99	GMC PICKUP 1/2 TON, C15 / C1500 All		
F 92-00	PICKUP 1 TON, C35/3500 Crew Cab Pickup Exc. HD Straight Front Axle		
F 88-00	PICKUP 1 TON, C35/3500 Extended Cab Pickup Exc. HD Straight Front Axle		
F 88-00	PICKUP 1 TON, C35/3500 Standard Cab Pickup Exc. HD Straight Front Axle		
F 88-00	PICKUP 3/4 TON, C25 / C2500 All		
F 92-99	SUBURBAN 1/2 TON, C15 / C1500 All		
F 92-99	SUBURBAN 3/4 TON, C25 / C2500 All		
F 92-99	YUKON RWD		
77494	D	140149	
R 84-89	TOYOTA 4RUNNER All		
R 84-95	PICKUP 4WD Exc. Lift Kit		
R 98-04	TACOMA Pre Runner, RWD		
R 04	TACOMA Base, 4WD		
R 95-03	TACOMA 4WD		
77524	D		
R 98-11	FORD RANGER Torsion Bar (FrontSpringType)		
R 90-97	RANGER 4WD		
R 89	RANGER 4WD Mfg. from 2/89; Vehicles w/ 12mm bolt in rear lower mount		
R 95-96	MAZDA B2300 4WD		
R 98-07	B3000 Torsion Bar (FrontSpringType)		
R 98-09	B4000 Torsion Bar (FrontSpringType)		
77525	C		
R 90	FORD BRONCO II All		
R 89	BRONCO II All Mfg. from 2/89; Vehicles w/ 12mm bolt in rear lower mount		

Numerical listing

Shock	POP	Alternative No.	MTG Acc. Supplied
Pos.	Year	Application	
77525	C	(cont)	
R 98-11	RANGER RWD, Coil (FrontSpringType)		
R 90-97	RANGER RWD		
R 89	RANGER RWD Mfg. from 2/89; Vehicles w/ 12mm bolt in rear lower mount		
R 01-09	MAZDA B2300 RWD		
R 94-97	B2300 RWD		
R 98-01	B2500 RWD, Coil (FrontSpringType)		
R 03-07	B3000 RWD, Coil (FrontSpringType)		
R 94-01	B3000 RWD, Coil (FrontSpringType)		
R 94-00	B4000 RWD, Coil (FrontSpringType)		
77607	W	140719	
R 00-05	FORD EXCURSION RWD		
R 91-94	EXPLORER All		
R 91-94	MAZDA NAVAJA All		
77608	W	140780	
F 91-94	FORD EXPLORER All		
F 92-14	VAN 1/2 TON, ECONOLINE / CLUB WAGON All		
F 91-94	MAZDA NAVAJA All		
77609	A		
F 99-00	CADILLAC ESCALADE All		
F 90-05	CHEVROLET ASTRO 4WD		
F 92-94	BLAZER 4WD Full Size		
F 88-99	PICKUP 1/2 TON, K15 / K1500 All		
F 88-00	PICKUP 1 TON, K35 / K3500 All		
F 88-00	PICKUP 3/4 TON, K25 / K2500 All		
F 92-99	SUBURBAN 1/2 TON, K15 / K1500 All		
F 92-99	SUBURBAN 3/4 TON, K25 / K2500 All		
F 95-00	TAHOE 4WD Old Body Style		
F 88-99	GMC PICKUP 1/2 TON, K15 / K1500 All		
F 88-00	PICKUP 1 TON, K35 / K3500 All		
F 88-00	PICKUP 3/4 TON, K35 / K3500 All		
F 90-05	SAFARI AWD		
F 92-99	SUBURBAN 1/2 TON, K15 / K1500 All		
F 92-99	SUBURBAN 3/4 TON, K25 / K2500 All		
F 92-99	YUKON 4WD		
77614	A	140780	
F 90	FORD BRONCO II All		
F 96-99	ECONOLINE SUPER DUTY All		
F 00-05	EXCURSION RWD		
F 90-97	RANGER All		
F 21-24	VAN 1 TON, ECONOLINE / CLUB WAGON / SUPERDUTY All		
F 07-19	VAN 1 TON, ECONOLINE / CLUB WAGON / SUPERDUTY All Exc. Cutaway Chassis		
F 99-08	VAN 1 TON, ECONOLINE / CLUB WAGON / SUPERDUTY All		
F 92-05	VAN 1 TON, ECONOLINE / CLUB WAGON / SUPERDUTY All Cutaway Chassis		
F 92-14	VAN 3/4 TON, ECONOLINE / CLUB WAGON / SUPERDUTY All		
F 94-97	MAZDA B2300 All		
F 94-97	B3000 RWD		
F 94-97	B4000 RWD		
F 25	THOR MOTOR COACH FOUR WINDS 282		
77623	D	142731	
R 96-99	FORD ECONOLINE SUPER DUTY All		
R 10-14	VAN 1/2 TON, ECONOLINE / CLUB WAGON All		
R 21-24	VAN 1 TON, ECONOLINE / CLUB WAGON / SUPERDUTY All		
R 04-19	VAN 1 TON, ECONOLINE / CLUB WAGON / SUPERDUTY All Exc. Cutaway Chassis		
R 07-08	VAN 1 TON, ECONOLINE / CLUB WAGON / SUPERDUTY All		
R 92-05	VAN 1 TON, ECONOLINE / CLUB WAGON / SUPERDUTY All Cutaway Chassis		
R 99-03	VAN 1 TON, ECONOLINE / CLUB WAGON / SUPERDUTY All		
R 92-14	VAN 3/4 TON, ECONOLINE / CLUB WAGON / SUPERDUTY All		
R 25	THOR MOTOR COACH FOUR WINDS 282		

Numerical listing

Shock	POP	Alternative No.	MTG Acc. Supplied
Pos.	Year	Application	
77638 A			
R	99-00	CADILLAC	ESCALADE All
R	92-94	CHEVROLET	BLAZER 4WD Full Size
R	92-99		SUBURBAN 1/2 TON, C15 / C1500 All
R	92-99		SUBURBAN 1/2 TON, K15 / K1500 All
R	92-99		SUBURBAN 3/4 TON, C25 / C2500 All
R	92-99		SUBURBAN 3/4 TON, K25 / K2500 All
R	95-00		TAHOE All Old Body Style
R	96-14		VAN 1/2 TON, G / EXPRESS All
R	03-24		VAN 1 TON, G / EXPRESS All
R	03-24		VAN 3/4 TON, G / EXPRESS All
R	96-02		VAN 3/4 TON, G / EXPRESS All Exc. 8600# GVW
R	92-99	GMC	SUBURBAN 1/2 TON, C15 / C1500 All
R	92-99		SUBURBAN 1/2 TON, K15 / K1500 All
R	92-99		SUBURBAN 3/4 TON, C25 / C2500 All
R	92-99		SUBURBAN 3/4 TON, K25 / K2500 All
R	96-14		VAN 1/2 TON, G / SAVANA RWD
R	04-24		VAN 1 TON, G / SAVANA All
R	96-02		VAN 1 TON, G / SAVANA All Exc. 8600# GVW
R	96		VAN 1 TON, G / SAVANA All 7100, 7400 and 8600# GVW
R	03-24		VAN 3/4 TON, G / SAVANA All
R	96-02		VAN 3/4 TON, G / SAVANA All Exc. 8600# GVW
R	92-99		YUKON All
77661 D			
F	94-01	DODGE	PICKUP 1/2 TON, RAM 1500 (SEE RAM 1500) RWD
F	94-02		PICKUP 1 TON, RAM 3500 (SEE RAM 3500) RWD Exc. Solid Front Axle
F	94-02		PICKUP 3/4 TON, RAM 2500 (SEE RAM 2500) RWD
77662 C			
R	07	CHEVROLET	PICKUP 1/2 TON, SILVERADO 1500 RWD Old Body Style; Exc. Electronic Adjustable Suspension
R	99-06		PICKUP 1/2 TON, SILVERADO 1500 RWD Exc. Electronic Adjustable Suspension
R	74-80		VAN 1/2 TON, P SERIES All
R	79-89		VAN 3/4 TON, P SERIES All
R	94-01	DODGE	PICKUP 1/2 TON, RAM 1500 (SEE RAM 1500) All
R	94-02		PICKUP 1 TON, RAM 3500 (SEE RAM 3500) RWD Exc. Solid Front Axle
R	94-02		PICKUP 3/4 TON, RAM 2500 (SEE RAM 2500) All Exc. 8800# GVW
R	99-07	GMC	SIERRA 1500 RWD Exc. Electronic Adjustable Suspension
R	74-80		VAN 1/2 TON, P SERIES All
R	75-99		VAN 1 TON, P SERIES All
R	73-74		VAN 1 TON, P SERIES Base Cutaway Chassis
R	74		VAN 1 TON, P SERIES Motorhome
77673 W 142731			
F	94-01	DODGE	PICKUP 1/2 TON, RAM 1500 (SEE RAM 1500) 4WD
F	94-02		PICKUP 3/4 TON, RAM 2500 (SEE RAM 2500) 4WD Exc. 8800# GVW
77674 D 142731			
F	94-02	DODGE	PICKUP 1 TON, RAM 3500 (SEE RAM 3500) 4WD
F	94-02		PICKUP 1 TON, RAM 3500 (SEE RAM 3500) RWD Solid Front Axle
F	94-02		PICKUP 3/4 TON, RAM 2500 (SEE RAM 2500) 4WD 8800# GVW
77675 D			
R	94-02	DODGE	PICKUP 1 TON, RAM 3500 (SEE RAM 3500) 4WD
R	94-02		PICKUP 1 TON, RAM 3500 (SEE RAM 3500) RWD Solid Front Axle
R	94-02		PICKUP 3/4 TON, RAM 2500 (SEE RAM 2500) 4WD 8800# GVW
77678 C			
F	95-01	FORD	EXPLORER All Exc. Adjustable Suspension

Max Control

Shock	POP	Alternative No.	MTG Acc. Supplied
Pos.	Year	Application	
77678 C (cont)			
F	01-05		EXPLORER SPORT TRAC All
F	98-11		RANGER Torsion Bar (FrontSpringType)
F	98-07	MAZDA	B3000 Torsion Bar (FrontSpringType)
F	98-09		B4000 Torsion Bar (FrontSpringType)
F	97-01	MERCURY	MOUNTAINEER All Exc. Electronic Adjustable Suspension
77679 W 140719			
R	95-01	FORD	EXPLORER All Exc. Adjustable Suspension
R	01-05		EXPLORER SPORT TRAC All
R	97-01	MERCURY	MOUNTAINEER All Exc. Electronic Adjustable Suspension
77683 W			
R	93-98	JEEP	GRAND CHEROKEE All
77714 W 142731			
F	97-02	FORD	EXPEDITION RWD Exc. Front Air- Leveling
F	97-03		LOBO RWD
F	97-04		PICKUP 1/2 TON, F-150 RWD
F	96-99		PICKUP 3/4 TON, F-250 / SUPERDUTY RWD Up through 8500# GVW
F	98-02	LINCOLN	NAVIGATOR RWD
77715 C 142700			
R	98-03	FORD	LOBO 4WD
R	97-04		PICKUP 1/2 TON, F-150 4WD
R	97-99		PICKUP 3/4 TON, F-250 / SUPERDUTY 4WD Up through 8500# GVW
77716 A 142731			
F	97-02	FORD	EXPEDITION 4WD Exc. Front Air- Leveling
F	98-03		LOBO 4WD
F	04		PICKUP 1/2 TON, F-150 4WD Exc. 7000# GVW
F	97-03		PICKUP 1/2 TON, F-150 4WD
F	97-99		PICKUP 3/4 TON, F-250 / SUPERDUTY 4WD Up through 8500# GVW
77717 W			
R	97-02	FORD	EXPEDITION All
R	98-02	LINCOLN	NAVIGATOR RWD
77726 C 140921			
R	90-02	TOYOTA	4RUNNER All
77772 C 140780			
F	06-11	FORD	RANGER RWD, Coil (FrontSpringType)
F	01-05		RANGER XL, RWD, Coil (FrontSpringType)
F	01-05		RANGER XLT, RWD, Coil (FrontSpringType)
F	01-02		RANGER EV Coil (FrontSpringType)
F	02		RANGER Sport, RWD, Coil (FrontSpringType)
F	98-00		RANGER XL, RWD
F	98-00		RANGER XLT, RWD
F	01-09	MAZDA	B2300 RWD
F	98-01		B2500 RWD
F	98-07		B3000 RWD
F	98-09		B4000 RWD
77783 C 141665			
F	99-07	CHEVROLET	PICKUP 1/2 TON, SILVERADO 1500 RWD Exc. Electronic Adjustable Suspension
F	99-04		PICKUP 3/4 TON, SILVERADO 2500 RWD Exc. Electronic Adjustable Suspension
F	01-04		PICKUP 3/4 TON, SILVERADO 2500 HD RWD
F	99-07	GMC	SIERRA 1500 RWD Exc. Electronic Adjustable Suspension
F	99-04		SIERRA 2500 RWD Exc. Electronic Adjustable Suspension
F	01-04		SIERRA 2500 HD RWD
77803 A 143276			
F	02-06	CADILLAC	ESCALADE All
F	02-04		ESCALADE EXT All
F	02-06	CHEVROLET	AVALANCHE 1500 All Exc. Electronic Ride Control

Numerical listing

Shock	POP	Alternative No.	MTG Acc. Supplied
Pos.	Year	Application	
77803 A (cont) 143276			
F	07		PICKUP 1/2 TON, SILVERADO 1500 All Old Body Style; Exc. Electronic Adjustable Suspension
F	99-06		PICKUP 1/2 TON, SILVERADO 1500 4WD Exc. Electronic Adjustable Suspension
F	00-06		SUBURBAN 1/2 TON, 1500 All Exc. Z55 Auto Ride Suspension
F	02-06		TAHOE All Exc. Z55 Auto Ride Suspension
F	00-01		TAHOE All New Body Style; Exc. Z55 Auto Ride Suspension
F	07	GMC	SIERRA 1500 4WD Old Body Style; Exc. Electronic Adjustable Suspension
F	99-06		SIERRA 1500 4WD Exc. Electronic Adjustable Suspension
F	00-06		YUKON All Exc. Z55 Auto Ride Suspension
F	00-06		YUKON XL 1/2 TON All Exc. Z55 Auto Ride Suspension
77807 C 142617			
F	99-24	FORD	PICKUP 1 TON, F-350 / SUPERDUTY RWD
F	11-16		PICKUP 1 TON, F-350 / SUPERDUTY All
F	99-09		PICKUP 1 TON, F-350 / SUPERDUTY All
F	99-24		PICKUP 3/4 TON, F-250 / SUPERDUTY RWD
77808 W			
R	99-04	FORD	PICKUP 1 TON, F-350 / SUPERDUTY RWD
R	99-04		PICKUP 3/4 TON, F-250 / SUPERDUTY RWD
77809 A			
F	00-05	FORD	EXCURSION 4WD
R	97		F-250 HD All
R	85-96		PICKUP 1/2 TON, F-150 RWD
F	99-04		PICKUP 1 TON, F-350 / SUPERDUTY 4WD
R	80-97		PICKUP 1 TON, F-350 / SUPERDUTY RWD Exc. Dual Rear Wheels
F	99-04		PICKUP 3/4 TON, F-250 / SUPERDUTY 4WD
R	97		PICKUP 3/4 TON, F-250 / SUPERDUTY RWD Over 8500# GVW
R	80-96		PICKUP 3/4 TON, F-250 / SUPERDUTY RWD
77810 A			
R	99-04	FORD	PICKUP 1 TON, F-350 / SUPERDUTY 4WD
R	99-04		PICKUP 3/4 TON, F-250 / SUPERDUTY 4WD
77815 W 142389			
R	00-06	TOYOTA	TUNDRA All
77817 A 141665			
F	02-06	CHEVROLET	AVALANCHE 2500 All Exc. Electronic Ride Control
F	05-06		PICKUP 1/2 TON, SILVERADO 1500 HD All
F	01-03		PICKUP 1/2 TON, SILVERADO 1500 HD All
F	01-09		PICKUP 1 TON, SILVERADO 3500 All
F	07-10		PICKUP 1 TON, SILVERADO 3500 HD All
F	05-08		PICKUP 3/4 TON, SILVERADO 2500 All
F	99-04		PICKUP 3/4 TON, SILVERADO 2500 4WD
F	01-10		PICKUP 3/4 TON, SILVERADO 2500 HD All 9200# GVW
F	07		SILVERADO 1500 HD CLASSIC All
F	07		SILVERADO 2500 HD CLASSIC All
F	00-13		SUBURBAN 3/4 TON, 2500 All Exc. Z55 Auto Ride Suspension and QuadraSteer
F	05-06	GMC	SIERRA 1500 HD All
F	01-03		SIERRA 1500 HD All
F	07		SIERRA 1500 HD CLASSIC All
F	99-04		SIERRA 2500 4WD
F	01-10		SIERRA 2500 HD 4WD
F	01-06		SIERRA 3500 All
F	07-10		SIERRA 3500 HD Torsion Bar (FrontSpringType)

Numerical listing

Shock	POP	Alternative No.	MTG Acc. Supplied
Pos.	Year	Application	
77817	A (cont)		141665
F	00-06	YUKON XL 3/4 TON All Exc. Hydraulic Self-Leveling System	
F	03-09	HUMMER H2 All	
77829	W		
R	99-04	JEEP GRAND CHEROKEE All	
77837	W		
R	00-05	FORD EXCURSION 4WD	
77847	W		142592,141353
F	99-04	JEEP GRAND CHEROKEE All Exc. Up Country Suspension	
77905	D		140126
F	97-04	DODGE DAKOTA 4WD	
F	98-03	DURANGO 4WD	
77907	W		
R	75-80	CHEVROLET LUV PICKUP All	
R	72-74	LUV PICKUP All	
R	87-93	DODGE PICKUP, RAM 50 RWD	
R	83-86	PICKUP, RAM 50 All	
R	86-87	MAZDA B2000 RWD	
R	87-93	B2200 RWD	
R	87-93	B2600 RWD	
R	95-96	MITSUBISHI MIGHTY MAX All	
R	83-94	MIGHTY MAX RWD	
R	87-90	VAN All	
R	98-04	NISSAN FRONTIER RWD Exc. Desert Runner	
R	87-97	PICKUP RWD	
R	86	PICKUP RWD Mfg. from 8/86	
R	79-82	PLYMOUTH PICKUP All	
R	85-95	TOYOTA PICKUP RWD Exc. 1 Ton	
R	84	PICKUP RWD	
R	75-83	PICKUP RWD Mojave	
R	70-74	PICKUP All RWD	
R	84-88	VAN Leaf (RearSpringType)	
77909	D		141368
F	81-82	CHEVROLET LUV PICKUP 4WD	
F	75-80	LUV PICKUP All	
F	72-74	LUV PICKUP All	
F	89-94	ISUZU AMIGO All	
F	81-95	PICKUP 4WD	
F	84-86	TROOPER 4WD	
F	98-04	NISSAN FRONTIER RWD Exc. Desert Runner	
F	87-97	PICKUP RWD	
F	86	PICKUP RWD Mfg. from 8/86	
77915	D		141349
F	87-04	DODGE DAKOTA RWD	
F	99-03	DURANGO RWD	
77947	W		142731
F	02-05	DODGE PICKUP 1/2 TON, RAM 1500 (SEE RAM 1500) 4WD	
77948	B		142731
F	07-10	DODGE PICKUP 1 TON, RAM 3500 (SEE RAM 3500) 4WD	
F	06	PICKUP 1 TON, RAM 3500 (SEE RAM 3500) 4WD Exc. 5.9L	
F	03-05	PICKUP 1 TON, RAM 3500 (SEE RAM 3500) 4WD	
F	07-10	PICKUP 3/4 TON, RAM 2500 (SEE RAM 2500) 4WD	
F	06	PICKUP 3/4 TON, RAM 2500 (SEE RAM 2500) 4WD, 4.7L 8Cyl V (287), 3.66 93.0(Bore)3.41 86.5(Stroke)	
F	06	PICKUP 3/4 TON, RAM 2500 (SEE RAM 2500) 4WD, 5.9L 6Cyl L (359), 4.02 102.0(Bore)4.72 120.0(Stroke)	
F	03-05	PICKUP 3/4 TON, RAM 2500 (SEE RAM 2500) 4WD	
F	11-20	RAM 2500 (SEE DODGE RAM 2500) 4WD	
F	11-20	3500 (SEE DODGE RAM 3500) 4WD	
77949	W		143000
F	06-08	DODGE PICKUP 1/2 TON, RAM 1500 (SEE RAM 1500) Extended Crew Cab Pickup, RWD	
F	03-10	PICKUP 1 TON, RAM 3500 (SEE RAM 3500) RWD	
F	03-10	PICKUP 3/4 TON, RAM 2500 (SEE RAM 2500) RWD	
F	14-20	RAM 2500 (SEE DODGE RAM 2500) RWD	
F	11-13	2500 (SEE DODGE RAM 2500) Standard Cab Pickup, RWD	

Max Control, Guardian Shock

Shock	POP	Alternative No.	MTG Acc. Supplied
Pos.	Year	Application	
77949	W (cont)		143000
F	11-20	3500 (SEE DODGE RAM 3500) RWD	
77950	A		
R	03-10	DODGE PICKUP 1 TON, RAM 3500 (SEE RAM 3500) All	
R	03-10	PICKUP 3/4 TON, RAM 2500 (SEE RAM 2500) All	
R	11-13	RAM 2500 (SEE DODGE RAM 2500) All	
R	11-13	3500 (SEE DODGE RAM 3500) All	
77951	C		142731
F	05-24	FORD PICKUP 1 TON, F-350 / SUPERDUTY 4WD	
F	11-16	PICKUP 1 TON, F-350 / SUPERDUTY All 4WD	
F	99-09	PICKUP 1 TON, F-350 / SUPERDUTY All 4WD	
F	01-24	PICKUP 3/4 TON, F-250 / SUPERDUTY 4WD	
F	99	PICKUP 3/4 TON, F-250 / SUPERDUTY 4WD	
77952	A		
R	13-16	FORD PICKUP 1 TON, F-350 / SUPERDUTY 4WD	
R	05-12	PICKUP 1 TON, F-350 / SUPERDUTY Crew Cab Pickup, 4WD Single Rear Wheels	
R	05-12	PICKUP 1 TON, F-350 / SUPERDUTY Extended Cab Pickup, 4WD Single Rear Wheels	
R	05-12	PICKUP 1 TON, F-350 / SUPERDUTY Standard Cab Pickup, 4WD Single Rear Wheels	
R	05-16	PICKUP 3/4 TON, F-250 / SUPERDUTY 4WD	
77953	A		
R	02-13	CADILLAC ESCALADE All Exc. Electronic Ride Control	
R	07-13	CHEVROLET AVALANCHE 1500 All Exc. Z55 or ZW7 Ride Suspension	
R	02-06	AVALANCHE 1500 All Exc. Electronic Ride Control	
R	02-06	AVALANCHE 2500 All Exc. Electronic Ride Control	
R	21-22	COLORADO Z71 LT	
R	15-22	COLORADO LT	
R	15-22	COLORADO WT	
R	15-22	COLORADO Z71	
R	15-20	COLORADO Base	
R	15	COLORADO LTZ	
R	07-11	SUBURBAN 1/2 TON, 1500 All Exc. Z55 or ZW7 Ride Suspension	
R	00-06	SUBURBAN 1/2 TON, 1500 All Exc. Z55 Auto Ride Suspension	
R	00-13	SUBURBAN 3/4 TON, 2500 All Exc. Z55 Auto Ride Suspension and Quadrasteer	
R	07-11	TAHOE All Exc. Z55 or ZW7 Ride Suspension	
R	02-06	TAHOE All Exc. Z55 Auto Ride Suspension	
R	00-01	TAHOE All New Body Style; Exc. Z55 Auto Ride Suspension	
R	15-22	GMC CANYON All Exc. ZR2	
R	07-11	YUKON All Exc. Z55 or ZW7 Ride Suspension	
R	00-06	YUKON All Exc. Z55 Auto Ride Suspension	
R	07-11	YUKON XL 1/2 TON All Exc. Z55 or ZW7 Ride Suspension	
R	00-06	YUKON XL 1/2 TON All Exc. Z55 Auto Ride Suspension	
R	00-11	YUKON XL 3/4 TON All Exc. Z55 Auto Ride Suspension and Quadrasteer	
77954	C		143276
F	06-08	DODGE PICKUP 1/2 TON, RAM 1500 (SEE RAM 1500) Crew Cab Pickup, RWD	
F	06-08	PICKUP 1/2 TON, RAM 1500 (SEE RAM 1500) Standard Cab Pickup, RWD	
F	02-05	PICKUP 1/2 TON, RAM 1500 (SEE RAM 1500) RWD	
77971	W		
R	04-07	BUICK RAINIER All	
R	02-09	CHEVROLET TRAILBLAZER Coil (RearSpringType)	
R	02-06	TRAILBLAZER EXT All	

Numerical listing

Shock	POP	Alternative No.	MTG Acc. Supplied
Pos.	Year	Application	
77971	W (cont)		
R	02-09	GMC ENVOY Coil (RearSpringType)	
R	02-06	ENVOY XL All	
R	04-05	ENVOY XUV All	
R	02-04	OLDSMOBILE BRAVADA All	
R	05-09	SAAB 9-7X All	
77973	W		
R	07-17	JEEP WRANGLER 4WD	
77975	B		
R	14-20	CHEVROLET SUBURBAN 1/2 TON, 1500 All	
R	12-19	TAHOE All	
R	12-20	GMC YUKON All	
R	15-20	YUKON XL All	
77976	A		
R	07-17	CHEVROLET PICKUP 1/2 TON, SILVERADO 1500 All	
R	11-24	PICKUP 1 TON, SILVERADO 3500 HD All	
R	11-24	PICKUP 3/4 TON, SILVERADO 2500 HD All	
R	07-17	GMC SIERRA 1500 All	
R	11-24	SIERRA 2500 HD All	
R	11-24	SIERRA 3500 HD All	
R	17-22	NISSAN TITAN 4WD	
R	04-15	TITAN 4WD	
R	16-22	TITAN XD Platinum Reserve. 4WD	
R	20-24	RAM 3500 (SEE DODGE RAM 3500) All	
77978	W		141665
F	97-06	JEEP WRANGLER All	
77980	W		142731
F	06-08	DODGE PICKUP 1/2 TON, RAM 1500 (SEE RAM 1500) 4WD, 5.7L 8Cyl V (345), 3.92 99.57(Bore)3.58 90.93(Stroke)	
F	06	PICKUP 1 TON, RAM 3500 (SEE RAM 3500) 4WD, 5.7L 8Cyl V (345), 3.92 99.57(Bore)3.58 90.93(Stroke)	
F	06	PICKUP 3/4 TON, RAM 2500 (SEE RAM 2500) 4WD, 5.7L 8Cyl V (345), 3.92 99.57(Bore)3.58 90.93(Stroke)	
77981	W		142973
F	07-12	JEEP WRANGLER All	
77983	W		
R	06-10	HUMMER H3 All w/ Off Road Package	
77988	W		
R	17-24	FORD PICKUP 1 TON, F-350 / SUPERDUTY 4WD	
R	17-24	PICKUP 3/4 TON, F-250 / SUPERDUTY 4WD	
Guardian Shock			
81039	A		140357
F	75-84	CHEVROLET BLAZER RWD	
F	69-74	BLAZER All RWD	
F	63-67	C10 PANEL All	
F	63-86	PICKUP 1/2 TON, C10 All	
F	87	PICKUP 1/2 TON, R10 All	
F	63-86	PICKUP 1 TON, C30 All	
F	88-91	PICKUP 1 TON, C35/3500 Cab & Chassis Exc. HD Solid Front Axle	
F	87-88	PICKUP 1 TON, R30 All	
F	89-91	PICKUP 1 TON, R3500 All	
F	63-86	PICKUP 3/4 TON, C20 All	
F	87-88	PICKUP 3/4 TON, R20 All	
F	89	PICKUP 3/4 TON, R2500 All	
F	63-66	SUBURBAN 1/2 TON, 1500 All	
F	67-86	SUBURBAN 1/2 TON, C10 All	
F	87-88	SUBURBAN 1/2 TON, R10 All	
F	89-91	SUBURBAN 1/2 TON, R1500 All	
F	68-86	SUBURBAN 3/4 TON, C20 All	
F	87-88	SUBURBAN 3/4 TON, R20 All	
F	89-91	SUBURBAN 3/4 TON, R2500 All	
F	63-80	VAN 1/2 TON, P SERIES All	
F	68-90	VAN 1 TON, P SERIES All Cutaway Chassis	
F	68-89	VAN 3/4 TON, P SERIES All	
F	75-84	GMC JIMMY RWD	
F	70-74	JIMMY All RWD	
F	67-86	PICKUP 1/2 TON, C15 / C1500 All	
F	87	PICKUP 1/2 TON, R1500 All	
F	88-91	PICKUP 1 TON, C35/3500 Cab & Chassis	
F	80-86	PICKUP 1 TON, C35/3500 All	
F	67-78	PICKUP 1 TON, C35/3500 All	
F	87-91	PICKUP 1 TON, R3500 All	

Numerical listing

Shock	POP	Alternative No.	MTG Acc. Supplied
Pos.	Year	Application	
81039		A (cont)	140357
F	83-86	PICKUP 3/4 TON, C25 / C2500 All	
F	75-82	PICKUP 3/4 TON, C25 / C2500 Cab & Chassis	
F	75-82	PICKUP 3/4 TON, C25 / C2500 Crew Cab Pickup	
F	75-82	PICKUP 3/4 TON, C25 / C2500 Standard Cab Pickup	
F	67-74	PICKUP 3/4 TON, C25 / C2500 All	
F	87-89	PICKUP 3/4 TON, R2500 All Exc. Crew Cab & Bonus Cab	
F	63-66	PICKUP 1000 SERIES All	
F	63-66	PICKUP 1500 SERIES All	
F	66	PICKUP 2500 SERIES All	
F	73-86	SUBURBAN 1/2 TON, C15 / C1500 All	
F	68-72	SUBURBAN 1/2 TON, C15 / C1500 All Coil (FrontSpringType)	
F	87-91	SUBURBAN 1/2 TON, R1500 All	
F	68-86	SUBURBAN 3/4 TON, C25 / C2500 All	
F	87-91	SUBURBAN 3/4 TON, R2500 All	
F	67-80	VAN 1/2 TON, P SERIES All	
F	75-90	VAN 1 TON, P SERIES All Cutaway Chassis	
F	73-74	VAN 1 TON, P SERIES Base Cutaway Chassis	
F	68-72	VAN 1 TON, P SERIES All	
F	68-89	VAN 3/4 TON, P SERIES All	
F	63-65	VAN, PB 1000 SERIES All	
81076		A	140496
F	70-77	FORD MAVERICK All	
F	67-70	MUSTANG / MUSTANG II All	
F	71-77	MERCURY COMET All	
F	67-70	COUGAR All	
81082		C	
R	97	FORD F-250 HD RWD	
R	85-96	PICKUP 1/2 TON, F-150 RWD	
R	80-97	PICKUP 1 TON, F-350 / SUPERDUTY RWD Exc. Dual Rear Wheels	
R	97	PICKUP 3/4 TON, F-250 / SUPERDUTY RWD Over 8500# GVW	
R	80-96	PICKUP 3/4 TON, F-250 / SUPERDUTY RWD	
81091		B	
R	67-73	CHRYSLER IMPERIAL All	
R	70-73	NEWPORT All	
R	70-73	NEW YORKER All	
R	71-73	TOWN & COUNTRY All	
R	73	DODGE MONACO All	
R	71	MONACO All	
R	72-93	PICKUP 1/2 TON, D100 SERIES All	
R	72-93	PICKUP 1 TON, D300 SERIES All	
R	72-93	PICKUP 3/4 TON, D200 SERIES All	
R	73	POLARA All	
R	71	POLARA All	
R	75-93	RAMCHARGER RWD	
R	74	RAMCHARGER All RWD	
R	70-73	PLYMOUTH FURY All	
R	73	FURY All Exc. Wagon	
R	73	GRAN FURY Hardtop	
R	72	GRAN FURY All	
R	75-81	TRAILDUSTER RWD	
R	74	TRAILDUSTER All	
81095		C	140524
R	70-81	CHEVROLET CAMARO All	
R	57-58	FORD COUNTRY SQUIRE All	
R	57-58	COURIER SEDAN DELIVERY All	
R	57-58	DEL RIO WAGON All	
R	57-58	RANCH WAGON All	
R	57-58	SKYLINER All	
R	57-58	SUNLINER All	
R	70-81	PONTIAC FIREBIRD All	
81096		C	140126
F	84-86	DODGE MINI RAM All	
F	72-93	PICKUP 1/2 TON, D100 SERIES All	
F	72-93	PICKUP 3/4 TON, D200 SERIES All Exc. Heavy Duty Package	
F	75-93	RAMCHARGER RWD	
F	99-03	VAN 1/2 TON, A / B SERIES / RAM 109.3 / 277.6 (WheelBase) Exc. 7000# GVW	
F	81-98	VAN 1/2 TON, A / B SERIES / RAM 109.6 / 278.4 (WheelBase) Exc. 7000# GVW	
F	71-80	VAN 1/2 TON, A / B SERIES / RAM All	
F	95-03	VAN 1 TON, A / B SERIES / RAM All	

Guardian Shock

Shock	POP	Alternative No.	MTG Acc. Supplied
Pos.	Year	Application	
81096		C (cont)	140126
F	71-94	VAN 1 TON, A / B SERIES / RAM All Exc. 4000# Front Axle	
F	71-03	VAN 3/4 TON, A / B SERIES / RAM All	
F	74-80	VAN, CB300 All Exc. 4000# Front Axle	
F	75-81	PLYMOUTH TRAILDUSTER RWD	
F	74-83	VAN 1/2 TON, PB SERIES All	
F	74-83	VAN 1 TON, PB SERIES All Exc. 4000# Front Axle	
F	74-83	VAN 3/4 TON, PB SERIES All	
81113		D	
F	69-91	CHEVROLET BLAZER 4WD Exc. Quad Suspension	
F	81-86	PICKUP 1/2 TON, K10 All Standard Suspension; Exc. Lift Kit	
F	69-80	PICKUP 1/2 TON, K10 All Exc. Lift Kit	
F	87	PICKUP 1/2 TON, V10 All Quad Suspension Short Shock; Exc. Lift Kit	
F	81-86	PICKUP 3/4 TON, K20 All Standard Suspension; Exc. Lift Kit	
F	69-80	PICKUP 3/4 TON, K20 All Exc. Lift Kit	
F	81-86	SUBURBAN 1/2 TON, K10 All Standard Suspension; Exc. Lift Kit	
F	69-80	SUBURBAN 1/2 TON, K10 All Exc. Lift Kit	
F	87-88	SUBURBAN 1/2 TON, V10 All Quad Suspension Short Shock; Exc. Lift Kit	
F	81-86	SUBURBAN 3/4 TON, K20 All Standard Suspension; Exc. Lift Kit	
F	69-80	SUBURBAN 3/4 TON, K20 All Exc. Lift Kit	
F	87-88	SUBURBAN 3/4 TON, V20 All Quad Suspension Short Shock; Exc. Lift Kit	
F	89-91	SUBURBAN 3/4 TON, V2500 All Quad Suspension Short Shock; Exc. Lift Kit	
F	75-91	GMC JIMMY 4WD Exc. Quad Suspension	
F	70-74	JIMMY All 4WD; Exc. Quad Suspension	
F	69-86	PICKUP 1/2 TON, K15 / K1500 All Exc. Quad Suspension	
F	87	PICKUP 1/2 TON, V1500 All Quad Suspension Short Shock	
F	69-86	PICKUP 3/4 TON, K25 / K2500 All Exc. Quad Suspension and Lift Kit	
F	87	PICKUP 3/4 TON, V2500 All Quad Suspension Short Shock; Exc. Lift Kit	
F	69-86	SUBURBAN 1/2 TON, K15 / K1500 All Exc. Quad Suspension	
F	87-91	SUBURBAN 1/2 TON, V1500 All Quad Suspension Short Shock	
F	69-86	SUBURBAN 3/4 TON, K25 / K2500 All Exc. Quad Suspension and Lift Kit	
F	87-91	SUBURBAN 3/4 TON, V2500 All Quad Suspension Short Shock; Exc. Lift Kit	
81147		B	
R	56	BUICK ROADMASTER All Exc. Air Suspension	
R	56	SPECIAL All	
R	56	SUPER All	
R	75-80	CHEVROLET LUV PICKUP All	
R	72-74	LUV PICKUP All	
F	55-56	PICKUP 3200	
F	55-56	PICKUP 3600	
F	55-56	PICKUP 3800	
F	55	PICKUP 3100	
R	83-93	DODGE PICKUP, RAM 50 RWD	
F	48-52	FORD F-1 All	
F	48-52	F-2 All	
F	48-52	F-3 All	
R	61-64	PICKUP 1/2 TON, F-100 All	
F	65-66	PICKUP 1 TON, F-350 / SUPERDUTY All	
R	61-64	PICKUP 1 TON, F-350 / SUPERDUTY All	
R	61-64	PICKUP 3/4 TON, F-250 / SUPERDUTY All	
R	68	INTERNATIONAL 908C All	
R	68	1000C All	
R	68	1100C All Exc. 166" Wheelbase	
R	68	1100C All Exc. 166" Wheelbase	
F	68	1200C All Exc. 166" Wheelbase	

Numerical listing

Shock	POP	Alternative No.	MTG Acc. Supplied
Pos.	Year	Application	
81147		B (cont)	
R	68	1200C All Exc. 166" Wheelbase	
F	68	1300C All Exc. 166" Wheelbase	
R	68	1300C All Exc. 166" Wheelbase	
R	72-83	JEEP CJ5 All Exc. Lift Kit	
R	66-71	CJ5 All Exc. 5 Leaf Front Springs & Lift Kit	
R	66-75	CJ6 All Exc. Lift Kit	
R	76-86	CJ7 All Exc. Lift Kit	
R	66-74	DJ5 All Exc. Lift Kit	
R	66-68	DJ6 All	
R	57-60	FC150 All	
F	63-65	FC170 All	
R	63-65	FC170 All	
R	64-66	GLADIATOR All	
R	63	GLADIATOR All Independent Front Suspension	
R	70-71	JEEPSTER All	
R	81-85	SCRAMBLER / CJ8 All	
R	61-67	UNIVERSAL All	
R	86-87	MAZDA B2000 RWD	
R	87-93	B2000 RWD	
R	87-93	B2600 RWD	
R	95-96	MITSUBISHI MIGHTY MAX All	
R	83-94	MIGHTY MAX RWD	
R	87-90	VAN All	
R	98-04	NISSAN FRONTIER RWD Exc. Desert Runner	
R	87-97	PICKUP RWD	
R	86	PICKUP RWD Mfg. from 8/86	
R	79-82	PLYMOUTH PICKUP All	
R	67-68	TOYOTA LAND CRUISER All	
R	84-95	PICKUP RWD Exc. 1 Ton	
R	77-83	PICKUP RWD Mojave	
R	75-76	PICKUP RWD	
R	70-74	PICKUP All RWD	
R	84-88	VAN Leaf (RearSpringType)	
R	88	VAN WAGON All Leaf(RearSpringType)	
81153		W	140126
F	75-79	CHRYSLER CORDOBA All	
F	79-81	NEWPORT All	
F	79-81	TOWN & COUNTRY All	
F	73-78	DODGE CHARGER All	
F	73-76	CORONET All	
F	78-79	MAGNUM All	
F	77-78	MONACO All	
F	79-81	ST. REGIS All	
F	75-78	PLYMOUTH FURY All	
F	80-81	GRAN FURY All	
F	73-75	ROAD RUNNER All	
F	73-74	SATELLITE All	
81164		B	140357
R	87-91	CHEVROLET BLAZER 4WD Full Size; Exc. Quad Suspension	
R	85-86	BLAZER 4WD	
R	73-84	BLAZER All	
R	73-86	PICKUP 1/2 TON, C10 All	
R	73-86	PICKUP 1/2 TON, K10 All Exc. Lift Kit	
R	87	PICKUP 1/2 TON, R10 All	
R	87	PICKUP 1/2 TON, V10 All Exc. Lift Kit	
R	75-86	PICKUP 3/4 TON, C20 Standard Cab Pickup	
R	73-74	PICKUP 3/4 TON, C20 All Standard Cab Pickup	
R	73-86	PICKUP 3/4 TON, K20 All Exc. Lift Kit	
R	87	PICKUP 3/4 TON, R20 Standard Cab Pickup	
R	87	PICKUP 3/4 TON, V20 All Exc. Quad Suspension and Lift Kit	
R	73-86	SUBURBAN 1/2 TON, C10 All	
R	73-86	SUBURBAN 1/2 TON, K10 All Exc. Lift Kit	
R	87-88	SUBURBAN 1/2 TON, R10 All	
R	89-91	SUBURBAN 1/2 TON, R1500 All	
R	89-91	SUBURBAN 1/2 TON, V1500 All Exc. Lift Kit	
R	73-86	SUBURBAN 3/4 TON, C20 All	
R	73-86	SUBURBAN 3/4 TON, K20 All Exc. Lift Kit	
R	87-88	SUBURBAN 3/4 TON, R20 All	
R	89-91	SUBURBAN 3/4 TON, R2500 All	
R	87-88	SUBURBAN 3/4 TON, V20 All Exc. Quad Suspension and Lift Kit	
R	89-91	SUBURBAN 3/4 TON, V2500 All Exc. Lift Kit	
R	73	VAN 1/2 TON, P SERIES All	
R	73-78	VAN 3/4 TON, P SERIES All	
R	73-91	GMC JIMMY All	
R	73-86	PICKUP 1/2 TON, C15 / C1500 All	

Numerical listing

Shock	POP	Alternative No.	MTG Acc. Supplied
Pos.	Year	Application	
81164	B (cont)	140357	
R	73-86	PICKUP 1/2 TON, K15 / K1500 All	
R	87	PICKUP 1/2 TON, R1500 All	
R	87	PICKUP 1/2 TON, V1500 All Exc. Lift Kit	
R	83-86	PICKUP 3/4 TON, C25 / C2500 All	
R	75-82	PICKUP 3/4 TON, C25 / C2500 Cab & Chassis	
R	75-82	PICKUP 3/4 TON, C25 / C2500 Standard Cab Pickup	
R	73-86	PICKUP 3/4 TON, K25 / K2500 All Exc. Lift Kit	
R	88-89	PICKUP 3/4 TON, R2500 All Exc. Crew Cab & Bonus Cab	
R	87	PICKUP 3/4 TON, R2500 Cab & Chassis Exc. Crew Cab & Bonus Cab	
R	87	PICKUP 3/4 TON, R2500 Standard Cab Pickup Exc. Crew Cab & Bonus Cab	
R	87	PICKUP 3/4 TON, V2500 All Exc. Lift Kit	
R	73-86	SUBURBAN 1/2 TON, C15 / C1500 All	
R	73-86	SUBURBAN 1/2 TON, K15 / K1500 All	
R	87-91	SUBURBAN 1/2 TON, R1500 All	
R	87-91	SUBURBAN 1/2 TON, V1500 All Exc. Lift Kit	
R	75-86	SUBURBAN 3/4 TON, C25 / C2500 All	
R	73-74	SUBURBAN 3/4 TON, C25 / C2500 All Exc. Crew Cab & Bonus Cab	
R	73-86	SUBURBAN 3/4 TON, K25 / K2500 All Exc. Lift Kit	
R	87-91	SUBURBAN 3/4 TON, R2500 All	
R	87-91	SUBURBAN 3/4 TON, V2500 All Exc. Lift Kit	
R	73	VAN 1/2 TON, P SERIES All	
R	73-78	VAN 3/4 TON, P SERIES All	
81242	B	140126	
R	62-67	CHEVROLET CHEVY II All	
R	66	FORD BRONCO All Thru Serial #830000	
R	73-79	PICKUP 1/2 TON, F-100 RWD	
R	70-72	PICKUP 1/2 TON, F-100 All RWD	
R	75-79	PICKUP 1/2 TON, F-150 RWD	
R	75-79	PICKUP 1 TON, F-350 / SUPERDUTY Extended Cab Pickup, RWD	
R	75-79	PICKUP 3/4 TON, F-250 / SUPERDUTY Cab & Chassis, RWD	
R	75-79	PICKUP 3/4 TON, F-250 / SUPERDUTY Standard Cab Pickup, RWD	
R	73-74	PICKUP 3/4 TON, F-250 / SUPERDUTY RWD Exc. Supercab	
R	70-72	PICKUP 3/4 TON, F-250 / SUPERDUTY All RWD; Exc. Supercab	
R	75-91	VAN 1/2 TON, ECONOLINE / CLUB WAGON All	
F	71-80	INTERNATIONAL SCOUT II All	
81270	A	140523	
R	75-80	AMERICAN MOTORS PACER All	
F	58	BUICK CENTURY All	
F	58	LIMITED All	
F	58	ROADMASTER All Exc. Air Suspension	
F	58	SPECIAL All Exc. Air Suspension	
F	58	SUPER All Exc. Air Suspension	
F	54-55	CHEVROLET PICKUP All	
F	50-53	PICKUP 3100	
F	50-53	PICKUP 3600	
F	50-53	PICKUP 3800	
R	90-92	DAIHATSU ROCKY All	
R	58	EDSEL PACER All	
R	58-59	RANGER All	
R	62-70	FORD FAIRLANE All	
R	55-58	FAIRLANE All	
R	66-70	FALCON All Exc. Wagon	
R	60-65	FALCON All	
R	52-56	MAINLINE All	
R	65-73	MUSTANG / MUSTANG II All	
R	56	PARK LANE WAGON All	
F	56-59	PICKUP 1/2 TON, F-100 All	
R	60	PICKUP 1 TON, F-350 / SUPERDUTY All	
F	56-59	PICKUP 1 TON, F-350 / SUPERDUTY All	
F	56-59	PICKUP 3/4 TON, F-250 / SUPERDUTY All	
R	60-65	RANCHERO All	

Guardian Shock

Shock	POP	Alternative No.	MTG Acc. Supplied
Pos.	Year	Application	
81270	A (cont)	140523	
R	52-56	RANCH WAGON All	
R	54-56	SKYLINER All	
F	57-58	SUNLINER All	
R	52	SUNLINER All	
R	55-57	THUNDERBIRD All	
R	68-70	TORINO All Exc. Wagon	
R	52-58	VICTORIA All	
F	53-54	GMC PICKUP All	
R	62-64	JAGUAR XKE All	
R	72-77	MAZDA 808 Wagon Exc. Models w/ Tokico OE Struts	
R	79-83	GLC Wagon	
R	78	GLC All	
R	74-76	RX3 Wagon	
R	72-73	RX3 All	
R	74-78	RX4 All	
R	59-60	MERCURY COLONY PARK All	
R	68-69	COMET All	
R	66-67	COMET Convertible	
R	66-67	COMET Hardtop	
R	66-67	COMET Sedan	
R	60-65	COMET All	
R	59-60	COMMUTER All	
R	67-73	COUGAR All	
R	59-60	COUNTRY CRUISER All	
R	68-71	CYCLONE All	
R	62-63	METEOR All	
R	59-60	MONTCLAIR All	
R	68-71	MONTEGO All Exc. Wagon	
R	59-60	MONTEREY All	
R	59-60	PARKLANE All	
R	59	VOYAGER All	
R	69-78	SAAB 99 All	
R	59-68	VOLVO 122 All	
81318	C	141137	
R	81-82	CHEVROLET LUV PICKUP All	
R	55	PICKUP 3100	
F	61-67	FORD ECONOLINE All	
R	89-94	ISUZU AMIGO All	
R	81-95	PICKUP All	
R	84-86	TROOPER 4WD	
R	86-92	JEEP COMANCHE All	
F	66-67	GLADIATOR All	
F	64-65	GLADIATOR All Exc. Independent Front Suspension	
F	68-73	J2500 PICKUP All	
F	66-73	WAGONEER All	
F	63-65	WAGONEER All Exc. Independent Front Suspension	
R	49-51	MERCURY MERCURY All	
R	50-51	MONTEREY All	
R	83-89	MITSUBISHI MONTERO 2.6L 4Cyl L (156), 3.59 91.1(Bore)3.86 98.0(Stroke)	
R	82-86	NISSAN 720 PICKUP 4WD	
R	00-04	FRONTIER Crew Cab Pickup, RWD w/ Desert Runner	
R	98-04	FRONTIER 4WD	
R	98-99	FRONTIER RWD Crew Cab; w/ Desert Runner Package	
R	87-95	PATHFINDER All Exc. Electronic Adjustable Suspension	
R	87-97	PICKUP 4WD	
R	86	PICKUP 4WD Mfg. from 8/86	
R	57-60	PONTIAC BONNEVILLE All	
R	58-60	CATALINA All	
R	58	CHIEFTAIN All	
R	58-60	STAR CHIEF All	
R	58	SUPER CHIEF All	
R	60	VENTURA All	
R	84-87	TOYOTA LAND CRUISER FJ60 (MfrBodyCode), Sport Utility	
R	75-83	LAND CRUISER All	
R	69-74	LAND CRUISER All Wagon	
R	85-92	PICKUP RWD 1 Ton	
R	80-83	PICKUP 4WD Exc. Lift Kit	
81340	D	141041	
R	70-74	AMERICAN MOTORS AMBASSADOR All	
R	70	AMX All	
R	80-88	EAGLE All	
R	70-74	JAVELIN All	
R	71-78	MATADOR All	
R	76-87	CHEVROLET CHEVETTE All	
R	49-52	FLEETLINE All	
R	49-52	FLEETLINE TRUCK All	
R	83-89	ISUZU IMPULSE All	
R	72	NISSAN 510 All	
R	74-77	710 Hardtop	
R	74-77	710 Sedan	
R	76-87	PONTIAC ACADIAN All	
R	81-87	T1000 All	

Numerical listing

Shock	POP	Alternative No.	MTG Acc. Supplied
Pos.	Year	Application	
81340	D (cont)	141041	
R	76-79	TOYOTA COROLLA Coupe	
R	72-79	COROLLA Sedan	
R	75-78	COROLLA Hardtop	
R	72-74	COROLLA Coupe	
R	79-81	CORONA Wagon	
R	73-76	CORONA Sedan	
R	73-74	CORONA Hardtop	
R	72	CORONA Mark II Exc. Wagon	
R	78-80	CRESSIDA Wagon	
F	75-79	LAND CRUISER FJ55 (MfrBodyCode), Sport Utility	
F	69-74	LAND CRUISER All	
81342	D		
R	81-93	DODGE PICKUP 1/2 TON, W100 SERIES All Exc. Lift Kit	
R	72-80	PICKUP 1/2 TON, W100 SERIES All	
R	81-93	PICKUP 1 TON, W300 SERIES All Exc. Quad Suspension and Lift Kit	
R	72-80	PICKUP 1 TON, W300 SERIES All	
R	90-93	PICKUP 3/4 TON, W200 SERIES Extended Cab Pickup Exc. Lift Kit	
R	88-93	PICKUP 3/4 TON, W200 SERIES Cab & Chassis Exc. Lift Kit	
R	81-93	PICKUP 3/4 TON, W200 SERIES Standard Cab Pickup Exc. Lift Kit	
R	86	PICKUP 3/4 TON, W200 SERIES Cab & Chassis Exc. Lift Kit	
R	81-83	PICKUP 3/4 TON, W200 SERIES Cab & Chassis Exc. Lift Kit	
R	81-82	PICKUP 3/4 TON, W200 SERIES Extended Cab Pickup Exc. Lift Kit	
R	72-80	PICKUP 3/4 TON, W200 SERIES All	
R	76-93	RAMCHARGER 4WD	
R	78-80	RD200 All	
R	76-81	PLYMOUTH TRAILDUSTER 4WD	
81394	B	140780	
F	78-79	FORD BRONCO All Quad Suspension Rearward, Non Quad Suspension Right	
F	74-77	BRONCO All From Serial #830001; Exc. Lift Kit RWD, 4WD Quad Suspension Rearward of Front Axle, Non Quad Suspension	
F	73	BRONCO All From Serial #830001; Exc. Lift Kit	
F	70-72	BRONCO All From Serial #830001; Exc. Lift Kit RWD, 4WD Quad Suspension Rearward of Front Axle, Non Quad Suspension	
F	69	BRONCO All From Serial #830001; Exc. Lift Kit	
F	66-68	BRONCO All From Serial #830001; Exc. Lift Kit RWD, 4WD Quad Suspension Rearward of Front Axle, Non Quad Suspension	
F	70-79	PICKUP 1/2 TON, F-100 All RWD, 4WD Quad Suspension Rearward, Non Quad Suspension Right	
F	65-69	PICKUP 1/2 TON, F-100 All Quad Suspension Rearward of Front Axle	
F	75-79	PICKUP 1/2 TON, F-150 All RWD, 4WD Quad Suspension Rearward, Non Quad Suspension Right	
F	79	PICKUP 1 TON, F-350 / SUPERDUTY RWD Quad Suspension Rearward of Front Axle	
F	68-78	PICKUP 1 TON, F-350 / SUPERDUTY All Quad Suspension Rearward of Front Axle	
F	67	PICKUP 1 TON, F-350 / SUPERDUTY All RWD; Quad Suspension Rearward of Front Axle	
F	65-69	PICKUP 3/4 TON, F-250 / SUPERDUTY All RWD; Quad Suspension Rearward of Front Axle	
F	75-91	VAN 1 TON, ECONOLINE / CLUB WAGON / SUPERDUTY All Exc. Cutaway Chassis RWD, 4WD Quad Suspension Rearward of Front Axle, Non Quad Suspension	
F	75-91	VAN 3/4 TON, ECONOLINE / CLUB WAGON / SUPERDUTY All RWD, 4WD Quad Suspension Rearward of Front Axle, Non Quad Suspension	
F	90	VAN 3/4 TON, ECONOLINE / CLUB WAGON / SUPERDUTY All	
F	87	VAN 3/4 TON, ECONOLINE / CLUB WAGON / SUPERDUTY All	
F	85	VAN 3/4 TON, ECONOLINE / CLUB WAGON / SUPERDUTY All	
F	79-81	VAN 3/4 TON, ECONOLINE / CLUB WAGON / SUPERDUTY All	

Numerical listing

Shock	POP	Alternative No.	MTG Acc. Supplied
Pos.	Year	Application	
81416	W		141045
R	78-85	TOYOTA CELICA All	
R	75-83	COROLLA Wagon	
R	74	COROLLA All Mfg. from 8/74; Wagon	
R	79-82	CORONA Hatchback	
R	79-82	CORONA Sedan	
R	81-87	CRESSIDA Wagon	
81440	W		141045
R	85-88	TOYOTA CRESSIDA Sedan Exc. Electronic Adjustable Suspension	
R	83-84	CRESSIDA Sedan	
R	81-82	CRESSIDA Sedan Exc. Electronic Adjustable Suspension	
R	78-80	CRESSIDA Sedan	
R	81-84	STARLET All	
81446	A		141041
F	71-73	BUICK CENTURION All	
F	91-96	COMMERCIAL CHASSIS All	
F	71-84	ELECTRA All	
F	71-83	ESTATE WAGON All	
F	71-85	LESABRE All	
F	71-78	RIVIERA All	
F	91-96	ROADMASTER All	
F	87-92	CADILLAC BROUGHAM All	
F	92-96	COMMERCIAL CHASSIS RWD	
F	77-84	COMMERCIAL CHASSIS All	
F	77-84	DEVILLE All	
F	93-96	FLEETWOOD RWD	
F	77-86	FLEETWOOD RWD	
F	81	CHEVROLET BEL AIR Sedan Exc. Police and Taxi Models	
F	65-75	BEL AIR Sedan Exc. Police and Taxi Models	
F	65-72	BISCAYNE All Exc. Police and Taxi Models	
F	69-72	BROOKWOOD All	
F	70-81	CAMARO All	
F	73-96	CAPRICE Wagon	
F	71-72	CAPRICE Hardtop Exc. Police and Taxi Models	
F	70	CAPRICE Hardtop	
F	66-69	CAPRICE All	
F	94-96	IMPALA All Wagon; Exc. Police and Taxi Models	
F	83-85	IMPALA All Wagon; Exc. Police and Taxi Models	
F	65-82	IMPALA Wagon Exc. Police and Taxi Models	
F	69-72	KINGSWOOD All	
F	69-72	TOWNSMAN All	
F	65-74	FORD COUNTRY SEDAN All	
F	87-91	COUNTRY SQUIRE All	
F	65-74	COUNTRY SQUIRE All	
F	93-02	CROWN VICTORIA Base	
F	93-02	CROWN VICTORIA LX	
F	93-02	CROWN VICTORIA S	
F	02	CROWN VICTORIA LWB	
F	92	CROWN VICTORIA All	
F	65-72	CUSTOM All	
F	68-77	CUSTOM 500 All	
F	75-76	ELITE All	
F	65-67	GALAXIE All	
F	68-74	GALAXIE 500 All	
F	64-66	GALAXIE 500 All	
F	01-02	GRAND MARQUIS All	
F	87-91	LTD / COUNTRY SEDAN / COUNTRY SQUIRE / CROWN VICTORIA All	
F	85-86	LTD / COUNTRY SEDAN / COUNTRY SQUIRE / CROWN VICTORIA Crown Victoria	
F	65-82	LTD / COUNTRY SEDAN / COUNTRY SQUIRE / CROWN VICTORIA All	
F	77-79	LTD II All	
F	72-79	RANCHERO All	
F	65-74	RANCH WAGON All	
F	67-79	THUNDERBIRD All	
F	72-76	TORINO All	
F	70-80	LINCOLN CONTINENTAL All	
F	68-71	MARK III All	
F	72-76	MARK IV All	
F	77-79	MARK V All	
F	80-83	MARK VI All	
F	81-02	TOWN CAR All	
F	67	MERCURY BROUGHAM All	
F	87-91	COLONY PARK All	
F	65-74	COLONY PARK All	
F	65-68	COMMUTER All	
F	74-79	COUGAR All	
F	75-02	GRAND MARQUIS All	
F	69-70	MARAUDER All	

Guardian Shock

Shock	POP	Alternative No.	MTG Acc. Supplied
Pos.	Year	Application	
81446	A (cont)		141041
F	65-67	MARAUDER All	
F	67-82	MARQUIS All	
F	65-68	MONTCLAIR All	
F	72-76	MONTEGO All	
F	65-74	MONTEREY All	
F	65-68	PARKLANE All	
F	65-67	VILLAGER All	
F	66-67	VOYAGER All	
F	71-85	OLDSMOBILE 88 SERIES All	
F	71-84	98 All	
F	71-92	CUSTOM CRUISER All	
F	71-81	PONTIAC BONNEVILLE All	
F	71-81	CATALINA All	
F	70-81	FIREBIRD All	
F	71-78	GRAND SAFARI All	
F	76-81	LAURENTIAN All	
F	76-86	PARISIENNE All	
F	87-89	SAFARI All	
81469	A		
R	57-64	CHRYSLER 300 All	
R	57-66	IMPERIAL All	
R	55	IMPERIAL All	
R	55-56	NASSAU All	
R	51-64	NEWPORT All	
R	51-64	NEW YORKER All	
R	57-60	SARATOGA All	
R	51-52	SARATOGA All	
R	55-56	ST REGIS All	
R	51-64	TOWN & COUNTRY All	
R	51-61	WINDSOR All	
R	56-60	DESOTO ADVENTURER All	
R	51-52	CUSTOM	
R	51-52	DELUXE	
R	61	DESOTO All	
R	52-59	FIREDOME All	
R	56-60	FIREFLITE All	
R	57-59	FIRESWEEP All	
R	53-54	POWERMASTER All	
R	62-64	DODGE 880 All	
R	64-70	A100 TRUCK All	
R	51-59	CORONET All	
R	54-61	CUSTOM All	
R	63-76	DART All	
R	60-61	DART All	
R	61-62	LANCER All	
R	51-54	MEADOWBROOK All	
R	60-61	POLARA All	
R	64-70	VAN 1/2 TON, A / B SERIES / RAM All	
R	64-69	PLYMOUTH BARRACUDA All	
R	53-61	BELVEDERE All	
R	51-53	CAMBRIDGE All	
R	51-52	CONCORD All	
R	51-53	CRANBROOK All	
R	58-61	CUSTOM All	
R	70-76	DUSTER All	
R	60-61	FLEET SPECIAL All	
R	56-61	FURY All	
R	54-58	PLAZA All	
R	53-61	SAVOY All	
R	71-76	SCAMP All	
R	60-61	SPORT WAGON All	
R	51-61	SUBURBAN All	
R	60-76	VALIANT All	
81478	W		140857
F	81-82	CHEVROLET LUV PICKUP RWD	
F	81-95	ISUZU PICKUP RWD	
F	69-72	NISSAN 521 PICKUP All	
F	72-79	620 PICKUP All	
F	80-86	720 PICKUP All	
F	87-97	PICKUP 4WD	
F	86	PICKUP 4WD Mfg. from 8/86	
81481	D		142261
R	82-02	CHEVROLET CAMARO All	
R	52-54	LINCOLN CAPRI All	
R	52-54	COSMOPOLITAN All	
R	82-02	PONTIAC FIREBIRD All	
81482	C		
R	05	CHEVROLET BLAZER Base, 4WD	
R	05	BLAZER Base, RWD	
R	96-04	BLAZER LS, 4WD	
R	96-04	BLAZER LS, RWD	
R	95-02	BLAZER LT, RWD	
R	95-01	BLAZER LT, 4WD	
R	95-99	BLAZER Base, 4WD	
R	95-99	BLAZER Base, RWD	
R	95-97	BLAZER Deluxe, RWD	
R	83-94	BLAZER, S MODELS All	
R	94-04	S10 LS, 4WD	
R	99-03	S10 Base, 4WD	
R	99-03	S10 LS, RWD	

Numerical listing

Shock	POP	Alternative No.	MTG Acc. Supplied
Pos.	Year	Application	
81482	C (cont)		
R	98-03	S10 Base, RWD	
R	83-97	S10 Base, 4WD	
R	92-93	S10 EL, 4WD	
R	83-92	S10 Tahoe, 4WD	
R	88-90	S10 Durango, 4WD	
R	83-86	S10 Durango, 4WD	
R	05	GMC JIMMY 4WD	
R	92-04	JIMMY All	
R	83-91	S15 JIMMY All	
R	82-04	SONOMA / S15 All	
R	91	SYCLONE All	
R	92-93	TYPHOON All	
R	96-00	ISUZU HOMBRE All	
R	96-01	OLDSMOBILE BRAVADA All	
R	91-94	BRAVADA All	
81484	B		141137
R	78-79	FORD BRONCO All	
R	66-77	BRONCO All From Serial #830001	
R	65-69	PICKUP 1/2 TON, F-100 All RWD; w/Front Coil Springs	
R	75-79	PICKUP 1 TON, F-350 / SUPERDUTY Standard Cab Pickup, RWD	
R	73-74	PICKUP 1 TON, F-350 / SUPERDUTY All RWD; Exc. Supercab	
R	75-79	PICKUP 3/4 TON, F-250 / SUPERDUTY Extended Cab Pickup, RWD	
R	73-74	PICKUP 3/4 TON, F-250 / SUPERDUTY RWD Supercab	
R	65-72	PICKUP 3/4 TON, F-250 / SUPERDUTY All RWD; Supercab	
R	69-74	VAN 1/2 TON, ECONOLINE / CLUB WAGON All	
R	69-74	VAN 1 TON, ECONOLINE / CLUB WAGON / SUPERDUTY All	
R	69-74	VAN 3/4 TON, ECONOLINE / CLUB WAGON / SUPERDUTY All	
R	76-83	JEEP CHEROKEE All	
F	74-83	CHEROKEE All	
F	82-83	CJ5 All Exc. Lift Kit	
F	82-86	CJ7 All Exc. Lift Kit	
R	67	GLADIATOR All	
F	93	GRAND WAGONEER All	
R	93	GRAND WAGONEER All	
F	84-91	GRAND WAGONEER All	
R	84-91	GRAND WAGONEER All	
F	74-88	J10 PICKUP All	
R	74-88	J10 PICKUP All	
F	74-88	J20 PICKUP All	
R	74-88	J20 PICKUP All	
R	68-73	J2500 PICKUP All	
F	82-85	SCRAMBLER / C/J8 All	
R	76-83	WAGONEER All	
F	74-83	WAGONEER All	
81490	C		140780
F	80-96	FORD BRONCO All Rearward of Front Axle; Exc. Lift Kit	
F	89	BRONCO II All Mfg. to 2/89; Vehicles w/ 10mm & 12mm bolt in rear lower mount	
F	84-88	BRONCO II All w/ 10mm Bolt In Rear Lower Mount	
F	86-90	F-200 All	
F	97	F-250 HD RWD	
F	80-83	PICKUP 1/2 TON, F-100 RWD	
F	80-96	PICKUP 1/2 TON, F-150 All	
F	80-97	PICKUP 1 TON, F-350 / SUPERDUTY RWD	
F	97	PICKUP 3/4 TON, F-250 / SUPERDUTY RWD Over 8500# GVW	
F	80-96	PICKUP 3/4 TON, F-250 / SUPERDUTY RWD	
F	87-89	RANGER All Exc. High Ryder Option	
F	83-86	RANGER All	
81491	C		141164
F	80-88	AMERICAN MOTORS EAGLE All	
F	75-80	FORD GRANADA All	
F	71-73	MUSTANG / MUSTANG II All	
F	77-80	LINCOLN VERSAILLES All	
F	71-73	MERCURY COUGAR All	
F	75-80	MONARCH All	
81492	A		140629
R	73-81	BUICK CENTURY All	
R	71-83	ESTATE WAGON All	
R	65-67	GRAN SPORT All	
R	68-72	GS / GS350 / GS400 / GS455 All	
R	73-87	REGAL All	

Numerical listing

Shock	POP	Alternative No.	MTG Acc. Supplied
Pos.	Year	Application	
81492		A (cont)	140629
R	91-96	ROADMASTER Wagon	
R	68-72	SKYLARK All	
R	64-67	SKYLARK All Heavy Duty Suspension	
R	68-69	SPECIAL All	
R	64-67	SPECIAL All Heavy Duty Suspension	
R	70-72	SPORTWAGON All	
R	71-72	CHEVROLET BROOKWOOD All	
R	71-96	CAPRICE Wagon	
R	68-73	CHEVELLE All	
R	64-67	CHEVELLE All Heavy Duty Suspension	
R	68-87	EL CAMINO All	
R	71-82	IMPALA Wagon	
R	71-72	KINGSWOOD All	
R	73-83	MALIBU All	
R	64-67	MALIBU All Heavy Duty Suspension	
R	70-88	MONTE CARLO All	
R	71-72	TOWNSMAN All	
R	78-87	GMC SPRINT / CABALLERO RWD	
R	71-77	SPRINT / CABALLERO All	
R	74-76	NISSAN 610 Wagon	
R	73	610 All Wagon	
R	74-77	710 Wagon	
R	77-80	810 Wagon	
R	71-92	OLDSMOBILE CUSTOM CRUISER All	
R	68-87	CUTLASS / CUTLASS SUPREME All	
R	72	CUTLASS / CUTLASS SUPREME Base	
R	72	CUTLASS / CUTLASS SUPREME S	
R	64-67	CUTLASS / CUTLASS SUPREME All Heavy Duty Suspension	
R	80-83	CUTLASS CLASSIC / CUTLASS CRUISER All	
R	68-72	F85 All	
R	61-67	F85 All Heavy Duty Suspension	
R	71-78	TORONADO All	
R	82-86	PONTIAC BONNEVILLE All	
R	77-81	CATALINA Wagon	
R	71-75	CATALINA Wagon	
R	78-80	GRAND AM All	
R	73-75	GRAND AM All	
R	75-83	GRAND LEMANS All	
R	69-87	GRAND PRIX All	
R	71-78	GRAND SAFARI All	
R	71-75	GRANDVILLE All	
R	68-73	GTO All	
R	64-67	GTO All Heavy Duty Suspension	
R	68-81	LEMANS All	
R	64-67	LEMANS All Heavy Duty Suspension	
R	80-86	PARISIENNE Wagon	
R	76-79	PARISIENNE All Wagon	
R	87-89	SAFARI All	
R	68-70	TEMPEST All	
R	64-67	TEMPEST All Heavy Duty Suspension	

81494		A	140455
F	73-75	BUICK APOLLO All	
F	73-81	CENTURY All	
F	68-72	GS / GS350 / GS400 / GS455 All	
F	73-87	REGAL All	
F	75-79	SKYLARK All	
F	68-72	SKYLARK All	
F	68-69	SPECIAL All	
F	68-72	SPORTWAGON All	
F	76-79	CADILLAC SEVILLE All	
F	67-69	CHEVROLET CAMARO All	
F	68-73	CHEVELLE All	
F	68	CHEVY II All	
F	73-83	MALIBU All	
F	70-88	MONTE CARLO All	
F	69-79	NOVA All	
F	64-65	NISSAN 410 All	
F	64-67	411 All	
F	68-87	OLDSMOBILE CUTLASS / CUTLASS SUPREME All	
F	80-83	CUTLASS CLASSIC / CUTLASS CRUISER All	
F	68-72	F85 All	
F	74-79	OMEGA All	
F	73	OMEGA All Exc. Heavy Duty Suspension	
F	82-86	PONTIAC BONNEVILLE All	
F	67-69	FIREBIRD All	
F	78-80	GRAND AM All	
F	73-75	GRAND AM All	
F	75-83	GRAND LEMANS All	
F	69-87	GRAND PRIX All	
F	71-75	GRANDVILLE All	

Guardian Shock

Shock	POP	Alternative No.	MTG Acc. Supplied
Pos.	Year	Application	
81494		A (cont)	140455
F	68-73	GTO All	
F	68-81	LEMANS All	
F	77-79	PHOENIX All	
F	68-70	TEMPEST All	
F	71-77	VENTURA All	
F	67-78	TOYOTA CORONA All	
F	68-75	VOLVO 142 / 144 / 145 / 164 All	
81495		A	141150
R	61-63	BUICK SKYLARK All	
R	61-63	SPECIAL All	
R	64-69	SPORTWAGON All	
R	68-69	CHEVROLET CAMARO All Multi-Leaf Springs	
R	65-74	FORD COUNTRY SEDAN All	
R	87-91	COUNTRY SQUIRE All	
R	65-74	COUNTRY SQUIRE All	
R	92-02	CROWN VICTORIA All	
R	65-72	CUSTOM All	
R	68-77	CUSTOM 500 All	
R	75-76	ELITE All	
R	66-70	FALCON All Wagon	
R	65-67	GALAXIE All	
R	68-74	GALAXIE 500 All	
R	64-66	GALAXIE 500 All	
R	01-02	GRAND MARQUIS All	
R	87-91	LTD / COUNTRY SEDAN / COUNTRY SQUIRE / CROWN VICTORIA All	
R	65-82	LTD / COUNTRY SEDAN / COUNTRY SQUIRE / CROWN VICTORIA All	
R	77-79	LTD II All	
R	56-60	PICKUP 1/2 TON, F-100 All	
R	56-60	PICKUP 3/4 TON, F-250 / SUPERDUTY All	
R	66-79	RANCHERO All	
R	65-74	RANCH WAGON All	
R	77-79	THUNDERBIRD All	
R	67-72	THUNDERBIRD All	
R	74-76	TORINO Wagon	
R	71	TORINO All Wagon	
R	70-80	LINCOLN CONTINENTAL All	
R	68-71	MARK III All	
R	72	MARK IV All	
R	80-83	MARK VI All	
R	81-02	TOWN CAR All	
R	67	MERCURY BROUGHAM All	
R	87-91	COLONY PARK All	
R	65-74	COLONY PARK All	
R	66-67	COMET Wagon	
R	65-68	COMMUTER All	
R	74-79	COUGAR All	
R	75-02	GRAND MARQUIS All	
R	69-70	MARAUDER All	
R	65-67	MARAUDER All	
R	67-82	MARQUIS All	
R	65-68	MONTECLAIR All	
R	74-76	MONTEGO Wagon	
R	68-73	MONTEGO All Wagon	
R	65-74	MONTEREY All	
R	65-68	PARKLANE All	
R	65-67	VILLAGER All	
R	66-67	VOYAGER All	
R	64-72	OLDSMOBILE VISTA CRUISER All	
R	68-69	PONTIAC FIREBIRD All	

81496		D	140857
F	87-91	CHEVROLET BLAZER 4WD Full Size; Quad Suspension Long Shock	
F	81-86	BLAZER 4WD Quad Suspension Long Shock	
F	81-86	PICKUP 1/2 TON, K10 All Quad Suspension Long Shock; Exc. Lift Kit	
F	87	PICKUP 1/2 TON, V10 All Quad Suspension Long Shock; Exc. Lift Kit	
F	81-86	PICKUP 3/4 TON, K20 All Quad Suspension Long Shock; Exc. Lift Kit	
F	87	PICKUP 3/4 TON, V20 All Quad Suspension Long Shock; Exc. Lift Kit	
F	81-86	SUBURBAN 1/2 TON, K10 All Quad Suspension Long Shock; Exc. Lift Kit	
F	87-88	SUBURBAN 1/2 TON, V10 All Quad Suspension Long Shock; Exc. Lift Kit	
F	81-86	SUBURBAN 3/4 TON, K20 All Quad Suspension Long Shock; Exc. Lift Kit	
F	87-88	SUBURBAN 3/4 TON, V20 All Quad Suspension Long Shock; Exc. Lift Kit	
F	89-91	SUBURBAN 3/4 TON, V2500 All Quad Suspension Long Shock; Exc. Lift Kit	
R	78-95	VAN 1/2 TON, G / EXPRESS All	
R	78-95	VAN 1 TON, G / EXPRESS Cutaway Van	

Numerical listing

Shock	POP	Alternative No.	MTG Acc. Supplied
Pos.	Year	Application	
81496		D (cont)	
R	78-95	VAN 3/4 TON, G / EXPRESS All Exc. 8600# GVW	
R	84-86	DODGE MINI RAM All	
R	99-03	VAN 1/2 TON, A / B SERIES / RAM 109.3 / 277.6 (WheelBase) Exc. 7000# GVW	
R	81-98	VAN 1/2 TON, A / B SERIES / RAM 109.6 / 278.4 (WheelBase) Exc. 7000# GVW	
R	71-80	VAN 1/2 TON, A / B SERIES / RAM All	
R	71-03	VAN 1 TON, A / B SERIES / RAM All	
R	74-80	VAN, CB300 All	
F	75-91	GMC JIMMY 4WD Quad Suspension Long Shock	
F	81-86	PICKUP 1/2 TON, K15 / K1500 All Quad Suspension Long Shock	
F	87	PICKUP 1/2 TON, V1500 All Quad Suspension Long Shock	
F	87-88	PICKUP 1 TON, V3000 / V3500 All Quad Suspension Long Shock; Exc. Lift Kit	
F	81-86	PICKUP 3/4 TON, K25 / K2500 All Quad Suspension Long Shock; Exc. Lift Kit	
F	87	PICKUP 3/4 TON, V2500 All Quad Suspension Long Shock; Exc. Lift Kit	
F	81-86	SUBURBAN 1/2 TON, K15 / K1500 All Quad Suspension Long Shock	
F	87-91	SUBURBAN 1/2 TON, V1500 All Quad Suspension Long Shock	
F	81-86	SUBURBAN 3/4 TON, K25 / K2500 All Quad Suspension Long Shock; Exc. Lift Kit	
F	87-91	SUBURBAN 3/4 TON, V2500 All Quad Suspension Long Shock; Exc. Lift Kit	
R	78-95	VAN 1/2 TON, G / SAVANA All	
R	85-96	VAN 1 TON, G / SAVANA Extended Cargo Van	
R	85-96	VAN 1 TON, G / SAVANA Extended Passenger Van	
R	79-96	VAN 1 TON, G / SAVANA Standard Cargo Van	
R	79-96	VAN 1 TON, G / SAVANA Standard Passenger Van	
R	78	VAN 1 TON, G / SAVANA Cutaway Van	
R	78-95	VAN 3/4 TON, G / SAVANA All Exc. 8600# GVW	
R	74-83	PLYMOUTH VAN 1/2 TON, PB SERIES All	
R	74-83	VAN 3/4 TON, PB SERIES All	

81507		A	140857
F	81-82	CHEVROLET LUV PICKUP 4WD	
F	75-80	LUV PICKUP All	
F	72-74	LUV PICKUP All	
F	89-94	ISUZU AMIGO All	
F	81-95	PICKUP 4WD	
F	84-86	TROOPER 4WD	
F	98-04	NISSAN FRONTIER RWD Exc. Desert Runner	
F	87-97	PICKUP RWD	
F	86	PICKUP RWD Mfg. from 8/86	
81510		C	
R	97	FORD F-250 HD 4WD	
R	80-96	PICKUP 1/2 TON, F-150 4WD Exc. Lift Kit	
R	86-97	PICKUP 1 TON, F-350 / SUPERDUTY 4WD Dual Rear Wheels	
R	82-85	PICKUP 1 TON, F-350 / SUPERDUTY 4WD Clevis Type Lower Front Mount; Exc. Dual Rear Wheels or Lift Kit	
R	80-81	PICKUP 1 TON, F-350 / SUPERDUTY 4WD	
R	97	PICKUP 3/4 TON, F-250 / SUPERDUTY 4WD Over 8500# GVW	
R	86-96	PICKUP 3/4 TON, F-250 / SUPERDUTY 4WD	
R	82-85	PICKUP 3/4 TON, F-250 / SUPERDUTY 4WD Clevis Type Lower Front Mount; Exc. Dual Rear Wheels or Lift Kit	
R	80-81	PICKUP 3/4 TON, F-250 / SUPERDUTY 4WD	

Numerical listing

Shock	POP	Alternative No.	MTG Acc. Supplied
Pos.	Year		Application
81514	A		140629
R	73	BUICK APOLLO All Heavy Duty Suspension	
R	71-73	CENTURION All	
R	71-84	ELECTRA All	
R	70	ESTATE WAGON All	
R	71-85	LESABRE All	
R	71-78	RIVIERA All	
R	92-96	ROADMASTER Sedan	
R	64-67	SKYLARK All Exc. Heavy Duty Suspension	
R	64-67	SPECIAL All Exc. Heavy Duty Suspension	
R	87-92	CADILLAC BROUGHAM All	
R	92-96	COMMERCIAL CHASSIS RWD	
R	77-84	COMMERCIAL CHASSIS All	
R	77-84	DEVILLE All	
R	93-96	FLEETWOOD RWD	
R	77-86	FLEETWOOD RWD	
R	81	CHEVROLET BEL AIR Sedan	
R	65-75	BEL AIR All	
R	65-72	BISCAYNE All	
R	69-70	BROOKWOOD All	
R	73-96	CAPRICE Sedan Police and Taxi Models	
R	71-72	CAPRICE Hardtop Police and Taxi Models	
R	66-70	CAPRICE All	
R	64-67	CHEVELLE All Exc. Heavy Duty Suspension	
R	68	CHEVY II All	
R	64-67	EL CAMINO All	
R	94-96	IMPALA Sedan	
R	65-85	IMPALA Sedan	
R	69-70	KINGSWOOD All	
R	64-67	MALIBU All Exc. Heavy Duty Suspension	
R	73	NOVA All Heavy Duty Suspension	
R	69-72	NOVA All	
R	69-70	TOWNSMAN All	
R	65-85	OLDSMOBILE 88 SERIES All	
R	65-84	98 All	
R	64-67	CUTLASS / CUTLASS SUPREME All Exc. Heavy Duty Suspension	
R	65-66	DYNAMIC 88 All	
R	61-67	F85 All Exc. Heavy Duty Suspension	
R	65-66	STARFIRE All	
R	63-81	PONTIAC BONNEVILLE All	
R	75-81	CATALINA Coupe	
R	71-81	CATALINA Sedan	
R	71-74	CATALINA Hardtop	
R	63-70	CATALINA All	
R	67-70	EXECUTIVE All	
R	63-68	GRAND PRIX All	
R	64-67	GTO All Exc. Heavy Duty Suspension	
R	76-81	LAURENTIAN CAN	
R	64-67	LEMANS All Exc. Heavy Duty Suspension	
R	76-86	PARISIENNE Sedan	
R	63-66	STAR CHIEF All	
R	64-67	TEMPEST All Exc. Heavy Duty Suspension	
R	73	VENTURA All Heavy Duty Suspension	
R	71-72	VENTURA All Leaf(RearSpringType)	
81516	C		
F	05	CHEVROLET BLAZER Base, 4WD	
F	96-04	BLAZER LS, 4WD	
F	95-01	BLAZER LT, 4WD	
F	95-99	BLAZER Base, 4WD	
F	83-94	BLAZER, S MODELS 4WD	
F	94-04	S10 LS, 4WD	
F	83-03	S10 Base, 4WD	
F	92-93	S10 EL, 4WD	
F	83-92	S10 Tahoe, 4WD	
F	88-90	S10 Durango, 4WD	
F	83-86	S10 Durango, 4WD	
F	92-05	GMC JIMMY 4WD	
F	83-91	S15 JIMMY 4WD	
F	83-04	SONOMA / S15 4WD	
F	91	SYCLONE All	
F	92-93	TYPHOON All	
F	99-00	ISUZU HOMBRE 4WD	
F	96-98	HOMBRE All Sport Chassis	
F	96-01	OLDSMOBILE BRAVADA All	
F	91-94	BRAVADA All	
81540	W		
R	83-89	FORD RANGER 4WD	

Guardian Shock

Shock	POP	Alternative No.	MTG Acc. Supplied
Pos.	Year		Application
81541	W		140455
F	85-95	TOYOTA PICKUP RWD Exc. 1 Ton	
F	84	PICKUP RWD	
F	93-98	T100 RWD	
81548	C		141353
F	84-01	JEEP CHEROKEE All	
F	86-92	COMANCHE All	
F	93-98	GRAND CHEROKEE All	
F	84-90	WAGONEER All	
81549	D		
R	84-01	JEEP CHEROKEE All	
R	84-90	WAGONEER All	
81553	W		140524
F	87-91	ISUZU TROOPER 4WD	
F	86-87	MAZDA B2000 RWD	
F	87-93	B2200 RWD	
F	87-93	B2600 RWD	
81559	C		140126
F	87-04	DODGE DAKOTA RWD	
F	99-03	DURANGO RWD	
81560	C		
R	87-96	DODGE DAKOTA RWD	
81582	C		140126
F	55-56	CHRYSLER IMPERIAL All	
F	55-56	NASSAU All	
F	55-56	NEWPORT All	
F	55-56	NEW YORKER All	
F	55-56	ST REGIS All	
F	55-56	TOWN & COUNTRY All	
F	55-56	WINDSOR All	
F	56	DESOTO ADVENTURER All	
F	55-56	FIREDOME All	
F	56	FIREFLITE All	
F	55-56	DODGE CORONET All	
F	55-56	CUSTOM All	
F	86-97	FORD AEROSTAR RWD	
F	55-56	PLYMOUTH BELVEDERE All	
F	56	FURY All	
F	55-56	PLAZA All	
F	55-56	SAVOY All	
F	55-56	SUBURBAN All	
81583	C		
R	86-88	FORD AEROSTAR RWD	
R	87-95	JEEP WRANGLER YJ (MfrBodyCode)	
81667	C		
R	88-02	CHEVROLET PICKUP 1/2 TON, C15 / C1500 All	
R	88-99	PICKUP 1/2 TON, K15 / K1500 All	
R	88-00	PICKUP 1 TON, C35/3500 Extended Cab Pickup Exc. HD Straight Front Axle	
R	88-00	PICKUP 1 TON, C35/3500 Standard Cab Pickup Exc. HD Straight Front Axle	
R	88-00	PICKUP 1 TON, K35 / K3500 All	
R	88-00	PICKUP 3/4 TON, C25 / C2500 All	
R	88-00	PICKUP 3/4 TON, K25 / K2500 All	
R	88-99	GMC PICKUP 1/2 TON, C15 / C1500 All	
R	88-99	PICKUP 1/2 TON, K15 / K1500 All	
R	89-00	PICKUP 1 TON, C35/3500 Extended Cab Pickup Exc. HD Straight Front Axle	
R	88-00	PICKUP 1 TON, C35/3500 Standard Cab Pickup Exc. HD Straight Front Axle	
R	88-00	PICKUP 1 TON, K35 / K3500 All	
R	88-00	PICKUP 3/4 TON, C25 / C2500 All	
R	88-00	PICKUP 3/4 TON, K25 / K2500 All	
81668	C		141277
F	88-02	CHEVROLET PICKUP 1/2 TON, C15 / C1500 All	
F	92-00	PICKUP 1 TON, C35/3500 All Exc. HD Straight Front Axle	
F	88-91	PICKUP 1 TON, C35/3500 Extended Cab Pickup Exc. HD Straight Front Axle	
F	88-91	PICKUP 1 TON, C35/3500 Standard Cab Pickup Exc. HD Straight Front Axle	
F	88-00	PICKUP 3/4 TON, C25 / C2500 All	
F	92-99	SUBURBAN 1/2 TON, C15 / C1500 All	
F	92-99	SUBURBAN 3/4 TON, C25 / C2500 All	
F	95-00	TAHOE RWD Old Body Style	

Numerical listing

Shock	POP	Alternative No.	MTG Acc. Supplied
Pos.	Year		Application
81668	C (cont)		141277
F	88-99	GMC PICKUP 1/2 TON, C15 / C1500 All	
F	88-00	PICKUP 1 TON, C35/3500 All Exc. HD Straight Front Axle	
F	88-00	PICKUP 3/4 TON, C25 / C2500 All	
F	92-99	SUBURBAN 1/2 TON, C15 / C1500 All	
F	92-99	SUBURBAN 3/4 TON, C25 / C2500 All	
F	92-99	YUKON RWD	
81675	C		140455
F	86-95	SUZUKI SAMURAI All	
81676	A		
R	77-79	DODGE COLT Coupe	
R	77-79	COLT Sedan	
R	77	COLT Hardtop	
R	48-52	FORD F-1 All	
R	48-52	F-2 All	
R	48-52	F-3 All	
R	54-55	PICKUP 1/2 TON, F-100 All	
F	53-55	PICKUP 1/2 TON, F-100 All	
R	53	PICKUP 1/2 TON, F-100 All Exc. Heavy Duty Suspension	
F	53-55	PICKUP 1 TON, F-350 / SUPERDUTY All	
R	53-55	PICKUP 1 TON, F-350 / SUPERDUTY All	
F	53-55	PICKUP 3/4 TON, F-250 / SUPERDUTY All	
R	53-55	PICKUP 3/4 TON, F-250 / SUPERDUTY All	
R	74	JEEP CHEROKEE All	
F	59-66	CJ3 All	
R	59-66	CJ3 All	
F	66-68	CJ5 All	
F	72-81	CJ5 All	
R	59-81	CJ5 All	
F	66-71	CJ5 All 5 Leaf Front Springs; Exc. Lift Kit	
R	66-71	CJ5 All 5 Leaf Front Springs; Exc. Lift Kit	
F	59-65	CJ5 All	
F	66-68	CJ6 All	
F	72-75	CJ6 All	
R	59-75	CJ6 All	
F	66-71	CJ6 All 5 Leaf Front Springs; Exc. Lift Kit	
R	66-71	CJ6 All 5 Leaf Front Springs; Exc. Lift Kit	
F	59-65	CJ6 All	
F	76-81	CJ7 All	
F	61-67	DISPATCHER All	
R	61-67	DISPATCHER All	
F	59-66	DJ3 All	
R	59-66	DJ3 All	
F	65-74	DJ5 All	
F	65-68	DJ6 All	
R	61-65	FC150 All	
F	57-60	FC150 All	
F	60-68	M151 All	
F	81	SCRAMBLER / CJ8 All	
F	56-66	TRUCK All	
F	61-67	UNIVERSAL All 5 Leaf Front Springs; Exc. Lift Kit	
R	61-67	UNIVERSAL All 5 Leaf Front Springs; Exc. Lift Kit	
R	63-74	WAGONEER All	
F	63-65	WAGONEER All Independent Front Suspension	
F	43-58	WILLYS All	
R	43-58	WILLYS All	
R	76-80	PLYMOUTH ARROW All	
R	76-79	COLT All	
R	56-57	SAAB 93 All	
R	58-59	93B All	
R	58-59	GT750 All	
R	63	GT850 All	
R	86-95	SUZUKI SAMURAI All	
81691	D		141353
F	87-95	JEEP WRANGLER YJ (MfrBodyCode)	
81710	C		
R	80-96	FORD BRONCO All Exc. Lift Kit	
R	80-83	PICKUP 1/2 TON, F-100 RWD	
R	80-84	PICKUP 1/2 TON, F-150 RWD	
R	80-97	PICKUP 1 TON, F-350 / SUPERDUTY RWD Dual Rear Wheels	
81713	C		140800
F	85-05	CHEVROLET ASTRO RWD	

Numerical listing

Shock	POP	Alternative No.	MTG Acc. Supplied
Pos.	Year	Application	
81713	C (cont)		140800
F	71-75	BEL AIR Wagon	
F	71-72	BISCAYNE All Police and Taxi Models	
F	73-96	CAPRICE Sedan Police and Taxi Models	
F	71-72	CAPRICE Hardtop Police and Taxi Models	
F	83-85	IMPALA All Police and Taxi Models	
F	71-82	IMPALA Sedan Police and Taxi Models	
F	96-02	VAN 1/2 TON, G / EXPRESS All	
F	96-02	VAN 1 TON, G / EXPRESS All	
F	96-02	VAN 3/4 TON, G / EXPRESS All Exc. 8600# GVW	
F	93-02	FORD CROWN VICTORIA Police Interceptor	
F	85-05	GMC SAFARI RWD	
F	96-02	VAN 1/2 TON, G / SAVANA RWD	
F	96-02	VAN 1 TON, G / SAVANA All	
F	96-02	VAN 3/4 TON, G / SAVANA All Exc. 8600# GVW	
81726	W		
F	99-00	CADILLAC ESCALADE All	
F	90-05	CHEVROLET ASTRO AWD	
F	92-94	BLAZER 4WD Full Size	
F	88-00	PICKUP 1 TON, K35 / K3500 All	
F	88-00	PICKUP 3/4 TON, K25 / K2500 All	
F	92-99	SUBURBAN 1/2 TON, K15 / K1500 All	
F	92-99	SUBURBAN 3/4 TON, K25 / K2500 All	
F	95-00	TAHOE 4WD Old Body Style	
F	88-00	GMC PICKUP 1 TON, K35 / K3500 All	
F	88-00	PICKUP 3/4 TON, K25 / K2500 All	
F	90-05	SAFARI AWD	
F	92-99	SUBURBAN 1/2 TON, K15 / K1500 All	
F	92-99	SUBURBAN 3/4 TON, K25 / K2500 All	
F	92-99	YUKON 4WD	
81730	C		
R	90	FORD BRONCO II All	
R	89	BRONCO II All Mfg. from 2/89; Vehicles w/ 12mm bolt in rear lower mount	
R	90-97	RANGER RWD	
R	89	RANGER RWD Mfg. from 2/89; Vehicles w/ 12mm bolt in rear lower mount	
R	94-97	MAZDA B2300 RWD	
R	94-97	B3000 RWD	
81744	A		140780
F	90	FORD BRONCO II All	
F	91-94	EXPLORER All	
F	90-97	RANGER All	
F	92-14	VAN 1/2 TON, ECONOLINE / CLUB WAGON All	
F	21-24	VAN 1 TON, ECONOLINE / CLUB WAGON / SUPERDUTY All	
F	92-19	VAN 1 TON, ECONOLINE / CLUB WAGON / SUPERDUTY All	
F	92-14	VAN 3/4 TON, ECONOLINE / CLUB WAGON / SUPERDUTY All	
F	94-97	MAZDA B2300 All	
F	94-97	B3000 All	
F	94-97	B4000 All	
F	91-94	NAVAJO All	
81750	A		140455
F	05	CHEVROLET BLAZER Base, RWD	
F	96-04	BLAZER LS, RWD	
F	95-02	BLAZER LT, RWD	
F	95-99	BLAZER Base, RWD	
F	95-97	BLAZER Deluxe, RWD	
F	83-94	BLAZER, S MODELS RWD	
F	68-87	EL CAMINO All	
F	94-03	S10 LS, RWD	
F	82-03	S10 Base, RWD	
F	92-93	S10 EL, RWD	
F	83-92	S10 Tahoe, RWD	
F	88-90	S10 Durango, RWD	
F	82-86	S10 Durango, RWD	
F	72-82	FORD COURIER All	
F	92-04	GMC JIMMY RWD	
F	83-91	S15 JIMMY RWD	
F	04	SONOMA / S15 All RWD	
F	82-03	SONOMA / S15 RWD	
F	78-87	SPRINT / CABALLERO RWD	
F	71-77	SPRINT / CABALLERO All	
F	96-00	ISUZU HOMBRE RWD Exc. Sport Chassis	

Guardian Shock

Shock	POP	Alternative No.	MTG Acc. Supplied
Pos.	Year	Application	
81750	A (cont)		140455
F	72-76	MAZDA B1600 All	
F	77-78	B1800 All	
F	79-84	B2000 All	
F	82-84	B2200 All	
F	78-83	TOYOTA PICKUP SR5, RWD	
F	75-77	PICKUP RWD Mojave	
F	70-74	PICKUP All RWD	
81794	W		140126
R	03-04	FORD MUSTANG / MUSTANG II Mach 1	
R	94-04	MUSTANG / MUSTANG II Base	
R	94-04	MUSTANG / MUSTANG II GT	
R	04	MUSTANG / MUSTANG II GT Base	
R	04	MUSTANG / MUSTANG II GT Equipado	
R	01	MUSTANG / MUSTANG II GT Bullitt	
R	95	MUSTANG / MUSTANG II GTS	
81821	D		
F	97	FORD F-250 HD 4WD	
F	86-97	PICKUP 1 TON, F-350 / SUPERDUTY 4WD	
F	97	PICKUP 3/4 TON, F-250 / SUPERDUTY 4WD Over 8500# GVW	
F	87-96	PICKUP 3/4 TON, F-250 / SUPERDUTY 4WD	
81825	D		
F	81-93	DODGE PICKUP 1/2 TON, W100 SERIES All Exc. Lift Kit	
F	61-80	PICKUP 1/2 TON, W100 SERIES All	
F	81-93	PICKUP 1 TON, W300 SERIES All Exc. Quad Suspension and Lift Kit	
F	61-80	PICKUP 1 TON, W300 SERIES All	
R	61-71	PICKUP 1 TON, W300 SERIES All	
F	90-93	PICKUP 3/4 TON, W200 SERIES Extended Cab Pickup Exc. Lift Kit	
F	88-93	PICKUP 3/4 TON, W200 SERIES Cab & Chassis Exc. Lift Kit	
F	81-93	PICKUP 3/4 TON, W200 SERIES Standard Cab Pickup Exc. Lift Kit	
F	86	PICKUP 3/4 TON, W200 SERIES Cab & Chassis Exc. Lift Kit	
F	81-83	PICKUP 3/4 TON, W200 SERIES Cab & Chassis Exc. Lift Kit	
F	81-82	PICKUP 3/4 TON, W200 SERIES Extended Cab Pickup Exc. Lift Kit	
F	69-80	PICKUP 3/4 TON, W200 SERIES All	
F	61-67	PICKUP 3/4 TON, W200 SERIES All	
F	75-93	RAMCHARGER 4WD	
F	74	RAMCHARGER All	
F	78-80	RD200 All	
F	75-81	PLYMOUTH TRAILDUSTER 4WD	
F	74	TRAILDUSTER All	
81828	W		142617
R	10-14	FORD VAN 1/2 TON, ECONOLINE / CLUB WAGON All	
R	21-24	VAN 1 TON, ECONOLINE / CLUB WAGON / SUPERDUTY All	
R	04-19	VAN 1 TON, ECONOLINE / CLUB WAGON / SUPERDUTY All Exc. Cutaway Chassis	
R	92-05	VAN 1 TON, ECONOLINE / CLUB WAGON / SUPERDUTY All	
R	92-14	VAN 3/4 TON, ECONOLINE / CLUB WAGON / SUPERDUTY All	
81833	W		140780
R	92-07	FORD VAN 1/2 TON, ECONOLINE / CLUB WAGON All	
81834	W		140126
F	72-93	DODGE PICKUP 1 TON, D300 SERIES All Heavy Duty Package	
F	82-93	PICKUP 3/4 TON, D200 SERIES All Heavy Duty Package	
F	75-81	PICKUP 3/4 TON, D200 SERIES 165.0 / 419.1 (WheelBase) Heavy Duty Package	
F	72-74	PICKUP 3/4 TON, D200 SERIES All Heavy Duty Package	
F	71-93	VAN 1 TON, A / B SERIES / RAM All 4000# Front Axle	
F	74-80	VAN, CB300 All 4000# Front Axle	
F	74-83	PLYMOUTH VAN 1 TON, PB SERIES All 4000# Front Axle	
81836	C		140126
F	87-04	DODGE DAKOTA 4WD	
F	98-03	DURANGO 4WD	

Numerical listing

Shock	POP	Alternative No.	MTG Acc. Supplied
Pos.	Year	Application	
81837	W		
R	87-96	DODGE DAKOTA 4WD	
81869	C		141353,142592
F	99-04	JEEP GRAND CHEROKEE All	
81870	W		141350
F	86-95	TOYOTA 4RUNNER All	
F	86-95	PICKUP 4WD Exc. Lift Kit	
F	93-98	T100 4WD	
81871	C		140149
R	84-89	TOYOTA 4RUNNER All	
R	84-95	PICKUP 4WD Exc. Lift Kit	
R	98-04	TACOMA Pre Runner, RWD	
R	95-04	TACOMA 4WD	
81872	W		140524
F	90-92	DAIHATSU ROCKY All	
F	94-02	HONDA PASSPORT All	
F	98-00	ISUZU AMIGO All	
F	02-04	AXIOM All	
F	91-04	RODEO All	
F	87-90	MINIBUS VAN All	
F	87-95	NISSAN PATHFINDER All	
81873	B		
R	99-07	CHEVROLET PICKUP 1/2 TON, SILVERADO 1500 RWD Exc. Electronic Adjustable Suspension	
R	94-01	DODGE PICKUP 1/2 TON, RAM 1500 (SEE RAM 1500) All	
R	94-02	PICKUP 1 TON, RAM 3500 (SEE RAM 3500) RWD Exc. Solid Front Axle	
R	94-03	PICKUP 3/4 TON, RAM 2500 (SEE RAM 2500) All Exc. 8800# GVW	
R	99-07	GMC SIERRA 1500 RWD Exc. Electronic Adjustable Suspension	
81878	C		
R	96-07	CHRYSLER TOWN & COUNTRY All Exc. Hydraulic Self-Leveling System	
R	00-03	VOYAGER / GRAND VOYAGER All Exc. Hydraulic Self-Leveling System	
R	00	VOYAGER / GRAND VOYAGER Non-ABS Exc. Hydraulic Self-Leveling System	
R	96-07	DODGE CARAVAN / GRAND CARAVAN All Exc. Hydraulic Self-Leveling System	
R	96-00	PLYMOUTH VOYAGER / GRAND VOYAGER All Exc. Hydraulic Self-Leveling System	
81880	A		
R	63-82	CHEVROLET CORVETTE All	
81890	W		140719
R	95-01	FORD EXPLORER All Exc. Adjustable Suspension	
R	01-05	EXPLORER SPORT TRAC All	
R	97-01	MERCURY MOUNTAINEER All Exc. Electronic Adjustable Suspension	
81891	D		
R	93-98	JEEP GRAND CHEROKEE All	
81892	D		142700
R	00-03	FORD LOBO Harley-Davidson Edition, RWD	
R	00-03	LOBO XLT, RWD	
R	00	LOBO Base, RWD	
R	00	LOBO Lariat, RWD	
R	97-98	LOBO RWD	
R	04	PICKUP 1/2 TON, F-150 RWD	
R	00-03	PICKUP 1/2 TON, F-150 Harley-Davidson Edition, RWD	
R	99-03	PICKUP 1/2 TON, F-150 Lariat, RWD	
R	99-03	PICKUP 1/2 TON, F-150 XL, RWD	
R	99-03	PICKUP 1/2 TON, F-150 XLT, RWD	
R	00	PICKUP 1/2 TON, F-150 Base, RWD	
R	97-98	PICKUP 1/2 TON, F-150 RWD	
R	97-99	PICKUP 3/4 TON, F-250 / SUPERDUTY RWD Up through 8500# GVW	
81893	C		142277
F	95-01	FORD EXPLORER All Exc. Adjustable Suspension	
F	01-05	EXPLORER SPORT TRAC All	
F	98-11	RANGER Torsion Bar (FrontSpringType)	

Numerical listing

Shock	POP	Alternative No.	MTG Acc. Supplied
Pos.	Year	Application	
81893	C (cont)		142277
F	98-07	MAZDA B3000 Torsion Bar (FrontSpringType)	
F	98-09	B4000 Torsion Bar (FrontSpringType)	
F	97-01	MERCURY MOUNTAINEER All Exc. Electronic Adjustable Suspension	
81904	W		141514
R	92-93	ASUNA SUNRUNNER All	
R	98-04	CHEVROLET TRACKER Non-ABS	
R	89-97	GEO TRACKER All	
R	89-91	GMC TRACKER All	
R	94-97	PONTIAC SUNRUNNER All	
R	99-05	SUZUKI GRAND VITARA All	
R	89-98	SIDEKICK Non-ABS	
R	99-04	VITARA Non-ABS	
R	96-98	X-90 All	
81905	W		
R	90-97	FORD RANGER 4WD	
R	89	RANGER 4WD Mfg. from 2/89; Vehicles w/ 12mm bolt in rear lower mount	
R	95-96	MAZDA B2300 4WD	
R	94-97	B3000 4WD	
R	94-97	B4000 4WD	
81910	W		141137
R	98	INFINITI QX4 All Mfg. to 12/98	
R	97	QX4 All	
R	98-99	NISSAN PATHFINDER All Mfg. to 12/98	
R	96-97	PATHFINDER All	
81911	W		140524
R	98-02	HONDA PASSPORT All	
R	98-00	ISUZU AMIGO All	
R	02-04	AXIOM All	
R	98-04	RODEO All	
81912	C		142731
F	97-02	FORD EXPEDITION RWD Exc. Front Air- Leveling	
F	97-03	LOBO RWD	
F	97-04	PICKUP 1/2 TON, F-150 RWD	
F	97-99	PICKUP 3/4 TON, F-250 / SUPERDUTY RWD Up through 8500# GVW	
F	98-02	LINCOLN NAVIGATOR RWD	
81913	D		142700
R	98-03	FORD LOBO 4WD	
R	97-04	PICKUP 1/2 TON, F-150 4WD	
R	97-99	PICKUP 3/4 TON, F-250 / SUPERDUTY 4WD Up through 8500# GVW	
81914	D		142731
F	97-02	FORD EXPEDITION 4WD Exc. Front Air- Leveling	
F	98-03	LOBO 4WD	
F	04	PICKUP 1/2 TON, F-150 4WD Exc. 7000# GVW	
F	97-03	PICKUP 1/2 TON, F-150 4WD	
F	97-99	PICKUP 3/4 TON, F-250 / SUPERDUTY 4WD Up through 8500# GVW	
81916	A		141665
F	06-11	FORD RANGER RWD, Coil (FrontSpringType)	
F	01-05	RANGER XL, RWD, Coil (FrontSpringType)	
F	01-05	RANGER XLT, RWD, Coil (FrontSpringType)	
F	01-02	RANGER EV, RWD Coil (FrontSpringType)	
F	98-00	RANGER XL, RWD	
F	98-00	RANGER XLT, RWD	
F	01-09	MAZDA B2300 RWD	
F	98-01	B2500 RWD	
F	98-07	B3000 RWD	
F	98-09	B4000 RWD	
81917	A		
R	98-11	FORD RANGER RWD, Coil (FrontSpringType)	
R	01-09	MAZDA B2300 RWD, Coil (FrontSpringType)	
R	94-97	B2300 RWD, Coil (FrontSpringType)	
R	98-01	B2500 Coil (FrontSpringType)	
R	03-07	B3000 RWD, Coil (FrontSpringType)	

Guardian Shock

Shock	POP	Alternative No.	MTG Acc. Supplied
Pos.	Year	Application	
81917	A (cont)		
R	02	B3000 Coil (FrontSpringType)	RWD
R	94-01	B3000 RWD, Coil (FrontSpringType)	
R	01-09	B4000 RWD Coil (FrontSpringType)	
R	94-00	B4000 RWD, Coil (FrontSpringType)	
81918	D		
R	98-11	FORD RANGER Torsion Bar (FrontSpringType)	
R	98-07	MAZDA B3000 Torsion Bar (FrontSpringType)	
R	98-09	B4000 Torsion Bar (FrontSpringType)	
81919	D		142731
F	94-01	DODGE PICKUP 1/2 TON, RAM 1500 (SEE RAM 1500) 4WD	
F	99-02	PICKUP 3/4 TON, RAM 2500 (SEE RAM 2500) 4WD Exc. 8800# GVW	
F	94-95	PICKUP 3/4 TON, RAM 2500 (SEE RAM 2500) 4WD Exc. 8800# GVW	
81920	B		141665
F	99-07	CHEVROLET PICKUP 1/2 TON, SILVERADO 1500 RWD Exc. Electronic Adjustable Suspension	
F	99-04	PICKUP 3/4 TON, SILVERADO 2500 RWD Exc. Electronic Adjustable Suspension	
F	01-04	PICKUP 3/4 TON, SILVERADO 2500 HD RWD	
F	99-07	GMC SIERRA 1500 RWD Exc. Electronic Adjustable Suspension	
F	99-04	SIERRA 2500 RWD Exc. Electronic Adjustable Suspension	
F	01-04	SIERRA 2500 HD RWD	
81921	A		
R	07	CHEVROLET PICKUP 1/2 TON, SILVERADO 1500 4WD Old Body Style; Exc. Electronic Adjustable Suspension	
R	99-06	PICKUP 1/2 TON, SILVERADO 1500 4WD Exc. Electronic Adjustable Suspension	
R	05-06	PICKUP 1/2 TON, SILVERADO 1500 HD All	
R	01-03	PICKUP 1/2 TON, SILVERADO 1500 HD All	
R	77-86	PICKUP 1 TON, K30 All	
R	90-91	PICKUP 1 TON, R3500 All	
R	89	PICKUP 1 TON, R3500 Cab & Chassis, RWD	
R	89	PICKUP 1 TON, R3500 Crew Cab Pickup, RWD	
R	01-09	PICKUP 1 TON, SILVERADO 3500 All	
R	08-10	PICKUP 1 TON, SILVERADO 3500 HD All	
R	87-88	PICKUP 1 TON, V30 All	
R	89-91	PICKUP 1 TON, V3000 / V3500 All	
R	99-08	PICKUP 3/4 TON, SILVERADO 2500 All	
R	01-10	PICKUP 3/4 TON, SILVERADO 2500 HD All	
R	07	SILVERADO 1500 HD CLASSIC All	
R	07	SILVERADO 3500 CLASSIC All	
R	94-02	DODGE PICKUP 1 TON, RAM 3500 (SEE RAM 3500) 4WD	
R	94-02	PICKUP 1 TON, RAM 3500 (SEE RAM 3500) RWD Solid Front Axle	
R	94-02	PICKUP 3/4 TON, RAM 2500 (SEE RAM 2500) 4WD 8800# GVW	
R	77-86	GMC PICKUP 1 TON, K35 / K3500 All	
R	87-91	PICKUP 1 TON, V3000 / V3500 All	
R	07	SIERRA 1500 4WD Old Body Style; Exc. Electronic Adjustable Suspension	
R	99-06	SIERRA 1500 4WD Exc. Electronic Adjustable Suspension	
R	05-06	SIERRA 1500 HD All	
R	01-03	SIERRA 1500 HD All	
R	07	SIERRA 1500 HD CLASSIC All	
R	99-04	SIERRA 2500 All	
R	01-10	SIERRA 2500 HD All	
R	01-06	SIERRA 3500 All	
R	07-10	SIERRA 3500 HD All	
81922	A		141665
F	02-06	CHEVROLET AVALANCHE 1500 All Exc. Electronic Ride Control	

Numerical listing

Shock	POP	Alternative No.	MTG Acc. Supplied
Pos.	Year	Application	
81922	A (cont)		141665
F	07	PICKUP 1/2 TON, SILVERADO 1500 4WD Old Body Style; Exc. Electronic Adjustable Suspension	
F	99-06	PICKUP 1/2 TON, SILVERADO 1500 4WD Exc. Electronic Adjustable Suspension	
F	00-06	SUBURBAN 1/2 TON, 1500 All Exc. Z55 Auto Ride Suspension	
F	02-06	TAHOE All Exc. Z55 Auto Ride Suspension	
F	00-01	TAHOE All New Body Style; Exc. Z55 Auto Ride Suspension	
F	07	GMC SIERRA 1500 4WD Old Body Style; Exc. Electronic Adjustable Suspension	
F	99-06	SIERRA 1500 4WD Exc. Electronic Adjustable Suspension	
F	00-06	YUKON All Exc. Z55 Auto Ride Suspension	
F	00-06	YUKON XL 1/2 TON All Exc. Z55 Auto Ride Suspension	
F	00-13	YUKON XL 3/4 TON All Exc. Z55 Auto Ride Suspension	
81923	D		
R	97-04	DODGE DAKOTA All	
R	98-03	DURANGO 4WD	
R	98-03	DURANGO RWD	
81924	W		
R	02-05	CHEVROLET VENTURE All	
R	97-01	VENTURE FWD	
R	02-04	OLDSMOBILE SILHOUETTE AWD	
R	97-04	SILHOUETTE FWD	
R	99-05	PONTIAC MONTANA All Exc. Air-Leveling Suspension	
R	97-98	TRANS SPORT All	
81925	D		141665
F	02-06	CHEVROLET AVALANCHE 2500 All Exc. Electronic Ride Control	
F	05-06	PICKUP 1/2 TON, SILVERADO 1500 HD All	
F	01-03	PICKUP 1/2 TON, SILVERADO 1500 HD All	
F	01-09	PICKUP 1 TON, SILVERADO 3500 All	
F	05-08	PICKUP 3/4 TON, SILVERADO 2500 All	
F	99-04	PICKUP 3/4 TON, SILVERADO 2500 4WD	
F	07	SILVERADO 1500 HD CLASSIC All	
F	12-13	SUBURBAN 3/4 TON, 2500 All	
F	00-11	SUBURBAN 3/4 TON, 2500 All Exc. Z55 Auto Ride Suspension and Quadrateer	
F	05-06	GMC SIERRA 1500 HD All	
F	01-03	SIERRA 1500 HD All	
F	07	SIERRA 1500 HD CLASSIC All	
F	99-04	SIERRA 2500 4WD	
F	00-06	YUKON XL 3/4 TON All Exc. Hydraulic Self-Leveling System	
81926	C		
R	99-04	JEEP GRAND CHEROKEE All	
81928	W		143000
F	94-01	DODGE PICKUP 1/2 TON, RAM 1500 (SEE RAM 1500) RWD	
F	94-02	PICKUP 1 TON, RAM 3500 (SEE RAM 3500) RWD Exc. Solid Front Axle	
F	94-02	PICKUP 3/4 TON, RAM 2500 (SEE RAM 2500) RWD	
81929	D		
R	97-06	JEEP WRANGLER TJ (MfrBodyCode)	
81930	A		
R	07-13	CHEVROLET AVALANCHE 1500 All Exc. Z55 or ZW7 Ride Suspension	
R	02-06	AVALANCHE 1500 All Exc. Electronic Ride Control	
R	02-06	AVALANCHE 2500 All Exc. Electronic Ride Control	
R	07-11	SUBURBAN 1/2 TON, 1500 All Exc. Z55 or ZW7 Ride Suspension	
R	00-06	SUBURBAN 1/2 TON, 1500 All Exc. Z55 Auto Ride Suspension	
R	00-11	SUBURBAN 3/4 TON, 2500 All Exc. Z55 Auto Ride Suspension and Quadrateer	
R	07-11	TAHOE All Exc. Z55 or ZW7 Ride Suspension	

Numerical listing

Shock	POP	Alternative No.	MTG Acc. Supplied
Pos.	Year	Application	
81930	A (cont)		
R	02-06	TAHOE All Exc. Z55 Auto Ride Suspension	
R	00-01	TAHOE All New Body Style; Exc. Z55 Auto Ride Suspension	
R	07-11	GMC YUKON All Exc. Z55 or ZW7 Ride Suspension	
R	00-06	YUKON All Exc. Z55 Auto Ride Suspension	
R	07-11	YUKON XL 1/2 TON All Exc. Z55 or ZW7 Ride Suspension	
R	00-06	YUKON XL 1/2 TON All Exc. Z55 Auto Ride Suspension	
R	00-11	YUKON XL 3/4 TON All Exc. Z55 Auto Ride Suspension and Quadrasteer	
81931	W		
R	06-08	DODGE PICKUP 1/2 TON, RAM 1500 (SEE RAM 1500) Crew Cab Pickup, 4WD	
R	06-08	PICKUP 1/2 TON, RAM 1500 (SEE RAM 1500) Standard Cab Pickup, 4WD	
R	02-05	PICKUP 1/2 TON, RAM 1500 (SEE RAM 1500) All	
81932	C		
F	02-05	DODGE PICKUP 1/2 TON, RAM 1500 (SEE RAM 1500) 4WD	
81933	C		
F	06-08	DODGE PICKUP 1/2 TON, RAM 1500 (SEE RAM 1500) Crew Cab Pickup, RWD	
F	06-08	PICKUP 1/2 TON, RAM 1500 (SEE RAM 1500) Standard Cab Pickup, RWD	
F	02-05	PICKUP 1/2 TON, RAM 1500 (SEE RAM 1500) RWD	
81934	W 142155		
R	98-10	VOLKSWAGEN BEETLE All	
R	99-06	GOLF A4 (MfrBodyCode)	
R	01-05	JETTA Sedan	
81935	W 142950		
R	08-11	FORD FOCUS All	
R	00-07	FOCUS Hatchback	
R	00-07	FOCUS Sedan	
81936	D		
F	97-06	JEEP WRANGLER TJ (MfrBodyCode)	
81937	W 142389		
R	94-97	HONDA PASSPORT All	
R	91-97	ISUZU RODEO All	
R	98-03	TOYOTA SIENNA All	
Classic Shock Absorbers			
82001	A 141229		
R	67-77	VOLKSWAGEN BEETLE All	
F	66	BEETLE All Exc. 1300 and 1500	
F	52-65	BEETLE All	
R	52-65	BEETLE All	
F	66-73	FASTBACK All	
R	66-73	FASTBACK All	
R	67-74	KARMANN GHIA All	
F	66-73	SQUAREBACK All	
R	66-73	SQUAREBACK All	
R	74-79	SUPER BEETLE All	
R	71-73	SUPER BEETLE All 3 Bolt Flange-Type Lower Mount	
R	73-74	THING All	
F	56-69	TRANSPORTER All	
R	56-67	TRANSPORTER All	
82003	A		
R	69-72	CHEVROLET BLAZER All Coil(RearSpringType)	
R	67-72	PICKUP 1/2 TON, C10 All Coil(RearSpringType)	
R	67-72	PICKUP 3/4 TON, C20 All Coil(RearSpringType)	
R	68-72	SUBURBAN 1/2 TON, C10 All	
R	68-72	SUBURBAN 3/4 TON, C20 All	
R	64-66	VAN 1/2 TON, G / EXPRESS All	
R	67-72	VAN 1/2 TON, P SERIES All	
R	70-72	GMC JIMMY All RWD	
R	67-72	PICKUP 1/2 TON, C15 / C1500 All Coil(RearSpringType)	
R	67-72	PICKUP 3/4 TON, C25 / C2500 All Coil(RearSpringType)	
R	68-72	SUBURBAN 1/2 TON, C15 / C1500 All Coil(RearSpringType)	

Guardian Shock, Classic Shock Absorbers

Shock	POP	Alternative No.	MTG Acc. Supplied
Pos.	Year	Application	
82003	A (cont)		
R	68-72	SUBURBAN 3/4 TON, C25 / C2500 All	
R	64-66	VAN 1/2 TON, G / SAVANA All	
R	68-72	VAN 1/2 TON, P SERIES All	
82004	W 140918		
R	74-80	FORD PINTO Sedan	
R	71-73	PINTO All Sedan	
R	75-80	MERCURY BOBCAT Sedan	
82005	B 141147		
F	66-77	VOLKSWAGEN BEETLE All	
F	67-74	KARMANN GHIA All	
F	73-74	THING All	
82007	B 140349		
F	47-48	FORD DELUXE All Direct Acting Shocks	
R	61-67	ECONOLINE All	
F	47-48	SUPER DELUXE All Direct Acting Shocks	
F	68	INTERNATIONAL 908C All	
F	68	1100C All	
F	68	1200C All Exc. 166" Wheelbase	
F	68	1300C All Exc. 166" Wheelbase	
F	61-71	SCOUT All	
F	61-66	JEEP CJ3 All Exc. 5 Leaf Front Springs & Lift Kit	
F	72-81	CJ5 All Exc. Lift Kit	
F	61-71	CJ5 All Exc. 5 Leaf Front Springs & Lift Kit	
F	72-75	CJ6 All Exc. Lift Kit	
F	66-71	CJ6 All Exc. 5 Leaf Front Springs & Lift Kit	
F	76-81	CJ7 All Exc. Lift Kit	
F	66-74	DJ5 All Exc. Lift Kit	
F	66-68	DJ6 All	
F	57-65	FC150 All	
F	67-71	JEEPSTER All	
R	67-69	JEEPSTER All	
F	81	SCRAMBLER / CJ8 All	
F	61-67	UNIVERSAL All	
F	76-83	TOYOTA LAND CRUISER FJ40 (MfrBodyCode)	
F	75	LAND CRUISER FJ40 (MfrBodyCode) Mfg. to 2/75	
F	67-74	LAND CRUISER All	
82010	B		
F	71-78	CADILLAC ELDORADO All	
F	67-70	ELDORADO All Vertically Mounted	
F	71-78	OLDSMOBILE TORONADO All	
F	66-70	TORONADO All Vertically Mounted	
82011	B 140126		
F	65-71	CHRYSLER 300 All	
F	67-73	IMPERIAL All	
F	65-73	NEWPORT All	
F	65-73	NEW YORKER All	
F	65-73	TOWN & COUNTRY All	
F	65	DODGE 880 All	
F	65-73	MONACO All	
F	65-73	POLARA All	
F	65-73	PLYMOUTH FURY All	
F	72-73	GRAN FURY All	
F	67	VIP All	
82012	C		
F	69-74	FORD VAN 1/2 TON, ECONOLINE / CLUB WAGON All	
F	69-74	VAN 1 TON, ECONOLINE / CLUB WAGON / SUPERDUTY All	
F	69-74	VAN 3/4 TON, ECONOLINE / CLUB WAGON / SUPERDUTY All	
82025	W 140873		
F	75-80	AMERICAN MOTORS PACER All	
82026	A 140455		
F	53	CADILLAC DEVILLE All	
F	50-53	FLEETWOOD / 60 SERIES / 70 SERIES All	
F	50-54	CHEVROLET BEL AIR All	
F	53-62	CORVETTE All	
F	49-52	FLEETLINE All	
F	49-52	FLEETLINE TRUCK All	
F	53-54	ONE-FIFTY SERIES All	
F	49-52	STYLELINE DELUXE All	
F	49-52	STYLELINE SPECIAL All	
F	53-54	TWO-TEN SERIES All	
F	50-56	FORD COUNTRY SEDAN All	
F	50-56	COUNTRY SQUIRE All	
F	54-56	COURIER SEDAN DELIVERY All	
F	50-54	CRESTLINE All	
F	50-52	CUSTOM All	

Numerical listing

Shock	POP	Alternative No.	MTG Acc. Supplied
Pos.	Year	Application	
82026	A (cont) 140455		
F	52-56	CUSTOMLINE All	
F	49-51	DELUXE All	
F	55-56	FAIRLANE All	
F	49	FORD All	
F	52-56	MAINLINE All	
F	56	PARK LANE WAGON All	
F	50-56	RANCH WAGON All	
F	54-56	SKYLINER All	
F	52-56	SUNLINER All	
F	55-57	THUNDERBIRD All	
F	51-56	VICTORIA All	
F	52-54	LINCOLN CAPRI All	
F	52-54	COSMOPOLITAN All	
F	52-56	MERCURY CUSTOM All	
F	56	MEDALIST All	
F	49-51	MERCURY All	
F	55-56	MONTCLAIR All	
F	50-56	MONTEREY All	
F	55	OLDSMOBILE 98 All	
F	51-52	PACKARD 200 All w/ Conventional Suspension	
F	57	PONTIAC BONNEVILLE All	
F	50-57	CATALINA All	
F	49-57	CHIEFTAIN All	
F	54-57	STAR CHIEF All	
F	49-52	STREAMLINER All	
F	57	SUPER CHIEF All	
F	50	STUDEBAKER CHAMPION All	
F	56	POWER HAWK All	
F	55-56	PRESIDENT All	
F	56	SKY HAWK All	
F	59-68	VOLVO 122 All	
F	61-73	1800 All	
82032	W		
R	68-79	VOLKSWAGEN TRANSPORTER All	
82034	C 141138		
R	55-56	CADILLAC DEVILLE All	
R	67	ELDORADO All Vertically Mounted	
R	55-56	FLEETWOOD / 60 SERIES / 70 SERIES All	
F	73-78	FORD PICKUP 3/4 TON, F-250 / SUPERDUTY 4WD Up through Serial No. Y2000	
F	68-72	PICKUP 3/4 TON, F-250 / SUPERDUTY All 4WD; Up through Serial No. Y2000	
F	66-67	PICKUP 3/4 TON, F-250 / SUPERDUTY All 4WD; Up through Serial No. Y20000	
F	61-65	PICKUP 3/4 TON, F-250 / SUPERDUTY All 4WD	
R	67-70	OLDSMOBILE TORONADO All Vertically Mounted	
82035	C 140357		
F	60-62	CHEVROLET C10 PANEL All	
F	60	PICKUP All	
F	60-62	PICKUP 1/2 TON, C10 All	
F	61-62	PICKUP 1 TON, C30 All	
F	60-62	PICKUP 3/4 TON, C20 All	
F	61-62	SUBURBAN 1/2 TON, 1500 All	
F	61-62	VAN 1/2 TON, P SERIES All	
F	61-62	GMC PICKUP 1000 SERIES All	
F	61-62	PICKUP 1500 SERIES All	
F	61-62	PICKUP 2500 SERIES All	
82039	C 140455		
R	53-59	CHEVROLET CORVETTE All	
R	61-71	INTERNATIONAL SCOUT All	
R	69-73	OPEL OPEL All	
82040	B 140455		
R	68-70	CADILLAC ELDORADO All Vertically Mounted; Single Leaf Rear Springs	
R	67-69	CHEVROLET CAMARO All Single Leaf Rear Springs	
R	66	OLDSMOBILE TORONADO All Vertically Mounted; Single Leaf Rear Springs	
R	67	PONTIAC FIREBIRD All Single Leaf Rear Springs	
82047	A 140630		
F	57-58	CHEVROLET PICKUP All	
F	61-67	VAN 1 TON, P SERIES All	
F	61-67	VAN 3/4 TON, P SERIES All	
F	55-59	GMC PICKUP All	
F	67	VAN 1 TON, P SERIES All	
F	67	VAN 3/4 TON, P SERIES All	

Numerical listing

Shock	POP	Alternative No.	MTG Acc. Supplied
Pos.	Year	Application	
82051	C		
R 70		AMERICAN MOTORS	GREMLIN All
R 70			HORNET All
R 58-64		CHEVROLET	BEL AIR All
R 58-64			BISCAYNE All
R 58			DEL RAY All
R 59-60			EL CAMINO All
R 58-64			IMPALA All
82060	A		140630
R 65-68		CADILLAC	CALAIS All
R 65-68			DEVILLE All
R 65-68			FLEETWOOD All
R 50-51			FLEETWOOD / 60 SERIES / 70 SERIES All
R 57-58		CHEVROLET	PICKUP Truck, 3200
R 57-58			PICKUP Truck, 3600
R 50-51		FORD	COUNTRY SQUIRE All
R 49			FORD All
R 50-51			RANCH WAGON All
R 55-59		GMC	PICKUP All Series 100, 150
R 50		STUDEBAKER	CHAMPION All
R 56			POWER HAWK All
R 55-56			PRESIDENT All
R 56			SKY HAWK All
82065	C		140478
R 74		DODGE	M300 All
R 74			M350 All
F 60			PICKUP 1/2 TON, D100 SERIES All
F 60			PICKUP 1/2 TON, W100 SERIES All
R 61-71			PICKUP 1 TON, D300 SERIES All
F 60			PICKUP 3/4 TON, D200 SERIES All
F 60			PICKUP 3/4 TON, W200 SERIES All
F 53-60			TRUCK All
R 53-58			TRUCK All
R 64-70			VAN 1/2 TON, A / B SERIES / RAM Van
R 66-72			VAN 1 TON, P SERIES All
R 61-64			VAN 1 TON, P SERIES All
82066	A		140455
R 60-66		AMERICAN MOTORS	AMBASSADOR All
R 58			AMERICAN All
R 61-66			CLASSIC All
R 65-66			MARLIN All
R 58-61			REBEL All
R 53-54		CADILLAC	DEVILLE All
R 52-54			FLEETWOOD / 60 SERIES / 70 SERIES All
R 55-57		CHEVROLET	BEL AIR All
R 49-52			FLEETLINE All
R 49-52			FLEETLINE TRUCK All
R 55-57			ONE-FIFTY SERIES All
R 50-53			PICKUP Truck, 3100
R 50-53			PICKUP Truck, 3600
R 50-53			PICKUP Truck, 3800
R 55-57			TWO-TEN SERIES All
R 87-88		ISUZU	TROOPER 4WD
R 55-56		PACKARD	CARIBBEAN All w/ Torsion Bar Rear Suspension
R 55-56			CLIPPER All w/ Torsion Bar Rear Suspension
R 56			EXECUTIVE All w/ Torsion Bar Rear Suspension
R 55-56			FOUR-HUNDRED All w/ Torsion Bar Rear Suspension
R 55-56			PATRICIAN All w/ Torsion Bar Rear Suspension LVA
82069	C		140435
F 64-68		AMERICAN MOTORS	AMERICAN All
F 68-69			AMX All
F 68-69			JAVELIN All
F 69			RAMBLER All
R 62-63		MERCEDES-BENZ	190SL All
82070	D		140494
F 62-67		CHEVROLET	CHEVY II All
82072	A		140126
F 57-64		CHRYSLER	300 All
F 57-66			IMPERIAL All
F 57-64			NEWPORT All
F 57-64			NEW YORKER All
F 57-60			SARATOGA All
F 57-64			TOWN & COUNTRY All
F 57-61			WINDSOR All
F 57-60		DESOTO	ADVENTURER All
F 61			DESOTO All
F 57-59			FIREDDOME All
F 57-60			FIREFLITE All
F 57-59			FIRESWEEP All

Classic Shock Absorbers

Shock	POP	Alternative No.	MTG Acc. Supplied
Pos.	Year	Application	
82072	A (cont)		140126
F 62-64		DODGE	880 All
F 57-59			CORONET All
F 57-61			CUSTOM All
F 60-61			DART All
F 60-61			POLARA All
F 57-61		PLYMOUTH	BELVEDERE All
F 58-61			CUSTOM All
F 60-61			FLEET SPECIAL All
F 57-61			FURY All
F 57-58			PLAZA All
F 57-61			SAVOY All
F 60-61			SPORT WAGON All
F 57-61			SUBURBAN All
82075	A		140689
F 62-65		FORD	FAIRLANE All
F 62-63		MERCURY	METEOR All
82076	C		140524
R 58		EDSEL	BERMUDA All
R 58			CITATION All
R 58-59			CORSAIR All
R 60			RANGER All
R 58			ROUNDUP All
R 58-60			VILLAGER All
R 60-64		FORD	COUNTRY SEDAN All
R 59-64			COUNTRY SQUIRE All
R 59-60			COURIER SEDAN DELIVERY All
R 64-66			CUSTOM All
R 60			CUSTOM 300 All
R 60-61			FAIRLANE All
R 60-64			GALAXIE All
R 59			RANCHERO All
R 59-64			RANCH WAGON All
R 59			SKYLINER All
R 60			STARLINER All
R 60			SUNLINER All
R 60			VICTORIA All
R 61-64		MERCURY	COLONY PARK All
R 64			COMMUTER All
R 61-62			COMMUTER All
R 63			COUNTRY CRUISER All
R 63-64			MARAUDER All
R 64			MONTCLAIR All
R 61-64			MONTEREY All
R 64			PARKLANE All
R 62-64			VILLAGER All
82079	A		
F 57-64		OLDSMOBILE	88 SERIES All
F 58-64			98 All
F 58-64			DYNAMIC 88 All
F 57-63			FIESTA All
F 62-63			JETFIRE All
F 61-64			STARFIRE All
F 57			STARFIRE All
82086	B		
R 60		CHEVROLET	PICKUP All
R 60-62			PICKUP 1/2 TON, C10 All
R 60-62			PICKUP 3/4 TON, C20 All
R 61-62			SUBURBAN 1/2 TON, 1500 All
R 61-62			VAN 1/2 TON, P SERIES All
R 61-62		GMC	PICKUP 1000 SERIES All
R 61-62			PICKUP 1500 SERIES All
82087	A		140455
F 56		BUICK	CENTURY All
F 61-64			ELECTRA All
F 61-63			INVICTA All
F 61-64			LESABRE All
F 63-65			RIVIERA All
F 56			ROADMASTER All Exc. Air Suspension
F 56			SPECIAL All
F 56			SUPER All Exc. Air Suspension
F 63-64			WILDCAT All
F 57		PACKARD	CLIPPER All
F 58			HAWK All
F 58			PACKARD All
F 63-64		STUDEBAKER	AVANTI All
F 57-58			CHAMPION All
F 57-58			COMMANDER All
F 57-58			GOLDEN HAWK All
F 60-62			HAWK All
F 59-62			LARK All
F 57-58			PRESIDENT All
F 57-59			SILVER HAWK All
82090	A (cont)		140126
F 62-76			DART All
F 61-62			LANCER All
F 62-64			POLARA All
F 64-74		PLYMOUTH	BARRACUDA All
F 62-70			BELVEDERE All
F 70-76			DUSTER All
F 62-63			FLEET SPECIAL All
F 62-64			FURY All
F 67-70			GTX All
F 68-72			ROAD RUNNER All
F 65-72			SATELLITE All
F 62-64			SAVOY All
F 71-76			SCAMP All
F 70			SUPERBIRD All
F 60-76			VALIANT All
82099	A		140877
F 58-60		CADILLAC	DEVILLE All
F 56			DEVILLE All
F 56-60			FLEETWOOD / 60 SERIES / 70 SERIES All
F 55-57		CHEVROLET	BEL AIR All
F 60-64			CORVAIR All
F 61-64			CORVAIR TRUCK All
F 55-57			ONE-FIFTY SERIES All
F 55-57			TWO-TEN SERIES All
F 58		EDSEL	BERMUDA All
F 58			CITATION All
F 58-59			CORSAIR All
F 58			PACER All
F 58-60			RANGER All
F 58			ROUNDUP All
F 58-60			VILLAGER All
F 57-64		FORD	COUNTRY SEDAN All
F 57-64			COUNTRY SQUIRE All
F 57-60			COURIER SEDAN DELIVERY All
F 64-66			CUSTOM All
F 57			CUSTOM All
F 58-60			CUSTOM 300 All
F 57-58			DEL RIO WAGON All
F 57-61			FAIRLANE All
F 59-64			GALAXIE All
F 59			RANCHERO All
F 57-64			RANCH WAGON All
F 57-59			SKYLINER All
F 60			STARLINER All
F 57-60			SUNLINER All
F 59-60			THUNDERBIRD All
F 57-60			VICTORIA All
F 57-64		MERCURY	COLONY PARK All
F 64			COMMUTER All
F 57-62			COMMUTER All
F 63			COUNTRY CRUISER All
F 59-60			COUNTRY CRUISER All
F 63-64			MARAUDER All
F 58			MEDALIST All
F 64			MONTCLAIR All
F 57-60			MONTCLAIR All
F 57-64			MONTEREY All
F 64			PARKLANE All
F 58-60			PARKLANE All
F 57			TURNPIKE CRUISER All
F 62-64			VILLAGER All
F 57-59			VOYAGER All
F 58-64		PONTIAC	BONNEVILLE All
F 58-64			CATALINA All
F 58			CHIEFTAIN All
F 62-64			GRAND PRIX All
F 58-64			STAR CHIEF All
F 58			SUPER CHIEF All
F 60-61			VENTURA All
F 67			TOYOTA CROWN All Mfg. to 9/67
F 65-66			CROWN All
82103	B		140455
R 63-64		STUDEBAKER	AVANTI All
82104	W		140496
F 65-66		FORD	MUSTANG / MUSTANG II All
82109	A		140455
F 61-64		CADILLAC	DEVILLE All
F 61-64			FLEETWOOD / 60 SERIES / 70 SERIES All
F 65-69		CHEVROLET	CORVAIR All
82110	D		140455
F 65-70		OLDSMOBILE	88 SERIES All
F 65-70			98 All
F 67			CUTLASS / CUTLASS SUPREME Turnpike Cruiser
F 65-66			DYNAMIC 88 All
F 65-66			STARFIRE All
F 65-70		PONTIAC	BONNEVILLE All
F 65-70			CATALINA All

Numerical listing

Shock	POP	Alternative No.	MTG Acc. Supplied
Pos.	Year	Application	
82091	C		
R 70		AMERICAN MOTORS	GREMLIN All
R 70			HORNET All
R 58-64		CHEVROLET	BEL AIR All
R 58-64			BISCAYNE All
R 58			DEL RAY All
R 59-60			EL CAMINO All
R 58-64			IMPALA All
82092	A		140630
R 65-68		CADILLAC	CALAIS All
R 65-68			DEVILLE All
R 65-68			FLEETWOOD All
R 50-51			FLEETWOOD / 60 SERIES / 70 SERIES All
R 57-58		CHEVROLET	PICKUP Truck, 3200
R 57-58			PICKUP Truck, 3600
R 50-51		FORD	COUNTRY SQUIRE All
R 49			FORD All
R 50-51			RANCH WAGON All
R 55-59		GMC	PICKUP All Series 100, 150
R 50		STUDEBAKER	CHAMPION All
R 56			POWER HAWK All
R 55-56			PRESIDENT All
R 56			SKY HAWK All
82093	C		140478
R 74		DODGE	M300 All
R 74			M350 All
F 60			PICKUP 1/2 TON, D100 SERIES All
F 60			PICKUP 1/2 TON, W100 SERIES All
R 61-71			PICKUP 1 TON, D300 SERIES All
F 60			PICKUP 3/4 TON, D200 SERIES All
F 60			PICKUP 3/4 TON, W200 SERIES All
F 53-60			TRUCK All
R 53-58			TRUCK All
R 64-70			VAN 1/2 TON, A / B SERIES / RAM Van
R 66-72			VAN 1 TON, P SERIES All
R 61-64			VAN 1 TON, P SERIES All
82094	A		140455
R 60-66		AMERICAN MOTORS	AMBASSADOR All
R 58			

Numerical listing

Shock	POP	Alternative No.	MTG Acc. Supplied
Pos.	Year	Application	
82110	D (cont)		140455
F	67-70	EXECUTIVE All	
F	65-68	GRAND PRIX All	
F	65-66	STAR CHIEF All	
82118	C		141983
F	58-64	CHEVROLET BEL AIR All	
F	58-64	BISCAYNE All	
F	58	DEL RAY All	
F	59-60	EL CAMINO All	
F	58-64	IMPALA All	
82125	A		140523
R	78-80	AMERICAN MOTORS AMX All	
R	78-83	CONCORD All	
R	71-78	GREMLIN All	
R	71-77	HORNET All	
R	79-83	SPIRIT All	
R	75-76	CADILLAC COMMERCIAL CHASSIS All	
R	58-64	DEVILLE All	
R	57-64	FLEETWOOD / 60 SERIES / 70 SERIES All	
R	52-59	FORD COUNTRY SEDAN All	
R	52-56	COUNTRY SQUIRE All	
R	72-82	COURIER All	
R	54-56	COURIER SEDAN DELIVERY All	
R	52-54	CRESTLINE All	
R	57	CUSTOM All	
R	52	CUSTOM All	
R	58	CUSTOM 300 All	
R	52-56	CUSTOMLINE All	
R	72-76	MAZDA B1600 All	
R	77-78	B1800 All	
R	79-84	B2000 All	
R	82-84	B2200 All	
R	52-56	MERCURY CUSTOM All	
R	56	MEDALIST All	
R	49-51	MERCURY All	
R	55-56	MONTECLAIR All	
R	50-56	MONTEREY All	
R	76-78	NISSAN F10 Wagon	
R	59-66	PEUGEOT 403 All	
R	61-67	404 All	
82126	A		141164
F	70-74	AMERICAN MOTORS AMBASSADOR All	
F	78-80	AMX All	
F	70	AMX All	
F	78-83	CONCORD All	
F	70-78	GREMLIN All	
F	70-77	HORNET All	
F	70-74	JAVELIN All	
F	71-78	MATADOR All	
F	79-83	SPIRIT All	
F	66-70	FORD FAIRLANE All	
F	60-70	FALCON All	
F	60-71	RANCHERO All	
F	65-74	RANCH WAGON All	
F	68-71	TORINO All	
F	60-69	MERCURY COMET All	
F	68-71	CYCLONE All	
F	68-71	MONTEGO All	
82128	C		140873
F	74-77	FORD MUSTANG / MUSTANG II All	
F	74-80	PINTO Sedan	
F	71-73	PINTO All Sedan	
F	75-80	MERCURY BOBCAT All	
82130	D		141132
R	75-80	FORD GRANADA All	
R	70-77	MAVERICK All	
R	77-80	LINCOLN VERSAILLES All	
R	71-77	MERCURY COMET All	
R	75-80	MONARCH All	
R	66-70	NISSAN 1600 All	
R	68-70	2000 All	
82131	A		
R	65-69	CHRYSLER 300 All	
R	75-76	CORDOBA All	
R	74-75	IMPERIAL All	
R	74-78	NEWPORT All	
R	65-69	NEWPORT All	
R	74-78	NEW YORKER All	
R	65-69	NEW YORKER All	
R	74-78	TOWN & COUNTRY All	
R	65-70	TOWN & COUNTRY All	
R	63-64	DODGE 330 All	
R	63-64	440 All	
R	65	880 All	
R	70-74	CHALLENGER All	
R	66-76	CHARGER All	
R	65-76	CORONET All	

Classic Shock Absorbers, Suspension Mounts

Shock	POP	Alternative No.	MTG Acc. Supplied
Pos.	Year	Application	
82131	A (cont)		
R	62	DART All	
R	72-78	MONACO All	
R	65-70	MONACO All	
R	73	POLARA All Exc. Wagon	
R	72	POLARA All	
R	62-70	POLARA All	
R	75-77	ROYAL MONACO All	
R	70-74	PLYMOUTH BARRACUDA All	
R	62-70	BELVEDERE All	
R	62-63	FLEET SPECIAL All	
R	77-78	FURY All Police Package	
R	73-76	FURY All	
R	73	FURY Wagon	
R	62-69	FURY All	
R	74-77	GRAN FURY All	
R	73	GRAN FURY Wagon Wagon	
R	67-71	GTX All	
R	68-75	ROAD RUNNER All	
R	65-74	SATELLITE All	
R	62-64	SAVOY All	
R	70	SUPERBIRD All	
R	67	VIP All	
82138	A		140455
F	65-67	BUICK GRAN SPORT All	
F	64-67	SKYLARK All Heavy Duty Suspension	
F	64-67	SPECIAL All Heavy Duty Suspension	
F	64-67	SPORTWAGON All	
F	64-67	CHEVROLET CHEVELLE All	
F	64-67	EL CAMINO All	
F	64-67	MALIBU All	
F	64-67	OLDSMOBILE CUTLASS / CUTLASS SUPREME Base	
F	64-67	CUTLASS / CUTLASS SUPREME Holiday	
F	61-67	F85 All	
F	64-67	PONTIAC GTO All	
F	64-67	LEMANS All	
F	64-67	TEMPEST All	
82147	D		
R	65-69	FORD PICKUP 1/2 TON, F-100 All 4WD; Exc. Lift Kit	
R	75-78	PICKUP 3/4 TON, F-250 / SUPERDUTY 4WD Up through Serial No. Y20000	
R	66-74	PICKUP 3/4 TON, F-250 / SUPERDUTY All 4WD; Up through Serial No. Y20000	
82151	C		
R	57-58	STUDEBAKER CHAMPION All	
R	57-58	COMMANDER All	
R	57-58	GOLDEN HAWK All	
R	60-62	HAWK All	
R	59-62	LARK All	
R	57-58	PRESIDENT All	
R	57-59	SILVER HAWK All	
82155	A		141041
R	67-69	AMERICAN MOTORS AMBASSADOR All	
R	59-68	AMERICAN All	
R	68-69	AMX All	
R	68-69	JAVELIN All	
R	67	MARLIN All	
R	69	RAMBLER All	
R	59-60	RAMBLER All	
R	59-60	BUICK ELECTRA All Exc. Air Suspension	
R	59-60	INVICTA All Exc. Air Suspension	
R	59-60	LESABRE All Exc. Air Suspension	
R	51-54	CHEVROLET BEL AIR All	
R	50	BEL AIR All Exc. Air Suspension	
R	60-62	CORVETTE All	
R	53-54	ONE-FIFTY SERIES All	
R	55-58	PICKUP 3800	
R	54	PICKUP All	
R	49-52	STYLELINE DELUXE All	
R	49-52	STYLELINE SPECIAL All	
R	53-54	TWO-TEN SERIES All	
R	61-62	VAN 1 TON, P SERIES All	
R	61-62	VAN 3/4 TON, P SERIES All	
R	53-54	GMC PICKUP All 1/2 and 3/4 Ton	
R	64-65	NISSAN 410 All	
R	64-67	411 All	
R	74-76	TOYOTA CORONA Hardtop	
R	74-76	CORONA Sedan	
R	73	CORONA Base, Hardtop Mfg. to 6/73	
R	73	CORONA Base, Sedan Mfg. to 6/73	
R	68-72	CORONA Base, Hardtop	
R	68-72	CORONA Base, Sedan	

Numerical listing

Shock	POP	Alternative No.	MTG Acc. Supplied
Pos.	Year	Application	
82156	A		
R	57-58	BUICK CENTURY All	
R	58	LIMITED All	
R	57-58	ROADMASTER All Exc. Air Suspension	
R	57-58	SPECIAL All Exc. Air Suspension	
R	57-58	SUPER All Exc. Air Suspension	
R	75-80	DODGE COLT Wagon	
R	71-74	COLT All	
R	50-51	FORD COUNTRY SEDAN All	
R	50-51	CRESTLINE All	
R	50-51	CUSTOM All	
R	49-51	DELUXE All	
R	47-48	DELUXE All Direct Acting Shocks	
R	47-48	SUPER DELUXE All Direct Acting Shocks	
R	51	VICTORIA All	
R	78-81	NISSAN 510 Wagon	
R	83-84	MAXIMA Wagon	
R	51-56	OLDSMOBILE 98 All	
R	76-80	PLYMOUTH COLT All	
R	57-60	PONTIAC BONNEVILLE All	
R	50-60	CATALINA All	
R	49-58	CHIEFTAIN All	
R	54-60	STAR CHIEF All	
R	49-52	STREAMLINER All	
R	57-58	SUPER CHIEF All	
R	60	VENTURA All	
R	74-78	TOYOTA CORONA Wagon	
R	73	CORONA Wagon Mfg. from 8/73	
R	71	CORONA Mark II, Wagon Exc. Wagon	
R	69-70	CORONA Mark II, Wagon	
R	65-66	CROWN Wagon Wagon	
82601	A		140455
F	65-70	BUICK ELECTRA All	
F	70	ESTATE WAGON All	
F	65-70	LESABRE All	
F	66-70	RIVIERA All	
F	65-70	WILDCAT All	
F	65-76	CADILLAC CALAIS All	
F	75-76	COMMERCIAL CHASSIS All	
F	65-76	DEVILLE All	
F	65-76	FLEETWOOD All	
82602	W		140629
R	65-70	BUICK ELECTRA All	
R	65-70	LESABRE All	
R	65-70	WILDCAT All	
R	71-76	CADILLAC CALAIS All	
R	71-76	DEVILLE All	
R	71-76	FLEETWOOD All	
82609	C		
R	61-64	BUICK ELECTRA All	
R	61-63	INVICTA All	
R	61-64	LESABRE All	
R	63-65	RIVIERA All	
R	63-64	WILDCAT All	
82615	D		
F	61-69	LINCOLN CONTINENTAL All	
82618	C		140629
R	66-70	BUICK RIVIERA All	
Suspension Mounts			
142135	W		
R	91-98	BMW 318i All	
R	84-85	318i All	
R	91-98	318iS All	
R	95-99	318Ti All	
R	98-99	323i All	
R	87-88	325 All	
R	84-87	325E All	
R	87-95	325i All	
R	87-92	325iS All	
R	88-91	325iX All	
R	96-98	328i All	
R	88-91	M3 All	
142173	W		
R	83-87	DODGE CHARGER All	
R	78-90	OMNI All	
R	87-89	PLYMOUTH EXPO All	
R	78-90	HORIZON All	
R	85	TURISMO All	
R	83	TURISMO All	
142195	W		
F	88-92	AUDI 80 All	
F	88-92	80 QUATTRO All	
F	93-95	90 All	
F	88-91	90 All	
F	93-95	90 QUATTRO All	

Numerical listing

Shock	POP	Alternative No.	MTG Acc. Supplied
Pos.	Year	Application	
142195 W (cont)			
F	88-91	90 QUATTRO	All
F	80-87	4000	All
F	84-87	4000 QUATTRO	All
F	83-87	COUPE	All
F	90-91	COUPE QUATTRO	All
F	82-88	VOLKSWAGEN QUANTUM	All
142230 W			
F	01-03	ACURA CL	All
F	97-99	CL	All
F	97-03	EL	All
F	90-01	INTEGRA	All
R	90-93	INTEGRA	All
F	86-90	LEGEND	All Auto-Leveling System
R	02-06	RSX	All
F	95-14	TL	All
R	99-12	TL	All
F	92-94	VIGOR	All
R	98-12	HONDA ACCORD	All
F	86-12	ACCORD	All
R	88-05	CIVIC	All
F	88-00	CIVIC	All
F	93-97	CIVIC DEL SOL	All
R	93-97	CIVIC DEL SOL	All
R	03-12	CR-V	All
F	97-01	CR-V	All
R	97-01	CR-V	All
F	88-91	CRX	All
R	88-91	CRX	All
R	03-11	ELEMENT	All
F	95-98	ODYSSEY	All
R	95-98	ODYSSEY	All
F	83-01	PRELUDE	All
R	06-14	RIDGELINE	All
R	00-09	S2000	All
F	00-07	S2000	All
F	96-99	ISUZU OASIS	All
R	96-99	OASIS	All
142245 W			
R	91-02	SATURN SC / SL / SW SERIES	All
142249 W			
R	85-88	CHEVROLET NOVA	All
R	88-89	TOYOTA CELICA	GT
R	88-89	CELICA	GTS
R	88-89	CELICA	ST
R	86-87	CELICA	All
R	84-87	COROLLA	All
R	87	TERCEL	Wagon
R	83-86	TERCEL	All
142251 W			
F	73-79	VOLKSWAGEN SUPER BEETLE	All
142252 W			
R	85-93	VOLKSWAGEN CABRIOLET	All
R	90-92	CORRADO	All
R	85-98	GOLF	All
R	80-98	JETTA	All
R	75-84	RABBIT	All
R	75-89	SCIROCOCO	All
142329 W			
F	93-95	DODGE COLT	All
F	93-96	EAGLE SUMMIT	Coupe
F	93-96	SUMMIT	Sedan
F	96	96 MITSUBISHI MIRAGE	All Mfg. to 5/96
F	95	MIRAGE	Sedan
F	93-94	MIRAGE	All
F	93-94	PLYMOUTH COLT	Sedan
142402 W			
R	95-00	FORD CONTOUR	All
R	99-00	MERCURY COUGAR	All
R	95-00	MYSTIQUE	All
142419 W			
R	01-05	CHRYSLER SEBRING	ST (MfrBodyCode), Coupe
F	96-00	SEBRING	Coupe
R	96-00	SEBRING	Coupe
F	95	SEBRING	All
R	95	SEBRING	All
R	89-90	DODGE 2000 GTX	All Exc. Auto-Leveling System
F	95-00	AVENGER	All
R	95-00	AVENGER	All
R	92-95	COLT	All
R	89-91	COLT	Hatchback
R	91-96	STEALTH	All
R	01-05	STRATUS ST	(MfrBodyCode), Coupe

Suspension Mounts

Shock	POP	Alternative No.	MTG Acc. Supplied
Pos.	Year	Application	
142419 W (cont)			
R	91-93	EAGLE 2000 GTX	All
R	93-96	SUMMIT	All
R	89-92	SUMMIT	Sedan
R	92	SUMMIT	Wagon
F	95-98	TALON	All
R	90-98	TALON	All
R	06-11	HYUNDAI ACCENT	All
R	92-95	ELANTRA	Non-ABS
F	00-05	SONATA	All
R	00-05	SONATA	All
R	01	XG300	All
R	02-05	XG350	All
R	01-06	KIA MAGENTIS	All
R	01-06	OPTIMA	All
R	06-11	RIO	All
R	06-11	RIO	All
R	91-99	91-99 MITSUBISHI 3000GT	All
R	97-04	DIAMANTE	All
R	90-05	ECLIPSE	All
F	95-99	ECLIPSE	All
R	92-95	EXPO	All
R	89-07	GALANT	All
F	94-98	GALANT	All
R	85-88	GALANT	All Exc. Electronic Adjustable Suspension
R	97-02	MIRAGE	All
R	96	MIRAGE	All Mfg. to 5/96
R	95	MIRAGE	Sedan
R	89-94	MIRAGE	All
R	89-90	SIGMA	Non-ABS Exc. Auto-Leveling System
R	89-94	PLYMOUTH COLT	All
R	90-94	LASER	All
142444 W			
F	92-94	VOLKSWAGEN CORRADO	VR6
F	93-98	GOLF	All
F	94-98	JETTA	2.8L 6Cyl V (2771), 3.25 82.5(Bore)3.40 86.4(Stroke)
F	90-97	PASSAT	All
142526 W			
F	05-09	BUICK ALLURE	All
F	97-05	CENTURY	All
F	05-09	LACROSSE	All
F	97-04	REGAL	All Exc. Heavy Duty Suspension
F	05-07	TERRAZA	FWD
F	00-16	CHEVROLET IMPALA	All
F	00-07	MONTE CARLO	All
F	05-09	UPLANDER	FWD Exc. Air-Leveling Suspension
F	02-05	VENTURE	All
F	97-01	VENTURE	FWD
F	98-02	OLDSMOBILE INTRIGUE	All
F	97-04	SILHOUETTE	All
F	01-05	PONTIAC AZTEK	All
F	97-08	GRAND PRIX	All
F	99-09	MONTANA	All
F	97-99	TRANS SPORT	All
F	05-07	SATURN RELAY	FWD
142530 W			
F	91-99	BUICK LESABRE	All
F	97-99	OLDSMOBILE 88	SERIES All
F	96-99	LSS	All
F	97-98	REGENCY	All
F	97-99	PONTIAC BONNEVILLE	All
142546 W			
F	96-99	INFINITI I30	All
F	95-99	NISSAN MAXIMA	All
142547 W			
F	91-96	INFINITI G20	All
R	96-99	I30	All
R	95-99	NISSAN MAXIMA	All
142556 W			
F	95-04	TOYOTA AVALON	All
F	95-01	CAMRY	All
F	94-99	CELICA	All
142561 W			
F	92-94	LEXUS ES300	All
F	92-94	TOYOTA CAMRY	All
142569 W			
F	90-92	FORD PROBE	GT, 2.2L 4Cyl L (133), 3.39 86.1(Bore)3.70 94.0(Stroke), Automatic
F	89	PROBE	GT, 2.2L 4Cyl L (133), 3.39 86.1(Bore)3.70 94.0(Stroke)

Numerical listing

Shock	POP	Alternative No.	MTG Acc. Supplied
Pos.	Year	Application	
142569 W (cont)			
F	88-92	MAZDA 626	Automatic Exc. Electronic Adjustable Suspension or 4 Wheel Steer
F	89-92	MX6	Automatic
142625 W			
F	96-06	HYUNDAI ELANTRA	All
F	97-01	TIBURON	All
142649 W			
F	97-01	LEXUS ES300	All Right Exc. Electronic Adjustable Suspension
F	99-03	RX300	All Right
F	97-04	TOYOTA AVALON	All Right
F	97-01	CAMRY	All Right
F	98-03	SIENNA	All Right Mfg. to 12/02
F	99-03	SOLARA	All Right
142650 W			
F	97-01	LEXUS ES300	All Left Exc. Electronic Adjustable Suspension
F	99-03	RX300	All Left
F	97-04	TOYOTA AVALON	All Left
F	97-01	CAMRY	All Left
F	98-03	SIENNA	All Left
F	99-03	SOLARA	All Left
142651 W			
F	00-06	AUDI TT	All
F	00-06	TT QUATTRO	All
F	98-10	VOLKSWAGEN BEETLE	All
F	99-06	GOLF	A4 (MfrBodyCode)
F	01-05	JETTA	Sedan
F	99-00	JETTA	All
142653 W			
R	98-04	AUDI A6	All
R	98-01	VOLKSWAGEN PASSAT	All
142746 W			
F	86-95	FORD TAURUS	All
F	91-95	MERCURY SABLE	Sedan
F	86-90	SABLE	All
142747 W			
F	96-07	FORD TAURUS	All
F	96-05	MERCURY SABLE	All
142755 W			
F	93-97	CHRYSLER CONCORDE	All
F	94-97	LHS	All
F	94-96	NEW YORKER	All
F	93-97	DODGE INTREPID	All
F	93-97	EAGLE VISION	All
142828 W			
R	99-04	CHRYSLER 300M	All
R	98-04	CONCORDE	All
R	98-04	INTREPID	All
R	99-01	LHS	All
R	98-04	DODGE INTREPID	All
142836 W			
F	95-96	LEXUS ES300	All
F	95-96	TOYOTA AVALON	All
F	95-96	CAMRY	All
142843 W			
F	95-00	FORD CONTOUR	All
F	99-02	MERCURY COUGAR	All
F	95-00	MYSTIQUE	All
142850 W			
F	82-85	HONDA ACCORD	All
142852 W			
F	89-92	FORD PROBE	All
F	88-92	MAZDA 626	Automatic Exc. Electronic Adjustable Suspension or 4 Wheel Steer
F	88-92	MX6	Automatic Exc. Electronic Adjustable Suspension or 4 Wheel Steer
142930 W			
F	00-11	FORD FOCUS	All
142932 W			
F	00-02	CHRYSLER NEON	All
F	01-10	PT CRUISER	All
F	00-05	DODGE NEON	All
F	00-01	PLYMOUTH NEON	All
142933 W			
F	86-93	CHRYSLER DAYTONA	All
F	88-93	DYNASTY	All

Numerical listing

Shock	POP	Alternative No.	MTG Acc. Supplied
Pos.	Year	Application	
142933 W (cont)			
F	90-93	IMPERIAL All	
F	86	LASER All	
F	86-95	LEBARON All	
F	86-93	NEW YORKER All	
F	90-95	TOWN & COUNTRY All	
F	86-88	DODGE 600 All	
F	86-89	ARIES All	
F	86-95	CARAVAN / GRAND CARAVAN All	
F	86-93	DAYTONA All	
F	88-93	DYNASTY All	
F	86-89	LANCER All	
F	87-94	SHADOW All	
F	89-95	SPIRIT All	
F	89-95	PLYMOUTH ACCLAIM All	
F	86-88	CARAVELLE All	
F	86-89	RELIANT All	
F	87-94	SUNDANCE All	
F	86-95	VOYAGER / GRAND VOYAGER All	
142937 W			
F	03-08	INFINITI FX35 All	
F	03-08	FX45 All	
F	00-01	I30 All	
F	02-04	I35 All	
F	02-06	NISSAN ALTIMA All	
F	00-08	MAXIMA All	
F	03-07	MURANO All	
F	04-09	QUEST All	
142938 W			
F	97-03	INFINITI QX4 All	
F	96-03	NISSAN PATHFINDER All	
143030 W			
F	95-00	CHRYSLER CIRRUS All	
F	96-00	SEBRING Convertible	
F	95-98	DODGE STRATUS All	
F	96-99	PLYMOUTH BREEZE All	
143071 W			
R	95-01	CHEVROLET LUMINA All Left	
R	95-96	MONTE CARLO All Left	
143072 W			
R	95-01	CHEVROLET LUMINA All Right	
R	95-96	MONTE CARLO All Right	
143073 W			
R	05-09	BUICK ALLURE All Left	
R	97-05	CENTURY All Left	
R	05-09	LACROSSE All Left	
R	97-04	REGAL All Left Exc. Heavy Duty Suspension	
R	00-11	CHEVROLET IMPALA All Left	
R	95-01	LUMINA All Left	
R	95-07	MONTE CARLO All Left	
R	98-02	OLDSMOBILE INTRIGUE All Left	
R	97-08	PONTIAC GRAND PRIX All Left	
143074 W			
R	05-09	BUICK ALLURE All Right	
R	97-05	CENTURY All Right	
R	05-09	LACROSSE All Right	
R	97-04	REGAL All Right Exc. Heavy Duty Suspension	
R	00-11	CHEVROLET IMPALA All Right	
R	95-01	LUMINA All Right	
R	95-07	MONTE CARLO All Right	
R	98-02	OLDSMOBILE INTRIGUE All Right	
R	97-08	PONTIAC GRAND PRIX All Right	
143082 W			
F	00	BMW 323CI Coupe	
F	00	323I Wagon	
F	01-06	325CI All Sport Suspension; Exc. M-Sport Pack II	
F	01-06	325i All Mfg. to 9/01; Sport Suspension	
F	00	328CI All	
F	99-00	328i All	
F	01-06	330CI All Exc. Sport Suspension M-Sport Pack II	
F	97-00	528i All Exc. Electronic Adjustable Suspension	
143087 W			
F	01-05	CHRYSLER SEBRING ST (MfrBodyCode), Coupe	
F	01-05	DODGE STRATUS ST (MfrBodyCode), Coupe	
F	01-04	HYUNDAI SANTA FE All	
F	05-09	TUCSON All	
F	97-04	NISSAN ALTIMA All	
F	00-05	ECLIPSE All	
F	99-03	GALANT All	

Suspension Mounts

Shock	POP	Alternative No.	MTG Acc. Supplied
Pos.	Year	Application	
143088 W			
F	02-07	MITSUBISHI LANCER All	
F	03-06	OUTLANDER All	
143089 W			
F	03-07	SATURN ION All	
143094 W			
R	03-08	PONTIAC VIBE All	
R	05-10	SCION TC All	
R	00-05	TOYOTA CELICA All	
R	03-08	COROLLA All	
R	03-08	MATRIX All	
R	01-09	PRIUS All	
143191 W			
F	94-97	VOLVO 850 Wagon Exc. Hydraulic Self-Leveling System	
F	93-97	850 Sedan Exc. Hydraulic Self-Leveling System	
F	06-07	C70 All	
F	98-04	C70 All	
F	01-07	S60 All	
F	98-00	S70 All	
F	99-06	S80 All Exc. Nivomat Rear Suspension	
F	06-07	V70 R, AWD	
F	04-05	V70 2.4	
F	04-05	V70 2.5T	
F	04-05	V70 R	
F	01-05	V70 T5	
F	04	V70 2.5T AWD	
F	01-03	V70 2.4T	
F	01-03	V70 Base	
F	02	V70 AWD	
F	99-00	V70 R AWD Exc. Auto Rear Leveling	
F	98-00	V70 Base Exc. Auto Rear Leveling	
F	98-00	V70 GLT Exc. Auto Rear Leveling	
F	00	V70 2.4T Exc. Auto Rear Leveling	
F	00	V70 GLT SE Exc. Auto Rear Leveling	
F	98-99	V70 AWD Exc. Auto Rear Leveling	
F	98	V70 R Exc. Auto Rear Leveling	
F	04-06	XC90 All	
F	03	XC90 AWD	
143194 W			
F	00-05	TOYOTA ECHO All Only fits OE P/N's 48609-52011 & 48609-52050	
143197 W			
R	90-94	LEXUS LS400 All Exc. Auto-Leveling System	
143201 W			
F	00-05	TOYOTA CELICA All	
F	03-08	COROLLA All	
F	04-09	PRIUS All	
143202 W			
F	02-03	LEXUS ES300 All Exc. Electronic Adjustable Suspension	
F	04-06	ES330 All Exc. Adaptive Variable Suspension	
F	04-06	RX330 All	
F	06-07	RX400H All	
F	02-06	TOYOTA CAMRY All	
F	01-07	HIGHLANDER All	
F	04-08	SIENNA All	
F	04-08	SOLARA All	
143204 W			
F	03-04	CHEVROLET TRACKER All	
F	01-02	TRACKER 2.5L 6Cyl V (2500), 3.31 84.0(Bore)2.95 75.0(Stroke)	
F	99-02	TRACKER 2.0L 4Cyl L (122), 3.31 84.1(Bore)3.54 90.0(Stroke)	
F	99-04	SUZUKI GRAND VITARA All	
F	99-04	VITARA Non-ABS	
F	02-06	XL-7 All	
143209 W			
R	00-06	NISSAN SENTRA All	
143218 W			
F	98-02	MAZDA 626 All	
143227 W			
F	01-03	KIA RIO All	
143239 W			
F	06-11	CHEVROLET AVEO All	
F	04-11	AVEO All	
F	09-10	PONTIAC G3 All	
F	05-08	WAVE All	

Numerical listing

Shock	POP	Alternative No.	MTG Acc. Supplied
Pos.	Year	Application	
143244 W			
F	03-06	FORD EXPEDITION All Exc. Adjustable Suspension	
F	03-05	LINCOLN NAVIGATOR All	
143256 W			
R	00-02	CHRYSLER NEON All	
R	00-05	DODGE NEON All	
R	00-01	PLYMOUTH NEON All	
143277 W			
F	93-99	NISSAN ALTIMA All	
F	90-92	STANZA All	
143281 W			
F	98-02	CHEVROLET PRIZM All	
F	89-97	GEO PRIZM All	
F	90-91	LEXUS ES250 All	
F	88-02	TOYOTA COROLLA All	
143305 W			
F	12-17	HONDA ODYSSEY All From Chassis/VIN CB088499	
F	05-10	ODYSSEY All	
143315 W			
F	01-06	ACURA MDX All	
F	99-04	HONDA ODYSSEY All	
F	03-08	PILOT All	
143316 W			
F	07-13	CADILLAC ESCALADE All Exc. Electronic Ride Control	
F	07-13	ESCALADE ESV All Exc. Electronic Ride Control	
F	07-13	ESCALADE EXT All Exc. Electronic Ride Control	
F	07-13	CHEVROLET AVALANCHE 1500 All Exc. Electronic Ride Control	
F	07-13	PICKUP 1/2 TON, SILVERADO 1500 All Exc. Electronic Adjustable Suspension	
F	07-13	SUBURBAN 1/2 TON, 1500 All Exc. Z55 or ZW7 Ride Suspension	
F	07-14	TAHOE All Exc. Z55 or ZW7 Ride Suspension	
F	07-13	GMC SIERRA 1500 All Exc. Electronic Adjustable Suspension	
F	07-14	YUKON All Exc. Electronic Adjustable Suspension	
F	07-14	YUKON XL 1/2 TON All Exc. Z55 Auto Ride Suspension	
143317 W			
R	03-06	FORD EXPEDITION All	
143318 W			
F	02-05	FORD EXPLORER All	
F	02-05	MERCURY MOUNTAINEER All	
143319 W			
R	02-05	FORD EXPLORER All	
R	02-05	MERCURY MOUNTAINEER All	
143320 W			
R	99-00	CHRYSLER SEBRING Convertible	
143321 W			
R	01-06	CHRYSLER SEBRING JR (MfrBodyCode), Sedan	
R	01-06	DODGE STRATUS Sedan	
143323 W			
F	05-10	CHEVROLET COBALT LS	
F	05-10	COBALT LT	
F	10	COBALT Base	
F	10	COBALT LT Team Canada	
F	06-07	COBALT LTZ	
F	05	COBALT Base	
F	11	HHR All	
F	08-10	HHR LS Panel	
F	08-10	HHR LT Panel	
F	06-10	HHR LT	
F	06-10	HHR LT	
F	06-08	HHR Comfort LT	
F	06-08	HHR Elegance LT	
F	07	HHR Edicion Especial	
F	07-09	PONTIAC G5 All	
F	05-06	PURSUIT All	
143324 W			
F	06-08	DODGE PICKUP 1/2 TON, RAM 1500 (SEE RAM 1500) 4WD Exc. Mega Cab	
143325 W			
F	96-02	TOYOTA 4RUNNER 4WD	

Numerical listing

Shock	POP	Alternative No.	MTG Acc. Supplied
Pos.	Year	Application	
143325 W (cont)			
F	01-07	SEQUOIA All	
F	95-04	TACOMA 4WD	
F	00-06	TUNDRA All	
143335 W			
R	05-10	CHRYSLER 300 All	
R	08-10	DODGE CHALLENGER All	
R	06-10	CHARGER All	
R	05-08	MAGNUM All	
143336 W			
F	11-14	CHRYSLER 200 All	
F	07-10	SEBRING All	
F	08-14	DODGE AVENGER All	
143339 W			
F	08-17	TOYOTA SEQUOIA All Exc. Air Suspension	
143340 W			
R	08-22	TOYOTA SEQUOIA All	
R	07-21	TUNDRA All w/ Off Road Package	
143341 W			
F	05-07	FORD FREESTYLE All	
F	05-10	MUSTANG / MUSTANG II All	
F	05-07	MERCURY MONTEGO All	
143342 W			
F	06-11	HYUNDAI AZERA All	
F	06-10	SONATA All	
F	07-09	KIA AMANTI All	
143344 W			
F	06-11	AUDI A3 All	
F	08-09	TT All	
F	08-10	TT QUATTRO All	
F	09-17	VOLKSWAGEN CC All	
F	07-11	EOS All	
F	10-11	GOLF All	
F	06-14	GTI All	
F	06-17	JETTA All	
F	09-10	PASSAT All	
F	06-10	PASSAT All	
F	08	R32 All	
F	06-09	RABBIT All	
F	09-11	TIGUAN All	
143345 W			
R	06-11	AUDI A3 All	
R	08-09	TT All	
R	08-10	TT QUATTRO All	
R	09-17	VOLKSWAGEN CC All	
R	07-11	EOS All	
R	10-11	GOLF All	
R	06-14	GTI All	
R	06-17	JETTA All	
R	09-10	PASSAT All	
R	12-13	PASSAT All Mfg to 10/12	
R	10	PASSAT All Mfg to 10/12	
R	06-09	PASSAT All	
R	08	R32 All	
R	06-09	RABBIT All	
R	09-17	TIGUAN All	
R	18	TIGUAN LIMITED All	
143346 W			
F	02-07	NISSAN X-TRAIL All	
143349 W			
F	06-08	CHEVROLET OPTRA All	
F	04-08	SUZUKI FORENZA All	
F	05-08	RENO All	
143353 W			
F	02-06	ACURA RSX Base	
F	02-06	RSX Type-S	
F	02-05	HONDA CIVIC Hatchback Exc. Hybrid & Si Models	
F	01	CIVIC All	
F	02-06	CR-V All	
F	03-06	ELEMENT All	
143354 W			
F	04-12	CHEVROLET MALIBU All Left	
F	05-10	PONTIAC G6 All Left	
F	07-09	SATURN AURA All Left	
143355 W			
F	04-12	CHEVROLET MALIBU All Right	
F	05-10	PONTIAC G6 All Right	
F	07-09	SATURN AURA All Right	
143357 W			
F	07-11	FORD CROWN VICTORIA All	
F	03-06	CROWN VICTORIA Base	

Suspension Mounts

Shock	POP	Alternative No.	MTG Acc. Supplied
Pos.	Year	Application	
143357 W (cont)			
F	03-06	CROWN VICTORIA LX	
F	04-05	CROWN VICTORIA LX Sport	
F	05	CROWN VICTORIA S	
F	05	CROWN VICTORIA Special Edition	
F	03	CROWN VICTORIA LWB	
F	03	CROWN VICTORIA S	
F	03-11	LINCOLN TOWN CAR Executive	
F	03-11	MERCURY GRAND MARQUIS All	
143359 W			
F	04-10	INFINITI QX56 All	
F	05-11	NISSAN ARMADA All	
F	04-11	TITAN All	
143360 W			
F	06-10	FORD EXPLORER All	
F	06-10	MERCURY MOUNTAINEER All	
143361 W			
R	06-10	FORD EXPLORER All	
R	06-10	MERCURY MOUNTAINEER All	
143363 W			
F	05-06	CHEVROLET EQUINOX All	
F	06	PONTIAC TORRENT All	
143364 W			
F	06-10	JEEP COMMANDER All	
F	05-10	GRAND CHEROKEE All	
143365 W			
F	10-12	MAZDA 3 Grand Touring	
F	10-12	3 GX	
F	10-12	3 I Touring	
F	08-12	3 GS	
F	08-12	3 GT	
F	04-12	3 i	
F	12	3 GS-SKY	
F	12	3 S	
F	08-09	3 S	
F	08	3 GX	
F	05	3 SP23	
F	06-10	5 All	
143366 W			
F	08-12	BUICK ENCLAVE All	
F	09-12	CHEVROLET TRAVERSE All	
F	07-12	GMC ACADIA All	
F	07-10	SATURN OUTLOOK All	
143367 W			
F	96-05	TOYOTA RAV4 All	
143369 W			
F	05-10	CHRYSLER 300 RWD	
F	08-10	DODGE CHALLENGER All	
F	06-10	CHARGER RWD	
F	05-08	MAGNUM RWD	
143380 W			
R	02-05	VOLKSWAGEN PASSAT FWD	
143385 W			
F	05-09	DODGE DAKOTA All	
F	06-09	MIITSUBISHI RAIDER All	
143387 W			
R	04-06	LEXUS RX330 All Left Exc. Air Suspension	
R	07-09	RX350 All Left Exc. Air Suspension	
R	06-08	RX400H All Left	
R	04-07	TOYOTA HIGHLANDER All Left	
143388 W			
R	04-06	LEXUS RX330 All Right Exc. Air Suspension	
R	07-09	RX350 All Right Exc. Air Suspension	
R	06-08	RX400H All Right	
R	04-07	TOYOTA HIGHLANDER All Right	
143390 W			
R	05-07	FORD FIVE HUNDRED FWD Left	
R	05-07	MERCURY MONTEGO All Left	
143391 W			
R	05-07	FORD FIVE HUNDRED FWD Right	
R	05-07	MERCURY MONTEGO All Right	
143394 W			
R	02-10	MIITSUBISHI LANCER All	
R	03-11	OUTLANDER All	
143396 W			
R	03-07	NISSAN MURANO All	
R	04-09	QUEST All	

Numerical listing

Shock	POP	Alternative No.	MTG Acc. Supplied
Pos.	Year	Application	
143397 W			
F	03-08	HYUNDAI TIBURON All	
143398 W			
F	10	MIITSUBISHI ENDEAVOR All	
F	04-08	ENDEAVOR All	
F	04-10	GALANT All	
143401 W			
F	02-07	SUZUKI AERIO All	
143404 W			
F	02-06	MINI COOPER All	
143405 W			
F	02-11	MINI COOPER All	
143406 W			
F	05-10	SCION TC All	
143408 W			
R	98-05	LEXUS GS300 All	
R	98-00	GS400 All	
R	01-05	GS430 All	
R	01-05	IS300 All	
143409 W			
F	06-11	HYUNDAI ACCENT All Left	
F	06-11	KIA RIO All Left	
F	06-11	RIO All Left	
143410 W			
F	06-11	HYUNDAI ACCENT All Right	
F	06-11	KIA RIO All Right	
F	06-11	RIO All Right	
143412 W			
F	06-08	MAZDA MX-5 MIATA All	
R	06-08	MX-5 MIATA All	
143415 W			
F	07-10	FORD EDGE All	
F	08	TAURUS All	
F	08	TAURUS X All	
F	07-10	LINCOLN MKX All	
F	08-09	MERCURY SABLE All	
143416 W			
F	07-09	HYUNDAI ENTOURAGE All	
F	07-11	SANTA FE All	
F	07-11	VERACRUZ All	
F	06-11	KIA SEDONA All	
143418 W			
R	02-07	SUZUKI AERIO All	
143419 W			
F	04-06	KIA AMANTI All	
R	04-06	AMANTI All	
143422 W			
R	00-04	VOLVO S40 All	
R	00-04	V40 All	
143423 W			
R	03-06	CHRYSLER SEBRING JR (MfrBodyCode), Convertible	
R	03-06	SEBRING JR (MfrBodyCode), Sedan	
F	01-06	SEBRING JR (MfrBodyCode), Convertible	
F	01-06	SEBRING JR (MfrBodyCode), Sedan	
F	01-06	DODGE STRATUS Sedan	
R	01-06	STRATUS Sedan	
R	99-00	STRATUS All	
143425 W			
R	08-12	CHEVROLET MALIBU All	
R	04	MALIBU All	
R	05-10	PONTIAC G6 All	
R	07-09	SATURN AURA XE	
R	07-09	AURA XR	
R	07-08	AURA Green Line	
143455 W			
F	03-07	INFINITI G35 All	
F	06-07	M35 All	
F	03-08	NISSAN 350Z All	
143458 W			
F	02-05	KIA SEDONA All	
143459 W			
F	04-06	PONTIAC GTO All	
143460 W			
F	10-12	CHEVROLET CAMARO All	

Numerical listing

Shock	POP	Alternative No.	MTG Acc. Supplied
Pos.	Year	Application	

143461 W
R 10-12 **CHEVROLET** CAMARO 3.6L 6Cyl V (217), 3.70 94.0(Bore)3.37 85.6(Stroke) Left

143462 W
R 10-12 **CHEVROLET** CAMARO 3.6L 6Cyl V (217) Right

143464 W
F 01-03 **MINI** COOPER All

143465 W
R 02-03 **SUBARU** IMPREZA All Left

143466 W
R 02-03 **SUBARU** IMPREZA All Right

143468 W
F 11-13 **CHRYSLER** 300 All
F 11-13 **DODGE** CHARGER AWD

143473 W
F 10-15 **CHEVROLET** CRUZE All
F 16 CRUZE LIMITED All

143474 W
R 10-15 **CHEVROLET** CRUZE All
R 16 CRUZE LIMITED All

143476 W
R 11-14 **FORD** EXPLORER All
R 10-14 **TAURUS** All

143477 W
F 07-11 **HYUNDAI** ELANTRA All

143486 W
F 13-14 **CHEVROLET** TRAVERSE All

143491 W
F 07-12 **MINI** COOPER All

143492 W
F 09-13 **SUBARU** FORESTER All
F 06-08 FORESTER Manual
F 98-05 FORESTER All
F 12-14 IMPREZA All Exc. Sti
F 08-11 IMPREZA All
F 04-07 IMPREZA All Exc. Sti
F 93-03 IMPREZA All
F 90-13 LEGACY All
F 00-14 OUTBACK All

143495 W
F 07-12 **DODGE** CALIBER All
F 07-10 **JEEP** COMPASS All
F 07-10 **PATRIOT** All

143496 W
R 07-11 **DODGE** CALIBER All
R 07-10 **JEEP** COMPASS All
R 07-09 **PATRIOT** All

143498 W
R 06-11 **HONDA** CIVIC All

143530 W
R 12-13 **HONDA** CIVIC All

143531 W
R 04-11 **MAZDA** 3 All
R 06-10 5 All

143564 W
F 10-13 **FORD** TRANSIT CONNECT All

Strut Cushion

143057 W
F 93 **ASUNA** GT, SE All
F 88-92 **AUDI** 80 All
F 88-92 80 QUATTRO All
F 93-95 90 All
F 88-91 90 All
F 93-95 90 QUATTRO All
F 88-91 90 QUATTRO All
F 89-90 100 QUATTRO All
F 89-90 200 QUATTRO Wagon
F 80-87 4000 All
F 84-87 4000 QUATTRO All
F 83-87 COUPE All
F 90-91 COUPE QUATTRO All
F 90-94 V8 QUATTRO All
F 95-99 **BMW** 318TI All
F 97-05 **BUICK** PARK AVENUE All
F 97-99 RIVIERA All
F 95-05 **CHEVROLET** CAVALIER All

Suspension Mounts, Strut Cushion

Shock	POP	Alternative No.	MTG Acc. Supplied
Pos.	Year	Application	

143057 W (cont)
R 04-05 CLASSIC All
R 97-03 MALIBU All
R 98-01 METRO Non-ABS
R 89-91 SPRINT All
F 99-04 **CHRYSLER** 300M All
F 93-04 CONCORDE All
R 87-89 CONQUEST All Exc. Electronic Adjustable Suspension
F 83 E CLASS All
F 83 EXECUTIVE SEDAN All
F 93-04 INTREPID CAN
F 81-83 LEBARON All
F 99-01 LHS All
F 94-97 LHS All
R 00-02 NEON All
F 94-96 NEW YORKER All
F 83 NEW YORKER All
R 01-10 PT CRUISER All
F 96-00 SEBRING Coupe
F 96-00 SEBRING Coupe
F 95 SEBRING All
R 95 SEBRING All
F 82-83 **DODGE** 400 All
F 83 600 All
F 81-83 ARIES All
F 83-87 CHARGER All
F 90-95 COLT Sedan
F 90-94 COLT Hatchback
F 93-04 INTREPID All
F 95-05 NEON All
F 78-89 OMNI All
F 82-84 RAMPAGE All
F 91-93 **EAGLE** 2000 GTX CAN
F 89-96 SUMMIT All
F 90-94 TALON All
F 93-97 VISION All
F 94-97 **FORD** ASPIRE Non-ABS
F 81-96 ESCORT All
F 82-88 EXP All
F 00-05 FOCUS Hatchback
F 00-05 FOCUS Sedan
R 89-97 PROBE All
R 94-07 **TAURUS** Sedan
F 84-85 TEMPO All
R 89-97 **Geo** METRO Non-ABS
F 85-87 **HONDA** CIVIC Wagon, 4WD
F 92-95 **HYUNDAI** ELANTRA Non-ABS
F 90-94 EXCEL All
R 89-94 SONATA All
F 91-96 **INFINITI** G20 All
F 92-02 **LEXUS** ES300 All
R 02 ES300 All Exc. Electronic Adjustable Suspension
R 92-01 ES300 All
F 90-94 **MAZDA** 323 All
R 93-97 626 All
R 88-92 626 All Exc. Electronic Adjustable Suspension or 4 Wheel Steer
F 86-87 626 Automatic Exc. Electronic Adjustable Suspension
R 86-87 626 Automatic Exc. Electronic Adjustable Suspension
F 83-85 626 All
R 83-85 626 All
R 84-85 GLC All
R 81-83 GLC Hatchback
R 81-83 GLC Sedan
R 88-97 MX6 All
F 90-03 PROTG / PROTG5 All
F 91-93 **MERCURY** CAPRI All
F 82-83 LN7 All
F 81-87 LYNX All
R 94-05 SABLE Sedan
F 84-85 TOPAZ All
F 91-96 TRACER FWD
F 93-98 VILLAGER All
F 90-94 **MINI** COOPER All
F 92-95 EXPO All
R 94-98 GALANT All
F 89-98 GALANT All
F 89-96 MIRAGE All
F 90-94 PRECIS All
F 87-89 STARION All
F 95-98 **NISSAN** 200SX All
F 90-96 300ZX 2+2
F 84-86 300ZX All
F 00-01 ALTIMA All
R 89-94 MAXIMA All
R 87-88 MULTI CAN
F 91-93 NX All
F 83-90 PULSAR / PULSAR NX All
F 93-98 QUEST All
F 91-99 SENTRA All
F 87-90 SENTRA FWD

Numerical listing

Shock	POP	Alternative No.	MTG Acc. Supplied
Pos.	Year	Application	

143057 W (cont)
F 82-86 SENTRA All
R 87-89 STANZA Sedan
R 99-04 **OLDSMOBILE** ALERO All
R 97-99 CUTLASS / CUTLASS SUPREME All
F 92-93 **PLYMOUTH** COLT All
F 89-91 COLT Hatchback, FWD
F 87-89 EXPO All
F 78-89 HORIZON All
F 90-94 LASER All
F 95-99 NEON All
F 81-83 RELIANT All
F 83 SCAMP All
F 85 TURISMO All
F 83 TURISMO All
R 94-99 **PONTIAC** FIREFLY CAN
R 89-91 FIREFLY CAN
R 99-05 GRAND AM All
F 88-93 LEMANS All
F 95-05 SUNFIRE All
F 86-98 **SAAB** 900 All
F 91-02 **SATURN** SC / SL / SW SERIES All
F 98-02 **SUBARU** FORESTER All
R 98-02 FORESTER All
F 90-99 LEGACY All
R 90-99 LEGACY All
F 95-02 **SUZUKI** ESTEEM All
R 95-02 ESTEEM All
R 89-91 SWIFT All
F 95-03 **TOYOTA** AVALON All
R 95-03 AVALON All
F 87-01 CAMRY All
R 87-01 CAMRY All
R 92-93 CELICA All
F 75-85 CELICA All
F 93-02 COROLLA All
R 93-02 COROLLA All
F 88 COROLLA FX
F 88 COROLLA FX16
F 80-87 COROLLA All
F 75-79 COROLLA Wagon
F 74 COROLLA All Mfg. from 8/74
F 99-03 SOLARA All
R 86-91 SUPRA All
F 86 SUPRA All
R 83-88 TERCEL Wagon
F 87-93 **VOLKSWAGEN** FOX All
F 82-88 QUANTUM All
F 71-79 SUPER BEETLE All
F 75-93 **VOLVO** 240 / 242 / 244 / 245 / 262 / 264 / 265 All

143058 W
F 93 **ASUNA** SUNFIRE (CANADIAN VEHICLE) All Exc. Lotus Suspension
R 85-88 **CHEVROLET** NOVA All
R 98-02 PRIZM All
F 85-88 SPECTRUM All
R 99-04 **CHRYSLER** 300M All
R 98-04 CONCORDE All
F 87-89 CONQUEST All Exc. Electronic Adjustable Suspension
R 98-04 INTREPID CAN
R 99-01 LHS All
R 94-97 LHS All
R 84-86 **DODGE** CONQUEST All
R 98-04 INTREPID All
R 95-00 **FORD** CONTOUR All
R 91-96 ESCORT All
R 93-97 **Geo** PRIZM All
F 89 SPECTRUM All
F 90-93 STORM Non-ABS
F 90-92 **ISUZU** IMPULSE All
F 91-93 STYLUS All
F 86-89 **MAZDA** 323 FWD
R 86-89 323 FWD
R 92-03 PROTG / PROTG5 All
R 90-91 PROTG / PROTG5 FWD
R 99-02 **MERCURY** COUGAR All
R 91-96 TRACER FWD
R 87-89 TRACER FWD
R 87-89 **MINI** COOPER All
F 84-86 STARION LE
R 84-86 STARION LE
F 84-85 STARION LS
R 84-85 STARION LS
F 83 STARION All
R 83 STARION All
F 86 **NISSAN** STANZA Sedan
F 82-85 STANZA All
F 85-88 **PONTIAC** SUNBURST CAN
F 87-88 **PORSCHE** 924 All
F 77-82 924 All
F 83-88 944 All

Numerical listing

Shock	POP	Alternative No.	MTG Acc. Supplied
Pos.	Year	Application	
143058 W (cont)			
F	86-87	SAAB	9000 All
F	83-86	TOYOTA	CAMRY All
R	84-92	COROLLA	FWD
F	85-93	VOLKSWAGEN	CABRIOLET All
F	85-98	GOLF	All
F	80-98	JETTA	All
F	90-01	PASSAT	All
F	75-84	RABBIT	All
F	80-83	RABBIT PICKUP	All
F	75-89	SCIROCCO	All
F	84-92	VOLVO	740 / 745 / 760 / 780 All
F	91-95	940 All Exc.	Hydraulic Self-Leveling System
F	92-95	960	All
143059 W			
R	73-79	AUDI	FOX All
F	92-98	BUICK	SKYLARK All
F	92-96	CHEVROLET	BERETTA All
F	87-94	CAVALIER	All
F	92-96	CORSICA	All
F	98-01	METRO	Non-ABS
R	95-07	MONTE CARLO	All
F	85-88	NOVA	All
F	98-02	PRIZM	All
F	89-91	SPRINT	All
F	86-93	CHRYSLER	DAYTONA CAN
F	88-93	DYNASTY	CAN
F	90-93	IMPERIAL	All
F	86-95	LEBARON	All
F	04-08	PACIFICA	All
F	90-00	TOWN & COUNTRY	All
F	00-07	VOYAGER / GRAND VOYAGER	All
F	84-00	DODGE	CARAVAN / GRAND CARAVAN All
F	78-83	CHALLENGER	All
F	85-91	COLT	Vista, Wagon, FWD
F	84	COLT	Wagon
F	71-80	COLT	Wagon
F	86-93	DAYTONA	All
F	88-93	DYNASTY	All
F	87-88	MINI	RAM All
R	95-99	NEON	All
F	90	OMNI	All
F	87-94	SHADOW	All
F	89-95	SPIRIT	All
F	89-91	EAGLE	VISTA Wagon, CAN
R	81-90	FORD	ESCORT All
R	82-88	EXP	All
F	78-83	FAIRMONT	All
F	88-93	FESTIVA	All
F	81-82	GRANADA	All
F	83-86	LTD / COUNTRY SEDAN / COUNTRY SQUIRE / CROWN VICTORIA	All
F	79-93	MUSTANG	/ MUSTANG II All
F	94-07	TAURUS	All
R	86-93	TAURUS	Sedan
F	86-93	TAURUS	Wagon
R	84-94	TEMPO	All
F	87-88	THUNDERBIRD	Non-ABS
F	80-86	THUNDERBIRD	All
F	95-03	WINDSTAR	All
F	89-97	GEO	METRO Non-ABS
F	89-97	PRIZM	All
R	82-85	HONDA	ACCORD All
F	76-81	ACCORD	All
R	83-87	PRELUDE	All
F	79-87	PRELUDE	All
F	98-05	HYUNDAI	ACCENT All
R	97	ACCENT	All Mfg. to 6/97
F	95-96	ACCENT	All
R	95-96	ACCENT	All
F	86-89	EXCEL	All
F	82-87	LINCOLN	CONTINENTAL All
F	84-92	MARK VII	All
F	81-85	MAZDA	GLC Hatchback
F	81-85	GLC	Sedan
F	86-91	RX7	All
R	91-93	MERCURY	CAPRI All
F	79-86	CAPRI	All
F	80-88	COUGAR	All
R	82-83	LN7	All
R	81-87	LYNX	All
F	83-86	MARQUIS	All
F	86-05	SABLE	All
R	84-94	TOPAZ	All
F	87-91	TOPAZ	All
F	78-83	ZEPHYR	All
F	83-88	MIITSUBISHI	CORDIA All
F	95-05	ECLIPSE	All
R	95-05	ECLIPSE	All
F	97-02	MIRAGE	All
F	87-89	PRECIS	All

Strut Cushion

Shock	POP	Alternative No.	MTG Acc. Supplied
Pos.	Year	Application	
143059 W (cont)			
F	83-88	TREDIA	All
F	80-88	NISSAN	200SX All
F	79-82	210	All
F	89-94	240SX	All
R	70-73	240Z	All
R	74-75	260Z	All
R	75-78	280Z	All
F	79-83	280ZX	All
F	79-82	310	All
F	78-81	510	All
F	81	810	All
R	00-01	ALTIMA	All
F	90-94	AXXESS	All
R	90-94	AXXESS	All
F	74-78	B210	All
F	76-78	F10	All
F	89-94	MAXIMA	All
R	86-88	MAXIMA	Sedan
R	85	MAXIMA	All
F	82-84	MAXIMA	All
R	86-90	PULSAR / PULSAR NX	All
F	90-92	STANZA	All
F	92-98	OLDSMOBILE	ACHIEVA All
F	89-95	PLYMOUTH	ACCLAIM All
F	76-80	ARROW	All
F	79-82	CHAMP	All
F	84-91	COLT	Vista, Wagon
F	80-83	COLT	Hatchback
F	76-79	COLT	Sedan
F	76-79	COLT	Wagon
R	87-89	EXPO	All
F	90	HORIZON	Hatchback
F	95-99	NEON	All
R	78-83	SAPORO	All
F	96-00	VOYAGER / GRAND VOYAGER	Non-ABS
F	84-00	VOYAGER / GRAND VOYAGER	All
R	84-88	PONTIAC	FIERO All
F	94-99	FIREFLY	CAN
F	89-91	FIREFLY	CAN
F	92-98	GRAND AM	All Exc. Electronic Adjustable Suspension
R	91-02	SATURN	SC / SL / SW SERIES All
F	07-09	SUZUKI	SWIFT All
F	89-01	SWIFT	All
F	72-73	TOYOTA	CARINA All
F	92-93	CELICA	GT
F	92-93	CELICA	GTS
F	92-93	CELICA	ST
R	90-91	CELICA	AWD
F	90-91	CELICA	AWD
F	86-89	CELICA	All
F	89-92	COROLLA	All
F	88	COROLLA	DLX
F	88	COROLLA	GTS
F	88	COROLLA	LE
F	88	COROLLA	SR5
F	79-82	CORONA	All
F	78-92	CRESSIDA	All
F	92-95	MR2	All
F	85-89	MR2	All
F	92-99	PASEO	All
F	81-84	STARLET	All
F	80-99	TERCEL	All
143061 W			
R	93	ASUNA	SUNFIRE (CANADIAN VEHICLE) All Exc. Lotus Suspension
R	88-92	AUDI	80 All
R	93-95	90	All
R	88-91	90	All
R	89-94	100	All
F	89-94	100	All Mfg. Late 91
R	89-90	200	All
R	80-87	4000	All
R	84-87	4000	QUATTRO All
R	95-97	A6	QUATTRO All
F	83-87	COUPE	All
F	91-98	BMW	318i All
F	84-85	318i	All
F	91-98	318iS	All
F	98-99	323i	All
F	87-88	325	All
F	84-87	325E	All
F	87-95	325i	All
F	87-92	325iS	All
F	88-91	325iX	All
F	96-98	328i	All
F	89-95	525i	All
F	82-88	528E	All
F	94-95	530i	All
F	83-84	533i	All
F	91-93	535i	All
F	90	535i	All Mfg. from 8/90

Numerical listing

Shock	POP	Alternative No.	MTG Acc. Supplied
Pos.	Year	Application	
143061 W (cont)			
F	85-89	535i	All
F	88	535iS	All
F	85-89	635CSI	All
F	86-92	735i	All
F	88-92	735iL	All
R	05-09	BUICK	ALLURE All
R	97-05	CENTURY	All
F	85-90	ELECTRA	All
R	05-09	LACROSSE	All
F	90	LESABRE	All Early Design Front Strut w/ Spring Guard
F	86-89	LESABRE	All
R	97-04	REGAL	All
F	86-89	RIVIERA	All
F	87-88	CADILLAC	ALLANTE All
F	87-92	BROUGHAM	All
F	85-90	COMMERCIAL CHASSIS	All
F	85-90	DEVILLE	All
F	86-89	ELDORADO	All
F	85-90	FLEETWOOD	All
F	86-89	SEVILLE	All
R	00-16	CHEVROLET	IMPALA All
R	95-01	LUMINA	All
F	95-00	FORD	CONTOUR All
F	97-03	ESCORT	All
R	89-92	GEO	PRIZM All
R	90-93	STORM	Non-ABS
F	99-04	HONDA	ODYSSEY All
R	90-92	ISUZU	IMPULSE All
R	91-93	STYLUS	All
F	90-91	LEXUS	ES250 All
R	90-91	ES250	All
F	00-06	MAZDA	MPV All
F	99-02	MERCURY	COUGAR All
F	97-99	TRACER	FWD
F	86-90	OLDSMOBILE	88 SERIES All Early Design Front Strut w/ Spring Guard
F	85-90	98	All
R	98-02	INTRIGUE	All
F	91	PEUGEOT	504 / 505 / 604 All
F	86-90	504 / 505 / 604	Sedan
F	87-89	PONTIAC	BONNEVILLE All
F	88-88	SAAB	9000 All
F	80-87	SUBARU	BRAT All
F	85-89	DL	All
F	85-89	GL	Hatchback
F	90-94	LOYALE	All
F	91-97	TOYOTA	PREVIA All
F	90-92	VOLKSWAGEN	CORRADO All
143063 W			
R	91-95	ACURA	LEGEND All
R	86-90	LEGEND	All Auto-Leveling System
R	85-89	BMW	635CSI All
R	95-00	CHRYSLER	CIRRUS All
R	96-00	SEBRING	Convertible
R	95-00	DODGE	STRATUS All
R	88-93	FORD	FESTIVA All
R	90-02	HONDA	ACCORD All
R	95-98	ODYSSEY	All
R	96-99	ISUZU	OASIS All
R	86-91	MAZDA	RX7 All
R	93	MIITSUBISHI	GALANT All
R	90-92	GALANT	AWD
R	89	GALANT	All
R	96-00	PLYMOUTH	BREEZE All
R	90-92	VOLKSWAGEN	CORRADO All
R	87-93	FOX	All
R	85-98	GOLF	All
R	85-98	JETTA	All
R	98-01	PASSAT	All
R	82-88	QUANTUM	All
R	75-89	SCIROCCO	All
143064 W			
R	97-99	ACURA	CL All
F	97-00	EL	All
R	97-00	EL	All
F	90-01	INTEGRA	All
R	90-01	INTEGRA	All
F	86-90	LEGEND	All Auto-Leveling System
F	92-94	VIGOR	All
R	92-94	VIGOR	All
F	95-00	CHRYSLER	CIRRUS All
F	96-00	SEBRING	Convertible
R	89	DODGE	2000 GTX CAN
R	92-95	COLT	All
R	89-91	COLT	Hatchback
F	95-00	STRATUS	All
R	91-93	EAGLE	2000 GTX CAN
R	92	SUMMIT	Sedan
R	89-91	SUMMIT	All
R	90-94	TALON	All
F	90-02	HONDA	ACCORD All

Numerical listing

Shock	POP	Alternative No.	MTG Acc. Supplied
Pos.	Year	Application	

143064 W (cont)
 R 86-89 ACCORD All
 R 89-00 CIVIC All
 R 93-97 CIVIC DEL SOL All
 F 97-01 CR-V All
 R 97-01 CR-V All
 F 89-91 CRX All
 R 88 CRX All
 F 95-98 ODYSSEY All
 R 92-01 PRELUDE All
 F 88-01 PRELUDE All
 F 96-99 ISUZU OASIS All
 F 95-99 KIA SPORTAGE All
 R 91-97 MAZDA MIATA Non-ABS
 R 90 MIATA All
 R 90-94 MITSUBISHI ECLIPSE All
 R 85-88 GALANT All
 R 89-02 MIRAGE All
 R 89-90 SIGMA Non-ABS
 R 89-94 NISSAN 240SX All
 R 90-96 300ZX 2+2
 F 96-00 PLYMOUTH BREEZE All
 R 90-94 LASER All
 R 90-94 SUBARU LOYALE All
 R 85-91 XT FWD, Coil (RearSpringType)
 R 92-99 TOYOTA PASEO All
 R 91-99 TERCEL All
 R 87-90 TERCEL Hatchback
 R 87-90 TERCEL Sedan

Strut Cushion

Shock	POP	Alternative No.	MTG Acc. Supplied
Pos.	Year	Application	

Numerical listing

Shock	POP	Alternative No.	MTG Acc. Supplied
Pos.	Year	Application	

COMPETITIVE & O.E.M. INTERCHANGE LIST
Lista de Intercambios contra Competidores y Equipo Original.
Liste dinterchange de produits comptitifs & dquipement original (OEM)

ACDelco

ACdelco	Gabriel	Upgrade	ACdelco	Gabriel	Upgrade	ACdelco	Gabriel	Upgrade	ACdelco	Gabriel	Upgrade
13329507	G51982		501-384	143241		503-706	G51935		507-2	85302	89420
13330740	G52435		501-386	143281		503-708	G52395		507-2	89420	
13330741	G52436		501-4	143061		503-709	G52396		507-3	85307	
13345954	G51971		501-5	143059		503-710	G52494		507-4	85303	89422
15058617	G64014		501-75	83303		503-711	G52495		507-4	89422	
18041239	G63676		501-77	142244		503-712	G52435		507-5	85308	89422
19165214	G63869		501-82	142249		503-713	G52436		507-5	89422	
19172143	G51728		501-92	143204		504-1234	142316		507-6	85314	89425
19177778	G51718		503-117	G55526		504-501	49255		507-6	89425	
19203623	G51746		503-141	G55591		504-505	49107		507-7	85301	
19235162	G51736		503-160	G56518		504-508	49122		507-8	85301	
19241342	G56809		503-172	G55661		504-510	49128		507-9	85700	
19294056	G56726		503-173	G55662		504-511	49131		508-13	85012	89413
19294309	G57022		503-195	G55697		504-512	49135		508-13	89413	
19294310	G56929		503-196	G55698		504-516	49152		508-14	83216	
19294314	G57051		503-248	G55772		504-517	49155		508-14	85012	89413
19294318	G57013		503-278	G55820		504-518	49157		508-14	89413	
19294319	G57014		503-280	G55825		504-520	49162		508-15	83216	
19294320	G56948		503-285	G55856		504-531	49203		508-16	83308	
19294321	G56948		503-322	G55948		504-534	49212		508-17	83312	89409
19294322	G56950		503-323	G55949		504-535	43162		508-17	89409	
19294323	G56949		503-338	G55999		504-535	49213		508-18	83309	
19294325	G56951		503-340	G56700		504-537	49215		508-19	83314	
19294330	G57048		503-341	G56701		504-539	49218		508-20	83207	89407
19294331	G57047		503-353	G56718		504-547	49228		508-20	89407	
19294350	G52013		503-388	G56518		504-547	49255		508-21	83214	
19294353	G52026		503-389	G55892		504-549	49230		508-23	83225	
19307626	G51850		503-589	G56509		504-550	49231		508-24	83215	
19324428	G57048		503-599	G51746		504-554	49235		508-26	83203	89436
19324429	G57047		503-615	G56773		504-557	49304		508-26	85030	89440
19325297	G52278		503-616	G56774		504-562	49311		508-26	89436	
19325298	G52279		503-637	G56809		504-564	49334		508-26	89440	
19359121	G52395		503-638	G56810		504-579	49254		508-28	83207	89407
19359122	G52396		503-662	G56886		505-520	G55825		508-28	89407	
19359125	G52494		503-663	G56887		506-253	G55698		508-29	85030	89440
19359126	G52495		503-664	G52013		506-310	G52014		508-29	89440	
19359128	G52435		503-665	G52014		506-657	G52246		508-3	83400	
19359129	G52436		503-666	G52025		506-658	G52245		508-30	85005	89430
22737716	G52395		503-667	G52026		506-687	G52013		508-30	89430	
22737717	G52396		503-668	G52027		506-749	G52281		508-35	G63306	
22737724	G51975		503-677	G51759		506-753	G52280		508-39	G63347	
501-10	143057		503-681	G52125		506-801	G56886		508-42	G63353	
501-114	142317		503-682	G52116		506-803	G56887		508-464	G63676	
501-13	83318		503-683	G52127		506-806	G52395		508-47	G63350	
501-179	142439		503-684	G52128		506-807	G52396		508-48	G63409	
501-186	142524		503-685	G51904		506-854	G52435		508-5	G63359	
501-187	142526		503-686	G51871		506-855	G52436		508-5	G63360	
501-192	142530		503-687	G51850		507-1	85304		508-50	G63299	
501-2	143058		503-688	G51891		507-10	85711		508-52	G63405	
501-209	142547		503-689	G51870		507-11	85308	89422	508-52	G63419	
501-218	142836		503-699	G52244		507-11	89422		508-56	G63605	
501-275	142751		503-700	G52278		507-13	85704		508-57	83123	89405
501-276	142752		503-701	G52279		507-16	85702		508-57	89405	
501-318	142561		503-702	G52280		507-17	85304		508-59	G63183	
501-334	142567		503-703	G52281		507-18	85305		508-68	83209	89414
501-358	143073		503-705	G51949		507-19	85700		508-68	85006	

Important Note: Competitive Interchanges are to be used for stocking purposes only. Where multiple crosses are identified, please reference the applications section of this catalog./ **Remarque importante:** Les interchanges concurrentiels ne s'utilisent qu'aux fins de stocks. Dans le cas de rfrences multiples, consulter la section des applications du catalogue./ **Nota importante:** Dans le cas de rfrences multiples, consulter la section des applications du catalogue./ **Nota importante:** Se pueden usar intercambios competitivos para propósitos de almacenamiento solamente. Cuando se identifican intercambios múltiples, consulte la sección de aplicaciones de este catálogo.

COMPETITIVE & O.E.M. INTERCHANGE LIST
Lista de Intercambios contra Competidores y Equipo Original.
Liste d'interchange de produits compétitifs & d'équipement original (OEM)

ACDelco... cont'd

AcDelco	Gabriel	Upgrade	AcDelco	Gabriel	Upgrade	AcDelco	Gabriel	Upgrade	AcDelco	Gabriel	Upgrade
508-68	89414		520-176	81482		520-39	61541		530-133	G63421	
508-71	83314		520-177	81481		520-392	61664		530-134	G63357	
508-72	G63386		520-178	81490		520-393	81869		530-147	G63403	
508-74	G63511		520-179	81494		520-394	69622		530-147	G63413	
508-78	83400		520-180	81492		520-394	81880		530-151	G63366	
508-79	G63424		520-182	81495		520-396	61675		530-156	G63421	
508-80	G63425		520-183	81496		520-398	61777		530-157	G63422	
508-82	G63410		520-184	81484		520-40	61542		530-158	G63423	
508-86	83136		520-186	81507		520-401	61687		530-159	G63424	
508-87	85071		520-187	81514		520-403	61683		530-16	69715	
508-9	85000	89436	520-188	81516		520-406	61690		530-160	G63425	
508-9	89436		520-19	61519		520-407	61684		530-161	G63426	
508-90	83136		520-194	81540		520-408	61685		530-17	69714	
509-606	14017		520-196	81548		520-409	61717		530-175	G63375	
509-607	14018		520-197	81549		520-41	61543		530-176	G63454	
509-610	14040		520-199	81553		520-410	61718		530-189	G63488	
509-611	6801SE		520-2	61501		520-42	61544		530-189	G63609	
509-612	6802SE		520-205	81559		520-426	81930		530-190	G63489	
509-613	6803SE		520-206	81560		520-427	81318		530-193	G63492	
509-626	6853SE		520-210	81582		520-428	81873		530-2	69604	
519-15	43111		520-214	81667		520-429	81920		530-20	69675	
519-2	43048		520-215	81668		520-431	81922		530-201	G63403	
519-21	43162		520-22	61522		520-432	81924		530-202	G63411	
519-22	43163		520-220	81675		520-433	81925		530-203	G63394	
519-29	43180		520-227	81713		520-5	61504		530-211	G63511	
519-3	43049		520-238	81750		520-53	61555		530-223	G63609	
519-30	43181		520-24	61524		520-58	61560		530-235	G63625	
519-31	34036		520-25	61525		520-61	61565		530-238	G63638	
519-32	34051		520-261	82003		520-65	61575		530-243	G63662	
519-36	34073		520-268	82010		520-7	61506		530-247	G63675	
519-5	43060		520-27	61528		520-85	61600		530-251	G63683	
519-5	49152		520-292	82034		520-89	61605		530-253	G63690	
520-1	61500		520-293	82035		520-9	61508		530-267	G63721	
520-100	61616		520-298	82040		520-99	61615		530-268	G63722	
520-115	61641		520-30	61531		525-16	58403		530-274	G63902	
520-116	61642		520-300	82047		525-21	58412		530-279	G63907	
520-117	61643		520-310	82060		525-25	58421		530-281	G63909	
520-132	61659		520-319	82070		525-26	58422		530-295	G63776	
520-135	61663		520-323	82075		525-27	58423		530-298	G63783	
520-138	81039		520-324	82076		525-33	58488		530-3	69606	
520-141	81095		520-326	82079		525-34	58489		530-300	G63799	
520-142	81096		520-331	82086		525-36	58609		530-301	G63803	
520-145	81113		520-332	82087		525-42	58638		530-311	G63817	
520-146	81164		520-34	61535		525-44	58662		530-312	G63818	
520-147	81147		520-343	82109		525-55	58901		530-315	69625	
520-150	81242		520-344	82110		525-59	58803		530-324	G63829	
520-152	81270		520-35	61536		525-6	58357		530-335	G63842	
520-154	81340		520-350	82118		525-66	58817		530-336	G63844	
520-157	81394		520-353	82125		525-68	58930		530-338	G63847	
520-16	61516		520-360	82138		530-1	69600		530-37	69795	
520-164	81510		520-365	82151		530-10	69676		530-387	G63866	
520-165	81082		520-37	61539		530-129	G63347		530-393	G63868	
520-168	69675		520-371	82601		530-129	G63423		530-394	G63869	
520-168	81446		520-372	82602		530-130	G63349		530-395	G63884	
520-17	61517		520-378	82609		530-130	G63422		530-4	69622	
520-175	81478		520-386	82618		530-133	G63355		530-402	G63882	

Important Note: Competitive Interchanges are to be used for stocking purposes only. Where multiple crosses are identified, please reference the applications section of this catalog. / **Remarque importante:** Les interchanges concurrentiels ne s'utilisent qu'aux fins de stocks. Dans le cas de références multiples, consulter la section des applications du catalogue. / **Nota importante:** Dans le cas de références multiples, consulter la section des applications du catalogue. / **Nota importante:** Se pueden usar intercambios competitivos para propósitos de almacenamiento solamente. Cuando se identifican intercambios múltiples, consulte la sección de aplicaciones de este catálogo.

COMPETITIVE & O.E.M. INTERCHANGE LIST

Lista de Intercambios contra Competidores y Equipo Original.

Liste d'interchange de produits compititifs & equipement original (OEM)

ACDelco... cont'd

AcDelco	Gabriel	Upgrade	AcDelco	Gabriel	Upgrade	AcDelco	Gabriel	Upgrade	AcDelco	Gabriel	Upgrade
530-403	G63879		540-5032	77488		88945415	G63675		901-086	143462	
530-407	G51718		540-5033	77488		88945417	G63678		903-003RS	G56726	
530-42	69811		540-5033	77489		88945453	G63928		903-004RS	G56927	
530-423	G63872		540-5040	77609		88945468	G63799		903-005RS	G56927	
530-439	G51736		540-5043	77638		88945597	G55526		903-005RS	G56928	
530-441	G63893		540-5046	77662		88945640	G56518		903-012RS	G57060	
530-442	G63896		540-5062	77783		88945652	G55661		903-014RS	G56938	
530-443	G63897		540-5063	77803		88945653	G55662		903-015RS	G57022	
530-448	G63959		540-5069	77817		88945675	G55697		903-016RS	G56929	
530-449	G63894		540-5077	77907		88945728	G55772		903-020RS	G57051	
530-450	G63895		540-5078	77909		88945758	G55820		903-024RS	G57013	
530-454	69590		540-5088	77953		88945760	G55825		903-025RS	G57014	
530-455	G64014		540-514	G51904		88945765	G55856		903-026RS	G56948	
530-456	69587		550-13	85005	89430	88945818	G55999		903-027RS	G56948	
530-457	69589		550-13	89430		88961957	G56518		903-028RS	G56950	
530-466	G64015		550-73	83303		88963960	G55892		903-029RS	G56949	
530-467	70031		550-73	85005	89430	88973940	G52014		903-031RS	G56951	
530-469	G64040		550-73	89430		88973942	G52013		903-032RS	G56924	
530-476	G64101		550-75	83303		88974638	G51736		903-033RS	G56925	
530-479	70059		550-77	83221		88991409	G63882		903-035RS	G57000	
530-480	G51971		560-200	G51871		901-015	142249		903-035RS	G57023	
530-480	G51975		560-201	G51871		901-016	142245		903-038RS	G57048	
530-481	G64140		560-545	69845		901-026	142317		903-039RS	G57047	
530-482	G511030		560-596	G51736		901-038	142526		903-040RS	G57125	
530-483	G51982		560-681	G51971		901-039	142526		903-041RS	G57070	
530-5	69624		560-691	G51975		901-042	142530		903-041RS	G57122	
530-6	69632		560-809	G52494		901-052	143073		903-042RS	G57069	
530-9	69724		560-810	G52495		901-053	143074		903-042RS	G57121	
540-127	69898		560-811	G52494		901-055	142316		903-043RS	G57142	
540-144	G64014		560-812	G52495		901-064	143058		903-044RS	G57111	
540-404	G51718		88875108	G56887		901-064	143059		903-045RS	G57110	
540-5001	75676		88945297	G63347		901-071	143094		903-048RS	G57067	
540-5008	77403		88945297	G63423		901-073	143425		903-049RS	G57068	
540-5010	77375		88945315	G63403		901-074	143323		92195485	G51916	
540-5018	77412		88945315	G63413		901-075	143316		92244058	G52281	
540-5018	77783		88945329	G63426		901-076	143061		92244059	G52280	
540-5023	77422		88945361	G63492		901-078	143063				
540-5024	77423		88945403	G63625		901-079	143064				
540-5027	77454		88945411	G63662		901-085	143461				

ACDelco Long Number

AcDelco long number	Gabriel	Upgrade	AcDelco long number	Gabriel	Upgrade	AcDelco long number	Gabriel	Upgrade	AcDelco long number	Gabriel	Upgrade
13329507	G51982		19294310	G56929		19307626	G51850		88875108	G56887	
13330740	G52435		19294314	G57051		19324428	G57048		88945297	G63347	
13330741	G52436		19294318	G57013		19324429	G57047		88945297	G63423	
13345954	G51971		19294319	G57014		19325297	G52278		88945302	G63357	
15058617	G64014		19294320	G56948		19325298	G52279		88945315	G63403	
18041239	G63676		19294321	G56948		19359120	G51975		88945315	G63413	
19165214	G63869		19294322	G56950		19359121	G52395		88945327	G63424	
19172143	G51728		19294323	G56949		19359122	G52396		88945328	G63425	
19177778	G51718		19294325	G56951		19359125	G52494		88945329	G63426	
19203623	G51746		19294330	G57048		19359126	G52495		88945361	G63492	
19203639	G56773		19294331	G57047		19359128	G52435		88945369	G63403	
19203640	G56774		19294350	G52013		19359129	G52436		88945370	G63411	
19235162	G51736		19294351	G52014		22737716	G52395				
19241342	G56809		19294353	G52026		22737717	G52396				
19294056	G56726		19294354	G52027		22737724	G51975				
19294309	G57022		19295570	G51759		88875107	G56886				

Important Note: Competitive Interchanges are to be used for stocking purposes only. Where multiple crosses are identified, please reference the applications section of this catalog. / **Remarque importante:** Les interchanges concurrentiels ne s'utilisent qu'aux fins de stocks. Dans le cas de références multiples, consulter la section des applications du catalogue. / **Nota importante:** Dans le cas de referencias multiples, consultar la sección de aplicaciones del catálogo. / **Nota importante:** Se pueden usar intercambios competitivos para propósitos de almacenamiento solamente. Cuando se identifican intercambios múltiples, consulte la sección de aplicaciones de este catálogo.

COMPETITIVE & O.E.M. INTERCHANGE LIST

Lista de Intercambios contra Competidores y Equipo Original.

Liste d'interchange de produits compétitifs & d'équipement original (OEM)

ACDelco Long Number... cont'd

ACdelco long number	Gabriel	Upgrade	ACdelco long number	Gabriel	Upgrade	ACdelco long number	Gabriel	Upgrade	ACdelco long number	Gabriel	Upgrade
88945403	G63625		88945453	G63928		88945758	G55820		88973942	G52013	
88945411	G63662		88945468	G63799		88945760	G55825		88974638	G51736	
88945415	G63675		88945597	G55526		88945765	G55856		88985528	G63829	
88945417	G63678		88945621	G55591		88945818	G55999		88991409	G63882	
88945419	G63683		88945640	G56518		88945833	G56718		92195485	G51916	
88945435	G63721		88945652	G55661		88961957	G56518		92244058	G52281	
88945436	G63722		88945653	G55662		88961962	G63844		92244059	G52280	
88945442	G63902		88945675	G55697		88961964	G63847				
88945447	G63907		88945676	G55698		88963960	G55892				
88945449	G63909		88945728	G55772		88973940	G52014				

ACDelco Short Number

ACdelco short number	Gabriel	Upgrade	ACdelco short number	Gabriel	Upgrade	ACdelco short number	Gabriel	Upgrade	ACdelco short number	Gabriel	Upgrade
503-117	G55526		503-702	G52280		530-160	G63425		530-443	G63897	
503-141	G55591		503-703	G52281		530-161	G63426		530-448	G63959	
503-160	G56518		503-705	G51949		530-175	G63375		530-449	G63894	
503-172	G55661		503-706	G51935		530-176	G63454		530-450	G63895	
503-173	G55662		503-708	G52395		530-189	G63488		530-455	G64014	
503-195	G55697		503-709	G52396		530-189	G63609		530-466	G64015	
503-196	G55698		503-710	G52494		530-190	G63489		530-469	G64040	
503-248	G55772		503-711	G52495		530-193	G63492		530-476	G64101	
503-278	G55820		503-712	G52435		530-201	G63403		530-480	G51971	
503-280	G55825		503-713	G52436		530-202	G63411		530-480	G51975	
503-285	G55856		505-520	G55825		530-203	G63394		530-481	G64140	
503-322	G55948		506-253	G55698		530-211	G63511		530-483	G51982	
503-323	G55949		506-310	G52014		530-223	G63609		540-144	G64014	
503-338	G55999		506-657	G52246		530-235	G63625		540-404	G51718	
503-340	G56700		506-658	G52245		530-238	G63638		540-514	G51904	
503-341	G56701		506-687	G52013		530-243	G63662		560-200	G51871	
503-353	G56718		506-749	G52281		530-247	G63675		560-201	G51871	
503-388	G56518		506-753	G52280		530-251	G63683		560-596	G51736	
503-389	G55892		506-801	G56886		530-253	G63690		560-681	G51971	
503-589	G56509		506-803	G56887		530-267	G63721		560-691	G51975	
503-599	G51746		506-806	G52395		530-268	G63722		560-809	G52494	
503-615	G56773		506-807	G52396		530-274	G63902		560-810	G52495	
503-616	G56774		506-854	G52435		530-279	G63907		560-811	G52494	
503-637	G56809		506-855	G52436		530-281	G63909		560-812	G52495	
503-638	G56810		508-42	G63353		530-295	G63776		903-003RS	G56726	
503-662	G56886		508-464	G63676		530-298	G63783		903-004RS	G56927	
503-663	G56887		508-5	G63359		530-300	G63799		903-005RS	G56927	
503-664	G52013		508-5	G63360		530-301	G63803		903-005RS	G56928	
503-665	G52014		508-79	G63424		530-311	G63817		903-012RS	G57060	
503-666	G52025		508-80	G63425		530-312	G63818		903-014RS	G56938	
503-667	G52026		508-82	G63410		530-324	G63829		903-015RS	G57022	
503-668	G52027		530-129	G63347		530-335	G63842		903-016RS	G56929	
503-677	G51759		530-129	G63423		530-336	G63844		903-020RS	G57051	
503-681	G52125		530-130	G63349		530-338	G63847		903-024RS	G57013	
503-682	G52116		530-130	G63422		530-387	G63866		903-025RS	G57014	
503-683	G52127		530-133	G63355		530-393	G63868		903-026RS	G56948	
503-684	G52128		530-133	G63421		530-394	G63869		903-027RS	G56948	
503-685	G51904		530-134	G63357		530-395	G63884		903-028RS	G56950	
503-686	G51871		530-147	G63403		530-402	G63882		903-029RS	G56949	
503-687	G51850		530-147	G63413		530-403	G63879		903-031RS	G56951	
503-688	G51891		530-151	G63366		530-407	G51718		903-032RS	G56924	
503-689	G51870		530-156	G63421		530-423	G63872				
503-699	G52244		530-157	G63422		530-439	G51736				
503-700	G52278		530-158	G63423		530-441	G63893				
503-701	G52279		530-159	G63424		530-442	G63896				

Important Note: Competitive Interchanges are to be used for stocking purposes only. Where multiple crosses are identified, please reference the applications section of this catalog. / **Remarque importante:** Les interchanges concurrentiels ne s'utilisent qu'aux fins de stocks. Dans le cas de références multiples, consulter la section des applications du catalogue. / **Nota importante:** Dans le cas de referencias multiples, consultar la sección de aplicaciones del catálogo. / **Nota importante:** Se pueden usar intercambios competitivos para propósitos de almacenamiento solamente. Cuando se identifican intercambios múltiples, consulte la sección de aplicaciones de este catálogo.

COMPETITIVE & O.E.M. INTERCHANGE LIST
Lista de Intercambios contra Competidores y Equipo Original.
Liste d'interchange de produits complitifs & d'equpement original (OEM)

ACDelco Short Number... cont'd

AcDelco short number	Gabriel	Upgrade	AcDelco short number	Gabriel	Upgrade	AcDelco short number	Gabriel	Upgrade	AcDelco short number	Gabriel	Upgrade
903-033RS	G56925		903-039RS	G57047		903-042RS	G57069		903-045RS	G57110	
903-035RS	G57000		903-040RS	G57125		903-042RS	G57121		903-048RS	G57067	
903-035RS	G57023		903-041RS	G57070		903-043RS	G57142		903-049RS	G57068	
903-038RS	G57048		903-041RS	G57122		903-044RS	G57111				

Advance AutoParts

Advance autoparts	Gabriel	Upgrade	Advance autoparts	Gabriel	Upgrade	Advance autoparts	Gabriel	Upgrade	Advance autoparts	Gabriel	Upgrade
139104	G57125		172390	G57370		172963	G57676		181398	G57019	
142426	G57628		172391	G57369		172974	G57606		181400	G57269	
171109	G57458		172394L	G57568		172975	G57605		181401	G57268	
171110	G57457		172394R	G57569		172989	G57544		181404	G57089	
171111	G57053		172398L	G57415		172990	G57543		181404	G57140	
171126	G57447		172398R	G57414		181100	G57146		181405	G57088	
171137L	G57454		172400L	G57428		181101L	G57424		181405	G57139	
171137R	G57453		172400R	G57429		181101R	G57425		181406	G57168	
171312	G57036		172425	G57478		181103	G57413		181407	G57167	
171352L	G57010		172425	G57629		181119L	G57220		181410	G57635	
171352R	G57010		172426	G57477		181119R	G57221		181411	G57634	
171441	G57145		172433	G57561		181124	G57095		181417	G57059	
171442	G57144		172434	G57560		181125	G57096		181426	G57031	
171447	G57366		172448	G57126		181138	G57172		181427	G57030	
171447	G57515		172449	G57127		181266	G56995		181433	G57050	
171448	G57365		172450	G57128		181281	G56938		181433	G57522	
171448	G57516		172451	G57129		181291L	G56996		181434	G57049	
171565L	G57431		172491	G57574		181291R	G56997		181434	G57521	
171565R	G57432		172492	G57575		181292	G56998		181437	G57098	
171575	G57397		172493	G57362		181293	G57057		181438	G57097	
171578	G56973		172494	G57361		181293	G57058		181453	G57106	
171579	G56974		172498	G57346		181299	G56943		181454	G57105	
171580	G56975		172499	G57345		181321	G57017		181461	G57158	
171588	G57510		172501	G57423		181322	G57018		181462	G57157	
171589	G57509		172532	G57497		181327	G57159		181490	G57042	
171933	G57006		172533	G57498		181327	G57160		181491	G57041	
171933	G57392		172568	G57456		181340L	G57032		181492	G57044	
172103	G57613		172569	G57455		181340L	G57061		181493	G57043	
172104	G57612		172604	G57494		181340R	G57033		181494	G57615	
172170	G57490		172605	G57493		181340R	G57062		181495	G57614	
172171	G57489		172608	G57474		181341	G57022		181504	G57064	
172191	G57219		172609	G57473		181346	G57080		181505	G57063	
172191	G57399		172663	G57378		181348L	G57027		181525	G57039	
172192	G57218		172664	G57377		181348R	G57027		181572L	G56956	
172192	G57398		172678	G57645		181353	G57282		181572R	G56957	
172194	G57343		172679	G57644		181358	G57092		181577L	G57007	
172194	G57400		172684	G57673		181358	G57118		181577R	G57008	
172195	G57270		172685	G57674		181361	G57020		181584	G57279	
172213	G57153		172765	G57563		181362	G57021		181585	G57278	
172214	G57152		172766	G57562		181369	G57015		181593	G57046	
172242	G57342		172888	G57583		181369	G57212		181594	G57045	
172243	G57341		172889	G57582		181370	G57016		181597	G57012	
172246	G57609		172901	G57546		181371L	G57133		181598	G57011	
172247	G57608		172902	G57545		181371R	G57134		181615	G56934	
172272	G57184		172905	G57368		181372	G57056		181615	G56937	
172332	G57578		172906	G57367		181373L	G57067		181616	G56936	
172333	G57577		172917	G57488		181373R	G57068		181661	G57060	
172343	G57334		172918	G57487		181377L	G57083				
172344	G57333		172957L	G57597		181377R	G57083				
172345	G57460		172957R	G57598		181380L	G57086				
172346	G57459		172962	G57677		181380R	G57087				

Important Note: Competitive Interchanges are to be used for stocking purposes only. Where multiple crosses are identified, please reference the applications section of this catalog. / **Remarque importante:** Les interchanges concurrentiels ne s'utilisent qu'aux fins de stocks. Dans le cas de rferences multiples, consulter la section des applications du catalogue. / **Nota importante:** Dans le cas de rferences multiples, consulter la section des applications du catalogue. / **Nota importante:** Se pueden usar intercambios competitivos para propósitos de almacenamiento solamente. Cuando se identifican intercambios múltiples, consulte la sección de aplicaciones de este catálogo.

COMPETITIVE & O.E.M. INTERCHANGE LIST
Lista de Intercambios contra Competidores y Equipo Original.
Liste d'interchange de produits comptitifs & d'equipement original (OEM)

Advance AutoParts... cont'd

Advance autoparts	Gabriel	Upgrade	Advance autoparts	Gabriel	Upgrade	Advance autoparts	Gabriel	Upgrade	Advance autoparts	Gabriel	Upgrade
181667	G56963		182267	G57164		272213	G57587		37022	G63495	
181668	G56962		182268	G57163		272214	G57586		37022	G63909	
181669	G56964		182271	G57185		272257	G57082		37026	G63721	
181672	G56927		182281	G57149		272258	G57081		37029	G63419	
181674	G57558		182286	G57391		272288	G57354		37029	G63928	
181675	G57559		182287	G57390		272289	G57353		37030	81870	
181678	G56931		182292	G57147		272299	G57472		37031	G63404	
181679	G56930		182295	G57131		272300	G57471		37033	G63548	
181680	G56933		182296	G57130		272367	G57463		37044	G63488	
181681	G56932		182297	G57276		272368	G57464		37047	G63813	
181685	G57051		182298	G57275		272382	G57643		37047	G63902	
181686	G56928		182305	G57394		272383	G57642		37050	G63489	
181691L	G56991		182306	G57393		272401	G57607		37065	G63426	
181691R	G56992		182309	G57193		272408	G57071		37070	G63799	
181920	G56935		182310	G57192		272408	G57072		37073	G63173	
181924	G57013		182311	G57156		272532	G57497		37073	G63492	
181925	G57014		182311	G57277		272533	G57498		37082	G63683	
181945	G56994		182321	G57324		272534	G57495		37091	G63413	
181946	G56993		182357	G57405		272535	G57496		37094	G63353	
181953	G56950		182358	G57404		272568	G57595		37095	G63410	
181954	G56949		182363	G57664		272569	G57594		37095	G63414	
182105	G57035		182363	G57666		272596	G57427		37096	G63359	
182106	G57034		182364	G57663		272597	G57567		37097	G63950	
182113	G57274		182364	G57665		272598	G57566		37102	G63661	
182114	G57115		182365	G57376		272957L	G57601		37104	G63673	
182115	G57114		182366	G57375		272957R	G57602		37109	G63708	
182123L	G57054		182367	G57177		272974	G57120		37112	G63689	
182123R	G57055		182368	G57176		272975	G57119		371130	G57466	
182130L	G57112		182378	G57201		281100	G57409		371131	G57465	
182130R	G57113		182379	G57200		281952	G56948		371139	G57173	
182138	G57271		182392	G57161		282261	G57148		37117	G63623	
182143	G57085		182393	G57162		282275	G57205		37121	G63490	
182144	G57084		182401	G57178		282276	G57204		37123	G63690	
182174	G56951		182471L	G56924		282307	G57191		37130	G63609	
182177	G57141		182471R	G56925		282308	G57190		37130	G63818	
182179L	G57047		182497L	G57416		282308	G57539		37134	G63715	
182179R	G57048		182497R	G57682		282491	G57332		37135	G63722	
182199	G57070		182509	G57267		282491	G57480		37137	G63915	
182199	G57122		182510	G57266		282491	G57600		37146	G55821	
182200	G57069		182518	G57109		282492	G57479		37149	G63783	
182200	G57121		182518	G57314		282492	G57599		37151	G63803	
182203	G57099		182526	G57198		2882492	G57331		37152	G63675	
182203	G57100		182527	G57197		32545	82032		37156	G63869	
182205	G57077		182536	G57138		343143	82005		37160	G63710	
182206	G57076		182537	G57137		343144	82001		37161	G63847	
182207	G57079		189105	G57000		34504	81925		37162	G63829	
182208	G57078		189105	G57023		34732	81821		37183	G63832	
182209	G57111		271102	G57646		34761	81828		37184	G63828	
182209	G57536		271137L	G57454		34762	G63896		37187	82035	
182210	G57110		271137R	G57453		34787	G63615		37197	G63506	
182210	G57535		271311	G57026		34788	G63616		37198	G63694	
182217	G57312		271354	G57430		34791	G63692		37199	69813	
182218	G57311		271453	G57350		34828	G63510		37203	G63844	
182231	G57142		271454	G57349		34912	G63625		37204	G63845	
182236	G57372		271498	G57651		34919	G63411		37206	G63958	
182237	G57373		271499	G57650		37016	G63635		37206	G64009	

Important Note: Competitive Interchanges are to be used for stocking purposes only. Where multiple crosses are identified, please reference the applications section of this catalog. / **Remarque importante:** Les interchanges concurrentiels ne s'utilisent qu'aux fins de stocks. Dans le cas de références multiples, consulter la section des applications du catalogue. / **Nota importante:** Dans le cas de références multiples, consulter la section des applications du catalogue. / **Nota importante:** Se pueden usar intercambios competitivos para propósitos de almacenamiento solamente. Cuando se identifican intercambios múltiples, consulte la sección de aplicaciones de este catálogo.

COMPETITIVE & O.E.M. INTERCHANGE LIST
Lista de Intercambios contra Competidores y Equipo Original.
Liste d'interchange de produits compititifs & d'equipement original (OEM)

Advance AutoParts... cont'd

Advance autoparts	Gabriel	Upgrade	Advance autoparts	Gabriel	Upgrade	Advance autoparts	Gabriel	Upgrade	Advance autoparts	Gabriel	Upgrade
37217	69900		55609	G51807		5621	70036		59015	81549	
37219	G64049		55637	G51874		5622	70037		59016	81478	
37220	G63905		55801	82099		5626	70041		59017	81676	
37225	G64027		55801	82110		5639	70027		59017	82007	
37226	G64028		55802	81492		5751	82026		59024	81560	
37231	G63720		55803	81495		5754	82138		59025	81507	
37237	69907		55804	81494		5756	82070		59025	81553	
37241	G63842		55809	82126		5757	82060		59026	81691	
37242	61717		55815	82601		5759	82087		59027	81583	
37244	G63864		55818	81340		5760	82609		59028	81668	
37251	G63878		55818	81440		5762	82615		59029	81667	
37252	G63883		55818	82039		5765	82118		59031	81490	
37253	G63875		55818	82155		5766	82051		59032	81710	
372565	G57340		55820	81514		5777	69585		59034	81082	
372566	G57339		55820	82602		5778	69589		59036	81744	
37269	G64105		55831	81095		5778	69590		59037	81730	
37270	G63885		55864	69632		5779	69587		59037	81917	
37270	G64029		55867	81481		5783	69592		59038	81540	
37270	G64030		55960	81446		5783	69593		59038	81905	
37272	70000		55965	69845		5784	69591		59038	81918	
37273	G64031		55968	81794		5796	69464		59041	81039	
37274	G64033		55971	81927		5796	69465		59042	81113	
37275	69595		55984	81934		5799	70001		59044	81164	
37276	69594		55985	81935		5801	69625		59045	81496	
37279	G63889		55S11170	G57557		5803	69606		59048	81914	
37280	G64006		55S11351	G57037		5804	69600		59049	81913	
37281	G64032		55S11352	G57038		5811	82011		59061	81920	
37288	70010		55S11373	G57363		5819	82004		59086	81541	
37289	G64026		55S11374	G57364		5819	82069		59086	81713	
37290	G64042		55S11493	G57337		5820	69724		59087	81582	
37298	G64038		55S11494	G57338		5826	82025		59090	81726	
37302	G64037		55S11663	G57222		5831	69624		5928	69757	
37308	G64052		55S11664	G57223		5839	69795		59301	61529	
37313	G64056		55S11861	G57335		5845	69755		59302	61531	
37315	G64040		55S11862	G57336		5850	69622		59304	61506	
37318	G64047		55S11903	G57564		5850	81880		59305	61509	
37323	70078		55S11904	G57565		58567	82156		59305	61555	
37326	G51966		55S11973	G57517		58581	61544		59306	61500	
37907	G63511		55S11974	G57518		58599	61656		59307	61508	
39002	69996		55S15071	G57090		5864	81459		59307	61593	
39004	69677		55S15072	G57091		58653	G64079		59309	61561	
39006	69766		55S15320	G57444		5867	69676		59309	61591	
39020	69952		55S15360	G57422		5868	69787		59311	61561	
39027	70024		55S15360	G57437		5892	69714		59312	61627	
39040	70040		56000	81491		5892	69811		59313	61533	
39047	70033		56000	82075		5893	69715		59313	61573	
39051	G64046		56001	81076		59001	81318		59313	61629	
39102	69946		56001	82104		59002	81675		59316	61501	
39104	G51891		56002	82090		59003	81147		59317	G63620	
39107	70034		56003	82128		59004	81825		59318	61552	
471128L	G57206		5601	70028		59006	81394		59320	81871	
471128R	G57206		5607	70003		59007	81242		59321	61662	
472526	G57550		5614	70013		59011	81484		59322	61615	
472527	G57549		5615	70049		59012	81482		59322	81548	
482401	G57607		5616	70045		59013	81516		59323	61536	
550018	69574		5618	70039		59014	81936		59324	81937	

Important Note: Competitive Interchanges are to be used for stocking purposes only. Where multiple crosses are identified, please reference the applications section of this catalog. / **Remarque importante:** Les interchanges concurrentiels ne s'utilisent qu'aux fins de stocks. Dans le cas de rfrences multiples, consulter la section des applications du catalogue. / **Nota importante:** Dans le cas de rfrences multiples, consulter la section des applications du catalogue. / **Nota importante:** Se pueden usar intercambios competitivos para propósitos de almacenamiento solamente. Cuando se identifican intercambios múltiples, consulte la sección de aplicaciones de este catálogo.

COMPETITIVE & O.E.M. INTERCHANGE LIST
Lista de Intercambios contra Competidores y Equipo Original.
Liste d'interchange de produits comptitifs & d'equipement original (OEM)

Advance AutoParts... cont'd

Advance autoparts	Gabriel	Upgrade	Advance autoparts	Gabriel	Upgrade	Advance autoparts	Gabriel	Upgrade	Advance autoparts	Gabriel	Upgrade
59329	61601		59512	61632		71111	G51758		81565	G51267	
59329	61679		59512	81091		71128	G52131		81572	G56620	
59329	81836		59517	61595		71138	G51860		81580	G55892	
59330	61584		59517	61646		71139	G51861		81593	G56568	
59330	81837		59519	61687		71141	G51864		81594	G56601	
59331	61535		59520	61565		71312	G51279		81616	G55901	
59332	61590		59523	61599		71321	G51722		81654	G55879	
59332	61624		59525	61634		71322	G51724		81655	G55879	
59332	81823		59528	61635		71327	G51727		81661	G55948	
59332	81890		59542	61525		71332	69586		81662	G55949	
59333	61560		59544	61524		71350	69998		81669	G55856	
59333	81904		59547	81096		71358	G51715		81678	G56514	
59338	61539		59548	81153		71361	G51704		81679	G56506	
59348	61556		59549	61517		71362	G51703		81680	G55676	
59353	61541		59554	61521		71441	G56688		81681	G55675	
59356	61575		59560	82034		71442	G56687		81728	G56700	
59358	61582		59561	61522		71590	G56518		81803	G55551	
59359	61605		59562	61518		71591	G56518		81822	G56718	
59359	81878		59567	61554		71665	G56929		81845	G55579	
59361	61608		59571	82003		71898	G51723		81857	G55591	
59362	G63782		59574	61516		72185	G56678		81858	G55591	
59363	G63781		59574	61519		72186	G56677		81891	81891	
59364	61625		59574	82147		72211	G56731		81897	G55820	
59367	61510		59577	61547		72212	G56730		81951	G55999	
59368	61700		59578	81510		72257	G56837		81952	G55999	
59369	61699		59582	61542		72258	G56836		81953	G55662	
59371	81893		59583	61543		72311	G56899		81954	G55661	
59372	61504		59586	61614		72593	G55526		81962	G55681	
59372	81750		59588	61530		81100	G51815		81964	G55697	
59374	61616		59589	61641		81256	G55804		81973	G55698	
59374	81929		59591	61643		81281	G55825		82114	G56661	
59375	61512		59592	61642		81291	G55909		82115	G56660	
59375	81559		59592	81873		81293	G51087		82143	G56799	
59378	61658		59592	81921		81297	G51252		82144	G56800	
59378	81923		59596	61680		81340	G51700		82179	G56810	
59379	61626		59597	61654		81341	G51718		82203	G56809	
59379	81916		59598	61655		81348	G51477		82205	G56722	
59381	81924		5960	69675		81352	G51077		82206	G56721	
59383	61609		59614	61663		81371	G51739		82207	G56729	
59383	81910		59624	61712		81373	G51736		82208	G56728	
59385	81911		59624	81933		81377	G56807		82209	G56774	
59386	61664		59625	61691		81404	G56540		82210	G56773	
59386	81869		59625	61692		81405	G56539		82217	G52027	
59387	61676		59626	81932		81406	G56641		82218	G52026	
59387	81926		5968	69898		81407	G56640		82236	G56797	
59398	61720		5971	69962		81426	G56672		82237	G56798	
59400	61715		5975	69901		81427	G56671		82261	G51859	
59401	69909		5980	69903		81433	G56622		82263	G52006	
59402	61592		5984	69945		81434	G56621		82264	G52005	
5947	69725		5987	69450		81437	G55994		82267	G52009	
59501	81912		5988	69863		81438	G55993		82268	G52008	
59502	81892		5989	69473		81453	G56582		82275	G52007	
59503	61613		5991	70020		81454	G56581		82276	G52004	
59504	61612		5993	69575		81504	G56517		82295	G56887	
59505	61520		5996	69420		81505	G56516		82296	G56886	
59505	61546		66415	G63918		81525	G56606		82307	G56889	

Important Note: Competitive Interchanges are to be used for stocking purposes only. Where multiple crosses are identified, please reference the applications section of this catalog. / **Remarque importante:** Les interchanges concurrentiels ne s'utilisent qu'aux fins de stocks. Dans le cas de références multiples, consulter la section des applications du catalogue. / **Nota importante:** Dans le cas de références multiples, consulter la section des applications du catalogue. / **Nota importante:** Se pueden usar intercambios competitivos para propósitos de almacenamiento solamente. Cuando se identifican intercambios múltiples, consulte la sección de aplicaciones de este catálogo.

COMPETITIVE & O.E.M. INTERCHANGE LIST

Lista de Intercambios contra Competidores y Equipo Original.

Liste d'interchange de produits compititifs & d'equpement original (OEM)

Advance AutoParts... cont'd

Advance autoparts	Gabriel	Upgrade	Advance autoparts	Gabriel	Upgrade	Advance autoparts	Gabriel	Upgrade	Advance autoparts	Gabriel	Upgrade
82308	G56888		911228	G63882		911299	G64044		L3000570107MNR	G51714	
82378	G52095		911229	G63884		911505	81922		L3000570112MNR	G51842	
82379	G52094		911259	G64016		911508	G64000		L3000654023ISG	G51737	
82392	G52121		911261	G63870		911527	G64001		L3000654090ISG	G55896	
82393	G52122		911262	G63867		L3000063955ISG	G51738		L3000654135ISG	G56758	
82518	G52125		911267	G63888		L30001338345ISG	G51765		L3000654139ISG	G56759	
872526	G57323		911277	G63890		L3000569882MNR	G51728		L3002569812MNR	G56965	
872527	G57322		911277	G63891		L3000569977MNR	G52082		L4000654339ISG	81416	
911039	G63456		911278	G64012		L3000569978MNR	G52081		L4000654464ISG	61704	
911228	G63879		911299	G64043		L3000570081MNR	G51713				

AL-KO

Al-ko	Gabriel	Upgrade	Al-ko	Gabriel	Upgrade	Al-ko	Gabriel	Upgrade	Al-ko	Gabriel	Upgrade
813000	G64079		813025	G64157		813033	G63847		813053	G63808	
813002	G64038		813026	G63817		813034	G63425		813054	G63607	
813007	G64001		813028	G51870		813035	G63403		813055	G63844	
813008	G51855		813028	G51891		813035	G63454		813057	G63882	
813009	G63886		813029	G51865		813036	G63818		813058	G64044	
813010	G63866		813030	G63347		813037	G63609		813059	G64043	
813011	G63783		813030	G63405		813038	G63489		813061	G51728	
813012	G63884		813030	G63413		813040	G63488		813065	G64011	
813013	G51864		813030	G63490		813045	G63715		813070	G63778	
813018	G63879		813030	G63907		813046	G64010		813093	G56807	
813021	G63888		813031	G63422		813048	G63829		813099	G63624	
813023	G63959		813031	G63638		813050	G63837		813100	G63897	
813024	G63803		813033	G63424		813051	G63809		813107	G63918	

Aralmex

Aralmex	Gabriel	Upgrade	Aralmex	Gabriel	Upgrade	Aralmex	Gabriel	Upgrade	Aralmex	Gabriel	Upgrade
2AMG037	G63375		3AMG007	G63357		3AMG026	G63455		3AMG033	G63614	
3AMG001	G63355		3AMG009	G63406		3AMG027	G63426		3AMG034	G63608	
3AMG004	G63306		3AMG021	G63409		3AMG029	G63488		3AMG035	G63607	
3AMG005	G63359		3AMG022	G63454		3AMG030	G63818				
3AMG006	G63377		3AMG023	G63421		3AMG031	G63360				

AutoAnything

Autoanything	Gabriel	Upgrade	Autoanything	Gabriel	Upgrade	Autoanything	Gabriel	Upgrade	Autoanything	Gabriel	Upgrade
AA142091	142091		AA143318	143318		AA61554	61554		AA61680	61680	
AA142195	142195		AA143319	143319		AA61565	61565		AA61682	61682	
AA142244	142244		AA143321	143321		AA61591	61591		AA61687	61687	
AA142316	142316		AA143324	143324		AA61595	61595		AA61691	61691	
AA142317	142317		AA143365	143365		AA61599	61599		AA61712	61712	
AA142546	142546		AA61500	61500		AA61600	61600		AA61714	61714	
AA142547	142547		AA61506	61506		AA61611	61611		AA61715	61715	
AA142556	142556		AA61509	61509		AA61612	61612		AA61716	61716	
AA142561	142561		AA61516	61516		AA61613	61613		AA61720	61720	
AA142569	142569		AA61517	61517		AA61614	61614		AA69420	69420	
AA142653	142653		AA61518	61518		AA61624	61624		AA69450	69450	
AA142735	142735		AA61519	61519		AA61634	61634		AA69464	69464	
AA142747	142747		AA61520	61520		AA61635	61635		AA69465	69465	
AA142755	142755		AA61521	61521		AA61638	61638		AA69473	69473	
AA142828	142828		AA61522	61522		AA61641	61641		AA69574	69574	
AA142836	142836		AA61523	61523		AA61642	61642		AA69575	69575	
AA142855	142855		AA61524	61524		AA61643	61643		AA69585	69585	
AA143059	143059		AA61525	61525		AA61646	61646		AA69586	69586	
AA143201	143201		AA61530	61530		AA61654	61654		AA69587	69587	
AA143204	143204		AA61542	61542		AA61655	61655				
AA143209	143209		AA61543	61543		AA61656	61656				
AA143263	143263		AA61546	61546		AA61663	61663				
AA143317	143317		AA61547	61547		AA61675	61675				

Important Note: Competitive Interchanges are to be used for stocking purposes only. Where multiple crosses are identified, please reference the applications section of this catalog. / **Remarque importante:** Les interchanges concurrentiels ne s'utilisent qu'aux fins de stocks. Dans le cas de rferences multiples, consulter la section des applications du catalogue. / **Nota importante:** Dans le cas de rferences multiples, consulter la section des applications du catalogue. / **Nota importante:** Se pueden usar intercambios competitivos para propósitos de almacenamiento solamente. Cuando se identifican intercambios mltiples, consulte la seccin de aplicaciones de este catlogo.

COMPETITIVE & O.E.M. INTERCHANGE LIST
Lista de Intercambios contra Competidores y Equipo Original.
Liste dinterchange de produits comptitifs & dquipement original (OEM)

AutoAnything... cont'd

Autoanything	Gabriel	Upgrade	Autoanything	Gabriel	Upgrade	Autoanything	Gabriel	Upgrade	Autoanything	Gabriel	Upgrade
AA69589	69589		AA70039	70039		AA82025	82025		AAG51742	G51742	
AA69590	69590		AA70040	70040		AA82065	82065		AAG51746	G51746	
AA69591	69591		AA70041	70041		AA82066	82066		AAG51758	G51758	
AA69592	69592		AA70045	70045		AA82072	82072		AAG51759	G51759	
AA69593	69593		AA70049	70049		AA82075	82075		AAG51760	G51760	
AA69594	69594		AA70052	70052		AA82076	82076		AAG51761	G51761	
AA69595	69595		AA70053	70053		AA82079	82079		AAG51765	G51765	
AA69600	69600		AA70055	70055		AA82086	82086		AAG51766	G51766	
AA69604	69604		AA70056	70056		AA82099	82099		AAG51767	G51767	
AA69606	69606		AA70059	70059		AA82103	82103		AAG51772	G51772	
AA69622	69622		AA70060	70060		AA82104	82104		AAG51773	G51773	
AA69624	69624		AA70064	70064		AA82109	82109		AAG51774	G51774	
AA69625	69625		AA70065	70065		AA82110	82110		AAG51783	G51783	
AA69632	69632		AA70068	70068		AA82131	82131		AAG51794	G51794	
AA69675	69675		AA70078	70078		AA82147	82147		AAG51795	G51795	
AA69676	69676		AA70086	70086		AA82151	82151		AAG51798	G51798	
AA69677	69677		AA70089	70089		AA82155	82155		AAG51799	G51799	
AA69714	69714		AA70095	70095		AA82618	82618		AAG51802	G51802	
AA69715	69715		AA70096	70096		AAG44461	G44461		AAG51803	G51803	
AA69724	69724		AA77412	77412		AAG44986	G44986		AAG51804	G51804	
AA69755	69755		AA77422	77422		AAG51063	G51063		AAG51805	G51805	
AA69757	69757		AA77423	77423		AAG51077	G51077		AAG51806	G51806	
AA69766	69766		AA77488	77488		AAG51087	G51087		AAG51807	G51807	
AA69795	69795		AA77489	77489		AAG51097	G51097		AAG51810	G51810	
AA69811	69811		AA77524	77524		AAG511004	G511004		AAG51811	G51811	
AA69813	69813		AA77609	77609		AAG511054	G511054		AAG51812	G51812	
AA69845	69845		AA77638	77638		AAG511055	G511055		AAG51813	G51813	
AA69863	69863		AA77662	77662		AAG51252	G51252		AAG51814	G51814	
AA69898	69898		AA77678	77678		AAG51254	G51254		AAG51815	G51815	
AA69900	69900		AA77683	77683		AAG51255	G51255		AAG51825	G51825	
AA69901	69901		AA77715	77715		AAG51256	G51256		AAG51832	G51832	
AA69903	69903		AA77716	77716		AAG51267	G51267		AAG51833	G51833	
AA69907	69907		AA77783	77783		AAG51268	G51268		AAG51836	G51836	
AA69909	69909		AA77803	77803		AAG51279	G51279		AAG51838	G51838	
AA69945	69945		AA77817	77817		AAG51286	G51286		AAG51841	G51841	
AA69946	69946		AA77829	77829		AAG51477	G51477		AAG51842	G51842	
AA69952	69952		AA77847	77847		AAG51700	G51700		AAG51847	G51847	
AA69962	69962		AA77909	77909		AAG51703	G51703		AAG51848	G51848	
AA69966	69966		AA77948	77948		AAG51704	G51704		AAG51849	G51849	
AA69996	69996		AA77950	77950		AAG51713	G51713		AAG51850	G51850	
AA69998	69998		AA77953	77953		AAG51714	G51714		AAG51852	G51852	
AA70000	70000		AA77971	77971		AAG51715	G51715		AAG51853	G51853	
AA70001	70001		AA77973	77973		AAG51716	G51716		AAG51854	G51854	
AA70003	70003		AA81440	81440		AAG51718	G51718		AAG51855	G51855	
AA70010	70010		AA81541	81541		AAG51719	G51719		AAG51856	G51856	
AA70013	70013		AA81582	81582		AAG51721	G51721		AAG51858	G51858	
AA70020	70020		AA81730	81730		AAG51722	G51722		AAG51859	G51859	
AA70024	70024		AA81825	81825		AAG51723	G51723		AAG51860	G51860	
AA70027	70027		AA81917	81917		AAG51724	G51724		AAG51861	G51861	
AA70028	70028		AA81918	81918		AAG51727	G51727		AAG51863	G51863	
AA70031	70031		AA81928	81928		AAG51728	G51728		AAG51864	G51864	
AA70033	70033		AA81931	81931		AAG51729	G51729		AAG51865	G51865	
AA70034	70034		AA82004	82004		AAG51736	G51736		AAG51870	G51870	
AA70036	70036		AA82007	82007		AAG51737	G51737		AAG51871	G51871	
AA70037	70037		AA82011	82011		AAG51738	G51738		AAG51874	G51874	
AA70038	70038		AA82012	82012		AAG51739	G51739		AAG51877	G51877	

Important Note: Competitive Interchanges are to be used for stocking purposes only. Where multiple crosses are identified, please reference the applications section of this catalog. / **Remarque importante:** Les interchanges concurrentiels ne s'utilisent qu'aux fins de stocks. Dans le cas de références multiples, consulter la section des applications du catalogue. / **Nota importante:** Dans le cas de referencias multiples, consultar la sección de aplicaciones del catálogo. / **Nota importante:** Se pueden usar intercambios competitivos para propósitos de almacenamiento solamente. Cuando se identifican intercambios múltiples, consulte la sección de aplicaciones de este catálogo.

COMPETITIVE & O.E.M. INTERCHANGE LIST
Lista de Intercambios contra Competidores y Equipo Original.
Liste d'interchange de produits compititifs & equipement original (OEM)

AutoAnything... cont'd

Autoanything	Gabriel	Upgrade	Autoanything	Gabriel	Upgrade	Autoanything	Gabriel	Upgrade	Autoanything	Gabriel	Upgrade
AAG51878	G51878		AAG52025	G52025		AAG52163	G52163		AAG52293	G52293	
AAG51879	G51879		AAG52026	G52026		AAG52164	G52164		AAG52294	G52294	
AAG51880	G51880		AAG52027	G52027		AAG52165	G52165		AAG52295	G52295	
AAG51881	G51881		AAG52032	G52032		AAG52168	G52168		AAG52297	G52297	
AAG51883	G51883		AAG52033	G52033		AAG52169	G52169		AAG52298	G52298	
AAG51884	G51884		AAG52036	G52036		AAG52170	G52170		AAG52299	G52299	
AAG51887	G51887		AAG52037	G52037		AAG52171	G52171		AAG52300	G52300	
AAG51888	G51888		AAG52081	G52081		AAG52172	G52172		AAG52301	G52301	
AAG51891	G51891		AAG52082	G52082		AAG52173	G52173		AAG52314	G52314	
AAG51892	G51892		AAG52094	G52094		AAG52174	G52174		AAG52329	G52329	
AAG51896	G51896		AAG52095	G52095		AAG52175	G52175		AAG52330	G52330	
AAG51897	G51897		AAG52096	G52096		AAG52176	G52176		AAG52331	G52331	
AAG51898	G51898		AAG52097	G52097		AAG52182	G52182		AAG52332	G52332	
AAG51899	G51899		AAG52098	G52098		AAG52183	G52183		AAG52333	G52333	
AAG51900	G51900		AAG52103	G52103		AAG52184	G52184		AAG52334	G52334	
AAG51901	G51901		AAG52104	G52104		AAG52185	G52185		AAG52335	G52335	
AAG51904	G51904		AAG52105	G52105		AAG52187	G52187		AAG52336	G52336	
AAG51905	G51905		AAG52106	G52106		AAG52188	G52188		AAG52348	G52348	
AAG51908	G51908		AAG52107	G52107		AAG52199	G52199		AAG52349	G52349	
AAG51910	G51910		AAG52108	G52108		AAG52200	G52200		AAG52351	G52351	
AAG51911	G51911		AAG52110	G52110		AAG52201	G52201		AAG52352	G52352	
AAG51914	G51914		AAG52111	G52111		AAG52202	G52202		AAG52353	G52353	
AAG51916	G51916		AAG52112	G52112		AAG52203	G52203		AAG52354	G52354	
AAG51917	G51917		AAG52113	G52113		AAG52204	G52204		AAG52355	G52355	
AAG51918	G51918		AAG52116	G52116		AAG52209	G52209		AAG52356	G52356	
AAG51919	G51919		AAG52117	G52117		AAG52210	G52210		AAG52360	G52360	
AAG51920	G51920		AAG52118	G52118		AAG52237	G52237		AAG52361	G52361	
AAG51921	G51921		AAG52121	G52121		AAG52238	G52238		AAG52374	G52374	
AAG51922	G51922		AAG52122	G52122		AAG52244	G52244		AAG52375	G52375	
AAG51925	G51925		AAG52125	G52125		AAG52245	G52245		AAG52382	G52382	
AAG51926	G51926		AAG52127	G52127		AAG52246	G52246		AAG52383	G52383	
AAG51928	G51928		AAG52128	G52128		AAG52247	G52247		AAG52398	G52398	
AAG51930	G51930		AAG52129	G52129		AAG52248	G52248		AAG52399	G52399	
AAG51933	G51933		AAG52130	G52130		AAG52249	G52249		AAG52406	G52406	
AAG51934	G51934		AAG52131	G52131		AAG52250	G52250		AAG55526	G55526	
AAG51937	G51937		AAG52140	G52140		AAG52253	G52253		AAG55551	G55551	
AAG51947	G51947		AAG52141	G52141		AAG52254	G52254		AAG55579	G55579	
AAG51948	G51948		AAG52142	G52142		AAG52255	G52255		AAG55591	G55591	
AAG51949	G51949		AAG52143	G52143		AAG52256	G52256		AAG55661	G55661	
AAG51955	G51955		AAG52144	G52144		AAG52257	G52257		AAG55662	G55662	
AAG51961	G51961		AAG52145	G52145		AAG52258	G52258		AAG55675	G55675	
AAG51966	G51966		AAG52148	G52148		AAG52260	G52260		AAG55676	G55676	
AAG51971	G51971		AAG52149	G52149		AAG52261	G52261		AAG55681	G55681	
AAG51975	G51975		AAG52150	G52150		AAG52264	G52264		AAG55697	G55697	
AAG51993	G51993		AAG52151	G52151		AAG52265	G52265		AAG55698	G55698	
AAG52004	G52004		AAG52152	G52152		AAG52272	G52272		AAG55772	G55772	
AAG52005	G52005		AAG52153	G52153		AAG52273	G52273		AAG55774	G55774	
AAG52006	G52006		AAG52154	G52154		AAG52274	G52274		AAG55804	G55804	
AAG52007	G52007		AAG52155	G52155		AAG52275	G52275		AAG55821	G55821	
AAG52008	G52008		AAG52156	G52156		AAG52276	G52276		AAG55825	G55825	
AAG52009	G52009		AAG52157	G52157		AAG52278	G52278		AAG55856	G55856	
AAG52013	G52013		AAG52158	G52158		AAG52279	G52279		AAG55870	G55870	
AAG52014	G52014		AAG52159	G52159		AAG52280	G52280		AAG55879	G55879	
AAG52017	G52017		AAG52160	G52160		AAG52281	G52281		AAG55892	G55892	
AAG52018	G52018		AAG52161	G52161		AAG52282	G52282		AAG55896	G55896	
AAG52019	G52019		AAG52162	G52162		AAG52283	G52283		AAG55901	G55901	

Important Note: Competitive Interchanges are to be used for stocking purposes only. Where multiple crosses are identified, please reference the applications section of this catalog. / **Remarque importante:** Les interchanges concurrentiels ne s'utilisent qu'aux fins de stocks. Dans le cas de références multiples, consulter la section des applications du catalogue. / **Nota importante:** Dans le cas de referencias multiples, consultar la sección de aplicaciones del catálogo. / **Nota importante:** Se pueden usar intercambios competitivos para propósitos de almacenamiento solamente. Cuando se identifican intercambios múltiples, consulte la sección de aplicaciones de este catálogo.

COMPETITIVE & O.E.M. INTERCHANGE LIST
Lista de Intercambios contra Competidores y Equipo Original.
Liste dinterchange de produits comptitifs & dquipement original (OEM)

AutoAnything... cont'd

Autoanything	Gabriel	Upgrade	Autoanything	Gabriel	Upgrade	Autoanything	Gabriel	Upgrade	Autoanything	Gabriel	Upgrade
AAG55909	G55909		AAG56680	G56680		AAG56889	G56889		AAG57027	G57027	
AAG55910	G55910		AAG56683	G56683		AAG56892	G56892		AAG57030	G57030	
AAG55911	G55911		AAG56684	G56684		AAG56893	G56893		AAG57031	G57031	
AAG55948	G55948		AAG56685	G56685		AAG56894	G56894		AAG57032	G57032	
AAG55949	G55949		AAG56686	G56686		AAG56899	G56899		AAG57033	G57033	
AAG55991	G55991		AAG56687	G56687		AAG56924	G56924		AAG57034	G57034	
AAG55993	G55993		AAG56688	G56688		AAG56925	G56925		AAG57035	G57035	
AAG55994	G55994		AAG56700	G56700		AAG56927	G56927		AAG57036	G57036	
AAG55999	G55999		AAG56701	G56701		AAG56928	G56928		AAG57037	G57037	
AAG56506	G56506		AAG56718	G56718		AAG56929	G56929		AAG57038	G57038	
AAG56509	G56509		AAG56721	G56721		AAG56930	G56930		AAG57039	G57039	
AAG56512	G56512		AAG56722	G56722		AAG56931	G56931		AAG57040	G57040	
AAG56513	G56513		AAG56726	G56726		AAG56932	G56932		AAG57041	G57041	
AAG56514	G56514		AAG56728	G56728		AAG56933	G56933		AAG57042	G57042	
AAG56516	G56516		AAG56729	G56729		AAG56934	G56934		AAG57043	G57043	
AAG56517	G56517		AAG56730	G56730		AAG56935	G56935		AAG57044	G57044	
AAG56518	G56518		AAG56731	G56731		AAG56936	G56936		AAG57045	G57045	
AAG56529	G56529		AAG56732	G56732		AAG56937	G56937		AAG57046	G57046	
AAG56530	G56530		AAG56733	G56733		AAG56938	G56938		AAG57047	G57047	
AAG56537	G56537		AAG56734	G56734		AAG56943	G56943		AAG57048	G57048	
AAG56538	G56538		AAG56735	G56735		AAG56948	G56948		AAG57049	G57049	
AAG56539	G56539		AAG56750	G56750		AAG56949	G56949		AAG57050	G57050	
AAG56540	G56540		AAG56751	G56751		AAG56950	G56950		AAG57051	G57051	
AAG56561	G56561		AAG56758	G56758		AAG56951	G56951		AAG57053	G57053	
AAG56562	G56562		AAG56759	G56759		AAG56956	G56956		AAG57054	G57054	
AAG56565	G56565		AAG56773	G56773		AAG56957	G56957		AAG57055	G57055	
AAG56568	G56568		AAG56774	G56774		AAG56962	G56962		AAG57056	G57056	
AAG56571	G56571		AAG56778	G56778		AAG56963	G56963		AAG57057	G57057	
AAG56581	G56581		AAG56784	G56784		AAG56964	G56964		AAG57058	G57058	
AAG56582	G56582		AAG56785	G56785		AAG56965	G56965		AAG57059	G57059	
AAG56591	G56591		AAG56791	G56791		AAG56973	G56973		AAG57060	G57060	
AAG56598	G56598		AAG56792	G56792		AAG56974	G56974		AAG57061	G57061	
AAG56601	G56601		AAG56797	G56797		AAG56975	G56975		AAG57062	G57062	
AAG56606	G56606		AAG56798	G56798		AAG56993	G56993		AAG57063	G57063	
AAG56615	G56615		AAG56799	G56799		AAG56994	G56994		AAG57064	G57064	
AAG56616	G56616		AAG56800	G56800		AAG56995	G56995		AAG57065	G57065	
AAG56620	G56620		AAG56802	G56802		AAG56996	G56996		AAG57066	G57066	
AAG56621	G56621		AAG56807	G56807		AAG56997	G56997		AAG57067	G57067	
AAG56622	G56622		AAG56809	G56809		AAG56998	G56998		AAG57068	G57068	
AAG56633	G56633		AAG56810	G56810		AAG57000	G57000		AAG57069	G57069	
AAG56634	G56634		AAG56817	G56817		AAG57005	G57005		AAG57070	G57070	
AAG56635	G56635		AAG56819	G56819		AAG57006	G57006		AAG57071	G57071	
AAG56636	G56636		AAG56820	G56820		AAG57007	G57007		AAG57072	G57072	
AAG56637	G56637		AAG56821	G56821		AAG57008	G57008		AAG57075	G57075	
AAG56640	G56640		AAG56822	G56822		AAG57010	G57010		AAG57076	G57076	
AAG56641	G56641		AAG56836	G56836		AAG57011	G57011		AAG57077	G57077	
AAG56642	G56642		AAG56837	G56837		AAG57012	G57012		AAG57078	G57078	
AAG56643	G56643		AAG56838	G56838		AAG57014	G57014		AAG57079	G57079	
AAG56655	G56655		AAG56839	G56839		AAG57015	G57015		AAG57080	G57080	
AAG56660	G56660		AAG56840	G56840		AAG57016	G57016		AAG57081	G57081	
AAG56661	G56661		AAG56841	G56841		AAG57018	G57018		AAG57082	G57082	
AAG56671	G56671		AAG56842	G56842		AAG57019	G57019		AAG57083	G57083	
AAG56672	G56672		AAG56843	G56843		AAG57020	G57020		AAG57084	G57084	
AAG56677	G56677		AAG56886	G56886		AAG57022	G57022		AAG57085	G57085	
AAG56678	G56678		AAG56887	G56887		AAG57023	G57023		AAG57086	G57086	
AAG56679	G56679		AAG56888	G56888		AAG57026	G57026		AAG57087	G57087	

Important Note: Competitive Interchanges are to be used for stocking purposes only. Where multiple crosses are identified, please reference the applications section of this catalog. / **Remarque importante:** Les interchanges concurrentiels ne s'utilisent qu'aux fins de stocks. Dans le cas de références multiples, consulter la section des applications du catalogue. / **Nota importante:** Dans le cas de referencias multiples, consultar la sección de aplicaciones del catálogo. / **Nota importante:** Se pueden usar intercambios competitivos para propósitos de almacenamiento solamente. Cuando se identifican intercambios múltiples, consulte la sección de aplicaciones de este catálogo.

COMPETITIVE & O.E.M. INTERCHANGE LIST
Lista de Intercambios contra Competidores y Equipo Original.
Liste dinterchange de produits compititifs & dquipement original (OEM)

AutoAnything... cont'd

Autoanything	Gabriel	Upgrade	Autoanything	Gabriel	Upgrade	Autoanything	Gabriel	Upgrade	Autoanything	Gabriel	Upgrade
AAG57089	G57089		AAG57167	G57167		AAG63511	G63511		AAG63809	G63809	
AAG57090	G57090		AAG57168	G57168		AAG63524	G63524		AAG63810	G63810	
AAG57091	G57091		AAG57172	G57172		AAG63547	G63547		AAG63813	G63813	
AAG57092	G57092		AAG57173	G57173		AAG63548	G63548		AAG63815	G63815	
AAG57095	G57095		AAG57176	G57176		AAG63604	G63604		AAG63817	G63817	
AAG57096	G57096		AAG57177	G57177		AAG63605	G63605		AAG63818	G63818	
AAG57097	G57097		AAG57178	G57178		AAG63607	G63607		AAG63828	G63828	
AAG57098	G57098		AAG63173	G63173		AAG63608	G63608		AAG63829	G63829	
AAG57099	G57099		AAG63183	G63183		AAG63609	G63609		AAG63832	G63832	
AAG57100	G57100		AAG63299	G63299		AAG63610	G63610		AAG63837	G63837	
AAG57103	G57103		AAG63306	G63306		AAG63611	G63611		AAG63842	G63842	
AAG57105	G57105		AAG63347	G63347		AAG63614	G63614		AAG63844	G63844	
AAG57106	G57106		AAG63349	G63349		AAG63615	G63615		AAG63845	G63845	
AAG57107	G57107		AAG63350	G63350		AAG63616	G63616		AAG63847	G63847	
AAG57108	G57108		AAG63353	G63353		AAG63620	G63620		AAG63848	G63848	
AAG57109	G57109		AAG63355	G63355		AAG63622	G63622		AAG63860	G63860	
AAG57110	G57110		AAG63357	G63357		AAG63623	G63623		AAG63864	G63864	
AAG57111	G57111		AAG63359	G63359		AAG63624	G63624		AAG63866	G63866	
AAG57112	G57112		AAG63360	G63360		AAG63635	G63635		AAG63867	G63867	
AAG57113	G57113		AAG63366	G63366		AAG63638	G63638		AAG63868	G63868	
AAG57114	G57114		AAG63375	G63375		AAG63661	G63661		AAG63869	G63869	
AAG57115	G57115		AAG63377	G63377		AAG63662	G63662		AAG63870	G63870	
AAG57118	G57118		AAG63386	G63386		AAG63671	G63671		AAG63872	G63872	
AAG57119	G57119		AAG63387	G63387		AAG63673	G63673		AAG63873	G63873	
AAG57120	G57120		AAG63403	G63403		AAG63674	G63674		AAG63875	G63875	
AAG57121	G57121		AAG63404	G63404		AAG63675	G63675		AAG63878	G63878	
AAG57122	G57122		AAG63405	G63405		AAG63676	G63676		AAG63879	G63879	
AAG57123	G57123		AAG63406	G63406		AAG63678	G63678		AAG63882	G63882	
AAG57124	G57124		AAG63409	G63409		AAG63679	G63679		AAG63883	G63883	
AAG57125	G57125		AAG63410	G63410		AAG63683	G63683		AAG63884	G63884	
AAG57126	G57126		AAG63411	G63411		AAG63689	G63689		AAG63885	G63885	
AAG57127	G57127		AAG63413	G63413		AAG63690	G63690		AAG63886	G63886	
AAG57128	G57128		AAG63414	G63414		AAG63694	G63694		AAG63888	G63888	
AAG57129	G57129		AAG63418	G63418		AAG63707	G63707		AAG63889	G63889	
AAG57130	G57130		AAG63419	G63419		AAG63708	G63708		AAG63890	G63890	
AAG57131	G57131		AAG63421	G63421		AAG63710	G63710		AAG63891	G63891	
AAG57132	G57132		AAG63422	G63422		AAG63712	G63712		AAG63892	G63892	
AAG57133	G57133		AAG63423	G63423		AAG63714	G63714		AAG63893	G63893	
AAG57134	G57134		AAG63424	G63424		AAG63715	G63715		AAG63894	G63894	
AAG57135	G57135		AAG63425	G63425		AAG63716	G63716		AAG63895	G63895	
AAG57136	G57136		AAG63426	G63426		AAG63717	G63717		AAG63896	G63896	
AAG57137	G57137		AAG63432	G63432		AAG63720	G63720		AAG63897	G63897	
AAG57138	G57138		AAG63443	G63443		AAG63721	G63721		AAG63902	G63902	
AAG57139	G57139		AAG63454	G63454		AAG63722	G63722		AAG63903	G63903	
AAG57140	G57140		AAG63455	G63455		AAG63726	G63726		AAG63904	G63904	
AAG57141	G57141		AAG63456	G63456		AAG63772	G63772		AAG63905	G63905	
AAG57142	G57142		AAG63461	G63461		AAG63773	G63773		AAG63907	G63907	
AAG57144	G57144		AAG63479	G63479		AAG63775	G63775		AAG63909	G63909	
AAG57145	G57145		AAG63488	G63488		AAG63776	G63776		AAG63915	G63915	
AAG57147	G57147		AAG63489	G63489		AAG63778	G63778		AAG63918	G63918	
AAG57148	G57148		AAG63490	G63490		AAG63781	G63781		AAG63928	G63928	
AAG57156	G57156		AAG63492	G63492		AAG63782	G63782		AAG63929	G63929	
AAG57157	G57157		AAG63494	G63494		AAG63783	G63783		AAG63937	G63937	
AAG57158	G57158		AAG63495	G63495		AAG63799	G63799		AAG63950	G63950	
AAG57159	G57159		AAG63506	G63506		AAG63803	G63803		AAG63958	G63958	
AAG57160	G57160		AAG63510	G63510		AAG63808	G63808		AAG63959	G63959	

Important Note: Competitive Interchanges are to be used for stocking purposes only. Where multiple crosses are identified, please reference the applications section of this catalog./ **Remarque importante:** Les interchanges concurrentiels ne s'utilisent qu'aux fins de stocks. Dans le cas de rferences multiples, consulter la section des applications du catalogue./ **Nota importante:** Dans le cas de rferences multiples, consulter la section des applications du catalogue./ **Nota importante:** Se pueden usar intercambios competitivos para propósitos de almacenamiento solamente. Cuando se identifican intercambios múltiples, consulte la sección de aplicaciones de este catálogo.

COMPETITIVE & O.E.M. INTERCHANGE LIST
Lista de Intercambios contra Competidores y Equipo Original.
Liste dinterchange de produits comptitifs & dquipement original (OEM)

AutoAnything... cont'd

Autoanything	Gabriel	Upgrade	Autoanything	Gabriel	Upgrade	Autoanything	Gabriel	Upgrade	Autoanything	Gabriel	Upgrade
AAG63961	G63961		AAG64009	G64009		AAG64031	G64031		AAG64050	G64050	
AAG63962	G63962		AAG64010	G64010		AAG64032	G64032		AAG64052	G64052	
AAG63965	G63965		AAG64011	G64011		AAG64033	G64033		AAG64056	G64056	
AAG63966	G63966		AAG64012	G64012		AAG64037	G64037		AAG64071	G64071	
AAG63967	G63967		AAG64013	G64013		AAG64038	G64038		AAG64079	G64079	
AAG63969	G63969		AAG64014	G64014		AAG64040	G64040		AAG64080	G64080	
AAG63971	G63971		AAG64015	G64015		AAG64042	G64042		AAG64087	G64087	
AAG64000	G64000		AAG64016	G64016		AAG64043	G64043		AAG64101	G64101	
AAG64001	G64001		AAG64026	G64026		AAG64044	G64044		AAG64105	G64105	
AAG64002	G64002		AAG64027	G64027		AAG64046	G64046		AAG64111	G64111	
AAG64003	G64003		AAG64028	G64028		AAG64047	G64047		AAG64146	G64146	
AAG64006	G64006		AAG64029	G64029		AAG64048	G64048				
AAG64008	G64008		AAG64030	G64030		AAG64049	G64049				

AUTOMANN

Automann	Gabriel	Upgrade	Automann	Gabriel	Upgrade	Automann	Gabriel	Upgrade	Automann	Gabriel	Upgrade
A646155	646155		A83163	83163		A85061	85061	89502	A85931	85931	89458
A646177	646177		A83166	83166		A85062	85062	89408	A85934	85934	
A665937	665937		A83169	83169		A85063	85063		A85936	85936	89456
A83021	83021		A83175	83175		A85064	85064		A85937	85937	
A83023	83023		A83203	83203	89436	A85065	85065		A85938	85938	
A83024	83024		A83207	83207	89407	A85066	85066	89448	A85939	85939	
A83025	83025		A83209	83209	89414	A85067	85067	89451	A85954	85954	
A83026	83026		A83215	83215		A85069	85069	89455	A85956	85956	
A83028	83028		A83312	83312	89409	A85070	85070	89459	A85957	85957	
A83029	83029		A83317	83317		A85072	85072		A85958	85958	
A83030	83030		A83364	83364		A85081	85081		A85959	85959	
A83031	83031		A83391	83391		A85084	85084	89460	A85964	85964	
A83038	83038		A83395	83395		A85086	85086		A85967	85967	
A83039	83039		A83396	83396		A85088	85088		A85972	85972	
A83040	83040		A83456	83456	89447	A85109	85109		A85976	85976	
A83045	83045		A83905	83905		A85119	85119		A85977	85977	
A83048	83048		A83906	83906		A85188	85188		A85979	85979	
A83049	83049		A83907	83907		A85303	85303	89422	A85989	85989	
A83051	83051		A83908	83908		A85308	85308	89422	A85994	85994	
A83053	83053		A83911	83911		A85310	85310	89423	A85995	85995	
A83054	83054		A85000	85000	89436	A85311	85311	89424	A86200	86200	
A83066	83066		A85001	85001	89410	A85316	85316	89426	A89407	89407	
A83081	83081		A85003	85003	89411	A85319	85319	89428	A89408	89408	
A83101	83101		A85005	85005	89430	A85320	85320	89429	A89410	89410	
A83103	83103		A85006	85006		A85323	85323	89436	A89411	89411	
A83112	83112		A85012	85012	89413	A85338	85338		A89414	89414	
A83123	83123	89405	A85013	85013	89414	A85345	85345		A89423	89423	
A83125	83125		A85014	85014		A85639	85639		A89424	89424	
A83128	83128	89436	A85023	85023	89415	A85642	85642		A89426	89426	
A83130	83130		A85026	85026		A85724	85724	89443	A89427	89427	
A83131	83131		A85029	85029		A85738	85738		A89436	89436	
A83134	83134		A85030	85030	89440	A85739	85739		A89443	89443	
A83135	83135		A85033	85033	89427	A85900	85900		A89451	89451	
A83136	83136		A85036	85036	89405	A85909	85909		A89455	89455	
A83137	83137		A85045	85045		A85918	85918	89449	A89460	89460	
A83140	83140		A85046	85046	89434	A85920	85920	89503	A89503	89503	
A83142	83142		A85052	85052		A85923	85923	89458	A90131	83062	
A83143	83143		A85055	85055	89439	A85924	85924	89457	A99605	85109	
A83144	83144		A85058	85058	89431	A85927	85927		A99769	83081	
A83147	83147		A85060	85060		A85928	85928		AG63809	G63809	
A83150	83150		A85061	85061	89450	A85929	85929				

Important Note: Competitive Interchanges are to be used for stocking purposes only. Where multiple crosses are identified, please reference the applications section of this catalog. / **Remarque importante:** Les interchanges concurrentiels ne s'utilisent qu'aux fins de stocks. Dans le cas de rferences multiples, consulter la section des applications du catalogue. / **Nota importante:** Dans le cas de rferences multiples, consulter la section des applications du catalogue. / **Nota importante:** Se pueden usar intercambios competitivos para propósitos de almacenamiento solamente. Cuando se identifican intercambios múltiples, consulte la sección de aplicaciones de este catálogo.

COMPETITIVE & O.E.M. INTERCHANGE LIST
Lista de Intercambios contra Competidores y Equipo Original.
Liste dinterchange de produits comptitifs & dquipement original (OEM)

AUTOMANN... cont'd

Autopart International

Autopart international	Gabriel	Upgrade	Autopart international	Gabriel	Upgrade	Autopart international	Gabriel	Upgrade	Autopart international	Gabriel	Upgrade
2701-08486	G56620		2701-248152	G51719		2701-248247	G56562		2701-256905	G56995	
2701-08487	G56509		2701-248153	G51729		2701-248248	G56643		2701-256908	G57057	
2701-08598	G56635		2701-248154	81913		2701-248249	G56512		2701-256908	G57058	
2701-08987	G56636		2701-248155	G63870		2701-248250	G51728		2701-258033	G56729	
2701-08995	M56501		2701-248156	G63867		2701-248273	G52009		2701-25896	G56933	
2701-204603	69813		2701-248156	G64157		2701-248274	G52008		2701-259996	G56931	
2701-204605	81921		2701-248157	G63607		2701-248275	G52033		2701-259997	G56930	
2701-204606	69996		2701-248158	G63837		2701-248276	G52032		2701-259998	G56933	
2701-204608	81730		2701-248159	G51703		2701-248283	G56661		2701-259999	G56932	
2701-204608	81891		2701-248163	G63692		2701-248286	G56722		2701-275042	G56991	
2701-204608	81917		2701-248164	G63842		2701-248287	G56660		2701-276991	G56802	
2701-204609	69766		2701-248165	G63884		2701-248288	G52014		2701-277361	70040	
2701-204611	G63781		2701-248166	G63882		2701-248295	G52098		2701-287484	G57051	
2701-204612	G63455		2701-248168	G51850		2701-248300	G56721		2701-288156	69901	
2701-204612	G63717		2701-248172	G63879		2701-248301	G56680		2701-288911	G52111	
2701-204617	G51252		2701-248173	G63896		2701-248302	G56679		2701-288912	G52110	
2701-204619	G51279		2701-248174	G64015		2701-248303	G56581		2701-289571	G64003	
2701-204621	G51713		2701-248175	G63893		2701-248304	G56582		2701-289578	G57011	
2701-204625	G52336		2701-248176	81930		2701-248306	G52013		2701-289579	G57012	
2701-204626	G52335		2701-248177	G63894		2701-248307	G56728		2701-289580	G57017	
2701-204627	G56514		2701-248179	G51858		2701-248309	G52107		2701-289581	G57018	
2701-204628	G56506		2701-248180	G64000		2701-248309	G56797		2701-289582	G57022	
2701-204643	G56633		2701-248182	69907		2701-248310	G56785		2701-289583	G57020	
2701-204644	G56634		2701-248185	G51814		2701-248312	G56513		2701-289584	G57021	
2701-204645	G56802		2701-248186	G51813		2701-248726	G56962		2701-289585	G57015	
2701-204646	G56606		2701-248190	G56807		2701-248727	G56963		2701-289586	G57016	
2701-204651	G56537		2701-248191	G63844		2701-248728	G56936		2701-289587	G57019	
2701-204652	G56538		2701-248192	G64032		2701-248729	G56927		2701-289588	G57007	
2701-204653	G56672		2701-248197	G63864		2701-248730	G56934		2701-289589	G57008	
2701-204654	G56671		2701-248202	G51715		2701-248730	G56937		2701-289591	G57013	
2701-204657	81495		2701-248203	G51798		2701-248731	G56935		2701-289592	G57014	
2701-204660	G56684		2701-248204	G51802		2701-248732	G57060		2701-312896	70010	
2701-204660	G56686		2701-248205	G51803		2701-248734	G57064		2701-313021	G51736	
2701-204663	81919		2701-248206	G63883		2701-248735	G56928		2701-313757	G51758	
2701-204665	M55896		2701-248207	G63878		2701-248736	G57063		2701-314376	G51838	
2701-233579	6828SE		2701-248210	G63815		2701-248739	G56957		2701-314377	G51716	
2701-233580	6854SE		2701-248214	70028		2701-248740	G56956		2701-314381	G51805	
2701-233597	6847SE		2701-248219	G63889		2701-248742	G56951		2701-314386	G56843	
2701-236112	G56683		2701-248219	G64006		2701-248751	G56938		2701-314387	G56842	
2701-236112	G56685		2701-248222	G51739		2701-248755	G56949		2701-316357	G56641	
2701-239525	49255		2701-248223	G63885		2701-248756	G56950		2701-316359	G56640	
2701-24308	G52108		2701-248223	G64029		2701-248757	G57010		2701-316361	G52333	
2701-24308	G56798		2701-248223	G64030		2701-248758	G56992		2701-316363	G52334	
2701-248126	G51737		2701-248224	G56561		2701-248759	G57039		2701-316364	G56809	
2701-248127	G51738		2701-248225	G56759		2701-248775	G55879		2701-316365	G56809	
2701-248136	G63962		2701-248226	G56758		2701-248776	G55879		2701-316366	G52006	
2701-248137	81932		2701-248227	G56784		2701-255680	G51714		2701-316367	G52005	
2701-248142	81933		2701-248228	G56601		2701-256870	G56998		2701-316368	70003	
2701-248144	G63958		2701-248230	G56568		2701-256871	G56943		2701-316369	G51727	
2701-248145	G63892		2701-248233	G56655		2701-256875	G56964		2701-316657	G57026	
2701-248146	G64016		2701-248236	G51718		2701-256892	G56994		2701-317183	G56889	
2701-248149	G51724		2701-248239	G56678		2701-256893	G56993		2701-317184	G56888	
2701-248150	G51704		2701-248240	G56677		2701-256894	G56948		2701-321054	G52164	
2701-248151	G51722		2701-248244	G56642		2701-256895	G56948		2701-321057	G52165	

Important Note: Competitive Interchanges are to be used for stocking purposes only. Where multiple crosses are identified, please reference the applications section of this catalog. / **Remarque importante:** Les interchanges concurrentiels ne s'utilisent qu'aux fins de stocks. Dans le cas de références multiples, consulter la section des applications du catalogue. / **Nota importante:** Dans le cas de referencias multiples, consultar la sección de aplicaciones del catálogo. / **Nota importante:** Se pueden usar intercambios competitivos para propósitos de almacenamiento solamente. Cuando se identifican intercambios múltiples, consulte la sección de aplicaciones de este catálogo.

COMPETITIVE & O.E.M. INTERCHANGE LIST
Lista de Intercambios contra Competidores y Equipo Original.
Liste d'interchange de produits compétitifs & d'équipement original (OEM)

Autopart International... cont'd

Autopart international	Gabriel	Upgrade	Autopart international	Gabriel	Upgrade	Autopart international	Gabriel	Upgrade	Autopart international	Gabriel	Upgrade
2701-321278	G57031		2701-412141	G57034		2701-423498	G51877		2701-424210	G52281	
2701-321279	G57030		2701-412142	G57035		2701-423499	G51892		2701-424211	G52280	
2701-322040	G56799		2701-412146	G57045		2701-423500	G51879		2701-424212	G52396	
2701-322041	G56800		2701-412147	G57046		2701-423504	G51925		2701-424213	G52395	
2701-335085	G51804		2701-412150	G56680		2701-423505	G51926		2701-424214	G52176	
2701-335087	G51842		2701-412150	G56731		2701-423509	G511019		2701-424215	G52175	
2701-335090	G52082		2701-412151	G56679		2701-423510	G511020		2701-424216	G56778	
2701-335091	G52081		2701-412151	G56730		2701-423607	G57010		2701-424222	G52300	
2701-412058	G56616		2701-421772	G56838		2701-42372	G51286		2701-424223	G52299	
2701-412058	G56688		2701-421773	70027		2701-423797	G51955		2701-42423	G51815	
2701-412059	G56615		2701-423311	G64087		2701-423798	70089		2701-424238	G52131	
2701-412059	G56687		2701-423312	G63832		2701-423799	G52122		2701-424239	G52118	
2701-412060	G51799		2701-423313	G63828		2701-423800	G52121		2701-424240	G52117	
2701-412061	70013		2701-423314	70053		2701-423804	G51766		2701-424241	G52149	
2701-412062	70039		2701-423333	G52204		2701-423807	70041		2701-424242	G52148	
2701-412063	G51783		2701-423334	G52203		2701-423816	G52174		2701-424244	G51856	
2701-412067	69450		2701-423335	G52202		2701-423817	G52173		2701-424249	G51852	
2701-412068	G64027		2701-423336	G52201		2701-423821	G64050		2701-424251	G51847	
2701-412069	G64026		2701-423338	G51477		2701-423833	G63813		2701-424252	G51848	
2701-412070	69901		2701-423339	G52332		2701-423835	G63909		2701-42433	G51795	
2701-412070	70040		2701-423340	G52331		2701-423883	G64048		2701-424374	G52113	
2701-412075	70000		2701-423356	G64038		2701-423884	70036		2701-424375	G52112	
2701-412077	70086		2701-423357	G51855		2701-423885	70036		2701-424378	G51807	
2701-412078	G63872		2701-423359	G52103		2701-423886	70037		2701-424381	G56687	
2701-412081	G56839		2701-423360	G52104		2701-423887	G64071		2701-424384	G511055	
2701-412084	G56598		2701-423383	G51937		2701-423896	G52155		2701-424385	G56688	
2701-412085	G52275		2701-423394	G51920		2701-423919	81916		2701-424386	G52237	
2701-412086	G52274		2701-423395	G51921		2701-423921	70045		2701-424388	G52238	
2701-412088	G63799		2701-423408	G51832		2701-423922	G51097		2701-424389	69998	
2701-412089	G56518		2701-423409	G51833		2701-423924	70034		2701-424517	G51810	
2701-412093	G56773		2701-423413	G64037		2701-423928	G64046		2701-424518	G51811	
2701-412094	G56774		2701-423414	G64111		2701-423930	69952		2701-42456	G51904	
2701-412095	G52027		2701-423415	G51836		2701-423932	G64047		2701-424576	G511054	
2701-412096	G52026		2701-423427	G52265		2701-423933	G64056		2701-424577	70078	
2701-412097	G56820		2701-423428	G52264		2701-423937	69966		2701-424592	G56841	
2701-412098	G56819		2701-423454	G51911		2701-424130	G511004		2701-424593	G56840	
2701-412099	G56821		2701-423456	G52250		2701-424138	G64052		2701-424656	G56836	
2701-412100	G56822		2701-423457	G52249		2701-424142	G63615		2701-424657	G56837	
2701-412101	G52141		2701-423458	G52188		2701-424143	G63694		2701-424669	G51896	
2701-412102	G52140		2701-423459	G52187		2701-424152	G63971		2701-424670	G51897	
2701-412103	G52007		2701-423462	G51919		2701-424153	G64043		2701-424672	G63873	
2701-412104	G52004		2701-423463	G51918		2701-424155	G64001		2701-424682	G63808	
2701-412109	G52275		2701-423464	G51917		2701-424156	G63965		2701-424874	G52019	
2701-412110	G52274		2701-423465	G51966		2701-424157	G63866		2701-424886	G64105	
2701-412115	G52095		2701-423485	G51905		2701-424158	G63959		2701-424893	G63674	
2701-412116	G52094		2701-423486	70060		2701-424171	G52184		2701-424895	G64028	
2701-412117	G52097		2701-423487	G52282		2701-424173	G51908		2701-424957	G55772	
2701-412118	G52096		2701-423488	G52283		2701-424175	G51883		2701-425023	G52018	
2701-412127	G56894		2701-423489	G51880		2701-424182	G52185		2701-425024	G52017	
2701-412128	G56899		2701-423490	G52150		2701-424183	G52168		2701-425025	G56893	
2701-412129	G52273		2701-423491	G52151		2701-424189	G52169		2701-425026	G56892	
2701-412130	G52272		2701-423493	G52153		2701-424199	G56735		2701-425029	G52036	
2701-412131	G51910		2701-423494	G52152		2701-424200	G56734		2701-425030	G52037	
2701-412138	G56929		2701-423495	G52254		2701-424201	G56733		2701-425032	G51982	
2701-412139	G57065		2701-423496	G52253		2701-424202	G56732		2701-425041	G51920	
2701-412140	G57066		2701-423497	G51878		2701-424206	G64042		2701-425042	G51921	

Important Note: Competitive Interchanges are to be used for stocking purposes only. Where multiple crosses are identified, please reference the applications section of this catalog. / **Remarque importante:** Les interchanges concurrentiels ne s'utilisent qu'aux fins de stocks. Dans le cas de références multiples, consulter la section des applications du catalogue. / **Nota importante:** Dans le cas de referencias multiples, consultar la sección de aplicaciones del catálogo. / **Nota importante:** Se pueden usar intercambios competitivos para propósitos de almacenamiento solamente. Cuando se identifican intercambios múltiples, consulte la sección de aplicaciones de este catálogo.

COMPETITIVE & O.E.M. INTERCHANGE LIST
Lista de Intercambios contra Competidores y Equipo Original.
Liste dinterchange de produits complitifs & dquipement original (OEM)

Autopart International... cont'd

Autopart international	Gabriel	Upgrade	Autopart international	Gabriel	Upgrade	Autopart international	Gabriel	Upgrade	Autopart international	Gabriel	Upgrade
2701-425048	G51922		2701-460180	G51860		2701-502758	G57110		2701-52546	G57139	
2701-425061	G51773		2701-460181	G51861		2701-502759	G57111		2701-52547	G57140	
2701-425102	70098		2701-460182	G51865		2701-502760	G57059		2701-527288	G52314	
2701-425231	G56997		2701-460183	G51864		2701-502761	G57114		2701-527293	G52314	
2701-425232	G56996		2701-460184	70049		2701-502762	G57115		2701-528206	G51856	
2701-42955	G51794		2701-460185	G52154		2701-502763	G57172		2701-528382	G52361	
2701-429941	G57121		2701-479132	G57049		2701-502823	G52406		2701-528383	G52360	
2701-429942	G57122		2701-479133	G57033		2701-502832	70096		2701-528400	70068	
2701-460054	70033		2701-479133	G57062		2701-502834	G52399		2701-528877	G52525	
2701-460056	70065		2701-479134	G57032		2701-502835	G52398		2701-528878	G52524	
2701-460062	70056		2701-479134	G57061		2701-502974	G51825		2701-528879	G52355	
2701-460066	69464		2701-479137	G57050		2701-502975	G51774		2701-528880	G52356	
2701-460066	81935		2701-480154	G57076		2701-502980	G52294		2701-536290	G57203	
2701-460067	70052		2701-480155	G57077		2701-502981	G52293		2701-536292	G57202	
2701-460070	G63886		2701-480158	G57053		2701-502982	G51933		2701-536646	G57163	
2701-460070	G63969		2701-480161	G57036		2701-503072	G51863		2701-536647	G57164	
2701-460071	G63969		2701-480166	G57086		2701-503789	G52352		2701-539565	G57131	
2701-460072	G63969		2701-480167	G57087		2701-503790	G52351		2701-539566	G57130	
2701-460073	G64010		2701-480168	G57092		2701-503836	G51881		2701-539572	G57178	
2701-460074	G63622		2701-480169	G57096		2701-505582	G52375		2701-539575	G57138	
2701-460075	G64079		2701-480170	G57125		2701-507603	G52349		2701-539576	G57137	
2701-460077	G63888		2701-480172	G57118		2701-507604	G52348		2701-541592	G57091	
2701-460081	70031		2701-480173	G57123		2701-507605	G52301		2701-541593	G57090	
2701-460082	G64040		2701-480174	G57124		2701-507608	G51928		2701-541594	G57106	
2701-460085	70095		2701-480175	G57095		2701-507609	G51993		2701-541595	G57105	
2701-460086	G51746		2701-480176	G57133		2701-507707	G52105		2701-541599	G57204	
2701-460086	G51806		2701-480177	G57134		2701-507708	G52106		2701-547832	G64031	
2701-460089	G52116		2701-480178	G57147		2701-507718	G51841		2701-547833	G64008	
2701-460091	G51806		2701-480312	G57054		2701-507726	G51758		2701-547834	G64033	
2701-460092	G52157		2701-480313	G57055		2701-507727	G51815		2701-54914	G57177	
2701-460093	G52156		2701-480314	G57056		2701-507739	70001		2701-54915	G57176	
2701-460094	G52159		2701-480317	G57027		2701-508495	G63815		2701-56897	G56932	
2701-460095	G52158		2701-480318	G57027		2701-511481	G52295		2701-584377	G51891	
2701-460103	G52183		2701-480321	G57157		2701-511807	G57120		2701-730414	G57852	
2701-460104	G52182		2701-480322	G57158		2701-511808	G57119		2701-730415	G57853	
2701-460105	G52374		2701-480324	G57159		2701-511827	G57083		2701-80473	G55856	
2701-460106	G51961		2701-480324	G57160		2701-511828	G57083		2701-80475	G56517	
2701-460124	G52142		2701-480325	G57084		2701-511860	G52128		2701-80476	G56516	
2701-460125	G52143		2701-480326	G57085		2701-511865	G52127		2701-80477	G55994	
2701-460134	G52145		2701-482228	G52125		2701-514598	G57205		2701-80478	G55993	
2701-460135	G52144		2701-497098	G57042		2701-518672	G52440		2701-80480	G55901	
2701-460147	G52209		2701-497099	G57041		2701-518673	G52439		2701-80481	G55698	
2701-460148	G52210		2701-499609	G57103		2701-522613	G52257		2701-80484	M55974	
2701-460149	G52260		2701-499610	G57132		2701-522614	G52170		2701-80485	M55975	
2701-460150	G52261		2701-501868	G57043		2701-522615	G52171		2701-80491	G55870	
2701-460153	G56791		2701-501869	G57044		2701-524158	G57206		2701-80493	G51255	
2701-460153	G56792		2701-502744	G57112		2701-524520	G57167		2701-80494	G51256	
2701-460155	G51849		2701-502745	G57113		2701-524521	G57168		2701-80496	G55999	
2701-460156	G52161		2701-502748	G57088		2701-524525	G57097		2701-80497	G55999	
2701-460157	G52160		2701-502749	G57089		2701-524526	G57098		2701-80498	G55662	
2701-460158	G52248		2701-502750	G57142		2701-524543	G57141		2701-80499	G55661	
2701-460159	G52247		2701-502752	G57162		2701-524568	G57156		2701-80508	G56591	
2701-460166	G52130		2701-502755	G57078		2701-524587	G57030		2701-80509	G55820	
2701-460167	G52129		2701-502756	G57079		2701-524588	G57031		2701-80512	G51254	
2701-460170	G52163		2701-502757	G57099		2701-524606	G57081		2701-80513	G55676	
2701-460171	G52162		2701-502757	G57100		2701-524607	G57082		2701-80515	G55675	

Important Note: Competitive Interchanges are to be used for stocking purposes only. Where multiple crosses are identified, please reference the applications section of this catalog. / **Remarque importante:** Les interchanges concurrentiels ne s'utilisent qu'aux fins de stocks. Dans le cas de références multiples, consulter la section des applications du catalogue. / **Nota importante:** En el caso de referencias múltiples, consulte la sección de aplicaciones del catálogo. / **Nota importante:** Se pueden usar intercambios competitivos para propósitos de almacenamiento solamente. Cuando se identifican intercambios múltiples, consulte la sección de aplicaciones de este catálogo.

COMPETITIVE & O.E.M. INTERCHANGE LIST
Lista de Intercambios contra Competidores y Equipo Original.
Liste d'interchange de produits complitifs & d'equipement original (OEM)

Autopart International... cont'd

Autopart international	Gabriel	Upgrade	Autopart international	Gabriel	Upgrade	Autopart international	Gabriel	Upgrade	Autopart international	Gabriel	Upgrade
2701-80538	M55848		2701-80684	G63425		2701-80947	G63845		2702-32831	142842	
2701-80539	M55848		2701-80685	G63810		2701-80949	81923		2702-32847	142843	
2701-80551	G55774		2701-80689	G63847		2701-80952	G63350		2702-32860	142402	
2701-80551	M55877		2701-80690	69962		2701-80953	81583		2702-32944	142329	
2701-80552	G55774		2701-80691	69898		2701-80955	81924		2702-32954	142547	
2701-80552	M55877		2701-80691	81794		2701-80956	G63676		2702-32957	142546	
2701-80554	M55912		2701-80692	81927		2701-80957	G63829		2702-32958	142546	
2701-80558	M55913		2701-80693	81936		2701-80958	81873		2702-32973	142245	
2701-80573	G51087		2701-80696	81904		2701-80959	81912		2702-32996	142173	
2701-80587	G56540		2701-80871	81750		2701-80960	81833		2702-33086	142932	
2701-80588	G56539		2701-80872	81482		2701-80962	81828		2702-33087	142828	
2701-80593	G55697		2701-80875	81490		2701-80963	81928		2702-425444	143305	
2701-80593	M55697		2701-80875	81836		2701-82488	81892		2702-429309	143345	
2701-80595	G51772		2701-80876	81039		2701-82572	81923		2702-481941	143404	
2701-80596	G51767		2701-80877	81878		2701-82573	81920		2702-496762	143383	
2701-80601	G56718		2701-80880	81905		2701-82574	81925		2702-496800	143343	
2701-80601	M56718		2701-80880	81918		2701-82577	81931		2702-497209	143366	
2701-80603	G55579		2701-80881	G63454		2701-82582	G63929		2702-497274	143316	
2701-80609	G55551		2701-80882	81484		2701-82583	G55821		2702-497281	143409	
2701-80611	G56700		2701-80883	G63424		2701-82584	G63809		2702-497281	143410	
2701-80612	G56701		2701-80886	81559		2701-82585	G63410		2702-501865	143495	
2701-80613	M56708		2701-80887	81560		2701-82586	G63387		2702-502751	G57161	
2701-80620	G51267		2701-80888	69845		2701-82587	81394		2702-502764	G57173	
2701-80621	G51268		2701-80889	81893		2701-82588	G63366		2702-522616	G52258	
2701-80627	M55693		2701-80890	81914		2701-82589	G64002		2702-527292	G51900	
2701-80633	69945		2701-80891	69755		2701-82590	G63803		2702-543070	143455	
2701-80633	81934		2701-80892	81516		2701-82592	G63183		2702-71220	143059	
2701-80645	81713		2701-80893	81164		2701-91981	6801SE		2702-71221	143063	
2701-80646	70020		2701-80894	69676		2702-07929	143191		2702-71222	143064	
2701-80649	69909		2701-80896	81540		2702-20192	142573		2702-71241	142249	
2701-80650	69900		2701-80898	G63353		2702-204186	143464		2702-71247	142317	
2701-80652	81582		2701-80899	81096		2702-22374	143191		2702-71258	142404	
2701-80653	81837		2701-80900	81496		2702-236455	143321		2702-71274	143422	
2701-80655	81667		2701-80901	81082		2702-275057	143418		2702-71374	142250	
2701-80656	81668		2701-80901	81510		2702-30481	143244		2702-71393	142244	
2701-80657	81726		2701-80901	81710		2702-30482	143244		2702-71397	142444	
2701-80658	81744		2701-80903	81091		2702-313227	143363		2702-71413	142625	
2701-80659	81823		2701-80906	G63928		2702-316354	143323		2702-71414	142561	
2701-80659	81890		2701-80908	81937		2702-322136	143344		2702-71453	142530	
2701-80661	81691		2701-80908	82066		2702-32226	142649		2702-72157	142403	
2701-80662	69465		2701-80909	69625		2702-32228	142650		2702-82590	81922	
2701-80663	G63782		2701-80909	81494		2702-32266	143367		2702-84088	143201	
2701-80664	G63707		2701-80910	81446		2702-32273	142439		2702-90023	143058	
2701-80665	G63708		2701-80916	G63610		2702-32274	142836		2702-90302	142195	
2701-80666	69863		2701-80918	69787		2702-32283	143191		2702-94193	143266	
2701-80666	69903		2701-80919	81478		2702-32389	142746		2702-94194	143255	
2701-80667	G63937		2701-80934	G63419		2702-32395	143088		2702-94197	143241	
2701-80669	69901		2701-80934	G63492		2702-324503	143335		2702-95592	143209	
2701-80670	G63620		2701-80935	G63173		2702-32467	143459		2702-95593	143204	
2701-80672	G63726		2701-80935	G63907		2702-32472	142735		2702-95597	143259	
2701-80673	81910		2701-80936	G63299		2702-32476	143058		2702-95602	142949	
2701-80674	G51077		2701-80939	81871		2702-32785	142247		2702-95611	143325	
2701-80675	G63720		2701-80940	81870		2702-32787	143281		2702-95612	143197	
2701-80676	69946		2701-80941	81872		2702-32789	142230		2702-95617	142930	
2701-80682	81911		2701-80942	69725		2702-32791	142135		2702-95618	143315	
2701-80683	81929		2701-80945	G63903		2702-32820	142840		2702-96575	143458	

Important Note: Competitive Interchanges are to be used for stocking purposes only. Where multiple crosses are identified, please reference the applications section of this catalog. / **Remarque importante:** Les interchanges concurrentiels ne s'utilisent qu'aux fins de stocks. Dans le cas de rferences multiples, consulter la section des applications du catalogue. / **Nota importante:** Dans le cas de rferences multiples, consulter la section des applications du catalogue. / **Nota importante:** Se pueden usar intercambios competitivos para propósitos de almacenamiento solamente. Cuando se identifican intercambios múltiples, consulte la sección de aplicaciones de este catálogo.

COMPETITIVE & O.E.M. INTERCHANGE LIST
Lista de Intercambios contra Competidores y Equipo Original.
Liste d'interchange de produits compititifs & d'equpement original (OEM)

Autopart International... cont'd

Autopart international	Gabriel	Upgrade	Autopart international	Gabriel	Upgrade	Autopart international	Gabriel	Upgrade	Autopart international	Gabriel	Upgrade
2702-97311	143353		2725-539606	58930		2725-539634	58809		2725-546476	58422	
2702-98005	142651		2725-539618	58803		2725-539635	58807		2725-546476	58488	
2702-98083	143087		2725-539620	58817		2725-539642	G64011				
2702-98986	143202		2725-539627	58609		2725-539650	58623				
2725-539606	58662		2725-539630	58714		2725-539651	58622				

AutoZone

Autozone	Gabriel	Upgrade	Autozone	Gabriel	Upgrade	Autozone	Gabriel	Upgrade	Autozone	Gabriel	Upgrade
313 237	G52095		LS33-80261L	G57007		LS33-80701R	G57131		LS34-84081L	G57114	
313 238	G52094		LS33-80261R	G57008		LS33-80721L	G57390		LS34-84081R	G57115	
344426	81676		LS33-80271L	G56996		LS33-80721R	G57391		LS34-84091L	G57357	
61552	81870		LS33-80271R	G56997		LS33-80741L	G57268		LS34-84091R	G57358	
61559	81730		LS33-80282L	G57032		LS33-80741R	G57269		LS34-84101L	G57404	
61655	61655		LS33-80282L	G57061		LS33-80751B	G57013		LS34-84101R	G57405	
61712	61712		LS33-80282R	G57033		LS33-80761B	G57006		LS34-84121L	G57204	
69962	81927		LS33-80282R	G57062		LS33-80761B	G57392		LS34-84121R	G57205	
82025	82025		LS33-80301B	G57080		LS33-80771L	G57034		LS34-84131L	G57204	
82040	82040		LS33-80311L	G57054		LS33-80771R	G57035		LS34-84131R	G57205	
82151	82151		LS33-80311R	G57055		LS33-80781B	G57099		LS34-84161L	G57084	
82615	82615		LS33-80342L	G57568		LS33-80781B	G57100		LS34-84161R	G57085	
G51077	G51077		LS33-80342R	G57569		LS33-80801L	G57377		LS34-84181L	G57558	
G51087	G51087		LS33-80352B	G57159		LS33-80801R	G57378		LS34-84181R	G57559	
G51252	G51252		LS33-80352B	G57160		LS33-80831B	G57059		LS34-84191L	G57184	
G51267	G51267		LS33-80362B	G57430		LS33-80851B	G57680		LS34-84191R	G57185	
G51279	G51279		LS33-80372L	G57424		LS33-80861B	G57149		LS34-84211B	G57141	
G51477	G51477		LS33-80372R	G57425		LS33-80891L	G56991		LS34-84221L	G57477	
G51700	G51700		LS33-80382L	G57067		LS33-80891R	G56992		LS34-84221R	G57478	
G51703	G51703		LS33-80382R	G57068		LS33-80911B	G57039		LS34-84261L	G57640	
G51704	G51704		LS33-80392B	G57444		LS33-80922B	G57018		LS34-84261R	G57641	
G51713	G51713		LS33-80402L	G57086		LS33-80931B	G57000		LS34-84311L	G57345	
G51714	G51714		LS33-80402R	G57087		LS33-80931B	G57023		LS34-84311R	G57346	
G51715	G51715		LS33-80411B	G57282		LS33-80941B	G57053		LS34-84321L	G57515	
G63524	81905		LS33-80422B	G57423		LS33-80952B	G57036		LS34-84321R	G57516	
LS33-80001L	G57608		LS33-80432L	G57428		LS33-80971B	G57421		LS34-84331L	G57365	
LS33-80001R	G57609		LS33-80432R	G57429		LS33-80982B	G57607		LS34-84331R	G57366	
LS33-80031L	G57270		LS33-80471B	G57146		LS33-81011B	G57125		LS34-84351L	G57369	
LS33-80031R	G57270		LS33-80481B	G57409		LS33-81021B	G57147		LS34-84351R	G57370	
LS33-80061L	G57148		LS33-80491B	G57118		LS33-81042B	G57447		LS34-84361L	G57088	
LS33-80061R	G57148		LS33-80491B	G57413		LS33-81052B	G57579		LS34-84361R	G57089	
LS33-80091B	G57427		LS33-80511L	G57027		LS33-81102L	G57400		LS34-84381B	G57142	
LS33-80111L	G57207		LS33-80511R	G57027		LS33-81102R	G57401		LS34-84391L	G57161	
LS33-80111L	G57417		LS33-80541B	G57646		LS33-81111L	G57363		LS34-84391R	G57162	
LS33-80111R	G57208		LS33-80552L	G57416		LS33-81111R	G57364		LS34-84411L	G57218	
LS33-80111R	G57418		LS33-80552R	G57682		LS33-81121B	G57156		LS34-84411R	G57219	
LS33-80121L	G57455		LS33-80582L	G57597		LS33-81121B	G57277		LS34-84421L	G57644	
LS33-80121R	G57456		LS33-80582R	G57598		LS33-81131L	G57390		LS34-84421R	G57645	
LS33-80131L	G57594		LS33-80592L	G57599		LS33-81131R	G57391		LS34-84431B	G57324	
LS33-80131R	G57595		LS33-80592R	G57600		LS33-81141B	G57092		LS34-84441B	G56927	
LS33-80181B	G57557		LS33-80602L	G57451		LS33-81201B	G57397		LS34-84451B	G57060	
LS33-80192B	G56998		LS33-80602R	G57452		LS34-84001B	G57274		LS34-84461L	G56930	
LS33-80202B	G57057		LS33-80612L	G57572		LS34-84011L	G57190		LS34-84461R	G56931	
LS33-80202B	G57058		LS33-80612R	G57573		LS34-84011R	G57191		LS34-84521B	G56951	
LS33-80212B	G56995		LS33-80652B	G57675		LS34-84021L	G57539		LS34-84531L	G56948	
LS33-80231L	G56993		LS33-80681L	G57202		LS34-84021R	G57540		LS34-84531R	G56948	
LS33-80231R	G56994		LS33-80681R	G57203		LS34-84051L	G57097				
LS33-80241B	G57022		LS33-80691L	G57275		LS34-84051R	G57098				
LS33-80251L	G57010		LS33-80691R	G57276		LS34-84071L	G57157				
LS33-80251R	G57010		LS33-80701L	G57130		LS34-84071R	G57158				

Important Note: Competitive Interchanges are to be used for stocking purposes only. Where multiple crosses are identified, please reference the applications section of this catalog./ **Remarque importante:** Les interchanges concurrentiels ne s'utilisent qu'aux fins de stocks. Dans le cas de rrences multiples, consulter la section des applications du catalogue./ **Nota importante:** Dans le cas de rrences multiples, consulte la section des applications du catalogue./ **Nota importante:** Se pueden usar intercambios competitivos para propósitos de almacenamiento solamente. Cuando se identifican intercambios múltiples, consulte la sección de aplicaciones de este catálogo.

COMPETITIVE & O.E.M. INTERCHANGE LIST
Lista de Intercambios contra Competidores y Equipo Original.
Liste dinterchange de produits comptitifs & dquipement original (OEM)

AutoZone... cont'd

Autozone	Gabriel	Upgrade	Autozone	Gabriel	Upgrade	Autozone	Gabriel	Upgrade	Autozone	Gabriel	Upgrade
LS34-84581B	G56975		LS34-85411R	G57223		LS53-90611L	G57479		LS54-94321B	G57206	
LS34-84591B	G56965		LS34-85451L	G57495		LS53-90611R	G57480		LS54-94331B	G57206	
LS34-84651B	G57051		LS34-85451R	G57496		LS53-90621L	G57574		LS54-94342L	G57343	
LS34-84691L	G57030		LS34-85471L	G57359		LS53-90621R	G57575		LS54-94342R	G57344	
LS34-84691R	G57031		LS34-85471R	G57360		LS53-90651L	G57197		LS54-94351L	G57471	
LS34-84701L	G57521		LS53-90002L	G57167		LS53-90651L	G57322		LS54-94351R	G57472	
LS34-84701R	G57522		LS53-90002R	G57168		LS53-90651R	G57198		LS54-94391L	G56956	
LS34-84711B	G56929		LS53-90052L	G57642		LS53-90651R	G57323		LS54-94391R	G56957	
LS34-84721L	G57047		LS53-90052R	G57643		LS53-90661L	G57564		LS54-94411L	G56962	
LS34-84721R	G57048		LS53-90062L	G57634		LS53-90661R	G57565		LS54-94411L	G57431	
LS34-84741L	G57049		LS53-90062R	G57635		LS53-90671L	G57266		LS54-94411R	G56963	
LS34-84741R	G57050		LS53-90082B	G56928		LS53-90671R	G57267		LS54-94411R	G57432	
LS34-84771L	G57076		LS53-90122L	G56949		LS53-90691B	G57071		LS54-94432L	G56973	
LS34-84771R	G57077		LS53-90122R	G56950		LS53-90691B	G57072		LS54-94432R	G56974	
LS34-84791L	G57069		LS53-90142B	G57014		LS53-90712B	G56943		LS54-94451L	G57011	
LS34-84791L	G57121		LS53-90161L	G57582		LS53-90722B	G57576		LS54-94451R	G57012	
LS34-84791R	G57070		LS53-90161R	G57583		LS53-90732B	G56964		LS54-94462L	G56924	
LS34-84791R	G57122		LS53-90181L	G57353		LS53-90752B	G57056		LS54-94462R	G56925	
LS34-84821L	G57628		LS53-90181R	G57354		LS53-90801L	G57361		LS54-94471B	G57271	
LS34-84821R	G57629		LS53-90201L	G57083		LS53-90801R	G57362		LS54-94482L	G57078	
LS34-84861L	G57393		LS53-90201R	G57083		LS53-90841L	G57549		LS54-94482R	G57079	
LS34-84861R	G57394		LS53-90251B	G57020		LS53-90841R	G57550		LS54-94491L	G57664	
LS34-84931L	G57465		LS53-90261B	G57015		LS53-90852L	G57509		LS54-94491R	G57663	
LS34-84931R	G57466		LS53-90261B	G57212		LS53-90852R	G57510		LS54-94521L	G57473	
LS34-84941L	G57577		LS53-90271B	G57017		LS53-90872B	G57075		LS54-94521R	G57474	
LS34-84941R	G57578		LS53-90281B	G57021		LS53-90941B	G57040		LS54-94531L	G57137	
LS34-84961L	G57329		LS53-90291B	G57019		LS54-94032L	G57483		LS54-94531R	G57138	
LS34-84961R	G57330		LS53-90302B	G57437		LS54-94032R	G57484		LS54-94541L	G57481	
LS34-84981L	G57493		LS53-90322B	G57422		LS54-94042L	G57650		LS54-94541R	G57482	
LS34-84981R	G57494		LS53-90332B	G57026		LS54-94042R	G57651		LS54-94572L	G56924	
LS34-85001L	G57673		LS53-90361L	G57220		LS54-94081L	G57163		LS54-94572R	G56925	
LS34-85001R	G57674		LS53-90361R	G57221		LS54-94081R	G57164		LS54-94681L	G57562	
LS34-85021L	G57603		LS53-90371B	G57095		LS54-94091L	G57105		LS54-94681R	G57563	
LS34-85021R	G57604		LS53-90391B	G57132		LS54-94091R	G57106		LS54-94691B	G57109	
LS34-85121L	G57081		LS53-90401B	G57103		LS54-94101L	G57349		LS54-94691B	G57314	
LS34-85121R	G57082		LS53-90411L	G57133		LS54-94101R	G57350		LS54-94701L	G57676	
LS34-85131L	G57063		LS53-90411R	G57134		LS54-94132L	G57586		LS54-94701R	G57677	
LS34-85131R	G57064		LS53-90432L	G57419		LS54-94132R	G57587		LS54-94722B	G56936	
LS34-85141B	G56934		LS53-90432R	G57419		LS54-94141L	G57375		LS54-94732B	G57016	
LS34-85141B	G56937		LS53-90442L	G57278		LS54-94141R	G57376		LS54-94752L	G57090	
LS34-85151B	G56935		LS53-90442R	G57279		LS54-94161L	G57373		LS54-94752R	G57091	
LS34-85182L	G57414		LS53-90491L	G57311		LS54-94161R	G57372		LS54-94851L	G57612	
LS34-85182R	G57415		LS53-90491R	G57312		LS54-94171L	G57614		LS54-94851R	G57613	
LS34-85192B	G57096		LS53-90512B	G56938		LS54-94171R	G57615		LS54-94881L	G57144	
LS34-85202B	G57173		LS53-90522L	G56932		LS54-94191L	G57150		LS54-94881R	G57145	
LS34-85211L	G57339		LS53-90522R	G56933		LS54-94191R	G57151		LS54-94922L	G57152	
LS34-85211R	G57340		LS53-90541L	G57045		LS54-94211L	G57112		LS54-94922R	G57153	
LS34-85241L	G57341		LS53-90541R	G57046		LS54-94211R	G57113		LS54-94981L	G57037	
LS34-85241R	G57342		LS53-90561L	G57110		LS54-94221L	G57489		LS54-94981R	G57038	
LS34-85251L	G57341		LS53-90561L	G57535		LS54-94221R	G57490		LS54-95001L	G57119	
LS34-85251R	G57342		LS53-90561R	G57111		LS54-94281L	G57176		LS54-95011R	G57120	
LS34-85271L	G57041		LS53-90561R	G57536		LS54-94281L	G57464		LS55-99001L	G57333	
LS34-85271R	G57042		LS53-90601L	G57331		LS54-94281R	G57177		LS55-99001R	G57334	
LS34-85341L	G57459		LS53-90601L	G57601		LS54-94281R	G57463		LS55-99011L	G57560	
LS34-85341R	G57460		LS53-90601R	G57332		LS54-94301L	G57139		LS55-99011R	G57561	
LS34-85411L	G57222		LS53-90601R	G57602		LS54-94301R	G57140		TS32-30002B	81495	

Important Note: Competitive Interchanges are to be used for stocking purposes only. Where multiple crosses are identified, please reference the applications section of this catalog. / **Remarque importante:** Les interchanges concurrentiels ne s'utilisent qu'aux fins de stocks. Dans le cas de rferences multiples, consulter la section des applications du catalogue. / **Nota importante:** Dans le cas de rferences multiples, consulter la section des applications du catalogue. / **Nota importante:** Se pueden usar intercambios competitivos para propósitos de almacenamiento solamente. Cuando se identifican intercambios múltiples, consulte la sección de aplicaciones de este catálogo.

COMPETITIVE & O.E.M. INTERCHANGE LIST
Lista de Intercambios contra Competidores y Equipo Original.
Liste dinterchange de produits comptitifs & dquipement original (OEM)

AutoZone... cont'd

Autozone	Gabriel	Upgrade	Autozone	Gabriel	Upgrade	Autozone	Gabriel	Upgrade	Autozone	Gabriel	Upgrade
TS32-30002B	82076		TS33-31013B	81923		TS34-31342B	81931		TS34-32072B	81713	
TS32-30012B	69587		TS33-31181B	82147		TS34-31361B	81920		TS34-32081B	81750	
TS32-30022B	69590		TS33-31402B	81828		TS34-31371B	81912		TS34-32102B	81164	
TS32-30031B	81836		TS33-31452B	61656		TS34-31382B	81892		TS34-32111B	81039	
TS32-30041B	81516		TS33-31722B	69909		TS34-31391B	81744		TS34-32131B	81559	
TS32-30052B	81794		TS33-31741B	81932		TS34-31411B	81446		TS34-32141B	61546	
TS32-30072B	G64042		TS33-31852B	81910		TS34-31422B	81922		TS34-32152B	81510	
TS32-30082B	69589		TS33-31962B	69575		TS34-31422B	81925		TS34-32162B	61654	
TS32-30102B	81147		TS33-32351B	81113		TS34-31422B	81930		TS34-32172B	61614	
TS32-30112B	81481		TS33-32441B	G63782		TS34-31432B	81667		TS34-32202B	81492	
TS32-30141B	61662		TS33-32542B	81490		TS34-31441B	G63809		TS34-32252B	81496	
TS32-30141B	81507		TS33-32542B	81710		TS34-31462B	61717		TS34-32261B	81919	
TS32-30171B	G63614		TS33-32561B	81691		TS34-31481B	81893		TS34-32321B	81096	
TS32-30261B	81394		TS33-32573B	82007		TS34-31492B	81890		TS34-32423B	81242	
TS32-30302B	81459		TS33-32641B	81821		TS34-31521B	81933		TS34-32552B	81583	
TS32-30562B	82032		TS33-32813B	81484		TS34-31532B	81913		TS34-32632B	81825	
TS32-30872B	69592		TS33-32942B	G63781		TS34-31552B	G63892		TS34-32671B	81834	
TS32-32332B	81934		TS33-33032B	82003		TS34-31561B	61720		TS34-32772B	81891	
TS32-33951B	82005		TS33-33042B	81904		TS34-31611B	81916		TS34-32862B	81095	
TS32-33992B	82131		TS33-33412B	61582		TS34-31611B	81918		TS34-32911B	G64043	
TS32-34011B	82026		TS33-33581B	81675		TS34-31622B	81917		TS34-32952B	81823	
TS32-34032B	81469		TS33-33702B	81540		TS34-31632B	81926		TS34-33012B	G63837	
TS32-34032B	82065		TS33-33801B	81553		TS34-31641B	81869		TS34-33271B	81582	
TS32-34072B	82609		TS33-33931B	82104		TS34-31662B	81482		TS34-33382B	81837	
TS32-34092B	82155		TS33-33942B	82001		TS34-31672B	81082		TS34-34041B	81076	
TS32-34142B	82156		TS33-33981B	82090		TS34-31691B	81668		TS34-34061B	82087	
TS32-34172B	82066		TS33-34021B	82099		TS34-31702B	G64040		TS34-34111B	82118	
TS32-34222B	82004		TS33-34101B	82138		TS34-31732B	81878		TS34-34131B	82126	
TS32-34262B	82125		TS33-34321B	82072		TS34-31762B	70010		TS34-34152B	82051	
TS32-34341B	82035		TS33-34381B	82047		TS34-31772B	G63726		TS34-34192B	82060	
TS32-34352B	82086		TS33-34401B	82011		TS34-31802B	G63844		TS34-34201B	82601	
TS32-34422B	82103		TS33-34441B	82010		TS34-31822B	61704		TS34-34231B	82128	
TS33-30182B	81880		TS33-34472B	81416		TS34-31832B	81924		TS34-34241B	82079	
TS33-30241B	G64027		TS33-34532B	82130		TS34-31842B	81871		TS34-34281B	82070	
TS33-30252B	G64028		TS33-34641B	81153		TS34-31861B	81548		TS34-34301B	82075	
TS33-30411B	81478		TS33-34662B	82039		TS34-31872B	81549		TS34-34331B	81491	
TS33-30892B	81873		TS34-30953B	61506		TS34-31992B	61715		TS34-34391B	82109	
TS33-30892B	81928		TS34-30953B	81318		TS34-32002B	81937		TS34-34511B	82012	
TS33-30962B	69473		TS34-30953B	81440		TS34-32021B	81494		TS34-34541B	82110	
TS33-30971B	81914		TS34-31021B	81726		TS34-32031B	81936		TS34-34602B	82602	
TS33-31002B	81935		TS34-31231B	82034		TS34-32042B	81929		TS34-34682B	82618	
TS33-31013B	81560		TS34-31342B	81921		TS34-32052B	81833				

Avanti

Avanti	Gabriel	Upgrade	Avanti	Gabriel	Upgrade	Avanti	Gabriel	Upgrade	Avanti	Gabriel	Upgrade
88945169	69600		88945170	69604		88945188	69724				

BMW

Bmw	Gabriel	Upgrade	Bmw	Gabriel	Upgrade	Bmw	Gabriel	Upgrade	Bmw	Gabriel	Upgrade
31-31-6-750-792	G52237		31-31-6-786-022	G52143		33-52-1-095-913	69863		33-52-6-782-859	70045	
31-31-6-786-021	G52142		31-33-6-752-735	143082		33-52-1-096-366	69863				

BOGE

Boge	Gabriel	Upgrade	Boge	Gabriel	Upgrade	Boge	Gabriel	Upgrade	Boge	Gabriel	Upgrade
1034	69675		1557	69898		1575	69465		1674	G51874	
1534	82601		1558	G55825		1586	69473		1675	70027	
1541	69632		1567	69945		1624	G51799				
1551	82156		1569	G63776		1635	G51736				
1552	G63902		1571	G51279		1647	69592				
1553	G63907		1572	69464		1670	G51842				

Important Note: Competitive Interchanges are to be used for stocking purposes only. Where multiple crosses are identified, please reference the applications section of this catalog. / **Remarque importante:** Les interchanges concurrentiels ne s'utilisent qu'aux fins de stocks. Dans le cas de rferences multiples, consulter la section des applications du catalogue. / **Nota importante:** En el caso de rferencias mltiples, consultar la seccion de aplicaciones del catalogo. / **Nota importante:** Se pueden usar intercambios competitivos para propósitos de almacenamiento solamente. Cuando se identifican intercambios mltiples, consulte la seccion de aplicaciones de este catalogo.

COMPETITIVE & O.E.M. INTERCHANGE LIST
Lista de Intercambios contra Competidores y Equipo Original.
Liste dinterchange de produits comptitifs & dquipement original (OEM)

BOGE... cont'd

Boge	Gabriel	Upgrade	Boge	Gabriel	Upgrade	Boge	Gabriel	Upgrade	Boge	Gabriel	Upgrade
1680	70041		27-K65-A	G51811		34-508-0	77614		4985	G52245	
1683	70036		27-K66-A	G51810		35039	61525		4986	G52246	
1687	70003		27-M10-A	70036		35039	81039		4987	G51898	
1688	69591		28-B48-A	G63864		35054	81540		4990	70052	
1689	69587		30-E22-A	G51714		35059	61510		53-523-2	G63608	
1693	G51807		30-E23-A	G51713		35059	81871		83-202-5	69675	
1694	G51783		30-G50-A	69586		35063	61541		83-202-5	81494	
1697	G51863		30-H91-A	G52154		35063	81583		83-202-5	81582	
1698	70089		30-H92-A	G52155		35084	81342		83-202-5	81750	
1700	G51908		30-H93-A	G511054		35085	61632		83-203-4	82001	
1746	G51874		30-H94-A	G511055		35085	81825		83-203-4	82032	
1747	G511044		30-J09-A	G56633		35087	82065		83-205-7	81821	
1753	G51971		30-J10-A	G56634		35091	58489		83-214-1	82005	
2001	81394		32-A70-0	G44986		35091	61544		83-215-4	69465	
2002	81147		32-D14-F	69946		35091	77489		83-218-2	69606	
2006	G63495		32-G09-A	G51740		35091	81668		83-218-2	81514	
22003	14004		32-H73-A	G55896		35097	58422		83-221-9	61501	
22003	14005		32-K61-A	G52275		35115	58623		83-221-9	81478	
2501	G63386		32-K62-A	G52274		35115	81242		83-222-1	69632	
2502	G63907		32-P26-A	G52273		35257	58423		83-222-1	81459	
2504	G63349		32-P27-A	G52272		35257	58609		83-227-1	69845	
2505	G63355		32-P80-A	G56514		35257	61531		83-227-2	69675	
2506	G63414		32-P81-A	G56506		35257	77609		83-227-6	61529	
2507	G63717		32-Q85-A	70078		35257	81496		83-227-6	69625	
2516	G63377		32-R16-A	G52274		35257	81516		83-227-6	77375	
2519	G63488		32-R16-A	G52275		36-302-0	69677		83-227-6	81446	
2520	G63421		32-R17-A	G52274		36-A97-A	G56802		83-227-6	81541	
2521	G63896		32-R17-A	G52275		36-A97-F	G56802		83-227-6	81870	
2522	G63896		32-T45-A	G56819		36-G33-A	G52295		83-227-7	69574	
2525	G63662		32-T46-A	G56820		36-H61-0	70040		83-227-7	69575	
2526	G63673		32-T47-A	G56821		40-A85-0	85708		83-227-7	81495	
2527	G63424		32-T48-A	G56822		4503	G55526		83-227-8	82156	
2528	G63683		32-V34-A	G52374		4507	G56517		83-227-9	61501	
2529	G63423		32-V35-A	G52375		4510	G56516		83-227-9	81478	
2530	G63608		32001	81076		4550	G55948		83-228-0	81147	
2541	G64042		32001	82104		4589	G55697		83-228-6	81794	
2547	G63678		32002	81270		4596	G56606		83-229-5	G55825	
2548	G63607		32002	82004		46-A43-0	G51773		83-237-0	G51087	
2549	G63714		32003	81491		4607	G51268		83-239-5	69464	
2551	G63772		32003	82126		4608	G51267		83-239-5	81935	
2554	G63778		32022	82130		4619	G56620		83-241-9	61506	
2566	G63783		32025	69600		4689	G51737		83-241-9	81318	
2568	G63614		32036	82125		4717	G51738		83-243-0	69945	
2581	G63492		32051	81340		4719	G56899		83-243-0	81934	
2585	G63813		32067	82128		4797	G52081		83-243-8	61659	
2591	G63662		32091	81153		4798	G52082		83-243-8	61777	
27-B42-A	69901		32272	81446		4803	G52094		83-243-8	81924	
27-C08-F	69420		32276	81713		4804	G52095		83-245-4	G51279	
27-E03-A	69450		32277	81495		4830	G51859		83-249-8	69473	
27-F55-A	69473		32289	G63511		4831	G51859		83-251-3	69946	
27-G83-F	G51841		32305	81507		4836	G52006		83-251-4	69725	
27-H29-A	69585		32504	G63909		4837	G52005		83-252-8	69863	
27-J46-A	G51767		33-086-F	G51097		4838	G56887		83-253-2	G51881	
27-J46-A	G51910		33001	6802SE		4839	G56886		83-253-5	69450	
27-K42-A	70056		33002	6847SE		4859	G56842		83-254-2	G51799	
27-K42-S	70056		33005	6804SE		4860	G56843		83-254-6	69589	

Important Note: Competitive Interchanges are to be used for stocking purposes only. Where multiple crosses are identified, please reference the applications section of this catalog. / **Remarque importante:** Les interchanges concurrentiels ne s'utilisent qu'aux fins de stocks. Dans le cas de références multiples, consulter la section des applications du catalogue. / **Nota importante:** Dans le cas de referencias multiples, consultar la sección de aplicaciones del catálogo. / **Nota importante:** Se pueden usar intercambios competitivos para propósitos de almacenamiento solamente. Cuando se identifican intercambios múltiples, consulte la sección de aplicaciones de este catálogo.

COMPETITIVE & O.E.M. INTERCHANGE LIST
Lista de Intercambios contra Competidores y Equipo Original.
Liste d'interchange de produits compititifs & d'equipement original (OEM)

BOGE... cont'd

Boge	Gabriel	Upgrade	Boge	Gabriel	Upgrade	Boge	Gabriel	Upgrade	Boge	Gabriel	Upgrade
83-255-3	G51736		83-271-9	G51898		83-510-0	61642		83-518-7	81892	
83-255-6	G51841		83-272-0	70052		83-510-0	61691		83-518-7	81913	
83-255-8	69586		83-272-3	69590		83-510-0	81873		83-518-8	61626	
83-256-0	70086		83-273-6	70207		83-510-1	61634		83-518-9	61627	
83-256-4	70031		83-501-6	61521		83-510-1	61635		83-518-9	61629	
83-256-6	G51887		83-501-6	82012		83-510-1	81919		83-518-9	81918	
83-256-6	G51888		83-502-0	61500		83-510-1	81932		83-519-0	61680	
83-256-8	69592		83-502-0	61506		83-510-4	61535		83-519-0	77809	
83-256-8	69898		83-502-0	77907		83-510-4	61615		83-519-0	77837	
83-257-0	G51904		83-503-8	61524		83-510-4	81869		83-519-0	77951	
83-257-2	G51871		83-503-9	61525		83-510-4	81936		83-519-3	61536	
83-257-8	G51969		83-503-9	81039		83-510-5	61575		83-519-4	61625	
83-258-6	70039		83-505-3	61520		83-510-5	61664		83-519-5	61601	
83-258-7	70040		83-505-3	61546		83-510-5	61676		83-519-6	61658	
83-259-0	G51842		83-505-3	61561		83-510-5	61715		83-519-6	81923	
83-259-1	G51849		83-505-3	77414		83-510-5	81891		83-520-6	58817	
83-259-2	G51849		83-505-3	77455		83-510-6	61605		83-520-6	61641	
83-259-4	G51874		83-505-3	81394		83-510-6	81878		83-520-6	61663	
83-259-5	70027		83-505-3	81490		83-510-7	58622		83-520-6	77783	
83-260-1	70041		83-505-3	81553		83-510-7	58807		83-520-6	81920	
83-260-2	70060		83-505-3	81744		83-510-7	58929		83-520-6	81925	
83-260-4	70036		83-505-4	61518		83-510-7	61591		83-521-1	61710	
83-260-6	G51794		83-505-4	61530		83-510-7	77608		83-521-6	61600	
83-260-8	70003		83-505-4	61533		83-510-7	77614		83-522-2	61512	
83-260-9	69591		83-505-4	61547		83-510-7	77807		83-522-7	61552	
83-261-0	69587		83-505-4	61554		83-510-7	81744		83-523-1	61613	
83-261-4	G511092		83-505-4	61573		83-511-5	61595		83-523-1	81914	
83-261-5	G51783		83-505-4	61654		83-511-5	61646		83-523-3	61590	
83-261-8	G51863		83-505-4	61713		83-511-5	77623		83-523-3	81823	
83-261-9	70089		83-505-4	77461		83-511-5	81828		83-523-4	81318	
83-262-1	G51908		83-505-4	77525		83-511-5	81833		83-523-6	61662	
83-262-3	61504		83-505-4	81082		83-512-0	58357		83-523-7	61655	
83-262-3	81750		83-505-4	81510		83-512-0	61517		83-523-8	58810	
83-262-5	G63937		83-505-4	81710		83-512-1	58638		83-523-8	61656	
83-262-6	G63710		83-505-4	81730		83-512-1	61516		83-524-1	58662	
83-262-7	G63829		83-505-4	81905		83-512-1	61519		83-524-1	61600	
83-262-9	G63778		83-509-0	58359		83-512-1	61522		83-524-8	81928	
83-263-1	G63479		83-509-0	61523		83-512-1	61539		83-524-9	61692	
83-263-2	77494		83-509-0	81096		83-512-1	77454		83-524-9	61710	
83-263-3	G63454		83-509-0	81834		83-512-1	81484		87-286-A	142091	
83-263-4	G63679		83-509-1	58489		83-518-2	61623		87-375-R	142444	
83-263-5	81676		83-509-1	61544		83-518-2	61626		87-393-R	142651	
83-263-7	G63909		83-509-1	61555		83-518-2	77678		87-423-A	142653	
83-263-9	G63377		83-509-1	77489		83-518-2	81893		87-424-A	143191	
83-264-0	G63772		83-509-1	81668		83-518-2	81916		87-448-R	142230	
83-264-2	70038		83-509-2	61543		83-518-3	61624		87-462-R	142852	
83-267-3	G51934		83-509-2	81667		83-518-3	77607		87-482-A	142249	
83-267-4	G51934		83-509-3	61565		83-518-3	81890		88-237-A	142625	
83-268-5	70056		83-509-6	58421		83-518-4	58714		88-243-A	142419	
83-268-6	70040		83-509-6	61504		83-518-4	58808		88-248-A	143492	
83-268-7	G51874		83-509-7	58638		83-518-4	61611		88-471-R	142932	
83-268-8	G511044		83-509-7	61528		83-518-4	77714		88-472-R	142547	
83-269-4	G51971		83-509-7	61687		83-518-4	81912		88-473-R	142546	
83-270-8	G511142		83-509-7	81164		83-518-5	61614		88-595-A	142735	
83-271-0	G51990		83-509-7	81482		83-518-7	61612		88-597-R	143058	
83-271-3	G51905		83-509-9	61599		83-518-7	61638		88-624-A	143191	

Important Note: Competitive Interchanges are to be used for stocking purposes only. Where multiple crosses are identified, please reference the applications section of this catalog. / **Remarque importante:** Les interchanges concurrentiels ne s'utilisent qu'aux fins de stocks. Dans le cas de rfrences multiples, consulter la section des applications du catalogue. / **Nota importante:** Dans le cas de rfrences multiples, consulter la section des applications du catalogue. / **Nota importante:** Se pueden usar intercambios competitivos para propósitos de almacenamiento solamente. Cuando se identifican intercambios múltiples, consulte la sección de aplicaciones de este catálogo.

COMPETITIVE & O.E.M. INTERCHANGE LIST
Lista de Intercambios contra Competidores y Equipo Original.
Liste dinterchange de produits comptitifs & dquipement original (OEM)

BOGE... cont'd

Boge	Gabriel	Upgrade	Boge	Gabriel	Upgrade	Boge	Gabriel	Upgrade	Boge	Gabriel	Upgrade
88-709-A	143082		930040	61643		930084	G56807		930207	G64052	
88-716-R	143239		930040	77803		930085	G64012		930218	G511000	
88-994-A	143087		930040	81922		930089	G63845		950 002	G55697	
89-001-0	143057		930041	61675		930089	G64033		950 003	G56620	
89-001-0	143058		930041	61690		930090	61609		950 005	G55948	
89-018-0	143058		930041	77953		930091	G63878		950 006	G56778	
89-075-0	143058		930041	77976		930091	G63883		950 007	G56655	
930 041	58930		930042	G63776		930095	G51798		950 010	G56581	
930 159	G64151		930042	G63868		930095	G51884		950 011	G56582	
930001	G63915		930042	G63869		930105	61720		950 012	G52106	
930002	G63403		930043	G63907		930105	61734		950 012	G52108	
930003	77675		930044	G51766		930106	G64016		950 012	G56797	
930004	77949		930044	G63813		930107	G63890		950 013	G52105	
930004	77950		930045	G63492		930107	G63891		950 013	G52107	
930006	G63353		930045	G64031		930109	G51724		950 013	G56798	
930007	77847		930046	77905		930110	G51723		950 014	G56778	
930008	77683		930046	81836		930110	G51836		950 017	G56601	
930008	77829		930048	G63359		930113	G63879		950 018	G56568	
930008	81926		930048	G63661		930114	G63884		950 020	G51718	
930009	61616		930049	58944		930117	G63875		950 023	G56518	
930009	81929		930049	77673		930120	G51715		950 024	G56774	
930010	G51728		930049	77674		930130	G63299		950 025	G56773	
930011	G63844		930049	77947		930132	G63690		950 026	G56758	
930012	77661		930049	77967		930133	81917		950 027	G56759	
930012	77954		930050	G63410		930135	69813		950 028	G56799	
930013	61716		930050	G63614		930141	G56838		950 029	G56800	
930016	G63426		930051	77968		930142	G56839		950 034	G64049	
930016	G63690		930051	77969		930143	G64037		950 035	G56615	
930017	G63714		930052	77817		930144	G51853		950 036	G56616	
930018	77717		930053	G63355		930144	G51854		950 045	G52008	
930019	77772		930054	G51703		930145	G63889		950 045	G52170	
930020	77679		930055	G63870		930146	61714		950 046	G51739	
930022	77715		930056	G51704		930147	G51838		950 046	G57134	
930022	77808		930057	G63867		930148	G51838		950 047	G63885	
930023	G63406		930057	G64157		930151	G51879		950 047	G64029	
930023	G63409		930058	G51719		930153	70034		950 047	G64030	
930023	G63414		930060	G51729		930159	G64026		950 050	G52145	
930024	58809		930063	G63918		930160	G51848		950 055	G52009	
930025	G63716		930065	G64027		930161	G64056		950 055	G52171	
930026	77810		930066	G64028		930162	G64063		950 060	G51850	
930028	77524		930068	G51804		930163	G64050		950 061	G52144	
930029	G63676		930068	G51805		930165	G64089		950 062	G56518	
930029	G63873		930069	G64046		930166	G511004		950 064	G56841	
930030	77423		930072	69900		930167	G51993		950 065	G56840	
930031	77422		930073	61717		930170	G51928		950 068	G52188	
930032	G63349		930073	77971		930171	G51928		950 069	G52187	
930032	G63488		930074	61560		930189	G63872		950 070	G51815	
930033	77948		930074	81904		930191	G64031		950 071	G52295	
930034	58488		930075	61718		930192	G51766		950 073	G52199	
930034	77488		930077	61704		930197	G51880		950 074	G52200	
930035	G63675		930077	69909		930198	G51858		950 077	G51870	
930037	77638		930077	70010		930199	G51855		950 077	G51891	
930038	G63902		930078	G51286		930200	G64038		950 077	G51949	
930039	61506		930079	G64000		930203	G64008		950 078	G52007	
930039	81318		930081	G64001		930204	G63966		950 079	G52004	
930040	58803		930083	G63965		930205	70010		950 080	G52149	

Important Note: Competitive Interchanges are to be used for stocking purposes only. Where multiple crosses are identified, please reference the applications section of this catalog. / **Remarque importante:** Les interchanges concurrentiels ne s'utilisent qu'aux fins de stocks. Dans le cas de références multiples, consulter la section des applications du catalogue. / **Nota importante:** Dans le cas de referencias multiples, consultar la sección de aplicaciones del catálogo. / **Nota importante:** Se pueden usar intercambios competitivos para propósitos de almacenamiento solamente. Cuando se identifican intercambios múltiples, consulte la sección de aplicaciones de este catálogo.

COMPETITIVE & O.E.M. INTERCHANGE LIST
Lista de Intercambios contra Competidores y Equipo Original.
Liste dinterchange de produits comptitifs & dquipement original (OEM)

BOGE... cont'd

Boge	Gabriel	Upgrade	Boge	Gabriel	Upgrade	Boge	Gabriel	Upgrade	Boge	Gabriel	Upgrade
950 081	G52148		MP8035	G55526		MP8417	G51738		MP8537	G56886	
950 082	G52210		MP8122	G55698		MP8418	G51700		MP8538	G56810	
950 083	G52209		MP8142	G55579		MP8419	G56899		MP8539	G56810	
950 085	G52173		MP8168	G55909		MP8427	G51746		MP8542	G52276	
950 086	G52174		MP8169	G55910		MP8434	G52406		MP8553	G51810	
950 088	G52300		MP8172	G55856		MP8434	G56817		MP8553	G51859	
950 089	G52299		MP8215	G55856		MP8451	G56635		MP8553	G51896	
950 093	G52348		MP8225	G55697		MP8453	G56671		MP8554	G51811	
950 094	G52349		MP8226	G55681		MP8454	G56672		MP8554	G51859	
950 095	G52301		MP8241	G56606		MP8459	G56683		MP8554	G51897	
950 108	G52185		MP8259	G55892		MP8460	G56684		MP8557	G56842	
950 109	G52184		MP8264	G56517		MP8461	G51727		MP8558	G56843	
950 117	G52348		MP8265	G56516		MP8462	G56686		MP8563	G52117	
950 118	G52349		MP8273	G55949		MP8463	G56685		MP8564	G52118	
950 121	G52127		MP8274	G55948		MP8466	G52176		MP8565	G52382	
950 122	G52128		MP8294	G51267		MP8472	G56802		MP8566	G52383	
950 124	G52131		MP8295	G51254		MP8474	G56672		MP8575	G52172	
950 124	G64042		MP8295	G51268		MP8475	G56671		MP8579	G52142	
950 125	G52201		MP8305	G55901		MP8477	G52175		MP8580	G52143	
950 126	G52202		MP8308	G56620		MP8480	G55999		MP8611	G52297	
950 127	G52203		MP8321	G55896		MP8481	G55999		MP8612	G52298	
950 128	G52204		MP8324	G55870		MP8482	G55662		MP8619	G52276	
950 131	G52150		MP8338	G51097		MP8483	G55661		MP8620	G52275	
950 132	G52151		MP8359	G52333		MP8485	G56636		MP8621	G52274	
950 133	G52112		MP8360	G52334		MP8489	G51761		MP8640	G56889	
950 134	G52113		MP8365	G51740		MP8490	G51760		MP8641	G56888	
950 136	G52261		MP8368	G56750		MP8495	G52081		MP8642	G52104	
950 137	G52260		MP8369	G56751		MP8496	G52082		MP8643	G52103	
950 138	G52254		MP8374	G52165		MP8499	G52121		MP8655	G52152	
950 139	G52253		MP8375	G52164		MP8500	G52122		MP8656	G52153	
950 142	G52202		MP8389	G51737		MP8501	G52094		MP8681	G51877	
950 143	G52201		MP8390	G56622		MP8502	G52095		MP8682	G51878	
950 146	G52033		MP8391	G56621		MP8505	G56677		MP8683	G51892	
950 147	G52032		MP8392	G56792		MP8506	G56678		MP8684	G52246	
950 148	G52361		MP8402	G56722		MP8526	G52153		MP8685	G52245	
950 149	G52360		MP8403	G56721		MP8527	G52152		MP8686	G52256	
950 152	G51815		MP8404	G56729		MP8528	G52155		MP8687	G52255	
950 153	G52524		MP8405	G56728		MP8529	G52154		SK-003	143058	
950 154	G52525		MP8406	G52013		MP8531	G56894		SK-004	143059	
MP009	G55551		MP8406	G56660		MP8533	G52005		SK-006	143063	
MP122	G55698		MP8407	G52014		MP8534	G52006				
MP8020	G55991		MP8407	G56661		MP8536	G56887				

Classic Industries Catalog

Classic industries catalog	Gabriel	Upgrade	Classic industries catalog	Gabriel	Upgrade	Classic industries catalog	Gabriel	Upgrade	Classic industries catalog	Gabriel	Upgrade
61500	61500		61521	61521		61541	61541		61565	61565	
61501	61501		61522	61522		61542	61542		61573	61573	
61504	61504		61523	61523		61543	61543		61575	61575	
61506	61506		61524	61524		61544	61544		61582	61582	
61508	61508		61525	61525		61546	61546		61584	61584	
61509	61509		61528	61528		61547	61547		61590	61590	
61510	61510		61529	61529		61550	61550		61591	61591	
61512	61512		61530	61530		61552	61552		61592	61592	
61516	61516		61531	61531		61554	61554		61593	61593	
61517	61517		61533	61533		61555	61555				
61518	61518		61535	61535		61556	61556				
61519	61519		61536	61536		61560	61560				
61520	61520		61539	61539		61561	61561				

Important Note: Competitive Interchanges are to be used for stocking purposes only. Where multiple crosses are identified, please reference the applications section of this catalog. / **Remarque importante:** Les interchanges concurrentiels ne s'utilisent qu'aux fins de stocks. Dans le cas de rferences multiples, consulter la section des applications du catalogue. / **Nota importante:** Dans le cas de rferences multiples, consulter la section des applications du catalogue. / **Nota importante:** Se pueden usar intercambios competitivos para propósitos de almacenamiento solamente. Cuando se identifican intercambios múltiples, consulte la sección de aplicaciones de este catálogo.

COMPETITIVE & O.E.M. INTERCHANGE LIST
Lista de Intercambios contra Competidores y Equipo Original.
Liste dinterchange de produits comptitifs & dquipement original (OEM)

Classic Industries Catalog... cont'd

Classic industries catalog	Gabriel	Upgrade	Classic industries catalog	Gabriel	Upgrade	Classic industries catalog	Gabriel	Upgrade	Classic industries catalog	Gabriel	Upgrade
61595	61595		61711	61711		69909	69909		81095	81095	
61599	61599		61712	61712		69945	69945		81096	81096	
61600	61600		61713	61713		69946	69946		81113	81113	
61601	61601		61714	61714		69952	69952		81147	81147	
61605	61605		61715	61715		69962	69962		81153	81153	
61606	61606		61716	61716		69966	69966		81164	81164	
61608	61608		61717	61717		69996	69996		81242	81242	
61609	61609		61718	61718		69998	69998		81270	81270	
61611	61611		61720	61720		70000	70000		81318	81318	
61612	61612		61734	61734		70001	70001		81340	81340	
61613	61613		61777	61777		70003	70003		81342	81342	
61614	61614		69420	69420		70010	70010		81394	81394	
61615	61615		69450	69450		70013	70013		81416	81416	
61616	61616		69464	69464		70020	70020		81440	81440	
61623	61623		69465	69465		70024	70024		81446	81446	
61624	61624		69473	69473		70027	70027		81469	81469	
61625	61625		69574	69574		70028	70028		81478	81478	
61626	61626		69575	69575		70031	70031		81481	81481	
61627	61627		69585	69585		70033	70033		81482	81482	
61629	61629		69586	69586		70034	70034		81484	81484	
61632	61632		69587	69587		70036	70036		81490	81490	
61634	61634		69589	69589		70037	70037		81491	81491	
61635	61635		69590	69590		70038	70038		81492	81492	
61638	61638		69591	69591		70039	70039		81494	81494	
61641	61641		69592	69592		70040	70040		81495	81495	
61642	61642		69593	69593		70041	70041		81496	81496	
61643	61643		69594	69594		70045	70045		81507	81507	
61646	61646		69595	69595		70049	70049		81510	81510	
61651	61651		69600	69600		70052	70052		81514	81514	
61654	61654		69604	69604		70053	70053		81516	81516	
61655	61655		69606	69606		70055	70055		81540	81540	
61656	61656		69622	69622		70056	70056		81541	81541	
61658	61658		69624	69624		70059	70059		81548	81548	
61659	61659		69625	69625		70060	70060		81549	81549	
61662	61662		69632	69632		70064	70064		81553	81553	
61663	61663		69675	69675		70065	70065		81559	81559	
61664	61664		69676	69676		70068	70068		81560	81560	
61675	61675		69677	69677		70078	70078		81582	81582	
61676	61676		69714	69714		70086	70086		81583	81583	
61679	61679		69715	69715		70089	70089		81667	81667	
61680	61680		69724	69724		70095	70095		81668	81668	
61682	61682		69725	69725		70096	70096		81675	81675	
61683	61683		69755	69755		70098	70098		81676	81676	
61684	61684		69757	69757		70102	70102		81691	81691	
61685	61685		69766	69766		70203	70203		81710	81710	
61687	61687		69787	69787		70204	70204		81713	81713	
61690	61690		69795	69795		70207	70207		81726	81726	
61691	61691		69811	69811		70208	70208		81730	81730	
61692	61692		69813	69813		70209	70209		81744	81744	
61696	61696		69845	69845		70210	70210		81750	81750	
61697	61697		69863	69863		70213	70213		81794	81794	
61699	61699		69898	69898		70231	70231		81821	81821	
61700	61700		69900	69900		81039	81039		81823	81823	
61703	61703		69901	69901		81076	81076		81825	81825	
61704	61704		69903	69903		81082	81082		81828	81828	
61710	61710		69907	69907		81091	81091		81833	81833	

Important Note: Competitive Interchanges are to be used for stocking purposes only. Where multiple crosses are identified, please reference the applications section of this catalog. / **Remarque importante:** Les interchanges concurrentiels ne s'utilisent qu'aux fins de stocks. Dans le cas de références multiples, consulter la section des applications du catalogue. / **Nota importante:** Dans le cas de referencias multiples, consultar la section des applications du catalogue. / **Nota importante:** Se pueden usar intercambios competitivos para propósitos de almacenamiento solamente. Cuando se identifican intercambios múltiples, consulte la sección de aplicaciones de este catálogo.

COMPETITIVE & O.E.M. INTERCHANGE LIST
Lista de Intercambios contra Competidores y Equipo Original.
Liste d'interchange de produits compititifs & d'equipement original (OEM)

Classic Industries Catalog... cont'd

Classic industries catalog	Gabriel	Upgrade	Classic industries catalog	Gabriel	Upgrade	Classic industries catalog	Gabriel	Upgrade	Classic industries catalog	Gabriel	Upgrade
81834	81834		82039	82039		G511055	G511055		G51803	G51803	
81836	81836		82040	82040		G511078	G511078		G51804	G51804	
81837	81837		82047	82047		G511092	G511092		G51805	G51805	
81869	81869		82051	82051		G511122	G511122		G51806	G51806	
81870	81870		82060	82060		G511123	G511123		G51807	G51807	
81871	81871		82065	82065		G511134	G511134		G51812	G51812	
81872	81872		82066	82066		G511135	G511135		G51813	G51813	
81873	81873		82069	82069		G511142	G511142		G51814	G51814	
81878	81878		82070	82070		G51252	G51252		G51815	G51815	
81880	81880		82072	82072		G51254	G51254		G51825	G51825	
81890	81890		82075	82075		G51255	G51255		G51832	G51832	
81891	81891		82076	82076		G51256	G51256		G51833	G51833	
81892	81892		82079	82079		G51267	G51267		G51836	G51836	
81893	81893		82086	82086		G51268	G51268		G51838	G51838	
81904	81904		82087	82087		G51279	G51279		G51841	G51841	
81905	81905		82090	82090		G51286	G51286		G51842	G51842	
81910	81910		82099	82099		G51477	G51477		G51847	G51847	
81911	81911		82103	82103		G51700	G51700		G51848	G51848	
81912	81912		82104	82104		G51703	G51703		G51849	G51849	
81913	81913		82109	82109		G51704	G51704		G51850	G51850	
81914	81914		82110	82110		G51713	G51713		G51852	G51852	
81916	81916		82118	82118		G51714	G51714		G51853	G51853	
81917	81917		82125	82125		G51715	G51715		G51854	G51854	
81918	81918		82126	82126		G51716	G51716		G51855	G51855	
81919	81919		82128	82128		G51718	G51718		G51856	G51856	
81920	81920		82130	82130		G51719	G51719		G51858	G51858	
81921	81921		82131	82131		G51721	G51721		G51859	G51859	
81922	81922		82138	82138		G51722	G51722		G51860	G51860	
81923	81923		82147	82147		G51723	G51723		G51861	G51861	
81924	81924		82151	82151		G51724	G51724		G51863	G51863	
81925	81925		82155	82155		G51727	G51727		G51864	G51864	
81926	81926		82156	82156		G51728	G51728		G51865	G51865	
81927	81927		82601	82601		G51729	G51729		G51870	G51870	
81928	81928		82602	82602		G51736	G51736		G51871	G51871	
81929	81929		82609	82609		G51737	G51737		G51874	G51874	
81930	81930		82615	82615		G51738	G51738		G51877	G51877	
81931	81931		82618	82618		G51739	G51739		G51878	G51878	
81932	81932		G44461	G44461		G51740	G51740		G51879	G51879	
81933	81933		G44986	G44986		G51742	G51742		G51880	G51880	
81934	81934		G51077	G51077		G51746	G51746		G51881	G51881	
81935	81935		G51087	G51087		G51758	G51758		G51883	G51883	
81936	81936		G51097	G51097		G51759	G51759		G51884	G51884	
81937	81937		G511000	G511000		G51760	G51760		G51887	G51887	
82001	82001		G511001	G511001		G51761	G51761		G51888	G51888	
82003	82003		G511002	G511002		G51765	G51765		G51891	G51891	
82004	82004		G511003	G511003		G51766	G51766		G51892	G51892	
82005	82005		G511004	G511004		G51767	G51767		G51896	G51896	
82007	82007		G511007	G511007		G51772	G51772		G51897	G51897	
82010	82010		G511019	G511019		G51773	G51773		G51898	G51898	
82011	82011		G511020	G511020		G51774	G51774		G51899	G51899	
82012	82012		G511030	G511030		G51774	G51774		G51900	G51900	
82025	82025		G511037	G511037		G51783	G51783		G51901	G51901	
82026	82026		G511038	G511038		G51794	G51794		G51904	G51904	
82032	82032		G511043	G511043		G51795	G51795		G51905	G51905	
82034	82034		G511044	G511044		G51798	G51798		G51908	G51908	
82035	82035		G511054	G511054		G51799	G51799		G51908	G51908	
						G51802	G51802		G51910	G51910	

Important Note: Competitive Interchanges are to be used for stocking purposes only. Where multiple crosses are identified, please reference the applications section of this catalog. / **Remarque importante:** Les interchanges concurrentiels ne s'utilisent qu'aux fins de stocks. Dans le cas de rfrences multiples, consulter la section des applications du catalogue. / **Nota importante:** Dans le cas de rfrences multiples, consulter la section des applications du catalogue. / **Nota importante:** Se pueden usar intercambios competitivos para propósitos de almacenamiento solamente. Cuando se identifican intercambios múltiples, consulte la sección de aplicaciones de este catálogo.

COMPETITIVE & O.E.M. INTERCHANGE LIST
Lista de Intercambios contra Competidores y Equipo Original.
Liste dinterchange de produits comptitifs & dquipement original (OEM)

Classic Industries Catalog... cont'd

Classic industries catalog	Gabriel	Upgrade	Classic industries catalog	Gabriel	Upgrade	Classic industries catalog	Gabriel	Upgrade	Classic industries catalog	Gabriel	Upgrade
G51911	G51911		G52094	G52094		G52174	G52174		G52329	G52329	
G51914	G51914		G52095	G52095		G52175	G52175		G52330	G52330	
G51916	G51916		G52096	G52096		G52176	G52176		G52331	G52331	
G51917	G51917		G52097	G52097		G52182	G52182		G52332	G52332	
G51918	G51918		G52098	G52098		G52183	G52183		G52333	G52333	
G51919	G51919		G52103	G52103		G52184	G52184		G52334	G52334	
G51920	G51920		G52104	G52104		G52185	G52185		G52335	G52335	
G51921	G51921		G52105	G52105		G52187	G52187		G52336	G52336	
G51922	G51922		G52106	G52106		G52188	G52188		G52348	G52348	
G51925	G51925		G52107	G52107		G52199	G52199		G52349	G52349	
G51926	G51926		G52108	G52108		G52200	G52200		G52351	G52351	
G51928	G51928		G52110	G52110		G52201	G52201		G52352	G52352	
G51930	G51930		G52111	G52111		G52202	G52202		G52353	G52353	
G51933	G51933		G52112	G52112		G52203	G52203		G52354	G52354	
G51934	G51934		G52113	G52113		G52204	G52204		G52355	G52355	
G51937	G51937		G52116	G52116		G52209	G52209		G52356	G52356	
G51947	G51947		G52117	G52117		G52210	G52210		G52360	G52360	
G51948	G51948		G52118	G52118		G52237	G52237		G52361	G52361	
G51949	G51949		G52121	G52121		G52238	G52238		G52374	G52374	
G51955	G51955		G52122	G52122		G52244	G52244		G52375	G52375	
G51961	G51961		G52125	G52125		G52245	G52245		G52382	G52382	
G51965	G51965		G52127	G52127		G52246	G52246		G52383	G52383	
G51966	G51966		G52128	G52128		G52247	G52247		G52395	G52395	
G51969	G51969		G52129	G52129		G52248	G52248		G52396	G52396	
G51971	G51971		G52130	G52130		G52249	G52249		G52398	G52398	
G51972	G51972		G52131	G52131		G52250	G52250		G52399	G52399	
G51975	G51975		G52140	G52140		G52253	G52253		G52406	G52406	
G51980	G51980		G52141	G52141		G52254	G52254		G52410	G52410	
G51982	G51982		G52142	G52142		G52255	G52255		G52411	G52411	
G51983	G51983		G52143	G52143		G52256	G52256		G52435	G52435	
G51990	G51990		G52144	G52144		G52257	G52257		G52436	G52436	
G51992	G51992		G52145	G52145		G52258	G52258		G52437	G52437	
G51993	G51993		G52148	G52148		G52260	G52260		G52438	G52438	
G51994	G51994		G52149	G52149		G52261	G52261		G52439	G52439	
G51995	G51995		G52150	G52150		G52264	G52264		G52440	G52440	
G51996	G51996		G52151	G52151		G52265	G52265		G52449	G52449	
G52004	G52004		G52152	G52152		G52272	G52272		G52450	G52450	
G52005	G52005		G52153	G52153		G52273	G52273		G52494	G52494	
G52006	G52006		G52154	G52154		G52274	G52274		G52495	G52495	
G52007	G52007		G52155	G52155		G52275	G52275		G52524	G52524	
G52008	G52008		G52156	G52156		G52276	G52276		G52525	G52525	
G52009	G52009		G52157	G52157		G52278	G52278		G52906	G52906	
G52013	G52013		G52158	G52158		G52279	G52279		G52907	G52907	
G52014	G52014		G52159	G52159		G52280	G52280		G55526	G55526	
G52017	G52017		G52160	G52160		G52281	G52281		G55551	G55551	
G52018	G52018		G52161	G52161		G52282	G52282		G55579	G55579	
G52019	G52019		G52162	G52162		G52283	G52283		G55591	G55591	
G52025	G52025		G52163	G52163		G52293	G52293		G55661	G55661	
G52026	G52026		G52164	G52164		G52294	G52294		G55662	G55662	
G52027	G52027		G52165	G52165		G52295	G52295		G55675	G55675	
G52032	G52032		G52168	G52168		G52297	G52297		G55676	G55676	
G52033	G52033		G52169	G52169		G52298	G52298		G55681	G55681	
G52036	G52036		G52170	G52170		G52299	G52299		G55697	G55697	
G52037	G52037		G52171	G52171		G52300	G52300		G55698	G55698	
G52081	G52081		G52172	G52172		G52301	G52301		G55772	G55772	
G52082	G52082		G52173	G52173		G52314	G52314		G55774	G55774	

Important Note: Competitive Interchanges are to be used for stocking purposes only. Where multiple crosses are identified, please reference the applications section of this catalog. / **Remarque importante:** Les interchanges concurrentiels ne s'utilisent qu'aux fins de stocks. Dans le cas de références multiples, consulter la section des applications du catalogue. / **Nota importante:** Dans le cas de referencias multiples, consultar la sección de aplicaciones del catálogo. / **Nota importante:** Se pueden usar intercambios competitivos para propósitos de almacenamiento solamente. Cuando se identifican intercambios múltiples, consulte la sección de aplicaciones de este catálogo.

COMPETITIVE & O.E.M. INTERCHANGE LIST
Lista de Intercambios contra Competidores y Equipo Original.
Liste d'interchange de produits compititifs & d'equipement original (OEM)

Classic Industries Catalog... cont'd

Classic industries catalog	Gabriel	Upgrade	Classic industries catalog	Gabriel	Upgrade	Classic industries catalog	Gabriel	Upgrade	Classic industries catalog	Gabriel	Upgrade
G55804	G55804		G56641	G56641		G56842	G56842		G57017	G57017	
G55820	G55820		G56655	G56655		G56843	G56843		G57018	G57018	
G55821	G55821		G56660	G56660		G56886	G56886		G57019	G57019	
G55825	G55825		G56661	G56661		G56887	G56887		G57020	G57020	
G55856	G55856		G56671	G56671		G56892	G56892		G57021	G57021	
G55870	G55870		G56672	G56672		G56893	G56893		G57022	G57022	
G55879	G55879		G56679	G56679		G56894	G56894		G57023	G57023	
G55892	G55892		G56680	G56680		G56899	G56899		G57026	G57026	
G55896	G55896		G56683	G56683		G56924	G56924		G57027	G57027	
G55901	G55901		G56684	G56684		G56925	G56925		G57030	G57030	
G55909	G55909		G56685	G56685		G56927	G56927		G57031	G57031	
G55910	G55910		G56686	G56686		G56928	G56928		G57032	G57032	
G55911	G55911		G56687	G56687		G56929	G56929		G57033	G57033	
G55948	G55948		G56688	G56688		G56930	G56930		G57034	G57034	
G55949	G55949		G56700	G56700		G56931	G56931		G57035	G57035	
G55991	G55991		G56701	G56701		G56932	G56932		G57036	G57036	
G55993	G55993		G56718	G56718		G56933	G56933		G57037	G57037	
G55994	G55994		G56721	G56721		G56934	G56934		G57038	G57038	
G55999	G55999		G56722	G56722		G56935	G56935		G57039	G57039	
G56506	G56506		G56726	G56726		G56936	G56936		G57040	G57040	
G56509	G56509		G56728	G56728		G56937	G56937		G57041	G57041	
G56512	G56512		G56729	G56729		G56938	G56938		G57042	G57042	
G56513	G56513		G56730	G56730		G56943	G56943		G57043	G57043	
G56514	G56514		G56731	G56731		G56948	G56948		G57044	G57044	
G56516	G56516		G56732	G56732		G56949	G56949		G57045	G57045	
G56517	G56517		G56733	G56733		G56950	G56950		G57046	G57046	
G56518	G56518		G56734	G56734		G56951	G56951		G57047	G57047	
G56529	G56529		G56735	G56735		G56956	G56956		G57048	G57048	
G56530	G56530		G56750	G56750		G56957	G56957		G57049	G57049	
G56537	G56537		G56751	G56751		G56962	G56962		G57050	G57050	
G56538	G56538		G56758	G56758		G56963	G56963		G57051	G57051	
G56539	G56539		G56759	G56759		G56964	G56964		G57053	G57053	
G56540	G56540		G56773	G56773		G56965	G56965		G57054	G57054	
G56561	G56561		G56774	G56774		G56973	G56973		G57055	G57055	
G56562	G56562		G56778	G56778		G56974	G56974		G57056	G57056	
G56565	G56565		G56791	G56791		G56975	G56975		G57057	G57057	
G56568	G56568		G56792	G56792		G56991	G56991		G57058	G57058	
G56571	G56571		G56797	G56797		G56992	G56992		G57059	G57059	
G56581	G56581		G56798	G56798		G56993	G56993		G57060	G57060	
G56582	G56582		G56799	G56799		G56994	G56994		G57061	G57061	
G56591	G56591		G56800	G56800		G56995	G56995		G57062	G57062	
G56597	G56597		G56802	G56802		G56996	G56996		G57063	G57063	
G56598	G56598		G56807	G56807		G56997	G56997		G57064	G57064	
G56601	G56601		G56809	G56809		G56998	G56998		G57065	G57065	
G56606	G56606		G56810	G56810		G57000	G57000		G57066	G57066	
G56615	G56615		G56817	G56817		G57005	G57005		G57067	G57067	
G56616	G56616		G56819	G56819		G57006	G57006		G57068	G57068	
G56620	G56620		G56820	G56820		G57007	G57007		G57069	G57069	
G56621	G56621		G56821	G56821		G57008	G57008		G57070	G57070	
G56622	G56622		G56822	G56822		G57010	G57010		G57071	G57071	
G56633	G56633		G56836	G56836		G57011	G57011		G57072	G57072	
G56634	G56634		G56837	G56837		G57012	G57012		G57075	G57075	
G56635	G56635		G56838	G56838		G57013	G57013		G57076	G57076	
G56636	G56636		G56839	G56839		G57014	G57014		G57077	G57077	
G56637	G56637		G56840	G56840		G57015	G57015		G57078	G57078	
G56640	G56640		G56841	G56841		G57016	G57016		G57079	G57079	

Important Note: Competitive Interchanges are to be used for stocking purposes only. Where multiple crosses are identified, please reference the applications section of this catalog./ **Remarque importante:** Les interchanges concurrentiels ne s'utilisent qu'aux fins de stocks. **Dans le cas de rferences multiples, consulter la section des applications du catalogue./** **Nota importante:** Dans le cas de rferences multiples, consulter la section des applications du catalogue./ **Nota importante:** Se pueden usar intercambios competitivos para propósitos de almacenamiento solamente. Cuando se identifican intercambios múltiples, consulte la sección de aplicaciones de este catálogo.

COMPETITIVE & O.E.M. INTERCHANGE LIST
Lista de Intercambios contra Competidores y Equipo Original.
Liste dinterchange de produits comptitifs & dquipement original (OEM)

Classic Industries Catalog... cont'd

Classic industries catalog	Gabriel	Upgrade	Classic industries catalog	Gabriel	Upgrade	Classic industries catalog	Gabriel	Upgrade	Classic industries catalog	Gabriel	Upgrade
G57080	G57080		G57144	G57144		G57270	G57270		G57393	G57393	
G57081	G57081		G57145	G57145		G57271	G57271		G57394	G57394	
G57082	G57082		G57146	G57146		G57274	G57274		G57397	G57397	
G57083	G57083		G57147	G57147		G57275	G57275		G57398	G57398	
G57084	G57084		G57148	G57148		G57276	G57276		G57399	G57399	
G57085	G57085		G57149	G57149		G57277	G57277		G57400	G57400	
G57086	G57086		G57150	G57150		G57278	G57278		G57401	G57401	
G57087	G57087		G57151	G57151		G57279	G57279		G57404	G57404	
G57088	G57088		G57152	G57152		G57282	G57282		G57405	G57405	
G57089	G57089		G57153	G57153		G57314	G57314		G57409	G57409	
G57090	G57090		G57156	G57156		G57322	G57322		G57413	G57413	
G57091	G57091		G57157	G57157		G57323	G57323		G57414	G57414	
G57092	G57092		G57158	G57158		G57324	G57324		G57415	G57415	
G57095	G57095		G57159	G57159		G57329	G57329		G57416	G57416	
G57096	G57096		G57160	G57160		G57330	G57330		G57417	G57417	
G57097	G57097		G57161	G57161		G57331	G57331		G57418	G57418	
G57098	G57098		G57162	G57162		G57332	G57332		G57419	G57419	
G57099	G57099		G57163	G57163		G57333	G57333		G57420	G57420	
G57100	G57100		G57164	G57164		G57334	G57334		G57421	G57421	
G57103	G57103		G57167	G57167		G57335	G57335		G57422	G57422	
G57105	G57105		G57168	G57168		G57336	G57336		G57423	G57423	
G57106	G57106		G57172	G57172		G57337	G57337		G57424	G57424	
G57107	G57107		G57173	G57173		G57338	G57338		G57425	G57425	
G57108	G57108		G57176	G57176		G57339	G57339		G57427	G57427	
G57109	G57109		G57177	G57177		G57340	G57340		G57428	G57428	
G57110	G57110		G57178	G57178		G57341	G57341		G57429	G57429	
G57111	G57111		G57184	G57184		G57342	G57342		G57437	G57437	
G57112	G57112		G57185	G57185		G57343	G57343		G57441	G57441	
G57113	G57113		G57190	G57190		G57344	G57344		G57442	G57442	
G57114	G57114		G57191	G57191		G57345	G57345		G57444	G57444	
G57115	G57115		G57192	G57192		G57346	G57346		G57447	G57447	
G57118	G57118		G57193	G57193		G57349	G57349		G57449	G57449	
G57119	G57119		G57194	G57194		G57350	G57350		G57450	G57450	
G57120	G57120		G57195	G57195		G57353	G57353		G57451	G57451	
G57121	G57121		G57197	G57197		G57354	G57354		G57452	G57452	
G57122	G57122		G57198	G57198		G57357	G57357		G57453	G57453	
G57123	G57123		G57200	G57200		G57358	G57358		G57454	G57454	
G57124	G57124		G57201	G57201		G57359	G57359		G57455	G57455	
G57125	G57125		G57202	G57202		G57360	G57360		G57456	G57456	
G57126	G57126		G57203	G57203		G57361	G57361		G57457	G57457	
G57127	G57127		G57204	G57204		G57362	G57362		G57458	G57458	
G57128	G57128		G57205	G57205		G57363	G57363		G57459	G57459	
G57129	G57129		G57206	G57206		G57364	G57364		G57460	G57460	
G57130	G57130		G57207	G57207		G57367	G57367		G57463	G57463	
G57131	G57131		G57208	G57208		G57368	G57368		G57464	G57464	
G57132	G57132		G57212	G57212		G57369	G57369		G57465	G57465	
G57133	G57133		G57218	G57218		G57370	G57370		G57466	G57466	
G57134	G57134		G57219	G57219		G57372	G57372		G57471	G57471	
G57135	G57135		G57220	G57220		G57373	G57373		G57472	G57472	
G57136	G57136		G57221	G57221		G57375	G57375		G57473	G57473	
G57137	G57137		G57222	G57222		G57376	G57376		G57474	G57474	
G57138	G57138		G57223	G57223		G57377	G57377		G57477	G57477	
G57139	G57139		G57266	G57266		G57378	G57378		G57478	G57478	
G57140	G57140		G57267	G57267		G57390	G57390		G57479	G57479	
G57141	G57141		G57268	G57268		G57391	G57391		G57480	G57480	
G57142	G57142		G57269	G57269		G57392	G57392		G57481	G57481	

Important Note: Competitive Interchanges are to be used for stocking purposes only. Where multiple crosses are identified, please reference the applications section of this catalog. / **Remarque importante:** Les interchanges concurrentiels ne s'utilisent qu'aux fins de stocks. Dans le cas de références multiples, consulter la section des applications du catalogue. / **Nota importante:** Dans le cas de referencias multiples, consultar la sección de aplicaciones del catálogo. / **Nota importante:** Se pueden usar intercambios competitivos para propósitos de almacenamiento solamente. Cuando se identifican intercambios múltiples, consulte la sección de aplicaciones de este catálogo.

COMPETITIVE & O.E.M. INTERCHANGE LIST
Lista de Intercambios contra Competidores y Equipo Original.
Liste d'interchange de produits compititifs & d'equipement original (OEM)

Classic Industries Catalog... cont'd

Classic industries catalog	Gabriel	Upgrade	Classic industries catalog	Gabriel	Upgrade	Classic industries catalog	Gabriel	Upgrade	Classic industries catalog	Gabriel	Upgrade
G57482	G57482		G57577	G57577		G57689	G57689		G57753	G57753	
G57483	G57483		G57578	G57578		G57690	G57690		G57754	G57754	
G57484	G57484		G57579	G57579		G57691	G57691		G57755	G57755	
G57487	G57487		G57582	G57582		G57692	G57692		G57756	G57756	
G57488	G57488		G57583	G57583		G57693	G57693		G57757	G57757	
G57489	G57489		G57586	G57586		G57694	G57694		G57758	G57758	
G57490	G57490		G57587	G57587		G57695	G57695		G57759	G57759	
G57493	G57493		G57594	G57594		G57696	G57696		G57764	G57764	
G57494	G57494		G57595	G57595		G57697	G57697		G57765	G57765	
G57495	G57495		G57597	G57597		G57698	G57698		G57768	G57768	
G57496	G57496		G57598	G57598		G57699	G57699		G57769	G57769	
G57497	G57497		G57599	G57599		G57700	G57700		G57772	G57772	
G57498	G57498		G57600	G57600		G57701	G57701		G57773	G57773	
G57499	G57499		G57601	G57601		G57702	G57702		G57774	G57774	
G57500	G57500		G57602	G57602		G57703	G57703		G57775	G57775	
G57509	G57509		G57603	G57603		G57704	G57704		G57776	G57776	
G57510	G57510		G57604	G57604		G57705	G57705		G57777	G57777	
G57515	G57515		G57605	G57605		G57706	G57706		G57778	G57778	
G57516	G57516		G57606	G57606		G57709	G57709		G57779	G57779	
G57517	G57517		G57607	G57607		G57710	G57710		G57780	G57780	
G57518	G57518		G57608	G57608		G57711	G57711		G57781	G57781	
G57521	G57521		G57609	G57609		G57712	G57712		G57782	G57782	
G57522	G57522		G57612	G57612		G57713	G57713		G57783	G57783	
G57523	G57523		G57613	G57613		G57714	G57714		G57784	G57784	
G57524	G57524		G57614	G57614		G57715	G57715		G57785	G57785	
G57533	G57533		G57615	G57615		G57716	G57716		G57786	G57786	
G57534	G57534		G57628	G57628		G57717	G57717		G57790	G57790	
G57535	G57535		G57629	G57629		G57720	G57720		G57791	G57791	
G57536	G57536		G57634	G57634		G57721	G57721		G57792	G57792	
G57539	G57539		G57635	G57635		G57722	G57722		G57793	G57793	
G57540	G57540		G57640	G57640		G57723	G57723		G57794	G57794	
G57541	G57541		G57641	G57641		G57724	G57724		G57795	G57795	
G57542	G57542		G57642	G57642		G57725	G57725		G57796	G57796	
G57543	G57543		G57643	G57643		G57726	G57726		G57799	G57799	
G57544	G57544		G57644	G57644		G57727	G57727		G57800	G57800	
G57545	G57545		G57645	G57645		G57730	G57730		G57801	G57801	
G57546	G57546		G57646	G57646		G57731	G57731		G57802	G57802	
G57549	G57549		G57647	G57647		G57732	G57732		G57803	G57803	
G57550	G57550		G57648	G57648		G57733	G57733		G57804	G57804	
G57558	G57558		G57649	G57649		G57734	G57734		G57812	G57812	
G57559	G57559		G57650	G57650		G57735	G57735		G57816	G57816	
G57560	G57560		G57651	G57651		G57738	G57738		G57817	G57817	
G57561	G57561		G57658	G57658		G57739	G57739		G57818	G57818	
G57562	G57562		G57659	G57659		G57740	G57740		G57819	G57819	
G57563	G57563		G57663	G57663		G57741	G57741		G57820	G57820	
G57564	G57564		G57664	G57664		G57742	G57742		G57825	G57825	
G57565	G57565		G57665	G57665		G57743	G57743		G63173	G63173	
G57566	G57566		G57666	G57666		G57744	G57744		G63183	G63183	
G57567	G57567		G57673	G57673		G57745	G57745		G63299	G63299	
G57568	G57568		G57674	G57674		G57746	G57746		G63306	G63306	
G57569	G57569		G57675	G57675		G57747	G57747		G63347	G63347	
G57572	G57572		G57676	G57676		G57748	G57748		G63349	G63349	
G57573	G57573		G57677	G57677		G57749	G57749		G63350	G63350	
G57574	G57574		G57680	G57680		G57750	G57750		G63353	G63353	
G57575	G57575		G57682	G57682		G57751	G57751		G63355	G63355	
G57576	G57576		G57683	G57683		G57752	G57752		G63357	G63357	

Important Note: Competitive Interchanges are to be used for stocking purposes only. Where multiple crosses are identified, please reference the applications section of this catalog./ **Remarque importante:** Les interchanges concurrentiels ne s'utilisent qu'aux fins de stocks. Dans le cas de rferences multiples, consulter la section des applications du catalogue./ **Nota importante:** Dans le cas de rferences multiples, consulter la section des applications du catalogue./ **Nota importante:** Se pueden usar intercambios competitivos para propósitos de almacenamiento solamente. Cuando se identifican intercambios múltiples, consulte la sección de aplicaciones de este catálogo.

COMPETITIVE & O.E.M. INTERCHANGE LIST
Lista de Intercambios contra Competidores y Equipo Original.
Liste dinterchange de produits comptitifs & dquipement original (OEM)

Classic Industries Catalog... cont'd

Classic industries catalog	Gabriel	Upgrade	Classic industries catalog	Gabriel	Upgrade	Classic industries catalog	Gabriel	Upgrade	Classic industries catalog	Gabriel	Upgrade
G63359	G63359		G63622	G63622		G63845	G63845		G64003	G64003	
G63360	G63360		G63623	G63623		G63847	G63847		G64006	G64006	
G63366	G63366		G63624	G63624		G63848	G63848		G64008	G64008	
G63375	G63375		G63625	G63625		G63860	G63860		G64009	G64009	
G63377	G63377		G63635	G63635		G63862	G63862		G64010	G64010	
G63386	G63386		G63638	G63638		G63864	G63864		G64011	G64011	
G63387	G63387		G63661	G63661		G63866	G63866		G64012	G64012	
G63394	G63394		G63662	G63662		G63867	G63867		G64013	G64013	
G63403	G63403		G63671	G63671		G63868	G63868		G64014	G64014	
G63404	G63404		G63673	G63673		G63869	G63869		G64015	G64015	
G63405	G63405		G63674	G63674		G63870	G63870		G64016	G64016	
G63409	G63409		G63675	G63675		G63872	G63872		G64026	G64026	
G63410	G63410		G63676	G63676		G63873	G63873		G64027	G64027	
G63411	G63411		G63678	G63678		G63875	G63875		G64028	G64028	
G63413	G63413		G63679	G63679		G63878	G63878		G64029	G64029	
G63414	G63414		G63683	G63683		G63879	G63879		G64030	G64030	
G63418	G63418		G63689	G63689		G63882	G63882		G64031	G64031	
G63419	G63419		G63690	G63690		G63883	G63883		G64032	G64032	
G63421	G63421		G63692	G63692		G63884	G63884		G64033	G64033	
G63422	G63422		G63694	G63694		G63885	G63885		G64037	G64037	
G63423	G63423		G63707	G63707		G63886	G63886		G64038	G64038	
G63424	G63424		G63708	G63708		G63888	G63888		G64040	G64040	
G63425	G63425		G63710	G63710		G63889	G63889		G64042	G64042	
G63426	G63426		G63712	G63712		G63890	G63890		G64043	G64043	
G63432	G63432		G63714	G63714		G63891	G63891		G64044	G64044	
G63443	G63443		G63715	G63715		G63892	G63892		G64046	G64046	
G63454	G63454		G63716	G63716		G63893	G63893		G64047	G64047	
G63455	G63455		G63717	G63717		G63894	G63894		G64048	G64048	
G63456	G63456		G63720	G63720		G63895	G63895		G64049	G64049	
G63461	G63461		G63721	G63721		G63896	G63896		G64050	G64050	
G63479	G63479		G63722	G63722		G63897	G63897		G64052	G64052	
G63488	G63488		G63726	G63726		G63902	G63902		G64056	G64056	
G63489	G63489		G63772	G63772		G63903	G63903		G64063	G64063	
G63490	G63490		G63773	G63773		G63904	G63904		G64071	G64071	
G63492	G63492		G63775	G63775		G63905	G63905		G64079	G64079	
G63494	G63494		G63776	G63776		G63907	G63907		G64080	G64080	
G63495	G63495		G63778	G63778		G63909	G63909		G64087	G64087	
G63506	G63506		G63781	G63781		G63915	G63915		G64089	G64089	
G63510	G63510		G63782	G63782		G63918	G63918		G64101	G64101	
G63511	G63511		G63783	G63783		G63928	G63928		G64104	G64104	
G63524	G63524		G63799	G63799		G63929	G63929		G64111	G64111	
G63525	G63525		G63803	G63803		G63937	G63937		G64121	G64121	
G63547	G63547		G63808	G63808		G63950	G63950		G64140	G64140	
G63548	G63548		G63809	G63809		G63958	G63958		G64143	G64143	
G63604	G63604		G63810	G63810		G63959	G63959		G64146	G64146	
G63605	G63605		G63813	G63813		G63961	G63961		G64148	G64148	
G63607	G63607		G63815	G63815		G63962	G63962		G64151	G64151	
G63608	G63608		G63817	G63817		G63965	G63965		G64157	G64157	
G63609	G63609		G63818	G63818		G63966	G63966		G64163	G64163	
G63610	G63610		G63828	G63828		G63967	G63967		G64164	G64164	
G63611	G63611		G63829	G63829		G63969	G63969		G64177	G64177	
G63614	G63614		G63832	G63832		G63971	G63971		G64186	G64186	
G63615	G63615		G63837	G63837		G64000	G64000		G64216	G64216	
G63616	G63616		G63842	G63842		G64001	G64001		G64268	G64268	
G63620	G63620		G63844	G63844		G64002	G64002		G64269	G64269	

Important Note: Competitive Interchanges are to be used for stocking purposes only. Where multiple crosses are identified, please reference the applications section of this catalog. / **Remarque importante:** Les interchanges concurrentiels ne s'utilisent qu'aux fins de stocks. Dans le cas de rferences multiples, consulter la section des applications du catalogue. / **Nota importante:** Dans le cas de rferences multiples, consulter la section des applications du catalogue. / **Nota importante:** Se pueden usar intercambios competitivos para propósitos de almacenamiento solamente. Cuando se identifican intercambios múltiples, consulte la sección de aplicaciones de este catálogo.

COMPETITIVE & O.E.M. INTERCHANGE LIST
Lista de Intercambios contra Competidores y Equipo Original.
Liste dinterchange de produits compititifs & dquipement original (OEM)

DriveTech

Drivetech	Gabriel	Upgrade	Drivetech	Gabriel	Upgrade	Drivetech	Gabriel	Upgrade	Drivetech	Gabriel	Upgrade
D234039	M55848		D341302	81893		D344079	81905		D344374	81892	
D234040	M55848		D343127	81494		D344079	81918		D344375	81913	
D235058	M55921		D343130	81514		D344080	81878		D344376	81919	
D235059	M55920		D343135	81495		D344081	81713		D344378	81923	
D235621	M55693		D343156	81491		D344083	81582		D344379	81923	
D235626	M55896		D343157	81492		D344085	81484		D344380	81920	
D235627	M55892		D343209	81541		D344087	81484		D344381	81922	
D236003	M56708		D343218	81880		D344088	81548		D344383	81925	
D236007	M56718		D343280	81934		D344094	81559		D344385	81931	
D323247	81904		D343290	81935		D344096	81560		D344386	81921	
D334150	M55912		D343388	81910		D344266	81726		D344396	81917	
D334151	M55913		D344015	82066		D344267	81821		D344397	81916	
D334170	M56502		D344040	81750		D344269	81823		D344398	81933	
D334171	M56502		D344041	81482		D344269	81890		D344399	81932	
D334188	M55697		D344042	81516		D344299	81911		D344418	81549	
D334229	M55974		D344049	81490		D344338	81924		D344428	81871	
D334230	M55975		D344049	81836		D344365	81873		D344430	81872	
D334294	M55901		D344051	81540		D344367	81912		D344433	81794	
D334295	M56501		D344052	82125		D344368	81914		D344434	81927	
D341012	82156		D344077	81082		D344369	81833		D344437	81930	
D341117	M55877		D344077	81510		D344371	81828				
D341118	M55877		D344077	81710		D344372	81928				

FCS

Fcs	Gabriel	Upgrade	Fcs	Gabriel	Upgrade	Fcs	Gabriel	Upgrade	Fcs	Gabriel	Upgrade
1331008L	G57510		1331604L	G57105		1331630L	G57084		1331734	G57141	
1331008R	G57509		1331604L	G57350		1331630R	G57085		1331745L	G57341	
1331048L	G57278		1331604R	G57106		1331631L	G57084		1331745R	G57342	
1331048R	G57279		1331604R	G57349		1331631R	G57085		1331746L	G57477	
1331060L	G57167		1331605L	G57130		1331632L	G57222		1331746R	G57478	
1331060R	G57168		1331605R	G57131		1331632R	G57223		1331747L	G57460	
1331089	G57397		1331607L	G57192		1331634L	G57333		1331747R	G57459	
1331301L	G57114		1331607R	G57193		1331634R	G57334		1331750L	G57641	
1331520L	G57203		1331610R	G57574		1331642L	G57558		1331750R	G57640	
1331520R	G57202		1331612L	G57152		1331642R	G57559		1331751L	G57641	
1331573L	G57037		1331612R	G57153		1331645L	G57144		1331751R	G57640	
1331573R	G57038		1331613L	G57533		1331645R	G57145		1331752L	G57460	
1331579L	G57275		1331613R	G57534		1331646L	G57184		1331753L	G57460	
1331579R	G57276		1331614L	G57651		1331646R	G57185		1331753R	G57641	
1331581	G57274		1331614R	G57650		1331648L	G57200		1331758L	G57345	
1331582L	G57190		1331617L	G57357		1331648R	G57201		1331758R	G57346	
1331582R	G57191		1331617R	G57358		1331660L	G57150		1331759L	G57515	
1331584L	G57110		1331620L	G57404		1331660L	G57615		1331759R	G57516	
1331584R	G57111		1331620R	G57405		1331660R	G57151		1331760L	G57366	
1331588L	G57098		1331621L	G57444		1331660R	G57614		1331760R	G57365	
1331588R	G57097		1331621R	G57444		1331685L	G57112		1331762L	G57339	
1331590L	G57651		1331622L	G57204		1331685R	G57113		1331762R	G57340	
1331590R	G57650		1331622R	G57205		1331688L	G57583		1331763L	G57341	
1331595L	G57119		1331625L	G57666		1331688R	G57282		1331763R	G57342	
1331595L	G57606		1331625R	G57665		1331697L	G57608		1331765L	G57643	
1331595R	G57120		1331626L	G57664		1331697R	G57609		1331765R	G57642	
1331595R	G57605		1331626R	G57663		1331701L	G57608		1331766L	G57643	
1331596L	G57157		1331628L	G57372		1331701R	G57609		1331766R	G57642	
1331596R	G57158		1331628L	G57375		1331702L	G57489		1331767L	G57635	
1331597L	G57163		1331628R	G57373		1331702R	G57490				
1331597R	G57164		1331628R	G57376		1331715L	G57560				
1331601L	G57114		1331629L	G57391		1331715R	G57561				
1331601R	G57115		1331629R	G57390		1331733	G57051				

Important Note: Competitive Interchanges are to be used for stocking purposes only. Where multiple crosses are identified, please reference the applications section of this catalog./ **Remarque importante:** Les interchanges concurrentiels ne s'utilisent qu'aux fins de stocks. Dans le cas de rferences multiples, consulter la section des applications du catalogue./ **Nota importante:** Dans le cas de rferences multiples, consulter la section des applications du catalogue./ **Nota importante:** Se pueden usar intercambios competitivos para propósitos de almacenamiento solamente. Cuando se identifican intercambios múltiples, consulte la sección de aplicaciones de este catálogo.

COMPETITIVE & O.E.M. INTERCHANGE LIST
Lista de Intercambios contra Competidores y Equipo Original.
Liste d'interchange de produits complitifs & d'equipement original (OEM)

FCS... cont'd

Fcs	Gabriel	Upgrade	Fcs	Gabriel	Upgrade	Fcs	Gabriel	Upgrade	Fcs	Gabriel	Upgrade
1331767R	G57634		1332319L	G56956		1332369R	G57044		1333395R	G57565	
1331775L	G57369		1332319R	G56957		1333270L	G57069		1333402L	G57266	
1331775R	G57370		1332320	G56951		1333270L	G57121		1333402R	G57267	
1331778L	G57312		1332322L	G56962		1333270R	G57070		1333404	G57109	
1331778R	G57311		1332322R	G56963		1333270R	G57122		1333404	G57314	
1331783L	G57193		1332323L	G56948		1333271L	G57473		1333406L	G57465	
1331783R	G57192		1332323R	G56948		1333271R	G57474		1333406R	G57466	
1331785L	G57152		1332324L	G56949		1333283L	G57473		1333412L	G57566	
1331785L	G57533		1332324R	G56950		1333283R	G57474		1333412R	G57567	
1331785R	G57153		1332326L	G56924		1333290	G57099		1333414L	G57377	
1331785R	G57534		1332326R	G56925		1333290	G57100		1333414R	G57378	
1331786L	G57613		1332327	G57060		1333291L	G57137		1333415L	G57377	
1331786R	G57612		1332328L	G56973		1333291R	G57138		1333415R	G57378	
1331789L	G57176		1332328R	G56974		1333296L	G57330		1333426L	G57494	
1331789L	G57464		1332334	G56975		1333296R	G57329		1333426R	G57493	
1331789R	G57177		1332335	G56965		1333298	G57040		1333431L	G57629	
1331789R	G57463		1332338L	G56932		1333299L	G57110		1333431R	G57628	
1331794L	G57088		1332338R	G56933		1333299L	G57535		1333432L	G57677	
1331794R	G57089		1332342L	G57011		1333299R	G57111		1333432R	G57676	
1331796L	G57139		1332342R	G57012		1333299R	G57536		1333433L	G57659	
1331796R	G57140		1332343	G57051		1333305L	G57112		1333433R	G57658	
1331799L	G57398		1332344	G57013		1333305R	G57113		1333434L	G57659	
1331799R	G57399		1332345	G57014		1333307L	G57629		1333434R	G57658	
1331802L	G57167		1332347L	G56924		1333307R	G57628		1333435L	G57483	
1331802R	G57168		1332347R	G56925		1333319L	G57481		1333435L	G57659	
1331803L	G57400		1332348	G57060		1333319R	G57482		1333435R	G57484	
1331803R	G57401		1332349	G57271		1333320L	G57659		1333435R	G57658	
1331818	G57142		1332350L	G57030		1333320R	G57658		1333438L	G57674	
1331821	G57206		1332350R	G57031		1333354L	G56925		1333438R	G57673	
1331826L	G57268		1332352L	G57045		1333354R	G56924		1333439L	G57339	
1331826R	G57269		1332352R	G57046		1333355L	G57393		1333439R	G57340	
1331839L	G57161		1332353	G56929		1333355R	G57394		1333440L	G57604	
1331839R	G57162		1332354	G57005		1333363L	G57582		1333440R	G57603	
1331845L	G57477		1332354	G57006		1333363L	G57583		1333443L	G57695	
1331845R	G57478		1332354	G57392		1333363R	G57583		1333443R	G57696	
1331847L	G57126		1332355L	G57034		1333365L	G57331		1333444L	G57190	
1331847R	G57127		1332355R	G57035		1333365L	G57601		1333444R	G57191	
1331900L	G57218		1332356L	G57047		1333365R	G57332		1333447L	G57689	
1331900R	G57219		1332356R	G57048		1333365R	G57602		1333447R	G57690	
1331901L	G57343		1332357L	G57049		1333376L	G57500		1333448L	G57152	
1331901R	G57344		1332357R	G57050		1333376R	G57499		1333448R	G57153	
1331908L	G57471		1332358L	G57049		1333377L	G57500		1333450L	G57693	
1331908R	G57472		1332358R	G57050		1333377R	G57499		1333450R	G57694	
1331911L	G57645		1332360L	G57078		1333378L	G57587		1333451L	G57699	
1331911R	G57644		1332360R	G57079		1333378R	G57586		1333451R	G57700	
1331931	G57324		1332362L	G56932		1333379L	G57152		1333452L	G57218	
1332301	G56927		1332362R	G56933		1333379L	G57587		1333452R	G57219	
1332302	G56938		1332363L	G56930		1333379R	G57153		1333453L	G57361	
1332303	G57060		1332363R	G56931		1333379R	G57586		1333453R	G57362	
1332304L	G56924		1332366L	G57372		1333380L	G57587		1333454L	G57712	
1332304R	G56925		1332366R	G57373		1333380R	G57586		1333454R	G57713	
1332305L	G56930		1332367L	G57076		1333392L	G57197		1333462L	G57697	
1332305R	G56931		1332367R	G57077		1333392R	G57198		1333462R	G57698	
1332306L	G56932		1332368L	G57041		1333393L	G57562		1333464L	G57645	
1332306R	G56933		1332368R	G57042		1333393R	G57563		1333464R	G57644	
1332307	G56928		1332369L	G57043		1333395L	G57564		1333466L	G57390	

Important Note: Competitive Interchanges are to be used for stocking purposes only. Where multiple crosses are identified, please reference the applications section of this catalog. / **Remarque importante:** Les interchanges concurrentiels ne s'utilisent qu'aux fins de stocks. Dans le cas de références multiples, consulter la section des applications du catalogue. / **Nota importante:** Dans le cas de références multiples, consulter la section des applications du catalogue. / **Nota importante:** Se pueden usar intercambios competitivos para propósitos de almacenamiento solamente. Cuando se identifican intercambios múltiples, consulte la sección de aplicaciones de este catálogo.

COMPETITIVE & O.E.M. INTERCHANGE LIST
Lista de Intercambios contra Competidores y Equipo Original.
Liste dinterchange de produits comptitifs & dquipement original (OEM)

FCS... cont'd

Fcs	Gabriel	Upgrade	Fcs	Gabriel	Upgrade	Fcs	Gabriel	Upgrade	Fcs	Gabriel	Upgrade
1333466R	G57391		1333919R	G57853		1335924L	G57161		1345378R	G57569	
1333467L	G57549		1333926L	G57782		1335924R	G57162		1345395	G57159	
1333467R	G57550		1333926R	G57783		1336301L	G57063		1345395	G57160	
1333468L	G57322		1335383L	G57353		1336301R	G57064		1345397	G57430	
1333468R	G57323		1335383R	G57354		1336302	G56934		1345399	G57075	
1333471L	G57193		1335527L	G57270		1336302	G56937		1345401	G57159	
1333471R	G57192		1335527R	G57270		1336303	G56936		1345401	G57160	
1333475L	G57722		1335532L	G57431		1336304	G56935		1345403L	G57424	
1333475R	G57723		1335532R	G57432		1336305L	G56991		1345403R	G57425	
1333477L	G57496		1335543L	G57148		1336305R	G56992		1345404L	G57067	
1333477R	G57495		1335543R	G57148		1336306	G57039		1345404R	G57068	
1333489L	G57746		1335556	G57059		1336312	G56943		1345409L	G57444	
1333489R	G57747		1335562L	G57135		1336313	G56964		1345409R	G57444	
1333490	G57709		1335562R	G57136		1336315	G56998		1345411L	G57133	
1333491L	G57730		1335576	G57156		1336316	G57057		1345411R	G57134	
1333491R	G57731		1335576	G57277		1336316	G57058		1345416L	G57086	
1333492L	G57734		1335582	G57083		1336318	G56995		1345416R	G57087	
1333492R	G57735		1335582L	G57083		1336322L	G56993		1345417L	G57414	
1333494L	G57739		1335582R	G57083		1336322R	G56994		1345417R	G57415	
1333494R	G57738		1335604L	G57128		1336323	G57018		1345455	G57282	
1333495	G57142		1335604R	G57129		1336324	G57022		1345458L	G57457	
1333503L	G57803		1335664	G57149		1336325L	G57010		1345458R	G57458	
1333503R	G57804		1335682L	G57363		1336325R	G57010		1345459L	G57090	
1333511L	G57776		1335682R	G57364		1336326	G57020		1345459R	G57091	
1333511R	G57776		1335778	G57071		1336327	G57015		1345468L	G57442	
1333524L	G57784		1335778	G57072		1336327	G57212		1345468R	G57441	
1333524R	G57785		1335779L	G57081		1336328	G57016		1345469L	G57107	
1333529L	G57812		1335779R	G57082		1336329L	G57007		1345469R	G57108	
1333529R	G57812		1335790	G57427		1336329R	G57008		1345470	G57423	
1333532L	G57756		1335795L	G57337		1336330	G57017		1345471L	G57428	
1333532R	G57757		1335795R	G57338		1336331	G57021		1345471R	G57429	
1333534L	G57710		1335797L	G57207		1336332	G57019		1345477	G57421	
1333534R	G57711		1335797R	G57417		1336333	G57023		1345484	G57178	
1333548L	G57192		1335801L	G57595		1336334	G57053		1345497	G57092	
1333548R	G57193		1335801R	G57594		1336336	G57431		1345540	G57096	
1333549L	G57266		1335848L	G57359		1336336	G57432		1345541	G57703	
1333549R	G57267		1335848R	G57360		1336337L	G56996		1345555	G57125	
1333557L	G57487		1335849L	G57390		1336337R	G56997		1345556	G57146	
1333557R	G57488		1335849R	G57390		1336339	G57036		1345557	G57118	
1333565L	G57161		1335850	G57071		1336340L	G57033		1345557	G57413	
1333565R	G57162		1335875L	G57194		1336340L	G57061		1345558L	G57123	
1333702L	G57523		1335875R	G57195		1336340R	G57032		1345558L	G57220	
1333702R	G57524		1335876L	G57497		1336340R	G57062		1345558R	G57124	
1333714L	G57716		1335876R	G57498		1336341L	G57065		1345558R	G57221	
1333714R	G57717		1335877L	G57724		1336341R	G57066		1345559	G57095	
1333719L	G57543		1335877R	G57725		1336342	G57026		1345560	G57172	
1333719R	G57544		1335883L	G57764		1336343	G57080		1345561	G57173	
1333745L	G57780		1335883R	G57765		1336347L	G57054		1345562	G57103	
1333745R	G57781		1335892L	G57726		1336347R	G57055		1345563	G57103	
1333790L	G57480		1335892R	G57727		1336348	G57056		1345564L	G57027	
1333790R	G57479		1335893L	G57724		1336349	G57080		1345564R	G57027	
1333816L	G57780		1335893R	G57725		1337006L	G57774		1345565L	G57027	
1333816R	G57781		1335896L	G57517		1337006R	G57775		1345565R	G57027	
1333817L	G57076		1335896R	G57518		1337023L	G57800		1345566L	G57133	
1333817R	G57077		1335897L	G57517		1337023R	G57801		1345566R	G57134	
1333919L	G57852		1335897R	G57518		1345378L	G57568		1345567	G57147	

Important Note: Competitive Interchanges are to be used for stocking purposes only. Where multiple crosses are identified, please reference the applications section of this catalog. / **Remarque importante:** Les interchanges concurrentiels ne s'utilisent qu'aux fins de stocks. Dans le cas de références multiples, consulter la section des applications du catalogue. / **Nota importante:** Dans le cas de références multiples, consulter la section des applications du catalogue. / **Nota importante:** Se pueden usar intercambios competitivos para propósitos de almacenamiento solamente. Cuando se identifican intercambios múltiples, consulte la sección de aplicaciones de este catálogo.

COMPETITIVE & O.E.M. INTERCHANGE LIST
Lista de Intercambios contra Competidores y Equipo Original.
Liste dinterchange de produits comptitifs & dquipement original (OEM)

FCS... cont'd

Fcs	Gabriel	Upgrade	Fcs	Gabriel	Upgrade	Fcs	Gabriel	Upgrade	Fcs	Gabriel	Upgrade
1345568	G57420		2331622R	G57205		2333365R	G57479		2335527R	G57270	
1345682	G57646		2331629L	G57390		2333376L	G57500		2335543L	G57148	
1345683	G57447		2331629R	G57391		2333376R	G57499		2335543R	G57148	
1345685L	G57419		2331632L	G57222		2333378L	G57152		2335576	G57680	
1345685R	G57419		2331632R	G57223		2333378R	G57153		2335582L	G57083	
1345687	G57095		2331645L	G57144		2333392L	G57197		2335582R	G57083	
1345688L	G57416		2331645R	G57145		2333392I	G57322		2335779L	G57081	
1345688R	G57682		2331688L	G57583		2333392R	G57198		2335779R	G57082	
1345689L	G57451		2331688R	G57282		2333392R	G57323		2335790	G57427	
1345689R	G57452		2331747L	G57459		2333393L	G57720		2335790R	G57427	
1345695	G57706		2331747R	G57460		2333393R	G57721		2335797L	G57418	
1345721L	G57480		2331762L	G57339		2333406L	G57465		2335797R	G57417	
1345721L	G57597		2331762R	G57340		2333406R	G57466		2335801L	G57455	
1345721R	G57479		2331778L	G57311		2333412L	G57566		2335801R	G57456	
1345721R	G57598		2331778R	G57312		2333412R	G57567		2335849L	G57449	
1345741L	G57451		2331782L	G57615		2333414L	G57378		2335849R	G57450	
1345741R	G57452		2331782R	G57614		2333414R	G57377		2335850	G57071	
1345742L	G57572		2331785L	G57153		2333415L	G57377		2335876L	G57497	
1345742R	G57573		2331785R	G57152		2333415R	G57378		2335876R	G57498	
1345750	G57447		2331794L	G57088		2333438L	G57674		2335883L	G57764	
1345761	G57675		2331794R	G57089		2333438R	G57673		2335883R	G57765	
1345762	G57675		2331796L	G57139		2333444L	G57190		2335893L	G57756	
1345763	G57703		2331796R	G57140		2333444R	G57191		2335893R	G57727	
1345764L	G57457		2331821	G57206		2333445L	G57701		2335897L	G57517	
1345764R	G57458		2331839L	G57161		2333445R	G57702		2335897R	G57518	
1345768	G57703		2331839R	G57162		2333447L	G57689		2336305L	G56991	
1345815	G57000		2331852L	G57539		2333447R	G57690		2336306	G57039	
1345816R	G57683		2331852R	G57540		2333450L	G57691		2336310	G57557	
1345837R	G57683		2331908L	G57471		2333450R	G57692		2336312	G57576	
1345844	G57794		2331908R	G57472		2333451L	G57697		2336324	G57022	
1345845L	G57192		2331931	G57324		2333451R	G57698		2336329L	G57007	
1345845R	G57193		2332304L	G56924		2333453L	G57361		2336329R	G57008	
1345849L	G57454		2332304R	G56925		2333453R	G57362		2336338	G57422	
1345849R	G57453		2332350L	G57030		2333467L	G57549		2336338	G57423	
1345880	G57683		2332350R	G57031		2333467R	G57550		2336347	G57056	
1345959	G57799		2332352L	G57045		2333489L	G57746		2337006L	G57774	
1346088	G57343		2332352R	G57046		2333489R	G57747		2337006R	G57775	
1346088	G57344		2332357L	G57049		2333491L	G57730		2345397	G57430	
1346361L	G57133		2332357R	G57050		2333491R	G57731		2345455	G57282	
1346361R	G57134		2332367L	G57076		2333492L	G57733		2345458L	G57457	
1355057	G57683		2332367R	G57077		2333492R	G57732		2345458R	G57458	
2331008L	G57510		2332368L	G57041		2333494L	G57738		2345484	G57607	
2331008R	G57509		2332368R	G57042		2333494R	G57739		2345497	G57092	
2331579L	G57275		2333296L	G57329		2333511L	G57777		2345540	G57096	
2331579R	G57276		2333296R	G57330		2333511R	G57777		2345541	G57703	
2331582L	G57190		2333319L	G57481		2333714L	G57716		2345556	G57409	
2331582R	G57191		2333319R	G57482		2333714R	G57717		2345558L	G57123	
2331590L	G57613		2333320L	G57659		2333745L	G57780		2345558R	G57124	
2331590R	G57612		2333320R	G57658		2333745R	G57781		2345559	G57095	
2331595L	G57119		2333354L	G56924		2333790L	G57754		2345561	G57173	
2331595R	G57120		2333354R	G56925		2333790R	G57755		2345682	G57647	
2331604L	G57350		2333355L	G57393		2333816L	G57780		2345721L	G57480	
2331604R	G57349		2333355R	G57394		2333816R	G57781		2345721L	G57599	
2331613L	G57533		2333363L	G57583		2333817L	G57076		2345721R	G57479	
2331613R	G57534		2333363R	G57582		2333817R	G57077		2345742L	G57451	
2331622L	G57204		2333365L	G57480		2335527L	G57270		2345742R	G57452	

Important Note: Competitive Interchanges are to be used for stocking purposes only. Where multiple crosses are identified, please reference the applications section of this catalog. / **Remarque importante:** Les interchanges concurrentiels ne s'utilisent qu'aux fins de stocks. Dans le cas de références multiples, consulter la section des applications du catalogue. / **Nota importante:** Dans le cas de referencias multiples, consultar la sección de aplicaciones del catálogo. / **Nota importante:** Se pueden usar intercambios competitivos para propósitos de almacenamiento solamente. Cuando se identifican intercambios múltiples, consulte la sección de aplicaciones de este catálogo.

COMPETITIVE & O.E.M. INTERCHANGE LIST
Lista de Intercambios contra Competidores y Equipo Original.
Liste dinterchange de produits comptitifs & dquipement original (OEM)

FCS... cont'd

Fcs	Gabriel	Upgrade	Fcs	Gabriel	Upgrade	Fcs	Gabriel	Upgrade	Fcs	Gabriel	Upgrade
2345750	G57579		331634R	G52151		331802R	G52336		333290	G56809	
2345763	G57703		331639L	G55999		331818	G52025		333292	G55551	
2345764L	G57457		331639R	G55999		331820	G56700		333296L	G52245	
2345764R	G57458		331644L	G56687		331821	G52131		333296R	G52246	
2345815	G57000		331644R	G56688		331825L	G55591		333297	G56701	
2345844	G57794		331645L	G56615		331825R	G55591		333319L	G52201	
2345849L	G57454		331645R	G56616		331845L	G52182		333319R	G52202	
2345849R	G57453		331646L	G52032		331845R	G52183		3333296L	G57329	
2345881	G57748		331646R	G52033		331908L	G52158		3333296R	G57330	
331008L	G56538		331648L	G52094		331908R	G52159		3333354L	G56924	
331008R	G56537		331648R	G52095		331909L	G52247		3333354R	G56925	
331019L	G56634		331660L	G56679		331909R	G52248		3333363L	G57583	
331019R	G56633		331660R	G56680		331931	G52116		3333363R	G57282	
331048L	G52333		331661L	G52168		332302	G55825		3333365L	G57574	
331048R	G52334		331661R	G52169		332303	G55948		3333365R	G57575	
331060L	G56640		331668L	G56530		332304	G55949		3333392L	G57197	
331060R	G56641		331668R	G56529		332305L	G56506		3333392R	G57198	
331149L	G55879		331669L	G56530		332305R	G56514		3333393L	G57720	
331149R	G55879		331669R	G56529		332306L	G55675		3333393R	G57721	
331579L	G52154		331674L	G52260		332306R	G55676		3333406L	G57465	
331579R	G52155		331674R	G52261		332311	G55526		3333406R	G57466	
331587	G56802		331688R	G56841		332312	G56718		3333412L	G57329	
331588L	G55993		331692	G55681		332316	G55697		3333412R	G57330	
331588R	G55994		331694L	G56518		332317	G55698		3333414L	G57377	
331591L	G56683		331694R	G56518		332319	G56620		3333414R	G57378	
331591R	G56684		331700	G56778		332323L	G55999		3333415L	G57377	
331596L	G56685		331709L	G52017		332323R	G55999		3333415R	G57378	
331596R	G56686		331709R	G52018		332324L	G55661		3333444L	G57190	
331597L	G52008		331713L	G52144		332324R	G55662		3333444R	G57191	
331597R	G52009		331713R	G52145		332334	G55892		3333445L	G57701	
331601L	G56661		331715L	G52249		332335	G55896		3333445R	G57702	
331601R	G56660		331715R	G52250		332343	G56509		3333467L	G57549	
331603L	G56615		331716L	G52140		332349	G56817		3333467R	G57550	
331603R	G56616		331716R	G52141		332350L	G56671		3333489L	G57744	
331604L	G56582		331727	G55948		332350R	G56672		3333489R	G57745	
331604R	G56581		331733	G56509		332352L	G56601		333354	G55949	
331607L	G52103		331741L	G52184		332352R	G56568		333355L	G52156	
331607R	G52104		331741R	G52185		332356	G56810		333355R	G52157	
331617L	G52013		331762L	G52272		332357L	G56621		3333564L	G57772	
331617R	G52014		331762R	G52273		332357R	G56622		3333564R	G57773	
331622L	G52004		331773	G52098		332366L	G55993		333356L	G52255	
331622R	G52007		331775L	G52096		332366R	G55994		333356R	G52256	
331625L	G52105		331775R	G52097		3331582L	G57190		333363L	G52351	
331625R	G52106		331778L	G52026		3331582R	G57191		333363R	G52352	
331626L	G52107		331778R	G52027		3331595L	G57119		333365L	G52187	
331626R	G52108		331783L	G52103		3331595R	G57120		333365R	G52188	
331628L	G52107		331783R	G52104		3331622L	G57204		333379L	G56732	
331628R	G52108		331789L	G52081		3331622R	G57205		333379R	G56733	
331630L	G56800		331789R	G52082		3331660L	G57151		333392L	G52127	
331631L	G56800		331796L	G56562		3331660R	G57150		333392R	G52128	
331631R	G56799		331796R	G56561		3331821L	G57206		333393L	G52201	
331632L	G52112		331799L	G56642		3331821R	G57206		333393R	G52202	
331632R	G52113		331799R	G56643		3332304L	G56924		333402L	G52131	
331633L	G52282		331800L	G52333		3332304R	G56925		333402R	G52131	
331633R	G52283		331800R	G52334		333283L	G52173		333404	G52125	
331634L	G52150		331802L	G52335		333283R	G52174		333406L	G52117	

Important Note: Competitive Interchanges are to be used for stocking purposes only. Where multiple crosses are identified, please reference the applications section of this catalog. / **Remarque importante:** Les interchanges concurrentiels ne s'utilisent qu'aux fins de stocks. Dans le cas de rfrences multiples, consulter la section des applications du catalogue. / **Nota importante:** Dans le cas de rfrences multiples, consulter la section des applications du catalogue. / **Nota importante:** Se pueden usar intercambios competitivos para propósitos de almacenamiento solamente. Cuando se identifican intercambios múltiples, consulte la sección de aplicaciones de este catálogo.

COMPETITIVE & O.E.M. INTERCHANGE LIST
Lista de Intercambios contra Competidores y Equipo Original.
Liste dinterchange de produits comptitifs & dquipement original (OEM)

FCS... cont'd

Fcs	Gabriel	Upgrade	Fcs	Gabriel	Upgrade	Fcs	Gabriel	Upgrade	Fcs	Gabriel	Upgrade
333406R	G52118		335542L	G52110		341512	81713		341577	81744	
333426L	G52382		335542R	G52111		341513	81541		341578	81912	
333426R	G52383		335543L	G51859		341514	81490		341579	81914	
333431L	G52374		335543R	G51859		341514	81836		341580	G63886	
333431R	G52375		335547	G55579		341516	G63862		341581	81833	
333435L	G52203		335552	G55901		341517	69625		341582	81828	
333435R	G52204		335555L	G52274		341517	81446		341583	G64037	
333440L	G52152		335555R	G52275		341517	81492		341584	81892	
333440R	G52153		335556	G51714		341517	81494		341585	81913	
333443L	G52360		335559	G51740		341517	81495		341586	81935	
333443R	G52361		335561	G51097		341518	81548		341587	69592	
333444L	G56888		335576	G56899		341519	81893		341588	81794	
333444R	G56889		335582	G56807		341520	82155		341590	69962	
333453L	G52209		335583L	G51813		341522	69863		341593	G63884	
333453R	G52210		335583R	G51814		341523	G51807		341594	G63894	
333494L	G52331		335586	G56565		341524	69907		341595	81922	
333494R	G52332		335605	G51718		341526	70020		341596	G63895	
333504L	G52329		335632L	G52314		341527	81935		341597	81920	
333504R	G52330		335632R	G52314		341528	81872		341598	81925	
333507L	G52280		335664	G51806		341529	G51805		341599	81920	
333507R	G52281		335666	G51806		341530	81869		341600	81904	
3335576	G57156		335779L	G56836		341531	81922		341603	70013	
333560L	G52260		335779R	G56837		341532	G63885		341608	69420	
333560R	G52261		335811	G52276		341533	G63832		341613	81481	
333564L	G52524		335836L	G51920		341534	G63860		341615	69589	
333564R	G52525		335836R	G51921		341535	G63860		341617	81934	
3335779L	G57081		336301L	G56516		341537	G64087		341623	70028	
3335779R	G57082		336301R	G56517		341538	G64087		341624	70055	
3335797L	G57208		336303	G55901		341539	G51805		341627	81936	
3335797R	G57207		336305	G55870		341540	81416		341629	81691	
3335801L	G57455		336306	G56606		341541	G63937		341635	70036	
3335801R	G57456		336311L	G52005		341542	G63889		341638	81933	
3335876L	G57497		336311R	G52006		341543	G64006		341639	81928	
3335876R	G57498		336313	G55856		341544	G64038		341640	81932	
3336329L	G57007		336315	G55910		341545	70060		341641	81919	
3336329R	G57008		336316	G51087		341546	G55821		341642	G63958	
3336347L	G57055		336325	G51077		341548	81911		341643	G64011	
3336347R	G57054		336329	G51728		341550	G63828		341645	81096	
3345484	G57607		336330	G51722		341551	G63815		341649	82138	
3345497	G57144		336332	G51723		341552	81507		341688	G51874	
3345497	G57145		336333	G51870		341553	G63813		341715	70037	
3345559	G57095		336334	G51758		341554	81478		341716	70013	
3345682	G57646		336337	G55909		341556	81478		341952	G64047	
3345742L	G57572		336338	G51268		341557	G51812		341962	G51807	
3345742R	G57573		336339	G51279		341558	G51802		341964	70049	
335027	G55820		336340	G51700		341559	G51798		341967	69575	
3355037	G57023		336341	G51077		341560	G51803		341974	81870	
335519	G51255		336343	G51887		341561	70041		341979	69946	
335523L	G51813		336347	G51737		341562	G64027		341980	69450	
335523R	G51814		336348	G51738		341567	81916		342106	81459	
335527L	G51810		336349	G51888		341568	81744		342129	G63299	
335527R	G51811		341012	82156		341570	G51721		342390	81935	
335531L	G51761		341092	70000		341573	81582		342445	81878	
335531R	G51760		341347	69863		341574	G63410		342462	81726	
335533	G51267		341424	70003		341575	81713		342464	82001	
335541	G56655		341511	81668		341576	81744		342465	G64003	

Important Note: Competitive Interchanges are to be used for stocking purposes only. Where multiple crosses are identified, please reference the applications section of this catalog. / **Remarque importante:** Les interchanges concurrentiels ne s'utilisent qu'aux fins de stocks. Dans le cas de références multiples, consulter la section des applications du catalogue. / **Nota importante:** Dans le cas de références multiples, consulter la section des applications du catalogue. / **Nota importante:** Se pueden usar intercambios competitivos para propósitos de almacenamiento solamente. Cuando se identifican intercambios múltiples, consulte la sección de aplicaciones de este catálogo.

COMPETITIVE & O.E.M. INTERCHANGE LIST
Lista de Intercambios contra Competidores y Equipo Original.
Liste dinterchange de produits comptitifs & dquipement original (OEM)

FCS... cont'd

Fcs	Gabriel	Upgrade	Fcs	Gabriel	Upgrade	Fcs	Gabriel	Upgrade	Fcs	Gabriel	Upgrade
342466	81667		342537	G64032		343329	82004		345682	G51766	
342467	81039		342540	G64003		343330	82125		345683	G51863	
342467	81496		342541	69724		343339	82126		345685	G51892	
342468	81926		342542	81492		344312	81076		345688	G51879	
342470	69473		342542	81494		345066	G51252		345689	G51898	
342471	69590		342542	81514		345315	G51794		345691	G51860	
342472	81730		342543	G63776		345378	G51795		345692	G51861	
342472	81891		342546	69587		345394	G51063		345694	G51865	
342472	81917		342547	G64015		345395	G51727		345695	G51961	
342473	69591		342549	81676		345398	G51767		345734	G51848	
342474	69787		342549	82007		345399	G51254		345742	G51898	
342475	G63842		342550	69587		345401	G51727		345750	G51863	
342476	81930		342551	G63872		345402	G51910		345764L	G511054	
342477	G63868		342554	81549		345403	G51858		345764R	G511055	
342478	81318		342555	81549		345404	G51736		345766	G51922	
342479	81871		342556	G64012		345405	G51739		345825	G51916	
342480	81147		342557	G63844		345408	G55804		345826	G51975	
342481	G64026		342558	81929		345412	G51477		346017	70052	
342484	G63937		342561	81923		345413	G51738		346031	G51884	
342485	G63875		342564	G63962		345414	G51716		346051	G63726	
342486	81147		342565	81873		345415	G51256		346052	82090	
342487	82066		342567	81496		345416	G51286		346054	70055	
342488	81910		342572	G63866		345417	G51880		346056	G63815	
342489	70027		342573	81880		345419	G51715		346057	G51966	
342490	G63883		342770	G64042		345425	G51772		346066	G51971	
342491	G63878		342778	70010		345428	G51254		346087	G64056	
342492	G64028		342779	G63959		345429	G51254		346088	G64216	
342493	81318		342780	81484		345430	G51883		346090	G51905	
342494	81923		342781	81113		345433	G51980		346091	G511134	
342496	81821		342785	G64071		345434	G51794		346092	70078	
342496	81905		342787	G64033		345436	G51838		346093	70068	
342496	81918		342789	G64079		345443	G51719		346099	G51980	
342500	G63717		342790	G63886		345447	G51703		346100	G51980	
342501	81082		342791	G64050		345448	G51704		346101	G51980	
342501	81510		342792	69465		345450	G51729		346102	G511092	
342501	81710		342798	G63845		345451	G51724		346103	G511092	
342502	G63809		342799	81750		345455	G51850		346104	G64111	
342505	G63717		342827	G63622		345456	G51841		346113	70086	
342506	81823		342838	81676		345458L	G52036		346114	70053	
342506	81890		342840	G64016		345458R	G52037		346128	70096	
342507	G63870		342841	G63892		345459	G51713		346131	70096	
342508	G63867		342843	G64040		345471	G51852		346178	70059	
342509	G63810		342844	70203		345472	G51759		346212	70036	
342510	G63808		342845	G64031		345474	G56598		346213	G511078	
342511	G63810		342846	G64121		345478	G51832		346218	G511000	
342512	81710		342848	G64148		345483	G51833		346239	G511044	
342513	G63873		342856	G64040		345484	G51842		346240	G51905	
342516	81516		342873	G64104		345486	G51286		346243	G511044	
342517	G63879		342875	70203		345490	G51881		346249	G64216	
342518	G63882		342889	69591		345491	G51855		346253	G511092	
342519	81482		342905	70098		345492	G51477		346256	G64216	
342527	81873		342922	G64143		345555	G51891		346258	70096	
342528	81931		342944	G64186		345556	G51815		346324	G51971	
342529	81921		342946	G64012		345563	G51864		346341	G511030	
342534	G63918		342949	G64031		345567	G51856		346343	70086	
342536	69585		343308	81270		345681	G51765		346367	G63885	

Important Note: Competitive Interchanges are to be used for stocking purposes only. Where multiple crosses are identified, please reference the applications section of this catalog./ **Remarque importante:** Les interchanges concurrentiels ne s'utilisent qu'aux fins de stocks. Dans le cas de rfrences multiples, consulter la section des applications du catalogue./ **Nota importante:** Dans le cas de rfrences multiples, consulter la section des applications du catalogue./ **Nota importante:** Se pueden usar intercambios competitivos para propósitos de almacenamiento solamente. Cuando se identifican intercambios múltiples, consulte la sección de aplicaciones de este catálogo.

COMPETITIVE & O.E.M. INTERCHANGE LIST
Lista de Intercambios contra Competidores y Equipo Original.
Liste dinterchange de produits comptitifs & dquipement original (OEM)

FCS... cont'd

Fcs	Gabriel	Upgrade	Fcs	Gabriel	Upgrade	Fcs	Gabriel	Upgrade	Fcs	Gabriel	Upgrade
346370	G511142		F343379	85728		F347207	85061	89450	F347250	85300	89419
346410	G511000		F343380	85727		F347207	85061	89502	F347250	89419	
346443	70207		F343381	83400		F347207	89502		F347251	85023	89415
346449	G511038		F343382	83613		F347208	85938		F347251	89415	
346452	G51990		F344342	85936	89456	F347209	83124	89407	F347252	83002	
347007	G64048		F344342	89456		F347209	89407		F347253	83025	
347015	G64186		F344343	85937		F347210	83207	89407	F347254	83051	
347023	G64050		F344344	83027		F347210	89407		F347255	83035	
347037	G63888		F344345	83112		F347211	85066	89448	F347256	83028	
347072	70098		F344347	83062		F347211	89448		F347257	83031	
4331622L	G57204		F344348	83041		F347212	83125		F347260	85724	89443
4331622R	G57205		F344349	83045		F347213	85931	89458	F347260	89443	
4331660L	G57151		F344350	83050		F347213	89458		F347261	85918	89449
4331660R	G57150		F344351	83019		F347214	83048		F347261	89449	
4331778L	G57311		F344352	85729		F347215	85067	89451	F347262	83038	
4331778R	G57312		F344353	83142		F347215	89451		F347263	85001	89410
4331821L	G57206		F344354	83111		F347216	83389	89436	F347263	89410	
4331821R	G57206		F344355	83143		F347216	85000	89436	F347264	85323	89436
4333363L	G57583		F344356	83154		F347216	89436		F347264	89436	
4333363R	G57282		F344357	83110		F347217	83128	89436	F347265	85320	89429
4333392L	G57197		F344358	85026		F347217	89436		F347265	89429	
4333392R	G57198		F344360	83109		F347218	83147		F347266	85003	89411
4333406L	G57465		F346598	85033	89427	F347219	85006		F347266	89411	
4333406R	G57466		F346598	89427		F347220	85954		F347267	83009	
4333489L	G57744		F346599	85311	89424	F347221	85924	89457	F347268	85920	89503
4333489R	G57745		F346599	89424		F347221	89457		F347268	89503	
4335790	G57427		F346601	85319	89428	F347222	83021		F347269	85013	89414
4345497	G57118		F346601	89428		F347223	85934		F347269	89414	
5331821L	G57206		F346603	85316	89426	F347224	85919		F347270	85005	89430
5331821R	G57206		F346603	89426		F347225	85958		F347270	89430	
5333392L	G57197		F346632	83317		F347226	85012	89413	F347271	85901	
5333392R	G57198		F346633	85988		F347226	89413		F347272	85932	89453
5333406L	G57465		F346634	83515		F347227	85062	89408	F347272	89453	
5333406R	G57466		F346635	83518		F347227	89408		F347273	85047	89435
5335790	G57427		F346636	83395		F347231	83001		F347273	89435	
6333406L	G57578		F346637	85649		F347232	85959		F347274	85956	
6333406R	G57577		F347193	85030	89440	F347233	85070	89459	F347275	83042	
8335532L	G57431		F347193	89440		F347233	89459		F347276	85923	89458
8335532R	G57432		F347194	83203	89436	F347234	85933	89454	F347276	89458	
DG341531	58803		F347194	89436		F347234	89454		F347277	83148	
DG342476	G63866		F347195	85053	89442	F347235	85978		F347278	83017	
DT341951	70040		F347195	89442		F347236	83137		F347279	85014	
DT346181	G64046		F347196	85052		F347238	85331		F347280	85010	
DT346207	G511001		F347197	85088		F347239	85976		F347291	83047	
DT347071	77412		F347198	85058	89431	F347241	85928		F347292	83049	
F343368	85069	89455	F347198	89431		F347242	85957		F347293	83024	
F343368	89455		F347199	85738		F347243	83209	89414	F347294	83026	
F343371	85708		F347200	85072		F347243	89414		F347295	83011	
F343372	83136		F347201	85064		F347244	85043		F347296	83006	
F343373	83456	89447	F347202	85045		F347245	83029		F347297	83053	
F343373	89447		F347203	83127		F347246	83130		F347298	83044	
F343374	85722		F347204	83008		F347247	83135		F347299	83081	
F343375	85310	89423	F347205	85061	89450	F347248	83123	89405	F347300	85989	
F343375	89423		F347205	85061	89502	F347248	89405		F347302	85656	
F343376	85900		F347205	89502		F347249	85084	89460	F347303	85060	
F343378	85902		F347206	85029		F347249	89460		F347304	83163	

Important Note: Competitive Interchanges are to be used for stocking purposes only. Where multiple crosses are identified, please reference the applications section of this catalog. / **Remarque importante:** Les interchanges concurrentiels ne s'utilisent qu'aux fins de stocks. Dans le cas de références multiples, consulter la section des applications du catalogue. / **Nota importante:** Dans le cas de références multiples, consulter la section des applications du catalogue. / **Nota importante:** Se pueden usar intercambios competitivos para propósitos de almacenamiento solamente. Cuando se identifican intercambios múltiples, consulte la sección de aplicaciones de este catálogo.

COMPETITIVE & O.E.M. INTERCHANGE LIST
Lista de Intercambios contra Competidores y Equipo Original.
Liste d'interchange de produits compititifs & d'equpement original (OEM)

FCS... cont'd

Fcs	Gabriel	Upgrade	Fcs	Gabriel	Upgrade	Fcs	Gabriel	Upgrade	Fcs	Gabriel	Upgrade
F347305	85939		F347317	83166		F347330	85337		F347345	85637	
F347306	85909		F347318	85305		F347331	85916	89430	F347346	85642	
F347307	85036	89405	F347318	85307		F347331	89430		F347347	83519	
F347307	89405		F347319	83221		F347332	85911		F347348	83391	
F347308	85051		F347319	85071		F347333	83215		F347349	83363	
F347309	83122	89406	F347320	87015		F347334	85055	89439	F347350	85639	
F347309	89406		F347321	85007		F347334	89439		F347351	83901	
F347310	85031		F347322	85334		F347335	85304		F347352	83389	89436
F347311	85343		F347323	83101		F347335	85734		F347352	89436	
F347312	85712		F347324	85338		F347336	85321		F347353	83364	
F347313	83140		F347325	83312	89409	F347337	83309		F347354	85638	
F347314	85301		F347325	89409		F347339	85967		F347355	85648	
F347314	85302	89420	F347326	85046	89434	F347340	85308	89422	F347356	85650	
F347314	89420		F347326	89434		F347340	89422		F442755	646155	
F347315	83126	89430	F347327	83150		F347341	85024		F442790	646177	
F347315	89430		F347328	83204		F347342	83169		F442791	665937	
F347316	85303	89422	F347329	85906	89407	F347343	83905				
F347316	89422		F347329	89407		F347344	83906				

Ford

Ford	Gabriel	Upgrade	Ford	Gabriel	Upgrade	Ford	Gabriel	Upgrade	Ford	Gabriel	Upgrade
1201-0012	83023		2F2Z 18124-AA	G56935		3U2Z18124JAA	G63614		4C4O-18080-AA	83101	
1201-1043	83025		2L1Z 18124-AD	G57015		3U2Z18124MAA	83131		4C4O-18080-BA	83317	
1201-1044	83025		2L7Z 18125-AA	G57016		3U2Z18124YAA	G63809		4C4O18045AA	83163	
12010012	83023		3199942	89402		3U2Z18125AD	69575		4C4O18045BB	83135	
12011043	83025		3553628C1	85927		3U2Z18125CA	G63607		4C4O18045CA	85957	
12011044	83025		3553628C2	85927		3U2Z18125DA	G63525		4C4O18045DB	85927	
1202-0012	83023		3578858C1	85656		3U2Z18125EA	G63524		4C4O18045EA	85656	
1202-0032	83016		3578858C2	85656		3U2Z18125RA	G63623		4C4O18045GA	83175	
1202-0042	83025		3584116C1	83175		47 1700 007 203	85013	89414	4C4O18045HA	83135	
1202-1043	83025		3584116C2	83175		47 1700 007 203	89414		4C4O18045JA	85928	
1202-1044	83025		3584117C2	83135		471700007117	85010		4C4O18045KA	85976	
12020012	83023		3584118C2	85928		471700009775	85010		4C4O18045LA	85976	
12020032	83016		3919942	89402		471700011530	85181		4C4O18045MA	85656	
12020042	83025		3L2Z 18124-CA	G57017		471700011531	85180		4C4O18080AA	83101	
12021043	83025		3U2Z 18124-BJ	G57080		47902-13	83122	89406	4C4O18080BA	83317	
12021044	83025		3U2Z 18124-BK	G57080		47902-13	89406		4C4Z-18124-AB	83163	
1605788	G64063		3U2Z 18124-PAA	G57017		47902-28	85013	89414	4C4Z-18124-BB	83135	
1C34-18045-AA	83209	89414	3U2Z-18124-BAA	G63809		47902-28	89414		4C4Z-18124-CB	85957	
1C34-18045-AA	89414		3U2Z-18124-BV	G63614		47902-8	83122	89406	4C4Z-18124-DC	85927	
1C34-18045-JA	83209	89414	3U2Z-18124-BW	G63614		47902-8	89406		4C4Z-18124-EA	85656	
1C34-18045-JA	89414		3U2Z-18124-EA	G63772		4790213	83122	89406	4C4Z-18124-GB	83175	
1C3418045AA	83209	89414	3U2Z-18124-FA	G63608		4790213	89406		4C4Z-18124-HB	83135	
1C3418045AA	89414		3U2Z-18124-FAA	G63809		4790228	85013	89414	4C4Z-18124-JB	85928	
1C3418045JA	83209	89414	3U2Z-18124-JAA	G63614		4790228	89414		4C4Z-18124-KA	85976	
1C3418045JA	89414		3U2Z-18124-MAA	83131		479028	83122	89406	4C4Z-18124-LA	85976	
1C44-18080-AA	83123	89405	3U2Z-18124-YAA	G63809		479028	89406		4C4Z-18124-M	85656	
1C44-18080-AA	89405		3U2Z-18125-AD	69575		4C4O-18045-AA	83163		4C4Z-18124-P	83135	
1C4418080AA	83123	89405	3U2Z-18125-CA	G63607		4C4O-18045-BB	83135		4C4Z-18124-QA	83175	
1C4418080AA	89405		3U2Z-18125-DA	G63525		4C4O-18045-CA	85957		4C4Z-18124-RA	85928	
2C44-18045-BA	83175		3U2Z-18125-EA	G63524		4C4O-18045-DB	85927		4C4Z-18125-AB	83101	
2C4418045BA	83175		3U2Z-18125-RA	G63623		4C4O-18045-EA	85656		4C4Z-18125-B	83317	
2C4Z-18124-BA	83175		3U2Z18124BAA	G63809		4C4O-18045-GA	83175		4C4Z-18125-CA	85976	
2C4Z18124BA	83175		3U2Z18124BV	G63614		4C4O-18045-HA	83135		4C4Z-18125-DA	85656	
2C7Z-18125-AA	G63837		3U2Z18124BW	G63614		4C4O-18045-JA	85928				
2C7Z-18125-CA	G63607		3U2Z18124EA	G63772		4C4O-18045-KA	85976				
2C7Z18125AA	G63837		3U2Z18124FA	G63608		4C4O-18045-LA	85976				
2C7Z18125CA	G63607		3U2Z18124FAA	G63809		4C4O-18045-MA	85656				

Important Note: Competitive Interchanges are to be used for stocking purposes only. Where multiple crosses are identified, please reference the applications section of this catalog. / **Remarque importante:** Les interchanges concurrentiels ne s'utilisent qu'aux fins de stocks. Dans le cas de rferences multiples, consulter la section des applications du catalogue. / **Nota importante:** Dans le cas de rferences multiples, consulter la section des applications du catalogue. / **Nota importante:** Se pueden usar intercambios competitivos para propósitos de almacenamiento solamente. Cuando se identifican intercambios múltiples, consulte la sección de aplicaciones de este catálogo.

COMPETITIVE & O.E.M. INTERCHANGE LIST
Lista de Intercambios contra Competidores y Equipo Original.
Liste dinterchange de produits comptitifs & dquipement original (OEM)

Ford... cont'd

Ford	Gabriel	Upgrade	Ford	Gabriel	Upgrade	Ford	Gabriel	Upgrade	Ford	Gabriel	Upgrade
4C4Z18124AB	83163		5U2Z18V124AA	G63714		6U2Z18V125B	G63607		8L1Z 18125-J	G57173	
4C4Z18124BB	83135		5U2Z18V124AHA	G63622		70127	85006		90044769	83207	89407
4C4Z18124CB	85957		5U2Z18V124AU	G63772		70128	85006		90044769	89407	
4C4Z18124DC	85927		5U2Z18V124BA	G63716		7C2Z-18125-D	G63623		90044770	83207	89407
4C4Z18124EA	85656		5U2Z18V124CAA	G63809		7C34-18045-HB	G63969		90044770	89407	
4C4Z18124GB	83175		5U2Z18V124DB	G63455		7C34-18080-DCB	77968		90045099	85906	89407
4C4Z18124HB	83135		5U2Z18V124GA	G63809		7C3418045HB	G63969		90045099	89407	
4C4Z18124JB	85928		5U2Z18V124LA	G63929		7C3418080DCB	77968		90045132	85906	89407
4C4Z18124KA	85976		5U2Z18V125AE	G63808		7C3Z 18124-NCA	G63886		90045132	85909	
4C4Z18124LA	85976		5U2Z18V125AF	G63810		7C3Z 18124-NDA	G63886		90045132	89407	
4C4Z18124M	85656		5U2Z18V125BDA	G63623		7C3Z 18124-NEA	G63886		9C3Z 18124-A	G63886	
4C4Z18124P	83135		5U2Z18V125BGA	G63778		7C3Z 18124-PBA	G63886		9C3Z 18125-A	G63888	
4C4Z18124QA	83175		5U2Z18V125BS	G63607		7C3Z 18124-PCA	G63886		9L8Z 18124-AL	G56601	
4C4Z18124RA	85928		5U2Z18V125BT	G63525		7C3Z 18125-JCA	G63888		9L8Z 18124-AR	G56568	
4C4Z18125AB	83101		5U2Z18V125BU	G63524		7C3Z 18125-JEA	G63888		9L8Z 18124-BL	G56601	
4C4Z18125B	83317		5U2Z18V125F	G63676		7C3Z 18125-KBA	G63888		9L8Z 18124-BR	G56568	
4C4Z18125CA	85976		5U2Z18V125G	G63837		7C3Z 18125-KCA	G63888		9R3Z 18124-G	G57271	
4C4Z18125DA	85656		5U2Z18V125H	G63406		7C3Z 18125-KDA	G63888		9U94-18045-AA	83209	89414
4U2Z-18V124-AA	G63678		60670-008	83123	89405	7C3Z-18124-NJA	G63886		9U94-18045-AA	89414	
4U2Z18V124AA	G63678		60670-008	89405		7C3Z-18125-CXA	G64010		9U94-18080-AA	83122	89406
501906C91	83317		60670-008L	83123	89405	7E5Z 18124-LH	G57148		9U94-18080-AA	89406	
501906C92	83317		60670-008L	89405		7E5Z 18124-RH	G57148		9U9418045AA	83209	89414
57241-2	83109		60670-011	83148		7L1Z 18A099-C	143393		9U9418045AA	89414	
572412	83109		60670-012	83168		7L2Z 18124-AC	G57095		9U9418080AA	83122	89406
57365-111	85006		60670008	83123	89405	7L2Z 18124-BB	G57095		9U9418080AA	89406	
57365111	85006		60670008	89405		7L5Z-18124-A	G63772		9U9Z-18124-A	83209	89414
5C3Z-18124-JA	G63969		60670008L	83123	89405	7W7Z-18125-B	69574		9U9Z-18124-A	89414	
5C3Z-18125-CF	77969		60670008L	89405		7W7Z18125B	69574		9U9Z-18125-A	83122	89406
5C3Z-18125-DA	77968		60670011	83148		87HU-18045-AA	85301		9U9Z-18125-A	89406	
5C3Z18124JA	G63969		60670012	83168		87HU18045AA	85301		9U9Z-18125-B	83122	89406
5C3Z18125CF	77969		60675-003	85976		8A4Z 18183-C	143415		9U9Z-18125-B	89406	
5C3Z18125DA	77968		60675-003L	85976		8A8Z 18125-E	G51996		9U9Z18124A	83209	89414
5L1Z 18125-A	G57016		60675-014	85978		8C24-18045-DA	G63622		9U9Z18124A	89414	
5L2Z 18124-CA	G57018		60675003	85976		8C24-18080-DB	G63623		9U9Z18124B	83209	89414
5L2Z 18124-CB	G57019		60675003L	85976		8C2418045DA	G63622		9U9Z18124B	89414	
5L3Z-18125-AA	G63867		60675014	85978		8C2418045DA	G63625		9U9Z18125A	83122	89406
5U2Z-18V124-AA	G63714		680029	85301		8C2418080DB	G63623		9U9Z18125A	89406	
5U2Z-18V124-AHA	G63622		6C2Z-18124-A	G63622		8C2Z 18124-B	G63622		9U9Z18125B	83122	89406
5U2Z-18V124-AU	G63772		6C2Z-18124-B	G63929		8C2Z 18124-C	G63622		9U9Z18125B	89406	
5U2Z-18V124-BA	G63716		6C2Z18124B	G63929		8C2Z 18125-D	G63623		AA-494	83131	
5U2Z-18V124-CAA	G63809		6E5Z 18124-BL	G51859		8C2Z 18124-A	G63622		AA-615	83135	
5U2Z-18V124-DB	G63455		6E5Z-18124-BR	G51859		8C2Z-18124-D	G63622		AA-616	83175	
5U2Z-18V124-GA	G63809		6E5Z-18125-BA	69591		8C2Z-18125-A	G63623		AA-617	85928	
5U2Z-18V124-LA	G63929		6E7O-18B038-AA	83364		8C2Z-18125-B	G63623		AA-619	85927	
5U2Z-18V125-AE	G63808		6E7O18B038AA	83364		8C2Z-18125-C	G63623		AA-620	83101	
5U2Z-18V125-AF	G63810		6E7Z-18124-AB	83364		8C2Z-18125-D	G63623		AA494	83131	
5U2Z-18V125-BDA	G63623		6E7Z18124AB	83364		8C2Z18124D	G63622		AA615	83135	
5U2Z-18V125-BGA	G63778		6ETZ-18125-A	83364		8C2Z18124D	G63624		AA616	83175	
5U2Z-18V125-BS	G63607		6ETZ18125A	83364		8C2Z18125A	G63623		AA617	85928	
5U2Z-18V125-BT	G63525		6L1Z 18124-DD	G57015		8C2Z18125B	G63623		AA619	85927	
5U2Z-18V125-BU	G63524		6L1Z 18125-AA	G57016		8C2Z18125C	G63623		AA620	83101	
5U2Z-18V125-F	G63676		6L1Z 18125-AB	G57016		8C2Z18125D	G63623		AE5Z 18124-A	G57427	
5U2Z-18V125-G	G63837		6L7Z 18124-BC	G57015		8C3Z-3E651-E	14072		AE5Z 18124-B	G57427	
5U2Z-18V125-H	G63406		6U2Z-18V125-A	G63837		8L1Z 18125-B	G57173		AE5Z 18124-C	G57427	
5U2Z-18V125-VG	69845		6U2Z-18V125-B	G63607		8L1Z 18125-C	G57173		AE5Z 18124-D	G57427	
5U2Z-3V651-C	6828SE		6U2Z18V125A	G63837		8L1Z 18125-H	G57173		AE5Z 18124-E	G57427	

Important Note: Competitive Interchanges are to be used for stocking purposes only. Where multiple crosses are identified, please reference the applications section of this catalog. / **Remarque importante:** Les interchanges concurrentiels ne s'utilisent qu'aux fins de stocks. Dans le cas de rferences multiples, consulter la section des applications du catalogue. / **Nota importante:** Dans le cas de rferences multiples, consulter la section des applications du catalogue. / **Nota importante:** Se pueden usar intercambios competitivos para propósitos de almacenamiento solamente. Cuando se identifican intercambios múltiples, consulte la sección de aplicaciones de este catálogo.

COMPETITIVE & O.E.M. INTERCHANGE LIST
Lista de Intercambios contra Competidores y Equipo Original.
Liste dinterchange de produits comptitifs & dquipement original (OEM)

Ford... cont'd

Ford	Gabriel	Upgrade	Ford	Gabriel	Upgrade	Ford	Gabriel	Upgrade	Ford	Gabriel	Upgrade
AE5Z 18124-F	G57427		ASH-1230	83122	89406	ASH1205	89414		AT-696	83140	
AE5Z 18124-J	G57427		ASH-1230	89406		ASH1206	83122	89406	AT-766	83209	89414
AE5Z 18124-K	G57427		ASH-137	83122	89406	ASH1206	89406		AT-766	89414	
AE5Z 18125-A	69591		ASH-137	89406		ASH12251	85013	89414	AT-811	83135	
AE5Z 18125-B	69591		ASH-23486	G63461		ASH12251	89414		AT-812	85928	
AE5Z 18125-C	69591		ASH-23488	G63461		ASH12261	85010		AT163G	G63622	
AE5Z 18125-G	69591		ASH-24446	83215		ASH1228	83209	89414	AT163G	G63623	
AG1Z 18124-A	G57498		ASH-2447	83140		ASH1228	89414		AT164G	G63623	
AG1Z 18124-B	G57497		ASH-24473	85013	89414	ASH1229	83209	89414	AT504G	G63679	
AG1Z 18124-C	G57498		ASH-24473	89414		ASH1229	89414		AT610	G63461	
AG1Z 18124-D	G57497		ASH-24474	85010		ASH1230	83122	89406	AT611	G63461	
AG1Z 18124-E	G57498		ASH-24522	85013	89414	ASH1230	89406		AT620	83209	89414
AG1Z 18124-F	G57497		ASH-24522	89414		ASH137	83122	89406	AT620	89414	
AG1Z 18124-G	G57497		ASH-24523	85010		ASH137	89406		AT621	83122	89406
AG1Z 18124-H	G57498		ASH-24589	85010		ASH23486	G63461		AT621	89406	
AH6Z 18124-D	G51896		ASH-24634	85013	89414	ASH23488	G63461		AT696	83140	
AH6Z-18124-C	G51897		ASH-24634	89414		ASH24446	83215		AT766	83209	89414
AL1Z 18124-D	G51860		ASH-24658	85181		ASH2447	83140		AT766	89414	
AL1Z 18125-A	G57173		ASH-24659	85181		ASH24473	85013	89414	AT811	83135	
AL1Z 18125-D	G51861		ASH-24660	85180		ASH24473	89414		AT812	85928	
AL1Z 18125-F	G51861		ASH-24661	83317		ASH24474	85010		AU2Z 18124-H	G57015	
AL3Z 18124-BA	G51865		ASH-24662	83168		ASH24522	85013	89414	AU2Z 18125-E	G57016	
AL3Z 18124-DA	G57103		ASH-24663	83148		ASH24522	89414		AU2Z-18V124-AC	G63886	
AL3Z 18124-EA	G57103		ASH-247	G63461		ASH24589	85010		AU2Z-18V124-AU	G63622	
AL3Z 18124-GA	G51864		ASH-25770	77987		ASH24634	85013	89414	AU2Z-18V124-AY	G63714	
AL3Z 18124-RB	G51865		ASH-25820	85005	89430	ASH24634	89414		AU2Z-18V124-BB	G63714	
AL3Z 18124-SB	G57103		ASH-25820	89430		ASH24658	85181		AU2Z-18V124-BH	G63716	
AL3Z 18125-E	G64157		ASH-25821	85006		ASH24659	85181		AU2Z-18V124-J	G63886	
AL3Z 18125-G	G64079		ASH-25822	83209	89414	ASH24660	85180		AU2Z-18V125-BD	G63715	
AL3Z 18125-H	G64079		ASH-25822	89414		ASH24661	83317		AU2Z-18V125-S	G63888	
AL3Z 18125-K	G64157		ASH-25823	83209	89414	ASH24662	83168		AX-267A	83309	
AL3Z 18125-L	G64079		ASH-25823	89414		ASH24663	83148		AX-310	83215	
AL3Z-18124-AA	G51865		ASH-25824	83122	89406	ASH247	G63461		AX267A	83309	
AL3Z-18125-D	G64157		ASH-25824	89406		ASH25820	85005	89430	AX310	83215	
ALK3Z 18124-GA	G57103		ASH-25838	85978		ASH25820	89430		AX85A	83219	
ASH-1022	83209	89414	ASH-294	83209	89414	ASH25821	85006		B3Q-18124-A	83219	
ASH-1022	89414		ASH-294	89414		ASH25822	83209	89414	B3Q18124A	83219	
ASH-1023	83122	89406	ASH-397	83131		ASH25822	89414		B6TZ-18124-A	83219	
ASH-1023	89406		ASH-722	85976		ASH25823	83209	89414	B6TZ18124A	83219	
ASH-1105	85976		ASH-85789	77986		ASH25823	89414		B7T-18124-C	83225	
ASH-1136	G63623		ASH-85856	77987		ASH25824	83122	89406	B7T18124C	83225	
ASH-1154	G63622		ASH-85857	77987		ASH25824	89406		B7TZ-18124-B	83216	
ASH-1161	85006		ASH-85927	77986		ASH25838	85978		B7TZ-18124-C	83216	
ASH-1162	85005	89430	ASH-866127	77986		ASH294	83209	89414	B7TZ-18124-D	83219	
ASH-1162	89430		ASH-866139	77986		ASH294	89414		B7TZ18124B	83216	
ASH-1205	83209	89414	ASH1022	83209	89414	ASH397	83131		B7TZ18124C	83216	
ASH-1205	89414		ASH1022	89414		ASH722	85976		B7TZ18124D	83219	
ASH-1206	83122	89406	ASH1023	83122	89406	AT-163G	G63622		B8Q-18125-A	85307	
ASH-1206	89406		ASH1023	89406		AT-164G	G63623		B8Q18125A	85307	
ASH-12251	85013	89414	ASH1105	85976		AT-504G	G63679		B8QZ-18124-A	83312	89409
ASH-12251	89414		ASH1136	G63623		AT-610	G63461		B8QZ-18124-A	89409	
ASH-12261	85010		ASH1154	G63622		AT-611	G63461		B8QZ18124A	83312	89409
ASH-1228	83209	89414	ASH1161	85006		AT-620	83209	89414	B8QZ18124A	89409	
ASH-1228	89414		ASH1162	85005	89430	AT-620	89414		B8TZ-18124-A	83219	
ASH-1229	83209	89414	ASH1162	89430		AT-621	83122	89406	B8TZ18124A	83219	
ASH-1229	89414		ASH1205	83209	89414	AT-621	89406		B9TT-18045-C	83219	

Important Note: Competitive Interchanges are to be used for stocking purposes only. Where multiple crosses are identified, please reference the applications section of this catalog. / **Remarque importante:** Les interchanges concurrentiels ne s'utilisent qu'aux fins de stocks. Dans le cas de rfrences multiples, consulter la section des applications du catalogue. / **Nota importante:** Dans le cas de rfrences multiples, consulter la section des applications du catalogue. / **Nota importante:** Se pueden usar intercambios competitivos para propósitos de almacenamiento solamente. Cuando se identifican intercambios múltiples, consulte la sección de aplicaciones de este catálogo.

COMPETITIVE & O.E.M. INTERCHANGE LIST
Lista de Intercambios contra Competidores y Equipo Original.
Liste dinterchange de produits comptitifs & dquipement original (OEM)

Ford... cont'd

Ford	Gabriel	Upgrade	Ford	Gabriel	Upgrade	Ford	Gabriel	Upgrade	Ford	Gabriel	Upgrade
B9TT-18045-D	83219		BU9Z-18124-A	85013	89414	C2TA-18045-A	83216		C6TA18045Y	85301	
B9TT18045C	83219		BU9Z-18124-A	89414		C2TA-18045-B	83308		C6TA18045Z	85301	
B9TT18045D	83219		BU9Z-18125-A	85010		C2TA18045A	83216		C6TZ-18124-D	85301	
BC3Z 18124-AA	G63886		BU9Z18124A	85013	89414	C2TA18045B	83308		C6TZ-18124-E	85301	
BC3Z 18124-B	G63622		BU9Z18124A	89414		C2TZ-18124-A	83308		C6TZ-18124-H	85301	
BC3Z 18124-C	G63622		BU9Z18125A	85010		C2TZ18124A	83308		C6TZ-18124-J	85301	
BC3Z 18124-K	G63886		BV6Z 18125-B	G511002		C3TA-18045-A	83216		C6TZ18124D	85301	
BC3Z 18124-M	G63886		BV6Z 18125-C	G511002		C3TA18045A	83216		C6TZ18124E	85301	
BC3Z 18124-N	G63886		BV6Z 18125-D	G511002		C3TZ-18124-A	83308		C6TZ18124H	85301	
BC3Z 18124-R	G63886		BV6Z 18125-E	G511002		C3TZ18124A	83308		C6TZ18124J	85301	
BC3Z 18124-T	G63886		BV6Z 18125-F	G511002		C4HZ-18124-A	83312	89409	C7HZ-18124-A	83312	89409
BC3Z 18124-U	G63886		BV6Z 18125-G	G511002		C4HZ-18124-A	89409		C7HZ-18124-A	89409	
BC3Z 18124-X	G63886		C0TT-18045-A	83219		C4HZ-18124-B	83309		C7HZ18124A	83312	89409
BC3Z 18124-Y	G63886		C0TT-18045-D	83216		C4HZ-18124-C	83314		C7HZ18124A	89409	
BC3Z 18124-Z	G63886		C0TT18045A	83219		C4HZ-18124-D	83312	89409	C7PF-18077-A	83225	
BC3Z 18125-A	G64010		C0TT18045D	83216		C4HZ-18124-D	89409		C7PF18077A	83225	
BC3Z 18125-AE	G63888		C0TZ-18124-A	83216		C4HZ-18124-E	83309		C7TA-18045-R	83216	
BC3Z 18125-AF	G63888		C0TZ18124A	83216		C4HZ-18124-F	83308		C7TA-18045-Z	85301	
BC3Z 18125-AL	G63888		C1BZ 18124-B	G52255		C4HZ18124A	83312	89409	C7TA18045R	83216	
BC3Z 18125-B	G64010		C1BZ 18124-E	G52256		C4HZ18124A	89409		C7TA18045Z	85301	
BC3Z 18125-J	G63888		C1TT-18045-C	83312	89409	C4HZ18124B	83309		C8HA-18045-A	83312	89409
BC3Z 18125-L	G63888		C1TT-18045-C	89409		C4HZ18124C	83314		C8HA-18045-A	89409	
BC3Z 18125-M	G63888		C1TT-18045-D	G63406		C4HZ18124D	83312	89409	C8HA18045A	83312	89409
BC3Z 18125-N	G63888		C1TT-18045-E	83314		C4HZ18124D	89409		C8HA18045A	89409	
BC3Z 18125-R	G63888		C1TT-18045-G	83216		C4HZ18124E	83309		C8PF-18045-CM	83216	
BC3Z-18124-A	G63622		C1TT18045C	83312	89409	C4HZ18124F	83308		C8PF18045CM	83216	
BC3Z-18124-AB	G63886		C1TT18045C	89409		C4PF-18045-H	83216		C8TA-18045-AA	G63386	
BC3Z-18124-AC	77967		C1TT18045D	G63406		C4PF18045H	83216		C8TA18045AA	G63386	
BC3Z-18124-F	G63886		C1TT18045E	83314		C4TZ-18124-AA	83308		CA8Z 18125-A	G51996	
BC3Z-18124-G	G63886		C1TT18045G	83216		C4TZ-18124-AB	83308		CA8Z 18125-B	G51996	
BC3Z-18125-AA	G64010		C1TZ-18045-C	83312	89409	C4TZ-18124-B	83308		CG1Z 18125-A	70096	
BC3Z-18125-AJ	G63888		C1TZ-18045-C	89409		C4TZ18124AA	83308		CG1Z 18125-B	70096	
BC3Z-18125-AN	G64010		C1TZ-18124-B	83216		C4TZ18124AB	83308		CG1Z 18125-C	70096	
BC3Z-18125-AP	77969		C1TZ-18124-C	83312	89409	C4TZ18124B	83308		CG1Z 18125-D	70096	
BC3Z-18125-AQ	77969		C1TZ-18124-C	89409		C5TZ-18124-A	83308		CK4Z-18124-E	G57816	
BC3Z-18125-F	61682		C1TZ-18124-D	83309		C5TZ18124A	83308		CL3Z 18124-B	G57103	
BC3Z-18125-V	G63888		C1TZ-18124-E	83312	89409	C6PF-18077-A	G63306		CL8Z 18125-A	G64047	
BE8Z 18124-A	G52256		C1TZ-18124-E	89409		C6PF-18077-DD	83216		CL8Z 18125-B	G64047	
BE8Z 18124-B	G52255		C1TZ-18124-F	83312	89409	C6PF-18077-DE	83219		CL8Z 18125-C	G64047	
BE8Z 18124-C	G52256		C1TZ-18124-F	89409		C6PF-18077-DL	83312	89409	CT4Z 18124-A	G52351	
BE8Z 18124-D	G52255		C1TZ-18124-N	83314		C6PF-18077-DL	89409		CT4Z 18124-B	G52352	
BE8Z 18125-A	70052		C1TZ-18124-P	83312	89409	C6PF-18077-DN	83314		CT4Z 18125-A	G64111	
BE8Z 18125-B	70052		C1TZ-18124-P	89409		C6PF-18077-F	83225		CU9Z-18124-A	85013	89414
BK3Z-18124-A	G57816		C1TZ18045C	83312	89409	C6PF18077A	G63306		CU9Z-18124-A	89414	
BL3Z 18124-C	G51865		C1TZ18045C	89409		C6PF18077DD	83216		CU9Z-18125-A	85010	
BL3Z 18124-F	G57103		C1TZ18124B	83216		C6PF18077DE	83219		CU9Z18124A	85013	89414
BL3Z 18125-C	G64157		C1TZ18124C	83312	89409	C6PF18077DL	83312	89409	CU9Z18124A	89414	
BL3Z 18125-F	G64079		C1TZ18124C	89409		C6PF18077DL	89409		CU9Z18125A	85010	
BT4Z 18124-C	G52351		C1TZ18124D	83309		C6PF18077DN	83314		CV6Z 18125-P	G511001	
BT4Z 18124-D	G52352		C1TZ18124E	83312	89409	C6PF18077F	83225		CV6Z 18125-Q	G511001	
BT4Z 18124-E	G52352		C1TZ18124E	89409		C6TA-18045-U	85301		D0HA-18045-D	83309	
BT4Z 18124-EC	G52351		C1TZ18124F	83312	89409	C6TA-18045-V	85301		D0HA-18045-E	83312	89409
BU2Z-18V124-E	83107		C1TZ18124F	89409		C6TA-18045-Y	85301		D0HA-18045-E	89409	
BU2Z-18V125-F	G64010		C1TZ18124N	83314		C6TA-18045-Z	85301		D0HA18045D	83309	
BU2Z18V124E	83107		C1TZ18124P	83312	89409	C6TA18045U	85301		D0HA18045E	83312	89409
BU2Z18V125P	G63778		C1TZ18124P	89409		C6TA18045V	85301		D0HA18045E	89409	

Important Note: Competitive Interchanges are to be used for stocking purposes only. Where multiple crosses are identified, please reference the applications section of this catalog. / **Remarque importante:** Les interchanges concurrentiels ne s'utilisent qu'aux fins de stocks. Dans le cas de rferences multiples, consulter la section des applications du catalogue. / **Nota importante:** Dans le cas de rferences multiples, consulter la section des applications du catalogue. / **Nota importante:** Se pueden usar intercambios competitivos para propósitos de almacenamiento solamente. Cuando se identifican intercambios múltiples, consulte la sección de aplicaciones de este catálogo.

COMPETITIVE & O.E.M. INTERCHANGE LIST
Lista de Intercambios contra Competidores y Equipo Original.
Liste d'interchange de produits complitifs & d'equipement original (OEM)

Ford... cont'd

Ford	Gabriel	Upgrade	Ford	Gabriel	Upgrade	Ford	Gabriel	Upgrade	Ford	Gabriel	Upgrade
D0HZ-18124-A	83309		D2HF18045CA	83308		D2TZ-18124-G	83314		D7HT-18045-HA	89413	
D0HZ-18124-B	83312	89409	D2HF18045DA	83312	89409	D2TZ-18124-H	83308		D7HT-18045-JA	83308	
D0HZ-18124-B	89409		D2HF18045DA	89409		D2TZ-18124-J	83312	89409	D7HT-18045-NA	85301	
D0HZ-18124-C	83314		D2HF18124AA	83314		D2TZ-18124-J	89409		D7HT-18080-BA	83225	
D0HZ18124A	83309		D2HT-18045-CA	83314		D2TZ18124A	83308		D7HT-18080-CA	83225	
D0HZ18124B	83312	89409	D2HT-18045-EA	83312	89409	D2TZ18124E	83312	89409	D7HT-18080-DA	83215	
D0HZ18124B	89409		D2HT-18045-EA	89409		D2TZ18124E	89409		D7HT-18124-BA	83312	89409
D0HZ18124C	83314		D2HT-18045-GA	83308		D2TZ18124F	83309		D7HT-18124-BA	89409	
D1TF-18045-LA	83312	89409	D2HT-18080-HA	83225		D2TZ18124G	83314		D7HT-18124-CA	83314	
D1TF-18045-LA	89409		D2HT18045CA	83314		D2TZ18124H	83308		D7HT-18124-DA	83309	
D1TF18045LA	83312	89409	D2HT18045EA	83312	89409	D2TZ18124J	83312	89409	D7HT-18124-EA	83312	89409
D1TF18045LA	89409		D2HT18045EA	89409		D2TZ18124J	89409		D7HT-18124-EA	89409	
D1TZ-18124-D	83308		D2HT18045GA	83308		D3TA-18045-BA	83219		D7HT-18124-FA	83312	89409
D1TZ-18124-E	83216		D2HT18080HA	83225		D3TA18045BA	83219		D7HT-18124-FA	89409	
D1TZ-18124-F	83312	89409	D2HZ-18080-A	83209	89414	D3TZ-18124-B	83219		D7HT-18124-GA	83308	
D1TZ-18124-F	89409		D2HZ-18080-A	89414		D3TZ18124B	83219		D7HT-18124-HA	83219	
D1TZ18124D	83308		D2HZ-18125-A	83209	89414	D4HA-18080-A	83209	89414	D7HT-18124-JA	83308	
D1TZ18124E	83216		D2HZ-18125-A	89414		D4HA-18080-A	89414		D7HT-18124-KA	85301	
D1TZ18124F	83312	89409	D2HZ-18125-B	83209	89414	D4HA-18080-AA	83209	89414	D7HT-18125-DA	83215	
D1TZ18124F	89409		D2HZ-18125-B	89414		D4HA-18080-AA	89414		D7HT-18125-FA	83123	89405
D2EF-18045-AA	83312	89409	D2HZ18080A	83209	89414	D4HA18080A	83209	89414	D7HT-18125-FA	89405	
D2EF-18045-AA	89409		D2HZ18080A	89414		D4HA18080A	89414		D7HT18045BA	83312	89409
D2EF-18124-AA	83312	89409	D2HZ18125A	83209	89414	D4HA18080AA	83209	89414	D7HT18045BA	89409	
D2EF-18124-AA	89409		D2HZ18125A	89414		D4HA18080AA	89414		D7HT18045CA	83314	
D2EF18045AA	83312	89409	D2HZ18125B	83209	89414	D4TF-18045-AA	83312	89409	D7HT18045CA	83309	
D2EF18045AA	89409		D2HZ18125B	89414		D4TF-18045-AA	89409		D7HT18045EA	83312	89409
D2EF18124AA	83312	89409	D2KF-18045-AA	83312	89409	D4TF18045AA	83312	89409	D7HT18045EA	89409	
D2EF18124AA	89409		D2KF-18045-AA	89409		D4TF18045AA	89409		D7HT18045GA	83308	
D2HA-18045-E1A	85304		D2KF-18124-AA	83312	89409	D4TF-18124-J	83308		D7HT18045JA	83308	
D2HA-18045-E1B	85304		D2KF-18124-AA	89409		D4TZ-18124J	83308		D7HT18045NA	85301	
D2HA-18045-E2A	85304		D2KF18045AA	83312	89409	D5TZ-18124-B	83308		D7HT18080BA	83225	
D2HA-18045-E2B	85304		D2KF18045AA	89409		D5TZ-18124-C	83312	89409	D7HT18080DA	83215	
D2HA-18045-EB	85301		D2KF18124AA	83312	89409	D5TZ-18124-C	89409		D7HT18124BA	83312	89409
D2HA-18045-F1A	85301		D2KF18124AA	89409		D5TZ18124B	83308		D7HT18124BA	89409	
D2HA-18045-F1B	85301		D2TA-18045-AAA	83219		D5TZ18124C	83312	89409	D7HT18124CA	83314	
D2HA-18045-F2A	85301		D2TA-18045-ZA	83219		D5TZ18124C	89409		D7HT18124DA	83309	
D2HA-18045-F2B	85301		D2TA18045AAA	83219		D7HA-18080-AA	83123	89405	D7HT18124EA	83312	89409
D2HA18045E1A	85304		D2TA18045ZA	83219		D7HA-18080-AA	89405		D7HT18124EA	89409	
D2HA18045E1B	85304		D2TF-18045-AA	83312	89409	D7HA18080AA	83123	89405	D7HT18124FA	83312	89409
D2HA18045E2A	85304		D2TF-18045-AA	89409		D7HA18080AA	89405		D7HT18124FA	89409	
D2HA18045E2B	85304		D2TF-18045-FA	83312	89409	D7HF-18045-FA	83312	89409	D7HT18124GA	83308	
D2HA18045EB	85301		D2TF-18045-FA	89409		D7HF-18045-FA	89409		D7HT18124HA	83219	
D2HA18045F1A	85301		D2TF-18045-GA	83308		D7HF-18080-AA	83215		D7HT18124JA	83308	
D2HA18045F1B	85301		D2TF-18080-HA	83225		D7HF-18125-AA	83215		D7HT18124KA	85301	
D2HA18045F2A	85301		D2TF-18124-F	83309		D7HF18045FA	83312	89409	D7HT18125DA	83215	
D2HA18045F2B	85301		D2TF18045AA	83312	89409	D7HF18045FA	89409		D7HT18125FA	83123	89405
D2HF-18045-A	83314		D2TF18045AA	89409		D7HF18080AA	83215		D7HT18125FA	89405	
D2HF-18045-AA	83314		D2TF18045FA	83312	89409	D7HF18125AA	83215		D7HZ-18125-A	83215	
D2HF-18045-BA	83309		D2TF18045FA	89409		D7HT-18045-BA	83312	89409	D7HZ18125A	83215	
D2HF-18045-CA	83308		D2TF18045GA	83308		D7HT-18045-BA	89409		D7KF-18045-EA	83312	89409
D2HF-18045-DA	83312	89409	D2TF18080HA	83225		D7HT-18045-CA	83314		D7KF-18045-EA	89409	
D2HF-18045-DA	89409		D2TF18124F	83309		D7HT-18045-DA	83309		D7KF18045EA	83312	89409
D2HF-18124-AA	83314		D2TZ-18124-A	83308		D7HT-18045-EA	83312	89409	D7KF18045EA	89409	
D2HF18045A	83314		D2TZ-18124-E	83312	89409	D7HT-18045-EA	89409		D7TA-18124-GA	83314	
D2HF18045AA	83314		D2TZ-18124-E	89409		D7HT-18045-GA	83308		D7TA18124GA	83314	
D2HF18045BA	83309		D2TZ-18124-F	83309		D7HT-18045-HA	85012	89413	D8HZ-18124-A	85301	

Important Note: Competitive Interchanges are to be used for stocking purposes only. Where multiple crosses are identified, please reference the applications section of this catalog. / **Remarque importante:** Les interchanges concurrentiels ne s'utilisent qu'aux fins de stocks. Dans le cas de références multiples, consulter la section des applications du catalogue. / **Nota importante:** Dans le cas de références multiples, consulter la section des applications du catalogue. / **Nota importante:** Se pueden usar intercambios competitivos para propósitos de almacenamiento solamente. Cuando se identifican intercambios múltiples, consulte la sección de aplicaciones de este catálogo.

COMPETITIVE & O.E.M. INTERCHANGE LIST
Lista de Intercambios contra Competidores y Equipo Original.
Liste dinterchange de produits comptitifs & dquipement original (OEM)

Ford... cont'd

Ford	Gabriel	Upgrade	Ford	Gabriel	Upgrade	Ford	Gabriel	Upgrade	Ford	Gabriel	Upgrade
D8HZ-18125-A	83209	89414	E1TD18045AA	83309		EL3Z 18124-L	G57683		F1HZ-18124-E	85006	
D8HZ-18125-A	89414		E5HT-18045-AA	85301		F0HS-18045-AA	85006		F1HZ-18124-F	85006	
D8HZ-18125-B	83123	89405	E5HT-18045-DA	85301		F0HS18045AA	85006		F1HZ-18124-G	85006	
D8HZ-18125-B	89405		E5HT-18045-EA	85301		FOHT-18045-AA	85006		F1HZ-18124-H	85040	
D8HZ18124A	85301		E5HT-18080-DA	85315		FOHT-18045-CA	85006		F1HZ-18124-J	83308	
D8HZ18125A	83209	89414	E5HT-18080-EA	85315		FOHT-18080-AA	83122	89406	F1HZ-18124-K	89402	
D8HZ18125A	89414		E5HT18045AA	85301		FOHT-18080-AA	89406		F1HZ18124A	83309	
D8HZ18125B	83123	89405	E5HT18045DA	85301		FOHT18045AA	85006		F1HZ18124AA	83309	
D8HZ18125B	89405		E5HT18045EA	85301		FOHT18045CA	85006		F1HZ18124B	83308	
DA8Z 18125-A	G51996		E5HT18080DA	85315		FOHT18080AA	83122	89406	F1HZ18124C	89402	
DA8Z 18125-B	G51996		E5HT18080EA	85315		FOHT18080AA	89406		F1HZ18124D	85006	
DB5Z 18125-E	G51980		E6HT-18080-AA	83215		FOHZ-18124-A	85006		F1HZ18124E	85006	
DB5Z 18125-F	G51980		E6HT18080AA	83215		FOHZ-18124-B	85006		F1HZ18124F	85006	
DB5Z 18125-H	G51980		E6HZ-18124-A	85301		FOHZ-18125-A	83122	89406	F1HZ18124G	85006	
DB5Z-18125-G	G51980		E6HZ-18124-D	85301		FOHZ-18125-A	89406		F1HZ18124H	85040	
DG1Z 18124-AA	G57812		E6HZ-18125-D	83215		FOHZ18124A	85006		F1HZ18124J	83308	
DG1Z 18125-A	70096		E6HZ-18125-E	85315		FOHZ18124B	85006		F1HZ18124K	89402	
DG1Z 18125-F	70096		E6HZ-18125-F	85315		FOHZ18125A	83122	89406	F1SC-18008-AA	69845	
DG9Z 18124-AB	G57812		E6HZ18124A	85301		FOHZ18125A	89406		F1SC-18080-AA	69845	
DG9Z 18124-P	G57812		E6HZ18124D	85301		F1HT-18045-AA	83309		F1SZ-18125-B	69845	
DG9Z 18124-Q	G57812		E6HZ18125D	83215		F1HT-18045-CA	83308		F2HT-18045-BA	85376	
DG9Z 18124-T	G57812		E6HZ18125E	85315		F1HT-18045-CB	83216		F2HT-18045-CA	85376	
DG9Z 18124-Y	G57812		E6HZ18125F	85315		F1HT-18045-DA	83312	89409	F2HT-18045-DA	85006	
DG9Z 18124-Z	G57812		E7HZ-18124-A	85301		F1HT-18045-DA	89409		F2HT-18080-DA	85712	
DG9Z 18125-K	G51965		E7HZ18124A	85301		F1HT-18045-DB	83308		F2HT18045BA	85376	
DG9Z 18125-Q	G51965		E7XZ-18124-A	G63386		F1HT-18045-EA	89402		F2HT18045CA	85376	
DG9Z 18125-S	G51965		E7XZ-18124-C	G63511		F1HT-18045-EA	89402		F2HT18045DA	85006	
DG9Z 18125-T	G51965		E7XZ-18125-A	G63350		F1HT-18045-EB	85006		F2HT18080DA	85712	
DG9Z-18125-U	G51965		E7XZ-18125-B	G63387		F1HT-18045-GA	85006		F2HT18124A	85376	
DU94-18045-CB	85013	89414	E7XZ-18125-C	G63409		F1HT-18045-GB	85006		F2HZ-18124-B	85301	
DU94-18045-CB	89414		E7XZ-18125-D	G63406		F1HT-18045-HB	85006		F2HZ-18124-C	85006	
DU94-18080-CA	85010		E7XZ-18125-E	G63406		F1HT-18045-KB	85006		F2HZ-18124-CA	85006	
DU94-18080-CB	85010		E7XZ-18125-J	G63299		F1HT-18045-LB	85006		F2HZ-18125-A	85712	
DU9418080CA	85010		E7XZ18124A	G63386		F1HT-18045-NA	85040		F2HZ-18125-AA	85712	
DU9418080CB	85010		E7XZ18124C	G63511		F1HT-18045-RA	89402		F2HZ18124A	85376	
DU9Z-18124-A	85013	89414	E7XZ18124A	G63386		F1HT-18045-RB	89402		F2HZ18124B	85301	
DU9Z-18124-A	89414		E7XZ18125A	G63350		F1HT18045AA	83309		F2HZ18124C	85006	
DU9Z-18124-B	85013	89414	E7XZ18125B	G63387		F1HT18045CA	83308		F2HZ18124CA	85006	
DU9Z-18124-B	89414		E7XZ18125C	G63409		F1HT18045CB	83216		F2HZ18124CA	85006	
DU9Z-18124-B	89414		E7XZ18125D	G63406		F1HT18045CB	83216	89409	F2HZ18125A	85712	
DU9Z-18125-A	85010		E7XZ18125E	G63406		F1HT18045DA	83312		F2HZ18125AA	85712	
DU9Z-18125-B	85010		E7XZ18125J	G63299		F1HT18045DA	89409		F2HZ18125AA	85712	
DU9Z18124A	85013	89414	E9HS-18045-AA	83309		F1HT18045DB	83308		F4HT-18045-AB	83314	
DU9Z18124A	89414		E9HS-18080-AA	85716		F1HT18045EA	89402		F4HT-18045-AC	83314	
DU9Z18124B	85013	89414	E9HS-18080-AA	85716		F1HT18045EB	89402		F4HT-18045-CB	83107	
DU9Z18124B	89414		E9HS18045AA	83309		F1HT18045EB	89402		F4HT-18045-DA	85063	
DU9Z18124B	89414		E9HS18080AA	85716		F1HT18045GA	85006		F4HT-18045-EA	83125	
DU9Z18125A	85010		E9HS18080AA	85716		F1HT18045GB	85006		F4HT-18080-AA	85314	89425
DU9Z18125B	85010		E9HZ-18124-A	83309		F1HT18045GB	85006		F4HT-18080-AA	89425	
E0HT-18045-AA	83309		E9HZ-18125-A	85716		F1HT18045HB	85006		F4HT-18080-AA	89425	
E0HT-18045-AB	83309		E9HZ-18125-AA	85716		F1HT18045KB	85006		F4HT-18080-AB	85314	89425
E0HT18045AA	83309		E9HZ18124A	83309		F1HT18045LB	85006		F4HT-18080-AB	89425	
E0HT18045AB	83309		E9HZ18124A	83309		F1HT18045NA	85040		F4HT-18080-AB	89425	
E0HT18045AB	83309		E9HZ18125A	85716		F1HT18045NA	85040		F4HT-18080-AB	89425	
E0HZ-18124-A	83309		E9HZ18125AA	85716		F1HT18045RA	89402		F4HT-18080-BA	85001	89410
E0HZ18124A	83309		E9HZ18125AA	85716		F1HT18045RB	89402		F4HT-18080-BA	89410	
E1TA-18045-AA	83309		EL3Z 18124-D	G57683		F1HT18045RB	89402		F4HT18045AB	83314	
E1TA18045AA	83309		EL3Z 18124-E	G57683		F1HZ-18124-A	83309		F4HT18045AC	83314	
E1TD-18045-AA	83309		EL3Z 18124-F	G57683		F1HZ-18124-AA	83309		F4HT18045AC	83314	
			EL3Z 18124-G	G57683		F1HZ-18124-B	83308		F4HT18045CB	83107	
			EL3Z 18124-H	G57683		F1HZ-18124-C	89402		F4HT18045DA	85063	
			EL3Z 18124-I	G57683		F1HZ-18124-D	85006		F4HT18045EA	83125	
			EL3Z 18124-J	G57683							

Important Note: Competitive Interchanges are to be used for stocking purposes only. Where multiple crosses are identified, please reference the applications section of this catalog. / **Remarque importante:** Les interchanges concurrentiels ne s'utilisent qu'aux fins de stocks. Dans le cas de rferences multiples, consulter la section des applications du catalogue. / **Nota importante:** Dans le cas de rferences multiples, consulter la section des applications du catalogue. / **Nota importante:** Se pueden usar intercambios competitivos para propósitos de almacenamiento solamente. Cuando se identifican intercambios múltiples, consulte la sección de aplicaciones de este catálogo.

COMPETITIVE & O.E.M. INTERCHANGE LIST
Lista de Intercambios contra Competidores y Equipo Original.
Liste dinterchange de produits comptitifs & dquipement original (OEM)

Ford... cont'd

Ford	Gabriel	Upgrade	Ford	Gabriel	Upgrade	Ford	Gabriel	Upgrade	Ford	Gabriel	Upgrade
F4HT18080AA	85314	89425	F5TZ18124B	G63608		F6HT18045HB	85054		F6HZ18124J	89402	
F4HT18080AA	89425		F5TZ18125BC	G63607		F6HT18045HC	85054		F6HZ18124KA	89402	
F4HT18080AB	85314	89425	F5UZ-18124-A	G63622		F6HT18045JB	89402		F6HZ18124MA	85006	
F4HT18080AB	89425		F5UZ-18124-B	G63622		F6HT18045JC	89402		F6HZ18125A	85314	89425
F4HT18080BA	85001	89410	F5UZ-18125-A	G63623		F6HT18045KA	89402		F6HZ18125A	89425	
F4HT18080BA	89410		F5UZ-18125-C	G63624		F6HT18045LA	85376		F6HZ18125B	83109	
F4TA-18045-TA	G63455		F5UZ18124A	G63622		F6HT18045MA	85006		F6HZ18125D	85013	89414
F4TA-18080-PA	G63461		F5UZ18124B	G63622		F6HT18080B	83109		F6HZ18125D	89414	
F4TA18045TA	G63455		F5UZ18125A	G63623		F6HT18080CA	85314	89425	F6HZ18125JA	85305	
F4TA18080PA	G63461		F5UZ18125C	G63624		F6HT18080CA	89425		F6HZ5K407AB	83034	
F4TZ-18124-D	G63414		F6HT-18045-AA	85054		F6HT18080DA	83109		F77A-18045-AA	G63608	
F4TZ-18124-K	G63455		F6HT-18045-AC	85054		F6HT18080EA	85906	89407	F77A-18080-AA	G63679	
F4TZ-18125-E	G63461		F6HT-18045-BC	85047	89435	F6HT18080EA	89407		F77A-18080-BA	G63607	
F4TZ-18125-L	G63406		F6HT-18045-BC	89435		F6HT18080FC	85013	89414	F77A18045AA	G63608	
F4TZ18124D	G63414		F6HT-18045-CC	85055	89439	F6HT18080FC	89414		F77A18080AA	G63679	
F4TZ18124K	G63455		F6HT-18045-CC	89439		F6HT18080JA	85305		F77A18080BA	G63607	
F4TZ18125E	G63461		F6HT-18045-EB	85055	89439	F6HT18124JC	89402		F77D-18080-BA	G63679	
F4TZ18125L	G63406		F6HT-18045-EB	89439		F6HT18124KA	89402		F77D18080BA	G63679	
F57Z-18125-AC	G63679		F6HT-18045-EC	85055	89439	F6HZ-18080-FC	85013	89414	F7C2Z-18124-BR	G63929	
F57Z-18125-BB	G63679		F6HT-18045-EC	89439		F6HZ-18080-FC	89414		F7C2Z18124BR	G63929	
F57Z18125AC	G63679		F6HT-18045-GB	85030	89440	F6HZ-18124-A	85054		F7TA-18045-AA	G63608	
F57Z18125BB	G63679		F6HT-18045-GB	89440		F6HZ-18124-B	83308		F7TA-18080-BA	G63607	
F5HZ-18124-A	83314		F6HT-18045-GC	85030	89440	F6HZ-18124-C	85055	89439	F7TA18045AA	G63608	
F5HZ-18124-AA	83314		F6HT-18045-GC	89440		F6HZ-18124-C	89439		F7TA18080BA	G63607	
F5HZ-18124-B	83107		F6HT-18045-HB	85054		F6HZ-18124-D	85055	89439	F81A-18080-DCA	G63461	
F5HZ-18124-C	85063		F6HT-18045-HC	85054		F6HZ-18124-D	89439		F81A-18080-ZC	83140	
F5HZ-18124-D	83125		F6HT-18045-JB	89402		F6HZ-18124-E	85055	89439	F81A18080DCA	G63461	
F5HZ-18124-DA	83125		F6HT-18045-JC	89402		F6HZ-18124-E	89439		F81A18080ZC	83140	
F5HZ-18125-A	85314	89425	F6HT-18045-KA	89402		F6HZ-18124-F	85055	89439	F81D-18045-CD	83209	89414
F5HZ-18125-A	89425		F6HT-18045-LA	85376		F6HZ-18124-F	89439		F81D-18045-CD	89414	
F5HZ-18125-AA	85314	89425	F6HT-18045-MA	85006		F6HZ-18124-G	85054		F81D-18080-CD	83122	89406
F5HZ-18125-AA	89425		F6HT-18080-B	83109		F6HZ-18124-H	85054		F81D-18080-CD	89406	
F5HZ-18125-B	85001	89410	F6HT-18080-CA	85314	89425	F6HZ-18124-I	89402		F81D18045CD	83209	89414
F5HZ-18125-B	89410		F6HT-18080-CA	89425		F6HZ-18124-J	89402		F81D18045CD	89414	
F5HZ-18125-BA	85001	89410	F6HT-18080-DA	83109		F6HZ-18124-KA	89402		F81D18080CD	83122	89406
F5HZ-18125-BA	89410		F6HT-18080-DA	83109		F6HZ-18124-MA	85006		F81D18080CD	89406	
F5HZ-18125-DA	85314	89425	F6HT-18080-EA	85906	89407	F6HZ-18125-A	85314	89425	F81Z-18124-AL	G63622	
F5HZ-18125-DA	89425		F6HT-18080-EA	89407		F6HZ-18125-A	89425		F81Z-18124-BK	G63809	
F5HZ18124A	83314		F6HT-18080-FC	85013	89414	F6HZ-18125-B	83109		F81Z-18124-CA	83209	89414
F5HZ18124AA	83314		F6HT-18080-FC	89414		F6HZ-18125-D	85013	89414	F81Z-18124-CA	89414	
F5HZ18124B	83107		F6HT-18080-JA	85305		F6HZ-18125-D	89414		F81Z-18124-PA	85928	
F5HZ18124C	85063		F6HT-18124-JC	89402		F6HZ-18125-JA	85305		F81Z-18125-DC	G63461	
F5HZ18124D	83125		F6HT-18124-KA	89402		F6HZ-5K407-AB	83034		F81Z-18125-FA	83122	89406
F5HZ18124DA	83125		F6HT18045AA	85054		F6HZ18080FC	85013	89414	F81Z-18125-FA	89406	
F5HZ18125A	85314	89425	F6HT18045AC	85054		F6HZ18080FC	89414		F81Z-18125-ZA	83140	
F5HZ18125A	89425		F6HT18045BC	85047	89435	F6HZ18124A	85054		F81Z18124AL	G63622	
F5HZ18125AA	85314	89425	F6HT18045BC	89435		F6HZ18124B	83308		F81Z18124BK	G63809	
F5HZ18125AA	89425		F6HT18045CC	85055	89439	F6HZ18124C	85055	89439	F81Z18124CA	83209	89414
F5HZ18125B	85001	89410	F6HT18045CC	89439		F6HZ18124C	89439		F81Z18124CA	89414	
F5HZ18125B	89410		F6HT18045EB	85055	89439	F6HZ18124D	85055	89439	F81Z18124CA	85928	
F5HZ18125BA	85001	89410	F6HT18045EB	89439		F6HZ18124D	89439		F81Z18125DC	G63461	
F5HZ18125BA	89410		F6HT18045EC	85055	89439	F6HZ18124E	85055	89439	F81Z18125FA	83122	89406
F5HZ18125DA	85314	89425	F6HT18045EC	89439		F6HZ18124E	89439		F81Z18125FA	89406	
F5HZ18125DA	89425		F6HT18045GB	85030	89440	F6HZ18124F	85055	89439	F81Z18125ZA	83140	
F5TZ-18124-B	G63608		F6HT18045GB	89440		F6HZ18124F	89439		F87A-18045-AH	G63772	
F5TZ-18125-BC	G63607		F6HT18045GC	85030	89440	F6HZ18124G	85054		F87A-18045-CC	G63678	
			F6HT18045GC	89440		F6HZ18124H	85054				

Important Note: Competitive Interchanges are to be used for stocking purposes only. Where multiple crosses are identified, please reference the applications section of this catalog. / **Remarque importante:** Les interchanges concurrentiels ne s'utilisent qu'aux fins de stocks. Dans le cas de références multiples, consulter la section des applications du catalogue. / **Nota importante:** Dans le cas de références multiples, consulter la section des applications du catalogue. / **Nota importante:** Se pueden usar intercambios competitivos para propósitos de almacenamiento solamente. Cuando se identifican intercambios múltiples, consulte la sección de aplicaciones de este catálogo.

COMPETITIVE & O.E.M. INTERCHANGE LIST
Lista de Intercambios contra Competidores y Equipo Original.
Liste dinterchange de produits complitifs & dquipement original (OEM)

Ford... cont'd

Ford	Gabriel	Upgrade	Ford	Gabriel	Upgrade	Ford	Gabriel	Upgrade	Ford	Gabriel	Upgrade
F87A-18045-JA	G63678		FK4Z-18124-N	G57816		HU9Z-18125-C	83122	89406	TFAA18080A	85307	
F87A-18080-AC	G63773		FK4Z-18125-C	G57816		HU9Z-18125-C	89406		THAB-18045-A	83219	
F87A-18080-BC	G63773		FL3Z-18125-K	G64157		HU9Z18124A	85006		THAB-18045-B	83219	
F87A18045AH	G63772		GL3Z 18124-B	G57683		HU9Z18124B	83209	89414	THAB18045A	83219	
F87A18045CC	G63678		GL3Z 18124-C	G57683		HU9Z18124B	89414		THAB18045B	83219	
F87A18045JA	G63678		GL3Z 18124-D	G57683		HU9Z18124C	83209	89414	TQSH-18045-A	83309	
F87A18080AC	G63773		GL3Z 18124-E	G57683		HU9Z18124C	89414		TQSH18045A	83309	
F87A18080BC	G63773		GL3Z-18125-E	G64079		HU9Z18125A	85005	89430	XC35-18045-AB	83131	
F87Z-18124-AA	G63772		GL3Z-18125-F	G64079		HU9Z18125A	89430		XC35-18045-AD	83131	
F87Z-18124-CA	G63678		GU2Z-18A092-P	G57132		HU9Z18125B	83122	89406	XC35-18045-JA	83131	
F87Z-18124-JA	G63678		HC3Z-18124-B	G63622		HU9Z18125B	89406		XC3518045AB	83131	
F87Z-18125-AA	G63773		HC3Z-18124-C	G63622		HU9Z18125C	83122	89406	XC3518045AD	83131	
F87Z-18125-BA	G63773		HC3Z-18124-G	G63622		HU9Z18125C	89406		XC3518045JA	83131	
F87Z-18125-CA	G63773		HC3Z-18124-J	77967		JL3Z 18124-D	G57683		XC3Z-18124-JA	83131	
F87Z-18125-RA	G63775		HC3Z-18124-U	G63886		JL3Z 18124-E	G57683		XC3Z18124JA	83131	
F87Z18124AA	G63772		HC3Z-18125-B	77987		JL3Z 18124-F	G57683		XC45-18045-AA	83216	
F87Z18124CA	G63678		HC3Z-18125-ED	77987		JL3Z 18124-B	G57683		XC4518045AA	83216	
F87Z18124JA	G63678		HC3Z-18125-EE	77987		JL3Z-18124-J	G57683		XL24-18045-BA	G63678	
F87Z18125AA	G63773		HC3Z-18125-EP	77986		KC3Z-3E651-C	14072		XL24-18045-EA	G63678	
F87Z18125BA	G63773		HC3Z-18125-X	77986		LC3Z-18125-J	77986		XL24-18045-JA	G63678	
F87Z18125CA	G63773		HG9Z 18124-A	G57812		LC3Z-18125-W	77986		XL24-18080-BA	G63679	
F87Z18125RA	G63775		HG9Z 18124-B	G57812		M5L3Z-18124-HA	G51703		XL24-18080-CA	G63679	
FB5Z 18125-A	G51980		HG9Z 18124-D	G57812		M5L3Z-18124-HA	G51704		XL24-18080-EA	G63679	
FB5Z 18125-B	G51980		HG9Z 18124-F	G57812		M5L3Z-18125-BA	G63867		XL2418045BA	G63678	
FB5Z 18125-D	G51980		HG9Z 18124-G	G57812		M5L3Z-18125-BA	G63870		XL2418045EA	G63678	
FB5Z-18125-E	G51980		HG9Z 18124-H	G57812		M7C3Z-18124-AKA	G63622		XL2418045JA	G63678	
FC44-18045-AB	85181		HG9Z 18124-J	G57812		MAA568	G63614		XL2418080BA	G63679	
FC44-18045-BB	85181		HG9Z 18124-K	G57812		MBE8Z-18124-A	G52256		XL2418080CA	G63679	
FC44-18080-AB	85180		HG9Z 18124-L	G57812		MBE8Z-18124-B	G52355		XL2418080EA	G63679	
FC4418045BB	85181		HG9Z 18124-M	G57812		MR-AB-415	G63678		XL2Z-18124-BA	G63678	
FC4418080AB	85180		HG9Z 18124-N	G57812		TACAA-18045-A	83216		XL2Z-18124-EA	G63678	
FC4Z-18124-A	85181		HG9Z 18124-P	G57812		TACAA18045A	83216		XL2Z-18124-JA	G63678	
FC4Z-18124-B	85181		HU9418045AA	83209	89414	TANNA-18045-A	83312	89409	XL2Z-18125-BA	G63679	
FC4Z-18124-HB	83135		HU9418045AA	89414		TANNA-18045-A	89409		XL2Z-18125-CA	G63679	
FC4Z-18125-A	85180		HU9418045BA	83209	89414	TANNA18045A	83312	89409	XL2Z-18125-EA	G63679	
FC4Z-18125-C	83168		HU9418045BA	89414		TANNA18045A	89409		XL2Z18124BA	G63678	
FC4Z-18125-D	83148		HU9Z-18045-AA	83209	89414	TDBA-18045-A	83219		XL2Z18124EA	G63678	
FC4Z-18125-E	85978		HU9Z-18045-BA	83209	89414	TDBA-18045-B	83219		XL2Z18124JA	G63678	
FC4Z18124A	85181		HU9Z-18124-A	85006		TDBA18045A	83219		XL2Z18125BA	G63679	
FC4Z18124B	85181		HU9Z-18124-B	83209	89414	TDBA18045B	83219		XL2Z18125CA	G63679	
FC4Z18124HB	83135		HU9Z-18124-B	89414		TDBE-18045-A	83219		XL2Z18125EA	G63679	
FC4Z18125A	85180		HU9Z-18124-C	83209	89414	TDBE18045A	83219		XL58-18080-AC	G63773	
FC4Z18125C	83168		HU9Z-18124-C	89414		TFAA-18045-B	83219		XL5818080AC	G63773	
FC4Z18125D	83148		HU9Z-18125-A	85005	89430	TFAA-18045-C	83219		XL5Z-18125-AA	G63773	
FC4Z18125E	85978		HU9Z-18125-A	89430		TFAA-18080-A	85307		XL5Z18125AA	G63773	
FK3Z-18124-M	G57816		HU9Z-18125-B	83122	89406	TFAA18045B	83219		YL5Z-18124-AA	G63772	
FK3Z-18125-C	G64177		HU9Z-18125-B	89406		TFAA18045C	83219		YL5Z18124AA	G63772	

General Motors

General motors	Gabriel	Upgrade	General motors	Gabriel	Upgrade	General motors	Gabriel	Upgrade	General motors	Gabriel	Upgrade
1-51630-168-1	83515		10368516	69587		12011043	83025		12020054	83021	
1-51630-217-0	83114		10379370	69590		1202-0012	83023		12021043	83025	
1-51630-217-1	83114		10443949	69676		1202-0032	83016		12474692	49213	
1-51630-219-1	83114		11569856	143366		1202-0054	83021		12474692	61528	
10363555	69589		1201-0054	83021		1202-1043	83025		12474694	49213	
10363583	143074		1201-1043	83025		12020012	83023		12474719	61544	
10363584	143073		12010054	83021		12020032	83016		12474719	G63489	

Important Note: Competitive Interchanges are to be used for stocking purposes only. Where multiple crosses are identified, please reference the applications section of this catalog. / **Remarque importante:** Les interchanges concurrentiels ne s'utilisent qu'aux fins de stocks. Dans le cas de rferences multiples, consulter la section des applications du catalogue. / **Nota importante:** Dans le cas de rferences multiples, consulter la section des applications du catalogue. / **Nota importante:** Se pueden usar intercambios competitivos para propósitos de almacenamiento solamente. Cuando se identifican intercambios múltiples, consulte la sección de aplicaciones de este catálogo.

COMPETITIVE & O.E.M. INTERCHANGE LIST
Lista de Intercambios contra Competidores y Equipo Original.
Liste dinterchange de produits comptitifs & dquipement original (OEM)

General Motors... cont'd

General motors	Gabriel	Upgrade	General motors	Gabriel	Upgrade	General motors	Gabriel	Upgrade	General motors	Gabriel	Upgrade
12474721	43180		15873313	49228		19241358	61718		19368462	61675	
12474721	49231		15873314	49228		19241359	69590		19368462	G63866	
12474721	58638		15887728	83136		19241437	143241		19402811	83397	
12474721	61565		1591501	85722		19257307	G63894		19403619	83397	
12474721	77638		15935605	43181		19257308	G63893		19403620	83397	
12474721	G63638		15935605	61600		19257309	G63894		19404855	83135	
12474915	83122	89406	15935611	58412		19257310	G63895		19407869	83397	
12474915	89406		15935611	61642		19257311	G63893		19407870	83398	
12474917	83137		15935611	77412		19286580	142316		19407871	83397	
12477893	49213		15935621	43181		19293025	143281		19407873	83398	
12477894	49213		15935625	58412		19294074	142245		19408176	85670	
12477894	61528		15935625	61642		19294075	142249		20757505	G64040	
13319741	G52435		15935625	77412		19294076	142245		20759948	49228	
13319742	G52436		15935629	61600		19294086	142317		20759949	49228	
13333974	G52435		15943270	61659		19294098	142526		20760400	G64040	
15023687	49213		15963161	83122	89406	19294099	142526		20765171	G51870	
15098725	G51718		15963161	89406		19294102	142530		20765189	G51870	
15098726	G51718		15998555	49213		19294112	143073		20765189	G57000	
15098727	G51718		18041276	69845		19294113	143074		20765189	G57023	
15123676	83136		19122332	G56773		19294115	142316		20784307	G64040	
15125521	G51718		19122333	G56774		19294124	143058		20808505	G64140	
1516301681	83515		19126029	61777		19294124	143059		20832848	G64040	
1516302170	83114		19132275	143057		19294294	143094		20832849	G64040	
1516302171	83114		19132276	143058		19294296	143425		20833776	G63959	
1516302191	83114		19132277	143059		19294297	143323		20837766	61690	
15172340	G63842		19132279	143061		19294298	143316		20837766	G63959	
15172342	G63842		19132376	143072		19294299	143061		20862317	G64040	
15174898	83136		19132377	143073		19294301	143063		20906289	G64121	
15174902	85071		19152843	83136		19294302	143064		20908412	G64148	
15195073	G51718		19152953	G57070		19294330	G57048		20908414	G64148	
15198894	G51718		19153639	G63884		19294331	G57047		20908415	G64148	
15206892	G63842		19153641	G51850		19294349	81930		20909154	G52127	
15211377	49228		19158776	58930		19295551	81318		20909155	G52128	
15211378	49228		19158788	61675		19295552	81873		20929418	70059	
15232939	143366		19158789	77953		19295553	81920		20930989	G63882	
15260892	G63842		19167562	81039		19295555	81922		20930995	G63879	
15294604	69589		19167562	G63355		19295556	81924		20944661	G51982	
15588554	83136		19168179	61641		19295557	81925		20955404	61690	
15642943	83136		19168179	G63783		19295558	69587		20955404	G63959	
15740554	83137		19168458	61643		19295559	69589		20955406	77975	
15743856	143241		19168458	G63803		19299843	49228		20955406	G64101	
15786900	49228		19171474	143089		19299843	49255		20955408	77975	
15786901	49228		19172175	6850SE		19300025	49228		20955408	G64101	
15789588	G51718		19172178	6853SE		19300034	49228		20955413	61690	
15789590	G51718		19177785	G51718		19300035	49228		20955413	G63959	
15791315	69589		19203623	G51746		19300057	58803		20955414	61690	
15806823	G64015		19203641	61687		19300057	61643		20955414	G63959	
15836873	143354		19208029	G52116		19300057	77803		20955415	61690	
15836873	143355		19208306	G52127		19300057	G63803		20955415	G63959	
15836874	143355		19208307	G52128		19307628	70031		20955417	61690	
15836875	143354		19235148	61683		19324428	G57048		20955417	G63959	
15836875	143355		19235151	61690		19324429	G57047		20955422	61690	
15840282	143316		19241354	61684		19324431	49255		20955422	G63959	
15845231	61718		19241355	61685		19325299	70059		20955425	61690	
15845231	G64015		19241356	49254		19359124	G511030		20955425	G63959	
15864982	G57070		19241357	61717		19368462	49235		20955427	G63959	

Important Note: Competitive Interchanges are to be used for stocking purposes only. Where multiple crosses are identified, please reference the applications section of this catalog. / **Remarque importante:** Les interchanges concurrentiels ne s'utilisent qu'aux fins de stocks. Dans le cas de rfrences multiples, consulter la section des applications du catalogue. / **Nota importante:** Dans le cas de rfrences multiples, consulter la section des applications du catalogue. / **Nota importante:** Se pueden usar intercambios competitivos para propósitos de almacenamiento solamente. Cuando se identifican intercambios múltiples, consulte la sección de aplicaciones de este catálogo.

COMPETITIVE & O.E.M. INTERCHANGE LIST
Lista de Intercambios contra Competidores y Equipo Original.
Liste d'interchange de produits complitifs & d'equiment original (OEM)

General Motors... cont'd

General motors	Gabriel	Upgrade	General motors	Gabriel	Upgrade	General motors	Gabriel	Upgrade	General motors	Gabriel	Upgrade
20955486	G51870		22046430	81492		22064858	61528		22891328	61690	
20955487	G51870		22046476	69714		22065218	G63347		22891328	G63959	
20955495	G51870		22046481	85702		22065228	69724		22896271	61690	
20955497	G51870		22046483	85304		22065228	81492		22896271	G63959	
20955498	G51870		22046489	85303	89422	22065251	85030	89440	22902421	G57109	
20955500	G51870		22046489	89422		22065251	89440		22902430	G57109	
20955506	G51870		2204683	85304		22165187	83136		22920115	143366	
20955513	G51891		22052014	85702		22165188	83136		22932447	70059	
20955514	G51870		22052336	85304		22165189	83136		22950375	G51982	
20956372	G63896		22064009	69715		22166442	83136		22969018	G52278	
20956377	61687		22064013	61524		22181548	69898		22969019	G52279	
20956377	G63897		22064013	G63349		22687770	143089		22986271	G63959	
20956378	G63896		22064019	61524		22687774	143089		23106628	G51949	
20956379	61687		22064019	G63349		22687780	143089		23106629	G57000	
20956379	G63897		22064034	69715		22695255	G63872		23106629	G57023	
20956380	61687		22064099	69715		22696400	69587		23106631	61690	
20956380	G63897		22064102	G56718		22698911	G52026		23106631	G63959	
20958798	G51891		22064226	61524		22698912	G52027		23106632	G63959	
20958799	G51891		22064226	G63349		22707166	G56809		23106633	61690	
20982300	G51982		22064229	69811		22707167	G56809		23106633	G63959	
22002293	83126	89430	22064230	83136		22712116	143354		23111833	143486	
22002293	89430		22064232	85071		22712116	143355		23124579	61690	
22002295	83303		22064233	83136		22716372	G57070		23124579	G63959	
22007700	83207	89407	22064417	61544		22716376	143354		23124580	61690	
22007700	89407		22064417	G63489		22716376	143355		23124580	G63959	
22007701	83126	89430	22064432	83221		22716378	143354		23124581	61690	
22007701	89430		22064445	81750		22716378	143355		23124581	G63959	
22007703	83303		22064445	G63421		22737714	G52280		23124582	61690	
22007750	83207	89407	22064573	G55825		22737715	G52281		23124582	G63959	
22007750	89407		22064619	61539		22737716	G52280		23124583	61690	
22007751	83303		22064619	G63454		22737717	G52281		23124583	G63959	
22007753	83303		22064635	58609		22737724	G51916		23124584	61690	
22012065	85304		22064635	61542		22761744	69589		23124584	G63959	
22012067	85700		22064635	77609		22761744	69590		23124585	61690	
22012082	85702		22064635	G63609		22769872	G57060		23124585	G63959	
22012083	85711		22064684	58609		22769873	G57060		23124591	G51949	
22012083GS	85711		22064684	61542		22773347	G64140		23124594	G51949	
22012090	85308	89422	22064684	77609		22796281	G55949		23124595	G51949	
22012090	89422		22064684	G63609		22796872	G55948		23124596	G51949	
22012091	85303	89422	22064776	G55698		22796873	G55948		23124598	G51949	
22012091	89422		22064781	G56509		22809066	G51916		23130121	G51949	
22012095	83126	89430	22064804	83136		22811082	G57069		23130122	G51949	
22012095	89430		22064805	83136		22811844	77975		23147603	G64040	
22012096	83221		22064806	83136		22811844	G64101		23147604	G64040	
22012114	85700		22064807	83136		22811853	G51891		23156080	G57000	
22012131	85711		22064829	61543		22811854	G51891		23156080	G57023	
22012166	83126	89430	22064829	G63488		22830632	G57000		23156081	G51949	
22012166	89430		22064830	58609		22830632	G57023		23156082	G57000	
22012169	83221		22064830	61542		22862538	G52128		23156082	G57023	
22012196	83221		22064830	61544		22865484	G64140		23156090	61690	
22017530	83303		22064830	77609		22872085	G52127		23156090	G63959	
22017531	83303		22064830	G63489		22872086	G52128		23156091	61690	
22024061	85704		22064830	G63609		22891309	G57000		23156091	G63959	
22025067	85704		22064845	49213		22891309	G57023		23163342	G52279	
22025305	85704		22064855	61531		22891310	G57000		23179308	G57000	
22045526	85702		22064858	49213		22891310	G57023		23179308	G57023	

Important Note: Competitive Interchanges are to be used for stocking purposes only. Where multiple crosses are identified, please reference the applications section of this catalog. / **Remarque importante:** Les interchanges concurrentiels ne s'utilisent qu'aux fins de stocks. Dans le cas de références multiples, consulter la section des applications du catalogue. / **Nota importante:** Dans le cas de références multiples, consulter la section des applications du catalogue. / **Nota importante:** Se pueden usar intercambios competitivos para propósitos de almacenamiento solamente. Cuando se identifican intercambios múltiples, consulte la sección de aplicaciones de este catálogo.

COMPETITIVE & O.E.M. INTERCHANGE LIST
Lista de Intercambios contra Competidores y Equipo Original.
Liste dinterchange de produits comptitifs & dquipement original (OEM)

General Motors... cont'd

General motors	Gabriel	Upgrade	General motors	Gabriel	Upgrade	General motors	Gabriel	Upgrade	General motors	Gabriel	Upgrade
23183580	77975		23452955	G64101		3182842	85711		4940650	83207	89407
23183580	G64101		23452959	G57000		3188599	85711		4940650	89407	
23183849	77975		23452959	G57023		3188626	85300	89419	4940654	83216	
23183849	G64101		23455253	70059		3188626	89419		4940660	83207	89407
23183850	G64101		23483689	G52435		3188729	85303	89422	4940660	89407	
23183864	G51949		25805824	G52128		3188729	89422		4940662	83126	89430
23183880	G57000		25815074	143366		3189265	85700		4940662	89430	
23183880	G57023		25820699	G63842		3192333	85700		4963844	85307	
23183892	G51949		25822945	G64040		3192416	85711		4963853	83216	
23216161	G63872		25831691	69590		3192657	83216		4963854	83216	
23218793	77975		25856156	143366		3192890	83126	89430	4974401	85700	
23218793	G64101		25870984	61690		3192890	89430		4975429	85300	89419
23269413	G55948		25870984	G63959		3192891	83221		4975429	89419	
23269413	G57060		25870986	61690		3192892	83221		4975467	83207	89407
23269415	G55948		25870986	G63959		35901-0001	83209	89414	4975467	89407	
23269415	G57060		25870987	61690		35901-0001	89414		4975479	83400	
23269416	G55949		25870987	G63959		35901-0003	85301		4975480	83400	
23269417	G55949		25870990	61690		35901-0004	83219		4975494	83207	89407
23275425	G57000		25870990	G63959		35901-0005	83219		4975494	89407	
23275425	G57023		25871019	61690		35901-0017	83314		4975497	83126	89430
23276075	G57000		25871019	G63959		359010001	83209	89414	4975497	89430	
23276075	G57023		25871023	61690		359010001	89414		4975501	85700	
23338789	G57000		25871023	G63959		359010003	85301		4975510	83221	
23338789	G57023		25871025	61690		359010004	83219		4975511	83303	
23338792	G57000		25871025	G63959		359010005	83219		4975516	85702	
23338792	G57023		25871036	61690		359010017	83314		4975518	85704	
23338796	G57000		25871036	G63959		37301-0016	85026		4975538	85700	
23338796	G57023		25871225	49235		37301-0021	85026		4975549	83216	
23338800	G57000		25871225	61675		37301-3202	85026		4975550	85702	
23338800	G57023		25871225	G63866		373010016	85026		4975552	85711	
23338819	G57000		25871229	49235		373010021	85026		4984526	83216	
23338819	G57023		25871229	61675		373013202	85026		4993599	6804SE	
23338824	G57000		25871229	G63866		3989717C1	83135		507-16	85702	
23338824	G57023		25874561	143366		4089293C1	83397		507-19	85700	
23338831	G57000		25875709	142526		4109458C2	83243		507-3	85307	
23338831	G57023		25948611	43181		4109582C1	83397		50716	85702	
23338839	G57000		25978183	G64040		4109583C1	83397		50719	85700	
23338839	G57023		25980102	G51870		4206863C1	83398		5073	85307	
23338844	G57000		25984611	61600		4207304C1	83397		508-86	83136	
23338844	G57023		25984613	58412		4208946C1	83398		50886	83136	
23338863	G57000		25984613	61642		4214011C2	85670		5171068	83216	
23338863	G57023		25984613	77412		42417188	G52494		5304059	85700	
23338867	G57000		3082284	83400		42417189	G52495		5316784	85700	
23338867	G57023		3166657	85700		4939852	85308	89422	5316791	83219	
23338871	G57000		3171068	83216		4939852	89422		5316792	85305	
23338871	G57023		3171069	85304		4939967	85308	89422	5316793	85305	
23338875	G57000		3171462	83126	89430	4939967	89422		5316794	85700	
23338875	G57023		3171462	89430		4940600	83209	89414	5321920	85307	
23390195	G52435		3171696	85307		4940600	89414		5321929	85307	
23390196	G52436		3172948	85303	89422	4940601	83216		5348631	83203	89436
23390197	G52278		3172948	89422		4940606	83126	89430	5348631	89436	
23390198	G52279		3178106	85700		4940606	89430		5352857	85700	
23390201	G52278		3178157	85700		4940614	83216		5352858	85305	
23425607	G57000		3178233	85734		4940627	83203	89436	5353054	85303	89422
23425607	G57023		3178507	85700		4940627	89436		5353054	89422	
23452955	77975		3178995	85700		4940640	83216		5355798	85307	

Important Note: Competitive Interchanges are to be used for stocking purposes only. Where multiple crosses are identified, please reference the applications section of this catalog. / **Remarque importante:** Les interchanges concurrentiels ne s'utilisent qu'aux fins de stocks. Dans le cas de références multiples, consulter la section des applications du catalogue. / **Nota importante:** En el caso de referencias múltiples, consultar la sección de aplicaciones del catálogo. / **Nota importante:** Se pueden usar intercambios competitivos para propósitos de almacenamiento solamente. Cuando se identifican intercambios múltiples, consulte la sección de aplicaciones de este catálogo.

COMPETITIVE & O.E.M. INTERCHANGE LIST
Lista de Intercambios contra Competidores y Equipo Original.
Liste d'interchange de produits complitifs & d'equpement original (OEM)

General Motors... cont'd

General motors	Gabriel	Upgrade	General motors	Gabriel	Upgrade	General motors	Gabriel	Upgrade	General motors	Gabriel	Upgrade
5357955	85300	89419	5552112	85307		84059852	G57023		88946022	81481	
5357955	89419		5552114	83216		84061228	G57000		88946023	81490	
5357956	85734		5552206	83214		84061228	G57023		88946024	81494	
5357959	85300	89419	5552209	83215		84082002	G57000		88946025	81492	
5357959	89419		5552210	85308	89422	84082002	G57023		88946027	81495	
5361994	85734		5552210	89422		84082031	G57000		88946028	81496	
5374779	85308	89422	5552244	85308	89422	84082031	G57023		88946029	81484	
5374779	89422		5552244	89422		84129872	G64140		88946031	81507	
5374999	85307		5552285	83214		84176631	G57000		88946032	81514	
5385939	85307		5552451	85308	89422	84176631	G57023		88946033	81516	
5392387	85303	89422	5552451	89422		84192068	G64140		88946039	81540	
5392387	89422		5552452	85303	89422	84303234	G63895		88946041	81548	
5394448	85305		5552452	89422		87-2520-00003	85704		88946042	81549	
5394467	85305		5552453	85301		87252000003	85704		88946044	81553	
5455798	85307		5552454	85302	89420	88945169	69600		88946050	81559	
5513489	83216		5552454	89420		88945170	49334		88946051	81560	
5513716	85304		5552456	85307		88945170	69604		88946055	81582	
5516459	85305		5552552	85303	89422	88945171	69606		88946059	81667	
5522794	85308	89422	5552552	89422		88945172	69622		88946060	81668	
5522794	89422		5554184	85302	89420	88945173	69624		88946065	81675	
5522818	85305		5554184	89420		88945174	69632		88946072	81713	
5527001	85300	89419	5554589	85307		88945177	69675		88946083	81750	
5527001	89419		5554596	85303	89422	88945178	69676		88946106	82003	
5527271	85700		5554596	89422		88945184	69715		88946113	82010	
5527272	85700		5554814	85302	89420	88945185	69714		88946129	82026	
5527606	85305		5554814	89420		88945188	69724		88946137	82034	
5531027	85301		5554959	83401		88945188	81514		88946138	82035	
5531435	85307		5554995	85305		88945194	69725		88946142	82039	
5531436	85307		5559363	83203	89436	88945205	69795		88946143	82040	
5531437	85307		5559363	89436		88945210	69811		88946145	82047	
5532026	85304		5585939	85307		88945324	34051		88946149	82051	
5532425	83207	89407	684280	83209	89414	88945324	81494		88946155	82060	
5532425	89407		684280	89414		88945325	69715		88946164	82070	
5532433	83207	89407	8-51630-666-0	85012	89413	88945344	61539		88946168	82075	
5532433	89407		8-51630-666-0	89413		88945344	G63454		88946169	82076	
5532675	85307		8-94057-593-0	83114		88945846	61500		88946171	82079	
5533699	85302	89420	8-94454-986-0	83515		88945847	61501		88946176	82086	
5533699	89420		8-94454-987-0	83515		88945854	61508		88946177	82087	
5534430	85303	89422	8-97083-029-0	83515		88945861	61516		88946182	82099	
5534430	89422		8-97201-960-0	83515		88945867	61522		88946188	82109	
5534439	85304		8-97253-620-0	83515		88945983	81039		88946189	82110	
5534447	85303	89422	8-97253664-0	83159		88945986	81095		88946195	82118	
5534447	89422		8-97253665-0	83159		88945987	81096		88946198	82125	
5544060	85302	89420	8-98380-746-0	83159		88945990	81113		88946205	82138	
5544060	89420		8-98380-747-0	83159		88945991	81164		88946210	82151	
5544112	83216		8-98381-010-0	83515		88945992	81147		88946214	82155	
5544581	85302	89420	8-98381-012-0	83515		88945995	81242		88946215	82156	
5544581	89420		84043175	G57000		88945997	81270		88946216	82601	
5544716	85304		84043175	G57023		88945999	81340		88946217	82602	
5544717	85304		84043190	G57000		88946002	81394		88946223	82609	
5544812	83308		84043190	G57023		88946009	81510		88946231	82618	
5549899	83207	89407	84043200	G57000		88946010	81082		88946311	142244	
5549899	89407		84043200	G57023		88946013	69675		88946316	142249	
5549924	85700		84043205	G57000		88946013	81446		88946326	143204	
5549925	85304		84043205	G57023		88946020	81478		88946348	142317	
5552111	85304		84059852	G57000		88946021	81482		88946413	142439	

Important Note: Competitive Interchanges are to be used for stocking purposes only. Where multiple crosses are identified, please reference the applications section of this catalog. / **Remarque importante:** Les interchanges concurrentiels ne s'utilisent qu'aux fins de stocks. Dans le cas de rferences multiples, consulter la section des applications du catalogue. / **Nota importante:** Dans le cas de rferences multiples, consulter la section des applications du catalogue. / **Nota importante:** Se pueden usar intercambios competitivos para propósitos de almacenamiento solamente. Cuando se identifican intercambios múltiples, consulte la sección de aplicaciones de este catálogo.

COMPETITIVE & O.E.M. INTERCHANGE LIST
Lista de Intercambios contra Competidores y Equipo Original.
Liste dinterchange de produits comptitifs & dquipement original (OEM)

General Motors... cont'd

General motors	Gabriel	Upgrade	General motors	Gabriel	Upgrade	General motors	Gabriel	Upgrade	General motors	Gabriel	Upgrade
88946420	142524		88955460	49255		88966791	61541		89060253	143363	
88946421	142526		88955461	49228		88966792	61542		8940575930	83114	
88946426	142530		88955461	49255		88966793	61543		8944549860	83515	
88946443	142547		88959113	58357		88966794	61544		8944549870	83515	
88946452	142836		88959123	58403		88966801	61555		8970830290	83515	
88946509	142751		88959128	58412		88966805	61560		8972019600	83515	
88946510	142752		88959132	58421		88966809	61600		8972536200	83515	
88946547	14017		88959133	58422		88966810	61565		8972536640	83159	
88946548	14018		88959134	58423		88966813	61575		8972536650	83159	
88946552	14040		88959140	58488		88966837	61615		898098-0580	83159	
88946553	34036		88959141	58489		88966838	61616		898098-0581	83159	
88946554	34051		88959143	58609		88966850	61641		898098-0590	83159	
88946556	34057		88959149	58638		88966851	61642		898098-1250	83515	
88946558	34073		88959151	58662		88966852	61643		898098-1270	83515	
88946561	43048		88959156	58714		88966862	61659		8980980580	83159	
88946562	43049		88959162	58901		88966866	61663		8980980581	83159	
88946564	43060		88959166	58803		88966868	61664		8980980590	83159	
88946564	49152		88959173	58817		88966869	61605		8980981250	83515	
88946574	43111		88960674	142567		88974638	G51736		8980981270	83515	
88946580	43162		88961944	69464		88982682	83136		8983807460	83159	
88946581	43163		88961947	81869		88982684	83136		8983807470	83159	
88946588	43180		88962978	75676		88982686	85071		8983810100	83515	
88946589	43181		88962985	77403		88983816	58803		8983810120	83515	
88946592	49107		88962987	77375		88983816	77803		9-51630-647-1	83515	
88946595	49122		88962995	77412		88983818	49235		9-51630-666-0	85012	89413
88946597	49128		88962995	77783		88983818	61675		9-51630-666-0	89413	
88946598	49131		88963000	77422		88983818	G63866		9-51630-666-2	85012	89413
88946599	49135		88963001	77423		88985556	142561		9-51630-666-2	89413	
88946603	49152		88963004	77454		88986629	61555		90251921	143459	
88946604	49155		88963009	77488		88986629	81713		91174724	G56518	
88946605	49157		88963010	77488		88986629	G63375		91174725	G56518	
88946607	49162		88963010	77489		89038500	61643		91174727	G56518	
88946618	49203		88963017	77609		89038500	G63803		92195484	G51916	
88946621	49212		88963020	77638		89038591	61642		92195485	G51916	
88946622	43162		88963023	77662		89038595	58803		92213101	143461	
88946622	49213		88963039	77783		89038595	61641		92213102	143462	
88946624	49215		88963040	77803		89038595	61643		92233769	143462	
88946627	49218		88963046	77817		89038595	77803		92244056	G52281	
88946635	49228		88963054	77907		89038595	G63783		92244057	G52280	
88946635	49255		88963055	77909		89038595	G63803		92244058	G52281	
88946637	49230		88963949	69622		89038596	61690		92244059	G52280	
88946638	49231		88963949	81880		89038596	G63959		94033786	83114	
88946642	49235		88964326	143323		89038597	58412		94051090	83114	
88946647	49304		88965467	G55948		89038597	77412		94057593	83114	
88946652	49311		88965469	G55949		89038652	58803		94454987	83515	
88946654	49334		88966763	61504		89038652	58817		94849261	143281	
88946669	6801SE		88966765	61506		89038652	61663		94849262	143281	
88946670	6802SE		88966771	61517		89038652	77803		94854736	143281	
88946671	6803SE		88966773	61519		89038652	77817		94857922	143281	
88946672	6804SE		88966777	61524		89038652	G63817		94857975	G55999	
88947653	69625		88966778	61525		89038654	43181		94857976	G55999	
88955457	49228		88966780	61528		89038654	61600		94859874	G55662	
88955457	49255		88966782	61531		89040176	G57000		94859875	G55661	
88955458	49228		88966786	61535		89040176	G57023		95015324	143239	
88955458	49255		88966787	61536		89040177	61643		9516306471	83515	
88955460	49228		88966789	61539		89040177	G63803		9516306660	85012	89413

Important Note: Competitive Interchanges are to be used for stocking purposes only. Where multiple crosses are identified, please reference the applications section of this catalog. / **Remarque importante:** Les interchanges concurrentiels ne s'utilisent qu'aux fins de stocks. Dans le cas de rrences multiples, consulter la section des applications du catalogue. / **Nota importante:** Dans le cas de rrences multiples, consultar la section des applications du catalogue. / **Nota importante:** Se pueden usar intercambios competitivos para propósitos de almacenamiento solamente. Cuando se identifican intercambios múltiples, consulte la sección de aplicaciones de este catálogo.

COMPETITIVE & O.E.M. INTERCHANGE LIST

Lista de Intercambios contra Competidores y Equipo Original.

Liste d'interchange de produits compétitifs & d'équipement original (OEM)

General Motors... cont'd

General motors	Gabriel	Upgrade	General motors	Gabriel	Upgrade	General motors	Gabriel	Upgrade	General motors	Gabriel	Upgrade
9516306660	89413		95440471	G52495		97201960	83515		98098059	83159	
9516306662	85012	89413	95440472	G52494		97221000156	85702		98098125	83515	
9516306662	89413		95440473	G511030		97221000164	85708		98098127	83515	
95266854	G52495		96980824	G57130		97221000170	85733		98232671	83515	
95266855	G52494		96980825	G57131		97253616	83515		98380746	83159	
95266856	G52495		96980826	G57130		97253620	83515		98380747	83159	
95266857	G52494		96980827	G57131		97253621	83515		98381010	83515	
95271437	G511030		97-2210-00156	85702		97253623	83515		98381012	83515	
95271438	G511030		97-2210-00164	85708		97253651	83159		SG23086	61522	
95387906	G511030		97-2210-00170	85733		97253664	83159		U0109-014	83400	
95440469	G52495		97083027	83515		97253665	83159		U0109014	83400	
95440470	G52494		97083029	83515		98098058	83159				

GROB

Grob	Gabriel	Upgrade	Grob	Gabriel	Upgrade	Grob	Gabriel	Upgrade	Grob	Gabriel	Upgrade
1609001	69586		2709075	G52127		4009018	G63867		5009008	70060	
1609003	69946		2709076	G52128		4009019	G63775		5009009	G52187	
1909003	69863		2709077	G64015		4009020	G51703		5009010	G52188	
1909004	G52145		2709085	70204		4009021	G63870		5009011	G51879	
1909005	G52144		3009001	G63892		4009025	G63969		5009012	G56799	
1909006	G64046		3009002	G64016		4009027	G64063		5009013	G56800	
1909007	G52199		3009005	G52081		4009029	69592		5009014	G51286	
1909008	G52200		3009006	G52082		4009030	G56817		5009017	70010	
1909009	70034		3009007	G51842		4009031	G64037		5009018	G51878	
2709001	69589		3009008	G52155		4009032	G56841		5009019	G51877	
2709001	69590		3009009	G52154		4009033	G56840		5009020	G51892	
2709008	G63882		3009010	70036		4009035	G64079		5009024	G52254	
2709009	G51850		3009011	G64012		4009044	G52256		5009025	G52253	
2709010	G63879		3009012	G56807		4009045	G52255		5009026	G56678	
2709011	G56773		3009013	G63961		4009058	G511002		5009027	G56677	
2709012	G56774		3009014	G63958		4009058	G511135		5009028	G51858	
2709013	G64015		3009018	G51815		4009067	G51980		5009029	G56800	
2709019	G63875		3009019	G51947		4009082	G56837		5009030	G56799	
2709026	G63884		3009020	G51948		4009083	G56836		5009039	G52112	
2709031	G56886		3009021	G51721		4009091	G64157		5009052	G511092	
2709032	G56887		3009024	77948		4009103	G51965		5309003	G52439	
2709034	G56810		3009025	G64042		4409002	G63862		5309004	G52440	
2709035	G56810		3009026	G52131		4409003	G64047		5609000	G63611	
2709036	69587		3009027	G52148		4709001	70003		5609001	G63710	
2709042	G52025		3009028	G52149		4709002	69591		5909000	70209	
2709043	G63879		3009029	G51848		4709003	G51810		5909001	70203	
2709044	G51870		3009030	G51863		4709004	G51811		5909003	G64216	
2709045	G63959		3009031	G63967		4709005	G52005		5909006	70208	
2709047	G63965		3009032	G64008		4709006	G52006		6109001	G64089	
2709049	81496		3009033	G63966		4709011	G52260		6109005	G64089	
2709051	70039		3009033	G63967		4709012	G52261		6109007	G63918	
2709055	G51971		3009037	G511000		4709014	G52256		6109008	G56778	
2709058	G52125		3009039	81926		4709015	G52255		6409001	G51794	
2709059	G64040		3009040	G63847		4709016	70052		6409002	G56894	
2709060	G64040		3009041	G64012		4709017	G52209		6409009	G51254	
2709063	69590		3009042	G56807		4709018	G52210		6409013	G51908	
2709067	G52494		3009062	G511038		4709019	G64056		6409014	G52300	
2709068	G52495		4009000	G51836		4709033	70207		6409015	G52299	
2709069	G511030		4009001	G56839		5009001	G51738		6409019	G51883	
2709071	G64121		4009004	G51849		5009002	G51737				
2709072	77803		4009005	G51849		5009005	G51807				
2709073	G52127		4009015	G51861		5009006	G52283				
2709074	G52128		4009016	G51888		5009007	G52282				

Important Note: Competitive Interchanges are to be used for stocking purposes only. Where multiple crosses are identified, please reference the applications section of this catalog. / **Remarque importante:** Les interchanges concurrentiels ne s'utilisent qu'aux fins de stocks. Dans le cas de références multiples, consulter la section des applications du catalogue. / **Nota importante:** Dans le cas de referencias multiples, consultar la sección de aplicaciones del catálogo. / **Nota importante:** Se pueden usar intercambios competitivos para propósitos de almacenamiento solamente. Cuando se identifican intercambios múltiples, consulte la sección de aplicaciones de este catálogo.

COMPETITIVE & O.E.M. INTERCHANGE LIST
Lista de Intercambios contra Competidores y Equipo Original.
Liste dinterchange de produits comptitifs & dquipement original (OEM)

GROB... cont'd

Grob	Gabriel	Upgrade	Grob	Gabriel	Upgrade	Grob	Gabriel	Upgrade	Grob	Gabriel	Upgrade
6409022	G52300		8709010	G55662		G2154	69465		G5184	G63714	
6409023	G52299		8709011	G55999		G2182	69604		G5185	G63714	
6409025	G52293		8709012	G55999		G2201	69676		G5187	61613	
6409026	G52294		8709013	G51736		G2209	G55901		G5188	G63772	
6409027	G51933		8709014	G56660		G2210	G63903		G5189	G63773	
6709000	G51715		8709015	G56661		G2221	69632		G5190	G63622	
6709001	G63883		8709020	G63832		G2276	81446		G5193	G63425	
6709003	G56671		8709021	G63828		G2277	69606		G5194	G63676	
6709004	G56672		8709022	G51805		G2286	69898		G5195	G63905	
6709006	G63845		8709023	G52106		G2295	G55825		G5195	G63915	
6709007	G56687		8709024	G52106		G2370	G51087		G5196	G63403	
6709008	G56688		8709025	G63689		G2395	69464		G5196	G63890	
6709009	G51802		8709026	61606		G2419	G63492		G5197	G63965	
6709011	G56785		8709027	G51783		G2430	69945		G5200	61675	
6709012	G56784		8709028	G56843		G2438	G63776		G5206	61641	
6709013	G51803		8709029	G56842		G2454	G51279		G5213	61655	
6709014	G52033		8709030	G52007		G2496	G51704		G5222	G63915	
6709015	G52032		8709031	G52004		G2498	69473		G5227	61509	
6709016	70041		8709032	G64026		G3001	G63423		G5227	81870	
6709019	G52094		8709032	G64151		G3295	G51783		G5232	81744	
6709020	G52095		8709036	G52204		G4439	G51798		G5234	G63492	
6709021	70027		8709037	G52203		G5013	61629		G5235	G63299	
6709025	G52173		8709038	G52202		G5021	G63848		G5236	G63813	
6709026	G52174		8709039	G52201		G5034	G63366		G5237	G63714	
6709027	G64050		8709040	G52204		G5053	G63414		G5237	G63716	
6709033	G64033		8709041	G52203		G5054	G63888		G5238	61638	
6709034	G51765		8709042	G51937		G5059	G63494		G5239	G63414	
6709035	69594		8709044	G51739		G5091	G63489		G5837	G63837	
6709036	69595		8709045	G64006		G5092	G63488		G5838	G63809	
6709037	81147		8709046	G52106		G5092	G63896		GP009	G55579	
6709038	G63902		8709047	G52105		G5093	61675		GP010	G56581	
6709039	G63907		8709048	G511007		G5096	61531		GP011	G56582	
6709040	G51766		8709049	G52107		G5097	61528		GP019	G51718	
6709044	G52122		8709050	G52108		G5099	61523		GP026	G56758	
6709045	G52121		8709051	G52245		G5100	61600		GP027	G56759	
6709046	G51874		8709052	G52246		G5101	G63674		GP046	G51739	
6709049	G511123		8709053	G51898		G5104	G63424		GP047	G63885	
6709054	G51990		8709162	G64186		G5105	G63683		GP122	G55698	
6709057	G52382		9009005	70056		G5106	G63690		GP168	G55909	
6709058	G52383		9309003	G51799		G5107	G63622		GP169	G55910	
6709059	G51802		9309004	G56899		G5115	61646		GP172	G55856	
6709060	G52171		9309011	G51993		G5123	G63818		GP196	G55870	
6709061	G52170		9309012	G52301		G5124	61531		GP209	G51267	
6709062	G51884		9309016	G56899		G5127	61508		GP210	G51268	
6709065	G511044		9609001	G52295		G5128	G56518		GP215	G55856	
8409001	G52184		9609003	G52274		G5129	G56518		GP225	G55697	
8409002	G52185		9609004	G52275		G5130	G63799		GP226	14039	
8409003	G64052		9609005	70040		G5131	G63842		GP230	G51255	
8409004	G56887		9609006	G56802		G5133	G63609		GP231	G51256	
8409005	G56886		G0010	G51728		G5168	G63803		GP237	G56581	
8409007	G56886		G0011	G63844		G5169	G63817		GP237	G56582	
8709005	G56888		G0067	G63860		G5170	G63454		GP241	G56606	
8709006	G56889		G1348	G51838		G5172	G63862		GP259	G55892	
8709007	G52103		G2003	82126		G5174	G63489		GP259	G55896	
8709008	G52104		G2025	69600		G5182	G63678		GP264	G56517	
8709009	G55661		G2036	82125		G5183	G63679		GP265	G56516	

Important Note: Competitive Interchanges are to be used for stocking purposes only. Where multiple crosses are identified, please reference the applications section of this catalog. / **Remarque importante:** Les interchanges concurrentiels ne s'utilisent qu'aux fins de stocks. Dans le cas de rfrences multiples, consulter la section des applications du catalogue. / **Nota importante:** En el caso de referencias multiples, consultar la seccion de aplicaciones del catalogo. / **Nota importante:** Se pueden usar intercambios competitivos para propósitos de almacenamiento solamente. Cuando se identifican intercambios múltiples, consulte la sección de aplicaciones de este catálogo.

COMPETITIVE & O.E.M. INTERCHANGE LIST
Lista de Intercambios contra Competidores y Equipo Original.
Liste d'interchange de produits comppititifs & d'equipement original (OEM)

GROB... cont'd

Grob	Gabriel	Upgrade	Grob	Gabriel	Upgrade	Grob	Gabriel	Upgrade	Grob	Gabriel	Upgrade
GP274	G55948		GP380	G52009		GP403	G56721		GP460	G56684	
GP299	G56568		GP381	G52008		GP404	G56729		GP461	G51727	
GP300	G56601		GP390	G56622		GP405	G56728		GP462	G56686	
GP305	G55901		GP391	G56621		GP418	G51700		GP463	G56685	
GP308	G56620		GP402	G56722		GP459	G56683		GP465	G51727	

Grupo A

Grupo a	Gabriel	Upgrade	Grupo a	Gabriel	Upgrade	Grupo a	Gabriel	Upgrade	Grupo a	Gabriel	Upgrade
15055	14004		43124	81147		53023	81482		53272	G63662	
15067	14004		43125	61520		53024	85005	89430	53273	G63674	
15500	6802SE		43125	81490		53025	61521		53274	G63675	
15501	6804SE		43132	61554		53025	81394		53275	G63661	
15502	6804SE		43132	81710		53026	85005	89430	53276	81873	
15504	14071		43133	61554		53028	G63489		53337	61544	
15504	6801SE		43133	81710		53029	61544		53337	81668	
164023	43140		43134	G63909		53029	81668		53338	82003	
164028	43049		43139	83021		53032	81495		53341	61521	
215550	G55526		43145	83021		53035	G63488		53341	81394	
30216	G51279		43154	69632		53036	81091		53400	61523	
39155	49155		43156	G63907		53037	61565		53400	81096	
39205	49205		43158	G63183		53039	85006		53401	81091	
39218	49231		43171	82090		53040	85006		53402	G63360	
39569	49369		43172	81469		53041	85310	89423	58003	61524	
43003	61524		43236	61524		53041	89423		58003	81164	
43003	81164		43236	81164		53042	83309		58004	G63366	
43004	G63366		43381	61521		53043	83215		58012	85314	89425
43014	81340		43381	81394		53044	83124	89407	58012	89425	
43019	81492		43387	81076		53051	61520		58034	85013	89414
43025	61519		43440	82130		53051	81490		58034	89414	
43025	81484		43455	61501		53052	61530		58035	58488	
43026	61550		43455	81478		53052	81510		58035	61543	
43026	81676		43511	81091		53053	G63386		58035	81667	
43031	69724		43512	81091		53057	G63359		58038	85001	89410
43040	61626		43725	82005		53058	G63353		58038	89410	
43045	61501		43728	82001		53059	85051		58040	85026	
43045	81478		43731	61614		53060	81935		58041	83456	89447
43046	61500		43731	81821		53061	G63413		58041	89447	
43046	81147		43734	82005		53063	83025		58048	83137	
43053	81446		43736	82001		53065	83136		58049	85000	89436
43054	81495		53002	81446		53066	83124	89407	58049	85323	89436
43055	81494		53004	G63366		53066	89407		58049	89436	
43057	G55825		53008	G63929		53068	G51850		58050	85061	89450
43059	61500		53009	G63624		53069	81710		58050	85061	89502
43059	81147		53010	83136		53070	61520		58050	89450	
43060	69464		53013	85071		53070	81490		58054	61530	
43066	83309		53016	G63773		53070	81913		58054	81510	
43069	81710		53017	G63772		53071	61519		58055	85003	89411
43070	61520		53018	83317		53071	81484		58055	89411	
43070	81490		53019	83456	89447	53072	81925		58056	83137	
43092	81459		53019	89447		53073	81930		58057	83456	89447
43098	69945		53020	61521		53081	83159		58057	89447	
43119	61600		53020	81394		53082	83515		58058	85031	
43120	61641		53020	81744		53083	83159		58059	85005	89430
43121	81920		53021	G63623		53084	83515		58059	89430	
43122	61600		53022	61504		53091	83159		58061	83122	89406
43122	81873		53022	81750		53195	G63183		58061	85916	89430
43124	61500		53023	61528		53271	G63673		58061	89406	

Important Note: Competitive Interchanges are to be used for stocking purposes only. Where multiple crosses are identified, please reference the applications section of this catalog. / **Remarque importante:** Les interchanges concurrentiels ne s'utilisent qu'aux fins de stocks. Dans le cas de références multiples, consulter la section des applications du catalogue. / **Nota importante:** Dans le cas de références multiples, consulter la section des applications du catalogue. / **Nota importante:** Se pueden usar intercambios competitivos para propósitos de almacenamiento solamente. Cuando se identifican intercambios múltiples, consulte la sección de aplicaciones de este catálogo.

COMPETITIVE & O.E.M. INTERCHANGE LIST
Lista de Intercambios contra Competidores y Equipo Original.
Liste d'interchange de produits compititifs & d'equipement original (OEM)

Grupo A... cont'd

Grupo a	Gabriel	Upgrade	Grupo a	Gabriel	Upgrade	Grupo a	Gabriel	Upgrade	Grupo a	Gabriel	Upgrade
58064	85070	89459	69090	G64031		69309	61561		69516	G63423	
58069	61547		69091	G51799		69309	81490		69517	61528	
58069	81082		69092	69813		69309	81744		69519	61599	
58070	61520		69093	69450		69310	61533		69520	61544	
58070	81490		69098	69946		69310	81490		69521	61543	
58178	61500		69100	61593		69310	81744		69522	G63638	
58178	81147		69100	81872		69312	81492		69523	61544	
58337	58489		69101	G55821		69321	61500		69532	G63884	
58337	61544		69104	G63889		69321	81147		69534	G51815	
58337	81668		69107	70003		69322	81446		69535	G63891	
58341	61521		69108	G64003		69323	69606		69536	G51815	
58341	81394		69109	70036		69323	81495		69537	G63844	
58400	G63359		69110	G51805		69326	61500		69538	61683	
58401	G63353		69114	70027		69326	81147		69539	61684	
69010	69898		69115	70041		69330	81710		69541	G63867	
69011	61600		69116	G51783		69334	82156		69544	G63622	
69012	61641		69117	G63902		69338	69632		69545	61595	
69013	61641		69119	G51738		69346	81091		69546	61591	
69013	81920		69123	69591		69347	G63355		69547	61533	
69014	61600		69124	69589		69355	61523		69548	61520	
69014	81873		69125	69590		69355	81096		69548	61561	
69015	69464		69126	69587		69355	81834		69548	81490	
69017	G63409		69127	G51879		69357	81091		69548	81744	
69018	G63414		69129	G511004		69361	61614		69549	58929	
69023	69473		69131	G51874		69369	81147		69549	61591	
69024	61500		69132	G51983		69370	81478		69550	61518	
69024	81478		69133	G51990		69376	81478		69550	61595	
69025	61501		69134	G51721		69379	69632		69550	81242	
69025	81147		69135	69592		69379	81459		69554	61554	
69031	61528		69136	70095		69381	61500		69555	G63714	
69034	69909		69137	G51898		69381	81147		69556	G63778	
69036	69900		69146	G51971		69382	81342		69557	G63662	
69038	G51700		69147	G51848		69383	61632		69563	61634	
69039	G51286		69150	G64056		69383	81825		69582	G63848	
69040	61506		69151	G63872		69389	69845		69583	61692	
69040	81318		69152	70052		69391	81916		69584	G64012	
69041	61662		69153	G511030		69392	81917		69585	61720	
69042	61662		69155	G51863		69395	61520		69587	61710	
69043	61506		69159	G63907		69395	81490		69588	G63971	
69043	81318		69160	G64050		69396	61547		69590	61615	
69044	69465		69164	G511007		69396	81082		69591	61616	
69045	G51736		69170	G64050		69500	83122	89406	69592	61714	
69046	G63845		69171	G51807		69500	89406		69593	61654	
69048	G63909		69172	G511044		69501	61543		69594	61713	
69048	G64001		69175	69464		69502	G63424		69601	61554	
69049	G63965		69177	G51905		69503	61544		69605	G64015	
69077	G63813		69179	G51892		69504	G63425		69610	G63915	
69078	G63492		69180	G511002		69505	61506		69611	G63403	
69080	61506		69226	69945		69506	61523		69612	61535	
69080	81318		69234	G51279		69507	G63353		69613	G63683	
69081	G63712		69247	70098		69509	61554		69615	G63678	
69084	G51815		69248	70003		69510	61520		69616	G63607	
69085	G63890		69253	G511078		69511	G63299		69622	61642	
69086	G63890		69300	G63349		69513	61626		69623	61635	
69088	69595		69309	58929		69515	83124	89407	69651	G63488	
69089	69594		69309	61520		69515	89407		69653	58488	

Important Note: Competitive Interchanges are to be used for stocking purposes only. Where multiple crosses are identified, please reference the applications section of this catalog./ **Remarque importante:** Les interchanges concurrentiels ne s'utilisent qu'aux fins de stocks. Dans le cas de rfrences multiples, consulter la section des applications du catalogue./ **Nota importante:** Dans le cas de rfrences multiples, consulter la section des applications du catalogue./ **Nota importante:** Se pueden usar intercambios competitivos para propósitos de almacenamiento solamente. Cuando se identifican intercambios múltiples, consulte la sección de aplicaciones de este catálogo.

COMPETITIVE & O.E.M. INTERCHANGE LIST
Lista de Intercambios contra Competidores y Equipo Original.
Liste dinterchange de produits comptitifs & dquipement original (OEM)

Grupo A... cont'd

Grupo a	Gabriel	Upgrade	Grupo a	Gabriel	Upgrade	Grupo a	Gabriel	Upgrade	Grupo a	Gabriel	Upgrade
69654	61659		69746	83137		78023	89447		79190	G56758	
69656	61512		69747	85003	89411	78025	85009		79191	G56759	
69657	61658		69747	89411		78027	85314	89425	79195	G56886	
69658	61504		69748	85001	89410	78027	89425		79196	G56887	
69660	G51728		69748	89410		78030	85316	89426	79199	G51811	
69661	G63844		69750	85314	89425	78030	89426		79200	G51810	
69663	61555		69750	89425		78034	85920	89503	79201	G52185	
69664	61565		69752	85316	89426	78039	85311	89424	79202	G52184	
69666	61655		69752	89426		78039	89424		79203	G51859	
69668	G63918		69753	85031		79053	G56606		79204	G51859	
69669	83123	89405	69760	85924	89457	79059	G51254		79207	G56810	
69669	85010		69762	85931	89458	79059	G51268		79208	G56810	
69669	89405		69816	G55526		79060	G51267		79210	G56773	
69670	85051		69963	G55681		79061	G56517		79211	G56774	
69671	85006		70702	G55526		79062	G56516		79217	G52300	
69672	85043		72001	G63870		79064	G55948		79218	G52299	
69673	83209	89414	72004	G64026		79065	G55949		79219	G52082	
69673	89414		72005	G51798		79070	G55892		79220	G52081	
69678	G63674		72006	G64003		79077	G55896		79221	G51842	
69679	G63675		72007	G64063		79078	G55949		79222	G52122	
69680	89402		72008	G64052		79080	G55870		79225	G56889	
69685	83136		72009	G64089		79092	G56568		79226	G56888	
69688	85302	89420	72020	G64043		79093	G56601		79227	G52104	
69688	89420		72021	G64044		79096	G56799		79228	G52103	
69692	61663		72022	G63959		79097	G56800		79229	G51723	
69693	61675		72026	G63902		79098	G56660		79230	G51724	
69696	G63862		72027	G51766		79099	G56661		79231	G56838	
69697	G63676		72028	G64063		79103	G56778		79232	G56839	
69699	G63907		72029	G64031		79117	G56620		79233	G56807	
69705	83122	89406	72030	G63959		79128	G56672		79234	G56817	
69705	89406		72033	G63614		79129	G56671		79245	G52006	
69711	83207	89407	72034	G63406		79132	G56778		79246	G52005	
69711	89407		72037	G64157		79141	G51739		79249	G51761	
69712	85013	89414	72038	G64040		79143	G56899		79250	G51760	
69712	89414		72039	G63886		79148	G51097		79253	G52354	
69713	85046	89434	72040	G64104		79153	G52005		79254	G52353	
69713	89434		72049	G64037		79154	G52006		79259L	G52245	
69716	85024		78001	85314	89425	79162	G52155		79259R	G52246	
69717	85310	89423	78001	89425		79163	G52154		79264	G51908	
69717	89423		78002	85702		79164	G56797		79271	G51870	
69720	85736		78003	85308	89422	79165	G56798		79276L	G52148	
69726	85319	89428	78003	89422		79166	G56582		79276R	G52149	
69726	89428		78005	85310	89423	79167	G56581		79277L	G52210	
69728	85055	89439	78005	89423		79168	G51703		79277R	G52209	
69728	89439		78007	85307		79173	G52008		79278L	G52127	
69729	85314	89425	78008	85314	89425	79174	G52009		79278R	G52128	
69729	89425		78009	85303	89422	79175	G52095		79284L	G52494	
69732	85300	89419	78009	89422		79176	G52094		79284R	G52495	
69732	89419		78013	85323	89436	79179	G51704		79286L	G52117	
69741	85906	89407	78013	89436		79180	G51737		79286R	G52118	
69741	89407		78015	85724	89443	79184	G52188		79291L	G52173	
69743	85061	89450	78015	89443		79185	G52187		79291R	G52174	
69743	85061	89502	78016	85001	89410	79186	G52007		79292	G52131	
69743	89450		78016	89410		79187	G52004		79294L	G52152	
69745	85058	89431	78020	85712		79188	G56843		79294R	G52153	
69745	89431		78023	85705	89447	79189	G56842		79299L	G52255	

Important Note: Competitive Interchanges are to be used for stocking purposes only. Where multiple crosses are identified, please reference the applications section of this catalog. / **Remarque importante:** Les interchanges concurrentiels ne s'utilisent qu'aux fins de stocks. Dans le cas de références multiples, consulter la section des applications du catalogue. / **Nota importante:** Dans le cas de referencias multiples, consultar la sección de aplicaciones del catálogo. / **Nota importante:** Se pueden usar intercambios competitivos para propósitos de almacenamiento solamente. Cuando se identifican intercambios múltiples, consulte la sección de aplicaciones de este catálogo.

COMPETITIVE & O.E.M. INTERCHANGE LIST
Lista de Intercambios contra Competidores y Equipo Original.
Liste dinterchange de produits comptitifs & dquipement original (OEM)

Grupo A... cont'd

Grupo a	Gabriel	Upgrade	Grupo a	Gabriel	Upgrade	Grupo a	Gabriel	Upgrade	Grupo a	Gabriel	Upgrade
79299R	G52256		TX79196	G56887		USA69588	G63971		USA78051	85918	89449
79305	G51279		USA53094	83137		USA69589	G63958		USA78054	85736	
79309	G51972		USA53101	83038		USA69592	61714		USA78064	85301	
79310L	G52148		USA53102	83906		USA69594	61713		USA78066	85727	
79310R	G52149		USA58017	83164		USA69601	61554		USA79053	G56606	
79311L	G52187		USA58072	85936	89456	USA69606	61605		USA79092	G56568	
79311R	G52188		USA58073	85084	89460	USA69606	81878		USA79093	G56601	
79315L	G51877		USA58077	85337		USA69612	61535		USA79103	G56778	
79315R	G51878		USA58080	85932	89453	USA69612	61664		USA79117	G56620	
79317	G51865		USA58081	85920	89503	USA69613	61575		USA79132	G56778	
79319	G64148		USA58082	85932	89453	USA69613	61676		USA79166	G56581	
79320	G52125		USA69011	G63662		USA69615	61623		USA79167	G56582	
79322	G51719		USA69011	G63866		USA69616	61624		USA79168	G51703	
79324L	G52260		USA69012	G63783		USA69658	61504		USA79179	G51704	
79324R	G52261		USA69012	G63803		USA69660	G63844		USA79184	G52188	
79325	G51740		USA69013	61641		USA69661	G51728		USA79186	G52007	
79326L	G52173		USA69013	81920		USA69664	61565		USA79187	G52004	
79326R	G52174		USA69014	61600		USA69666	61655		USA79195	G56886	
79327L	G52173		USA69014	81873		USA69668	G63918		USA79196	G56887	
79327R	G52174		USA69031	61528		USA69689	83127		USA79217	G52300	
79329L	G52410		USA69034	69909		USA69692	61663		USA79218	G52299	
79329R	G52411		USA69080	61506		USA69693	61675		USA79219	G52082	
79333L	G52127		USA69080	81318		USA69696	G63862		USA79220	G52081	
79333R	G52128		USA69092	69813		USA69696	G64047		USA79221	G51842	
79334L	G52127		USA69115	70041		USA69697	G63676		USA79222	G52122	
79334R	G52128		USA69117	61501		USA69699	61500		USA79223	G52121	
79335L	G52360		USA69117	81478		USA69718	85321		USA79225	G56889	
79335R	G52361		USA69131	G51874		USA69749	85013	89414	USA79226	G56888	
79337L	G52203		USA69133	G51990		USA69756	85957		USA79227	G52104	
79337R	G52204		USA69135	69592		USA69758	85061	89450	USA79228	G52103	
79339	G51896		USA69137	G51898		USA69758	85061	89502	USA79229	G51723	
79339	G51897		USA69150	G64056		USA69759	83148		USA79230	G51724	
79341L	G52148		USA69391	G63772		USA72001	G63870		USA79231	G56838	
79341R	G52149		USA69392	G63773		USA72002	61535		USA79232	G56839	
79343	G511000		USA69517	61528		USA72003	61575		USA79233	G56807	
79347L	G52351		USA69522	61544		USA72004	G64026		USA79234	G56817	
79347R	G52352		USA69532	G63884		USA72004	G64151		USA79259L	G52245	
81740	61560		USA69538	61683		USA72006	G64003		USA79259R	G52246	
81740	81904		USA69539	61684		USA72014	83128	89436	USA79262	G56894	
85037	G55698		USA69544	G63622		USA72015	85052		USA79263	G56894	
85039	G56517		USA69555	61611		USA72016	83128	89436	USA79264	G51908	
85044	G55991		USA69556	G63717		USA72020	G51856		USA79271	G51949	
G44986	G44986		USA69582	G63848		USA72021	G64044		USA79277L	G52209	
G63626	G63683		USA69583	61692		USA72023	83908		USA79277R	G52210	
G63626	G63829		USA69584	G64012		USA72035	G64042		USA79284L	G52494	
G69795	69795		USA69585	61720		USA78000	85302	89420	USA79284R	G52495	
TX69115	70041		USA69586	G63892		USA78031	85311	89424	USA79343	G511000	
TX79195	G56886		USA69587	61710		USA78040	85314	89425			

GSP

Gsp	Gabriel	Upgrade	Gsp	Gabriel	Upgrade	Gsp	Gabriel	Upgrade	Gsp	Gabriel	Upgrade
810000	G57709		810013	G57566		810026	G57131		810227	G57377	
810001	G57142		810014	G57567		810120	G56951		810228	G57378	
810004	G57051		810015	G57329		810214	G57141		810229	G56924	
810005	G57549		810016	G57330		810215	G56924				
810006	G57550		810021	G57197		810216	G56925				
810009	G57282		810022	G57198		810218	G56929				
810010	G57060		810025	G57130		810222	G57142				

Important Note: Competitive Interchanges are to be used for stocking purposes only. Where multiple crosses are identified, please reference the applications section of this catalog./ **Remarque importante:** Les interchanges concurrentiels ne s'utilisent qu'aux fins de stocks. Dans le cas de rrences multiples, consulter la section des applications du catalogue./ **Nota importante:** En el caso de rrences multiples, consulte la seccion de aplicaciones del catalogo./ **Nota importante:** Se pueden usar intercambios competitivos para propósitos de almacenamiento solamente. Cuando se identifican intercambios múltiples, consulte la seccion de aplicaciones de este catalogo.

COMPETITIVE & O.E.M. INTERCHANGE LIST
Lista de Intercambios contra Competidores y Equipo Original.
Liste d'interchange de produits complitifs & d'equipement original (OEM)

GSP... cont'd

Gsp	Gabriel	Upgrade	Gsp	Gabriel	Upgrade	Gsp	Gabriel	Upgrade	Gsp	Gabriel	Upgrade
810230	G56925		811330	G57095		836221	G57119		837342	G57344	
810310	G57013		811331	G57096		836222	G57120		839219	G57086	
810311	G57014		811332	G57081		836310	G56943		847221	G57594	
810314	G56950		811333	G57082		836311	G56991		847222	G57595	
810315	G56949		811334	G57427		836312	G56992		853000	G57558	
810316	G56938		811335	G57148		836313	G57056		853001	G57559	
810320	G57060		811336	G57081		836314	G56995		853004	G57647	
810322	G57051		811337	G57082		836315	G56994		853005	G57144	
810323	G56928		811340	G57081		836316	G56993		853006	G57145	
810324	G56927		811341	G57082		836317	G56996		853007	G57034	
810327	G57100		811342	G57148		836318	G56997		853008	G57035	
810328	G57099		811346	G57148		836319	G56998		853009	G57493	
810331	G57110		811347	G57148		836320	G57050		853010	G57494	
810332	G57111		812001	G57071		836321	G57049		853013	G57092	
810333	G57069		812002	G57072		836324	G57033		853021	G57036	
810333	G57121		812005	G57206		836324	G57062		853114	G57057	
810334	G57070		812006	G57206		836325	G57032		853114	G57058	
810334	G57122		812009	G57206		836325	G57061		853115	G57037	
810335	G57022		812010	G57206		836328	G57084		853116	G57038	
810338	G57047		812219	G57112		836329	G57085		853211	G57161	
810339	G57048		812220	G57113		836331	G57119		853212	G57162	
810340	G57000		812222	G57026		836332	G57120		853213	G57161	
810341	G57125		812224	G57075		836333	G57419		853214	G57162	
810353	G57109		812225	G57176		836334	G57207		853215	G57161	
810354	G57197		812226	G57177		836335	G57208		853216	G57162	
810355	G57198		812228	G57206		836336	G57424		853221	G57157	
811004	G57582		812312	G56964		836337	G57425		853222	G57158	
811005	G57583		812313	G56963		836338	G57200		853224	G57159	
811009	G57726		812314	G56962		836339	G57201		853224	G57160	
811010	G57727		812316	G57422		836352	G57390		853227	G57030	
811011	G57726		812319	G56956		836353	G57391		853228	G57031	
811012	G57727		812320	G56957		836354	G57222		853312	G57031	
811014	G57450		812323	G57053		836355	G57223		853313	G57030	
811017	G57497		812324	G57146		836356	G57390		853314	G57035	
811018	G57498		812326	G56965		836357	G57391		853315	G57034	
811116	G56936		812327	G56973		836358	G57333		853316	G57036	
811117	G56934		812328	G56974		836359	G57334		853318	G57118	
811117	G56937		812329	G56975		836361	G57137		853319	G57092	
811212	G57271		812330	G57072		836362	G57138		853321	G57202	
811310	G56935		812331	G57071		837001	G57393		853322	G57203	
811313	G57064		812332	G57147		837002	G57394		853323	G57163	
811314	G57063		812333	G57178		837003	G57139		853324	G57164	
811315	G57046		821005	G57560		837004	G57140		853325	G57184	
811316	G57045		821006	G57561		837211	G57268		853326	G57185	
811317	G57017		821007	G57574		837212	G57269		853330	G57037	
811318	G57080		821008	G57575		837213	G57168		853331	G57038	
811319	G57016		821009	G56991		837214	G57167		853334	G57776	
811320	G57015		821010	G56992		837216	G57059		853335	G57777	
811321	G57018		827213	G57363		837219	G57090		866006	G57459	
811323	G57019		827214	G57364		837220	G57091		866007	G57460	
811324	G57020		836116	G57012		837330	G57088		866008	G57459	
811325	G57021		836117	G57011		837331	G57089		866009	G57460	
811326	G57172		836211	G57054		837333	G57149		866016	G57459	
811327	G57173		836212	G57055		837334	G57139		866017	G57460	
811328	G57132		836219	G57086		837335	G57140		866020	G57673	
811329	G57103		836220	G57087		837341	G57343		866021	G57674	

Important Note: Competitive Interchanges are to be used for stocking purposes only. Where multiple crosses are identified, please reference the applications section of this catalog. / **Remarque importante:** Les interchanges concurrentiels ne s'utilisent qu'aux fins de stocks. Dans le cas de références multiples, consulter la section des applications du catalogue. / **Nota importante:** Dans le cas de références multiples, consulter la section des applications du catalogue. / **Nota importante:** Se pueden usar intercambios competitivos para propósitos de almacenamiento solamente. Cuando se identifican intercambios múltiples, consulte la sección de aplicaciones de este catálogo.

COMPETITIVE & O.E.M. INTERCHANGE LIST
Lista de Intercambios contra Competidores y Equipo Original.
Liste dinterchange de produits compititifs & dquipement original (OEM)

GSP... cont'd

Gsp	Gabriel	Upgrade	Gsp	Gabriel	Upgrade	Gsp	Gabriel	Upgrade	Gsp	Gabriel	Upgrade
866022	G57675		869214	G57405		869338	G57079		882317	G57414	
866210	G57341		869219	G57375		869339	G57076		882318	G57415	
866211	G57342		869220	G57376		869340	G57077		882319	G57134	
866223	G57339		869221	G57097		869344	G57124		882320	G57027	
866224	G57340		869222	G57098		869345	G57123		882332	G57361	
869003	G57192		869223	G57097		869346	G57397		882333	G57362	
869007	G57650		869224	G57373		869347	G57353		882336	G57416	
869008	G57651		869229	G57663		869348	G57354		882337	G57682	
869009	G57568		869230	G57664		869350	G57121		882338	G57332	
869010	G57569		869237	G57191		869351	G57122		882339	G57331	
869013	G57738		869238	G57192		869368	G57330		882340	G57447	
869014	G57739		869310	G57027		872110	G57005		882341	G57465	
869017	G57204		869311	G56948		872112	G57006		882342	G57466	
869018	G57205		869312	G56948		872212	G57156		882345	G57197	
869021	G57105		869314	G57010		872310	G57039		882346	G57198	
869022	G57106		869315	G57065		875211	G57219		882347	G57564	
869023	G57375		869316	G57066		875212	G57218		882348	G57565	
869024	G57376		869321	G56931		882000	G57464		882349	G57515	
869025	G57078		869322	G56930		882001	G57463		882350	G57516	
869026	G57079		869324	G57098		882002	G57607		882351	G57393	
869031	G57499		869325	G57105		882003	G57463		882352	G57394	
869032	G57500		869326	G57106		882004	G57464		882353	G57204	
869033	G57329		869327	G57041		882005	G57607		882354	G57205	
869034	G57330		869328	G57042		882006	G57007		882367	G57658	
869037	G57665		869329	G57043		882007	G57008		882368	G57659	
869038	G57666		869330	G57044		882008	G57463		882371	G57465	
869041	G57568		869331	G57115		882009	G57464		882372	G57466	
869042	G57569		869332	G57114		882010	G57083		882377	G57275	
869049	G57648		869333	G57067		882011	G57083		882378	G57276	
869050	G57649		869334	G57068		882311	G57007		882383	G57471	
869112	G56933		869335	G57133		882312	G57008		882384	G57472	
869113	G56932		869336	G57134		882315	G57083				
869213	G57404		869337	G57078		882316	G57083				

Honda

Honda	Gabriel	Upgrade	Honda	Gabriel	Upgrade	Honda	Gabriel	Upgrade	Honda	Gabriel	Upgrade
51601-S3V-315	G57119		51605-S5A-C21	G57050		51606-S9V-A02	G56759		51920-SNW-Z01	143353	
51601-S3V-315	G57120		51605-S9V-A02	G56758		51606-S9V-A06	G56759		51920-TR0-A01	143353	
51601-S5A-C53	G57050		51605-S9V-A06	G56758		51606-SCV-A05	G52112		51920-TR0-A11	143353	
51601-S5A-C63	G57050		51605-SCV-A04	G52113		51606-SLN-A13	G52283		51920-TR7-A11	143353	
51601-S9V-305	G57120		51605-SCV-A05	G52113		51606-STK-A03	G52187		51925-S6M-014	143353	
51601-S9V-A04	G57120		51605-SEC-A02	G51737		51606-STX-A05	G52249		52610-S3V-305	G64003	
51601-SST-A04	G57050		51605-SEP-A04	G51737		51606-SZA-A02	G52360		52610-S3V-A05	G64003	
51601-SST-A12	G57050		51605-SEP-A06	G51737		51611-T5R-A04	G52153		52610-S5A-A13	G57061	
51602-A84-A8	G56991		51605-SEP-A11	G51737		51611-TK6-A02	G52153		52610-S5A-C02	G57061	
51602-S3V-315	G57119		51605-SEP-A16	G51737		51611-TK6-A11	G52153		52610-S5A-C11	G57061	
51602-S3V-315	G57120		51605-SLN-A13	G52282		51611-TK6-A51	G52153		52610-S5D-A14	G57061	
51602-S5A-C53	G57049		51605-STK-A03	G52188		51611-TK6-A71	G52153		52610-S5D-A65	G57061	
51602-S5A-C63	G57049		51605-STX-A05	G52250		51611-TX9-A03	G52153		52610-S5P-A03	G57061	
51602-S5T-A04	G57049		51605-SZA-A02	G52361		51621-T5R-A04	G52152		52610-S5P-C52	G57061	
51602-S5T-A12	G57049		51606-S3V-305	G56758		51621-TK6-A02	G52152		52610-S9V-A02	G64003	
51602-S80-A17	G56991		51606-S3V-305	G56759		51621-TK6-A11	G52152		52610-SEP-A05	G57056	
51602-S82-A27	G56991		51606-S3V-A11	G52140		51621-TK6-A51	G52152		52610-SEP-A06	G57056	
51602-S9V-305	G57119		51606-S5A-C21	G57049		51621-TK6-A71	G52152		52610-SEP-A08	G57056	
51602-S9V-A04	G57119		51606-S80-A03	G56991		51621-TX9-A03	G52152				
51605-S3V-305	G56758		51606-S82-A03	G56991		51802-S87-A08	G56991				
51605-S3V-305	G56759		51606-S84-A03	G56991		51920-S0X-A02	143315				
51605-S3V-A11	G52141		51606-S87-A03	G56991		51920-S6M-014	143353				

Important Note: Competitive Interchanges are to be used for stocking purposes only. Where multiple crosses are identified, please reference the applications section of this catalog./ **Remarque importante:** Les interchanges concurrentiels ne s'utilisent qu'aux fins de stocks. Dans le cas de rfrences multiples, consulter la section des applications du catalogue./ **Nota importante:** Dans le cas de rfrences multiples, consulter la section des applications du catalogue./ **Nota importante:** Se pueden usar intercambios competitivos para propósitos de almacenamiento solamente. Cuando se identifican intercambios múltiples, consulte la sección de aplicaciones de este catálogo.

COMPETITIVE & O.E.M. INTERCHANGE LIST

Lista de Intercambios contra Competidores y Equipo Original.

Liste d'interchange de produits compétitifs & d'équipement original (OEM)

Honda... cont'd

Honda	Gabriel	Upgrade	Honda	Gabriel	Upgrade	Honda	Gabriel	Upgrade	Honda	Gabriel	Upgrade
52610-SEP-A13	G57056		52610-TR5-B03	G511092		52611-S5P-A02	G57062		52611-T2A-A13	G51892	
52610-SEP-A14	G57056		52610-TR7-A02	G511092		52611-S5P-A03	G57061		52611-T2B-A03	G51892	
52610-SEP-A18	G57056		52610-TR7-B03	G511092		52611-S6M-A21	G51914		52611-T2F-A02	G51892	
52610-SLN-A04	70060		52610-TR7-B14	G511092		52611-S80-A02	G56943		52611-T3L-A12	G51892	
52610-STK-A03	G51966		52610-TS8-A03	G511092		52611-S82-A02	G56943		52611-TA0-A51	G51892	
52610-STX-A04	G64080		52610-TS8-B03	G511092		52611-S84-A04	G56943		52611-TL2-A01	G51919	
52610-SXS-A05	G57682		52610-TS8-B32	G511092		52611-S87-A04	G56943		52620-S5A-A11	G57062	
52610-TK6-A03	G51905		52610-TS9-A02	G511092		52611-SCV-A02	G51858		52620-S5A-A13	G57062	
52610-TK6-A13	G51905		52610-TS9-B03	G511092		52611-SEC-A02	G51847		52620-S5A-C02	G57062	
52610-TK6-A51	G51905		52610-TS9-B14	G511092		52611-SEC-A04	G51847		52620-S5D-A14	G57062	
52610-TK6-A71	G51905		52611-S5A-A02	G57061		52611-SEP-A04	G51738		52620-S5D-A65	G57062	
52610-TR0-A02	G511092		52611-S5A-A02	G57062		52611-SEP-A06	G51738		52620-S5P-C52	G57062	
52610-TR0-A12	G511092		52611-S5A-N06	G57061		52611-SEP-A12	G51738		52650-S5P-A03	G57062	
52610-TR0-A24	G511092		52611-S5A-N06	G57062		52611-SEP-A17	G51738				
52610-TR2-A03	G511092		52611-S5D-A06	G57061		52611-SWA-A02	G57682				
52610-TR2-B04	G511092		52611-S5D-A06	G57062		52611-SWA-A11	G57682				
52610-TR5-A01	G511092		52611-S5P-A02	G57061							

Hyundai

Hyundai	Gabriel	Upgrade	Hyundai	Gabriel	Upgrade	Hyundai	Gabriel	Upgrade	Hyundai	Gabriel	Upgrade
0K32B-28-700	69585		54650-2C200	G56642		54660-2C250	G56643		55310-1G110	70036	
0K53A-28-700E	70000		54650-2C250	G56642		54660-2C300	G56643		55310-2B101	G64048	
54610-1G505	143409		54650-2C300	G56642		54661-2C250	G56643		55310-4D100	G64071	
54610-1G555	143410		54651-2C250	G56642		54661-2G300	G52248		55310-4D401	G64071	
54610-26000	143087		54651-2G300	G52247		54661-3Q010	G52330		55310-4D500	G64071	
54610-2B000	143416		54651-3Q010	G52329		54661-3V280	G52438		55310-4Z000	G64143	
54610-2C000	143397		54651-3V280	G52437		54661-3V281	G52438		55310-4Z100	G64143	
54610-4D000	143416		54651-3V281	G52437		54661-3V900	G52438		55310-B8300	G64143	
54611-38610	G51714		54651-3V900	G52437		54661-3X151	G52439		55310-FD150	70001	
54611-3K060	G57149		54651-3X151	G52438		54661-4D001	G52258		55311-2G300	70049	
54611-3L040	G51806		54651-4D100	G52257		54661-4D101	G52258		55311-38610	G51713	
54611-3L041	G51806		54651-4D101	G52257		55300-1W200	70095		55311-3L040	70013	
54611-3L640	G51806		54660-1E200	G52155		55300-2V050	70068		55311-3L640	70013	
54650-1E200	G52154		54660-1G100	G52155		55300-2V620	70068		55311-3Q610	70068	
54650-1G100	G52154		54660-1W030	G52354		55300-2V820	70068		55311-3Q710	70068	
54650-1W030	G52353		54660-26100	G56561		55300-3X200	70098		55311-3V080	70068	
54650-26100	G56562		54660-2B100	G52159		55305-26500	69907		55311-4R010	70068	
54650-2B100	G52158		54660-2C000	G56643		55310-1E100	70036		Q0K52-Y3-4380Q	143458	
54650-2C000	G56642		54660-2C200	G56642		55310-1E150	70036				

Koni

Koni	Gabriel	Upgrade	Koni	Gabriel	Upgrade	Koni	Gabriel	Upgrade	Koni	Gabriel	Upgrade
090-2209-SP2	89410		30-1607	G63422		82-2345	G63413		88-1458-SP1	83122	89406
30-1348	G63424		30-1614	G63678		82-2372	G63609		88-1458-SP1	89406	
30-1350	G63511		30-1624	G63424		82-2384	G63488		88-1458-SP2	83122	89406
30-1351	G63490		30-1627	G63690		8240-1029	G63386		88-1458-SP2	89406	
30-1365	G63611		30-1630	G63425		8240-1054	G63375		88-1468	83209	89414
30-1366	G63610		30-1630	G63722		8240-1055	G63454		88-1468	89414	
30-1381	G63426		80-2516	G63421		8240-1148	G63720		88-1476	85740	
30-1421	G63547		80-2517	G63422		84-1168	83130		88-1489	85036	89405
30-1422	G63548		80-2633	G63423		88-1385	83105		88-1489	89405	
30-1456	G63782		80-2634	G63422		88-1417	83312	89409	88-1490	83124	89407
30-1457	G63781		82-1952	G63347		88-1417	89409		88-1490	89407	
30-1501	G63608		82-1954	G63355		88-1419	83136		88-1499	85001	89410
30-1502	G63679		82-1955	G63349		88-1422	85030	89440	88-1499	89410	
30-1565	G63707		82-1970	G63350		88-1422	89440		88-1509	85027	
30-1566	G63708		82-2158	G63357		88-1457-SP1	83209	89414	88-1510	85708	
30-1606	G63423		82-2246	G63299		88-1457-SP1	89414		88-1517	85040	

Important Note: Competitive Interchanges are to be used for stocking purposes only. Where multiple crosses are identified, please reference the applications section of this catalog. / **Remarque importante:** Les interchanges concurrentiels ne s'utilisent qu'aux fins de stocks. Dans le cas de références multiples, consulter la section des applications du catalogue. / **Nota importante:** Dans le cas de referencias multiples, consultar la sección de aplicaciones del catálogo. / **Nota importante:** Se pueden usar intercambios competitivos para propósitos de almacenamiento solamente. Cuando se identifican intercambios múltiples, consulte la sección de aplicaciones de este catálogo.

COMPETITIVE & O.E.M. INTERCHANGE LIST

Lista de Intercambios contra Competidores y Equipo Original.

Liste d'interchange de produits compititifs & d'equipement original (OEM)

Koni... cont'd

Koni	Gabriel	Upgrade	Koni	Gabriel	Upgrade	Koni	Gabriel	Upgrade	Koni	Gabriel	Upgrade
88-1518	85040		88-5163	83122	89406	90-1907-SP1	85300	89419	90-2396-SP1	85000	89436
88-1520	85040		88-5163	89406		90-1907-SP1	89419		90-2396-SP1	85323	89436
88-1525	85040		8805-1001	85125		90-1908-SP1	85723		90-2396-SP1	89436	
88-1532	85708		8805-1002	85124		90-1909-SP1	85722		90-2407	85709	
88-1540	85051		8805-1018	83209	89414	90-1910	85704		90-2434	85702	
88-1541	85045		8805-1018	89414		90-1912	85318		90-2477	85900	
88-1558	85013	89414	8805-1019	83122	89406	90-1922	85900		90-2478	85902	
88-1558	89414		8805-1019	89406		90-1943	85307		90-2497S-P1	85712	
88-1559-SP1	85036	89405	8805-1020	83160		90-1951-SP1	85734		90-2563	85006	
88-1559-SP1	89405		8805-1022	85724	89443	90-1951-SP5	85712		90-2572	85329	
88-1560	85062	89408	8805-1022	89443		90-1965	85304		90-2573	85329	
88-1560	89408		8805-1023	83136		90-1968	85720		90-2575	85700	
88-1561	85012	89413	8805-1042	G63622		90-1974	85311	89424	90-2576	85700	
88-1561	89413		8805-1043	G63623		90-1974	89424		90-2586	85728	
88-1562	85003	89411	8850-1002	G63622		90-2059	85722		90-2587	85729	
88-1562	89411		90-1409-SP1	85722		90-2060	85722		90-2588	85339	
88-1616	85014		90-1577-SP1	85310	89423	90-2102-SP1	85708		90-2589	85727	
88-1639	83130		90-1577-SP1	89423		90-2148	85304		90-2816	85711	
88-1641	85029		90-1811	85301		90-2164-SP1	85723		90-5055-SP2	85318	
88-1641SP3	85029		90-1813-SP1	85712		90-2209	85308	89422	90-5180	85300	89419
88-1642	83124	89407	90-1862	85708		90-2209	89422		90-5180	89419	
88-1642	89407		90-1867	85053	89442	90-2209-SP2	85001	89410	9005-1018	85970	
88-1644	85000	89436	90-1867	89442		90-2209-SP2	89410		9005-1019	85341	
88-1644	89436		90-1868	85307		90-2253-SP2	85732		9020-1042	85708	
88-1646	83613		90-1868-SP1	85307		90-2254	85720		90F-1235	85700	
88-1647	83317		90-1896	85302	89420	90-2256	85732		92-1227	85722	
88-1704	85030	89440	90-1896	89420		90-2257	85716		99B-3254	85029	
88-1704	89440		90-1897	85303	89422	90-2325	85340				
88-5162	83209	89414	90-1897	89422		90-2326	85970				
88-5162	89414		90-1898	83215		90-2327	85341				

KYB

Kyb	Gabriel	Upgrade	Kyb	Gabriel	Upgrade	Kyb	Gabriel	Upgrade	Kyb	Gabriel	Upgrade
231015	G55579		235907	G56734		331039	G52113		333117	G55661	
232027	G55772		235912	G56568		331040	G52112		333118	G55591	
234035	G55591		235913	G56601		331043	G51718		333119	G55591	
234036	G55591		235920	G56817		331046	G52113		333205	G56540	
234057	G55999		235921	G56655		331047	G52112		333206	G56539	
234058	G55999		235950	G55892		331048	G56799		333207	G52336	
234059	G55662		235951	G55892		331049	G56800		333208	G52335	
234060	G55661		235952	G55526		331050	G56799		333209	G55879	
234061	G55911		236001	G56700		331051	G56800		333210	G55879	
234062	G55911		236002	G56701		331613	G52349		333224	G56529	
235005	G55551		236007	G56718		331614	G52348		333225	G56530	
235060	G55681		331008	G56622		3320043	G55911		333236	G55999	
235061	G56513		331009	G56621		332108	G52334		333237	G55999	
235062	G56512		331010	G56678		332109	G52333		333264	G52018	
235619	G55856		331011	G56677		332112	G56529		333265	G52017	
235624	G55994		331016	G51718		332113	G56530		333274	G56633	
235625	G55993		331017	G51728		332135	G52334		333275	G56634	
235626	G55896		331021	G56622		332136	G52333		333276	G56537	
235627	G55892		331022	G56621		3330052	G52155		333277	G56538	
235630	G56635		331027	G56678		3330053	G52154		333316	G56893	
235631	G56636		331028	G56677		333111	G56571		333317	G56892	
235703	G52014		331035	G56799		333111	G56637				
235704	G52013		331036	G56800		333114	G55999				
235902	G55526		331037	G56799		333115	G55999				
235906	G56735		331038	G56800		333116	G55662				

Important Note: Competitive Interchanges are to be used for stocking purposes only. Where multiple crosses are identified, please reference the applications section of this catalog. / **Remarque importante:** Les interchanges concurrentiels ne s'utilisent qu'aux fins de stocks. Dans le cas de références multiples, consulter la section des applications du catalogue. / **Nota importante:** Dans le cas de referencias multiples, consultar la sección de aplicaciones del catálogo. / **Nota importante:** Se pueden usar intercambios competitivos para propósitos de almacenamiento solamente. Cuando se identifican intercambios múltiples, consulte la sección de aplicaciones de este catálogo.

COMPETITIVE & O.E.M. INTERCHANGE LIST
Lista de Intercambios contra Competidores y Equipo Original.
Liste dinterchange de produits comptitifs & dquipement original (OEM)

KYB... cont'd

Kyb	Gabriel	Upgrade	Kyb	Gabriel	Upgrade	Kyb	Gabriel	Upgrade	Kyb	Gabriel	Upgrade
333318	G56529		334228	G55949		334479	G55675		335033	G56687	
333319	G56530		334245	G56514		334500	G56561		335035	G56688	
333331	G52283		334246	G56506		334501	G56562		335036	G56687	
333332	G52282		334265	G56684		334502	G56820		335037	G56509	
333348	G56517		334266	G56683		334503	G56819		335040	G56581	
333349	G56516		334294	G55901		334504	G56821		335041	G56582	
333350	G56633		334316	G55698		334505	G56822		335059	G52104	
333351	G56634		334321	G56784		334506	G52159		335060	G52103	
333355	G52019		334322	G56785		334507	G52158		335061	G55948	
333382	G56894		334333	G56568		334508	G52248		335065	G52116	
333385	G52098		334334	G56601		334509	G52247		335070	G52104	
333417	G56887		334335	G56620		334611	G56802		335071	G52103	
333418	G56886		334336	G56672		334621	G52165		335072	G52128	
333461	G56809		334337	G56671		334621	G52298		335073	G52127	
333462	G56809		334364	G56758		334622	G52164		335074	G52128	
333474	G52283		334365	G56759		334622	G52297		335075	G52127	
333475	G52282		334366	G56684		334636	G52111		335082	G52294	
333490	G52161		334366	G56686		334637	G52110		335083	G52293	
333491	G52160		334367	G56683		334642	G52082		335084	G52128	
333492	G52163		334367	G56685		334643	G52081		335085	G52127	
333493	G52162		334380	G52009		334644	G56841		335094	G52127	
333500	G56641		334381	G52008		334645	G56840		335095	G52127	
333501	G56640		334384	G56735		334652	G52130		335610	G52399	
333508	G56643		334385	G56734		334653	G52129		335611	G52398	
333509	G56642		334386	G56722		334658	G52082		335623	G52406	
333516	G52155		334387	G56721		334659	G52081		3357504	G52495	
333517	G52154		334388	G56729		334673	G52131		3357505	G52494	
333602	G52095		334389	G56728		334684	G52281		3358000	G52301	
333603	G52094		334394	G56733		334685	G52280		335808	G56899	
333604	G52095		334395	G56732		334686	G52396		335809	G56778	
333605	G52094		334399	G56680		334687	G52395		335810	G56778	
333617	G52440		334399	G56731		334688	G52176		335814	G52301	
333618	G52439		334400	G56679		334689	G52175		335815	G52314	
333781	G56641		334400	G56730		334692	G52352		335816	G52314	
333782	G56640		334420	G56894		334693	G52351		335833	G52200	
3340049	G52173		334428	G56680		334698	G52298		335834	G52199	
3340050	G52174		334429	G56679		334699	G52297		335844	G52128	
3340063	G52081		334430	G52107		334700	G52006		335845	G52127	
3340064	G52082		334430	G56797		334701	G52005		335920	G56791	
3340128	G56843		334431	G52108		3348018	G52450		335920	G56792	
3340129	G56842		334431	G56798		3348019	G52449		335924	G52145	
334015	G56518		334432	G52169		3348041	G52256		335925	G52144	
3340158	G52411		334433	G52168		3348042	G52255		338001	G52153	
3340159	G52410		334440	G56671		3348056	G52256		338002	G52152	
334016	G56518		334441	G56672		3348057	G52255		338009	G52153	
3340213	G52495		334450	G56660		334812	G56606		338010	G52152	
3340214	G52494		334451	G56661		334834	G56899		338011	G56887	
3340249	G52149		334452	G52106		334842	G52275		338012	G56886	
3340250	G52148		334453	G52105		334843	G52274		338013	G56837	
334133	G55676		334454	G52033		334945	G52238		338014	G56836	
334134	G55675		334455	G52032		334946	G52237		338019	G52163	
334169	G55901		334464	G52185		335030	G56616		338020	G52162	
334188	G55697		334465	G52184		335031	G56615		338022	G52157	
334195	G56518		334472	G56843		335032	G56616		338023	G52156	
334196	G56518		334473	G56842		335032	G56688		338106	G52354	
334227	G55948		334478	G55676		335033	G56615		338107	G52353	

Important Note: Competitive Interchanges are to be used for stocking purposes only. Where multiple crosses are identified, please reference the applications section of this catalog. / **Remarque importante:** Les interchanges concurrentiels ne s'utilisent qu'aux fins de stocks. Dans le cas de références multiples, consulter la section des applications du catalogue. / **Nota importante:** Dans le cas de références multiples, consulter la section des applications du catalogue. / **Nota importante:** Se pueden usar intercambios competitivos para propósitos de almacenamiento solamente. Cuando se identifican intercambios múltiples, consulte la sección de aplicaciones de este catálogo.

COMPETITIVE & O.E.M. INTERCHANGE LIST
Lista de Intercambios contra Competidores y Equipo Original.
Liste dinterchange de produits comptitifs & dquipement original (OEM)

KYB... cont'd

Kyb	Gabriel	Upgrade	Kyb	Gabriel	Upgrade	Kyb	Gabriel	Upgrade	Kyb	Gabriel	Upgrade
339015	G55948		339190	G52122		339378	G52278		341203	G55909	
339023	G56889		339191	G52121		339725	G52006		341205	G51742	
339024	G56888		339192	G56722		339726	G52005		341207	G51097	
339025	G52104		339194	G52246		340010	G511020		341217	G51841	
339026	G52103		339195	G52245		340011	G511019		341244	G55825	
339031	G52007		339196	G52174		340018	G51898		341245	G56565	
339032	G52004		339197	G52173		340019	G51815		341253	G56597	
339037	G52250		339198	G52174		340022	G51806		341254	G56597	
339038	G52249		339199	G52173		340024	G51806		341257	G55870	
339039	G52151		339204	G52265		340028	G51856		341260	G51255	
339040	G52150		339205	G52264		340029	G51878		341261	G51256	
339043	G52104		339214	G56721		340030	G51877		341266	G56598	
339044	G52103		339216	G52204		340031	G511003		341271	G51727	
339053	G52026		339217	G52203		340038	G51897		341274	G51772	
339054	G52027		339224	G52273		340039	G51896		341276	G51767	
339057	G56773		339225	G52272		340040	G51878		341279	G51279	
339058	G56774		339230	G52202		340041	G51877		341280	G51714	
339072	G52141		339231	G52201		340043	G63909		341281	G51713	
339073	G52140		339234	G52204		340044	G51892		341287	G55870	
339080	G52300		339235	G52203		340045	G511055		341293	G51254	
339081	G52299		339242	G52332		340046	G511054		341299	G51740	
339084	G56810		339243	G52331		340049	G51919		341302	G63678	
339085	G56810		339246	G52131		340050	G51937		341311	G51700	
339086	G56514		339247	G52118		340054	G51918		341322	G51795	
339087	G56506		339248	G52117		340055	G51917		341326	G51722	
339098	G52273		339249	G52149		340056	G51911		341327	G51724	
339099	G52272		339250	G52148		340063	G51738		341330	G51737	
339100	G52108		339251	G52148		340066	G51737		341331	G51738	
339101	G52107		339251	G52149		340068	G51863		341339	G63918	
339102	G52106		339252	G52148		340069	G51916		341340	G51739	
339102	G52108		339252	G52149		340070	G51975		341341	G51727	
339103	G52105		339261	G52188		340071	G51860		341342	G51794	
339103	G52107		339262	G52187		340072	G51861		341343	G63783	
339114	G52246		339263	G52254		340073	G51864		341343	G63893	
339115	G52245		339264	G52253		340075	G51865		341344	G51739	
339124	G52300		339269	G52143		340084	83515		341348	G51838	
339125	G52299		339270	G52142		340085	G51739		341351	G51811	
339128	G52097		339272	G52125		340090	G51933		341352	G51810	
339129	G52096		339309	G52258		340094	G51863		341361	G51838	
339140	G52261		339310	G52257		340098	G51863		341362	G51716	
339141	G52260		339311	G52171		340115	G51972		341363	G51898	
339146	G52122		339312	G52170		340121	G51856		341364	G52037	
339147	G52121		339331	G52383		3410014	G51898		341365	G52036	
339148	G55949		339332	G52382		3410018	G51842		341366	G51814	
339149	G52183		339344	G52131		3410084	G511038		341367	G51813	
339150	G52182		339345	G52356		341117	G55774		341368	G51794	
339155	G52210		339346	G52355		341118	G55774		341369	G51738	
339156	G52209		339347	G52525		341120	G56591		341373	G51883	
339169	G52375		339348	G52524		341125	G55804		341374	G51850	
339170	G52374		339361	G52361		341140	G51063		341374	G63884	
339179	G56889		339362	G52360		341141	G55820		341382	G51736	
339180	G56888		339365	G52188		341165	G51254		341392	G51832	
339183	G56889		339366	G52187		341180	G51855		341393	G51833	
339185	G52103		339375	G52436		341191	G51252		341402	G51880	
339188	G52171		339376	G52435		341198	G55910		341405	G51859	
339189	G52170		339377	G52279		341202	G51087		341406	G51859	

Important Note: Competitive Interchanges are to be used for stocking purposes only. Where multiple crosses are identified, please reference the applications section of this catalog./ **Remarque importante:** Les interchanges concurrentiels ne s'utilisent qu'aux fins de stocks. Dans le cas de rfrences multiples, consulter la section des applications du catalogue./ **Nota importante:** Dans le cas de rfrences multiples, consulter la section des applications du catalogue./ **Nota importante:** Se pueden usar intercambios competitivos para propósitos de almacenamiento solamente. Cuando se identifican intercambios múltiples, consulte la sección de aplicaciones de este catálogo.

COMPETITIVE & O.E.M. INTERCHANGE LIST
Lista de Intercambios contra Competidores y Equipo Original.
Liste dinterchange de produits comptitifs & dquipement original (OEM)

KYB... cont'd

Kyb	Gabriel	Upgrade	Kyb	Gabriel	Upgrade	Kyb	Gabriel	Upgrade	Kyb	Gabriel	Upgrade
341419	G51723		341621	85311	89424	343127	81750		343419	70056	
341425	G51908		341621	89424		343127	82118		343425	G63409	
341440	G51477		341622	85023	89415	343128	69675		343426	70028	
341441	G51926		341622	89415		343128	82110		343429	69464	
341442	G51925		341623	85003	89411	343130	69724		343433	G63872	
341443	G51910		341623	89411		343130	82051		343435	G64052	
341444	G51908		341624	85036	89405	343131	69624		343442	G51783	
341448	G51898		341624	89405		343135	69606		343444	G63907	
341457	G51852		341625	85000	89436	343143	82005		343452	69420	
341458	G51854		341625	89436		343144	82001		343454	69589	
341459	G51853		341626	85000	89436	343147	81340		343458	70041	
341463	G51286		341626	89436		343149	82155		343460	G51807	
341466	G51477		341627	85006		343156	81491		343465	70041	
341467	G51766		341628	85724	89443	343157	69604		343471	G51783	
341468	G51765		341628	89443		343157	81492		343479	G51716	
341472	G51849		341629	85938		343161	69755		343484	G64089	
341473	G51849		341630	85052		343164	69632		343487	70060	
341474	G56838		341631	646155		343208	G63902		3438002	70052	
341475	G56839		341632	83124	89407	343208	G63909		3440012	G511044	
341476	G51806		341632	89407		343209	G63903		3440013	G511078	
341478	G51713		341633	83215		343209	G63937		3440022	G51965	
341480	G51855		341654	G51842		343210	G63799		3440029	77967	
341481	G51774		341658	70027		343211	69676		3440035	G511030	
341483	G51825		341659	70027		343218	69622		3440040	G51980	
341484	G51815		341661	G51704		343219	81270		3440047	G511135	
341485	G51758		341662	G51703		343240	82156		3440049	G51766	
341486	G51961		341664	G51719		343247	G63799		3440055	G511038	
341488	G51286		341665	G51729		343252	G63907		3440060	G51766	
341489	G51758		341666	G51948		343255	69863		3440067	G64177	
341492	G51879		341667	G51947		343270	70020		3440072	70213	
341493	G51870		341668	G51842		343272	69813		344008	G511030	
341493	G51891		341679	G51836		343280	69945		3440084	G64146	
341495	G51847		341681	G51916		343281	69946		3440089	G63866	
341499	G51848		341682	G51975		343284	69946		344015	G63928	
341600	G51715		341683	G51934		343290	69464		344040	G63421	
341601	G51703		341704	G51900		343291	69465		344041	G63422	
341601	G51704		3417504	G511000		343295	69450		344042	G63423	
341602	G51703		3417505	G51721		343308	69587		344043	G63813	
341603	70013		341814	69586		343313	G63860		344043	G63902	
341604	G51267		341842	G51097		343314	G63860		344043	G63909	
341605	G51719		341845	G51740		343330	82125		344044	G63173	
341607	G51729		341907	G51759		343342	G63902		344044	G63492	
341609	G51761		341924	G51881		343348	69945		344044	G63907	
341609	G51947		341952	G64047		343352	69863		344045	G63419	
341613	85062	89408	341966	G51759		343353	69585		344045	G63492	
341613	89408		3430015	G51905		343353	70001		344047	G63950	
341614	85001	89410	3430019	G51799		343367	G63907		344049	G63414	
341614	89410		3430024	G51799		343379	G63845		344050	G63773	
341615	83215		3430041	70207		343381	70060		344054	G63404	
341617	85005	89430	3430043	G51990		343385	69473		344055	G63299	
341617	89430		3430044	G51766		343388	G63712		344055	G63689	
341618	85918	89449	3430068	70231		343395	G63842		344066	G63359	
341618	89449		343010	69787		343395	G64014		344067	G63347	
341619	83136		343127	69600		343410	G63937		344068	G63355	
341620	85033	89427	343127	69625		343412	70003		344070	G63353	
341620	89427		343127	69675		343413	69464		344071	G63350	

Important Note: Competitive Interchanges are to be used for stocking purposes only. Where multiple crosses are identified, please reference the applications section of this catalog. / **Remarque importante:** Les interchanges concurrentiels ne s'utilisent qu'aux fins de stocks. Dans le cas de références multiples, consulter la section des applications du catalogue. / **Nota importante:** Dans le cas de références multiples, consulter la section des applications du catalogue. / **Nota importante:** Se pueden usar intercambios competitivos para propósitos de almacenamiento solamente. Cuando se identifican intercambios múltiples, consulte la sección de aplicaciones de este catálogo.

COMPETITIVE & O.E.M. INTERCHANGE LIST
Lista de Intercambios contra Competidores y Equipo Original.
Liste dinterchange de produits comptitifs & dquipement original (OEM)

KYB... cont'd

Kyb	Gabriel	Upgrade	Kyb	Gabriel	Upgrade	Kyb	Gabriel	Upgrade	Kyb	Gabriel	Upgrade
344072	G63349		344296	70000		344404	G63844		344655	70068	
344073	G63413		344298	G63611		344406	G64087		344655	70209	
344074	G63183		344299	G63710		344409	G63918		344658	G64216	
344075	G63413		344304	G63375		344410	G63885		344660	G51721	
344076	G63410		344305	G63678		344410	G64029		344663	70210	
344076	G63414		344308	G511007		344410	G64030		344664	70213	
344077	G63406		344314	69907		344413	G63810		344807	69586	
344078	G63409		344328	83159		344414	G63870		344808	69586	
344078	G63683		344338	G63776		344415	G63867		3450011	G64043	
344079	G63775		344338	G63869		344415	G64157		3450014	G64121	
344080	G63426		344341	G63847		344418	G63425		345005	G63694	
344080	G63690		344342	G63829		344419	G63888		345022	G63832	
344081	G63375		344353	69909		344426	G63299		345023	G63828	
344081	G63915		344355	G63707		344427	G63904		345024	G63864	
344082	G63454		344356	69900		344427	G63909		345025	83515	
344084	G63490		344358	G64087		344428	G63494		345030	G63394	
344085	G63306		344359	G63720		344428	G63510		345038	G63615	
344086	G63353		344363	69591		344429	G63907		345039	G63694	
344087	G63377		344364	77980		344430	G63495		345042	G63883	
344088	G63424		344365	G63662		344430	G63611		345043	G63878	
344089	G63424		344366	G63366		344430	G63909		345055	G63872	
344089	G63683		344367	G63714		344431	G63620		345055	G64140	
344090	G63492		344368	G63716		344432	69962		345056	G64033	
344090	G63928		344369	G63624		344433	69898		345061	77949	
344091	G63511		344370	G63622		344434	69962		345062	G63971	
344092	G63490		344371	G63623		344435	G63721		345067	G64031	
344093	G63905		344372	G63661		344436	G63866		345068	69595	
344094	G63915		344373	G63674		344437	G63866		345070	G63888	
344097	G63907		344373	G63675		344438	G63869		345072	G64010	
344110	69845		344374	G63778		344439	G51798		345073	G63866	
344202	G63479		344375	G63715		344440	G64105		345074	G63959	
344202	G63547		344376	G63673		344447	G63689		345075	69594	
344222	G63782		344377	G63717		344448	G63689		345080	G63622	
344223	G63781		344378	G63403		344450	G51802		345084	G63872	
344229	G63708		344378	G63890		344455	G51812		345601	83613	
344262	G63638		344378	G63891		344459	G51799		345602	85052	
344262	G63897		344379	G63403		344464	G63879		345604	85051	
344263	G63488		344380	G63783		344465	G63884		345605	85012	89413
344263	G63638		344381	G63803		344466	G63882		345605	89413	
344264	G63387		344382	G63808		344467	G63873		345606	83136	
344265	G63489		344383	G63817		344468	G63909		345607	83130	
344265	G63783		344384	G63866		344469	G63813		345608	85060	
344266	G63609		344385	G63866		344475	G63902		345609	83515	
344266	G63818		344386	G63675		344479	G51803		345611	83120	
344267	G63455		344387	G63692		344480	G51805		345613	85005	89430
344268	G63614		344388	G63929		344481	G63894		345613	89430	
344269	G63679		344396	G63525		344483	G63896		345614	83309	
344272	G63386		344396	G63683		344487	70034		345615	83314	
344273	G63638		344396	G63773		344491	G51812		345616	83125	
344274	G55821		344397	G63772		344496	G64012		345617	83203	89436
344279	G63707		344398	G63958		344500	G64048		345617	89436	
344290	G63490		344399	G63848		344501	70049		345618	83126	89430
344291	G63676		344400	G63958		344609	G51267		345618	89430	
344291	G63873		344400	G64009		344610	G51268		345620	83456	89447
344294	G64027		344402	G63783		344611	G51858		345620	89447	
344295	G64028		344403	G63722		344612	G51736		345621	85003	89411

Important Note: Competitive Interchanges are to be used for stocking purposes only. Where multiple crosses are identified, please reference the applications section of this catalog./ **Remarque importante:** Les interchanges concurrentiels ne s'utilisent qu'aux fins de stocks. Dans le cas de rfrences multiples, consulter la section des applications du catalogue./ **Nota importante:** En el caso de referencias multiples, consultar la sección de aplicaciones del catálogo./ **Nota importante:** Se pueden usar intercambios competitivos para propósitos de almacenamiento solamente. Cuando se identifican intercambios múltiples, consulte la sección de aplicaciones de este catálogo.

COMPETITIVE & O.E.M. INTERCHANGE LIST
Lista de Intercambios contra Competidores y Equipo Original.
Liste dinterchange de produits comptitifs & dquipement original (OEM)

KYB... cont'd

Kyb	Gabriel	Upgrade	Kyb	Gabriel	Upgrade	Kyb	Gabriel	Upgrade	Kyb	Gabriel	Upgrade
345621	89411		349085	70037		365070	G44986		551130	G51921	
345624	G64148		349086	70086		366010	G44461		551131	G51920	
345625	G511000		349092	G51884		441120	G55698		551132	G51922	
345626	G511000		349093	G51874		441120	G55825		551133	G51864	
345626	G511038		349094	G64071		441133	83515		551134	G51865	
345627	G51928		349095	G51966		441600	85310	89423	551136	G511142	
346016	G51905		349097	G64050		441600	89423		551139	G51766	
348002	70036		349098	70095		441602	85724	89443	551600	G51887	
348007	70036		349101	G64047		441602	89443		551602	G51888	
348016	G51905		349102	70013		443078	G63902		551605	G51746	
348018	70052		349105	70010		443216	G63495		551610	G51773	
348019	G511092		349106	G511001		443240	G63907		5530004	G64089	
348023	G51807		349108	G64079		443259	G63907		5530008	70089	
348029	G51990		349109	G51799		443363	G63845		5530013	G51874	
348032	G51971		349110	G64043		443477	69632		553153	77907	
348038	69464		349115	70078		443478	69945		553158	G63799	
348060	G511037		349117	G64042		444012	G63492		553160	77479	
348066	G511092		349119	83159		444024	G63492		553171	G63495	
348069	70055		349122	G64046		444058	83159		553197	69952	
348085	G511092		349123	G63958		444135	G63678		553198	69966	
349001	G63918		349124	G63967		444136	G63775		553209	G63495	
349004	58944		349125	G63776		444203	83515		553239	69863	
349005	G64032		349125	G64040		444209	83114		553256	83159	
349007	70039		349127	83159		444235	G63421		553303	G63845	
349008	69590		349130	G64040		444236	G63422		553310	69624	
349009	G63897		349136	70059		444244	G63409		553311	77971	
349010	G63889		349136	70204		444245	G63406		553320	69600	
349010	G64006		349139	70089		444249	G63489		553333	69473	
349024	G64026		349142	G64111		444250	G63488		553345	G64016	
349024	G64151		349146	G63888		444252	G63638		553346	G63892	
349025	G64080		349147	G64121		444254	G63366		553360	G63937	
349026	69592		349151	G64104		444255	G63414		553361	G63689	
349026	69593		349165	70096		444256	G63455		553367	70033	
349035	70053		349168	G51996		444269	83159		553381	70038	
349039	G64003		349183	G63886		444323	G63907		553385	70040	
349040	G511004		349184	70098		444328	83159		553387	G63907	
349043	69587		349185	G63885		445016	83515		553389	G51983	
349044	G64089		349187	G64216		445054	83613		553392	G511001	
349045	G64089		349191	G63894		445064	83162		5540000	77951	
349046	G63895		349194	G511002		445067	85009		5540005	G63918	
349047	G51955		349194	G511134		446074	85308	89422	5540007	G64089	
349054	G63815		349198	G511123		446074	89422		5540017	G64089	
349054	G64038		349199	G511122		446075	83215		5540021	G511043	
349060	70013		349207	69907		447001	85308	89422	5540022	77976	
349065	70086		349212	G511044		447001	89422		554003	G63610	
349067	G51993		349217	70203		5510000	G51860		554041	G56802	
349068	G64037		349219	G511078		5510001	G51861		554044	77726	
349069	G63966		349225	G64042		5510025	G51980		554060	G63455	
349069	G63967		349230	G64012		551091	77678		554069	77479	
349071	G64008		349232	G63799		551093	G51477		554075	77907	
349073	G64042		349237	G511043		551104	G51739		554100	G63495	
349075	70089		349240	G511044		551105	70003		554101	77907	
349076	G64056		349243	70068		551121	G51891		554125	G63707	
349078	G64050		349244	70068		551125	G51855		554127	G63708	
349080	G64063		354055	G64015		551126	G51921		554128	77726	
349083	G64063		363030	G44748		551127	G51920		554131	G63494	

Important Note: Competitive Interchanges are to be used for stocking purposes only. Where multiple crosses are identified, please reference the applications section of this catalog. / **Remarque importante:** Les interchanges concurrentiels ne s'utilisent qu'aux fins de stocks. Dans le cas de références multiples, consulter la section des applications du catalogue. / **Nota importante:** Dans le cas de références multiples, consulter la section des applications du catalogue. / **Nota importante:** Se pueden usar intercambios competitivos para propósitos de almacenamiento solamente. Cuando se identifican intercambios múltiples, consulte la sección de aplicaciones de este catálogo.

COMPETITIVE & O.E.M. INTERCHANGE LIST
Lista de Intercambios contra Competidores y Equipo Original.
Liste d'interchange de produits compititifs & d'equipement original (OEM)

KYB... cont'd

Kyb	Gabriel	Upgrade	Kyb	Gabriel	Upgrade	Kyb	Gabriel	Upgrade	Kyb	Gabriel	Upgrade
554132	G63928		554243	77815		554378	G64040		KG4515	82110	
554152	G63776		554244	G63611		554379	G64042		KG4530	69996	
554153	77489		554245	G63710		554380	83159		KG4537	69714	
554154	77638		554246	77783		554382	G64089		KG4539	69725	
554156	77915		554247	77817		554383	83159		KG4540	69677	
554158	G63890		554248	77953		554384	70098		KG4613A	G63909	
554159	77915		554249	77412		554385	70095		KG4731	70065	
554160	77905		554252	G63404		554385	70102		KG4738	G63860	
554161	77375		554255	77909		554385	70208		KG4740	70064	
554162	G63624		554257	77907		554386	G63862		KG4742	69952	
554163	77609		554260	77414		554388	77952		KG4743	69966	
554165	G51724		554262	77454		554389	G64121		KG4745A	G63799	
554166	77716		554264	G63511		554390	G64043		KG4752	G63937	
554168	77461		554265	G63490		554398	G63873		KG5039	G63844	
554169	G63424		554268	77909		554402	G511002		KG5040	77803	
554170	77525		554270	77412		5550006	77976		KG5041	77953	
554173	77907		554274	77614		555023	G63878		KG5045	G63868	
554174	G63299		554277	G63623		555024	G63883		KG5194	G64000	
554177	77614		554280	69604		555038	77614		KG5196	77950	
554178	77608		554281	69600		555039	77623		KG5197	77829	
554180	77422		554292	69624		555050	77983		KG5401	G63299	
554182	G63690		554306	75676		555051	G64031		KG5404	G63360	
554184	77909		554312	77375		555052	69594		KG5406	G63386	
554185	G63844		554319	77817		555054	77953		KG54100	77638	
554186	77716		554320	77947		555054	77975		KG54101	77638	
554187	77715		554321	77954		555055	77976		KG54102	77661	
554188	77803		554322	77949		555056	77952		KG54103	77674	
554189	77953		554324	77638		555057	G64033		KG54103	77948	
554195	G63867		554327	G63882		555058	77953		KG54103	77980	
554198	77953		554328	G51850		555060	69595		KG54104	77662	
554199	77950		554329	G63879		555601	69575		KG5420	G63366	
554200	77829		554330	77909		555603	69574		KG5421	G63387	
554203	G63386		554331	77909		555604	G51904		KG5422	G63183	
554206	77638		554342	G63894		555609	G51871		KG54300	G63615	
554207	77661		554344	77638		555610	G64046		KG54301	G63616	
554208	77661		554347	77951		564002	G51077		KG54302	G63782	
554209	77662		554347	77967		565013	G63624		KG54303	G63781	
554210	G63353		554348	77638		565033	77638		KG54304	G63707	
554211	G63350		554350	G63889		565060	77375		KG54306	77675	
554216	77662		554353	G64015		565062	77609		KG54308	G63708	
554223	77662		554356	G63895		565068	77412		KG54309	77678	
554225	G63676		554359	77949		565090	77809		KG5431	G63511	
554228	77661		554360	77950		565091	77809		KG54310	G63676	
554229	77717		554362	77968		565101	77783		KG54311	77714	
554230	77717		554362	77969		634812	G56606		KG54313	77716	
554231	77978		554364	77981		734033	G56606		KG54314	77715	
554233	77783		554365	77973		743029	69945		KG54315	77673	
554234	77803		554367	G64038		KG4026	G63492		KG54317	G63726	
554235	77678		554369	77807		KG4159	G63892		KG54319	G64002	
554236	77614		554370	77623		KG4160	G64016		KG54320	77455	
554237	G63950		554372	G64063		KG4162	77971		KG54320	77717	
554238	77614		554373	G64079		KG4163	G63845		KG54321	77403	
554239	77607		554374	G64043		KG4503	82026		KG54322	77403	
554240	77808		554375	G64043		KG4503	82069		KG54323	77978	
554241	77808		554376	G63966		KG4507	82011		KG54325	G63776	
554242	77815		554377	G64012		KG4515	69675		KG54326	77783	

Important Note: Competitive Interchanges are to be used for stocking purposes only. Where multiple crosses are identified, please reference the applications section of this catalog. / **Remarque importante:** Les interchanges concurrentiels ne s'utilisent qu'aux fins de stocks. Dans le cas de références multiples, consulter la section des applications du catalogue. / **Nota importante:** Dans le cas de références multiples, consulter la section des applications du catalogue. / **Nota importante:** Se pueden usar intercambios competitivos para propósitos de almacenamiento solamente. Cuando se identifican intercambios múltiples, consulte la sección de aplicaciones de este catálogo.

COMPETITIVE & O.E.M. INTERCHANGE LIST
Lista de Intercambios contra Competidores y Equipo Original.
Liste dinterchange de produits comptitifs & dquipement original (OEM)

KYB... cont'd

Kyb	Gabriel	Upgrade	Kyb	Gabriel	Upgrade	Kyb	Gabriel	Upgrade	Kyb	Gabriel	Upgrade
KG54327	77803		KG5496	G63624		KG9025	G51077		SM5234	142643	
KG54328	77772		KG5497	77807		KG9026	G51477		SM5237	142653	
KG54329	77607		KG5497	G63622		SB101	143057		SM5244	143465	
KG54330	77809		KG5498	77623		SB103	143058		SM5245	143466	
KG54330	G63809		KG5498	G63623		SB104	143059		SM5253	143259	
KG54331	77837		KG5507	69724		SB107	143063		SM5256	142735	
KG54331	G63837		KG5507	82051		SB132	143064		SM5260	143082	
KG54332	77808		KG5522	69606		SM5003	142567		SM5264	143423	
KG54333	77810		KG5534	G63610		SM5011	142091		SM5265	142932	
KG54333	G63810		KG5538	77494		SM5013	142135		SM5285	143459	
KG54335	77815		KG5554	69766		SM5034	142195		SM5295	143087	
KG54336	77815		KG5562	75676		SM5041	142852		SM5300	142852	
KG54339	77783		KG5564	69715		SM5042	142316		SM5314	143464	
KG54340	77817		KG5570	69811		SM5049	143281		SM5324	142546	
KG54341	77662		KG5571	69795		SM5057	142530		SM5329	142938	
KG54342	77412		KG5572	77375		SM5058	142230		SM5361	143492	
KG5438	77907		KG5575	69962		SM5067	142247		SM5366	143204	
KG5440	77414		KG5603A	G63418		SM5070	142252		SM5375	142250	
KG5440	77905		KG5614	77909		SM5078	142244		SM5378	142444	
KG5440	G63350		KG5615	77909		SM5079	142245		SM5379	143380	
KG5444	G63904		KG5744	77847		SM5081	142317		SM5382	143094	
KG5446	G63813		KG5747	69901		SM5091	142419		SM5385	142561	
KG5446	G63909		KG5780	G63894		SM5091	143394		SM5388	143087	
KG5451	77422		KG5784	77947		SM5091	143422		SM5391	143362	
KG5452	77423		KG5785	77954		SM5093	142403		SM5392	143357	
KG5455	G63456		KG5786	77949		SM5094	142404		SM5395	143241	
KG5457	G63690		KG5787A	69757		SM5109	142329		SM5398	143073	
KG5458	77375		KG6002A	85030	89440	SM5110	142842		SM5399	143074	
KG5458	77915		KG6002A	89440		SM5122	142546		SM5402	143353	
KG5459	77454		KG6003	83309		SM5123	142547		SM5403	143353	
KG5462	77494		KG6004	85320	89429	SM5126	142561		SM5409	142937	
KG5465	77425		KG6004	89429		SM5133	142439		SM5423	143202	
KG5466	G63492		KG6005	83216		SM5136	142840		SM5424	143244	
KG5474	77479		KG6006	85012	89413	SM5137	143320		SM5425	143244	
KG5475	77726		KG6006	89413		SM5138	142843		SM5441	143398	
KG5475	G63432		KG6007	85007		SM5140	142402		SM5442	143325	
KG5476	77909		KG6008A	83122	89406	SM5151	143458		SM5443	143404	
KG5478	77489		KG6008A	89406		SM5162	143367		SM5444	143405	
KG5479	77488		KG6009A	83303		SM5165	143191		SM5447	143354	
KG5480	77609		KG6010	83308		SM5168	142828		SM5451	143239	
KG5481	G63411		KG6198	G63616		SM5169	142930		SM5459	143218	
KG5482	77412		KG6199	85012	89413	SM5174	142836		SM5460	142419	
KG5484	G63635		KG6199	89413		SM5178	143197		SM5461	143088	
KG5487	77525		KG6201	83456	89447	SM5179	142649		SM5471	143355	
KG5487	77683		KG6201	89447		SM5180	142650		SM5472	143194	
KG5487	G63525		KG6403	G63605		SM5181	142651		SM5475	143191	
KG5488	G63403		KG6406	G63183		SM5184	143325		SM5476	143425	
KG5489	77614		KG6407	G63394		SM5193	142625		SM5483	143089	
KG5489	G63614		KG6412	G63625		SM5197	142444		SM5489	143418	
KG5490	77679		KG6413	77614		SM5198	143256		SM5491	143388	
KG5491	G63604		KG6413	G63622		SM5199	142932		SM5492	143387	
KG5493	77461		KG6414	77623		SM5203	142938		SM5513	143323	
KG5493	77524		KG6415	85013	89414	SM5211	143315		SM5517	143419	
KG5494	G63620		KG6415	89414		SM5213	143209		SM5530	143316	
KG5495	77608		KG6416	83123	89405	SM5215	143201		SM5531	143324	
KG5495	G63929		KG6416	89405		SM5217	142949		SM5533	143335	

Important Note: Competitive Interchanges are to be used for stocking purposes only. Where multiple crosses are identified, please reference the applications section of this catalog. / **Remarque importante:** Les interchanges concurrentiels ne s'utilisent qu'aux fins de stocks. Dans le cas de rferences multiples, consulter la section des applications du catalogue. / **Nota importante:** Dans le cas de rferences multiples, consulter la section des applications du catalogue. / **Nota importante:** Se pueden usar intercambios competitivos para propósitos de almacenamiento solamente. Cuando se identifican intercambios múltiples, consulte la sección de aplicaciones de este catálogo.

COMPETITIVE & O.E.M. INTERCHANGE LIST
Lista de Intercambios contra Competidores y Equipo Original.
Liste dinterchange de produits comptitifs & dquipement original (OEM)

KYB... cont'd

Kyb	Gabriel	Upgrade	Kyb	Gabriel	Upgrade	Kyb	Gabriel	Upgrade	Kyb	Gabriel	Upgrade
SM5535	143369		SR4025	G56938		SR4095	G57069		SR4153	G57349	
SM5535	143468		SR4027	G57064		SR4096	G57077		SR4154	G57666	
SM5537	143305		SR4028	G57063		SR4097	G57076		SR4155	G57665	
SM5539	143416		SR4029	G56931		SR4098	G57122		SR4156	G57035	
SM5542	143455		SR4030	G56930		SR4099	G57122		SR4157	G57034	
SM5567	143344		SR4033	G56934		SR4100	G57046		SR4158	G57016	
SM5568	142526		SR4033	G56937		SR4101	G57045		SR4159	G57111	
SM5569	143319		SR4034	G56936		SR4102	G57142		SR4159	G57536	
SM5581	143564		SR4035	G56933		SR4105	G57046		SR4160	G57110	
SM5582	143462		SR4036	G56932		SR4106	G57045		SR4160	G57535	
SM5583	143461		SR4037	G56928		SR4107	G57026		SR4161	G57198	
SM5589	143191		SR4038	G56957		SR4108	G57191		SR4162	G57197	
SM5589	143365		SR4039	G56956		SR4109	G57190		SR4163	G57031	
SM5597	143408		SR4040	G56997		SR4110	G57191		SR4164	G57030	
SM5601	143495		SR4041	G56996		SR4111	G57190		SR4165	G57053	
SM5602	143318		SR4042	G56998		SR4112	G57193		SR4166	G57053	
SM5603	143391		SR4051	G57018		SR4113	G57192		SR4167	G57271	
SM5604	143390		SR4052	G57039		SR4115	G57081		SR4168	G57120	
SM5607	142930		SR4053	G56965		SR4116	49255		SR4169	G57119	
SM5608	143363		SR4054	G57042		SR4117	G57358		SR4170	G57120	
SM5610	143460		SR4055	G57041		SR4118	G57357		SR4171	G57103	
SM5618	143342		SR4056	G57048		SR4119	G57134		SR4172	G57132	
SM5619	143531		SR4057	G57047		SR4120	G57133		SR4173	G57419	
SM5620	143412		SR4058	G57044		SR4121	G57055		SR4174	G57419	
SM5638	143406		SR4059	G57043		SR4122	G57054		SR4175	G57206	
SM5639	143343		SR4060	G56963		SR4123	G57354		SR4176	G57206	
SM5640	143383		SR4061	G56962		SR4124	G57353		SR4177	G57373	
SM5644	143345		SR4064	G56948		SR4125	G57397		SR4178	G57372	
SM5653	143366		SR4065	G56948		SR4126	G57203		SR4179	G57085	
SM5658	143343		SR4066	G56950		SR4127	G57202		SR4180	G57084	
SM5659	142653		SR4067	G56949		SR4128	G57050		SR4181	G57085	
SM5660	143491		SR4068	G57115		SR4129	G57049		SR4182	G57084	
SM5661	143397		SR4069	G57114		SR4129	G57050		SR4183	G57330	
SM5668	143477		SR4070	G56964		SR4130	G57134		SR4184	G57329	
SM5677	143336		SR4071	G57012		SR4131	G57133		SR4185	G57164	
SM5680	143266		SR4072	G57011		SR4132	G57056		SR4186	G57163	
SM5681	143255		SR4073	G57022		SR4133	G57134		SR4187	G57208	
SM5682	143369		SR4074	G56992		SR4134	G57133		SR4188	G57207	
SM5683	143369		SR4075	G56991		SR4135	G57055		SR4189	G57418	
SM5688	143305		SR4076	G56943		SR4136	G57054		SR4190	G57417	
SM5721	143349		SR4077	G57020		SR4137	G57095		SR4191	G57087	
SM5729	143473		SR4078	G57021		SR4138	G57191		SR4192	G57086	
SM5737	143339		SR4079	G57000		SR4139	G57190		SR4193	G57087	
SM5754	143393		SR4079	G57023		SR4140	G57080		SR4194	G57086	
SM5756	143415		SR4079	G57125		SR4141	G57096		SR4195	G57206	
SM5776	143416		SR4081	G57017		SR4142	G57076		SR4196	G57206	
SM5782	143350		SR4082	G57019		SR4143	G57077		SR4199	G57008	
SR1002	49228		SR4085	G57079		SR4144	G57664		SR4200	G57007	
SR4001	G56927		SR4086	G57078		SR4145	G57663		SR4201	G57646	
SR4002	G57060		SR4087	G57072		SR4146	G57106		SR4202	G57647	
SR4009	G56937		SR4088	G57071		SR4147	G57105		SR4203	G57413	
SR4010	G56934		SR4089	G57060		SR4148	G57212		SR4206	G57109	
SR4011	G56936		SR4090	G57051		SR4149	G57015		SR4206	G57314	
SR4016	G56935		SR4092	G56925		SR4150	G57042		SR4207	G57330	
SR4023	G57118		SR4093	G56924		SR4151	G57041		SR4208	G57329	
SR4024	G56951		SR4094	G57070		SR4152	G57350		SR4211	G57324	

Important Note: Competitive Interchanges are to be used for stocking purposes only. Where multiple crosses are identified, please reference the applications section of this catalog./ **Remarque importante:** Les interchanges concurrentiels ne s'utilisent qu'aux fins de stocks. Dans le cas de rfrences multiples, consulter la section des applications du catalogue./ **Nota importante:** Dans le cas de rfrences multiples, consulter la section des applications du catalogue./ **Nota importante:** Se pueden usar intercambios competitivos para propósitos de almacenamiento solamente. Cuando se identifican intercambios múltiples, consulte la sección de aplicaciones de este catálogo.

COMPETITIVE & O.E.M. INTERCHANGE LIST
Lista de Intercambios contra Competidores y Equipo Original.
Liste dinterchange de produits comptitifs & dquipement original (OEM)

KYB... cont'd

Kyb	Gabriel	Upgrade	Kyb	Gabriel	Upgrade	Kyb	Gabriel	Upgrade	Kyb	Gabriel	Upgrade
SR4214	G57201		SR4415	G57731		SR4463	G57133		SR4538	G57714	
SR4215	G57200		SR4415	G57733		SR4464	G57134		SR4545	G57023	
SR4216	G57177		SR4416	G57730		SR4465	G57221		SR4546	G57023	
SR4217	G57176		SR4416	G57732		SR4466	G57220		SR4547	G57000	
SR4218	G57178		SR4417	G57785		SR4469	G57799		SR4548	G57147	
SR4219	G57219		SR4418	G57784		SR4470	G57786		SR4553	G57779	
SR4220	G57218		SR4419	G57725		SR4471	G57786		SR4554	G57778	
SR4222	G57343		SR4420	G57724		SR4472	G57124		SR4555	G57466	
SR4223	G57344		SR4423	G57415		SR4473	G57123		SR4556	G57465	
SR4223	G57405		SR4424	G57404		SR4478	G57544		SR4558	G57456	
SR4224	G57404		SR4424	G57414		SR4479	G57543		SR4559	G57455	
SR4225	G57162		SR4425	G57735		SR4480	G57546		SR4576	G57191	
SR4226	G57161		SR4426	G57734		SR4481	G57545		SR4577	G57190	
SR4227	G57092		SR4427	G57083		SR4482	G57629		SR4580	G57370	
SR4228	G57334		SR4428	G57083		SR4483	G57628		SR4581	G57369	
SR4229	G57333		SR4429	G57083		SR4484	G57706		SR4582	G57429	
SR4230	G57092		SR4430	G57604		SR4485	G57705		SR4583	G57428	
SR4231	G57696		SR4431	G57603		SR4486	G57704		SR4589	G57453	
SR4232	G57695		SR4432	G57598		SR4491	G57340		SR4590	G57454	
SR4233	G57332		SR4432	G57602		SR4492	G57339		SR4591	G57346	
SR4234	G57331		SR4433	G57597		SR4498	G57565		SR4592	G57345	
SR4235	G57082		SR4433	G57601		SR4499	G57564		SR4593	G57423	
SR4236	G57081		SR4434	G57323		SR4500	G57276		SR4594	G57472	
SR4241	G57391		SR4435	G57322		SR4501	G57275		SR4595	G57471	
SR4242	G57390		SR4436	G57474		SR4502	G57149		SR4603	G57223	
SR4243	G57682		SR4437	G57473		SR4504	G57447		SR4604	G57222	
SR4244	G57416		SR4438	G57172		SR4504	G57579		SR4605	G57425	
SR4245	G57739		SR4439	G57677		SR4505	G57755		SR4606	G57424	
SR4246	G57738		SR4440	G57676		SR4505	G57793		SR4607	G57723	
SR4261	G57500		SR4443	G57683		SR4506	G57754		SR4608	G57722	
SR4262	G57499		SR4444	G57185		SR4506	G57792		SR4710	G57849	
SR4267	G57713		SR4445	G57184		SR4513	G57569		SR4711	G57848	
SR4268	G57712		SR4446	G57659		SR4514	G57568		SR7099	G57121	
SR4271	G57148		SR4447	G57658		SR4515	G57173		SR8069	G57114	
SR4272	G57148		SR4448	G57484		SR4516	G57794		SS10202	14072	
SR4275	G57394		SR4449	G57483		SR4517	G57794		SS10309	6854SE	
SR4276	G57393		SR4450	G57482		SR4522	G57138		SS10317	14040	
SR4279	G57282		SR4451	G57481		SR4523	G57137		SS10317	14071	
SR4317	G57378		SR4452	G57563		SR4524	G57138		SS10318	6853SE	
SR4318	G57377		SR4452	G57791		SR4525	G57137		SS10322	6856SE	
SR4388	G57480		SR4453	G57562		SR4526	G57781		SS10323	6847SE	
SR4388	G57600		SR4453	G57790		SR4527	G57780		SS10325	14017	
SR4389	G57479		SR4454	G57484		SR4528	G57134		SS10325	6804SE	
SR4389	G57599		SR4455	G57483		SR4529	G57133		SS11318	14074	
SR4404	G57540		SR4459	G57205		SR4532	G57709		SS15345	6802SE	
SR4405	G57539		SR4460	G57204		SR4535	G57794		SS15489	6855SE	
SR4408	G57567		SR4461	G57205		SR4536	G57794				
SR4409	G57566		SR4462	G57204		SR4537	G57715				

Leacree

Leacree	Gabriel	Upgrade	Leacree	Gabriel	Upgrade	Leacree	Gabriel	Upgrade	Leacree	Gabriel	Upgrade
201721149	G57115		30372189	69909		30372709	G64030		3056079	70003	
201722079	G57079		30372389	G63815		30372749	G64033		3056149	70013	
201722759	G57205		30372439	G63610		30372989	G64038		3056189	70039	
20714269	G56672		30372519	G63878		30373159	G64040				
30323349	G63726		30372529	G63883		30390409	69901				
30323379	G63710		30372709	G63885		30390409	70040				
30372049	G63845		30372709	G64029		30391029	69946				

Important Note: Competitive Interchanges are to be used for stocking purposes only. Where multiple crosses are identified, please reference the applications section of this catalog. / **Remarque importante:** Les interchanges concurrentiels ne s'utilisent qu'aux fins de stocks. Dans le cas de références multiples, consulter la section des applications du catalogue. / **Nota importante:** Dans le cas de referencias multiples, consultar la sección de aplicaciones del catálogo. / **Nota importante:** Se pueden usar intercambios competitivos para propósitos de almacenamiento solamente. Cuando se identifican intercambios múltiples, consulte la sección de aplicaciones de este catálogo.

COMPETITIVE & O.E.M. INTERCHANGE LIST
Lista de Intercambios contra Competidores y Equipo Original.
Liste dinterchange de produits compititifs & dquipement original (OEM)

Leacree... cont'd

Leacree	Gabriel	Upgrade	Leacree	Gabriel	Upgrade	Leacree	Gabriel	Upgrade	Leacree	Gabriel	Upgrade
3056229	70037		501714049	G57089		501721449	G57084		50713719	G51739	
3056379	70089		501714059	G57088		501721749	G56951		50713809	G51286	
3057889	70031		501714069	G57168		501721779	G57141		50713909	G51746	
309112659	G64010		501714079	G57167		501721799L	G57047		50714049	G56540	
309112679	G63888		501714269	G57031		501721799R	G57048		50714059	G56539	
309113319	G64157		501714279	G57030		501721859	G57050		50714069	G56641	
309113329	G64079		501714359	G57140		501721869	G57049		50714079	G56640	
309115069	G63866		501714369	G57139		501721999	G57070		50714189	G56684	
501000259	G57039		501714379	G57098		501721999	G57122		50714199	G56683	
501391049	G57125		501714389	G57097		501722009	G57069		50714279	G56671	
501711119	G57053		501714519	G57120		501722009	G57121		50714319	G55870	
501711199L	G57123		501714529	G57119		501722039	G57099		50714339	G56622	
501711199R	G57124		501714619	G57158		501722039	G57100		50714349	G56621	
501711249	G57095		501714629	G57157		501722059	G57077		50714359	G56561	
501711259	G57096		501714909	G57042		501722069	G57076		50714369	G56562	
501711389	G57172		501714919	G57041		501722089	G57078		50714619	G56686	
501711399	G57173		501714929	G57044		501722099	G57111		50714629	G56685	
501711409	G57132		501714939	G57043		501722109	G57110		50714859	G56802	
501711419	G57103		501715049	G57064		501722319	G57142		50715049	G56517	
501712669L	G56995		501715059	G57063		501722769	G57204		50715059	G56516	
501712669R	G56995		501715729L	G56956		501722929	G57147		50715259	G56606	
501712819	G56938		501715729R	G56957		501723119	G57156		50715729	G56620	
501712919L	G56996		501715779L	G57007		501723679	G57177		50715779	G51728	
501712919R	G56997		501715779R	G57008		501723689	G57176		50715809	G55892	
501712929	G56998		501715789	G56973		501723929	G57162		50716169	G55901	
501712939	G57057		501715799	G56974		501723939	G57161		50716699	G55856	
501712939	G57058		501715809	G56975		501724019	G57178		50716789	G56514	
501712999	G56943		501715929	G56965		50179519	G55999		50716799	G56506	
501713129	G57036		501715939	G57046		50179539	G55662		50716809	G55676	
501713219	G57017		501715949	G57045		502716629L	G56924		50716819	G55675	
501713229	G57018		501715979	G57012		502716629R	G56925		50716859	G56509	
501713279	G57159		501715989	G57011		502716789	G56931		50718229	G56718	
501713279	G57160		501716159	G56934		502716799	G56930		50719529	G55999	
501713409L	G57032		501716159	G56937		502719519	G56948		50719549	G55661	
501713409L	G57061		501716169	G56936		502719529	G56948		50719649	G55697	
501713409R	G57033		501716619	G57060		502722579	G57082		50719739	G55698	
501713409R	G57062		501716679	G56963		502722589	G57081		50721149	G56660	
501713419	G57022		501716689	G56962		503393099	G52258		50721159	G56661	
501713469	G57080		501716699	G56964		503393109	G52257		50721439	G56799	
501713489L	G57027		501716859	G57051		50711039	G51765		50721449	G56800	
501713489R	G57027		501716919L	G56991		50711199	G51855		50721859	G56678	
501713519L	G57065		501716919R	G56992		50712819	G55825		50721869	G56677	
501713519R	G57066		501719249	G57013		50712919	G55909		50722059	G56722	
501713529L	G57065		501719259	G57014		50712929	G55910		50722069	G56721	
501713529R	G57066		501719459	G56994		50712939	G51087		50722079	G56729	
501713589	G57092		501719469	G56993		50713219	G51722		50722089	G56728	
501713619	G57020		501719539	G56950		50713229	G51724		50722199	G56820	
501713629	G57021		501719549	G56949		50713279	G51727		50722209	G56819	
501713719L	G57133		501719579	G56933		50713409	G51700		50722219	G56821	
501713719R	G57134		501719589	G56932		50713419	G51718		50722229	G56822	
501713729	G57056		501721059	G57035		50713489	G51477		50722639	G52006	
501713779L	G57083		501721069	G57034		50713519	G51077		50722649	G52005	
501713779R	G57083		501721159	G57114		50713529	G51077		50722999	G52159	
501713809L	G57086		501721309L	G57112		50713589	G51715		50723009	G52158	
501713809R	G57087		501721309R	G57113		50713629	G51703		50723059	G52157	
501713989	G57019		501721439	G57085		50713629	G51704		50723069	G52156	

Important Note: Competitive Interchanges are to be used for stocking purposes only. Where multiple crosses are identified, please reference the applications section of this catalog./ **Remarque importante:** Les interchanges concurrentiels ne s'utilisent qu'aux fins de stocks. Dans le cas de rferences multiples, consulter la section des applications du catalogue./ **Nota importante:** Dans le cas de rferences multiples, consulter la section des applications du catalogue./ **Nota importante:** Se pueden usar intercambios competitivos para propósitos de almacenamiento solamente. Cuando se identifican intercambios múltiples, consulte la sección de aplicaciones de este catálogo.

COMPETITIVE & O.E.M. INTERCHANGE LIST

Lista de Intercambios contra Competidores y Equipo Original.

Liste d'interchange de produits compétitifs & d'équipement original (OEM)

Leacree... cont'd

Leacree	Gabriel	Upgrade	Leacree	Gabriel	Upgrade	Leacree	Gabriel	Upgrade	Leacree	Gabriel	Upgrade
50723079	G56889		50723289	G52175		50725189	G52125				
50723089	G56888		50723929	G52122		50725269	G52128				
50723279	G52176		50723939	G52121		50725279	G52127				

Les Schwab

Les schwab	Gabriel	Upgrade	Les schwab	Gabriel	Upgrade	Les schwab	Gabriel	Upgrade	Les schwab	Gabriel	Upgrade
14004	14004		142755	142755		143316	143316		143408	143408	
14005	14005		142828	142828		143317	143317		143409	143409	
14017	14017		142836	142836		143318	143318		143410	143410	
14018	14018		142840	142840		143319	143319		143412	143412	
14039	14039		142842	142842		143320	143320		143413	143413	
14040	14040		142843	142843		143321	143321		143414	143414	
14071	14071		142850	142850		143323	143323		143415	143415	
14072	14072		142852	142852		143324	143324		143416	143416	
14074	14074		142855	142855		143325	143325		143418	143418	
142091	142091		142930	142930		143335	143335		143419	143419	
142135	142135		142932	142932		143336	143336		143422	143422	
142173	142173		142933	142933		143339	143339		143423	143423	
142195	142195		142937	142937		143340	143340		143425	143425	
142230	142230		142938	142938		143341	143341		143455	143455	
142244	142244		142949	142949		143342	143342		143458	143458	
142245	142245		143030	143030		143343	143343		143459	143459	
142247	142247		143057	143057		143344	143344		143460	143460	
142249	142249		143058	143058		143345	143345		143461	143461	
142250	142250		143059	143059		143346	143346		143462	143462	
142251	142251		143061	143061		143349	143349		143464	143464	
142252	142252		143063	143063		143350	143350		143465	143465	
142316	142316		143064	143064		143353	143353		143466	143466	
142317	142317		143071	143071		143354	143354		143468	143468	
142329	142329		143072	143072		143355	143355		143473	143473	
142402	142402		143073	143073		143357	143357		143474	143474	
142403	142403		143074	143074		143359	143359		143476	143476	
142404	142404		143082	143082		143360	143360		143477	143477	
142419	142419		143087	143087		143361	143361		143486	143486	
142439	142439		143088	143088		143362	143362		143491	143491	
142444	142444		143089	143089		143363	143363		143492	143492	
142524	142524		143094	143094		143364	143364		143495	143495	
142526	142526		143191	143191		143365	143365		143496	143496	
142530	142530		143194	143194		143366	143366		143498	143498	
142546	142546		143197	143197		143367	143367		143530	143530	
142547	142547		143201	143201		143369	143369		143531	143531	
142556	142556		143202	143202		143380	143380		143564	143564	
142561	142561		143204	143204		143383	143383		34036	34036	
142567	142567		143209	143209		143385	143385		34051	34051	
142569	142569		143218	143218		143387	143387		34052	34052	
142573	142573		143227	143227		143388	143388		34057	34057	
142625	142625		143239	143239		143390	143390		34058	34058	
142643	142643		143241	143241		143391	143391		34073	34073	
142649	142649		143244	143244		143393	143393		34076	34076	
142650	142650		143255	143255		143394	143394		43048	43048	
142651	142651		143256	143256		143396	143396		43049	43049	
142653	142653		143259	143259		143397	143397		43058	43058	
142735	142735		143263	143263		143398	143398		43060	43060	
142745	142745		143266	143266		143399	143399		43085	43085	
142746	142746		143277	143277		143401	143401				
142747	142747		143281	143281		143404	143404				
142751	142751		143305	143305		143405	143405				
142752	142752		143315	143315		143406	143406				

Important Note: Competitive Interchanges are to be used for stocking purposes only. Where multiple crosses are identified, please reference the applications section of this catalog. / **Remarque importante:** Les interchanges concurrentiels ne s'utilisent qu'aux fins de stocks. Dans le cas de références multiples, consulter la section des applications du catalogue. / **Nota importante:** Dans le cas de références multiples, consulter la section des applications du catalogue. / **Nota importante:** Se pueden usar intercambios competitivos para propósitos de almacenamiento solamente. Cuando se identifican intercambios múltiples, consulte la sección de aplicaciones de este catálogo.

COMPETITIVE & O.E.M. INTERCHANGE LIST
Lista de Intercambios contra Competidores y Equipo Original.
Liste dinterchange de produits comptitifs & dquipement original (OEM)

Les Schwab... cont'd

Les schwab	Gabriel	Upgrade	Les schwab	Gabriel	Upgrade	Les schwab	Gabriel	Upgrade	Les schwab	Gabriel	Upgrade
43099	43099		58403	58403		61595	61595		6828SE	6828SE	
43111	43111		58412	58412		61599	61599		6847SE	6847SE	
43140	43140		58421	58421		61605	61605		6850SE	6850SE	
43162	43162		58422	58422		61608	61608		6853SE	6853SE	
43163	43163		58423	58423		61609	61609		6854SE	6854SE	
43167	43167		58488	58488		61612	61612		6855SE	6855SE	
43171	43171		58489	58489		61614	61614		6856SE	6856SE	
43180	43180		58609	58609		61625	61625		6861SE	6861SE	
43181	43181		58622	58622		61632	61632		69420	69420	
49105	49105		58623	58623		61634	61634		69450	69450	
49106	49106		58638	58638		61635	61635		69464	69464	
49107	49107		58662	58662		61642	61642		69465	69465	
49110	49110		58714	58714		61643	61643		69473	69473	
49122	49122		58803	58803		61646	61646		69574	69574	
49127	49127		58807	58807		61651	61651		69575	69575	
49128	49128		58808	58808		61654	61654		69585	69585	
49131	49131		58809	58809		61655	61655		69586	69586	
49135	49135		58810	58810		61656	61656		69587	69587	
49149	49149		58817	58817		61659	61659		69589	69589	
49152	49152		58901	58901		61662	61662		69590	69590	
49155	49155		58929	58929		61663	61663		69591	69591	
49157	49157		58930	58930		61664	61664		69592	69592	
49162	49162		58944	58944		61675	61675		69593	69593	
49173	49173		61510	61510		61676	61676		69594	69594	
49178	49178		61512	61512		61679	61679		69595	69595	
49199	49199		61516	61516		61680	61680		69600	69600	
49203	49203		61517	61517		61682	61682		69604	69604	
49205	49205		61518	61518		61683	61683		69606	69606	
49212	49212		61519	61519		61684	61684		69622	69622	
49213	49213		61521	61521		61685	61685		69624	69624	
49215	49215		61523	61523		61687	61687		69625	69625	
49218	49218		61524	61524		61690	61690		69632	69632	
49221	49221		61525	61525		61691	61691		69675	69675	
49223	49223		61529	61529		61692	61692		69676	69676	
49226	49226		61530	61530		61696	61696		69677	69677	
49228	49228		61533	61533		61697	61697		69714	69714	
49230	49230		61539	61539		61699	61699		69715	69715	
49231	49231		61541	61541		61700	61700		69724	69724	
49232	49232		61543	61543		61703	61703		69725	69725	
49233	49233		61544	61544		61704	61704		69755	69755	
49234	49234		61546	61546		61710	61710		69757	69757	
49235	49235		61547	61547		61711	61711		69766	69766	
49236	49236		61550	61550		61712	61712		69787	69787	
49237	49237		61554	61554		61713	61713		69795	69795	
49254	49254		61555	61555		61714	61714		69811	69811	
49255	49255		61556	61556		61715	61715		69813	69813	
49304	49304		61560	61560		61716	61716		69845	69845	
49307	49307		61561	61561		61717	61717		69863	69863	
49310	49310		61573	61573		61718	61718		69898	69898	
49311	49311		61575	61575		61720	61720		69900	69900	
49334	49334		61582	61582		61734	61734		69901	69901	
49369	49369		61584	61584		61777	61777		69903	69903	
49387	49387		61590	61590		6801SE	6801SE		69907	69907	
49388	49388		61591	61591		6802SE	6802SE		69909	69909	
58357	58357		61592	61592		6803SE	6803SE		69945	69945	
58359	58359		61593	61593		6804SE	6804SE		69946	69946	

Important Note: Competitive Interchanges are to be used for stocking purposes only. Where multiple crosses are identified, please reference the applications section of this catalog./ **Remarque importante:** Les interchanges concurrentiels ne s'utilisent qu'aux fins de stocks. Dans le cas de rfrences multiples, consulter la section des applications du catalogue./ **Nota importante:** Dans le cas de rfrences multiples, consulter la section des applications du catalogue./ **Nota importante:** Se pueden usar intercambios competitivos para propósitos de almacenamiento solamente. Cuando se identifican intercambios múltiples, consulte la sección de aplicaciones de este catálogo.

COMPETITIVE & O.E.M. INTERCHANGE LIST
Lista de Intercambios contra Competidores y Equipo Original.
Liste dinterchange de produits comptitifs & dquipement original (OEM)

Les Schwab... cont'd

Les schwab	Gabriel	Upgrade	Les schwab	Gabriel	Upgrade	Les schwab	Gabriel	Upgrade	Les schwab	Gabriel	Upgrade
69952	69952		71504	61504		77678	77678		81270	81270	
69962	69962		71506	61506		77679	77679		81318	81318	
69966	69966		71508	61508		77683	77683		81340	81340	
69996	69996		71509	61509		77714	77714		81342	81342	
69998	69998		71520	61520		77715	77715		81394	81394	
70000	70000		71522	61522		77716	77716		81416	81416	
70001	70001		71528	61528		77717	77717		81440	81440	
70003	70003		71531	61531		77726	77726		81446	81446	
70010	70010		71535	61535		77772	77772		81459	81459	
70013	70013		71536	61536		77783	77783		81469	81469	
70020	70020		71542	61542		77803	77803		81478	81478	
70024	70024		71552	61552		77807	77807		81481	81481	
70027	70027		71565	61565		77808	77808		81482	81482	
70028	70028		71600	61600		77809	77809		81484	81484	
70031	70031		71601	61601		77810	77810		81490	81490	
70033	70033		71606	61606		77815	77815		81491	81491	
70034	70034		71611	61611		77817	77817		81492	81492	
70034	85302	89420	71613	61613		77829	77829		81494	81494	
70034	89420		71615	61615		77837	77837		81495	81495	
70036	70036		71616	61616		77847	77847		81496	81496	
70037	70037		71623	61623		77905	77905		81507	81507	
70038	70038		71624	61624		77907	77907		81510	81510	
70039	70039		71626	61626		77909	77909		81514	81514	
70039	85303	89422	71627	61627		77915	77915		81516	81516	
70039	89422		71629	61629		77947	77947		81540	81540	
70040	70040		71638	61638		77948	77948		81541	81541	
70041	70041		71641	61641		77949	77949		81548	81548	
70041	85305		71658	61658		77950	77950		81549	81549	
70045	70045		75676	75676		77951	77951		81553	81553	
70049	70049		77375	77375		77952	77952		81559	81559	
70052	70052		77403	77403		77953	77953		81560	81560	
70053	70053		77412	77412		77954	77954		81582	81582	
70055	70055		77414	77414		77967	77967		81583	81583	
70056	70056		77422	77422		77968	77968		81667	81667	
70059	70059		77423	77423		77969	77969		81668	81668	
70060	70060		77425	77425		77971	77971		81675	81675	
70064	70064		77454	77454		77973	77973		81676	81676	
70065	70065		77455	77455		77975	77975		81691	81691	
70068	70068		77461	77461		77976	77976		81710	81710	
70078	70078		77479	77479		77978	77978		81713	81713	
70086	70086		77488	77488		77980	77980		81726	81726	
70089	70089		77489	77489		77981	77981		81730	81730	
70095	70095		77494	77494		77983	77983		81744	81744	
70096	70096		77524	77524		77988	77988		81750	81750	
70098	70098		77525	77525		79900	79900		81794	81794	
70102	70102		77607	77607		81039	81039		81821	81821	
70203	70203		77608	77608		81076	81076		81823	81823	
70204	70204		77609	77609		81082	81082		81825	81825	
70207	70207		77614	77614		81091	81091		81828	81828	
70208	70208		77623	77623		81095	81095		81833	81833	
70209	70209		77638	77638		81096	81096		81834	81834	
70210	70210		77661	77661		81113	81113		81836	81836	
70213	70213		77662	77662		81147	81147		81837	81837	
70231	70231		77673	77673		81153	81153		81869	81869	
71500	61500		77674	77674		81164	81164		81870	81870	
71501	61501		77675	77675		81242	81242		81871	81871	

Important Note: Competitive Interchanges are to be used for stocking purposes only. Where multiple crosses are identified, please reference the applications section of this catalog. / **Remarque importante:** Les interchanges concurrentiels ne s'utilisent qu'aux fins de stocks. Dans le cas de références multiples, consulter la section des applications du catalogue. / **Nota importante:** Dans le cas de références multiples, consulter la section des applications du catalogue. / **Nota importante:** Se pueden usar intercambios competitivos para propósitos de almacenamiento solamente. Cuando se identifican intercambios múltiples, consulte la sección de aplicaciones de este catálogo.

COMPETITIVE & O.E.M. INTERCHANGE LIST
Lista de Intercambios contra Competidores y Equipo Original.
Liste dinterchange de produits comptitifs & dquipement original (OEM)

Les Schwab... cont'd

Les schwab	Gabriel	Upgrade	Les schwab	Gabriel	Upgrade	Les schwab	Gabriel	Upgrade	Les schwab	Gabriel	Upgrade
81872	81872		82066	82066		G511123	G511123		G51807	G51807	
81873	81873		82069	82069		G511134	G511134		G51810	G51810	
81878	81878		82070	82070		G511135	G511135		G51811	G51811	
81880	81880		82072	82072		G511142	G511142		G51812	G51812	
81890	81890		82075	82075		G51252	G51252		G51813	G51813	
81891	81891		82076	82076		G51254	G51254		G51814	G51814	
81892	81892		82079	82079		G51255	G51255		G51815	G51815	
81893	81893		82086	82086		G51256	G51256		G51825	G51825	
81904	81904		82087	82087		G51267	G51267		G51832	G51832	
81905	81905		82090	82090		G51268	G51268		G51833	G51833	
81910	81910		82099	82099		G51279	G51279		G51836	G51836	
81911	81911		82103	82103		G51286	G51286		G51838	G51838	
81912	81912		82104	82104		G51477	G51477		G51841	G51841	
81913	81913		82109	82109		G51700	G51700		G51842	G51842	
81914	81914		82110	82110		G51703	G51703		G51847	G51847	
81916	81916		82118	82118		G51704	G51704		G51848	G51848	
81917	81917		82125	82125		G51713	G51713		G51849	G51849	
81918	81918		82126	82126		G51714	G51714		G51850	G51850	
81919	81919		82128	82128		G51715	G51715		G51852	G51852	
81920	81920		82130	82130		G51716	G51716		G51853	G51853	
81921	81921		82131	82131		G51718	G51718		G51854	G51854	
81922	81922		82138	82138		G51719	G51719		G51855	G51855	
81923	81923		82147	82147		G51721	G51721		G51856	G51856	
81924	81924		82151	82151		G51722	G51722		G51858	G51858	
81925	81925		82155	82155		G51723	G51723		G51859	G51859	
81926	81926		82156	82156		G51724	G51724		G51860	G51860	
81927	81927		82601	82601		G51727	G51727		G51861	G51861	
81928	81928		82602	82602		G51728	G51728		G51863	G51863	
81929	81929		82609	82609		G51729	G51729		G51864	G51864	
81930	81930		82615	82615		G51736	G51736		G51865	G51865	
81931	81931		82618	82618		G51737	G51737		G51870	G51870	
81932	81932		G44461	G44461		G51738	G51738		G51871	G51871	
81933	81933		G44748	G44748		G51739	G51739		G51874	G51874	
81934	81934		G44986	G44986		G51740	G51740		G51877	G51877	
81935	81935		G51063	G51063		G51742	G51742		G51878	G51878	
81936	81936		G51077	G51077		G51746	G51746		G51879	G51879	
81937	81937		G51087	G51087		G51758	G51758		G51880	G51880	
82001	82001		G51097	G51097		G51759	G51759		G51881	G51881	
82003	82003		G511000	G511000		G51760	G51760		G51883	G51883	
82004	82004		G511001	G511001		G51761	G51761		G51884	G51884	
82005	82005		G511002	G511002		G51765	G51765		G51887	G51887	
82007	82007		G511003	G511003		G51766	G51766		G51888	G51888	
82010	82010		G511004	G511004		G51767	G51767		G51891	G51891	
82011	82011		G511007	G511007		G51772	G51772		G51892	G51892	
82012	82012		G511019	G511019		G51773	G51773		G51896	G51896	
82025	82025		G511020	G511020		G51774	G51774		G51897	G51897	
82026	82026		G511030	G511030		G51783	G51783		G51898	G51898	
82032	82032		G511037	G511037		G51794	G51794		G51899	G51899	
82034	82034		G511038	G511038		G51795	G51795		G51900	G51900	
82035	82035		G511043	G511043		G51798	G51798		G51901	G51901	
82039	82039		G511044	G511044		G51799	G51799		G51904	G51904	
82040	82040		G511054	G511054		G51802	G51802		G51905	G51905	
82047	82047		G511055	G511055		G51803	G51803		G51908	G51908	
82051	82051		G511078	G511078		G51804	G51804		G51910	G51910	
82060	82060		G511092	G511092		G51805	G51805		G51911	G51911	
82065	82065		G511122	G511122		G51806	G51806		G51914	G51914	

Important Note: Competitive Interchanges are to be used for stocking purposes only. Where multiple crosses are identified, please reference the applications section of this catalog./ **Remarque importante:** Les interchanges concurrentiels ne s'utilisent qu'aux fins de stocks. **Dans le cas de rfrences multiples, consulter la section des applications du catalogue./** **Nota importante:** Dans le cas de rfrences multiples, consulter la section des applications du catalogue./ **Nota importante:** Se pueden usar intercambios competitivos para propósitos de almacenamiento solamente. Cuando se identifican intercambios múltiples, consulte la sección de aplicaciones de este catálogo.

COMPETITIVE & O.E.M. INTERCHANGE LIST
Lista de Intercambios contra Competidores y Equipo Original.
Liste dinterchange de produits comptitifs & dquipement original (OEM)

Les Schwab... cont'd

Les schwab	Gabriel	Upgrade	Les schwab	Gabriel	Upgrade	Les schwab	Gabriel	Upgrade	Les schwab	Gabriel	Upgrade
G51916	G51916		G52082	G52082		G52173	G52173		G52314	G52314	
G51917	G51917		G52094	G52094		G52174	G52174		G52329	G52329	
G51918	G51918		G52095	G52095		G52175	G52175		G52330	G52330	
G51919	G51919		G52096	G52096		G52176	G52176		G52331	G52331	
G51920	G51920		G52097	G52097		G52182	G52182		G52332	G52332	
G51921	G51921		G52098	G52098		G52183	G52183		G52333	G52333	
G51922	G51922		G52103	G52103		G52184	G52184		G52334	G52334	
G51925	G51925		G52104	G52104		G52185	G52185		G52335	G52335	
G51926	G51926		G52105	G52105		G52187	G52187		G52336	G52336	
G51928	G51928		G52106	G52106		G52188	G52188		G52348	G52348	
G51930	G51930		G52107	G52107		G52199	G52199		G52349	G52349	
G51933	G51933		G52108	G52108		G52200	G52200		G52351	G52351	
G51934	G51934		G52110	G52110		G52201	G52201		G52352	G52352	
G51935	G51935		G52111	G52111		G52202	G52202		G52353	G52353	
G51937	G51937		G52112	G52112		G52203	G52203		G52354	G52354	
G51947	G51947		G52113	G52113		G52204	G52204		G52355	G52355	
G51948	G51948		G52116	G52116		G52209	G52209		G52356	G52356	
G51949	G51949		G52117	G52117		G52210	G52210		G52360	G52360	
G51955	G51955		G52118	G52118		G52237	G52237		G52361	G52361	
G51961	G51961		G52121	G52121		G52238	G52238		G52367	G52367	
G51965	G51965		G52122	G52122		G52244	G52244		G52368	G52368	
G51966	G51966		G52125	G52125		G52245	G52245		G52374	G52374	
G51969	G51969		G52127	G52127		G52246	G52246		G52375	G52375	
G51971	G51971		G52128	G52128		G52247	G52247		G52382	G52382	
G51972	G51972		G52129	G52129		G52248	G52248		G52383	G52383	
G51975	G51975		G52130	G52130		G52249	G52249		G52395	G52395	
G51979	G51979		G52131	G52131		G52250	G52250		G52396	G52396	
G51980	G51980		G52140	G52140		G52253	G52253		G52398	G52398	
G51981	G51981		G52141	G52141		G52254	G52254		G52399	G52399	
G51982	G51982		G52142	G52142		G52255	G52255		G52406	G52406	
G51983	G51983		G52143	G52143		G52256	G52256		G52410	G52410	
G51990	G51990		G52144	G52144		G52257	G52257		G52411	G52411	
G51992	G51992		G52145	G52145		G52258	G52258		G52435	G52435	
G51993	G51993		G52148	G52148		G52260	G52260		G52436	G52436	
G51994	G51994		G52149	G52149		G52261	G52261		G52437	G52437	
G51995	G51995		G52150	G52150		G52264	G52264		G52438	G52438	
G51996	G51996		G52151	G52151		G52265	G52265		G52439	G52439	
G52004	G52004		G52152	G52152		G52272	G52272		G52440	G52440	
G52005	G52005		G52153	G52153		G52273	G52273		G52449	G52449	
G52006	G52006		G52154	G52154		G52274	G52274		G52450	G52450	
G52007	G52007		G52155	G52155		G52275	G52275		G52494	G52494	
G52008	G52008		G52156	G52156		G52276	G52276		G52495	G52495	
G52009	G52009		G52157	G52157		G52278	G52278		G52524	G52524	
G52013	G52013		G52158	G52158		G52279	G52279		G52525	G52525	
G52014	G52014		G52159	G52159		G52280	G52280		G52906	G52906	
G52017	G52017		G52160	G52160		G52281	G52281		G52907	G52907	
G52018	G52018		G52161	G52161		G52282	G52282		G55526	G55526	
G52019	G52019		G52162	G52162		G52283	G52283		G55551	G55551	
G52025	G52025		G52163	G52163		G52293	G52293		G55579	G55579	
G52026	G52026		G52164	G52164		G52294	G52294		G55591	G55591	
G52027	G52027		G52165	G52165		G52295	G52295		G55661	G55661	
G52032	G52032		G52168	G52168		G52297	G52297		G55662	G55662	
G52033	G52033		G52169	G52169		G52298	G52298		G55675	G55675	
G52036	G52036		G52170	G52170		G52299	G52299		G55676	G55676	
G52037	G52037		G52171	G52171		G52300	G52300		G55681	G55681	
G52081	G52081		G52172	G52172		G52301	G52301		G55697	G55697	

Important Note: Competitive Interchanges are to be used for stocking purposes only. Where multiple crosses are identified, please reference the applications section of this catalog. / **Remarque importante:** Les interchanges concurrentiels ne s'utilisent qu'aux fins de stocks. Dans le cas de références multiples, consulter la section des applications du catalogue. / **Nota importante:** Se pueden usar intercambios competitivos para propósitos de almacenamiento solamente. Cuando se identifican intercambios múltiples, consulte la sección de aplicaciones de este catálogo.

COMPETITIVE & O.E.M. INTERCHANGE LIST
Lista de Intercambios contra Competidores y Equipo Original.
Liste dinterchange de produits comptitifs & dquipement original (OEM)

Les Schwab... cont'd

Les schwab	Gabriel	Upgrade	Les schwab	Gabriel	Upgrade	Les schwab	Gabriel	Upgrade	Les schwab	Gabriel	Upgrade
G55698	G55698		G56636	G56636		G56820	G56820		G57005	G57005	
G55772	G55772		G56637	G56637		G56821	G56821		G57006	G57006	
G55774	G55774		G56640	G56640		G56822	G56822		G57007	G57007	
G55804	G55804		G56641	G56641		G56836	G56836		G57008	G57008	
G55820	G55820		G56642	G56642		G56837	G56837		G57010	G57010	
G55821	G55821		G56643	G56643		G56838	G56838		G57011	G57011	
G55825	G55825		G56655	G56655		G56839	G56839		G57012	G57012	
G55856	G55856		G56660	G56660		G56840	G56840		G57013	G57013	
G55870	G55870		G56661	G56661		G56841	G56841		G57014	G57014	
G55879	G55879		G56671	G56671		G56842	G56842		G57015	G57015	
G55892	G55892		G56672	G56672		G56843	G56843		G57016	G57016	
G55896	G55896		G56677	G56677		G56886	G56886		G57017	G57017	
G55901	G55901		G56678	G56678		G56887	G56887		G57018	G57018	
G55909	G55909		G56679	G56679		G56888	G56888		G57019	G57019	
G55910	G55910		G56680	G56680		G56889	G56889		G57020	G57020	
G55911	G55911		G56683	G56683		G56892	G56892		G57021	G57021	
G55948	G55948		G56684	G56684		G56893	G56893		G57022	G57022	
G55949	G55949		G56685	G56685		G56894	G56894		G57023	G57023	
G55991	G55991		G56686	G56686		G56899	G56899		G57026	G57026	
G55993	G55993		G56687	G56687		G56924	G56924		G57027	G57027	
G55994	G55994		G56688	G56688		G56925	G56925		G57030	G57030	
G55999	G55999		G56700	G56700		G56927	G56927		G57031	G57031	
G56506	G56506		G56701	G56701		G56928	G56928		G57032	G57032	
G56509	G56509		G56718	G56718		G56929	G56929		G57033	G57033	
G56512	G56512		G56721	G56721		G56930	G56930		G57034	G57034	
G56513	G56513		G56722	G56722		G56931	G56931		G57035	G57035	
G56514	G56514		G56726	G56726		G56932	G56932		G57036	G57036	
G56516	G56516		G56728	G56728		G56933	G56933		G57037	G57037	
G56517	G56517		G56729	G56729		G56934	G56934		G57038	G57038	
G56518	G56518		G56730	G56730		G56935	G56935		G57039	G57039	
G56529	G56529		G56731	G56731		G56936	G56936		G57040	G57040	
G56530	G56530		G56732	G56732		G56937	G56937		G57041	G57041	
G56537	G56537		G56733	G56733		G56938	G56938		G57042	G57042	
G56538	G56538		G56734	G56734		G56943	G56943		G57043	G57043	
G56539	G56539		G56735	G56735		G56948	G56948		G57044	G57044	
G56540	G56540		G56750	G56750		G56949	G56949		G57045	G57045	
G56561	G56561		G56751	G56751		G56950	G56950		G57046	G57046	
G56562	G56562		G56758	G56758		G56951	G56951		G57047	G57047	
G56565	G56565		G56759	G56759		G56956	G56956		G57048	G57048	
G56568	G56568		G56773	G56773		G56957	G56957		G57049	G57049	
G56571	G56571		G56774	G56774		G56962	G56962		G57050	G57050	
G56581	G56581		G56778	G56778		G56963	G56963		G57051	G57051	
G56582	G56582		G56784	G56784		G56964	G56964		G57053	G57053	
G56591	G56591		G56785	G56785		G56965	G56965		G57054	G57054	
G56597	G56597		G56791	G56791		G56973	G56973		G57055	G57055	
G56598	G56598		G56792	G56792		G56974	G56974		G57056	G57056	
G56601	G56601		G56797	G56797		G56975	G56975		G57057	G57057	
G56606	G56606		G56798	G56798		G56991	G56991		G57058	G57058	
G56615	G56615		G56799	G56799		G56992	G56992		G57059	G57059	
G56616	G56616		G56800	G56800		G56993	G56993		G57060	G57060	
G56620	G56620		G56802	G56802		G56994	G56994		G57061	G57061	
G56621	G56621		G56807	G56807		G56995	G56995		G57062	G57062	
G56622	G56622		G56809	G56809		G56996	G56996		G57063	G57063	
G56633	G56633		G56810	G56810		G56997	G56997		G57064	G57064	
G56634	G56634		G56817	G56817		G56998	G56998		G57065	G57065	
G56635	G56635		G56819	G56819		G57000	G57000		G57066	G57066	

Important Note: Competitive Interchanges are to be used for stocking purposes only. Where multiple crosses are identified, please reference the applications section of this catalog./ **Remarque importante:** Les interchanges concurrentiels ne s'utilisent qu'aux fins de stocks. **Dans le cas de rfrences multiples, consulter la section des applications du catalogue./** **Nota importante:** Dans le cas de rfrences multiples, consulter la section des applications du catalogue./ **Nota importante:** Se pueden usar intercambios competitivos para propósitos de almacenamiento solamente. Cuando se identifican intercambios múltiples, consulte la sección de aplicaciones de este catálogo.

COMPETITIVE & O.E.M. INTERCHANGE LIST
Lista de Intercambios contra Competidores y Equipo Original.
Liste dinterchange de produits comptitifs & dquipement original (OEM)

Les Schwab... cont'd

Les schwab	Gabriel	Upgrade	Les schwab	Gabriel	Upgrade	Les schwab	Gabriel	Upgrade	Les schwab	Gabriel	Upgrade
G57067	G57067		G57132	G57132		G57212	G57212		G57365	G57365	
G57068	G57068		G57133	G57133		G57218	G57218		G57366	G57366	
G57069	G57069		G57134	G57134		G57219	G57219		G57367	G57367	
G57070	G57070		G57135	G57135		G57220	G57220		G57368	G57368	
G57071	G57071		G57136	G57136		G57221	G57221		G57369	G57369	
G57072	G57072		G57137	G57137		G57222	G57222		G57370	G57370	
G57075	G57075		G57138	G57138		G57223	G57223		G57372	G57372	
G57076	G57076		G57139	G57139		G57266	G57266		G57373	G57373	
G57077	G57077		G57140	G57140		G57267	G57267		G57375	G57375	
G57078	G57078		G57141	G57141		G57268	G57268		G57376	G57376	
G57079	G57079		G57142	G57142		G57269	G57269		G57377	G57377	
G57080	G57080		G57144	G57144		G57270	G57270		G57378	G57378	
G57081	G57081		G57145	G57145		G57271	G57271		G57390	G57390	
G57082	G57082		G57146	G57146		G57274	G57274		G57391	G57391	
G57083	G57083		G57147	G57147		G57275	G57275		G57392	G57392	
G57084	G57084		G57148	G57148		G57276	G57276		G57393	G57393	
G57085	G57085		G57149	G57149		G57277	G57277		G57394	G57394	
G57086	G57086		G57150	G57150		G57278	G57278		G57397	G57397	
G57087	G57087		G57151	G57151		G57279	G57279		G57398	G57398	
G57088	G57088		G57152	G57152		G57282	G57282		G57399	G57399	
G57089	G57089		G57153	G57153		G57311	G57311		G57400	G57400	
G57090	G57090		G57156	G57156		G57312	G57312		G57401	G57401	
G57091	G57091		G57157	G57157		G57314	G57314		G57404	G57404	
G57092	G57092		G57158	G57158		G57322	G57322		G57405	G57405	
G57095	G57095		G57159	G57159		G57323	G57323		G57409	G57409	
G57096	G57096		G57160	G57160		G57324	G57324		G57413	G57413	
G57097	G57097		G57161	G57161		G57329	G57329		G57414	G57414	
G57098	G57098		G57162	G57162		G57330	G57330		G57415	G57415	
G57099	G57099		G57163	G57163		G57331	G57331		G57416	G57416	
G57100	G57100		G57164	G57164		G57332	G57332		G57417	G57417	
G57103	G57103		G57167	G57167		G57333	G57333		G57418	G57418	
G57105	G57105		G57168	G57168		G57334	G57334		G57419	G57419	
G57106	G57106		G57172	G57172		G57335	G57335		G57420	G57420	
G57107	G57107		G57173	G57173		G57336	G57336		G57421	G57421	
G57108	G57108		G57176	G57176		G57337	G57337		G57422	G57422	
G57109	G57109		G57177	G57177		G57338	G57338		G57423	G57423	
G57110	G57110		G57178	G57178		G57339	G57339		G57424	G57424	
G57111	G57111		G57184	G57184		G57340	G57340		G57425	G57425	
G57112	G57112		G57185	G57185		G57341	G57341		G57427	G57427	
G57113	G57113		G57190	G57190		G57342	G57342		G57428	G57428	
G57114	G57114		G57191	G57191		G57343	G57343		G57429	G57429	
G57115	G57115		G57192	G57192		G57344	G57344		G57430	G57430	
G57118	G57118		G57193	G57193		G57345	G57345		G57431	G57431	
G57119	G57119		G57194	G57194		G57346	G57346		G57432	G57432	
G57120	G57120		G57195	G57195		G57349	G57349		G57437	G57437	
G57121	G57121		G57197	G57197		G57350	G57350		G57441	G57441	
G57122	G57122		G57198	G57198		G57353	G57353		G57442	G57442	
G57123	G57123		G57200	G57200		G57354	G57354		G57444	G57444	
G57124	G57124		G57201	G57201		G57357	G57357		G57447	G57447	
G57125	G57125		G57202	G57202		G57358	G57358		G57449	G57449	
G57126	G57126		G57203	G57203		G57359	G57359		G57450	G57450	
G57127	G57127		G57204	G57204		G57360	G57360		G57451	G57451	
G57128	G57128		G57205	G57205		G57361	G57361		G57452	G57452	
G57129	G57129		G57206	G57206		G57362	G57362		G57453	G57453	
G57130	G57130		G57207	G57207		G57363	G57363		G57454	G57454	
G57131	G57131		G57208	G57208		G57364	G57364		G57455	G57455	

Important Note: Competitive Interchanges are to be used for stocking purposes only. Where multiple crosses are identified, please reference the applications section of this catalog. / **Remarque importante:** Les interchanges concurrentiels ne s'utilisent qu'aux fins de stocks. Dans le cas de références multiples, consulter la section des applications du catalogue. / **Nota importante:** Dans le cas de références multiples, consulter la section des applications du catalogue. / **Nota importante:** Se pueden usar intercambios competitivos para propósitos de almacenamiento solamente. Cuando se identifican intercambios múltiples, consulte la sección de aplicaciones de este catálogo.

COMPETITIVE & O.E.M. INTERCHANGE LIST
Lista de Intercambios contra Competidores y Equipo Original.
Liste dinterchange de produits comptitifs & dquipement original (OEM)

Les Schwab... cont'd

Les schwab	Gabriel	Upgrade	Les schwab	Gabriel	Upgrade	Les schwab	Gabriel	Upgrade	Les schwab	Gabriel	Upgrade
G57456	G57456		G57550	G57550		G57647	G57647		G57732	G57732	
G57457	G57457		G57557	G57557		G57648	G57648		G57733	G57733	
G57458	G57458		G57558	G57558		G57649	G57649		G57734	G57734	
G57459	G57459		G57559	G57559		G57650	G57650		G57735	G57735	
G57460	G57460		G57560	G57560		G57651	G57651		G57738	G57738	
G57463	G57463		G57561	G57561		G57658	G57658		G57739	G57739	
G57464	G57464		G57562	G57562		G57659	G57659		G57740	G57740	
G57465	G57465		G57563	G57563		G57663	G57663		G57741	G57741	
G57466	G57466		G57564	G57564		G57664	G57664		G57742	G57742	
G57471	G57471		G57565	G57565		G57665	G57665		G57743	G57743	
G57472	G57472		G57566	G57566		G57666	G57666		G57744	G57744	
G57473	G57473		G57567	G57567		G57673	G57673		G57745	G57745	
G57474	G57474		G57568	G57568		G57674	G57674		G57746	G57746	
G57477	G57477		G57569	G57569		G57675	G57675		G57747	G57747	
G57478	G57478		G57572	G57572		G57676	G57676		G57748	G57748	
G57479	G57479		G57573	G57573		G57677	G57677		G57749	G57749	
G57480	G57480		G57574	G57574		G57680	G57680		G57750	G57750	
G57481	G57481		G57575	G57575		G57682	G57682		G57751	G57751	
G57482	G57482		G57576	G57576		G57683	G57683		G57752	G57752	
G57483	G57483		G57577	G57577		G57689	G57689		G57753	G57753	
G57484	G57484		G57578	G57578		G57690	G57690		G57754	G57754	
G57487	G57487		G57579	G57579		G57691	G57691		G57755	G57755	
G57488	G57488		G57582	G57582		G57692	G57692		G57756	G57756	
G57489	G57489		G57583	G57583		G57693	G57693		G57757	G57757	
G57490	G57490		G57586	G57586		G57694	G57694		G57758	G57758	
G57493	G57493		G57587	G57587		G57695	G57695		G57759	G57759	
G57494	G57494		G57594	G57594		G57696	G57696		G57764	G57764	
G57495	G57495		G57595	G57595		G57697	G57697		G57765	G57765	
G57496	G57496		G57597	G57597		G57698	G57698		G57768	G57768	
G57497	G57497		G57598	G57598		G57699	G57699		G57769	G57769	
G57498	G57498		G57599	G57599		G57700	G57700		G57772	G57772	
G57499	G57499		G57600	G57600		G57701	G57701		G57773	G57773	
G57500	G57500		G57601	G57601		G57702	G57702		G57774	G57774	
G57509	G57509		G57602	G57602		G57703	G57703		G57775	G57775	
G57510	G57510		G57603	G57603		G57704	G57704		G57776	G57776	
G57515	G57515		G57604	G57604		G57705	G57705		G57777	G57777	
G57516	G57516		G57605	G57605		G57706	G57706		G57778	G57778	
G57517	G57517		G57606	G57606		G57709	G57709		G57779	G57779	
G57518	G57518		G57607	G57607		G57710	G57710		G57780	G57780	
G57521	G57521		G57608	G57608		G57711	G57711		G57781	G57781	
G57522	G57522		G57609	G57609		G57712	G57712		G57782	G57782	
G57523	G57523		G57612	G57612		G57713	G57713		G57783	G57783	
G57524	G57524		G57613	G57613		G57714	G57714		G57784	G57784	
G57533	G57533		G57614	G57614		G57715	G57715		G57785	G57785	
G57534	G57534		G57615	G57615		G57716	G57716		G57786	G57786	
G57535	G57535		G57628	G57628		G57717	G57717		G57790	G57790	
G57536	G57536		G57629	G57629		G57720	G57720		G57791	G57791	
G57539	G57539		G57634	G57634		G57721	G57721		G57792	G57792	
G57540	G57540		G57635	G57635		G57722	G57722		G57793	G57793	
G57541	G57541		G57640	G57640		G57723	G57723		G57794	G57794	
G57542	G57542		G57641	G57641		G57724	G57724		G57795	G57795	
G57543	G57543		G57642	G57642		G57725	G57725		G57796	G57796	
G57544	G57544		G57643	G57643		G57726	G57726		G57797	G57797	
G57545	G57545		G57644	G57644		G57727	G57727		G57798	G57798	
G57546	G57546		G57645	G57645		G57730	G57730		G57799	G57799	
G57549	G57549		G57646	G57646		G57731	G57731		G57800	G57800	

Important Note: Competitive Interchanges are to be used for stocking purposes only. Where multiple crosses are identified, please reference the applications section of this catalog./ **Remarque importante:** Les interchanges concurrentiels ne s'utilisent qu'aux fins de stocks. **Dans le cas de rferences multiples, consulter la section des applications du catalogue./** **Nota importante:** Dans le cas de rferences multiples, consulter la section des applications du catalogue./ **Nota importante:** Se pueden usar intercambios competitivos para propósitos de almacenamiento solamente. Cuando se identifican intercambios múltiples, consulte la sección de aplicaciones de este catálogo.

COMPETITIVE & O.E.M. INTERCHANGE LIST
Lista de Intercambios contra Competidores y Equipo Original.
Liste dinterchange de produits comptitifs & dquipement original (OEM)

Les Schwab... cont'd

Les schwab	Gabriel	Upgrade	Les schwab	Gabriel	Upgrade	Les schwab	Gabriel	Upgrade	Les schwab	Gabriel	Upgrade
G57801	G57801		G60571	G63614		G63605	G63605		G63893	G63893	
G57802	G57802		G60582	G63622		G63609	G63609		G63894	G63894	
G57803	G57803		G60583	G63623		G63615	G63615		G63895	G63895	
G57804	G57804		G60606	G63662		G63616	G63616		G63896	G63896	
G57812	G57812		G60616	G63673		G63620	G63620		G63897	G63897	
G57816	G57816		G60617	G63674		G63624	G63624		G63904	G63904	
G57817	G57817		G60618	G63675		G63625	G63625		G63918	G63918	
G57818	G57818		G60621	G63678		G63635	G63635		G63928	G63928	
G57819	G57819		G60622	G63679		G63638	G63638		G63929	G63929	
G57820	G57820		G60626	G63683		G63661	G63661		G63937	G63937	
G57825	G57825		G60657	G63714		G63671	G63671		G63950	G63950	
G60031	G63405		G60658	G63715		G63676	G63676		G63958	G63958	
G60042	G63377		G60659	G63716		G63689	G63689		G63961	G63961	
G60053	G63425		G60703	G63902		G63690	G63690		G63962	G63962	
G60099	G63490		G60706	G63905		G63692	G63692		G63966	G63966	
G60101	G63492		G60713	G63915		G63694	G63694		G63967	G63967	
G60129	G63511		G61112	G63772		G63712	G63712		G63969	G63969	
G60143	G63524		G61113	G63773		G63720	G63720		G63971	G63971	
G60144	G63525		G61115	G63775		G63721	G63721		G64000	G64000	
G60164	G63610		G61154	G63813		G63722	G63722		G64001	G64001	
G60165	G63611		G61182	G63848		G63726	G63726		G64002	G64002	
G60250	G63707		G61524	G63783		G63776	G63776		G64003	G64003	
G60251	G63708		G61544	G63803		G63778	G63778		G64006	G64006	
G60253	G63710		G61550	G63809		G63781	G63781		G64008	G64008	
G60260	G63717		G61551	G63810		G63782	G63782		G64009	G64009	
G60304	G63903		G61558	G63817		G63799	G63799		G64010	G64010	
G60308	G63907		G61559	G63818		G63808	G63808		G64012	G64012	
G60310	G63909		G61866	G63866		G63815	G63815		G64014	G64014	
G60408	G63347		G61886	G63886		G63828	G63828		G64015	G64015	
G60410	G63349		G61888	G63888		G63829	G63829		G64016	G64016	
G60414	G63355		G61959	G63959		G63832	G63832		G64026	G64026	
G60415	G63357		G61965	G63965		G63837	G63837		G64027	G64027	
G60417	G63359		G62011	G64011		G63842	G63842		G64028	G64028	
G60423	G63386		G62013	G64013		G63844	G63844		G64029	G64029	
G60424	G63387		G63173	G63173		G63845	G63845		G64030	G64030	
G60428	G63183		G63299	G63299		G63847	G63847		G64031	G64031	
G60433	G63410		G63306	G63306		G63860	G63860		G64032	G64032	
G60435	G63409		G63350	G63350		G63862	G63862		G64033	G64033	
G60438	G63414		G63353	G63353		G63864	G63864		G64037	G64037	
G60439	G63413		G63360	G63360		G63867	G63867		G64038	G64038	
G60449	G63421		G63366	G63366		G63868	G63868		G64040	G64040	
G60450	G63422		G63394	G63394		G63869	G63869		G64042	G64042	
G60451	G63423		G63404	G63404		G63870	G63870		G64043	G64043	
G60452	G63424		G63406	G63406		G63872	G63872		G64044	G64044	
G60476	G63375		G63411	G63411		G63873	G63873		G64046	G64046	
G60477	G63454		G63418	G63418		G63875	G63875		G64047	G64047	
G60480	G63455		G63419	G63419		G63878	G63878		G64048	G64048	
G60484	G63461		G63426	G63426		G63879	G63879		G64049	G64049	
G60486	G63479		G63432	G63432		G63882	G63882		G64050	G64050	
G60497	G63488		G63443	G63443		G63883	G63883		G64052	G64052	
G60498	G63489		G63456	G63456		G63884	G63884		G64056	G64056	
G60511	G63403		G63494	G63494		G63885	G63885		G64063	G64063	
G60553	G63547		G63495	G63495		G63889	G63889		G64071	G64071	
G60554	G63548		G63506	G63506		G63890	G63890		G64079	G64079	
G60561	G63607		G63510	G63510		G63891	G63891		G64080	G64080	
G60562	G63608		G63604	G63604		G63892	G63892		G64087	G64087	

Important Note: Competitive Interchanges are to be used for stocking purposes only. Where multiple crosses are identified, please reference the applications section of this catalog. / **Remarque importante:** Les interchanges concurrentiels ne s'utilisent qu'aux fins de stocks. Dans le cas de références multiples, consulter la section des applications du catalogue. / **Nota importante:** Dans le cas de références multiples, consulter la section des applications du catalogue. / **Nota importante:** Se pueden usar intercambios competitivos para propósitos de almacenamiento solamente. Cuando se identifican intercambios múltiples, consulte la sección de aplicaciones de este catálogo.

COMPETITIVE & O.E.M. INTERCHANGE LIST
Lista de Intercambios contra Competidores y Equipo Original.
Liste dinterchange de produits comptitifs & dquipement original (OEM)

Mazda

Mazda	Gabriel	Upgrade	Mazda	Gabriel	Upgrade	Mazda	Gabriel	Upgrade	Mazda	Gabriel	Upgrade
EG21-28-910E	G64056		EG23-28-910B	G64056		EG23-34-900A	G52209		GK2A-34-900J	G57270	
EG21-34-900A	G52209		EG23-28-910C	G64056		EG23-34-900B	G52209		N066-28-700	G56597	
EG21-34-900B	G52209		EG23-28-910D	G64056		GK2A-28-700D	69591				
EG21-34-900C	G52209		EG23-34-900	G52209		GK2A-34-700H	G57270				

McQuay Norris

Mcquay norris	Gabriel	Upgrade	Mcquay norris	Gabriel	Upgrade	Mcquay norris	Gabriel	Upgrade	Mcquay norris	Gabriel	Upgrade
CB4120	143058		SM7259	143088		SM7501	143218		SM7662	143564	
CB4120	143059		SM7289	142651		SM7510	143404		SM7663	143391	
CB4125	143057		SM7298	142735		SM7530	143396		SM7664	143390	
CB4128	143061		SM7333	143367		SM7534	143194		SM7667	143462	
CB4138	143057		SM7334	143191		SM7539	143191		SM7668	143460	
SM5475	143191		SM7337	143082		SM7541	143354		SM7671	143342	
SM6076	142091		SM7343	142828		SM7542	143355		SM7672	143191	
SM7007	142135		SM7345	142316		SM7549	143089		SM7672	143365	
SM7049	142230		SM7356	142836		SM7563	143418		SM7716	143495	
SM7070	142244		SM7362	143197		SM7565	143388		SM7722	143341	
SM7071	142245		SM7363	143325		SM7566	143387		SM7723	143363	
SM7078	142247		SM7367	143259		SM7569	143425		SM7724	143461	
SM7080	143281		SM7368	143256		SM7573	143385		SM7735	143531	
SM7082	142249		SM7371	142932		SM7574	143364		SM7752	143406	
SM7083	142250		SM7372	142933		SM7576	143323		SM7753	143343	
SM7086	142252		SM7378	142949		SM7580	143419		SM7754	143383	
SM7105	142317		SM7380	142938		SM7602	143408		SM7760	143345	
SM7123	142329		SM7391	143191		SM7606	143335		SM7772	143491	
SM7144	142419		SM7399	143315		SM7627	143369		SM7778	143366	
SM7151	142439		SM7402	143209		SM7627	143468		SM7781	143397	
SM7160	142403		SM7403	143204		SM7630	143316		SM7782	143477	
SM7161	142404		SM7434	143094		SM7633	143416		SM7784	143409	
SM7173	142625		SM7450	143241		SM7644	143344		SM7784	143410	
SM7200	142840		SM7453	143073		SM7646	143319		SM7821	143305	
SM7236	142526		SM7454	143074		SM7659	143394				
SM7240	142530		SM7464	142937		SM7659	143422				
SM7249	143458		SM7478	143202		SM7661	143318				

Mercedes Benz

Mercedes benz	Gabriel	Upgrade	Mercedes benz	Gabriel	Upgrade	Mercedes benz	Gabriel	Upgrade	Mercedes benz	Gabriel	Upgrade
163-326-11-00	G64049		906 320 06 33	G57802		906 320 13 33	G57802		907 320 790 1	G64089	
906 320 04 33	G57802		906 320 10 33	G57802		907 320 430 1	G64089				

Mitsubishi

Mitsubishi	Gabriel	Upgrade	Mitsubishi	Gabriel	Upgrade	Mitsubishi	Gabriel	Upgrade	Mitsubishi	Gabriel	Upgrade
MN101519	G51838		MR491946	143394		MR554860	143088		MR961211	G51838	

Monroe

Monroe	Gabriel	Upgrade	Monroe	Gabriel	Upgrade	Monroe	Gabriel	Upgrade	Monroe	Gabriel	Upgrade
1000	82156		1668722	89440		16775	83207	89407	171100	G57146	
1085	83214		16720	83107		16775	89407		171101L	G57425	
12608	83125		16721	83125		16776	83122	89406	171101R	G57424	
12788	83216		16767	85013	89414	16776	89406		171102	G57413	
12866	83207	89407	16767	89414		16777	85006		171102	G57647	
12866	89407		16769	83221		16778	83203	89436	171103	G57118	
12872	83219		16770	83209	89414	16778	89436		171109	G57458	
139104	G57125		16770	89414		16779	83126	89430	171110	G57457	
139105	G57023		16771	83126	89430	16779	89430		171111	G57053	
139112	G57000		16771	89430		16780	83123	89405	171114L	G57442	
1401	58423		16772	83122	89406	16780	89405		171114L	G57444	
1401	61531		16772	89406		16781	85006				
1401	81516		16773	85005	89430	16787	85030	89440			
16385	83215		16773	89430		16787	89440				
1668722	85030	89440	16774	83215		16949	83120				

Important Note: Competitive Interchanges are to be used for stocking purposes only. Where multiple crosses are identified, please reference the applications section of this catalog. / Remarque importante: Les interchanges concurrentiels ne s'utilisent qu'aux fins de stocks. Dans le cas de rferences multiples, consulter la section des applications du catalogue. / Nota importante: Dans le cas de rferences multiples, consulter la section des applications du catalogue. / Nota importante: Se pueden usar intercambios competitivos para propósitos de almacenamiento solamente. Cuando se identifican intercambios múltiples, consulte la sección de aplicaciones de este catálogo.

COMPETITIVE & O.E.M. INTERCHANGE LIST
Lista de Intercambios contra Competidores y Equipo Original.
Liste d'interchange de produits compétitifs & d'équipement original (OEM)

Monroe... cont'd

Monroe	Gabriel	Upgrade	Monroe	Gabriel	Upgrade	Monroe	Gabriel	Upgrade	Monroe	Gabriel	Upgrade
171114R	G57441		171372	G57056		171581	G57364		172114	G57115	
171119L	G57123		171373L	G57067		171582	G57363		172115	G57114	
171119R	G57124		171373R	G57068		171584	G57279		172116	G57357	
171124	G57095		171377L	G57083		171585	G57278		172117	G57358	
171125	G57096		171377R	G57083		171588	G57509		172120	G57608	
171126	G57447		171380L	G57086		171589	G57510		172121	G57609	
171128L	G57206		171380R	G57087		171592	G56965		172123L	G57054	
171128R	G57206		171398	G57019		171593	G57046		172123R	G57055	
171130	G57466		171400	G57269		171594	G57045		172124	G57050	
171131	G57465		171401	G57268		171597	G57012		172125	G57049	
171137L	G57454		171404	G57089		171598	G57011		172130L	G57112	
171137R	G57453		171405	G57088		171615	G56934		172130R	G57113	
171138	G57172		171406	G57168		171615	G56937		172135	G57222	
171139	G57173		171407	G57167		171616	G56936		172136	G57223	
171140	G57132		171417	G57059		171661	G57060		172138	G57271	
171141	G57103		171426	G57031		171662L	G56924		172143	G57085	
171266	G56995		171427	G57030		171662R	G56925		172144	G57084	
171281	G56938		171433	G57050		171665	G56929		172170	G57489	
171282	G57422		171433	G57522		171667	G56963		172171	G57490	
171291L	G56996		171434	G57049		171668	G56962		172177	G57141	
171291R	G56997		171434	G57521		171669	G56964		172179L	G57047	
171292	G56998		171435	G57140		171670	G57060		172179R	G57048	
171293	G57057		171436	G57139		171671L	G56924		172185	G57050	
171293	G57058		171437	G57098		171671R	G56925		172186	G57049	
171299	G56943		171438	G57097		171672	G56927		172191	G57399	
171312	G57036		171441	G57145		171674	G57559		172192	G57398	
171313	G57026		171442	G57144		171675	G57558		172194	G57400	
171313	G57075		171447	G57365		171678	G56931		172195	G57270	
171321	G57017		171448	G57366		171679	G56930		172199	G57070	
171322	G63679		171451	G57120		171680	G56933		172199	G57122	
171327	G57159		171452	G57119		171681	G56932		172200	G57069	
171327	G57160		171453	G57106		171684	G57051		172200	G57121	
171340L	G57032		171454	G57105		171685	G57051		172203	G57099	
171340L	G57061		171461	G57158		171686	G56928		172203	G57100	
171340R	G57033		171462	G57157		171691L	G56991		172205	G57077	
171340R	G57062		171490	G57042		171691R	G56992		172206	G57076	
171341	G57022		171491	G57041		171798	G56726		172207	G57079	
171346	G57080		171492	G57044		171920	G56935		172208	G57078	
171347L	G57220		171493	G57043		171924	G57013		172209	G57111	
171347R	G57221		171494	G57649		171925	G57014		172210	G57110	
171348L	G57027		171495	G57648		171933	G57006		172213	G57153	
171348R	G57027		171496	G57651		171945	G56994		172214	G57152	
171351L	G57065		171497	G57650		171946	G56993		172217	G57312	
171351R	G57066		171504	G57064		171953	G56950		172218	G57311	
171352L	G57010		171505	G57063		171954	G56949		172219	G57219	
171352R	G57010		171525	G57039		171957	G56933		172220	G57218	
171353	G57282		171565L	G57431		171958	G56932		172221	G57343	
171354	G57430		171565R	G57432		172101	G57615		172222	G57344	
171358	G57092		171572L	G56956		172102	G57614		172231	G57142	
171359	G57036		171572R	G56957		172103	G57613		172236	G57372	
171361	G57020		171575	G57397		172104	G57612		172237	G57373	
171362	G57021		171577L	G57007		172105	G57035		172238	G57524	
171369	G57015		171577R	G57008		172106	G57034		172239	G57523	
171370	G57016		171578	G56973		172107	G57035		172240	G57031	
171371L	G57133		171579	G56974		172108	G57034		172241	G57030	
171371R	G57134		171580	G56975		172113	G57274		172242	G57674	

Important Note: Competitive Interchanges are to be used for stocking purposes only. Where multiple crosses are identified, please reference the applications section of this catalog. / **Remarque importante:** Les interchanges concurrentiels ne s'utilisent qu'aux fins de stocks. Dans le cas de références multiples, consulter la section des applications du catalogue. / **Nota importante:** Dans le cas de références multiples, consulter la section des applications du catalogue. / **Nota importante:** Se pueden usar intercambios competitivos para propósitos de almacenamiento solamente. Cuando se identifican intercambios múltiples, consulte la sección de aplicaciones de este catálogo.

COMPETITIVE & O.E.M. INTERCHANGE LIST
Lista de Intercambios contra Competidores y Equipo Original.
Liste dinterchange de produits comptitifs & dquipement original (OEM)

Monroe... cont'd

Monroe	Gabriel	Upgrade	Monroe	Gabriel	Upgrade	Monroe	Gabriel	Upgrade	Monroe	Gabriel	Upgrade
172243	G57673		172392	G57162		172562R	G57418		172763	G57153	
172246	G57609		172393	G57161		172563	G57419		172764	G57152	
172247	G57608		172394L	G57568		172565	G57340		172765	G57562	
172248	G57071		172394R	G57569		172566	G57339		172766	G57563	
172248	G57072		172398L	G57414		172568	G57456		172780L	G57206	
172257	G57082		172398R	G57415		172569	G57455		172780R	G57206	
172258	G57081		172400L	G57428		172596	G57427		172781	G57733	
172261	G57148		172400R	G57429		172597	G57330		172782	G57732	
172267	G57164		172401	G57178		172598	G57329		172783	G57731	
172268	G57163		172408	G57071		172599L	G57451		172784	G57730	
172271	G57185		172414	G57643		172599R	G57452		172901	G57546	
172272	G57184		172415	G57642		172600L	G57451		172902	G57545	
172275	G57205		172416	G57643		172600R	G57452		172903	G57060	
172276	G57204		172417	G57642		172604	G57494		172905	G57368	
172278	G57142		172425	G57478		172605	G57493		172906	G57367	
172281	G57149		172426	G57477		172608	G57474		172907	G57727	
172284	G57391		172433	G57561		172609	G57473		172908	G57726	
172285	G57390		172434	G57560		172618	G57518		172917	G57488	
172286	G57391		172448	G57126		172619	G57517		172918	G57487	
172287	G57390		172449	G57127		172620	G57694		172919	G57748	
172292	G57147		172450	G57128		172621	G57693		172942	G57500	
172295	G57131		172451	G57129		172624	G57456		172943	G57499	
172296	G57130		172471L	G56924		172625	G57455		172949	G57709	
172297	G57276		172471R	G56925		172626	G57378		172950	G57794	
172298	G57275		172485	G57484		172627	G57377		172951	G57795	
172299	G57472		172486	G57483		172647	G57696		172957L	G57597	
172300	G57471		172489	G57659		172648	G57695		172957R	G57598	
172305	G57394		172490	G57658		172652L	G57683		172962	G57677	
172306	G57393		172491	G57575		172652R	G57683		172963	G57676	
172307	G57191		172492	G57574		172653	G57746		172964	G57659	
172308	G57190		172492	G57575		172654	G57747		172965	G57658	
172309	G57193		172493	G57362		172663	G57378		172966	G57659	
172310	G57192		172494	G57361		172664	G57377		172967	G57658	
172311	G57156		172497L	G57416		172670	G57723		172974	G57606	
172311	G57277		172497R	G57682		172671	G57722		172975	G57605	
172332	G57466		172497R	G57691		172678	G57629		172980	G57376	
172333	G57465		172498	G57345		172679	G57628		172981	G57375	
172343	G57334		172499	G57346		172680	G57645		172985	G57853	
172344	G57333		172501	G57423		172681	G57644		172986	G57852	
172345	G57460		172509	G57266		172686	G57340		172989	G57544	
172346	G57459		172510	G57267		172687	G57339		172990	G57543	
172351	G57202		172518	G57109		172688	G57739		173032L	G57683	
172352	G57203		172522	G57727		172689	G57738		173032R	G57683	
172357	G57405		172523	G57726		172695	G57706		181100	G57146	
172363	G57664		172526	G57198		172708	G57743		181101L	G57425	
172364	G57663		172527	G57197		172709	G57742		181101R	G57424	
172365	G57376		172530	G57498		172712	G57690		181102	G57646	
172366	G57375		172532	G57498		172713	G57689		181111	G57053	
172367	G57177		172533	G57498		172727	G57495		181119L	G57123	
172368	G57176		172536	G57138		172728	G57496		181119R	G57124	
172378	G57201		172537	G57137		172729	G57820		181124	G57095	
172379	G57200		172541	G57565		172730	G57819		181125	G57096	
172384	G57190		172542	G57564		172741	G57193		181126	G57447	
172385	G57192		172546L	G57749		172742	G57192		181128L	G57206	
172390	G57370		172546R	G57825		172743	G57725		181128R	G57206	
172391	G57369		172562L	G57417		172744	G57724		181138	G57172	

Important Note: Competitive Interchanges are to be used for stocking purposes only. Where multiple crosses are identified, please reference the applications section of this catalog./ **Remarque importante:** Les interchanges concurrentiels ne s'utilisent qu'aux fins de stocks. Dans le cas de rfrences multiples, consulter la section des applications du catalogue./ **Nota importante:** Dans le cas de rfrences multiples, consulter la section des applications du catalogue./ **Nota importante:** Se pueden usar intercambios competitivos para propósitos de almacenamiento solamente. Cuando se identifican intercambios múltiples, consulte la sección de aplicaciones de este catálogo.

COMPETITIVE & O.E.M. INTERCHANGE LIST
Lista de Intercambios contra Competidores y Equipo Original.
Liste dinterchange de produits comptitifs & dquipement original (OEM)

Monroe... cont'd

Monroe	Gabriel	Upgrade	Monroe	Gabriel	Upgrade	Monroe	Gabriel	Upgrade	Monroe	Gabriel	Upgrade
181140	G57132		181461	G57158		181954	G56949		182284	G57391	
181141	G57103		181462	G57157		181957	G56933		182285	G57390	
181266	G56995		181490	G57042		181958	G56932		182286	G57391	
181274	G56951		181491	G57041		182105	G57035		182287	G57390	
181281	G56938		181492	G57044		182106	G57034		182292	G57147	
181291L	G56996		181493	G57043		182113	G57274		182295	G57131	
181291R	G56997		181494	G57649		182114	G57115		182296	G57130	
181292	G56998		181495	G57648		182115	G57114		182297	G57276	
181293	G57057		181504	G57064		182123L	G57054		182298	G57275	
181293	G57058		181505	G57063		182123R	G57055		182305	G57394	
181299	G56943		181525	G57039		182130L	G57112		182306	G57393	
181312	G57036		181572L	G56956		182130R	G57113		182307	G57191	
181313	G57026		181572R	G56957		182135	G57223		182308	G57190	
181321	G57017		181577L	G57007		182136	G57222		182309	G57193	
181322	G57018		181577R	G57008		182138	G57271		182310	G57192	
181327	G57159		181578	G56973		182143	G57085		182311	G57156	
181340L	G57061		181579	G56974		182144	G57084		182321	G57324	
181340R	G57062		181580	G56975		182174	G56951		182351	G57203	
181341	G57022		181584	G57279		182177	G57141		182352	G57202	
181346	G57080		181585	G57278		182179L	G57047		182357	G57405	
181347L	G57220		181592	G56965		182179R	G57048		182358	G57404	
181347R	G57221		181593	G57045		182185	G57050		182363	G57664	
181348L	G57027		181594	G57046		182186	G57049		182364	G57663	
181348R	G57027		181597	G57012		182199	G57070		182365	G57376	
181351L	G57065		181598	G57011		182200	G57069		182366	G57375	
181351R	G57066		181615	G56934		182203	G57099		182367	G57464	
181352L	G57010		181615	G56937		182205	G57077		182368	G57463	
181352R	G57010		181616	G56936		182206	G57076		182378	G57201	
181353	G57282		181661	G57060		182207	G57079		182379	G57200	
181358	G57092		181662L	G56924		182208	G57078		182392	G57162	
181361	G57020		181662R	G56925		182209	G57111		182393	G57161	
181362	G57021		181665	G56929		182210	G57110		182401	G57178	
181369	G57212		181667	G56963		182215	G57533		182471L	G56924	
181371L	G57133		181668	G56962		182216	G57534		182471R	G56925	
181371R	G57134		181669	G56964		182217	G57312		182497L	G57416	
181372	G57056		181670	G57060		182218	G57311		182497R	G57691	
181373L	G57067		181671L	G56924		182219	G57219		182509	G57266	
181373R	G57068		181671R	G56925		182220	G57218		182510	G57267	
181380L	G57086		181672	G56927		182221	G57343		182518	G57109	
181380R	G57087		181674	G57559		182222	G57344		182526	G57197	
181398	G57019		181675	G57558		182231	G57142		182527	G57198	
181400	G57269		181678	G56931		182236	G57372		182530	G57498	
181401	G57268		181679	G56930		182237	G57373		182536	G57138	
181404	G57089		181680	G56933		182240	G57031		182537	G57137	
181405	G57088		181681	G56932		182241	G57030		182562L	G57207	
181406	G57168		181685	G57051		182248	G57071		182562R	G57208	
181407	G57167		181686	G56928		182257	G57082		182563	G57419	
181417	G57059		181691L	G56991		182258	G57081		182596	G57427	
181426	G57031		181691R	G56992		182261	G57148		182597	G57329	
181427	G57030		181784	G57125		182267	G57164		182598	G57330	
181435	G57140		181920	G56935		182268	G57163		189105	G57023	
181436	G57139		181924	G57013		182271	G57185		250132	81582	
181451	G57120		181925	G57014		182272	G57184		250186	81482	
181452	G57119		181945	G56994		182275	G57205		250194	81750	
181453	G57106		181946	G56993		182276	G57204		250290	81878	
181454	G57105		181953	G56950		182281	G57149		250300	81750	

Important Note: Competitive Interchanges are to be used for stocking purposes only. Where multiple crosses are identified, please reference the applications section of this catalog. / **Remarque importante:** Les interchanges concurrentiels ne s'utilisent qu'aux fins de stocks. Dans le cas de références multiples, consulter la section des applications du catalogue. / **Nota importante:** Dans le cas de références multiples, consulter la section des applications du catalogue. / **Nota importante:** Se pueden usar intercambios competitivos para propósitos de almacenamiento solamente. Cuando se identifican intercambios múltiples, consulte la sección de aplicaciones de este catálogo.

COMPETITIVE & O.E.M. INTERCHANGE LIST
Lista de Intercambios contra Competidores y Equipo Original.
Liste d'interchange de produits compititifs & d'equipement original (OEM)

Monroe... cont'd

Monroe	Gabriel	Upgrade	Monroe	Gabriel	Upgrade	Monroe	Gabriel	Upgrade	Monroe	Gabriel	Upgrade
250302	81912		272214	G57586		272599R	G57452		3100	G63907	
250303	81892		272215	G57587		272604	G57494		31000	61500	
250322	61614		272216	G57586		272605	G57493		31000	81147	
250984	81934		272217	G57312		272621	G57691		31000	82156	
271100	G57409		272218	G57311		272626	G57378		31029	81675	
271102	G57646		272257	G57082		272627	G57377		31069	81270	
271109	G57458		272258	G57081		272638	G57812		31069	82076	
271110	G57457		272261	G57148		272679	G57704		31089	82001	
271124	G57095		272275	G57205		272684	G57673		31094	61506	
271125	G57096		272276	G57204		272685	G57674		31094	81318	
271128L	G57206		272288	G57353		272686	G57340		31094	82012	
271128R	G57206		272289	G57354		272687	G57339		31125	82125	
271130	G57466		272297	G57276		272712	G57690		31131	61632	
271131	G57465		272298	G57275		272713	G57689		31131	81469	
271137L	G57454		272305	G57394		272730	G57819		31131	81825	
271137R	G57453		272306	G57393		272748	G57518		31163	81416	
271139	G57173		272307	G57191		272749	G57517		31163	81440	
271311	G57026		272308	G57190		272750	G57518		31538	82005	
271326L	G57090		272309	G57193		272751	G57517		31542	82001	
271326R	G57091		272345	G57460		272889	G57583		32022	82090	
271341	G57022		272346	G57459		272919	G57748		32066	61529	
271346	G57080		272367	G57463		272934	G57849		32066	61555	
271353	G57282		272368	G57464		272935	G57848		32066	81446	
271354	G57430		272384	G57192		272957L	G57792		32066	81541	
271358	G57092		272385	G57192		272957R	G57793		32066	81713	
271371L	G57133		272394L	G57568		272974	G57120		32066	82099	
271371R	G57134		272394R	G57569		272975	G57119		32067	82601	
271426	G57031		272401	G57607		273133	G57833		32073	82131	
271427	G57030		272408	G57071		273134	G57834		32075	61521	
271435	G57140		272412	G57635		281100	G57409		32075	81394	
271436	G57139		272413	G57634		281130	G57466		32080	61518	
271441	G57145		272471L	G56924		281131	G57465		32080	81242	
271442	G57144		272471R	G56925		281311	G57026		32103	82130	
271453	G57349		272483	G57482		281426	G57031		32112	81095	
271454	G57350		272484	G57481		281427	G57030		32113	61501	
271498	G57651		272489	G57484		281616	G56936		32113	61508	
271499	G57650		272490	G57483		281662L	G56924		32113	81478	
271525	G57039		272491	G57331		281662R	G56925		32118	82128	
271575	G57397		272492	G57332		281670	G57060		32126	81340	
271577L	G57007		272501	G57423		281678	G56931		32126	82039	
271577R	G57008		272526	G57198		281679	G56930		32127	61523	
271588	G57509		272527	G57197		281680	G56933		32127	81096	
271589	G57510		272532	G57498		281681	G56932		32127	81834	
271616	G56936		272533	G57497		281951	G56948		32128	81091	
271662L	G56924		272534	G57496		281952	G56948		32132	61529	
271662R	G56925		272535	G57495		282257	G57082		32132	81494	
271670	G57060		272562L	G57417		282258	G57081		32132	81582	
271678	G56931		272562R	G57418		282261	G57148		32132	81750	
271679	G56930		272565	G57340		282275	G57205		32134	81153	
271680	G56933		272566	G57339		282276	G57204		32143	81495	
271681	G56932		272568	G57456		282299	G57472		32164	61519	
271951	G56948		272569	G57455		282300	G57471		32164	81484	
271952	G56948		272596	G57427		282307	G57191		32186	61528	
272162	G57635		272597	G57330		282308	G57190		32186	81482	
272163	G57634		272598	G57329		282491	G57480		32194	61531	
272213	G57587		272599L	G57451		282492	G57479		32194	81516	

Important Note: Competitive Interchanges are to be used for stocking purposes only. Where multiple crosses are identified, please reference the applications section of this catalog. / **Remarque importante:** Les interchanges concurrentiels ne s'utilisent qu'aux fins de stocks. Dans le cas de rfrences multiples, consulter la section des applications du catalogue. / **Nota importante:** Dans le cas de rfrences multiples, consulter la section des applications du catalogue. / **Nota importante:** Se pueden usar intercambios competitivos para propósitos de almacenamiento solamente. Cuando se identifican intercambios múltiples, consulte la sección de aplicaciones de este catálogo.

COMPETITIVE & O.E.M. INTERCHANGE LIST
Lista de Intercambios contra Competidores y Equipo Original.
Liste d'interchange de produits comptitifs & d'equipement original (OEM)

Monroe... cont'd

Monroe	Gabriel	Upgrade	Monroe	Gabriel	Upgrade	Monroe	Gabriel	Upgrade	Monroe	Gabriel	Upgrade
32196	61535		32245	81870		32285	61521		32330	81916	
32196	61615		32247	61510		32287	G63432		32332	61614	
32196	81548		32247	81871		32288	61614		32333	61659	
32196	81936		32249	61593		32288	81821		32333	81924	
32197	61536		32249	81872		32290	61605		32334	G63726	
32197	81549		32250	61601		32290	81878		32335	61609	
32202	69755		32250	61679		32292	61606		32335	81910	
32206	61501		32250	81836		32293	61500		32336	61593	
32206	81478		32251	61584		32294	61700		32336	81872	
32206	81507		32251	81837		32295	61699		32337	81911	
32207	61550		32252	61535		32296	61623		32338	61664	
32207	81676		32252	81548		32296	61626		32338	81869	
32207	82007		32253	61590		32296	81893		32339	61676	
32211	81583		32253	61624		32299	81927		32339	81926	
32212	61539		32253	81823		32300	61504		32340	61663	
32214	61512		32253	81890		32300	81750		32340	81920	
32214	81559		32254	61542		32301	82003		32341	61642	
32215	81560		32254	81726		32302	61611		32341	81921	
32216	81491		32258	61504		32302	81912		32344	61675	
32217	61593		32258	61556		32303	61638		32344	81930	
32217	81507		32258	81750		32303	81892		32345	61642	
32217	81553		32259	61626		32303R	81892		32345	61675	
32217	81872		32259	81744		32304	61613		32345	81921	
32219	81691		32260	61595		32304	81914		32345	81930	
32220	61541		32260	81833		32305	61612		32346	61623	
32220	81583		32262	81270		32305	81913		32346	81893	
32224	61544		32263	81726		32306	61616		32347	58803	
32224	81668		32264	58638		32306	81929		32347	61643	
32225	61543		32264	61565		32314	81318		32347	81922	
32225	81667		32265	61687		32315	G63720		32348	58930	
32226	61520		32266	61565		32316	61560		32348	61675	
32226	77414		32266R	61543		32316	81904		32348	81930	
32226	81490		32267	61591		32317	69675		32350	61663	
32227	61520		32267	81744		32317	81713		32350	81925	
32227	81490		32268	61646		32318	61512		32355	14039	
32228	61554		32268	81828		32318	81559		32356	G63614	
32228	81710		32269	61575		32319	61658		32356	G63622	
32231	61547		32269	81891		32319	81923		32357	58808	
32231	81082		32270	61582		32321	61658		32357	61654	
32231	81710		32271	81872		32321	81923		32358	58809	
32235	61561		32272	61608		32322	61614		32358	61655	
32235	81744		32273	G63782		32323	61614		32359	58810	
32237	61533		32274	G63781		32324	61638		32359	61656	
32237	61627		32275	61625		32324	81892		32360	81082	
32237	81730		32277	61599		32325	61612		32361	G63394	
32237	81917		32277	81928		32325	81913		32362	61685	
32238	61573		32278	61600		32326	61641		32362	81668	
32238	61629		32278	81873		32326	81920		32365	61642	
32238	81540		32279	61634		32327	61600		32365	81921	
32238	81905		32279	81919		32327	81873		32366	61635	
32238	81918		32280	61520		32327R	81873		32366	81919	
32239	61530		32280	61613		32328	58803		32369	G63616	
32239	81510		32280	81490		32328	61643		32370	G63692	
32243	61520		32281	82147		32328	81922		32371	61523	
32243	81490		32283	G63510		32329	81921		32371	81096	
32245	61552		32284	G63387		32330	61626		32372	61547	

Important Note: Competitive Interchanges are to be used for stocking purposes only. Where multiple crosses are identified, please reference the applications section of this catalog. / **Remarque importante:** Les interchanges concurrentiels ne s'utilisent qu'aux fins de stocks. Dans le cas de références multiples, consulter la section des applications du catalogue. / **Nota importante:** Dans le cas de références multiples, consulter la section des applications du catalogue. / **Nota importante:** Se pueden usar intercambios competitivos para propósitos de almacenamiento solamente. Cuando se identifican intercambios múltiples, consulte la sección de aplicaciones de este catálogo.

COMPETITIVE & O.E.M. INTERCHANGE LIST
Lista de Intercambios contra Competidores y Equipo Original.
Liste dinterchange de produits comptitifs & dquipement original (OEM)

Monroe... cont'd

Monroe	Gabriel	Upgrade	Monroe	Gabriel	Upgrade	Monroe	Gabriel	Upgrade	Monroe	Gabriel	Upgrade
32372	81082		33074	81113		34521	61710		34692	61675	
32372	81507		33076	58357		34521	61716		34693	61675	
32373	61542		33076	61517		34522	61712		34694	58930	
32373	81726		33082	81492		34522	61714		34694	61642	
32375	81342		33082	81514		34523	77967		34694	61675	
32376	81834		33084	61524		34523	G63969		34694	81930	
32377	82007		33084	81164		34524	77968		34721	83103	
32379	G63411		33086	61522		34524	77969		34722	83400	
32380	G63675		33086	81496		34525	61680		34729	61520	
32381	61520		33090	82010		34526	61682		34729	61546	
32381	61546		33095	81459		34530	61685		34729	G63414	
32383	61509		33101	82010		34534	G64009		34729MM	61520	
32383	81541		33121	81880		34612	83017		34730	61520	
32385	81091		33122	81481		34617	83019		34730	G63386	
32386	81510		33123	69675		34655	58714		34730MM	61520	
32388	G64027		33123	81446		34655	61611		34731	61547	
32389	G64028		33127	81446		34655	G63714		34731	61554	
32390	81933		33127	81713		34656	61638		34732	61614	
32390R	81933		33128	81495		34656	G63778		34732	G63455	
32391	61691		33136	81495		34656MM	61638		34736	61525	
32391	61692		33137	81794		34657	61613		34740	58423	
32391	81931		33178	G63884		34657	G63716		34740	61531	
32392	81932		33179	G63879		34657MM	61613		34740	81516	
32393	G63607		33180	61662		34658	61612		34741	61544	
32394	G63809		33181	61506		34671	61614		34750	58359	
32395	G63837		33182	61662		34672	61614		34750	61523	
32399	G55821		33183	69587		34673	61638		34751	61590	
32400	77949		33184	61717		34673	81892		34751	G63607	
32401	61710		33185	G51807		34674	81913		34756	61543	
32401	61716		33187	69900		34675	61641		34759	61595	
32401	81931		33188	69473		34675MM	61641		34759	G63624	
32402	61712		33189	69590		34676	58662		34760	58622	
32402	61714		33190	G64042		34676	61600		34760	61591	
32403	81934		33191	G63844		34676MM	61600		34760	G63622	
32404	81935		33192	61704		34677	58803		34761	58623	
32405	61720		33193	G64040		34677	61643		34761	61646	
32406	61734		33194	70010		34678	61642		34761	G63623	
32407	61715		33195	69589		34678	81873		34763	58638	
32545	82032		33196	G51874		34684	58807		34763	61565	
32592	82032		33197	69575		34684	G63622		34763	61687	
33033	61525		33198	69592		34685	58808		34763MM	61565	
33033	81039		33274	61704		34685	61654		34766	61664	
33049	61592		33274	69909		34685	77808		34768	83209	89414
33049	81340		33275	81937		34685	G63808		34768	89414	
33049	81495		34501	58803		34686	58809		34769	61676	
33049	81937		34501	61643		34686	61655		34770	61713	
33049	82034		34504	58817		34686	G63809		34771	81342	
33049	82066		34504	61663		34687	58810		34774	61512	
33049	82155		34514	G63958		34687	61656		34776	61599	
33049	G63610		34515	61691		34687	61682		34777	58662	
33050	82602		34515	61692		34687	G63810		34777	61600	
33053	82069		34516	81932		34689	61641		34777MM	61600	
33053	82126		34517	G63837		34689	61663		34778	61634	
33059	81076		34518	G63809		34690	61642		34780	81560	
33059	82104		34519	G63837		34690	81921		34781	61642	
33074	61516		34520	G63958		34692	58930		34782	61635	

Important Note: Competitive Interchanges are to be used for stocking purposes only. Where multiple crosses are identified, please reference the applications section of this catalog./ **Remarque importante:** Les interchanges concurrentiels ne s'utilisent qu'aux fins de stocks. Dans le cas de rferences multiples, consulter la section des applications du catalogue./ **Nota importante:** Dans le cas de rferences multiples, consulter la section des applications du catalogue./ **Nota importante:** Se pueden usar intercambios competitivos para propósitos de almacenamiento solamente. Cuando se identifican intercambios múltiples, consulte la sección de aplicaciones de este catálogo.

COMPETITIVE & O.E.M. INTERCHANGE LIST
Lista de Intercambios contra Competidores y Equipo Original.
Liste dinterchange de produits comptitifs & dquipement original (OEM)

Monroe... cont'd

Monroe	Gabriel	Upgrade	Monroe	Gabriel	Upgrade	Monroe	Gabriel	Upgrade	Monroe	Gabriel	Upgrade
34782	77674		34906	61521		37024	G63610		37083	81548	
34785	61512		34907	G63511		37026	G63424		37085	G63896	
34786	61658		34910	61516		37026	G63721		37086	77638	
34787	G63615		34910	61522		37027	61536		37087	G63638	
34788	G63616		34910	81496		37027	77425		37089	G63350	
34789	61658		34911	61518		37028	G63904		37090	G63357	
34790	61601		34911	G63350		37029	G63419		37091	G63413	
34791	G63692		34912	G63625		37029	G63492		37093	G63359	
34793	61520		34919	G63411		37029	G63928		37094	G63353	
34793MM	61520		34920	58412		37030	77479		37095	G63410	
34794	61523		34920	61642		37031	G63404		37095	G63414	
34795	G64044		34927	61554		37032	77494		37096	G63359	
34796	58929		34927	G63409		37033	G63548		37097	G63950	
34796	61591		34928	61546		37034	G63414		37098	G63299	
34796	G63929		34929	58403		37035	77607		37099	58423	
34797	61547		34929	G63403		37035	G63607		37100	G63904	
34797	G63406		34930	61530		37036	G63410		37102	G63661	
34798	58609		34934	61528		37037	G63409		37103	G63413	
34798	58901		34944	61516		37038	G63461		37103	G63662	
34798	61542		34945	58421		37039	G63461		37104	G63673	
34798	77609		34945	61504		37040	G63347		37104	G63674	
34799	61542		34945	81750		37041	77662		37105	G63662	
34800	G64043		34953	61509		37044	G63488		37108	G63707	
34802	83216		34953	81541		37045	G63183		37108ST	G63707	
34802MM	83216		34953MM	61509		37047	G63813		37109	G63708	
34803	61500		34958	61519		37047	G63902		37109ST	G63708	
34803	G63306		34959	G63432		37048	G63492		37110	G63676	
34803MM	61500		34960	G63366		37049	G63355		371102	G57647	
34804	61623		34963	61547		37050	G63489		37111	G63937	
34804	77678		34963	G63406		37051	G63490		37112	G63689	
34804	81893		34964	61530		37052	G63406		371124	G57095	
34807	61638		34968	61501		37053	G63386		371128L	G57206	
34810	G64148		34968	61508		37055	G63455		371128R	G57206	
34811	G64121		34972	G63610		37062	G63818		37113	61700	
34812	G64121		34972MM	G63610		37063	61555		371130	G57466	
34814	G63673		34975	G63511		37063	77375		371131	G57465	
34817	61525		34983	58489		37063	81713		371139	G57173	
34817	G63355		34983	61544		37064	77454		37114	61699	
34821	61547		34985	58488		37065	G63426		37116	G63622	
34821	G63406		34985	61543		37066	77915		37117	G63623	
34822	G63306		37011	G63414		37068	G63905		37118	G63414	
34824	61524		37013	77525		37070	G63799		37120	G63511	
34828	G63510		37013	G63525		37072	61529		37121	G63490	
34831	61523		37014	77524		37073	G63173		37122	G63678	
34839	58357		37014	G63524		37073	G63419		37122ST	G63678	
34839	61517		37015	G63614		37073	G63907		37123	G63690	
34853	61632		37015ST	G63614		37073ST	G63907		37125	G63489	
34895	83207	89407	37016	G63635		37074	G63620		37128	58622	
34895	89407		37018	G63614		37077	77909		37128	58929	
34900	61521		37019	58421		37077ST	G63909		37128	G63929	
34900	G63386		37019	61504		37078	77907		37129	G63421	
34901	G63387		37019	81750		37080	G63624		37130	G63609	
34904	G63299		37021	58422		37081	61535		37130	G63818	
34905	61500		37022	G63495		37081ST	G63424		37131	G63714	
34905	G63405		37022	G63611		37082	G63683		37132	G63778	
34905MM	61500		37022ST	G63611		37083	61535		37133	77716	

Important Note: Competitive Interchanges are to be used for stocking purposes only. Where multiple crosses are identified, please reference the applications section of this catalog. / **Remarque importante:** Les interchanges concurrentiels ne s'utilisent qu'aux fins de stocks. Dans le cas de rferences multiples, consulter la section des applications du catalogue. / **Nota importante:** Dans le cas de rferences multiples, consulter la section des applications du catalogue. / **Nota importante:** Se pueden usar intercambios competitivos para propósitos de almacenamiento solamente. Cuando se identifican intercambios múltiples, consulte la sección de aplicaciones de este catálogo.

COMPETITIVE & O.E.M. INTERCHANGE LIST
Lista de Intercambios contra Competidores y Equipo Original.
Liste dinterchange de produits comptitifs & dquipement original (OEM)

Monroe... cont'd

Monroe	Gabriel	Upgrade	Monroe	Gabriel	Upgrade	Monroe	Gabriel	Upgrade	Monroe	Gabriel	Upgrade
37133	G63716		37191	G63615		37272	70000		37370	G64050	
37134	G63715		37197	G63506		372729	G57745		37377	70210	
37135	G63722		37198	G63694		37273	G64031		37379	70213	
371358	G57092		37199	61651		372730	G57744		37803	G63306	
371358	G57118		37199	69813		37274	G64033		39002	69996	
37137	G63915		37202	61703		37275	69594		39004	69677	
37138	G63403		37203	G63844		37276	69595		39006	69766	
37140	G63403		37204	G63845		37279	G63889		39020	69952	
37144	61614		37206	G63958		37280	G64006		39021	69966	
37145	G63717		37207	58412		37281	G64032		39027	70024	
371453	G57349		37207	61692		37282	G51798		39040	70040	
371454	G57350		37208	77947		37283	G51803		39042	70065	
37146	G55821		37217	69900		37284	G51804		39043	70064	
37147	G63778		37218	69909		37284	G51992		39047	70033	
37148	G63715		37219	G64049		37285	61711		39050	70033	
37149	G63783		37220	G63905		37286	61696		39051	G64046	
37149ST	G63783		372215	G57659		37287	61697		39052	61777	
37150	58662		372216	G57658		37288	70010		39102	69946	
37150	61600		37225	G64027		372888	G57583		39104	G51891	
37150	77662		37226	G64028		372889	G57582		39105	61690	
37150	81873		372297	G57276		37289	G64026		39106	G51891	
37151	G63803		37231	G63720		37289	G64151		39107	70034	
37151ST	G63803		37232	G63506		37290	G64042		39111	G511001	
37152	G63675		37233	G63506		37298	G64038		39112	G51949	
37152ST	G63675		37234	G63694		37301	G511007		39112	G64101	
37153	77772		372367	G57463		37302	G64037		39113	G51746	
37153	G63772		372368	G57464		37307	G64071		39114	70031	
37154	G63717		37237	69907		37308	G64052		39130	70038	
37155	G63676		37238	G63815		37309	G64080		39131	G51921	
37156	G63776		37239	77815		37310	G511004		39132	G51920	
37156	G63869		37240	G64087		37313	G64056		39133	G51922	
37157	77726		37241	G63842		37315	G64040		39136	G51901	
37158	61609		37242	61717		37316	70010		39138	G51921	
37159	G63611		37243	G63610		37317	G51884		39139	G51920	
37160	G63710		37244	G63864		37318	G64047		400295	G56887	
37161	G63847		37245	61662		37320	61500		400296	G56886	
37162	G63829		37246	61704		37320	81147		400312	G51279	
37163	G63783		37247	G63615		37322	70203		400426	G56672	
37163	G63817		372471L	G56924		37323	70078		400427	G56671	
37164	G63675		372471R	G56925		37326	G51966		40046	49254	
37166	G63866		37248	G63694		37327	G64111		400525	G56606	
371662L	G56924		372489	G57659		37328	G64050		400964	G55697	
371662R	G56925		372490	G57658		37329	G51996		471128L	G57206	
37171	61662		37251	G63878		37334	G64146		471128R	G57206	
37172	61506		37252	G63883		37336	G511122		471311	G57075	
37177	77678		372526	G57550		37338	G64056		471358	G57092	
37178	58803		372527	G57549		37339	G64104		471377	G57083	
37178	61643		37253	G63875		37341	G64216		471453	G57349	
37178	81922		372565	G57340		37342	G63828		471454	G57350	
37181	58817		372566	G57339		37352	G511122		471662L	G56924	
37181	61663		372663	G57378		37352	G511123		471662R	G56925	
37181	81925		372664	G57377		37358	G511038		472367	G57463	
37183	G63832		37269	G64105		37361	G64163		472368	G57464	
37184	G63828		37270	G63885		37361	G64186		472401	G57607	
37187	82035		37270	G64029		37363	G511043		472471L	G56924	
37191	G63506		37270	G64030		37367	G64063		472471R	G56925	

Important Note: Competitive Interchanges are to be used for stocking purposes only. Where multiple crosses are identified, please reference the applications section of this catalog./ **Remarque importante:** Les interchanges concurrentiels ne s'utilisent qu'aux fins de stocks. Dans le cas de rferences multiples, consulter la section des applications du catalogue./ **Nota importante:** Dans le cas de rferences multiples, consulter la section des applications du catalogue./ **Nota importante:** Se pueden usar intercambios competitivos para propósitos de almacenamiento solamente. Cuando se identifican intercambios múltiples, consulte la sección de aplicaciones de este catálogo.

COMPETITIVE & O.E.M. INTERCHANGE LIST
Lista de Intercambios contra Competidores y Equipo Original.
Liste dinterchange de produits comptitifs & dquipement original (OEM)

Monroe... cont'd

Monroe	Gabriel	Upgrade	Monroe	Gabriel	Upgrade	Monroe	Gabriel	Upgrade	Monroe	Gabriel	Upgrade
472526	G57550		555031	G63622		5615	70049		5760	82609	
472527	G57549		555032	G63623		5616	70045		5762	82615	
472534	G57496		555033	G63386		5617	70056		5765	82118	
472535	G57495		555034	G63387		5618	70039		5766	82051	
472597	G57330		555035	G63357		5621	70036		5777	69585	
472598	G57329		555036	77403		5622	70037		5778	69590	
472653	G57746		555038	77403		5624	70055		5779	69587	
472654	G57747		555041	G63866		5626	70041		5780	69589	
472663	G57378		555043	83400		5629	70086		5783	69593	
472664	G57377		555045	G63394		5630	70052		5784	69591	
481311	G57422		557001	83209	89414	5637	70089		5795	G51812	
482401	G57607		557001	85013	89414	5639	70027		5796	69464	
482597	G57330		557001	89414		5645	G511002		5797	70086	
482598	G57329		557002	83125		5645	G511134		5799	69585	
550010	G63375		557004	G63866		5645	G511135		5799	70001	
550011	69606		557005	83136		5646	70068		5801	69675	
550016	G63424		557006	83136		5646	70209		5802	69604	
550017	G63425		557007	83122	89406	5647	70059		5802	69724	
550018	69574		557007	85010		5647	70204		5803	81340	
550018	69575		557007	89406		5648	70096		5803	82066	
550019	G63918		557008	85029		5659	70089		5804	69600	
550051	43140		557009	85007		5662	G51982		5809	82069	
550061	58412		557010	83144		5663	G51971		5809	82126	
5504	G51807		557011	83160		5667	G51965		5811	82011	
551001	83125		557012	83204		5668	69587		5815	82601	
551002	83122	89406	557012	85029		5671	70098		5818	69606	
551002	89406		557013	83127		5671	70102		5818	82155	
5511	70052		557014	83126	89430	5672	70095		5819	82004	
5518	G51993		557014	89430		5672	70208		5820	69724	
552001	G63959		557015	83209	89414	5673	G51990		5820	81514	
5521	69590		557015	89414		5681	70045		5820	82602	
5525	G511044		557017	85029		5682	G511037		5823	81491	
5528	G51799		557018	83127		5683	G51983		58241	34036	
5529	G51799		557020	83123	89405	5685	70053		58253	34058	
5530	G511078		557020	89405		5687	70053		5826	81270	
553001	79900		557021	85051		5697	G51983		58263	34073	
553002	G56778		557022	85051		5698	G511092		5827	G511142	
553003	G57802		557023	83144		5699	G511030		58270	34051	
5532	G511044		557026	83127		571128L	G57206		58273	34073	
5540	70207		557027	83144		571128R	G57206		58275	34057	
555004	G63299		557028	85010		571377L	G57083		5831	69624	
555005	G63689		557031	85010		571377R	G57083		5840	69600	
555006	G63173		557033	85900		572367	G57464		58411	43060	
555010	77623		557038	85125		572368	G57463		5845	69755	
555011	83119		557039	85959		572526	G57550		5847	69755	
555012	G63183		5600	G51802		572527	G57549		5850	69622	
555019	85069	89455	5601	70028		572597	G57330		58510	43140	
555019	89455		5602	G51904		572598	G57329		58518	43099	
555026	83124	89407	5603	G51871		572889	G57582		58523	43162	
555026	89407		5605	70060		5751	82026		58567	43048	
555027	83124	89407	5607	70003		5753	82039		58568	43140	
555027	89407		5609	G51807		5754	69600		58574	43049	
555028	83207	89407	5611	G51799		5754	82138		58574	43060	
555028	89407		5612	70086		5756	82070		58578	43111	
555029	83144		5613	69945		5757	82060		58592	43058	
555031	77614		5614	70013		5759	82087		58595	43085	

Important Note: Competitive Interchanges are to be used for stocking purposes only. Where multiple crosses are identified, please reference the applications section of this catalog. / **Remarque importante:** Les interchanges concurrentiels ne s'utilisent qu'aux fins de stocks. Dans le cas de références multiples, consulter la section des applications du catalogue. / **Nota importante:** Dans le cas de références multiples, consulter la section des applications du catalogue. / **Nota importante:** Se pueden usar intercambios competitivos para propósitos de almacenamiento solamente. Cuando se identifican intercambios múltiples, consulte la sección de aplicaciones de este catálogo.

COMPETITIVE & O.E.M. INTERCHANGE LIST
Lista de Intercambios contra Competidores y Equipo Original.
Liste dinterchange de produits comptitifs & dquipement original (OEM)

Monroe... cont'd

Monroe	Gabriel	Upgrade	Monroe	Gabriel	Upgrade	Monroe	Gabriel	Upgrade	Monroe	Gabriel	Upgrade
58600	43163		63620	143058		65139	89449		65400	89427	
58601	43167		63621	143059		65140	85918	89449	65400MOR	85033	89427
58606	43180		63628	143064		65140	89449		65400MM	85033	89427
58610	43181		63630	143058		65141	85014		65400MM	89427	
58612	43180		63631	143057		65142	83131		65401	85013	89414
58615	43181		63973	143057		65143	83163		65401	89414	
58617	43171		65101	85062	89408	65144	85928		65402	85311	89424
58618	43167		65101	89408		65144MOR	85928		65402	89424	
58636	43181		65101MOR	85062	89408	65145	85671		65402MOR	85311	89424
58637	43181		65102	85001	89410	65145	85929		65404	85310	89423
58654	43181		65102	89410		65146	85648		65404	89423	
5867	69676		65102MOR	85001	89410	65147	85924	89457	65404MOR	85310	89423
5867	75676		65103	85320	89429	65147	89457		65405	85023	89415
5868	69787		65103	89429		65147MOR	85924	89457	65405	89415	
5892	69714		65103MOR	85320	89429	65148	85918	89449	65405MOR	85023	89415
5892	69811		65103MM	85320	89429	65148	89449		65406	85024	
5893	69715		65103MM	89429		65148MOR	85918	89449	65407	85736	
5906	69625		65105	85026		65153	85921		65408	85319	89428
5928	69757		65106	83124	89407	65155	83175		65408	89428	
5939	69795		65106	89407		65156	85005	89430	65409	85003	89411
5947	69725		65107	85316	89426	65156	89430		65409	89411	
5955	69724		65107	89426		65157	85954		65409MOR	85003	89411
5959	69632		65107MOR	85316	89426	65158	85954		65410	85300	89419
5960	69675		65108	85030	89440	65158MOR	85954		65410	89419	
5961	69606		65108	89440		65159	85070	89459	65411	85036	89405
5962	69632		65109	85058	89431	65159	89459		65411	89405	
5965	69845		65109	89431		65159MOR	85070	89459	65412	83122	89406
5966	69724		65110	85005	89430	65159MM	85070	89459	65412	89406	
5967	69606		65110	89430		65159MM	89459		65413	83136	
5968	69898		65110MOR	85005	89430	65160	85080		65415	85046	89434
5969	61555		65110MM	85005	89430	65161	83136		65415	89434	
5969	69675		65110MM	89430		65162	85959		65416	85000	89436
5969	81713		65111	85006		65162MOR	85959		65416	89436	
5971	69962		65112	89402		65163	85954		65416MOR	85000	89436
5974	69863		65113	85012	89413	65164	85649		65416MM	85000	89436
5975	69901		65113	89413		65166	85090		65416MM	89436	
5980	69903		65113MOR	85012	89413	65167	58944		65417	85322	
5981	69725		65114	85036	89405	65167	G63969		65418	85906	89407
5981	69863		65114	89405		65168	77968		65418	89407	
5982	69903		65115	85027		65171	85964		65419	83389	89436
5984	69945		65116	85329		65172	89413		65419	85000	89436
5986	69465		65116MM	85329		65175	85084	89460	65419	89436	
5987	69450		65118	85001	89410	65175	89460		65419MOR	85000	89436
5988	69863		65118	89410		65175MOR	85084	89460	65420	85013	89414
5989	69473		65119	85029		65176	85084	89460	65420	89414	
5991	70020		65120	85010		65176	89460		65420MOR	85013	89414
5993	69575		65122	85063		65177	85012	89413	65421	85916	89430
5994	69575		65123	85054		65177	89413		65421	89430	
5996	69420		65124	85053	89442	65179	85995		65426	85054	
5998	69863		65124	89442		65180	85639		65428	85321	
6025	83122	89406	65128	85031		65181	85650		65429	85030	89440
6025	89406		65130	85061	89450	65183	85181		65429	89440	
6026	83204		65130	85061	89502	65184	85180		65430	85712	
63618	143058		65130	89502		65185	85180		65431	85909	
63619	143057		65133	85935		65186	85637		65432	85910	
63619	143061		65139	85918	89449	65400	85033	89427	65433	85910	

Important Note: Competitive Interchanges are to be used for stocking purposes only. Where multiple crosses are identified, please reference the applications section of this catalog. / **Remarque importante:** Les interchanges concurrentiels ne s'utilisent qu'aux fins de stocks. Dans le cas de rferences multiples, consulter la section des applications du catalogue. / **Nota importante:** Dans le cas de rferences multiples, consulter la section des applications du catalogue. / **Nota importante:** Se pueden usar intercambios competitivos para propósitos de almacenamiento solamente. Cuando se identifican intercambios múltiples, consulte la sección de aplicaciones de este catálogo.

COMPETITIVE & O.E.M. INTERCHANGE LIST
Lista de Intercambios contra Competidores y Equipo Original.
Liste dinterchange de produits comptitifs & dquipement original (OEM)

Monroe... cont'd

Monroe	Gabriel	Upgrade	Monroe	Gabriel	Upgrade	Monroe	Gabriel	Upgrade	Monroe	Gabriel	Upgrade
65434	85012	89413	65485MM	85972		65524M0R	85936	89456	66122M0R	83038	
65434	89413		65486	85066	89448	65525	87015		66123	83004	
65434M0R	85012	89413	65486	89448		65526	85956		66124	83040	
65435	85901		65486M0R	85066	89448	65527	85955		66125	83035	
65436	85900		65487	85927		65528	85069	89455	66125M0R	83035	
65436M0R	85900		65488	85656		65528	89455		66126	83051	
65439	85716		65489	85331		65528M0R	85069	89455	6613	83123	89405
65440	85711		65490	85724	89443	65530	85932	89453	6613	89405	
65441	85704		65490	89443		65530	89453		66131	83062	
65442	85700		65490M0R	85724	89443	65530M0R	85932	89453	66132	83001	
65444	85311	89424	65492	85931	89458	65531	85334		66138	619501	
65444	89424		65492	89458		65532	85967		6614	83125	
65444M0R	85311	89424	65492M0R	85931	89458	65534	85343		66142	83039	
65448	85700		65493	85934		65535	85954		66143	83007	
65449	85702		65494	85061	89450	65536	85965		66145	83008	
65451	85029		65494	85061	89502	65537	85962		66147	83009	
65452	85733		65494	89502		65539	85961		66147MM	83009	
65453	85043		65494M0R	85061	89450	65540	85959		66149	83022	
65454	85030	89440	65494M0R	85061	89502	65541	85119		6615	83120	
65454	89440		65495	85067	89451	65541M0R	85119		66150	83003	
65455	85716		65495	89451		65542	85102		66152	83012	
65456	85376		65495M0R	85067	89451	65543	85724	89443	66157	83015	
65457	85909		65497	85933	89454	65543	89443		66159	83031	
65458	85908		65497	89454		65547	85650		66159M0R	83031	
65459	85043		65498	85964		65548	85106		66160	83054	
65461	85059		65499	85963		65549	85642		66161	83054	
65463	85040		65500	85738		65552	85188		66162	83025	
65464	85716		65501	85323	89436	65554	85670		66169	83027	
65465	85939		65501	89436		6603	83103		66178	83023	
65466	85047	89435	65502	85938		6604	83101		66179	83013	
65466	89435		65503	85919		6605	83613		66181	83025	
65467	85054		65504	85072		6607	85052		66182	83005	
65468	85069	89455	65504M0R	85072		6608	83128	89436	66189	83041	
65468	89455		65505	83147		6608	89436		66189MM	83041	
65468M0R	85069	89455	65505M0R	83147		6609	83635		66193	83034	
65469	85708		65506	83168		6610	85051		66196	83027	
65470	85708		65507	83143		66101	83042		66198	83158	
65471	85302	89420	65508	83142		66101M0R	83042		66199	83048	
65471	89420		65509	85079		66102	83059		66200	83066	
65473	85329		65510	85052		66104	83021		66201	83081	
65474	85712		65511	85939		66105	83044		66201M0R	83081	
65475	85065		65511M0R	85939		66106	83016		66204	83024	
65476	85736		65512	85938		66107	83048		66209	83040	
65477	85702		65512M0R	85938		66108	83028		66400	G63432	
65478	85058	89431	65513	85338		66109	83048		66402	83157	
65478	89431		65514	89405		66111	83016		66403	83154	
65479	83122	89406	65515	83125		66112	83017		66405	83154	
65479	89406		65516	85013	89414	66113	83050		66406	85920	89503
65480	83111		65516	89414		66114	83045		66406	89503	
65481	85036	89405	65519	85060		66115	83045		66407	83134	
65481	89405		65521	85014		66116	83018		66412	83169	
65482	85006		65522	85082		66117	83019		66414	G64089	
65482M0R	85006		65523	85937		66118	83001		66415	G63918	
65483	85978		65523M0R	85937		66120	85006		66418	85918	89449
65484	85976		65524	85936	89456	66121	83047		66418	89449	
65485	85972		65524	89456		66122	83038		66419	85931	89458

Important Note: Competitive Interchanges are to be used for stocking purposes only. Where multiple crosses are identified, please reference the applications section of this catalog. / **Remarque importante:** Les interchanges concurrentiels ne s'utilisent qu'aux fins de stocks. Dans le cas de références multiples, consulter la section des applications du catalogue. / **Nota importante:** Dans le cas de références multiples, consulter la section des applications du catalogue. / **Nota importante:** Se pueden usar intercambios competitivos para propósitos de almacenamiento solamente. Cuando se identifican intercambios múltiples, consulte la sección de aplicaciones de este catálogo.

COMPETITIVE & O.E.M. INTERCHANGE LIST
Lista de Intercambios contra Competidores y Equipo Original.
Liste dinterchange de produits comptitifs & dquipement original (OEM)

Monroe... cont'd

Monroe	Gabriel	Upgrade	Monroe	Gabriel	Upgrade	Monroe	Gabriel	Upgrade	Monroe	Gabriel	Upgrade
66419	89458		66604	83101		66666	G63671		66871	G63605	
66420	G64164		66605	83613		66668	83312	89409	66878	83221	
66422	83163		66607	85052		66668	89409		66878M0R	83221	
66422M0R	83163		66608	83128	89436	66669	83111		66883	83314	
66423	85001	89410	66608	83389	89436	66670	89402		66884	83125	
66423	89410		66608	89436		66671	83123	89405	66884M0R	83125	
66423M0R	85001	89410	66608M0R	83128	89436	66671	89405		66886	83124	89407
66424	85310	89423	66609	83635		66672	83209	89414	66886	89407	
66424	89423		66610	83130		66672	89414		66886M0R	83124	89407
66425	85920	89503	66611	83016		66675	83515		66891	83215	
66425	89503		66612	83017		66677	83114		66893	83203	89436
66426	85924	89457	66613	83123	89405	66678	83023		66893	89436	
66426	89457		66613	89405		66679	83013		66893M0R	83203	89436
66428	85033	89427	66614	83125		66680	83317		66894	83137	
66428	89427		66615	83120		66681	83025		66897	83126	89430
66429	85311	89424	66616	83018		66682	83005		66897	89430	
66429	89424		66617	83019		66683	83101		66898	83125	
66430	83309		66618	83159		66684	85007		66902	83401	
66431	85066	89448	66620	83162		66686	85014		66903	83400	
66431	89448		66623	83004		66692	83120		66913	83303	
66432	85319	89428	66624	83141		66693	83034		66921	83318	
66432	89428		66625	83162		66697	83164		66921MM	83318	
66433	85918	89449	66626	85071		66699	83113		66922	83301	
66433	89449		66627	85045		66701	83215		66923	83456	89447
66434	85069	89455	66627M0R	85045		66707	83215		66923	89447	
66434	89455		66628	83136		66710	83209	89414	66924	83244	
66435	83219		66629	83107		66710	89414		66924MM	83317	
66436	85067	89451	66630	83216		66710M0R	83209	89414	66956	83101	
66436	89451		66631	83140		66713	83105		66957	83225	
66438	83363		66632	83006		66714	83216		66966	85740	
66439	G64177		66633	83127		66714MM	83216		66969	83126	89430
66442	83150		66634	83203	89436	66715	85026		66969	89430	
66443	83150		66634	89436		66717	83515		66969	89430	
66445	83135		66634M0R	83203	89436	66717	85716		6701	83215	
66447	83180		66636	83127		66717MM	83515		6707	83215	
66448	85058	89431	66636M0R	83127		66719	83242		6710	83209	89414
66448	89431		66638	83123	89405	66720	85003	89411	6710	89414	
66451	G64177		66638	89405		66720	89411		6712	85040	
66452	G64177		66639	G63610		66721	83391		6713	83105	
66453	G64089		66642	G63866		66722	83518		6714	83216	
66454	83166		66643	83007		66811	83312	89409	6715	85026	
66455	83166		66645	83008		66811	89409		6717	G63616	
66458	83396		66646	83308		66813	83303		6718	85024	
66486	85066	89448	66647	83009		66828	83159		6719	83242	
66486	89448		66648	83112		66829	83103		6720	85003	89411
66502	646155		66650	83003		66833	83126	89430	6720	89411	
66502M0R	646155		66653	83515		66833	89430		6721	83103	
66503	646155		66656	83110		66841	83216		672526	G57198	
66504	632147		66657	83015		66841MM	83216		672527	G57197	
66506	646155		66658	85009		66858	G63183		6803	G63907	
66535	85062	89408	66659	83002		66860	83308		6803MM	G63907	
66535	89408		66660	85059		66860MM	83308		6811	83312	89409
6658	85009		66661	83123	89405	66861	83309		6811	89409	
66601	83114		66661	89405		66861MM	83309		6811MM	83312	89409
66602	G63610		66664	83215		66863	83314		6811MM	89409	
66603	83103		66665	83109		66868	83219		6817	G63355	

Important Note: Competitive Interchanges are to be used for stocking purposes only. Where multiple crosses are identified, please reference the applications section of this catalog. / **Remarque importante:** Les interchanges concurrentiels ne s'utilisent qu'aux fins de stocks. Dans le cas de rfrences multiples, consulter la section des applications du catalogue. / **Nota importante:** Dans le cas de rfrences multiples, consulter la section des applications du catalogue. / **Nota importante:** Se pueden usar intercambios competitivos para propósitos de almacenamiento solamente. Cuando se identifican intercambios múltiples, consulte la sección de aplicaciones de este catálogo.

COMPETITIVE & O.E.M. INTERCHANGE LIST
Lista de Intercambios contra Competidores y Equipo Original.
Liste d'interchange de produits comptitifs & d'equipement original (OEM)

Monroe... cont'd

Monroe	Gabriel	Upgrade	Monroe	Gabriel	Upgrade	Monroe	Gabriel	Upgrade	Monroe	Gabriel	Upgrade
6824	G63349		70034	85302	89420	71120	G51849		71360	G51772	
6828	83219		70034	89420		71124	G56838		71361	G51704	
6828MM	83219		70039	85303	89422	71125	G56839		71362	G51703	
6829	83103		70039	89422		71126	G51863		71364	G51899	
6833	83126	89430	70041	85305		71128	G52131		71367	G51773	
6833	89430		70042	85302	89420	71130	G52118		71369	G51719	
6839	G63357		70042	89420		71131	G52117		71370	G51729	
6841	83216		70088	85307		71133	G56598		71371	G51739	
6860	83308		70123	85716		71135	G52248		71372	G51738	
6860MM	83308		70127	85006		71136	G52247		71373	G51736	
6861	83309		70128	85006		71137	G51937		71377	G56807	
6863	83314		70162	85716		71138	G51860		71379	G51794	
6868	G63360		70163	85302	89420	71139	G51861		71380	G51286	
6878	83221		70163	89420		71140	G51865		71390	G51746	
6886	83124	89407	70164	85716		71141	G51864		71391	G52276	
6886	89407		70166	85301		71142	G51738		71398	G51723	
6891	83215		70300	85320	89429	71143	G51979		71404	G56540	
6893	83203	89436	70300	89429		71144	G51981		71405	G56539	
6893	89436		70312	85001	89410	71146	G51838		71406	G56641	
6894	83209	89414	70312	89410		71254	G56591		71407	G56640	
6894	89414		70315	85063		71256	G55804		71417	G51714	
6895	83204		70317	89402		71272	G51742		71418	G56684	
6897	83126	89430	70331	85314	89425	71281	G55825		71419	G56683	
6897	89430		70331	89425		71291	G55909		71424	G56633	
6898	83125		70332	83314		71292	G55910		71425	G56634	
6900	G63386		70334	85316	89426	71293	G51087		71426	G56672	
6901	G63387		70334	89426		71294	G51252		71427	G56671	
6901MM	G63387		70397	85006		71296	G51254		71433	G56622	
6902	83401		70402	85305		71297	G51252		71434	G56621	
6903	83400		70642	85300	89419	71304	G51097		71435	G56561	
6910	G63413		70642	89419		71307	G51729		71436	G56562	
6911	G63350		70644	85334		71309	G51759		71437	G55994	
6913	83303		70651	85013	89414	71311	G51268		71438	G55993	
6916	83123	89405	70651	89414		71312	G51279		71441	G56688	
6916	89405		70652	85030	89440	71313	G51254		71442	G56687	
6920	G63411		70652	89440		71321	G51722		71451	G56758	
6921	83318		70663	85013	89414	71322	G51724		71452	G56759	
6921MM	83318		70663	89414		71325	G51256		71453	G56581	
6922	83301		70691	85007		71326	G51713		71454	G56582	
6923	83456	89447	70720	85934		71327	G51727		71461	G56686	
6923	89447		70721	83125		71331	G51740		71462	G56685	
6927	G63409		71100	G51815		71332	69586		71485	G56802	
6945	G63421		71101	G51858		71334	G51742		71486	G56791	
6956	83101		71102	G51766		71340	G51700		71488	G56792	
6957	83225		71103	G51765		71341	G51718		71494	G56680	
6960	G63366		71105	G51854		71343	G56597		71495	G56679	
6969	83126	89430	71106	G51853		71346	G51887		71496	G56680	
6969	89430		71109	G511055		71347	G51477		71497	G56679	
6994	83122	89406	71110	G511054		71348	G51477		71505	G56516	
6994	89406		71111	G51758		71350	69998		71525	G56606	
70018	85303	89422	71112	G51881		71351	G51077		71547	G56571	
70018	89422		71113	G51767		71352	G51077		71548	G56637	
70021	85303	89422	71115	G51825		71353	G51850		71551	G52336	
70021	89422		71116	G511020		71356	G51841		71553	G56529	
70029	85308	89422	71117	G511019		71358	G51715		71554	G56530	
70029	89422		71119	G51855		71359	G51279		71565	G51267	

Important Note: Competitive Interchanges are to be used for stocking purposes only. Where multiple crosses are identified, please reference the applications section of this catalog. / **Remarque importante:** Les interchanges concurrentiels ne s'utilisent qu'aux fins de stocks. Dans le cas de références multiples, consulter la section des applications du catalogue. / **Nota importante:** Dans le cas de referencias multiples, consultar la sección de aplicaciones del catálogo. / **Nota importante:** Se pueden usar intercambios competitivos para propósitos de almacenamiento solamente. Cuando se identifican intercambios múltiples, consulte la sección de aplicaciones de este catálogo.

COMPETITIVE & O.E.M. INTERCHANGE LIST
Lista de Intercambios contra Competidores y Equipo Original.
Liste dinterchange de produits comptitifs & dquipement original (OEM)

Monroe... cont'd

Monroe	Gabriel	Upgrade	Monroe	Gabriel	Upgrade	Monroe	Gabriel	Upgrade	Monroe	Gabriel	Upgrade
71568	G56784		71954	G55661		72244	G51774		72313	G52143	
71569	G56785		71962	G55681		72245	G52098		72314	G52142	
71572	G56620		71964	G55697		72248	G51760		72315	G52275	
71573	G56616		71973	G55698		72248	G51947		72316	G52274	
71574	G56615		72114	G56660		72248	G51948		72321	G52116	
71577	G51728		72115	G56661		72249	G51761		72322	G51737	
71580	G55892		72116	G52014		72250	G51814		72324	G51847	
71581	G52238		72117	G52013		72251	G51813		72327	G52176	
71581	G56751		72122	G56655		72257	G56837		72328	G52175	
71582	G52237		72123	G51737		72258	G56836		72331	G51863	
71582	G56750		72135	G52113		72261	G51810		72332	G52118	
71583	G51255		72136	G52112		72261	G51811		72333	G52117	
71584	G52334		72138	G56817		72261	G51859		72336	G56889	
71585	G52333		72139	G56635		72263	G52006		72337	G52280	
71588	G56537		72140	G56636		72263	G52450		72338	G51916	
71589	G56538		72141	G56894		72264	G52005		72338	G56888	
71592	G55896		72142	G56894		72264	G52449		72339	G52145	
71593	G56568		72143	G56799		72265	G52165		72340	G52144	
71594	G56601		72144	G56800		72266	G52164		72341	G51832	
71599	G56565		72179	G56810		72267	G52009		72342	G51833	
71632	G56701		72183	G52436		72268	G52008		72343	G52151	
71639	G55911		72184	G52435		72269	G56841		72344	G52150	
71642	G51063		72185	G56678		72270	G56840		72347	G52169	
71652	G55879		72186	G56677		72271	G52033		72348	G52168	
71653	G55879		72191	G56643		72272	G52032		72359	G52396	
71654	G55879		72192	G56642		72275	G52007		72360	G52395	
71655	G55879		72195	G51810		72276	G52004		72363	G52106	
71656	G56513		72195	G51811		72278	G55948		72363	G52108	
71657	G56512		72203	G56809		72281	G51806		72364	G52105	
71661	G55948		72205	G56722		72288	G56843		72364	G52107	
71662	G55949		72206	G56721		72289	G56842		72365	G52106	
71669	G55856		72207	G56729		72290	G52153		72365	G52108	
71670	G55948		72208	G56728		72290	G52283		72366	G52105	
71671	G55949		72209	G56774		72291	G52152		72366	G52107	
71678	G56514		72210	G56773		72291	G52282		72367	G52082	
71679	G56506		72211	G56731		72292	G51856		72368	G52081	
71680	G55676		72212	G56730		72293	G51836		72371	G56893	
71681	G55675		72213	G56735		72295	G56887		72372	G56892	
71684	G56509		72214	G56734		72296	G56886		72373	G52018	
71685	G56509		72215	G56733		72297	G52155		72374	G52017	
71691	G55870		72216	G56732		72298	G52154		72378	G52095	
71698	G55820		72217	G52027		72299	G52159		72379	G52094	
71728	G56700		72218	G52026		72300	G52158		72384	G52104	
71803	G55551		72219	G56820		72301	G52161		72385	G52103	
71819	G55526		72220	G56819		72302	G52160		72390	G52097	
71822	G56718		72221	G56821		72303	G52163		72391	G52096	
71845	G55579		72222	G56822		72304	G52162		72392	G52122	
71852	G55772		72229	G52141		72305	G52157		72393	G52121	
71857	G55591		72230	G52140		72306	G52156		72394	G51795	
71858	G55591		72231	G52025		72307	G56889		72397	G51883	
71875	G55774		72236	G52108		72308	G56888		72397	G51969	
71932	G56518		72236	G56797		72309	G52104		72398	G51880	
71933	G55991		72237	G52107		72310	G52103		72399	G51908	
71951	G55999		72237	G56798		72311	G56899		72400	G51852	
71952	G55999		72240	G56672		72312	G52301		72401	G51842	
71953	G55662		72241	G56671		72312	G56899		72408	G51760	

Important Note: Competitive Interchanges are to be used for stocking purposes only. Where multiple crosses are identified, please reference the applications section of this catalog./ **Remarque importante:** Les interchanges concurrentiels ne s'utilisent qu'aux fins de stocks. Dans le cas de rfrences multiples, consulter la section des applications du catalogue./ **Nota importante:** Dans le cas de rfrences multiples, consulter la section des applications du catalogue./ **Nota importante:** Se pueden usar intercambios competitivos para propósitos de almacenamiento solamente. Cuando se identifican intercambios múltiples, consulte la sección de aplicaciones de este catálogo.

COMPETITIVE & O.E.M. INTERCHANGE LIST
Lista de Intercambios contra Competidores y Equipo Original.
Liste d'interchange de produits comptitifs & d'equipement original (OEM)

Monroe... cont'd

Monroe	Gabriel	Upgrade	Monroe	Gabriel	Upgrade	Monroe	Gabriel	Upgrade	Monroe	Gabriel	Upgrade
72408	G51761		72549	G56899		72742	G52367		74012	85736	
72408	G51947		72562	G51877		72747	G51900		74024	85308	89422
72408	G51948		72562	G51878		72755	G52143		74024	89422	
72423	G52185		72563	G51892		72756	G52142		74025	85303	89422
72424	G52184		72565	G52273		72763	G56735		74025	89422	
72433	G52250		72566	G52272		72764	G56734		74028	85302	89420
72434	G52249		72567	G51910		72778	G52256		74028	89420	
72437	G52300		72571	G511020		72779	G52255		74029	85308	89422
72438	G52299		72572	G511019		72780	G52131		74029	89422	
72443	G52261		72585	G52330		72870	G44748		74039	85303	89422
72444	G52260		72586	G52329		72888	G52352		74039	89422	
72445	G52183		72587	G52437		72889	G52351		74069	85301	
72446	G52182		72588	G52438		72894	G51848		74070	85716	
72466	G52019		72589	G55526		72895	G51848		74073	85320	89429
72471	G52244		72590	G55526		72896	G51848		74073	89429	
72476	G52349		72593	G55526		72905	G52122		74074	85722	
72477	G52348		72596	G51896		72906	G52121		74075	85712	
72478	G51928		72596	G51897		72917	G52258		74078	85027	
72480	G52298		72597	G52246		72918	G52257		74079	85708	
72481	G52297		72598	G52245		72920	G52261		74080	85332	
72482	G51934		72599	G51898		72921	G52260		74081	85727	
72483	G52202		72604	G52383		72922	G51901		74400	85700	
72484	G52201		72605	G52382		72934	G52494		74402	85711	
72485	G52204		72606	G52171		72935	G52495		74402MM	85711	
72486	G52203		72607	G52170		72936	G52525		74405	85300	89419
72491	G52188		72608	G52174		72937	G52524		74405	89419	
72492	G52187		72609	G52173		72950	G52082		74405MM	85300	89419
72493	G52210		72610	G52110		72951	G52081		74405MM	89419	
72494	G52209		72611	G52111		72952	G51842		74406	85712	
72497	G51879		72622	G56529		72955	G52171		74408	85702	
72506	G51926		72623	G56530		72956	G52170		74409	85310	89423
72507	G51925		72635	G52172		72957	G51972		74409	89423	
72508	G51908		72647	G52361		72974	G56758		74412	85704	
72509	G52149		72648	G52360		72975	G56759		74412MM	85704	
72510	G52148		72659	G52153		72976	G55948		74413	85700	
72511	G51848		72660	G52152		72977	G55948		74414	85723	
72518	G52125		72670	G52265		72980	G52106		74415	85318	
72524	G52256		72671	G52264		72981	G52105		74416	85705	89447
72525	G52255		72678	G52375		72984	G511003		74416	89447	
72526	G52128		72679	G52374		72991	G51898		74417	85311	89424
72527	G52127		72686	G52273		72997	G52174		74417	89424	
72528	G52279		72687	G52272		72998	G52173		74418	85709	
72529	G52278		72688	G52332		73029	G51916		74418MM	85709	
72530	G52129		72689	G52331		73030	G51975		74420	85003	89411
72531	G52130		72692	G51919		73045	G52188		74420	89411	
72532	G52398		72693	G51918		73046	G52187		74421	85708	
72533	G52399		72694	G51917		73074	G52410		74422	85733	
72538	G51849		72695	G51961		73075	G52411		74423	85712	
72539	G51849		72706	G52354		7315	G64040		74424	85308	89422
72540	G52406		72707	G52353		73226	G52281		74424	89422	
72541	G52254		72708	G52440		73264	G44461		74425	85724	89443
72542	G52253		72709	G52439		74001	85307		74425	89443	
72544	G52255		72731	G52314		74003	85314	89425	74426	85333	
72545	G52256		72733	G52314		74003	89425		74427	85308	89422
72547	G52200		72734	G52314		74004	85315		74427	89422	
72548	G52199		72741	G52368		74006	85304		74429	85919	

Important Note: Competitive Interchanges are to be used for stocking purposes only. Where multiple crosses are identified, please reference the applications section of this catalog. / **Remarque importante:** Les interchanges concurrentiels ne s'utilisent qu'aux fins de stocks. Dans le cas de références multiples, consulter la section des applications du catalogue. / **Nota importante:** Dans le cas de referencias multiples, consultar la sección de aplicaciones del catálogo. / **Nota importante:** Se pueden usar intercambios competitivos para propósitos de almacenamiento solamente. Cuando se identifican intercambios múltiples, consulte la sección de aplicaciones de este catálogo.

COMPETITIVE & O.E.M. INTERCHANGE LIST
Lista de Intercambios contra Competidores y Equipo Original.
Liste dinterchange de produits comptitifs & dquipement original (OEM)

Monroe... cont'd

Monroe	Gabriel	Upgrade	Monroe	Gabriel	Upgrade	Monroe	Gabriel	Upgrade	Monroe	Gabriel	Upgrade
74430	85340		801438	G55993		901942	142195		903974	142752	
74431	85341		801504	G56517		901950	142244		903977	142755	
74432	85970		801505	G56516		901952	142173		903986	143466	
74433	85331		801525	G56606		901958	142249		903987	143465	
74434	85711		801565	G51267		901962	142250		903991	142836	
74435	85736		801572	G56620		901964	142245		903995	143367	
74436	85334		801580	G55892		901965	142135		904900	143325	
74438	85734		801592	G55896		901966	142252		904903	143191	
74439	85728		801616	G55901		901966	142573		904904	143191	
74439MM	85728		801661	G55948		901967	142247		904905	142651	
74440	85729		801662	G55949		901975	143277		904909	142653	
74441	85339		801669	G55856		901980	142842		904909	143380	
74442	85727		801678	G56514		901999	142852		904912	143059	
74451	85711		801679	G56506		902906	142444		904916	142567	
74452	85740		801680	G55676		902907	142840		904918	143197	
74453	85339		801681	G55675		902923	142419		904932	143204	
74454	85314	89425	801691	G55870		902924	143492		904935	143201	
74454	89425		801728	G56700		902926	142561		904942	142524	
74454MM	85314	89425	801770	G55526		902927	142439		904954	143218	
74454MM	89425		801803	G55551		902932	142317		904955	143209	
74462	85346		801819	G55526		902939	142855		904957	143087	
74464	85318		801822	G56718		902946	143320		904968	143241	
74465	85708		801845	G55579		902951	142404		904973	143317	
74466	85318		801855	G55526		902952	142403		904974	143244	
74467	85723		801857	G55591		902953	142843		904975	143315	
74469	85345		801858	G55591		902954	142402		904979	142949	
74471	85736		801875	G55774		902954	142843		904980	143227	
74472	85303	89422	801897	G51267		902958	142329		904984	143464	
74472	89422		801932	G56518		902968	143071		904988	143194	
74473	85716		801933	G55991		902968	143074		904989	143202	
74474	85916	89430	801951	G55999		902969	143072		904990	143094	
74474	89430		801952	G55999		902969	143073		905902	143266	
74480	85351		801953	G55662		902973	142526		905903	143255	
75934	G52495		801954	G55661		902984	142625		905904	143305	
75935	G52494		801962	G55681		902991	143063		905906	143239	
801256	G55804		801964	G55697		902992	142316		905907	143323	
801281	G55825		801973	G55698		9039005	142569		905908	143355	
801291	G55909		802179	G56810		903902	142828		905909	143354	
801292	G55910		802236	G56797		903903	142649		905910	143316	
801293	G51087		802248	G51760		903906	142650		905912	143281	
801296	G51254		802248	G51761		903910	142546		905913	143385	
801311	G51268		802275	G52007		903911	142547		905914	143324	
801312	G51279		802276	G52004		903915	142735		905915	143341	
801326	G51713		872526	G57198		903918	143082		905916	143397	
801340	G51700		872527	G57197		903920	143263		905922	143364	
801341	G51718		901903	142091		903923	143259		905923	143419	
801347	G51477		901904	142444		903924	143256		905930	143408	
801351	G51077		901908	142567		903926	142932		905936	143388	
801352	G51077		901908	142933		903928	142930		905937	143387	
801358	G51715		901922	142530		903932	143459		905944	143088	
801377	G56807		901933	142850		903942	142643		905945	143394	
801426	G56672		901940	142230		903954	142938		905948	143089	
801427	G56671		901940	142419		903966	142745		905953	143418	
801433	G56622		901940	143030		903967	142746		905966	143369	
801434	G56621		901940	143423		903968	142747		905966	143468	
801437	G55994		901941	142251		903973	142751		905969	143335	

Important Note: Competitive Interchanges are to be used for stocking purposes only. Where multiple crosses are identified, please reference the applications section of this catalog./ **Remarque importante:** Les interchanges concurrentiels ne s'utilisent qu'aux fins de stocks. Dans le cas de rfrences multiples, consulter la section des applications du catalogue./ **Nota importante:** En el caso de rfrences multiples, consulte la seccion de aplicaciones del catalogo./ **Nota importante:** Se pueden usar intercambios competitivos para propósitos de almacenamiento solamente. Cuando se identifican intercambios múltiples, consulte la seccion de aplicaciones de este catalogo.

COMPETITIVE & O.E.M. INTERCHANGE LIST
Lista de Intercambios contra Competidores y Equipo Original.
Liste d'interchange de produits compétitifs & d'équipement original (OEM)

Monroe... cont'd

Monroe	Gabriel	Upgrade	Monroe	Gabriel	Upgrade	Monroe	Gabriel	Upgrade	Monroe	Gabriel	Upgrade
905980	143363		911021	77422		911178	58803		911304	G511000	
905983	143342		911030	G63479		911178	61643		911304	G511038	
905985	143455		911034	G63410		911178	81922		911330	G51980	
906914	142937		911035	77679		911181	G63817		911331	G63867	
906917	143321		911038	77461		911183	G63832		911331	G64157	
906918	143318		911039	G63456		911184	G63828		911332	G64079	
906919	143353		911043	G63609		911186	77954		911334	G64157	
906920	143353		911044	58488		911187	G63961		911335	G64079	
906927	143319		911044	61543		911187	G63962		911447	G64148	
906936	142556		911044	81667		911188	G63848		911501	77803	
906958	143336		911050	58489		911190	G63609		911502	77412	
906959	143496		911050	61544		911192	77675		911503	77783	
906962	143415		911050	81668		911193	61635		911504	77662	
906967	143477		911052	G63406		911194	G63808		911505	77803	
906968	143416		911055	77455		911195	58809		911506	77953	
906969	143410		911080	G63624		911195	61655		911506	77975	
906970	143409		911085	G63896		911195	77809		911507	77817	
906977	143458		911086	G63897		911196	77810		911508	G64000	
906980	143365		911096	G63360		911198	G63673		911509	77971	
906980	143422		911099	77423		911220	G63905		911510	61717	
906981	143531		911102	77661		911221	77949		911511	77609	
906982	143412		911103	G63662		911222	77950		911512	77488	
906983	143404		911104	77673		911223	77948		911513	77489	
906987	143343		911128	77608		911226	G64028		911514	77423	
906988	143343		911131	77714		911228	G63882		911517	77422	
906990	143422		911132	G63778		911229	G63884		911521	77715	
906996	143390		911133	G63716		911230	G63879		911522	77847	
906997	143391		911134	G63715		911251	G63878		911523	77829	
907922	143383		911140	77403		911252	G63883		911525	77683	
907923	143339		911144	61614		911253	G63875		911527	G64001	
907925	143325		911145	77717		911255	61684		911528	77983	
907932	143359		911149	61641		911256	61683		911529	G63813	
907934	143393		911149	81920		911257	G63895		911530	77907	
907937	143360		911150	58662		911258	61718		911533	77976	
907940	143361		911150	61600		911259	G64016		911534	77980	
907943	143406		911150	81873		911260	61734		911535	G64013	
907944	143357		911151	G63803		911261	G63870		911536	77981	
907947	143345		911152	58412		911262	G63867		911538	77973	
907949	143344		911152	61642		911265	61713		911539	77973	
907986	143366		911152	81921		911266	77951		911540	77978	
907986	143486		911152MM	G63675		911268	G63888		911545	77975	
907990	143425		911161	77847		911270	G63885		911546	77975	
907991	143460		911163	61641		911270	G64029		972526	G57198	
907994	143495		911163	81920		911270	G64030		972527	G57197	
907996	143399		911164	G63675		911273	G64031		AMS65101	85062	89408
908900	143564		911166	58930		911274	G64033		AMS65102	85001	89410
908910	143491		911166	61675		911276	69594		AMS65103	85320	89429
908944	143398		911166	81930		911277	G63890		AMS65106	83124	89407
908946	143349		911167	77953		911277	G63891		AMS65108	85030	89440
908947	143350		911168	G63675		911278	G64012		AMS65118	85001	89410
908953	143089		911171	G63813		911279	G63889		AMS65124	85053	89442
908965	143414		911172	G63492		911298	G64038		AMS65128	85031	
908966	143413		911173	77807		911299	G64044		AMS65140	85918	89449
908993	143474		911174	G63607		911300	G64043		AMS65142	83131	
908995	143473		911175	G63809		911302	G64079		AMS65143	83163	
909957	143201		911176	77837		911303	G64121		AMS65147	85924	89457

Important Note: Competitive Interchanges are to be used for stocking purposes only. Where multiple crosses are identified, please reference the applications section of this catalog. / **Remarque importante:** Les interchanges concurrentiels ne s'utilisent qu'aux fins de stocks. Dans le cas de références multiples, consulter la section des applications du catalogue. / **Nota importante:** Dans le cas de références multiples, consulter la section des applications du catalogue. / **Nota importante:** Se pueden usar intercambios competitivos para propósitos de almacenamiento solamente. Cuando se identifican intercambios múltiples, consulte la sección de aplicaciones de este catálogo.

COMPETITIVE & O.E.M. INTERCHANGE LIST
Lista de Intercambios contra Competidores y Equipo Original.
Liste dinterchange de produits comptitifs & dquipement original (OEM)

Monroe... cont'd

Monroe	Gabriel	Upgrade	Monroe	Gabriel	Upgrade	Monroe	Gabriel	Upgrade	Monroe	Gabriel	Upgrade
AMS65148	85918	89449	AMS65502	85938		AMS66893	83203	89436	MA817	49212	
AMS65155	83175		AMS65503	85919		AMS66897	83126	89430	MA819	49131	
AMS65157	85954		AMS65504	85072		AMS66923	83456	89447	MA822	49228	
AMS65159	85070	89459	AMS65505	83147		AMS66924	83317		MA822	49255	
AMS65162	85959		AMS65511	85939		AMS66956	83101		MA824	49230	
AMS65179	85995		AMS65512	85938		AMS66969	83126	89430	MA828	49235	
AMS65400	85033	89427	AMS65519	85060		AMS74405	85300	89419	MA829	49237	
AMS65402	85311	89424	AMS65522	85082		AMS74439	85728		MA834	49235	
AMS65404	85310	89423	AMS65523	85937		AMS74465	85708		MONRS55042	77951	
AMS65405	85023	89415	AMS65528	85069	89455	MA700	49205		MONRS55274	77412	
AMS65409	85003	89411	AMS65530	85932	89453	MA702	49131		MONRS55288	77817	
AMS65410	85300	89419	AMS66104	83021		MA704	49110		MONSC2955	6828SE	
AMS65411	85036	89405	AMS66115	83045		MA705	49105		OE10881	85711	
AMS65416	85000	89436	AMS66122	83038		MA706	49157		OE10882	85740	
AMS65419	85000	89436	AMS66126	83051		MA708	49135		OE10883	85339	
AMS65420	85013	89414	AMS66138	619501		MA711	49122		OE12425	83214	
AMS65431	85909		AMS66162	83025		MA717	49152		SA1930	6802SE	
AMS65434	85012	89413	AMS66403	83154		MA719	49128		SC-2920	83176	
AMS65435	85901		AMS66424	85310	89423	MA726	49173		SC2911	6804SE	
AMS65436	85900		AMS66445	83135		MA730	49127		SC2912	6802SE	
AMS65444	85311	89424	AMS66502	646155		MA733	49149		SC2913	14017	
AMS65451	85029		AMS66603	83103		MA743	49155		SC2913	6804SE	
AMS65459	85043		AMS66605	83613		MA751	49131		SC2915	6802SE	
AMS65468	85069	89455	AMS66607	85052		MA757	49106		SC2920	83176	
AMS65480	83111		AMS66608	83128	89436	MA758	49215		SC2928	14040	
AMS65481	85036	89405	AMS66613	83123	89405	MA759	49213		SC2928	6804SE	
AMS65482	85006		AMS66615	83120		MA762	49152		SC2936	6801SE	
AMS65483	85978		AMS66624	83141		MA764	49218		SC2937	6801SE	
AMS65484	85976		AMS66627	85045		MA765	49226		SC2953	6804SE	
AMS65486	85066	89448	AMS66628	83136		MA768	49221		SC2955	6828SE	
AMS65487	85927		AMS66634	83203	89436	MA769	49223		SC2961	6850SE	
AMS65489	85331		AMS66636	83127		MA776	49232		SC2961	6854SE	
AMS65490	85724	89443	AMS66648	83112		MA777	49178		SC2961	6855SE	
AMS65492	85931	89458	AMS66683	83101		MA779	49231		SC2962	14071	
AMS65492MM	85931	89458	AMS66710	83209	89414	MA784	49369		SC2963	6803SE	
AMS65493	85934		AMS66828	83159		MA785	49304		SC2963	6853SE	
AMS65494	85061	89450	AMS66833	83126	89430	MA789	49334		SC2964	6847SE	
AMS65494	85061	89502	AMS66861	83309		MA803	49307		SC2965	6856SE	
AMS65495	85067	89451	AMS66878	83221		MA805	49203		SC2967	14072	
AMS65499	85963		AMS66884	83125		MA810	49199		SC2970	14074	
AMS65500	85738		AMS66886	83124	89407	MA812	49311		SC2975	6828SE	
AMS65501	85323	89436	AMS66891	83215		MA815	49205				

MOOG

Moog	Gabriel	Upgrade	Moog	Gabriel	Upgrade	Moog	Gabriel	Upgrade	Moog	Gabriel	Upgrade
K160002	143354		K160092	143324		K160197	143495		K160229	143531	
K160003	143355		K160094	143335		K160198	143318		K160264	143406	
K160004	143425		K160096	143369		K160200	143564		K160265	143343	
K160012	143089		K160096	143468		K160201	143391		K160266	143383	
K160026	143418		K160097	143317		K160202	143390		K160271	143345	
K160028	143388		K160098	143316		K160209	143341		K160285	143064	
K160029	143387		K160099	143305		K160210	143363		K160288	143491	
K160049	143385		K160101	143416		K160211	143462		K160294	143366	
K160050	143364		K160104	143398		K160212	143461		K160294	143486	
K160051	143321		K160105	143455		K160214	143460				
K160052	143323		K160132	143344		K160225	143342				
K160056	143419		K160135	143319		K160228	143191				
K160089	143408		K160148	143422		K160228	143365				

Important Note: Competitive Interchanges are to be used for stocking purposes only. Where multiple crosses are identified, please reference the applications section of this catalog. / **Remarque importante:** Les interchanges concurrentiels ne s'utilisent qu'aux fins de stocks. Dans le cas de rferences multiples, consulter la section des applications du catalogue. / **Nota importante:** Dans le cas de rferences multiples, consulter la section des applications du catalogue. / **Nota importante:** Se pueden usar intercambios competitivos para propósitos de almacenamiento solamente. Cuando se identifican intercambios múltiples, consulte la sección de aplicaciones de este catálogo.

COMPETITIVE & O.E.M. INTERCHANGE LIST
Lista de Intercambios contra Competidores y Equipo Original.
Liste dinterchange de produits comptitifs & dquipement original (OEM)

MOOG... cont'd

Moog	Gabriel	Upgrade	Moog	Gabriel	Upgrade	Moog	Gabriel	Upgrade	Moog	Gabriel	Upgrade
K160297	143397		K90269	143082		ST8525R	G56950		ST8590R	G57035	
K160298	143477		K90289	143197		ST8527	G56936		ST8591	G57036	
K160316	142653		K90290	143325		ST8528	G56935		ST8592L	G57049	
K160334	143473		K90294	143259		ST8530	G56938		ST8592R	G57050	
K160368	143393		K90299	142949		ST8532	G57057		ST8595L	G57065	
K160369	143415		K90301	142938		ST8532	G57058		ST8595R	G57066	
K160383	142650		K90307	143191		ST8533L	G57010		ST8596L	G57011	
K160390	142649		K90323	143315		ST8533R	G57010		ST8596R	G57012	
K160392	143094		K90326	143209		ST8538L	G56996		ST8597L	G57047	
K16093	143321		K90327	143204		ST8538R	G56997		ST8597R	G57048	
K5338	142530		K90330	143201		ST8539	G56998		ST8598	G57172	
K6438	142244		K90462	143058		ST8540	G56934		ST8599	G57173	
K6440	142245		K90462	143059		ST8540	G56937		ST8601L	G57069	
K6443	142316		K90464	143061		ST8546L	G56930		ST8601L	G57121	
K6515	143459		K90648	143353		ST8546R	G56931		ST8601R	G57122	
K6521	142526		K90655	142937		ST8547	G57060		ST8602	G57039	
K6702	143241		K90658	143202		ST8548L	G56962		ST8602R	G57070	
K6725	142852		K9394	142091		ST8548T	G56963		ST8603	G57053	
k7175	142567		K9478	142249		ST8549	G56964		ST8604	G57132	
K7202	142842		K9492	142230		ST8550	G56927		ST8606	G57147	
K7215	142840		K9506	142250		ST8551	G56928		ST8608L	G57133	
K7226	142419		K9559	143492		ST8552L	G56991		ST8608R	G57134	
K7226	143394		K9565	142317		ST8552R	G56992		ST8609L	G57027	
K7226	143422		K9583	142444		ST8553	G56943		ST8609R	G57027	
K7372	143256		K9624	142135		ST8554	G56951		ST8611	G57095	
K7375	142932		K9632	142252		ST8555L	G57063		ST8612	G57096	
K7380	142828		K9642	142247		ST8555R	G57064		ST8615	G57118	
K7413	143423		K9692	142329		ST8560	G57051		ST8616L	G57123	
K7414	143423		K9711	142561		ST8562	G56965		ST8616R	G57124	
K7456	143087		K9713	142439		ST8563	G57018		ST8617L	G57112	
K80031	142930		K9775	142547		ST8564	G57022		ST8617R	G57113	
K80145	143357		K9778	142735		ST8565L	G57007		ST8618L	G57110	
K80218	143244		K9786	142546		ST8565R	G57008		ST8618R	G57111	
K80219	143244		K9789	142836		ST8566	G57015		ST8620	G57080	
K80902	143404		K9794	142625		ST8567	G57016		ST8622L	G57061	
K80907	143239		K9798	143465		ST8568	G57020		ST8622R	G57062	
K80915	143218		K9799	143466		ST8568	G57103		ST8626L	G57041	
K80917	143088		K9904	143281		ST8569L	G56924		ST8626R	G57042	
K80928	143194		SSD122	6861SE		ST8569R	G56925		ST8627L	G57043	
K80931	143191		SSD131	6856SE		ST8573	G57017		ST8627R	G57044	
K8693	142852		SSD56	14071		ST8573	G57019		ST8629L	G57114	
K8694	142404		SSD56	6801SE		ST8574L	G57030		ST8629R	G57115	
K8696	142403		ST8511	G57013		ST8574R	G57031		ST8631	G57142	
K8741	142843		ST8512	G57014		ST8578L	G57032		ST8632L	G57054	
K8743	142402		ST8513	G56995		ST8578R	G57033		ST8632R	G57055	
K90219	142643		ST8515L	G56932		ST8579L	G57045		ST8635	G57056	
K90222	143458		ST8515R	G56933		ST8579R	G57046		ST8638L	G57088	
K90238	143367		ST8519	G57006		ST8581	G56929		ST8638R	G57089	
K90239	142561		ST8524L	G56948		ST8582	G57021		ST8640L	G57167	
K90240	143191		ST8524R	G56948		ST8583	G57000		ST8640R	G57168	
K90241	142651		ST8525L	G56949		ST8590L	G57034				

Motorcraft

Motorcraft	Gabriel	Upgrade	Motorcraft	Gabriel	Upgrade	Motorcraft	Gabriel	Upgrade	Motorcraft	Gabriel	Upgrade
AA-229	G63773		AA-483	G63837		AA-494	83131				
AA-450	G63773		AA-484	G63837		AA-500	G63809				
AA-456	G63772		AA-485	G63837		AA-501	G63809				
AA-457	G63678		AA-486	G63607		AA-502	G63614				

Important Note: Competitive Interchanges are to be used for stocking purposes only. Where multiple crosses are identified, please reference the applications section of this catalog. / **Remarque importante:** Les interchanges concurrentiels ne s'utilisent qu'aux fins de stocks. Dans le cas de références multiples, consulter la section des applications du catalogue. / **Nota importante:** Dans le cas de referencias multiples, consultar la sección de aplicaciones del catálogo. / **Nota importante:** Se pueden usar intercambios competitivos para propósitos de almacenamiento solamente. Cuando se identifican intercambios múltiples, consulte la sección de aplicaciones de este catálogo.

COMPETITIVE & O.E.M. INTERCHANGE LIST
Lista de Intercambios contra Competidores y Equipo Original.
Liste d'interchange de produits compititifs & d'equipement original (OEM)

Motorcraft... cont'd

Motorcraft	Gabriel	Upgrade	Motorcraft	Gabriel	Upgrade	Motorcraft	Gabriel	Upgrade	Motorcraft	Gabriel	Upgrade
AA-503	G63614		ASH-12336	G51861		ASH-294	83209	89414	ASHV-1048	G63525	
AA-504	G63614		ASH-1255	70096		ASH-294	89414		ASHV-1049	G63524	
AA-615	83135		ASH-1256	70096		ASH-32	83125		ASHV-1050	G63608	
AA-616	83175		ASH-132	G63614		ASH-322	77969		ASHV-1051	G63837	
AA-617	85928		ASH-137	83122	89406	ASH-324	77968		ASHV-1056	G51722	
AD1002	143318		ASH-137	89406		ASH-335	G63969		ASHV-1056	G51723	
AD1043	143360		ASH-163	G51724		ASH-36	85716		ASHV-12	69962	
AD1050	143415		ASH-172	G51704		ASH-362	G63607		ASHV-13	G63676	
AD962	143318		ASH-224	G51704		ASH-363	G63525		ASHV-14	G63837	
AS-1086	G63678		ASH-23406	G56838		ASH-364	G63524		ASHV-3	G63714	
AS-413	G63414		ASH-23407	G56839		ASH-365	G63772		ASHV-4	G63716	
AS-433	G63406		ASH-23415	G63969		ASH-366	G63608		ASHV-6	G63809	
AS-485G	G63622		ASH-23454	G63614		ASH-37	85712		ASHV-7	69464	
AS-498G	G63608		ASH-23458	G63614		ASH-38	85314	89425	ASHV-8	69465	
AS-500G	G63624		ASH-23460	G63714		ASH-38	89425		ASHV-864	G63929	
AS1020G	G63386		ASH-23465	G511001		ASH-386	G63717		ASHV-865	G63808	
AS105	69606		ASH-24397	G63716		ASH-387	G63809		ASHV-866	G63810	
AS1055G	G63490		ASH-24401	G63809		ASH-39	85001	89410	ASHV-867	G63455	
AS200	G63350		ASH-24402	85928		ASH-39	89410		ASHV-868	G63406	
AS310	G63524		ASH-24407	G63867		ASH-391	G63809		ASHV-871	G63809	
AS954G	G63299		ASH-24408	G63717		ASH-394	G63614		ASHV-879	G63455	
ASH-1022	83209	89414	ASH-24411	G63717		ASH-397	83131		ASHV-9	G63375	
ASH-1022	89414		ASH-24425	G63624		ASH-398	85928		ASHV-992	G63679	
ASH-1023	83122	89406	ASH-24433	G63837		ASH-4	G63716		ASHV-995	G63414	
ASH-1023	89406		ASH-24434	G63607		ASH-407	G63809		ASHV-997	G63678	
ASH-1028	69592		ASH-24438	6828SE		ASH-408	G63809		AST-115	G56517	
ASH-1113	69593		ASH-24478	G56838		ASH-487	G63867		AST-159	G51859	
ASH-1121	G63873		ASH-24492	83175		ASH-51	G63773		AST-162	G51859	
ASH-1129	14072		ASH-24495	G63870		ASH-678	G63717		AST-177	69591	
ASH-1130	G63622		ASH-245	69900		ASH-684	G63623		AST-233	G56655	
ASH-1131	G63622		ASH-24524	G51836		ASH-69	83175		AST-235	G51849	
ASH-1132	G63622		ASH-24525	G51836		ASH-701	G51888		AST-236	G51849	
ASH-1135	G63623		ASH-24531	G51887		ASH-706	G63614		AST-260	G63929	
ASH-1136	G63623		ASH-24533	G51888		ASH-707	G63614		AST-266	G52110	
ASH-1154	G63622		ASH-24538	69575		ASH-712	69575		AST-268	G52111	
ASH-1155	G63623		ASH-24539	69574		ASH-759	G51729		AST-284	G56836	
ASH-1159	G64037		ASH-24548	G64111		ASH-787	G63870		AST-291	G56837	
ASH-1160	G64037		ASH-24659	85181		ASH-791	G51724		AST-311	G64047	
ASH-119	G63809		ASH-24660	85180		ASH-795	G63867		AST-369	G52129	
ASH-120	G63837		ASH-24667	G63676		ASH-797	G63867		AST-383	G56817	
ASH-1205	83209	89414	ASH-24676	G511001		ASH-820	G51723		AST-385	G56817	
ASH-1205	89414		ASH-24741	G51860		ASH-824	G63929		AST-405	G52130	
ASH-1206	83122	89406	ASH-25	83309		ASH-864	G63929		AST-422	G51897	
ASH-1206	89406		ASH-252	G63929		ASH-967	G51719		AST-423	G51896	
ASH-121	G63607		ASH-257	G51703		ASHV-1	G63678		AST-424	G51897	
ASH-122	G63614		ASH-25822	83209	89414	ASHV-1000	G63608		AST-443	G52130	
ASH-12221	70052		ASH-25822	89414		ASHV-1000	G63614		AST-449	G56817	
ASH-12222	70052		ASH-25823	83209	89414	ASHV-1014	69845		AST-451	G56817	
ASH-12277	69574		ASH-25823	89414		ASHV-1015	G63622		AST-472	G52399	
ASH-1228	83209	89414	ASH-25824	83122	89406	ASHV-1025	G63623		AST-474	G52399	
ASH-1228	89414		ASH-25824	89406		ASHV-1028	G63778		AST-477	G52398	
ASH-1230	83122	89406	ASH-25825	83122	89406	ASHV-1031	G63692		AST-66	G56516	
ASH-1230	89406		ASH-25825	89406		ASHV-1038	69675		AST-867	G52352	
ASH-12322	G51861		ASH-26	85006		ASHV-1039	69898		AST-867	G56841	
ASH-12326	G51861		ASH-2737	G51860		ASHV-1046	G63772		AST-868	G52351	
ASH-12335	G51861		ASH-29	83314		ASHV-1047	G63607		AST-868	G56840	

Important Note: Competitive Interchanges are to be used for stocking purposes only. Where multiple crosses are identified, please reference the applications section of this catalog. / **Remarque importante:** Les interchanges concurrentiels ne s'utilisent qu'aux fins de stocks. Dans le cas de rferences multiples, consulter la section des applications du catalogue. / **Nota importante:** Dans le cas de rferences multiples, consulter la section des applications du catalogue. / **Nota importante:** Se pueden usar intercambios competitivos para propósitos de almacenamiento solamente. Cuando se identifican intercambios múltiples, consulte la sección de aplicaciones de este catálogo.

COMPETITIVE & O.E.M. INTERCHANGE LIST
Lista de Intercambios contra Competidores y Equipo Original.
Liste dinterchange de produits comptitifs & dquipement original (OEM)

Motorcraft... cont'd

Motorcraft	Gabriel	Upgrade	Motorcraft	Gabriel	Upgrade	Motorcraft	Gabriel	Upgrade	Motorcraft	Gabriel	Upgrade
AST-871	G56841		AX-310	83215		CAT-793	G63414		CAX-720	85003	89411
AST-872	G56840		AX-327	G63773		CAT-802	G63419		CAX-720	89411	
AST-900	G52406		AX-332	85928		CAT-803	G63306		CAX-811	83312	89409
AST-902	G52406		AX-79A	83221		CAT-817	G63355		CAX-811	89409	
AST-903	G52406		AX-79A	85030	89440	CAT-824	G63349		CAX-828	83207	89407
AST-904	G52406		AX-79A	89440		CAT-828	G63494		CAX-828	85012	89413
AST-905	G52255		AX-85A	83219		CAT-831	G63359		CAX-828	89407	
AST-906	G52256		AX-97A	83122	89406	CAT-832	G63353		CAX-828	89413	
AST-910	G52351		AX-97A	85005	89430	CAT-839	G63357		CAX-833	83303	
AST-911	G52351		AX-97A	89406		CAT-853	G63183		CAX-833	85005	89430
AST-913	G52352		AX-97A	89430		CAT-868	G63360		CAX-833	89430	
AST-914	G52352		CAH-001	85307		CAT-895	83207	89407	CAX-841	83216	
ASTV-25	G55681		CAH-001	85711		CAT-895	89407		CAX-860	83308	
ASTV-31	G55901		CAH-003	83215		CAT-900	G63386		CAX-861	83309	
AT-110	G63387		CAH-006	85304		CAT-901	G63387		CAX-863	83314	
AT-147	G63350		CAH-012	85736		CAT-904	G63299		CAX-878	83221	
AT-163G	G63622		CAH-025	85007		CAT-905	G63405		CAX-886	83207	89407
AT-164G	G63623		CAH-028	85302	89420	CAT-907	G63511		CAX-886	85014	
AT-504G	G63679		CAH-028	89420		CAT-910	G63413		CAX-886	89407	
AT-506G	G63679		CAH-029	85308	89422	CAT-911	G63350		CAX-891	83215	
AT-507G	G63607		CAH-029	89422		CAT-912	G63625		CAX-891	85314	89425
AT-546	G63678		CAH-069	83219		CAT-919	G63411		CAX-891	89425	
AT-547	G63775		CAH-069	85301		CAT-920	G63675		CAX-893	83203	89436
AT-554	85305		CAHL-400	85303	89422	CAT-926	G63410		CAX-893	85000	89436
AT-557	G63714		CAHL-400	85700		CAT-927	G63409		CAX-893	85043	
AT-568	G63622		CAHL-400	89422		CAT-928	G63410		CAX-893	89436	
AT-579	G63809		CAHL-405	85300	89419	CAT-929	G63403		CAX-894	83209	89414
AT-610	G63461		CAHL-405	89419		CAT-930	G63461		CAX-894	85005	89430
AT-611	G63461		CAHL-406	85004		CAT-935	G63424		CAX-894	85013	89414
AT-620	83209	89414	CAHL-409	85310	89423	CAT-936	G63425		CAX-894	89414	
AT-620	89414		CAHL-409	89423		CAT-944	G63347		CAX-894	89430	
AT-621	83122	89406	CAHL-417	85311	89424	CAT-945	G63421		CAX-898	83125	
AT-621	89406		CAHL-417	89424		CAT-948	G63909		CAX-898	85006	
AT-682	G63678		CAT-722	83400		CAT-953	G63375		CAX-913	83303	
AT-683	G63679		CAT-729	G63414		CAT-953	G63903		CAX-916	83123	89405
AT-684	G63679		CAT-730	G63386		CAT-955	G63454		CAX-916	85036	89405
AT-685	G63679		CAT-731	G63409		CAT-958	G63377		CAX-916	89405	
AT-696	83140		CAT-732	G63455		CAT-960	G63366		CAX-921	83318	
AT-710	G63809		CAT-736	G63394		CAT-963	G63525		CAX-923	83102	
AT-713	G63614		CAT-740	G63423		CAT-964	G63456		CAX-923	83456	89447
AT-715	G63614		CAT-741	G63489		CAT-972	G63610		CAX-923	89447	
AT-716	G63809		CAT-745	G63608		CAT-975	G63511		CAX-924	83317	
AT-764	G63678		CAT-745	G63614		CAT-976	G63490		CAX-957	83225	
AT-765	G63772		CAT-750	G63359		CAT-977	G63915		CAX-969	83221	
AT-766	83209	89414	CAT-751	G63607		CAT-983	G63489		CAX-969	85030	89440
AT-766	89414		CAT-758	G63909		CAT-984	G63609		CAX-969	89440	
AT-811	83135		CAT-759	G63624		CAT-984	G63818		CLT-109	G63614	
AT619G	G63410		CAT-760	G63622		CAT-985	G63488		CLT-112	G63525	
AX-135A	G63406		CAT-761	G63623		CAT-986	G63489		CLT-113	G63524	
AX-267A	83309		CAT-762	G63638		CAX-001	85307		CLT-114	G63635	
AX-269A	83308		CAT-768	83209	89414	CAX-707	83215		CLT-116	G63902	
AX-269A	83312	89409	CAT-768	89414		CAX-707	85001	89410	CLT-124	G63610	
AX-269A	89409		CAT-776	G63661		CAX-707	89410				
AX-277A	83219		CAT-777	G63662		CAX-710	83209	89414			
AX-282A	85010		CAT-778	G63673		CAX-710	89414				

Important Note: Competitive Interchanges are to be used for stocking purposes only. Where multiple crosses are identified, please reference the applications section of this catalog. / **Remarque importante:** Les interchanges concurrentiels ne s'utilisent qu'aux fins de stocks. Dans le cas de rferences multiples, consulter la section des applications du catalogue. / **Nota importante:** Dans le cas de rferences multiples, consulter la section des applications du catalogue. / **Nota importante:** Se pueden usar intercambios competitivos para propósitos de almacenamiento solamente. Cuando se identifican intercambios múltiples, consulte la sección de aplicaciones de este catálogo.

COMPETITIVE & O.E.M. INTERCHANGE LIST
Lista de Intercambios contra Competidores y Equipo Original.
Liste dinterchange de produits comptitifs & dquipement original (OEM)

NAPA

Napa	Gabriel	Upgrade	Napa	Gabriel	Upgrade	Napa	Gabriel	Upgrade	Napa	Gabriel	Upgrade
LS56924	G56924		LS57030	G57030		LS57089	G57089		LS57153	G57153	
LS56925	G56925		LS57031	G57031		LS57090	G57090		LS57156	G57156	
LS56927	G56927		LS57032	G57032		LS57091	G57091		LS57157	G57157	
LS56928	G56928		LS57033	G57033		LS57092	G57092		LS57158	G57158	
LS56929	G56929		LS57034	G57034		LS57095	G57095		LS57159	G57159	
LS56930	G56930		LS57035	G57035		LS57096	G57096		LS57160	G57160	
LS56931	G56931		LS57036	G57036		LS57097	G57097		LS57161	G57161	
LS56932	G56932		LS57037	G57037		LS57098	G57098		LS57162	G57162	
LS56933	G56933		LS57038	G57038		LS57099	G57099		LS57163	G57163	
LS56934	G56934		LS57039	G57039		LS57100	G57100		LS57164	G57164	
LS56935	G56935		LS57040	G57040		LS57103	G57103		LS57167	G57167	
LS56936	G56936		LS57041	G57041		LS57105	G57105		LS57168	G57168	
LS56937	G56937		LS57042	G57042		LS57106	G57106		LS57172	G57172	
LS56938	G56938		LS57043	G57043		LS57107	G57107		LS57173	G57173	
LS56943	G56943		LS57044	G57044		LS57108	G57108		LS57176	G57176	
LS56948	G56948		LS57045	G57045		LS57109	G57109		LS57177	G57177	
LS56949	G56949		LS57046	G57046		LS57110	G57110		LS57178	G57178	
LS56950	G56950		LS57047	G57047		LS57111	G57111		LS57184	G57184	
LS56951	G56951		LS57048	G57048		LS57112	G57112		LS57185	G57185	
LS56956	G56956		LS57049	G57049		LS57113	G57113		LS57190	G57190	
LS56957	G56957		LS57050	G57050		LS57114	G57114		LS57191	G57191	
LS56962	G56962		LS57051	G57051		LS57115	G57115		LS57192	G57192	
LS56963	G56963		LS57053	G57053		LS57118	G57118		LS57193	G57193	
LS56964	G56964		LS57054	G57054		LS57119	G57119		LS57194	G57194	
LS56965	G56965		LS57055	G57055		LS57120	G57120		LS57195	G57195	
LS56973	G56973		LS57056	G57056		LS57121	G57121		LS57197	G57197	
LS56974	G56974		LS57057	G57057		LS57122	G57122		LS57198	G57198	
LS56975	G56975		LS57058	G57058		LS57123	G57123		LS57200	G57200	
LS56991	G56991		LS57059	G57059		LS57124	G57124		LS57201	G57201	
LS56992	G56992		LS57060	G57060		LS57125	G57125		LS57202	G57202	
LS56993	G56993		LS57061	G57061		LS57126	G57126		LS57203	G57203	
LS56994	G56994		LS57062	G57062		LS57127	G57127		LS57204	G57204	
LS56995	G56995		LS57063	G57063		LS57128	G57128		LS57205	G57205	
LS56996	G56996		LS57064	G57064		LS57129	G57129		LS57206	G57206	
LS56997	G56997		LS57065	G57065		LS57130	G57130		LS57207	G57207	
LS56998	G56998		LS57066	G57066		LS57131	G57131		LS57208	G57208	
LS57000	G57000		LS57067	G57067		LS57132	G57132		LS57212	G57212	
LS57006	G57006		LS57068	G57068		LS57133	G57133		LS57218	G57218	
LS57007	G57007		LS57069	G57069		LS57134	G57134		LS57219	G57219	
LS57008	G57008		LS57070	G57070		LS57135	G57135		LS57220	G57220	
LS57010	G57010		LS57071	G57071		LS57136	G57136		LS57221	G57221	
LS57011	G57011		LS57072	G57072		LS57137	G57137		LS57222	G57222	
LS57012	G57012		LS57075	G57075		LS57138	G57138		LS57223	G57223	
LS57013	G57013		LS57076	G57076		LS57139	G57139		LS57266	G57266	
LS57014	G57014		LS57077	G57077		LS57140	G57140		LS57267	G57267	
LS57015	G57015		LS57078	G57078		LS57141	G57141		LS57268	G57268	
LS57016	G57016		LS57079	G57079		LS57142	G57142		LS57269	G57269	
LS57017	G57017		LS57080	G57080		LS57144	G57144		LS57270	G57270	
LS57018	G57018		LS57081	G57081		LS57145	G57145		LS57271	G57271	
LS57019	G57019		LS57082	G57082		LS57146	G57146		LS57274	G57274	
LS57020	G57020		LS57083	G57083		LS57147	G57147		LS57275	G57275	
LS57021	G57021		LS57084	G57084		LS57148	G57148		LS57276	G57276	
LS57022	G57022		LS57085	G57085		LS57149	G57149		LS57277	G57277	
LS57023	G57023		LS57086	G57086		LS57150	G57150		LS57278	G57278	
LS57026	G57026		LS57087	G57087		LS57151	G57151		LS57279	G57279	
LS57027	G57027		LS57088	G57088		LS57152	G57152		LS57282	G57282	

Important Note: Competitive Interchanges are to be used for stocking purposes only. Where multiple crosses are identified, please reference the applications section of this catalog./ **Remarque importante:** Les interchanges concurrentiels ne s'utilisent qu'aux fins de stocks. **Dans le cas de rfrences multiples, consulter la section des applications du catalogue./ Nota importante:** Dans le cas de rfrences multiples, consulter la section des applications du catalogue./ **Nota importante:** Se pueden usar intercambios competitivos para propósitos de almacenamiento solamente. Cuando se identifican intercambios múltiples, consulte la sección de aplicaciones de este catálogo.

COMPETITIVE & O.E.M. INTERCHANGE LIST
Lista de Intercambios contra Competidores y Equipo Original.
Liste dinterchange de produits comptitifs & dquipement original (OEM)

NAPA... cont'd

Napa	Gabriel	Upgrade	Napa	Gabriel	Upgrade	Napa	Gabriel	Upgrade	Napa	Gabriel	Upgrade
LS57311	G57311		LS57400	G57400		LS57488	G57488		LS57594	G57594	
LS57312	G57312		LS57401	G57401		LS57489	G57489		LS57595	G57595	
LS57314	G57314		LS57404	G57404		LS57490	G57490		LS57597	G57597	
LS57322	G57322		LS57405	G57405		LS57493	G57493		LS57598	G57598	
LS57323	G57323		LS57409	G57409		LS57494	G57494		LS57599	G57599	
LS57324	G57324		LS57413	G57413		LS57495	G57495		LS57600	G57600	
LS57329	G57329		LS57414	G57414		LS57496	G57496		LS57601	G57601	
LS57330	G57330		LS57415	G57415		LS57497	G57497		LS57602	G57602	
LS57331	G57331		LS57416	G57416		LS57498	G57498		LS57603	G57603	
LS57332	G57332		LS57417	G57417		LS57499	G57499		LS57604	G57604	
LS57333	G57333		LS57418	G57418		LS57500	G57500		LS57605	G57605	
LS57334	G57334		LS57419	G57419		LS57509	G57509		LS57606	G57606	
LS57335	G57335		LS57420	G57420		LS57510	G57510		LS57607	G57607	
LS57336	G57336		LS57421	G57421		LS57515	G57515		LS57608	G57608	
LS57337	G57337		LS57422	G57422		LS57516	G57516		LS57609	G57609	
LS57338	G57338		LS57423	G57423		LS57517	G57517		LS57612	G57612	
LS57339	G57339		LS57424	G57424		LS57518	G57518		LS57613	G57613	
LS57340	G57340		LS57425	G57425		LS57521	G57521		LS57614	G57614	
LS57341	G57341		LS57427	G57427		LS57522	G57522		LS57615	G57615	
LS57342	G57342		LS57428	G57428		LS57523	G57523		LS57628	G57628	
LS57343	G57343		LS57429	G57429		LS57524	G57524		LS57629	G57629	
LS57344	G57344		LS57430	G57430		LS57535	G57535		LS57634	G57634	
LS57345	G57345		LS57431	G57431		LS57536	G57536		LS57635	G57635	
LS57346	G57346		LS57432	G57432		LS57539	G57539		LS57640	G57640	
LS57349	G57349		LS57437	G57437		LS57540	G57540		LS57641	G57641	
LS57350	G57350		LS57441	G57441		LS57541	G57541		LS57642	G57642	
LS57353	G57353		LS57442	G57442		LS57542	G57542		LS57643	G57643	
LS57354	G57354		LS57444	G57444		LS57543	G57543		LS57644	G57644	
LS57357	G57357		LS57447	G57447		LS57544	G57544		LS57645	G57645	
LS57358	G57358		LS57449	G57449		LS57545	G57545		LS57646	G57646	
LS57359	G57359		LS57450	G57450		LS57546	G57546		LS57648	G57648	
LS57360	G57360		LS57451	G57451		LS57549	G57549		LS57649	G57649	
LS57361	G57361		LS57452	G57452		LS57550	G57550		LS57650	G57650	
LS57362	G57362		LS57453	G57453		LS57557	G57557		LS57651	G57651	
LS57363	G57363		LS57454	G57454		LS57560	G57560		LS57658	G57658	
LS57364	G57364		LS57455	G57455		LS57561	G57561		LS57659	G57659	
LS57365	G57365		LS57456	G57456		LS57562	G57562		LS57663	G57663	
LS57366	G57366		LS57457	G57457		LS57563	G57563		LS57664	G57664	
LS57367	G57367		LS57458	G57458		LS57564	G57564		LS57665	G57665	
LS57368	G57368		LS57459	G57459		LS57565	G57565		LS57666	G57666	
LS57369	G57369		LS57460	G57460		LS57566	G57566		LS57673	G57673	
LS57370	G57370		LS57463	G57463		LS57567	G57567		LS57674	G57674	
LS57372	G57372		LS57464	G57464		LS57568	G57568		LS57675	G57675	
LS57373	G57373		LS57465	G57465		LS57569	G57569		LS57676	G57676	
LS57375	G57375		LS57466	G57466		LS57572	G57572		LS57677	G57677	
LS57376	G57376		LS57473	G57473		LS57573	G57573		LS57680	G57680	
LS57377	G57377		LS57474	G57474		LS57574	G57574		LS57682	G57682	
LS57378	G57378		LS57477	G57477		LS57575	G57575		LS57697	G57697	
LS57390	G57390		LS57478	G57478		LS57576	G57576		LS57698	G57698	
LS57391	G57391		LS57479	G57479		LS57577	G57577		LS57701	G57701	
LS57392	G57392		LS57480	G57480		LS57578	G57578		LS57702	G57702	
LS57393	G57393		LS57481	G57481		LS57579	G57579		LS57704	G57704	
LS57394	G57394		LS57482	G57482		LS57582	G57582		LS57705	G57705	
LS57397	G57397		LS57483	G57483		LS57583	G57583		LS57722	G57722	
LS57398	G57398		LS57484	G57484		LS57586	G57586		LS57723	G57723	
LS57399	G57399		LS57487	G57487		LS57587	G57587		LS57732	G57732	

Important Note: Competitive Interchanges are to be used for stocking purposes only. Where multiple crosses are identified, please reference the applications section of this catalog. / **Remarque importante:** Les interchanges concurrentiels ne s'utilisent qu'aux fins de stocks. Dans le cas de références multiples, consulter la section des applications du catalogue. / **Nota importante:** Dans le cas de références multiples, consulter la section des applications du catalogue. / **Nota importante:** Se pueden usar intercambios competitivos para propósitos de almacenamiento solamente. Cuando se identifican intercambios múltiples, consulte la sección de aplicaciones de este catálogo.

COMPETITIVE & O.E.M. INTERCHANGE LIST
Lista de Intercambios contra Competidores y Equipo Original.
Liste dinterchange de produits comptitifs & dquipement original (OEM)

NAPA... cont'd

Napa	Gabriel	Upgrade	Napa	Gabriel	Upgrade	Napa	Gabriel	Upgrade	Napa	Gabriel	Upgrade
LS57733	G57733		SH69592	69592		SH81821	81821		SH82026	82026	
LS57752	G57752		SH69909	69909		SH81823	81823		SH82032	82032	
LS57753	G57753		SH70010	70010		SH81825	81825		SH82034	82034	
LS57754	G57754		SH70102	70102		SH81828	81828		SH82035	82035	
LS57755	G57755		SH81039	81039		SH81833	81833		SH82039	82039	
LS57772	G57772		SH81076	81076		SH81834	81834		SH82040	82040	
LS57773	G57773		SH81082	81082		SH81836	81836		SH82047	82047	
LS57784	G57784		SH81091	81091		SH81837	81837		SH82051	82051	
LS57785	G57785		SH81095	81095		SH81869	81869		SH82060	82060	
LS57786	G57786		SH81096	81096		SH81870	81870		SH82065	82065	
LS57792	G57792		SH81113	81113		SH81871	81871		SH82066	82066	
LS57793	G57793		SH81147	81147		SH81873	81873		SH82069	82069	
LS57794	G57794		SH81153	81153		SH81878	81878		SH82070	82070	
LS57795	G57795		SH81164	81164		SH81880	81880		SH82072	82072	
LS57796	G57796		SH81242	81242		SH81890	81890		SH82075	82075	
LS57800	G57800		SH81318	81318		SH81891	81891		SH82076	82076	
LS57801	G57801		SH81340	81340		SH81892	81892		SH82079	82079	
SH511134	G511134		SH81394	81394		SH81893	81893		SH82086	82086	
SH51807	G51807		SH81416	81416		SH81904	81904		SH82087	82087	
SH51874	G51874		SH81440	81440		SH81905	81905		SH82090	82090	
SH61506	61506		SH81446	81446		SH81910	81910		SH82099	82099	
SH61546	61546		SH81459	81459		SH81911	81911		SH82103	82103	
SH61582	61582		SH81469	81469		SH81912	81912		SH82104	82104	
SH61614	61614		SH81478	81478		SH81913	81913		SH82109	82109	
SH61654	61654		SH81481	81481		SH81914	81914		SH82110	82110	
SH61655	61655		SH81482	81482		SH81916	81916		SH82118	82118	
SH61656	61656		SH81484	81484		SH81917	81917		SH82125	82125	
SH61662	61662		SH81490	81490		SH81918	81918		SH82126	82126	
SH61704	61704		SH81491	81491		SH81919	81919		SH82128	82128	
SH61712	61712		SH81492	81492		SH81920	81920		SH82130	82130	
SH61715	61715		SH81494	81494		SH81921	81921		SH82131	82131	
SH61717	61717		SH81495	81495		SH81922	81922		SH82138	82138	
SH61720	61720		SH81496	81496		SH81923	81923		SH82147	82147	
SH63614	G63614		SH81507	81507		SH81924	81924		SH82151	82151	
SH63692	G63692		SH81510	81510		SH81925	81925		SH82155	82155	
SH63720	G63720		SH81516	81516		SH81926	81926		SH82156	82156	
SH63726	G63726		SH81540	81540		SH81927	81927		SH82601	82601	
SH63781	G63781		SH81548	81548		SH81928	81928		SH82602	82602	
SH63782	G63782		SH81549	81549		SH81929	81929		SH82609	82609	
SH63809	G63809		SH81553	81553		SH81930	81930		SH82615	82615	
SH63837	G63837		SH81559	81559		SH81931	81931		SH82618	82618	
SH63844	G63844		SH81560	81560		SH81932	81932		ST51077	G51077	
SH63862	G63862		SH81582	81582		SH81933	81933		ST51087	G51087	
SH63879	G63879		SH81583	81583		SH81934	81934		ST51252	G51252	
SH63884	G63884		SH81667	81667		SH81935	81935		ST51267	G51267	
SH63892	G63892		SH81668	81668		SH81936	81936		ST51279	G51279	
SH64027	G64027		SH81675	81675		SH81937	81937		ST51477	G51477	
SH64028	G64028		SH81676	81676		SH82001	82001		ST51700	G51700	
SH64040	G64040		SH81691	81691		SH82003	82003		ST51703	G51703	
SH64042	G64042		SH81710	81710		SH82004	82004		ST51704	G51704	
SH64043	G64043		SH81713	81713		SH82005	82005		ST51713	G51713	
SH69473	69473		SH81726	81726		SH82007	82007		ST51714	G51714	
SH69575	69575		SH81730	81730		SH82010	82010		ST51715	G51715	
SH69587	69587		SH81744	81744		SH82011	82011		ST51716	G51716	
SH69589	69589		SH81750	81750		SH82012	82012		ST51718	G51718	
SH69590	69590		SH81794	81794		SH82025	82025		ST51722	G51722	

Important Note: Competitive Interchanges are to be used for stocking purposes only. Where multiple crosses are identified, please reference the applications section of this catalog. / **Remarque importante:** Les interchanges concurrentiels ne s'utilisent qu'aux fins de stocks. Dans le cas de rfrences multiples, consulter la section des applications du catalogue. / **Nota importante:** Dans le cas de rfrences multiples, consulter la section des applications du catalogue. / **Nota importante:** Se pueden usar intercambios competitivos para propósitos de almacenamiento solamente. Cuando se identifican intercambios múltiples, consulte la sección de aplicaciones de este catálogo.

COMPETITIVE & O.E.M. INTERCHANGE LIST
Lista de Intercambios contra Competidores y Equipo Original.
Liste dinterchange de produits comptitifs & dquipement original (OEM)

NAPA... cont'd

Napa	Gabriel	Upgrade	Napa	Gabriel	Upgrade	Napa	Gabriel	Upgrade	Napa	Gabriel	Upgrade
ST51723	G51723		ST52027	G52027		ST55949	G55949		ST56687	G56687	
ST51724	G51724		ST52081	G52081		ST55991	G55991		ST56688	G56688	
ST51727	G51727		ST52082	G52082		ST55993	G55993		ST56700	G56700	
ST51728	G51728		ST52094	G52094		ST55994	G55994		ST56718	G56718	
ST51736	G51736		ST52095	G52095		ST55999	G55999		ST56721	G56721	
ST51737	G51737		ST52121	G52121		ST56506	G56506		ST56722	G56722	
ST51738	G51738		ST52122	G52122		ST56509	G56509		ST56728	G56728	
ST51739	G51739		ST52125	G52125		ST56514	G56514		ST56729	G56729	
ST51758	G51758		ST52131	G52131		ST56516	G56516		ST56730	G56730	
ST51760	G51760		ST55526	G55526		ST56517	G56517		ST56731	G56731	
ST51761	G51761		ST55551	G55551		ST56518	G56518		ST56758	G56758	
ST51765	G51765		ST55591	G55591		ST56539	G56539		ST56759	G56759	
ST51815	G51815		ST55661	G55661		ST56540	G56540		ST56773	G56773	
ST51842	G51842		ST55662	G55662		ST56561	G56561		ST56774	G56774	
ST51859	G51859		ST55675	G55675		ST56562	G56562		ST56797	G56797	
ST51860	G51860		ST55676	G55676		ST56568	G56568		ST56798	G56798	
ST51861	G51861		ST55681	G55681		ST56581	G56581		ST56799	G56799	
ST51864	G51864		ST55697	G55697		ST56582	G56582		ST56800	G56800	
ST51870	G51870		ST55698	G55698		ST56601	G56601		ST56807	G56807	
ST51877	G51877		ST55804	G55804		ST56606	G56606		ST56809	G56809	
ST51878	G51878		ST55820	G55820		ST56620	G56620		ST56810	G56810	
ST51891	G51891		ST55821	G55821		ST56621	G56621		ST56836	G56836	
ST52004	G52004		ST55825	G55825		ST56622	G56622		ST56837	G56837	
ST52005	G52005		ST55856	G55856		ST56640	G56640		ST56886	G56886	
ST52006	G52006		ST55870	G55870		ST56641	G56641		ST56887	G56887	
ST52007	G52007		ST55879	G55879		ST56660	G56660		ST56888	G56888	
ST52008	G52008		ST55892	G55892		ST56661	G56661		ST56889	G56889	
ST52009	G52009		ST55896	G55896		ST56671	G56671		ST56899	G56899	
ST52013	G52013		ST55901	G55901		ST56672	G56672				
ST52014	G52014		ST55909	G55909		ST56677	G56677				
ST52026	G52026		ST55948	G55948		ST56678	G56678				

Nissan

Nissan	Gabriel	Upgrade	Nissan	Gabriel	Upgrade	Nissan	Gabriel	Upgrade	Nissan	Gabriel	Upgrade
54302-2Y987	G56686		54303-2Y989	G56685		56101-30Z02	G63610		56110-8Z425	G63813	
54302-2Y988	G56686		54303-2Z325	G56785		56101-Z5008	83114		56110-8Z426	G63813	
54302-2Y989	G56686		54303-4W925	G56687		56101-Z5014	83162		56110-8Z427	G63813	
54302-2Z325	G56784		54303-4W926	G56687		56101-Z5017	83162		56110-8Z428	G63813	
54302-4W925	G56688		54303-4W985	G56615		56101Z5008	83114		56110-8Z625	G63813	
54302-4W926	G56688		54303-5Z025	G52032		56101Z5014	83162		56110-8Z825	G63813	
54302-4W985	G56616		54303-5Z026	G52032		56101Z5017	83162		56110-8Z826	G63813	
54302-5Z025	G52033		54303-6Y325	G56685		56110-01G27	G63909		56110-8Z828	G63813	
54302-5Z026	G52033		54303-6Y425	G56685		56110-1Z626	G63813		56110-9Z325	G63813	
54302-6Y325	G56686		54303-7B025	G56785		56110-1Z627	G63813		56110-9Z425	G63813	
54302-6Y425	G56686		54303-7B085	G56785		56110-1Z628	G63813		56110-CD027	G51814	
54302-7B025	G56784		54303-7Y426	G56671		56110-30Z02	G63610		56110-CD028	G51813	
54302-7B085	G56784		54303-8J025	G56671		56110-3S526	G63909		56110-EA025	G51765	
54302-7Y426	G56672		54303-8J026	G56671		56110-3S527	G63813		56110-EA026	G51765	
54302-8J025	G56672		54303-8J127	G56671		56110-4S125	G63813		56110-EA027	G51765	
54302-8J026	G57030		54303-9PB0A	G52524		56110-7S026	G51715		56110-EA028	G51765	
54302-8J127	G56672		54303-CA025	G52008		56110-7S125	G51715		56110-EA525	G51765	
54302-9PB0A	G52525		54303-CA125	G52008		56110-7S126	G51715		56110-EA526	G51765	
54302-CA025	G52009		54303-CB125	G52008		56110-7S225	G51715		56110-EA825	G51766	
54302-CA125	G52009		54303-EJ026	G57031		56110-7S226	G51715		56110-EB025	G51766	
54302-CB125	G52009		54303-ZB125	G56671		56110-7S325	G51715				
54302-ZB125	G56672		54322-4U01A	142937		56110-7S326	G51715				
54303-2Y987	G56685		54322-CG00A	142937		56110-7Z025	G63813				
54303-2Y988	G56685		56100-ZP02A	G51766		56110-7Z225	G63813				

Important Note: Competitive Interchanges are to be used for stocking purposes only. Where multiple crosses are identified, please reference the applications section of this catalog. / **Remarque importante:** Les interchanges concurrentiels ne s'utilisent qu'aux fins de stocks. Dans le cas de rferences multiples, consulter la section des applications du catalogue. / **Nota importante:** Dans le cas de rferences multiples, consulter la section des applications du catalogue. / **Nota importante:** Se pueden usar intercambios competitivos para propósitos de almacenamiento solamente. Cuando se identifican intercambios múltiples, consulte la sección de aplicaciones de este catálogo.

COMPETITIVE & O.E.M. INTERCHANGE LIST
Lista de Intercambios contra Competidores y Equipo Original.
Liste dinterchange de produits comptitifs & dquipement original (OEM)

Nissan... cont'd

Nissan	Gabriel	Upgrade	Nissan	Gabriel	Upgrade	Nissan	Gabriel	Upgrade	Nissan	Gabriel	Upgrade
56110-EG025	G51925		56200-ZC00A	G63875		E4302-CB10A	G52009		E4303-9PB0A	G52524	
56110-F400A	G63902		56200-ZP025	G64031		E4302-ET00B	G52095		E4303-CB00J	G52008	
56110-T8123	G63432		56200-ZR00A	G63878		E4302-ET02B	G52095		E4303-CB025	G52008	
56110-T8129	G63432		56200-ZV50A	G63875		E4302-ET81A	G52095		E4303-CB10A	G52008	
56110-Z5008	83114		56200-ZV60A	G63875		E4302-ET81B	G52095		E4303-ET00B	G52094	
56110-Z5011	G63610		56200-ZZ90A	G63875		E4302-ET82B	G52095		E4303-ET02B	G52094	
56110-Z5014	83162		56210-10G27	G63907		E4302-JA01B	G52122		E4303-ET81A	G52094	
56110-Z5017	83162		56210-31U25	G51087		E4302-JA02A	G52122		E4303-ET81B	G52094	
56110-ZC00A	G51715		56210-31U27	G51087		E4302-JA11A	G52122		E4303-ET82B	G52094	
56110-ZC025	G51715		56210-43U27	G51087		E4302-JA12A	G52122		E4303-JA01B	G52121	
56110-ZC085	G51715		56210-4Z025	G51279		E4302-JB12A	G52122		E4303-JA02A	G52121	
56110-ZP025	G51766		56210-4Z026	G51279		E4302-JB12B	G52122		E4303-JA11A	G52121	
56110T8123	G63432		56210-4Z027	G51279		E4302-JM00A	G52174		E4303-JA12A	G52121	
56110T8129	G63432		56210-5Y025	G51727		E4302-ZB02B	G57030		E4303-JB12A	G52121	
56110Z5008	83114		56210-5Y026	G51727		E4302-ZB03B	G57030		E4303-JB12B	G52121	
56110Z5014	83162		56210-5Z025	G51803		E4302-ZB70A	G57030		E4303-JM00A	G52173	
56110Z5017	83162		56210-5Z026	G51803		E4302-ZJ60A	G52095		E4303-ZB02B	G57031	
56111-EG025	G51926		56210-6Y325	G51727		E4302-ZM70A	G52033		E4303-ZB03A	G57031	
56200-0B027	G63299		56210-6Y425	G51727		E4302-ZX00A	G52122		E4303-ZB03B	G56671	
56200-0B028	G63299		56210-6Z625	G51279		E4302-ZX10A	G52122		E4303-ZB70A	G57031	
56200-1B026	G63299		56210-6Z925	G51279		E43021-AA0B	G52171		E4303-ZJ60A	G52094	
56200-1W225	G63712		56210-7Y027	G51802		E43021-AA0C	G52171		E4303-ZM70A	G52032	
56200-1Z625	61506		56210-7Y427	G51802		E43021-AA0D	G52171		E4303-ZX00A	G52121	
56200-1Z626	61506		56210-CA025	G51798		E43021-AA0F	G52171		E4303-ZX10A	G52121	
56200-2Z325	G63299		56210-CA026	G51798		E43021-AA1A	G52171		E4C02-1AA0J-NW	G52171	
56200-6B025	G63299		56210-CB025	G51798		E43021-AA1B	G52171		E4C02-2Y98J-NW	G56684	
56200-7B025	G63299		56210-CB026	G51798		E43021-AA1C	G52171		E4C02-2Z32J-NW	G56784	
56200-7B085	G63299		56210-CB825	G51798		E4303-1AA0B	G52170		E4C02-4W92J-NW	G56616	
56200-7S023	G63875		56210-Z6003	85308	89422	E4303-1AA0C	G52170		E4C02-6Y42J-NW	G56686	
56200-7S225	G63883		56210-Z6003	89422		E4303-1AA0D	G52170		E4C02-7Y42J-NW	G56672	
56200-7S226	G63883		56210-ZG125	G51279		E4303-1AA0F	G52170		E4C02-CA02J-NW	G52009	
56200-7S325	G63878		56210Z6003	85308	89422	E4303-1AA1A	G52170		E4C02-ET81J-NW	G52095	
56200-7S326	G63878		56210Z6003	89422		E4303-1AA1B	G52170		E4C02-JA02J-NW	G52122	
56200-7Z025	61506		56217-61L10	142547		E4303-1AA1C	G52170		E4C02-JM00J-NW	G52174	
56200-7Z225	61506		56218-61L10	142547		E4303-1JA0B	G52355		E4C02-ZM70J-NW	G52033	
56200-7Z285	61506		66400	G63432		E4303-1JA0B	G52356		E4C03-1AA0J-NW	G52170	
56200-8Z425	61506		E4302-1JA0C	G52355		E4303-1JA0C	G52356		E4C03-2Y98J-NW	G56683	
56200-8Z625	61506		E4302-1JA0J-NW	G52356		E4303-1JA0J-NW	G52355		E4C03-2Z32J-NW	G56785	
56200-8Z825	61506		E4302-2Y985	G56684		E4303-2Y985	G56683		E4C03-4W92J-NW	G56615	
56200-8Z826	61506		E4302-2Y988	G56686		E4303-2Y988	G56685		E4C03-6Y42J-NW	G56685	
56200-8Z827	61506		E4302-3KA0A	G52525		E4303-3KA0A	G52524		E4C03-7Y42J-NW	G56671	
56200-9FF0B	G63883		E4302-3W485	G56616		E4303-3NA0C	G52524		E4C03-CA02J-NW	G52008	
56200-9FG0A	G63878		E4302-4BA1C	G52410		E4303-3NF1A	G52524		E4C03-ET81J-NW	G52094	
56200-9FG0B	G63878		E4302-4BF1C	G52410		E4303-3W485	G56615		E4C03-JA02J-NW	G52121	
56200-9Z825	61506		E4302-4W92J-NW	G56688		E4303-4BA1C	G52411		E4C03-JM00J-NW	G52173	
56200-EA025	69594		E4302-6Y325	G56686		E4303-4BF1C	G52411		E4C03-ZM70J-NW	G52032	
56200-EA026	69594		E4302-7Y01B	G56672		E4303-4W92J-NW	G56687		E6110-4KH4A	G51766	
56200-EA027	69594		E4302-9DA0A	G52383		E4303-6Y325	G56685		E6110-9FE0A	G51715	
56200-EA285	69595		E4302-9DA0J-NW	G52383		E4303-6Y425	G56685		E6110-9FE0B	G51715	
56200-EA286	69595		E4302-9DC0A	G52383		E4303-7Y01B	G56671		E6110-9FE1B	G51715	
56200-EA287	69595		E4302-9DF0C	G52383		E4303-9DA0A	G52382		E6110-9FE4A	G51715	
56200-EA525	G64033		E4302-9N20D	G52383		E4303-9DA0J-NW	G52382		E6110-9FE4B	G51715	
56200-EA585	G64033		E4302-9PB0A	G52525		E4303-9DCA0A	G52382		E6110-9FG0A	G51715	
56200-EB025	G64031		E4302-9PB0B	G52525		E4303-9DF0C	G52382		E6110-CD02J-NW	G51814	
56200-EB085	G64031		E4302-CB00J	G52009		E4303-9N00D	G52382		E6110-EB025	G51766	
56200-F400A	G63907		E4302-CB025	G52009		E4303-9N20D	G52382		E6110-ZL10A	G51765	

Important Note: Competitive Interchanges are to be used for stocking purposes only. Where multiple crosses are identified, please reference the applications section of this catalog. / **Remarque importante:** Les interchanges concurrentiels ne s'utilisent qu'aux fins de stocks. Dans le cas de rferences multiples, consulter la section des applications du catalogue. / **Nota importante:** Dans le cas de rferences multiples, consulter la section des applications du catalogue. / **Nota importante:** Se pueden usar intercambios competitivos para propósitos de almacenamiento solamente. Cuando se identifican intercambios múltiples, consulte la sección de aplicaciones de este catálogo.

COMPETITIVE & O.E.M. INTERCHANGE LIST
Lista de Intercambios contra Competidores y Equipo Original.
Liste dinterchange de produits comptitifs & dquipement original (OEM)

Nissan... cont'd

Nissan	Gabriel	Upgrade	Nissan	Gabriel	Upgrade	Nissan	Gabriel	Upgrade	Nissan	Gabriel	Upgrade
E6110-ZL40A	G51766		E6200-ET000	70027		E6210-3LN0J-NW	G64146		E6A10-CD70A	G51814	
E6110-ZL60A	G51766		E6200-ET80A	70027		E6210-3SH0C	G511044		E6A10-CD70B	G51813	
E6110-ZL60J	G51766		E6200-ET81B	70027		E6210-3TA1B	G51874		E6A10-EA02J-NW	G51765	
E6110-ZP02A	G51766		E6200-EZ71B	G63878		E6210-4AF0A	G511044		E6A10-EA82J-NW	G51766	
E6110-ZP90A	G51766		E6200-EZ81A	G63878		E6210-4BA0C	G64050		E6A10-EG00D	G51926	
E6110-ZQ00C	G51715		E6200-ZJ60A	70027		E6210-4BA1C	G64050		E6A11-EG00D	G51925	
E6110-ZQ20C	G51715		E6200-ZL02A	G64031		E6210-5AA0C	G51884		E6B00-0W02J-NW	G63712	
E6110-ZR00A	G51715		E6200-ZL10A	G64033		E6210-5HA0B	G64050		E6B00-1B02J-NW	G63299	
E6110-ZR00B	G51715		E6200-ZL40A	G64031		E6210-5Y025	G51727		E6B00-1Z62J-NW	G63492	
E6110-ZR01B	G51715		E6200-ZL60A	G64031		E6210-9AM0A	G511044		E6B00-4W02J-NW	G63845	
E6110-ZR40A	G51715		E6200-ZN90A	70041		E6210-9AN0A	G511044		E6B00-7S22J-NW	G63883	
E6110-ZR40B	G51715		E6200-ZP50A	G64031		E6210-9KN0A	G51990		E6B00-7S32J-NW	G63878	
E6110-ZR50A	G51715		E6200-ZR00B	G63883		E6210-9LE0B	G51990		E6B00-EA02J-NW	69595	
E6110-ZR51A	G51715		E6200-ZR40A	G63878		E6210-9MB0A	G51990		E6B00-EA28J-NW	69594	
E6110-ZS30A	G51765		E6200-ZR40B	G63878		E6210-9N60B	70089		E6B00-EB02J-NW	G64031	
E6110-ZS60A	G51765		E6200-ZR50A	G63878		E6210-9N60J-NW	70089		E6B00-10C01J-NW	G63875	
E6110-ZZ50A	G51715		E6200-ZR51A	G63878		E6210-9NF0A	G511043		E6B10-ZG2J-NW	G63907	
E6110-ZZ50B	G51715		E6200-ZS61B	G64033		E6210-CB800	G51798		E6B10-1AA1J-NW	G51884	
E6110-ZZ51A	G51715		E6200-ZV90B	70041		E6210-EM30C	70041		E6B10-31U2J-NW	G51087	
E6110-ZZ51B	G51715		E6200-ZV9XB	70041		E6210-JA00D	G51874		E6B10-4Z02J-NW	G51279	
E6200-0W025	G63712		E6210-1AA0B	G51884		E6210-JA01A	G51874		E6B10-6Y42J-NW	G51727	
E6200-1PA0D	G64164		E6210-1AA0C	G51884		E6210-JA11A	G51874		E6B10-7Y02J-NW	G51802	
E6200-1PA1A	G64164		E6210-1AA1A	G51884		E6210-JA12D	G51874		E6B10-CA02J-NW	G51798	
E6200-1PB0A	G64164		E6210-1HKXB	G51990		E6210-JA80B	G51874		E6B10-EL00A	70041	
E6200-2W525	G63845		E6210-1TZ0A	G51884		E6210-JM01A	G64050		E6B10-JA01J-NW	G51874	
E6200-4W000	G63845		E6210-1TZ0B	G51884		E6210-ZM70A	G51803		E6B10-JM01J-NW	G64050	
E6200-4W025	G63845		E6210-3ANOC	G51990		E6210-ZX00A	G51874		E6B10-ZM70J-NW	G51803	
E6200-9FF0A	G63883		E6210-3JA0B	G511043		E6210-ZX10A	G51874		E6B1M-EL00J-NW	70041	
E6200-9FF0B	G63883		E6210-3JV0B	G511043		E6A10-01G2J-NW	G63909		E6B20-EA52J-NW	G64033	
E6200-9FG0A	G63878		E6210-3KA0A	G511043		E6A10-1Z62J-NW	G63813		E6B20-ET00J-NW	70027	
E6200-9FG0B	G63878		E6210-3LM0B	G64146		E6A10-7S32J-NW	G51715				
E6200-9FG1A	G63878		E6210-3LN0A	G64146		E6A10-CD02J-NW	G51813				

O'Reilly

O'reilly	Gabriel	Upgrade	O'reilly	Gabriel	Upgrade	O'reilly	Gabriel	Upgrade	O'reilly	Gabriel	Upgrade
181674	G57559		20766	81744		32066	61529		32196	61615	
181675	G57558		20778	81730		32066	61555		32197	81549	
20400	81870		20778	81917		32066	81446		32206	61501	
20407	81548		20779	81540		32066	82110		32206	61662	
20408	81823		20779	81905		32067	82601		32207	82007	
20408	81890		20779	81918		32073	82131		32212	61539	
20418	81726		20801	81541		32075	61521		32215	81560	
20433	81928		20801	81713		32080	61518		32217	61508	
20444	81878		20801	82099		32103	82130		32217	61593	
20452	81750		20802	81492		32112	81095		32217	81553	
20701	81516		20851	81318		32113	81507		32219	81691	
20704	81242		23073	81394		32118	82128		32220	61541	
20711	81113		31000	61506		32126	81340		32220	81583	
20713	81164		31000	82156		32126	81440		32224	61544	
20718	81039		31029	81675		32126	82039		32225	61543	
20719	81496		31094	61500		32126	82155		322268	61646	
20721	81478		31125	82125		32132	81494		32227	61520	
20722	81676		31131	61632		32132	81582		32228	61554	
20744	81668		31131	81469		32143	82040		32231	81082	
20745	81667		31538	82005		32164	61519				
20747	81490		31542	82001		32164	81484				
20748	81710		32022	82090		32186	81482				
20751	81147		32066	61509		32194	61531				

Important Note: Competitive Interchanges are to be used for stocking purposes only. Where multiple crosses are identified, please reference the applications section of this catalog. / **Remarque importante:** Les interchanges concurrentiels ne s'utilisent qu'aux fins de stocks. Dans le cas de rferences multiples, consulter la section des applications du catalogue. / **Nota importante:** Dans le cas de rferences multiples, consulter la section des applications du catalogue. / **Nota importante:** Se pueden usar intercambios competitivos para propósitos de almacenamiento solamente. Cuando se identifican intercambios múltiples, consulte la sección de aplicaciones de este catálogo.

COMPETITIVE & O.E.M. INTERCHANGE LIST
Lista de Intercambios contra Competidores y Equipo Original.
Liste dinterchange de produits comptitifs & dquipement original (OEM)

O'Reilly... cont'd

O'reilly	Gabriel	Upgrade	O'reilly	Gabriel	Upgrade	O'reilly	Gabriel	Upgrade	O'reilly	Gabriel	Upgrade
32235	61561		32318	61512		32HN1100	G57062		33BW1101	G57363	
32237	61533		32318	81559		32HN1103	G57033		33BW1104	G57363	
32237	61627		32321	61658		32HN1103	G57061		33BW1105	G57364	
32238	61573		32321	81923		32HN1105	G57424		33CH1102	G57026	
32238	61629		32322	61614		32HN1106	G57425		33CH1103	G57071	
32245	61552		32325	61530		32HN1107	G56996		33CH1103	G57072	
32247	81871		32326	61641		32HN1108	G56997		33CH1105	G56964	
32250	61601		32326	81920		32HN1109	G56998		33CH1106	G56965	
32250	61679		32326	81921		32HN1161	G56994		33CH1109	G56963	
32250	81836		32328	61643		32HN1162	G56993		33CH1110	G56962	
32251	61584		32329	61642		32HN1163	G56995		33CH1111	G57206	
32251	81837		32330	61626		32JP1106	G57607		33CH1112	G57206	
32252	61535		32330	81916		32KA1100	G57458		33CH1113	G57466	
32253	61590		32333	81924		32KA1101	G57457		33CH1114	G57465	
32253	61624		32335	61609		32MZ1100	G57270		33CH1124	G57466	
32258	61556		32335	81910		32MZ1101	G57456		33CH1124	G57578	
32259	61591		32337	81911		32MZ1101	G57595		33CH1125	G57465	
32262	81872		32338	61664		32MZ1102	G57455		33CH1125	G57577	
32263	61542		32338	81869		32MZ1102	G57594		33CH1130	G57437	
32265	61687		32339	61676		32NS1100	G57057		33CH4111	G57206	
32266	61565		32339	81926		32NS1100	G57058		33DG1102	G57146	
32268	61595		32350	61663		32SB1100	G57423		33DG1103	G57053	
32268	81828		32350	81925		32TY1100	G57134		33DG1104	G57147	
32269	61575		32357	61654		32TY1101	G57133		33DG1105	G57266	
32269	81891		32358	61655		32TY1102	G57010		33DG1106	G57267	
32270	61582		32359	61656		32TY1103	G57066		33DG1111	G57071	
32272	61608		32362	61685		32TY1104	G57065		33FD1102	G57080	
32273	G63782		32366	61635		32TY1105	G57010		33FD1103	G57095	
32274	G63781		32376	81834		32TY1106	G57027		33FD1104	G57064	
32275	61625		32385	81091		32TY1107	G57027		33FD1105	G57063	
32277	61599		32385	81153		33033	61525		33FD1106	G57019	
32279	61634		32386	61546		33049	81495		33FD1108	G57021	
32279	81919		32386	81510		33050	81514		33FD1109	G57103	
32281	82147		32390	81933		33050	82602		33FD1110	G57020	
32286	82034		32391	61691		33053	82126		33FD1111	G57132	
32288	81821		32391	61692		33059	81076		33FD1112	G57018	
32290	61605		32391	81931		33059	82104		33FD1113	G57017	
32292	61606		32392	81932		33074	61516		33FD1114	G57015	
32293	61510		32401	61710		33076	61517		33FD1114	G57212	
32294	61547		32402	61712		33084	61524		33FD1115	G57096	
32294	61700		32402	61714		33086	61522		33FD1116	G57172	
32294	69675		32402	61716		33095	69632		33FD1117	G57082	
32295	61699		32403	81934		33095	81459		33FD1118	G57081	
32296	81893		32404	81935		33101	82010		33FD1119	G57046	
32299	81927		32405	61720		33122	81481		33FD1120	G57045	
32300	61504		32407	61715		33134	69845		33FD1121	G57271	
32301	82003		32592	82032		33137	81794		33FD1147	G57080	
32302	81912		32CH1100	G57075		33185	G51807		33FD1148	G57583	
32303	81892		32CH1101	G57026		33192	61704		33FD1149	G57582	
32304	61613		32CH1126	G57465		33196	G51874		33GM1100	G57131	
32304	81914		32DG1100	G57409		33274	69909		33GM1101	G57130	
32305	61612		32DG1101	G57178		33275	61592		33GM1102	G57022	
32305	81913		32FD1100	G57427		33275	81937		33GM1103	G57013	
32306	61616		32FD1101	G57148		33AC1105	G57574		33GM1104	G57014	
32316	61560		32GM1106	G57282		33AC1106	G57575		33GM1105	G57311	
32316	81904		32HN1100	G57032		33BW1100	G57364		33GM1107	G57312	

Important Note: Competitive Interchanges are to be used for stocking purposes only. Where multiple crosses are identified, please reference the applications section of this catalog. / **Remarque importante:** Les interchanges concurrentiels ne s'utilisent qu'aux fins de stocks. Dans le cas de rferences multiples, consulter la section des applications du catalogue. / **Nota importante:** Dans le cas de rferences multiples, consulter la section des applications du catalogue. / **Nota importante:** Se pueden usar intercambios competitivos para propósitos de almacenamiento solamente. Cuando se identifican intercambios múltiples, consulte la sección de aplicaciones de este catálogo.

COMPETITIVE & O.E.M. INTERCHANGE LIST
Lista de Intercambios contra Competidores y Equipo Original.
Liste dinterchange de produits comptitifs & dquipement original (OEM)

O'Reilly... cont'd

O'reilly	Gabriel	Upgrade	O'reilly	Gabriel	Upgrade	O'reilly	Gabriel	Upgrade	O'reilly	Gabriel	Upgrade
33GM1108	G56928		33HN1152	G57416		33NS1110	G57200		33TY1174	G57330	
33GM1109	G57047		33HN1164	G57604		33NS1111	G57474		33TY1174	G57567	
33GM1110	G57000		33HN1165	G57603		33NS1112	G57473		33TY1175	G57329	
33GM1110	G57023		33HY1100	G57059		33NS1137	G57092		33TY1175	G57566	
33GM1111	G57378		33HY1101	G57149		33NS1154	G57035		33TY1180	G57651	
33GM1112	G57377		33HY1104	G57168		33NS1155	G57034		33TY1181	G57650	
33GM1113	G57099		33HY1105	G57167		33NS1158	G57646		33TY1182	G57193	
33GM1113	G57100		33HY1106	G57269		33NS1158	G57647		33TY1184	G57353	
33GM1114	G57070		33HY1107	G57268		33NS1159	G57145		33TY1185	G57354	
33GM1114	G57122		33HY1108	G57279		33NS1160	G57144		33TY1192	G57573	
33GM1115	G57069		33HY1109	G57219		33SB1101	G57430		33TY1193	G57572	
33GM1115	G57121		33HY1110	G57218		33SB1104	G57706		33TY1194	G57569	
33GM1116	G57125		33HY1111	G57278		33SB1106	G57460		33TY1195	G57568	
33GM1118	G57111		33HY1112	G57140		33SB1107	G57459		33TY1202	G57544	
33GM1118	G57536		33HY1113	G57139		33SB1109	G57629		33TY1203	G57543	
33GM1119	G57110		33HY1118	G57343		33SB1109	G57705		33TY1209	G57397	
33GM1119	G57535		33HY1119	G57344		33SB1110	G57628		33TY1216	G57587	
33GM1120	G57109		33HY1120	G57759		33SB1110	G57704		33TY1217	G57586	
33GM1120	G57314		33HY1121	G57059		33SB1136	G57643		33VO1100	G57338	
33GM1136	G57048		33HY1122	G57758		33SB1137	G57642		33VO1101	G57337	
33GM1138	G57108		33HY1127	G57399		33SB1140	G57673		33VO1102	G57335	
33GM1139	G57107		33HY1128	G57398		33SB1141	G57674		33VO1102	G57336	
33GM1141	G57198		33HY1129	G57401		33SC1100	G57370		33VW1100	G57156	
33GM1142	G57197		33HY1130	G57400		33SC1101	G57369		33VW1100	G57277	
33GM1147	G57198		33JP1100	G57007		33SC1102	G57429		33VW1101	G57039	
33GM1147	G57323		33JP1101	G57008		33SC1103	G57428		33VW1103	G57006	
33GM1148	G57197		33JP1102	G57083		33SZ1100	G57126		33VW1103	G57392	
33GM1148	G57322		33JP1103	G57083		33SZ1101	G57127		33VW1104	G57206	
33GM1149	G57051		33JP1104	G57463		33SZ1102	G57128		33VW1105	G57206	
33HN1110	G57208		33JP1105	G57464		33SZ1103	G57129		34759	81833	
33HN1110	G57418		33JP1107	G57765		33TY1108	G57124		34762	G63896	
33HN1111	G57207		33JP1108	G57764		33TY1108	G57453		34787	G63615	
33HN1111	G57417		33KA1102	G57609		33TY1109	G57123		34788	G63616	
33HN1112	G57391		33KA1103	G57608		33TY1110	G57221		34791	G63692	
33HN1113	G57390		33KA1108	G57690		33TY1111	G57220		34828	G63510	
33HN1114	G57087		33KA1109	G57689		33TY1112	G57068		34831	81096	
33HN1115	G57086		33KA1110	G57276		33TY1113	G57067		34912	G63625	
33HN1116	G56992		33KA1111	G57275		33TY1114	G57405		34919	G63411	
33HN1117	G56991		33LX1100	G57421		33TY1116	G56948		34BK1102	G57274	
33HN1118	G57055		33LX1101	G57420		33TY1117	G56948		34CH1113	G57113	
33HN1119	G57054		33MZ1103	G57362		33TY1118	G56950		34CH1114	G57112	
33HN1120	G57598		33MZ1104	G57361		33TY1119	G56949		34CH1119	G56957	
33HN1121	G57597		33MZ1109	G57509		33TY1120	G57404		34CH1120	G56956	
33HN1122	G57056		33MZ1110	G57510		33TY1121	G57106		34CH1121	G56975	
33HN1123	G56943		33NS1101	G57118		33TY1122	G57105		34CH1122	G56973	
33HN1124	G57331		33NS1101	G57413		33TY1153	G56933		34CH1122	G56974	
33HN1124	G57480		33NS1101	G57647		33TY1154	G56932		34DG1107	G56975	
33HN1124	G57602		33NS1102	G57092		33TY1163	G57454		34DG1109	G57177	
33HN1125	G57419		33NS1103	G57159		33TY1164	G57452		34DG1110	G57176	
33HN1126	G57332		33NS1103	G57160		33TY1165	G57451		34FD1122	G56935	
33HN1126	G57479		33NS1104	G57202		33TY1166	G57376		34FD1123	G56936	
33HN1126	G57601		33NS1105	G57203		33TY1167	G57375		34FD1124	G56934	
33HN1147	G57696		33NS1106	G57036		33TY1168	G57330		34FD1124	G56937	
33HN1148	G57695		33NS1107	G57035		33TY1169	G57329		34FD1125	G57016	
33HN1151	G57682		33NS1108	G57034		33TY1170	G57330		34FD1126	G57173	
33HN1151	G57691		33NS1109	G57201		33TY1171	G57329		34FD1135	G57518	

Important Note: Competitive Interchanges are to be used for stocking purposes only. Where multiple crosses are identified, please reference the applications section of this catalog. / **Remarque importante:** Les interchanges concurrentiels ne s'utilisent qu'aux fins de stocks. Dans le cas de références multiples, consulter la section des applications du catalogue. / **Nota importante:** Dans le cas de références multiples, consulter la section des applications du catalogue. / **Nota importante:** Se pueden usar intercambios competitivos para propósitos de almacenamiento solamente. Cuando se identifican intercambios múltiples, consulte la sección de aplicaciones de este catálogo.

COMPETITIVE & O.E.M. INTERCHANGE LIST
Lista de Intercambios contra Competidores y Equipo Original.
Liste dinterchange de produits comptitifs & dquipement original (OEM)

O'Reilly... cont'd

O'reilly	Gabriel	Upgrade	O'reilly	Gabriel	Upgrade	O'reilly	Gabriel	Upgrade	O'reilly	Gabriel	Upgrade
34FD1136	G57517		34NS1118	G57185		34TY1141	G57041		37094	G63353	
34FD1164	G57496		34NS1119	G57184		34TY1142	G57079		37095	G63410	
34FD1165	G57495		34NS1120	G57164		34TY1143	G57078		37095	G63414	
34GM1121	G56924		34NS1121	G57163		34TY1144	G57190		37096	G63359	
34GM1122	G56925		34NS1126	G57031		34TY1145	G57115		37097	G63950	
34GM1123	G56938		34NS1127	G57030		34TY1146	G57114		37100	G63904	
34GM1124	G56927		34NS1133	G57162		34TY1147	G56931		37102	G63661	
34GM1125	G56951		34NS1133	G57368		34TY1148	G56930		37104	G63673	
34GM1126	G57060		34NS1134	G57161		34TY1149	G57357		37109	G63708	
34GM1127	G57324		34NS1134	G57367		34TY1150	G57358		37111	G63937	
34GM1128	G57051		34NS1135	G57031		34TY1157	G57500		37112	G63689	
34GM1129	G56925		34NS1136	G57030		34TY1158	G57499		37117	G63623	
34GM1130	G56924		34NS1144	G57494		34TY1159	G52007		37121	G63490	
34GM1131	G57060		34NS1145	G57493		34TY1159	G57204		37123	G63690	
34GM1133	G57060		34NS1148	G57546		34TY1160	G52004		37129	G63421	
34GM1134	G56925		34NS1149	G57545		34TY1160	G57205		37130	G63609	
34GM1135	G56924		34NS1161	G57773		34TY1161	G57664		37130	G63818	
34GM1136	G56925		34NS1162	G57772		34TY1161	G57666		37134	G63715	
34GM1137	G56924		34NS1163	G57775		34TY1162	G57663		37135	G63722	
34GM1140	G56929		34NS1164	G57774		34TY1162	G57665		37137	G63915	
34HN1127	G57050		34PC1100	G57141		34TY1172	G56731		37149	G63783	
34HN1128	G57049		34PC1101	G57142		34TY1173	G56730		37151	G63803	
34HN1129	G57415		34SB1113	G57365		34TY1176	G57349		37152	G63675	
34HN1130	G57414		34SB1114	G57366		34TY1177	G57350		37156	G63869	
34HN1131	G57085		34SB1115	G57516		34TY1178	G57733		37160	G63710	
34HN1132	G57084		34SB1116	G57515		34TY1179	G57732		37161	G63847	
34HN1133	G57223		34SB1117	G57340		34TY1188	G57615		37162	G63829	
34HN1134	G57222		34SB1118	G57339		34TY1188	G57649		37183	G63832	
34HN1135	G57119		34SB1119	G57345		34TY1189	G57614		37184	G63828	
34HN1135	G57606		34SB1120	G57346		34TY1189	G57648		37187	82035	
34HN1136	G57120		34SB1121	G57478		34TY1198	G57484		37197	G63506	
34HN1136	G57605		34SB1122	G57477		34TY1199	G57483		37198	G63694	
34HN1137	G57334		34SB1125	G57342		34TY1222	G57482		37199	69813	
34HN1138	G57333		34SB1126	G57341		34TY1223	G57481		37203	G63844	
34HN1139	G57522		34SB1127	G57340		34TY1228	G57153		37204	G63845	
34HN1140	G57521		34SB1128	G57339		34TY1229	G57152		37206	G63958	
34HN1141	G57012		34TY1123	G57191		37016	G63635		37217	69900	
34HN1142	G57011		34TY1123	G57540		37022	G63495		37219	G64049	
34HN1153	G57138		34TY1124	G57191		37022	G63909		37220	G63905	
34HN1154	G57137		34TY1125	G57190		37026	G63721		37225	G64027	
34HY1114	G57089		34TY1125	G57539		37029	G63419		37226	G64028	
34HY1115	G57088		34TY1126	G57098		37029	G63928		37231	G63720	
34HY1116	G57394		34TY1127	G57097		37031	G63404		37237	69907	
34HY1117	G57393		34TY1128	G57077		37033	G63548		37241	G63842	
34KA1116	G57489		34TY1129	G57076		37044	G63488		37242	61717	
34KA1117	G57490		34TY1130	G57372		37047	G63813		37244	G63864	
34KA1118	G57091		34TY1131	G57373		37047	G63902		37251	G63878	
34KA1119	G57090		34TY1132	G56933		37050	G63489		37252	G63883	
34KA1120	G57488		34TY1133	G56932		37065	G63426		37253	G63875	
34KA1121	G57487		34TY1134	G57044		37070	G63799		37269	G64105	
34LX1102	G57150		34TY1135	G57043		37073	G63173		37270	G63885	
34LX1105	G57151		34TY1136	G57193		37073	G63492		37270	G64029	
34NS1113	G57158		34TY1137	G57192		37073	G63866		37270	G64030	
34NS1114	G57157		34TY1138	G56930		37074	G63620		37272	70000	
34NS1116	G57031		34TY1139	G56931		37082	G63683		37273	G64031	
34NS1117	G57030		34TY1140	G57042		37091	G63413		37274	G64033	

Important Note: Competitive Interchanges are to be used for stocking purposes only. Where multiple crosses are identified, please reference the applications section of this catalog./ **Remarque importante:** Les interchanges concurrentiels ne s'utilisent qu'aux fins de stocks. Dans le cas de rfrences multiples, consulter la section des applications du catalogue./ **Nota importante:** Dans le cas de rfrences multiples, consulter la section des applications du catalogue./ **Nota importante:** Se pueden usar intercambios competitivos para propósitos de almacenamiento solamente. Cuando se identifican intercambios múltiples, consulte la sección de aplicaciones de este catálogo.

COMPETITIVE & O.E.M. INTERCHANGE LIST
Lista de Intercambios contra Competidores y Equipo Original.
Liste d'interchange de produits comptitifs & d'equipement original (OEM)

O'Reilly... cont'd

O'reilly	Gabriel	Upgrade	O'reilly	Gabriel	Upgrade	O'reilly	Gabriel	Upgrade	O'reilly	Gabriel	Upgrade
37275	69595		5783	69592		71405	G56539		801593	G56568	
37276	69594		5783	69593		71417	G51714		801594	G56601	
37279	G63889		5784	69591		71435	G56562		801616	G55901	
37280	G64006		5796	69464		71436	G56561		801654	G55879	
37281	G64032		5796	69465		71441	G56688		801655	G55879	
37288	70010		5799	70001		71442	G56687		801661	G55948	
37289	G64026		5801	69625		71453	G56581		801662	G55949	
37290	G64042		5803	69606		71454	G56582		801669	G55856	
37298	G64038		5804	69600		71577	G51728		801678	G56514	
37302	G64037		5811	82011		71590	G56518		801679	G56506	
37308	G64052		5819	82004		71591	G56518		801680	G56676	
37313	G64056		5819	82069		71685	G56509		801681	G56675	
37315	G64040		5820	69724		71845	G55579		801691	G55870	
37318	G64047		5823	81491		72114	G56660		801728	G56700	
37323	70078		5826	82025		72115	G56661		801803	G55551	
37326	G51966		5831	69624		72185	G56678		801822	G56718	
37328	G64050		5839	69795		72186	G56677		801857	G55591	
39002	69996		5845	69755		72203	G56809		801933	G55991	
39004	69677		5850	69622		72209	G56774		801952	G55999	
39006	69766		5850	81880		72210	G56773		801953	G55662	
39020	69952		58653	G64079		72257	G56837		801953	G55999	
39027	70024		5867	69676		72258	G56836		801954	G55661	
39040	70040		5868	69787		72261	G51859		801962	G55681	
39047	70033		5892	69714		72263	G52006		801964	G55697	
39051	G64046		5892	69811		72264	G52005		801973	G55698	
39102	69946		5893	69715		72312	G56899		802116	G52014	
39107	70034		5928	69757		72322	G51737		802117	G52013	
39114	70031		5947	69725		72562	G51877		802143	G56799	
39130	70038		5968	69898		72562	G51878		802144	G56800	
40040	81873		5971	69962		801100	G51815		802179	G56810	
40044	81922		5975	69901		801256	G55804		802205	G56722	
40047	G51891		5980	69903		801281	G55825		802206	G56721	
40210	81930		5984	69945		801293	G51087		802207	G56729	
550018	69574		5987	69450		801297	G51252		802208	G56728	
5601	70028		5988	69863		801312	G51279		802236	G56797	
5607	70003		5989	69473		801326	G51713		802237	G56798	
5614	70013		5991	70020		801341	G51718		802248	G51760	
5615	70049		5993	69575		801352	G51077		802248	G51761	
5616	70045		5996	69420		801371	G51739		802267	G52009	
5618	70039		66417	G63918		801372	G51738		802268	G52008	
5621	70036		71103	G51765		801377	G56807		802295	G56887	
5622	70037		71128	G52131		801426	G56672		802296	G56886	
5626	70041		71138	G51860		801427	G56671		802307	G56889	
5639	70027		71139	G51861		801433	G56621		802308	G56888	
5751	82026		71141	G51864		801434	G56622		802367	G52082	
5754	82138		71321	G51722		801437	G55994		802368	G52081	
5756	82070		71322	G51724		801438	G55993		802378	G52095	
5757	82060		71327	G51727		801451	G56758		802379	G52094	
5760	82609		71332	69586		801452	G56759		802392	G52122	
5762	82615		71348	G51477		801504	G56517		802393	G52121	
5765	82118		71350	69998		801505	G56516		802401	G51842	
5766	82051		71361	G51704		801525	G56606		802518	G52125	
5777	69585		71362	G51703		801565	G51267		82196	81936	
5778	69589		71373	G51736		801572	G56620		82306	81929	
5778	69590		71398	G51723		801580	G55892		911039	G63456	
5779	69587		71404	G56540		801592	G55896		911228	G63879	

Important Note: Competitive Interchanges are to be used for stocking purposes only. Where multiple crosses are identified, please reference the applications section of this catalog. / **Remarque importante:** Les interchanges concurrentiels ne s'utilisent qu'aux fins de stocks. Dans le cas de références multiples, consulter la section des applications du catalogue. / **Nota importante:** Dans le cas de références multiples, consulter la section des applications du catalogue. / **Nota importante:** Se pueden usar intercambios competitivos para propósitos de almacenamiento solamente. Cuando se identifican intercambios múltiples, consulte la sección de aplicaciones de este catálogo.

COMPETITIVE & O.E.M. INTERCHANGE LIST
Lista de Intercambios contra Competidores y Equipo Original.
Liste d'interchange de produits compititifs & d'equipement original (OEM)

PRT

Prt	Gabriel	Upgrade	Prt	Gabriel	Upgrade	Prt	Gabriel	Upgrade	Prt	Gabriel	Upgrade
920728	G57853		920729	G57852							

PRT (ADD)

Prt (add)	Gabriel	Upgrade	Prt (add)	Gabriel	Upgrade	Prt (add)	Gabriel	Upgrade	Prt (add)	Gabriel	Upgrade
141251	G52174		171295	83137		173328	70000		173620	61676	
170129	85303	89422	171376	81924		173436	61659		173620	81926	
170129	85320	89429	171384	81096		173436	61777		173621	61635	
170129	89422		171430	82126		173436	81924		173621	61714	
170129	89429		172127	61651		173471	69591		173622	61599	
170130	85001	89410	172127	69813		173493	G64111		173622	81928	
170130	89410		172131	61606		173504	61544		173623	61638	
170132	85724	89443	172131	G51077		173504	61555		173623	81892	
170132	89443		172174	69585		173504	61685		173624	61613	
170133	85060		172174	70001		173504	81668		173624	81914	
170133	85959		172193	61560		173504	81713		173625	61641	
170139	85003	89411	172193	81904		173505	61543		173625	81920	
170139	89411		172288	81459		173505	61565		173626	61654	
170140	85014		172289	81495		173505	81667		173627	61656	
170146	83207	89407	172293	G63845		173506	61601		173627	61682	
170146	89407		172321	69587		173506	81836		173628	61626	
170148	83456	89447	172331	61592		173509	61504		173628	81916	
170148	89447		172331	81937		173509	61601		173650	G64027	
170198	81744		172358	61651		173509	81516		173651	G64028	
170207	81510		172358	69813		173509	81750		173655	61528	
170211	85058	89431	172359	61651		173509	81836		173655	81482	
170211	89431		172359	69813		173510	61512		173656	61662	
170213	85054		172371	69676		173510	61542		173680	81091	
170215	85918	89449	172371	81481		173510	61555		173681	81484	
170215	85920	89503	172372	69464		173510	81559		173682	81691	
170215	89449		172372	81935		173510	81713		173684	81559	
170215	89503		172373	69473		173510	81726		173686	G63387	
170217	83163		172404	69606		173523	61535		173687	81744	
170221	85921		172404	81495		173523	81548		173688	61704	
170222	83175		172405	61717		173542	61536		173688	69909	
170225	83136		172412	G51077		173542	81549		173690	61591	
170228	G63969		172413	69589		173564	69900		173690	81744	
170237	83136		172436	G64052		173575	61655		173691	61595	
170243	85069	89455	172439	G64105		173579	61623		173691	81833	
170243	89455		172452	61690		173579	81893		173692	61703	
170245	83122	89406	172453	G63872		173581	61591		173693	61658	
170245	89406		172461	70027		173581	81744		173693	81923	
170246	83123	89405	172480	G51807		173582	61646		173694	61643	
170246	89405		172704	69606		173582	81828		173694	81922	
170247	85006		172704	81495		173583	61626		173695	81930	
170248	83137		173001	61506		173583	61627		173696	61641	
170248	85976		173001	81318		173583	81917		173696	61663	
170249	85927		173070	82156		173584	61542		173696	81920	
170257	G64177		173098	61508		173584	61555		173696	81921	
170262	83159		173098	81507		173584	81726		173696	81922	
170263	85071		173099	81494		173585	61611		173696	81925	
170264	83515		173170	61605		173585	81912		173697	61642	
170296	69755		173170	81878		173586	61600		173697	61675	
170335	G63717		173176	61506		173586	81873		173697	81921	
170366	61529		173176	81318		173616	81496		173697	81930	
170464	81492		173196	G63720		173617	61546				
170469	G63809		173228	61500		173618	61625				
170740	81076		173293	81446		173619	61664				
170996	81270		173296	82125		173619	81869				

Important Note: Competitive Interchanges are to be used for stocking purposes only. Where multiple crosses are identified, please reference the applications section of this catalog. / **Remarque importante:** Les interchanges concurrentiels ne s'utilisent qu'aux fins de stocks. Dans le cas de rferences multiples, consulter la section des applications du catalogue. / **Nota importante:** Dans le cas de rferences multiples, consulter la section des applications du catalogue. / **Nota importante:** Se pueden usar intercambios competitivos para propósitos de almacenamiento solamente. Cuando se identifican intercambios múltiples, consulte la sección de aplicaciones de este catálogo.

COMPETITIVE & O.E.M. INTERCHANGE LIST
Lista de Intercambios contra Competidores y Equipo Original.
Liste dinterchange de produits comptitifs & dquipement original (OEM)

PRT (ADD)... cont'd

Prt (add)	Gabriel	Upgrade	Prt (add)	Gabriel	Upgrade	Prt (add)	Gabriel	Upgrade	Prt (add)	Gabriel	Upgrade
173698	61642		173821	G63918		173928	G64040		175450	81744	
173698	61675		173823	61712		173932	G64079		175452	61690	
173698	61691		173823	81933		173933	61713		175454	69595	
173698	61692		173824	61675		173934	G64071		175456	69594	
173698	81921		173824	81930		173935	G51980		175457	G64031	
173698	81930		173825	61714		173935	G64042		175458	61675	
173698	81931		173826	61641		173936	G51812		175458	81930	
173700	69898		173826	61663		173937	G64050		177083	61605	
173700	81794		173826	81920		173938	G64104		177083	81878	
173701	61615		173826	81925		173939	G64043		177085	61675	
173701	81936		173827	G63870		173941	70078		177085	81930	
173704	61614		173828	G63867		173942	69590		190008	70095	
173705	61658		173828	G64157		173943	G64111		190008	70102	
173705	81923		173830	61700		173944	G64121		192404	69606	
173708	61500		173831	G51850		173945	G64042		192404	81495	
173708	81147		173831	G63879		173946	70010		192409	61734	
173725	61679		173831	G63882		173961	G64163		192411	61720	
173727	61593		173832	61565		173962	70203		193206	61608	
173727	81872		173833	G63889		173985	82128		193208	G63707	
173728	81911		173839	61643		174044	G63306		193574	69901	
173729	61616		173839	61683		174072	61531		193575	61655	
173729	81929		173839	81922		174072	81516		193576	G63726	
173730	69675		173840	G63844		174072	81750		193577	61565	
173730	81446		173841	61684		174088	81484		193577	61687	
173731	61510		173841	61685		174244	61523		193580	61624	
173731	81871		173842	G64032		174244	81096		193580	81890	
173733	69962		173843	G51812		174283	61643		193581	61591	
173733	81927		173843	G51981		174283	81922		193581	81744	
173735	61565		173851	G63873		174303	61523		193582	61646	
173735	61687		173857	G63918		174303	81096		193582	81828	
173736	61522		173858	61704		174315	81710		193583	81891	
173736	81496		173859	61680		174340	81582		193598	70098	
173738	81091		173860	61685		174386	G64033		193598	70208	
173739	81164		173862	61777		174408	G63404		193655	61528	
173741	61629		173863	61654		174441	61642		193655	81482	
173741	81918		173886	61662		174441	81921		193657	61539	
173766	69962		173887	69587		174442	81922		193695	61675	
173766	81927		173888	81507		174546	61715		193695	81930	
173769	61634		173889	G64026		174575	61638		193697	61675	
173769	81919		173890	G64048		174575	81892		193698	81921	
173800	81932		173892	61711		174576	61612		193702	G63782	
173802	61692		173893	70060		174576	81913		193703	G63781	
173802	61710		173894	61687		175075	81039		193706	G63809	
173802	61716		173895	81676		175093	81730		193707	G63815	
173803	G63884		173896	G64037		175357	61642		193724	81318	
173804	G63879		173898	69592		175357	81921		193805	G63815	
173804	G63882		173898	69593		175366	G63832		193818	G63837	
173806	G63885		173899	G64087		175367	G63828		193819	61663	
173806	G64029		173900	70039		175404	G63864		193820	G64000	
173806	G64030		173901	61696		175407	G63883		193834	G63607	
173813	G64087		173901	61697		175408	G63878		194267	61642	
173814	G64006		173903	61655		175409	61718		194267	81921	
173815	61612		173904	G64080		175441	61710		194432	81667	
173815	81913		173912	69591		175442	G63875		194506	61676	
173816	G51802		173913	82602		175448	61682		194506	81926	
173817	G51814		173924	G511001		175449	61713		194510	69575	

Important Note: Competitive Interchanges are to be used for stocking purposes only. Where multiple crosses are identified, please reference the applications section of this catalog. / **Remarque importante:** Les interchanges concurrentiels ne s'utilisent qu'aux fins de stocks. Dans le cas de références multiples, consulter la section des applications du catalogue. / **Nota importante:** Dans le cas de références multiples, consulter la section des applications du catalogue. / **Nota importante:** Se pueden usar intercambios competitivos para propósitos de almacenamiento solamente. Cuando se identifican intercambios múltiples, consulte la sección de aplicaciones de este catálogo.

COMPETITIVE & O.E.M. INTERCHANGE LIST
Lista de Intercambios contra Competidores y Equipo Original.
Liste dinterchange de produits comptitifs & dquipement original (OEM)

PRT (ADD)... cont'd

Prt (add)	Gabriel	Upgrade	Prt (add)	Gabriel	Upgrade	Prt (add)	Gabriel	Upgrade	Prt (add)	Gabriel	Upgrade
194511	G63625		372345	G51727		373284	G51898		374126	G51861	
194539	69574		372349	69465		373287	G51286		374128	G51900	
194539	69575		372350	G51910		373288	70089		374130	G51916	
194564	81869		372351	G51908		373289	G51898		374130	G51975	
194574	69575		372360	70056		373290	G51286		375007	69998	
194580	G51904		372361	G51852		373297	G51993		375022	G51724	
343162	G51804		372362	G51841		373301	G51832		375023	G51722	
349058	G51077		372364	70052		373303	G51966		375024	G51715	
349076	G51887		372366	G51905		373305	G51833		375027	G51928	
349122	G64046		372370	70055		373307	70037		375028	G51870	
370018	G64148		372382	70056		373308	G51847		375028	G51891	
370087	G51920		372387	G51759		373312	G64056		375028	G51949	
370088	G51921		373111	G51713		373313	70089		375030	G51765	
370100	70041		373111	G51714		373314	G51884		375031	G51766	
370126	G51879		373123	G55825		373315	G511055		375032	G51860	
370439	69966		373124	G51767		373316	G511054		375033	G51861	
370480	G51738		373139	G51881		373317	G51848		375034	G51864	
370504	G511043		373142	G51700		373318	G51863		375037	G51865	
370523	G51848		373150	G55821		373319	70059		375038	G51865	
370716	70052		373162	G51804		373319	70204		390107	70052	
370796	70065		373169	G51713		373320	70053		392226	70033	
370797	G51937		373192	G56597		373330	G51799		392226	70038	
370816	82011		373193	G51738		373333	G51825		392352	G51746	
371008	G51252		373194	69907		373348	G51856		392383	G511001	
371012	G51063		373195	G51858		373352	69420		392393	G511001	
371019	69946		373198	G51739		373358	G511002		393171	G51477	
371090	69450		373201	G51799		373358	G511134		393338	G51922	
371176	81934		373201	G56899		373367	G511122		394058	G51077	
371231	G51965		373202	G51983		373367	G511123		394075	G51887	
371305	G511092		373204	G51850		373368	G511122		394076	G51888	
372010	G51256		373206	G51798		373368	G511123		394091	G51477	
372046	G56591		373207	G51803		373373	G51933		414649	G56735	
372060	69945		373213	G51783		373374	G64049		414909	G56733	
372095	69945		373223	G51842		373376	G51961		470110	G55910	
372095	81934		373227	G51736		373380	G51898		470401	G52248	
372148	G51279		373231	G56598		373382	G51972		470402	G52247	
372157	G51254		373238	G51805		373385	G511044		470405	G52163	
372161	G51727		373242	G51716		373386	G64216		470406	G52162	
372184	G51795		373244	G511004		373804	G51850		470407	G52332	
372221	69863		373247	G51849		374067	G51704		470408	G52331	
372236	70040		373248	G64038		374070	G51719		470409	G52204	
372237	70020		373250	G51721		374070	G51860		470410	G52203	
372248	G51254		373251	G51883		374071	G51729		470411	G52118	
372288	70036		373251	G51969		374074	G51723		470412	G52117	
372291	70003		373253	G52037		374078	G51703		470427	G52131	
372294	G51794		373254	G52036		374085	G51849		470455	G51774	
372295	G51794		373255	70045		374086	G51849		470465	G52183	
372298	69586		373256	70013		374090	G51477		470466	G52182	
372304	70028		373257	G51880		374091	G51477		470467	G52103	
372313	70055		373259	G51854		374110	G56838		470468	G52104	
372316	70036		373260	G51853		374111	G56839		470470	G52103	
372320	G51971		373269	G51879		374112	G51937		470473	G56889	
372333	70041		373271	70034		374113	G51855		470474	G56888	
372336	G51807		373276	70037		374116	69998		470475	G52210	
372337	G51838		373278	G51898		374117	G51742		470476	G52209	
372340	G51908		373280	70086		374118	G51836		470477	G56889	

Important Note: Competitive Interchanges are to be used for stocking purposes only. Where multiple crosses are identified, please reference the applications section of this catalog. / **Remarque importante:** Les interchanges concurrentiels ne s'utilisent qu'aux fins de stocks. Dans le cas de rfrences multiples, consulter la section des applications du catalogue. / **Nota importante:** Dans le cas de rfrences multiples, consulter la section des applications du catalogue. / **Nota importante:** Se pueden usar intercambios competitivos para propósitos de almacenamiento solamente. Cuando se identifican intercambios múltiples, consulte la sección de aplicaciones de este catálogo.

COMPETITIVE & O.E.M. INTERCHANGE LIST
Lista de Intercambios contra Competidores y Equipo Original.
Liste d'interchange de produits compititifs & d'equipement original (OEM)

PRT (ADD)... cont'd

Prt (add)	Gabriel	Upgrade	Prt (add)	Gabriel	Upgrade	Prt (add)	Gabriel	Upgrade	Prt (add)	Gabriel	Upgrade
470478	G56888		473821	G56529		474240	G52272		474525	G56684	
470489	G52176		473822	G56530		474241	G52106		474525	G56686	
470490	G52175		473851	G51926		474242	G52105		474526	G56683	
470767	G52103		473852	G51925		474243	G56841		474526	G56685	
471025	G51255		473857	G51981		474244	G56840		474545	G56758	
471045	G51097		473858	G51979		474247	G52246		474546	G56759	
471055	G55999		473859	G52095		474248	G52245		474547	G56660	
471056	G55999		473860	G52094		474249	G52122		474548	G56661	
471137	G55879		473863	G52283		474250	G52121		474553	G56894	
471138	G55879		473864	G52282		474251	G52174		474557	G56820	
471180	G55909		473879	G51859		474252	G52173		474558	G56819	
471183	G55870		473880	G51859		474257	G52171		474577	G52009	
471288	G55772		473885	G51806		474258	G52170		474578	G52008	
471385	G52161		473893	G51981		474261	G52246		474579	G56581	
471386	G52160		473894	G51979		474262	G52245		474580	G56582	
472057	G56540		473897	70049		474274	G52131		474583	G52014	
472058	G56539		473899	G51718		474283	G52202		474584	G52013	
472079	G52354		473901	G51911		474284	G52201		474587	G56735	
472080	G52353		473903	G51918		474305	G52238		474588	G56734	
472101	G51859		473904	G51917		474306	G52237		474588	G56735	
472102	G51859		473909	G51897		474311	G56633		474599	G56643	
472119	G511003		473910	G51896		474312	G56634		474600	G56642	
473003	G56514		473911	G51892		474317	G52300		474607	G51760	
473004	G56506		473911	G51919		474318	G52299		474608	G51761	
473073	G55662		473913	G51097		474319	G55772		474617	G52108	
473074	G55661		473915	G51815		474321	G51267		474617	G56797	
473206	G51806		473919	G52153		474323	G55856		474618	G52107	
473340	G51268		473920	G52152		474354	G55896		474618	G56798	
473358	G51737		473925	G56887		474363	G52261		474621	G51097	
473402	G56894		473926	G56886		474364	G52260		474635	G52368	
473403	G52098		473935	G51980		474368	G51728		474635	G56729	
473407	G51814		473944	G64121		474381	G55892		474636	G52367	
473407	G51979		474008	G52025		474385	G52108		474636	G56728	
473408	G51813		474008	G55948		474386	G52107		474650	G56734	
473439	G56529		474015	G52244		474397	G55901		474653	G56773	
473440	G56530		474015	G55949		474399	G55901		474654	G56774	
473453	G51815		474103	G52027		474403	G55698		474659	G52141	
473454	G51806		474103	G52128		474407	G56620		474660	G52140	
473465	G51878		474104	G52026		474409	G52275		474704	G51758	
473466	G51877		474104	G52127		474410	G52274		474705	G51758	
473485	70068		474121	G56802		474416	G56655		474729	G55697	
473485	70209		474133	G52165		474431	G52188		474743	G56622	
473639	G55879		474133	G52298		474432	G52187		474744	G56621	
473640	G55879		474134	G52164		474433	G52155		474765	G52334	
473671	G56893		474134	G52297		474433	G52188		474766	G52333	
473672	G56892		474135	G55676		474434	G52154		474771	G55579	
473685	G51714		474136	G55675		474462	G56817		474772	G56802	
473719	G55999		474177	G56517		474468	G51267		474773	G56684	
473720	G55999		474178	G56516		474480	G51097		474773	G56686	
473748	G52019		474209	G52106		474482	G51740		474774	G56683	
473761	G56887		474210	G52105		474485	G56581		474774	G56685	
473762	G56886		474215	G52265		474486	G56582		474776	G56606	
473771	G51811		474215	G56821		474513	G52006		474805	G56641	
473772	G51810		474216	G52264		474514	G52005		474806	G56640	
473817	G52018		474216	G56822		474517	G52155		474850	G52237	
473818	G52017		474239	G52273		474518	G52154		474851	G52238	

Important Note: Competitive Interchanges are to be used for stocking purposes only. Where multiple crosses are identified, please reference the applications section of this catalog. / **Remarque importante:** Les interchanges concurrentiels ne s'utilisent qu'aux fins de stocks. Dans le cas de références multiples, consulter la section des applications du catalogue. / **Nota importante:** Dans le cas de références multiples, consulter la section des applications du catalogue. / **Nota importante:** Se pueden usar intercambios competitivos para propósitos de almacenamiento solamente. Cuando se identifican intercambios múltiples, consulte la sección de aplicaciones de este catálogo.

COMPETITIVE & O.E.M. INTERCHANGE LIST
Lista de Intercambios contra Competidores y Equipo Original.
Liste dinterchange de produits comptitifs & dquipement original (OEM)

PRT (ADD)... cont'd

Prt (add)	Gabriel	Upgrade	Prt (add)	Gabriel	Upgrade	Prt (add)	Gabriel	Upgrade	Prt (add)	Gabriel	Upgrade
474851	G56751		475072	G56538		475321	G56799		476822	G52439	
474852	G56750		475072	G56634		475322	G56800		476851	G52349	
474863	G56568		475077	G55681		475323	G56791		476852	G52348	
474864	G56601		475078	G56509		475323	G56792		477103	G52256	
474885	G55993		475084	G56807		475327	G56799		477104	G52255	
474886	G55994		475091	G56616		475328	G56800		477213	G51738	
474887	G56635		475091	G56688		475331	G56778		477217	G52436	
474888	G56636		475092	G56615		475347	G52116		477218	G52435	
474907	G56680		475092	G56687		475697	G511000		477701	G51738	
474907	G56731		475097	G56726		475725	G52352		478281	G52330	
474908	G56679		475107	G56700		475725	G56841		478282	G52329	
474908	G56730		475123	G56616		475726	G52351		478289	G56758	
474909	G56733		475123	G56688		475726	G56840		478290	G56759	
474910	G56732		475124	G56615		475915	G52128		478313	G52006	
474910	G56734		475124	G56687		475916	G52127		478314	G52005	
474917	G56672		475139	G56791		476007	G56778		478323	G52396	
474918	G56671		475139	G56792		476517	G52157		478324	G52395	
474921	G56784		475149	G52145		476518	G52156		478479	G52330	
474922	G56785		475150	G52144		476555	G52143		478480	G52329	
474923	G56722		475191	G56518		476556	G52142		478587	G52383	
474924	G56721		475192	G56518		476557	G52128		478588	G52382	
474929	G52033		475211	G56561		476558	G52127		478675	G51947	
474930	G52032		475212	G56562		476556	G52125		478675	G51948	
474931	G52111		475213	G56678		476615	G52149		492117	70031	
474932	G52110		475214	G56677		476616	G52148		493923	G51921	
474933	G56843		475215	G56821		476617	G52294		493924	G51920	
474934	G56842		475216	G56822		476618	G52293		496629	G51871	
474937	G52157		475217	G51799		476619	G52254		583052	6850SE	
474938	G52156		475217	G56899		476620	G52253		583053	6847SE	
474939	G52185		475219	G51799		476621	70096		583059	6847SE	
474940	G52184		475219	G56899		476623	G56837		583060	6853SE	
474941	G52082		475239	G56688		476624	G56516		584027	6856SE	
474942	G52081		475240	G56687		476624	G56836		710002	G57118	
474947	G52007		475267	G52159		476625	70096		710017L	G57568	
474948	G52004		475268	G52158		476665	G52375		710017R	G57569	
474953	G56889		475277	G52113		476666	G52374		710077	G57026	
474954	G56888		475278	G52112		476719	G51955		710077	G57075	
474955	G52104		475279	G52250		476733	G52258		710078	G57103	
474956	G52103		475280	G52249		476734	G52257		710079	G57087	
474963	G52104		475281	G55948		476739	G52361		710080	G57086	
474963	G52368		475283	G56509		476740	G52360		710081	G57132	
474964	G52103		475287	G52169		476743	G52525		710082	G57132	
474964	G52367		475288	G52168		476744	G52524		710083	G57108	
474969	G56810		475289	G52151		476745	G52356		710084	G57107	
474970	G56810		475290	G52150		476746	G52355		710098	G57282	
474981	G52274		475297	G52200		476751	G52330		710099	G57027	
474982	G52275		475298	G52199		476752	G52329		710103	G57178	
474989	G52097		475303	G52025		476755	G52128		710103	G57607	
474990	G52096		475303	G55948		476756	G52127		710139	G57425	
474991	G56809		475305	G52130		476757	G52399		710140	G57424	
474992	G56809		475306	G52129		476758	G52398		710150L	G57416	
475033	G52314		475309	G52281		476761	G52383		710150R	G57682	
475034	G52314		475310	G52280		476762	G52382		710251	G57282	
475071	G56537		475311	G52244		476767	G52406		710252	G57092	
475071	G56538		475315	G52113		476793	G52301		710307	G57092	
475071	G56633		475316	G52112		476821	G52440		710310	G57423	

Important Note: Competitive Interchanges are to be used for stocking purposes only. Where multiple crosses are identified, please reference the applications section of this catalog. / **Remarque importante:** Les interchanges concurrentiels ne s'utilisent qu'aux fins de stocks. Dans le cas de rfrences multiples, consulter la section des applications du catalogue. / **Nota importante:** Dans le cas de rfrences multiples, consulter la section des applications du catalogue. / **Nota importante:** Se pueden usar intercambios competitivos para propósitos de almacenamiento solamente. Cuando se identifican intercambios múltiples, consulte la sección de aplicaciones de este catálogo.

COMPETITIVE & O.E.M. INTERCHANGE LIST
Lista de Intercambios contra Competidores y Equipo Original.
Liste dinterchange de produits comptitifs & dquipement original (OEM)

PRT (ADD)... cont'd

Prt (add)	Gabriel	Upgrade	Prt (add)	Gabriel	Upgrade	Prt (add)	Gabriel	Upgrade	Prt (add)	Gabriel	Upgrade
710311	G57598		711011	G57703		715101	G57173		813491	G57035	
710312	G57597		711016	G57057		740098	G57282		813492	G57034	
710313	G57600		711077	G57075		745297	G52200		813493	G57048	
710314	G57599		711193	G57092		810071	G57466		813494	G57047	
710315	G57647		711349	G57134		810072	G57465		813497	G56997	
710317	G57646		711350	G57133		810077	G57311		813498	G56996	
710362	G57421		711388	G57413		810078	G57312		813653	G57397	
710370	G57675		711388	G57646		810110	G56998		813681	G57013	
710371	G57703		711389	G57075		810121	G57039		813685	G57059	
710373	G57429		711390	G57430		810145	G57354		813781	G57203	
710374	G57428		711392	G57423		810146	G57353		813782	G57202	
710375	G57646		712006	G57036		810147	G57645		813845	G57456	
710377	G57452		712161	G57159		810148	G57644		813846	G57455	
710378	G57451		712161	G57160		810161	G57391		813859	G57201	
710410	G57023		713002	G57010		810162	G57390		813860	G57200	
710411	G57036		713005	G57062		810163	G57635		813863	G57542	
710412	G57579		713006	G57061		810164	G57634		813864	G57541	
710413	G57000		713111L	G57090		810173	G56933		813919	G57604	
710415	G57080		713111R	G57091		810174	G56932		813920	G57603	
710416	G57173		713123	G56938		810199	G57500		814008	G56925	
710419	G57683		713171L	G57027		810200	G57499		814008	G57060	
710420	G57683		713171R	G57027		810407	G57739		814009	G57038	
710423	G57573		713193	G57056		810408	G57738		814010	G57037	
710424	G57572		713198L	G57133		810409	G57484		814015L	G56924	
710475	G57080		713198R	G57134		810410	G57483		814015R	G56925	
710757	G57458		713223	G57607		810410	G57658		814043	G56936	
710758	G57457		713278L	G57451		810411	G57466		814078	G56936	
710759	G57458		713278R	G57452		810412	G57465		814079	G56934	
710760	G57457		713318	G57447		810413	G57659		814079	G56937	
710761	G57173		713391	G57573		810414	G57658		814121	G57040	
710770	G57430		713392	G57572		810415	G57677		814128	G56927	
710771	G57706		713397	G57598		810416	G57676		814135	G56933	
710787	G57683		713398	G57597		810425	G57659		814136	G56932	
710788	G57683		713399	G57600		810426	G57658		814139	G56928	
710789	G57441		713400	G57599		810473	G57191		814177	G57064	
710790	G57442		714004	G57019		810474	G57190		814178	G57063	
710793	G57415		714009	G57124		810475	G57362		814231	G57460	
710794	G57414		714009	G57221		810476	G57361		814232	G57459	
710797	G57453		714010	G57123		811021	G56726		814241	G57376	
710798	G57454		714010	G57220		811045L	G57135		814241	G57666	
710863	G57703		714058L	G57065		811045R	G57136		814242	G57375	
710864	G57794		714058R	G57066		811046L	G56991		814242	G57665	
710871	G57453		714067	G57020		811046R	G56992		814243	G57583	
710872	G57454		714068	G57021		812057	G57089		814244	G57582	
710875	G57134		714071	G57016		812058	G57088		814251	G57474	
710876	G57133		714075	G57080		812102	G57148		814252	G57473	
710877	G57683		714078	G57021		813003	G56931		814319	G56928	
710878	G57683		714087	G57015		813004	G56930		814323	G56964	
710879	G57683		714087	G57212		813073	G56950		814349	G57643	
710880	G57683		714088	G57095		813074	G56949		814350	G57642	
710970	G57000		714089	G57096		813258L	G56993		814354	G56965	
710970	G57023		714109	G57023		813258R	G56994		814368L	G57007	
710974	G57067		714109	G57125		813331	G57022		814368R	G57008	
710983	G57068		715022	G57018		813338	G57014		814381	G56975	
710984	G57067		715023	G57017		813453	G57146		814385	G57664	
711010	G56943		715029	G57172		813487	G57409		814386	G57663	

Important Note: Competitive Interchanges are to be used for stocking purposes only. Where multiple crosses are identified, please reference the applications section of this catalog. / **Remarque importante:** Les interchanges concurrentiels ne s'utilisent qu'aux fins de stocks. Dans le cas de références multiples, consulter la section des applications du catalogue. / **Nota importante:** Dans le cas de références multiples, consulter la section des applications du catalogue. / **Nota importante:** Se pueden usar intercambios competitivos para propósitos de almacenamiento solamente. Cuando se identifican intercambios múltiples, consulte la sección de aplicaciones de este catálogo.

COMPETITIVE & O.E.M. INTERCHANGE LIST
Lista de Intercambios contra Competidores y Equipo Original.
Liste dinterchange de produits comptitifs & dquipement original (OEM)

PRT (ADD)... cont'd

Prt (add)	Gabriel	Upgrade	Prt (add)	Gabriel	Upgrade	Prt (add)	Gabriel	Upgrade	Prt (add)	Gabriel	Upgrade
814395	G57643		814961	G57070		815365	G57141		816054	G56930	
814396	G57642		814961	G57122		815367	G57193		816057	G56948	
814401	G57478		814962	G57069		815368	G57192		816058	G56948	
814402	G57477		814962	G57121		815369	G57711		816083	G57366	
814405	G57012		814989	G57370		815370	G57710		816083	G57516	
814406	G57011		814990	G57369		815373	G57397		816084	G57365	
814407L	G56956		815007	G57085		815377	G57055		816084	G57515	
814407R	G56957		815008	G57084		815378	G57054		816089	G57205	
814413	G57127		815009	G57046		815395	G57496		816090	G57204	
814414	G57126		815010	G57045		815396	G57495		816091	G57405	
814423	G57006		815010	G57046		815399	G57615		816092	G57404	
814433	G57276		815011	G57051		815400	G57614		816101	G56925	
814434	G57275		815013	G57053		815457	G57115		816102	G56924	
814523	G57342		815017	G57039		815458	G57114		816125	G57145	
814524	G57341		815019	G57649		815480	G57105		816126	G57144	
814525	G57158		815020	G57648		815881	G57559		816131	G57472	
814526	G57157		815023	G56925		815882	G57558		816132	G57471	
814545	G57120		815024	G56924		815883	G57373		816185	G57432	
814546	G57119		815025	G56925		815883	G57664		816186	G57431	
814547	G57115		815026	G56924		815884	G57372		816225	G57008	
814548	G57114		815027	G57075		815884	G57663		816226	G57007	
814557	G57219		815029	G57613		815907	G57274		816329	G57051	
814558	G57218		815030	G57612		815913	G57394		816333	G57035	
814579	G57106		815037	G57026		815914	G57393		816334	G57034	
814580	G57105		815037	G57075		815915	G57198		816335	G57193	
814587	G57534		815041	G57145		815915	G57323		816336	G57192	
814588	G57533		815042	G57144		815916	G57197		816339	G57142	
814635	G57077		815043	G57497		815916	G57198		816339	G57498	
814635	G57079		815044	G57497		815916	G57322		816340	G57497	
814636	G57076		815045	G57711		815917	G57567		816343	G57709	
814636	G57078		815046	G57710		815918	G57566		816345	G57022	
814695	G57509		815047	G57153		815925	G57106		816348	G57192	
814743	G57050		815048	G57152		815926	G57105		816369	G57575	
814743	G57522		815049	G57747		815927	G57510		816370	G57574	
814744	G57049		815051	G57747		815928	G57509		816385	G57151	
814744	G57521		815052	G57746		815937	G57427		816386	G57150	
814765	G57279		815078	G56929		815939	G57330		816387	G57582	
814766	G57278		815123	G57145		815940	G57329		816509	G57276	
814773	G57158		815124	G57144		815943	G57198		816510	G57275	
814774	G57157		815165	G56935		815944	G57197		816549	G57482	
814797	G57042		815187	G56963		815949	G57422		816550	G57481	
814798	G57041		815187	G56964		815953	G57550		816551	G57674	
814805	G57168		815188	G56962		815954	G57549		816552	G57673	
814806	G57167		815188	G56963		815959	G57148		816553	G57484	
814879	G56933		815211	G57140		815959	G57270		816554	G57483	
814879	G57044		815212	G57139		815967	G57466		816615	G57267	
814880	G56932		815213	G57050		815967	G57578		816615	G57751	
814880	G57043		815214	G57049		815968	G57465		816616	G57266	
814907	G57151		815215	G57344		815968	G57577		816616	G57750	
814908	G57150		815216	G57343		815981	G57332		816631	G57068	
814909	G57153		815219	G57156		815981	G57480		816631	G57358	
814910	G57152		815219	G57277		815981	G57602		816632	G57067	
814917	G57031		815289	G57334		815982	G57331		816632	G57357	
814918	G57030		815290	G57333		815982	G57479		816633	G57193	
814923	G57077		815299	G57060		815982	G57601		816634	G57192	
814924	G57076		815299	G57142		816053	G56931		816635	G57191	

Important Note: Competitive Interchanges are to be used for stocking purposes only. Where multiple crosses are identified, please reference the applications section of this catalog./ **Remarque importante:** Les interchanges concurrentiels ne s'utilisent qu'aux fins de stocks. Dans le cas de rfrences multiples, consulter la section des applications du catalogue./ **Nota importante:** Dans le cas de rfrences multiples, consulter la section des applications du catalogue./ **Nota importante:** Se pueden usar intercambios competitivos para propósitos de almacenamiento solamente. Cuando se identifican intercambios múltiples, consulte la sección de aplicaciones de este catálogo.

COMPETITIVE & O.E.M. INTERCHANGE LIST
Lista de Intercambios contra Competidores y Equipo Original.
Liste d'interchange de produits compétitifs & d'équipement original (OEM)

PRT (ADD)... cont'd

Prt (add)	Gabriel	Upgrade	Prt (add)	Gabriel	Upgrade	Prt (add)	Gabriel	Upgrade	Prt (add)	Gabriel	Upgrade
816635	G57540		816957	G57109		818208	G57734		818653	G57147	
816636	G57190		816957	G57314		818215	G57340		818667	G57649	
816636	G57539		816959	G57324		818216	G57339		818668	G57648	
816637	G57191		817011	G57490		818217	G57692		818669	G57039	
816638	G57190		817012	G57489		818218	G57691		818671	G57051	
816639	G57060		817021	G57702		818219	G57659		818675	G57194	
816639	G57142		817022	G57701		818220	G57658		818675	G57195	
816643	G57129		817025	G57702		818221	G57378		818677	G57148	
816644	G57128		817026	G57701		818222	G57377		818679	G57203	
816645	G57131		817029	G57391		818241	G57641		818680	G57202	
816646	G57130		817030	G57390		818242	G57640		818683	G57563	
816651	G57111		817033	G57725		818243	G57641		818684	G57562	
816651	G57536		817034	G57724		818244	G57640		818687	G57312	
816652	G57110		817035	G57651		818289	G57606		818688	G57311	
816652	G57535		817036	G57650		818290	G57605		818689	G57474	
816653	G57113		817037	G57060		818295	G57715		818690	G57473	
816654	G57112		817041	G57725		818296	G57714		818691	G57378	
816657	G57138		817042	G57724		818297	G57690		818692	G57377	
816658	G57137		817059	G57142		818298	G57689		818693	G56933	
816679	G57099		817109	G57578		818305	G57120		818694	G56932	
816679	G57100		817110	G57577		818306	G57119		818695	G57565	
816681	G57206		817111	G57346		818307	G56951		818696	G57564	
816682	G57206		817112	G57345		818309	G57524		818885	G57098	
816705	G57149		817129	G57496		818310	G57523		818886	G57097	
816715	G57391		817130	G57495		818315	G57587		818891	G57561	
816716	G57390		817131	G57340		818316	G57586		818892	G57560	
816735	G57163		817132	G57339		818325	G56925		818899	G57812	
816736	G57164		817135	G57747		818326	G56924		818903	G57696	
816753	G57270		817136	G57746		818327	G57401		818904	G57695	
816769	G57733		817137	G57629		818328	G57400		818905	G57733	
816770	G57732		817137	G57705		818329	G57399		818906	G57732	
816773	G57427		817138	G57628		818330	G57398		818907	G57546	
816783	G57031		817138	G57704		818345	G57456		818908	G57545	
816784	G57030		817143	G57373		818345	G57595		818909	G57727	
816787	G57208		817144	G57372		818346	G57455		818910	G57726	
816788	G57207		817151	G57698		818346	G57594		818913	G57472	
816799	G57312		817152	G57697		818587	G57494		818914	G57471	
816799	G57323		817153	G57583		818588	G57493		818917	G57694	
816800	G57311		817157	G57496		818591	G57162		818918	G57693	
816800	G57322		817158	G57495		818592	G57161		818919	G57700	
816809	G57185		817163	G57418		818595	G57544		818920	G57699	
816810	G57184		817164	G57417		818596	G57543		818925	G57494	
816839	G57269		817177	G57378		818609	G57482		818926	G57493	
816840	G57268		817178	G57377		818610	G57481		818929	G57812	
816841	G57271		817487	G57378		818611	G57340		818931	G57083	
816937	G57419		817488	G57377		818612	G57339		818932	G57083	
816947	G57162		817895	G57518		818613	G57463		818933	G57690	
816947	G57368		817896	G57517		818614	G57464		818934	G57689	
816948	G57161		818050	G57746		818615	G57206		818941	G57206	
816948	G57367		818065	G57804		818616	G57206		818942	G57206	
816949	G57223		818066	G57803		818617	G57498		818945	G57083	
816950	G57222		818187	G57659		818618	G57497		818949	G57083	
816951	G57082		818188	G57658		818625	G57463		818961	G57518	
816952	G57081		818205	G57488		818626	G57464		818962	G57517	
816955	G57177		818206	G57487		818629	G57198		818983	G57206	
816956	G57176		818207	G57735		818630	G57197		818985	G57206	

Important Note: Competitive Interchanges are to be used for stocking purposes only. Where multiple crosses are identified, please reference the applications section of this catalog. / **Remarque importante:** Les interchanges concurrentiels ne s'utilisent qu'aux fins de stocks. Dans le cas de références multiples, consulter la section des applications du catalogue. / **Nota importante:** Dans le cas de références multiples, consulter la section des applications du catalogue. / **Nota importante:** Se pueden usar intercambios competitivos para propósitos de almacenamiento solamente. Cuando se identifican intercambios múltiples, consulte la sección de aplicaciones de este catálogo.

COMPETITIVE & O.E.M. INTERCHANGE LIST
Lista de Intercambios contra Competidores y Equipo Original.
Liste dinterchange de produits comptitifs & dquipement original (OEM)

PRT (ADD)... cont'd

Prt (add)	Gabriel	Upgrade	Prt (add)	Gabriel	Upgrade	Prt (add)	Gabriel	Upgrade	Prt (add)	Gabriel	Upgrade
818986	G57206		920102	G57764		920325	G57720		925040	83120	
818991	G57206		920103	G57765		920326	G57721		925041	83122	89406
818992	G57206		920104	G57764		920331	G57772		925041	89406	
819363	G57071		920118	G57421		920332	G57773		925042	83123	89405
819363	G57072		920131	G57576		920344	G57420		925042	89405	
819379	G57713		920132	G57703		920345	G57800		925043	83124	89407
819380	G57712		920134	G57156		920346	G57801		925043	89407	
819381	G57711		920135	G57156		920347	G57799		925044	83125	
819382	G57710		920136	G57156		920348	G57752		925045	83126	89430
819565	G57198		920159	G57764		920349	G57753		925045	89430	
819565	G57323		920161	G57734		920350	G57697		925046	83131	
819565	G57550		920162	G57735		920351	G57698		925047	83134	
819566	G57197		920165	G57803		920360	G57715		925048	83135	
819566	G57322		920166	G57804		920361	G57714		925049	83136	
819566	G57549		920169	G57784		920416	G57450		925050	83137	
819567	G57198		920170	G57785		920417	G57449		925051	83140	
819567	G57323		920181	G57772		920419	G57775		925052	83141	
819567	G57550		920182	G57773		920420	G57774		925053	83142	
819568	G57197		920200	G57716		920770	G57364		925054	83143	
819568	G57322		920201	G57717		920771	G57363		925055	83147	
819568	G57549		920213	G57754		925000	83002		925057	83154	
819569	G57198		920214	G57755		925001	83008		925059	83159	
819569	G57323		920215	G57780		925002	83011		925060	83160	
819570	G57197		920216	G57781		925003	83012		925061	83162	
819570	G57322		920229	G57337		925004	83016		925063	83166	
819573	G57031		920230	G57338		925005	83017		925064	83169	
819574	G57030		920239	G57359		925006	83021		925065	83175	
819575	G57140		920240	G57360		925007	83023		925066	G63622	
819576	G57139		920241	G57497		925008	83024		925067	G63623	
819579	G57330		920242	G57498		925009	83025		925068	83180	
819580	G57329		920243	G57764		925010	83027		925069	83207	89407
819581	G57330		920244	G57765		925011	83028		925069	89407	
819582	G57329		920245	G57724		925012	83029		925070	83209	89414
819583	G57350		920246	G57725		925013	83035		925070	89414	
819584	G57349		920249	G57444		925014	83038		925071	83215	
819585	G57510		920250	G57444		925015	83039		925072	83216	
819586	G57509		920273	G57222		925016	83040		925073	83219	
819587	G57463		920274	G57223		925017	83041		925074	83221	
819588	G57464		920279	G57161		925018	83042		925075	83225	
819789	G57498		920280	G57162		925019	83044		925076	83303	
819790	G57498		920281	G57076		925021	83047		925078	83308	
819931	G56974		920282	G57077		925022	83048		925079	83309	
819932	G56973		920283	G57720		925024	83050		925080	83312	89409
828189	G57609		920284	G57721		925025	83051		925080	89409	
828190	G57608		920285	G57689		925026	83053		925081	83314	
920009	G57635		920286	G57690		925027	83054		925082	83317	
920010	G57634		920295	G57772		925028	83056		925083	83364	
920020	G57635		920296	G57773		925029	83062		925084	83391	
920021	G57634		920297	G57716		925030	83065		925085	83395	
920041	G57518		920298	G57717		925033	83081		925086	83400	
920042	G57517		920303	G57754		925034	83101		925088	83518	
920059	G57748		920304	G57755		925035	83103		925089	83519	
920076	G57748		920305	G57780		925036	83107		925090	83613	
920081	G57690		920306	G57781		925037	83109		925091	83901	
920082	G57689		920319	G57220		925038	83112		925093	83906	
920101	G57765		920320	G57221		925039	83114		925094	85001	89410

Important Note: Competitive Interchanges are to be used for stocking purposes only. Where multiple crosses are identified, please reference the applications section of this catalog. / **Remarque importante:** Les interchanges concurrentiels ne s'utilisent qu'aux fins de stocks. Dans le cas de rfrences multiples, consulter la section des applications du catalogue. / **Nota importante:** En el caso de referencias multiples, consultar la seccion de aplicaciones del catalogo. / **Nota importante:** Se pueden usar intercambios competitivos para propósitos de almacenamiento solamente. Cuando se identifican intercambios múltiples, consulte la sección de aplicaciones de este catálogo.

COMPETITIVE & O.E.M. INTERCHANGE LIST
Lista de Intercambios contra Competidores y Equipo Original.
Liste dinterchange de produits comptitifs & dquipement original (OEM)

PRT (ADD)... cont'd

Prt (add)	Gabriel	Upgrade	Prt (add)	Gabriel	Upgrade	Prt (add)	Gabriel	Upgrade	Prt (add)	Gabriel	Upgrade
925094	89410		925132	85086		925183	85920	89503	925251	83128	89436
925095	85004		925133	85088		925183	89503		925251	89436	
925096	85005	89430	925134	85090		925184	85656		925252	83130	
925096	89430		925135	85061	89450	925185	85927		925254	83144	
925097	85006		925135	85061	89502	925186	85928		925255	83148	
925098	85007		925135	89502		925187	85932	89453	925256	83149	
925099	85009		925136	85102		925187	89453		925257	83150	
925100	85012	89413	925137	85106		925188	85956		925258	83158	
925100	89413		925138	85109		925189	85958		925259	83164	
925101	85013	89414	925139	85119		925190	85959		925260	83168	
925101	89414		925140	85122		925191	85965		925261	83203	89436
925102	85014		925142	85124		925192	85967		925261	89436	
925103	85023	89415	925143	85125		925193	85976		925262	83214	
925103	89415		925145	85180		925194	89402		925264	83301	
925104	85024		925146	85181		925199	G63306		925265	83318	
925105	85026		925148	85301		925208	G63610		925266	83363	
925106	85029		925149	85302	89420	925209	85736		925267	83389	89436
925107	85030	89440	925149	89420		925210	85902		925267	89436	
925107	89440		925150	85303	89422	925211	85921		925268	83401	
925108	85031		925150	89422		925212	85923	89458	925269	83456	89447
925109	85033	89427	925151	85304		925212	89458		925269	89447	
925109	89427		925152	85307		925213	85924	89457	925270	83635	
925110	85036	89405	925153	85308	89422	925213	89457		925271	85000	89436
925110	89405		925153	89422		925214	85931	89458	925271	89436	
925111	85043		925154	85310	89423	925214	89458		925272	85003	89411
925112	85046	89434	925154	89423		925215	85933	89454	925272	89411	
925112	89434		925155	85311	89424	925215	89454		925273	85010	
925113	85047	89435	925155	89424		925216	85936	89456	925274	85027	
925113	89435		925156	85314	89425	925216	89456		925275	85040	
925114	85054		925156	89425		925217	85937		925276	85045	
925115	85055	89439	925157	85315		925218	85954		925277	85051	
925115	89439		925158	85316	89426	925219	85957		925278	85052	
925116	85058	89431	925158	89426		925220	85963		925279	85053	89442
925116	89431		925159	85319	89428	925221	85964		925279	89442	
925118	85061	89450	925159	89428		925222	85972		925281	85064	
925118	85061	89502	925160	85320	89429	925224	85985		925282	85078	
925118	89502		925160	89429		925226	85988		925283	85079	
925119	85062	89408	925161	85329		925227	85989		925284	85087	
925119	89408		925162	85331		925228	85994		925286	85300	89419
925120	85063		925163	85335		925229	85995		925286	89419	
925121	85065		925165	85343		925231	83001		925287	85305	
925122	85066	89448	925166	85376		925232	83003		925288	85318	
925122	89448		925167	85637		925233	83004		925289	85321	
925123	85067	89451	925168	85639		925235	83006		925290	85322	
925123	89451		925169	85642		925236	83009		925291	85323	89436
925124	85069	89455	925173	85716		925238	83018		925291	89436	
925124	89455		925174	85722		925239	83019		925292	85332	
925125	85070	89459	925175	85724	89443	925241	83022		925293	85333	
925125	89459		925175	89443		925242	83031		925294	85334	
925126	85071		925178	85900		925243	83102		925295	85337	
925127	85072		925179	85906	89407	925244	83105		925296	85338	
925128	85080		925179	89407		925245	83110		925297	85339	
925129	85081		925180	85909		925246	83111		925298	85340	
925130	85082		925181	85918	89449	925247	83113		925299	85341	
925131	85084	89460	925181	89449		925249	83119		925301	85345	
925131	89460		925182	85919		925250	83127		925302	85351	

Important Note: Competitive Interchanges are to be used for stocking purposes only. Where multiple crosses are identified, please reference the applications section of this catalog. / **Remarque importante:** Les interchanges concurrentiels ne s'utilisent qu'aux fins de stocks. Dans le cas de références multiples, consulter la section des applications du catalogue. / **Nota importante:** Dans le cas de références multiples, consulter la section des applications du catalogue. / **Nota importante:** Se pueden usar intercambios competitivos para propósitos de almacenamiento solamente. Cuando se identifican intercambios múltiples, consulte la sección de aplicaciones de este catálogo.

COMPETITIVE & O.E.M. INTERCHANGE LIST
Lista de Intercambios contra Competidores y Equipo Original.
Liste d'interchange de produits compititifs & d'equipement original (OEM)

PRT (ADD)... cont'd

Prt (add)	Gabriel	Upgrade	Prt (add)	Gabriel	Upgrade	Prt (add)	Gabriel	Upgrade	Prt (add)	Gabriel	Upgrade
925303	85382		925337	85910		925371	83176		930202	G51934	
925304	85638		925338	85911		925372	83204		930228	G52172	
925306	85702		925339	85916	89430	925373	83242		930288	81676	
925307	85704		925339	89430		925377	85700		930293	G51921	
925308	85708		925340	85648		925378	85705	89447	930294	G51920	
925309	85709		925341	85929		925378	89447		930532	70040	
925310	85711		925342	85934		925379	85732		930665	G52295	
925311	85712		925343	85935		925380	89437		930754	G511037	
925314	85723		925344	85938		925397	81744		930792	70040	
925315	85727		925345	85939		925406	85979		930799	G51965	
925316	85728		925346	85955		925449	G63456		930848	14072	
925317	85729		925347	85961		925525	61682		932801	70096	
925318	85733		925348	85962		925531	61685		932803	61655	
925319	85734		925349	85970		925547	81318		932805	G51721	
925321	89432		925353	87015		925562	G63889		932806	G51901	
925330	85737		925355	87018		925563	G63889		932819	G52495	
925331	85738		925363	83015		925566	61711		932820	G52494	
925332	85739		925364	83026		925567	61713		932845	G511044	
925333	85740		925365	83030		925579	81920		932855	69952	
925334	85901		925367	83034		925607	83007		932874	85007	
925336	85908		925368	83059		930201	G51934		990002	49255	

Rancho

Rancho	Gabriel	Upgrade	Rancho	Gabriel	Upgrade	Rancho	Gabriel	Upgrade	Rancho	Gabriel	Upgrade
RS5006	G63689		RS5128	G63847		RS5215	G63708		RS5315	G63891	
RS5008	G63928		RS5129	G63425		RS5221	G64009		RS5319	G63889	
RS5029	G63905		RS5132	G63675		RS5222	G63421		RS5319	G64006	
RS5039	G63608		RS5136	G63386		RS5223	G63782		RS5324	G64038	
RS5039	G63614		RS5136	G63404		RS5229	G63678		RS5326	G64008	
RS5039	G63635		RS5145	G63479		RS5233	G63716		RS5367	G64044	
RS5040	G63815		RS5145	G63547		RS5234	G63715		RS5368	G64043	
RS5041	G63815		RS5147	G63403		RS5236	G63778		RS5384	G64079	
RS5042	G63886		RS5147	G63454		RS5240	G63722		RS5385	G63837	
RS5045	G63888		RS5150	G63609		RS5248	G63403		RS5386	G63842	
RS5111	G63183		RS5150	G63818		RS5259	G63683		RS5388	G64016	
RS5112	G63692		RS5151	G63347		RS5260	G63829		RS5389	G63892	
RS5112	G63775		RS5151	G63411		RS5262	G63662		RS5394	G63878	
RS5113	G63413		RS5158	G63432		RS5262	G63674		RS5395	G63883	
RS5113	G63490		RS5165	G63455		RS5262	G63866		RS5396	G63875	
RS5115	G63387		RS5166	G63489		RS5262	G64101		RS5397	G63885	
RS5116	G63353		RS5168	G63511		RS5263	G63803		RS5397	G64029	
RS5116	G63492		RS5180	G63494		RS5265	G63783		RS5397	G64030	
RS5117	G63350		RS5185	G63679		RS5267	G63809		RS5401	14074	
RS5117	G63461		RS5187	G63548		RS5269	G63961		RS5401	6801SE	
RS5118	G63349		RS5187	G63726		RS5269	G64000		RS5409	14071	
RS5118	G63409		RS5188	G63813		RS5274	G63962		RS5410	6854SE	
RS5118	G63419		RS5190	G63488		RS5281	G63958		RS5413	6856SE	
RS5118	G63510		RS5195	G63661		RS5282	G63848		RS55784	G51891	
RS5120	G63357		RS5197	G63673		RS5284	G63844		RS55803	G51865	
RS5123	G63423		RS5198	G63959		RS5285	G63870		RS55804	G51864	
RS5124	G63422		RS5199	G63359		RS5287	G63867		RS55830	G51949	
RS5124	G63638		RS5203	G63604		RS5295	G63817		RS5601	G63173	
RS5125	G63525		RS5208	G63616		RS5299	G63882		RS5602	G63950	
RS5125	G63773		RS5213	G63781		RS5300	G63884		RS5605	G63902	
RS5126	G63524		RS5214	G63495		RS5301	G63879		RS5605	G63909	
RS5128	G63424		RS5214	G63611		RS5308	G63965		RS5609	G63903	
RS5128	G63721		RS5214	G63707		RS5315	G63890		RS5609	G63915	

Important Note: Competitive Interchanges are to be used for stocking purposes only. Where multiple crosses are identified, please reference the applications section of this catalog. / **Remarque importante:** Les interchanges concurrentiels ne s'utilisent qu'aux fins de stocks. Dans le cas de rfrences multiples, consulter la section des applications du catalogue. / **Nota importante:** Dans le cas de rfrences multiples, consulter la section des applications du catalogue. / **Nota importante:** Se pueden usar intercambios competitivos para propósitos de almacenamiento solamente. Cuando se identifican intercambios múltiples, consulte la sección de aplicaciones de este catálogo.

COMPETITIVE & O.E.M. INTERCHANGE LIST
Lista de Intercambios contra Competidores y Equipo Original.
Liste dinterchange de produits comptitifs & dquipement original (OEM)

Rancho... cont'd

Rancho	Gabriel	Upgrade	Rancho	Gabriel	Upgrade	Rancho	Gabriel	Upgrade	Rancho	Gabriel	Upgrade
RS5609	G63937		RS5784	G51870		RS7118	77907		RS7328	77973	
RS5753	G51723		RS5808	G51856		RS7128	77847		RS7401	14040	
RS5753	G56838		RS5817	G51718		RS7128	77978		RS97488	6855SE	
RS5754	G56839		RS5821	G51722		RS7129	77425		RS999120	58357	
RS5757	G51815		RS5825	G51286		RS7150	77609		RS999901	G57125	
RS5758	G51855		RS5826	G56807		RS7190	77422		RS999904	G57019	
RS5762	G51077		RS5827	G51715		RS7190	77488		RS999909	G57021	
RS5763	G51077		RS7040	77815		RS7254	77952		RS999910	G57020	
RS5764	G51728		RS7042	77951		RS7267	77809		RS999924	G57095	
RS5767	G51704		RS7044	77674		RS7269	77950		RS999927	G57096	
RS5774	G51703		RS7044	77948		RS7272	77807		RS999929	G57053	
RS5775	G51854		RS7044	77980		RS7286	G64157		RS999939	G57095	
RS5776	G51853		RS7112	G63456		RS7295	77817		RS999942	G57096	
RS5777	G51739		RS7118	77717		RS7326	77981		RS999943	G57053	

Raybestos

Raybestos	Gabriel	Upgrade	Raybestos	Gabriel	Upgrade	Raybestos	Gabriel	Upgrade	Raybestos	Gabriel	Upgrade
502-1291	143191		520-1352	143209		520-1531	143390		717-1281	G56938	
515-1006	142091		520-1353	143204		520-1548	143462		717-1291L	G56996	
520-1010	142135		520-1380	143087		520-1549	143460		717-1291R	G56997	
520-1034	143281		520-1387	143241		520-1552	143342		717-1292	G56998	
520-1058	142247		520-1390	143073		520-1553	143191		717-1293	G57057	
520-1060	142245		520-1391	143074		520-1553	143365		717-1293	G57058	
520-1061	142250		520-1400	142937		520-1633	143495		717-1299	G56943	
520-1063	142249		520-1402	143202		520-1639	143341		717-1312	G57036	
520-1065	142244		520-1403	143244		520-1640	143363		717-1321	G57017	
520-1099	142317		520-1404	143244		520-1641	143461		717-1322	G57018	
520-1117	142329		520-1415	143404		520-1652	143531		717-1340L	G57032	
520-1121	143492		520-1434	143088		520-1665	143406		717-1340L	G57061	
520-1145	142439		520-1436	143194		520-1666	143343		717-1340R	G57033	
520-1147	142444		520-1441	143191		520-1667	143383		717-1340R	G57062	
520-1153	142403		520-1443	143354		520-1673	143345		717-1341	G57022	
520-1154	142404		520-1444	143355		520-1680	142653		717-1348L	G57027	
520-1163	142625		520-1451	143089		520-1683	143491		717-1348R	G57027	
520-1186	142840		520-1465	143418		520-1689	143366		717-1351L	G57065	
520-1216	142526		520-1467	143388		520-1692	143397		717-1351R	G57066	
520-1222	142530		520-1468	143387		520-1693	143477		717-1352L	G57010	
520-1230	143458		520-1471	143425		520-1695	143409		717-1352R	G57010	
520-1242	143465		520-1475	143385		520-1695	143410		717-1361	G57103	
520-1243	143466		520-1476	143364		520-1713	143305		717-1369	G57015	
520-1257	142643		520-1478	143323		556-1105	143058		717-1370	G57016	
520-1266	142651		520-1482	143419		556-1105	143059		717-1371L	G57133	
520-1272	142735		520-1487	143335		556-1108	143057		717-1371R	G57134	
520-1277	143459		520-1492	143398		556-1111	143061		717-1398	G57019	
520-1290	143367		520-1496	143369		556-1121	143057		717-1426	G57031	
520-1291	143191		520-1496	143468		713-9104	G57125		717-1427	G57030	
520-1294	143082		520-1497	143317		713-9105	G57000		717-1490	G57042	
520-1300	142828		520-1498	143316		717-1103	G57118		717-1491	G57041	
520-1301	142930		520-1501	143416		717-1111	G57053		717-1492	G57044	
520-1316	143197		520-1504	143455		717-1119L	G57123		717-1493	G57043	
520-1317	143325		520-1505	143344		717-1119R	G57124		717-1504	G57064	
520-1321	143259		520-1511	143319		717-1124	G57095		717-1505	G57063	
520-1322	143256		520-1512	143394		717-1125	G57096		717-1525	G57039	
520-1325	142932		520-1512	143422		717-1138	G57172		717-1572LX	G56956	
520-1332	142949		520-1517	143318		717-1139	G57173		717-1572RX	G56957	
520-1334	142938		520-1529	143564		717-1140	G57132		717-1577L	G57007	
520-1349	143315		520-1530	143391		717-1266	G56995		717-1577R	G57008	

Important Note: Competitive Interchanges are to be used for stocking purposes only. Where multiple crosses are identified, please reference the applications section of this catalog. / **Remarque importante:** Les interchanges concurrentiels ne s'utilisent qu'aux fins de stocks. Dans le cas de références multiples, consulter la section des applications du catalogue. / **Nota importante:** Dans le cas de références multiples, consulter la section des applications du catalogue. / **Nota importante:** Se pueden usar intercambios competitivos para propósitos de almacenamiento solamente. Cuando se identifican intercambios múltiples, consulte la sección de aplicaciones de este catálogo.

COMPETITIVE & O.E.M. INTERCHANGE LIST
Lista de Intercambios contra Competidores y Equipo Original.
Liste dinterchange de produits comptitifs & dquipement original (OEM)

Raybestos... cont'd

Raybestos	Gabriel	Upgrade	Raybestos	Gabriel	Upgrade	Raybestos	Gabriel	Upgrade	Raybestos	Gabriel	Upgrade
717-1592	G56965		717-1672	G56927		717-1954	G56949		717-2199	G57070	
717-1593	G57046		717-1685	G57051		717-1957	G56933		717-2199	G57122	
717-1594	G57045		717-1686	G56928		717-1958	G56932		717-2200	G57069	
717-1597	G57012		717-1691L	G56991		717-2105	G57035		717-2200	G57121	
717-1598	G57011		717-1691R	G56992		717-2106	G57034		717-2209	G57111	
717-1615	G56934		717-1920	G56935		717-2114	G57115		717-2210	G57110	
717-1615	G56937		717-1924	G57013		717-2115	G57114		717-2231	G57142	
717-1616	G56936		717-1925	G57014		717-2123L	G57054		717-2292	G57147	
717-1661	G57060		717-1933	G57006		717-2123R	G57055		727-1662L	G56924	
717-1665	G56929		717-1945	G56994		717-2179L	G57047		727-1662R	G56925	
717-1667	G56963		717-1946	G56993		717-2179R	G57048		727-1680	G56933	
717-1668	G56962		717-1952	G56948		717-2185	G57050		727-1681	G56932	
717-1669	G56964		717-1953	G56950		717-2186	G57049				

Ruville

Ruville	Gabriel	Upgrade	Ruville	Gabriel	Upgrade	Ruville	Gabriel	Upgrade	Ruville	Gabriel	Upgrade
G88024800	G63907										

Sachs

Sachs	Gabriel	Upgrade	Sachs	Gabriel	Upgrade	Sachs	Gabriel	Upgrade	Sachs	Gabriel	Upgrade
030 086	G51759		030 265	G63915		030 844	G63879		031 347	G51714	
030 094	G51888		030 266	G63950		030 848	G63773		031 350	G63815	
030 095	G51887		030 267	69625		030 854	69962		031 351	G63815	
030 098	G56655		030 281	G51871		030 872	69590		031 354	G52333	
030 100	G56817		030 282	G51904		030 875	G63958		031 355	G52334	
030 202	G63357		030 296	G51704		030 877	G63962		031 356	G56642	
030 204	G63375		030 297	G63867		030 878	G63810		031 357	G56643	
030 204	G63894		030 297	G64157		030 879	G63808		031 362	G64105	
030 205	G63386		030 298	G51703		030 881	G64087		031 363	G56636	
030 206	G63406		030 299	G63870		030 980	49228		031 364	G56635	
030 209	G63421		030 314	69574		030 980	49255		031 365	G52013	
030 210	G63422		030 315	69575		031 020	G44748		031 366	G52014	
030 211	G63423		030 320	G51722		031 084	G63494		031 367	G51736	
030 212	G63424		030 321	G51724		031 085	G63404		031 374	70001	
030 212	G63721		030 334	G56809		031 091	G63548		031 383	G52168	
030 214	G63454		030 335	G56809		031 095	G63616		031 384	G52169	
030 215	G63461		030 613	G55579		031 098	G63903		031 388	G51802	
030 218	G63607		030 645	G55697		031 103	G63782		031 392	70028	
030 219	G63608		030 660	G55772		031 105	G63707		031 393	G52098	
030 219	G63614		030 667	G51267		031 106	G63708		031 422	G51849	
030 221	G63609		030 669	G55820		031 110	G63726		033 011	G56927	
030 221	G63818		030 671	G55901		031 242	G51279		033 020	G56935	
030 222	G63907		030 676	G56701		031 257	G56565		033 023	G57064	
030 226	69600		030 699	G55896		031 267	G56571		033 024	G57063	
030 229	69675		030 729	69845		031 279	G56640		033 036	G56957	
030 230	69676		030 731	69898		031 280	G56641		033 037	G56956	
030 243	G63350		030 747	G51268		031 289	G63864		033 044	G56997	
030 244	G63353		030 748	G51254		031 292	G56784		033 045	G56996	
030 245	G63360		030 760	G63443		031 293	G56785		033 046	G56998	
030 247	G63377		030 767	G63671		031 295	G51716		033 054	G56948	
030 248	G63387		030 768	G63411		031 304	G51838		033 055	G56948	
030 252	G63409		030 777	G63623		031 306	G55991		033 056	G56949	
030 255	G63418		030 780	G63638		031 336	G56731		033 057	G56950	
030 256	G51713		030 780	G63896		031 337	G56730		033 088	G57178	
030 257	G63455		030 798	G63722		031 338	G56735		033 089	G57176	
030 261	G63490		030 814	69473		031 339	G56734		033 090	G57177	
030 262	G63492		030 817	G63837		031 343	G56677		033 103	G56991	
030 262	G63928		030 838	G63848		031 344	G56678		033 103	G56992	

Important Note: Competitive Interchanges are to be used for stocking purposes only. Where multiple crosses are identified, please reference the applications section of this catalog. / **Remarque importante:** Les interchanges concurrentiels ne s'utilisent qu'aux fins de stocks. Dans le cas de rfrences multiples, consulter la section des applications du catalogue. / **Nota importante:** Dans le cas de rfrences multiples, consulter la section des applications du catalogue. / **Nota importante:** Se pueden usar intercambios competitivos para propósitos de almacenamiento solamente. Cuando se identifican intercambios múltiples, consulte la sección de aplicaciones de este catálogo.

COMPETITIVE & O.E.M. INTERCHANGE LIST
Lista de Intercambios contra Competidores y Equipo Original.
Liste dinterchange de produits comptitifs & dquipement original (OEM)

Sachs... cont'd

Sachs	Gabriel	Upgrade	Sachs	Gabriel	Upgrade	Sachs	Gabriel	Upgrade	Sachs	Gabriel	Upgrade
033 105	G56943		230 303	G51841		310 227	G63679		311 313	G56728	
033 107	G57054		230 499	G56518		310 231	G63414		311 409	70045	
033 107	G57055		230 500	G56518		310 235	G63778		311 410	70045	
033 108	G57056		230 709	G56517		310 249	69606		311 538	G51773	
033 113	G57114		230 710	G56516		310 253	G63715		311 543	G52276	
033 114	G57115		280 325	G63781		310 261	G63525		311 750	70039	
033 317	G63878		280 355	69465		310 272	G63676		311 752	70040	
101 471	69787		280 523	69450		310 272	G63873		311 753	70040	
101 705	69996		280 757	G64028		310 273	G52314		311 801	69909	
101892	85708		280 867	G63832		310 274	G52314		311 820	69585	
101968	85708		280 869	G63828		310 277	G63776		311 821	G63717	
105 828	69901		280499	85300	89419	310 277	G63869		311 823	G63714	
106 798	69677		280499	89419		310 284	G63489		311 944	G56688	
106282	85722		290 005	G64027		310 287	G63488		311 945	G56687	
106884	85708		290 074	G55999		310 291	G55698		311 946	G56688	
106885	85722		290 075	G55999		310 312	G63783		311 947	G56687	
112885	85709		290 078	G55662		310 315	G63355		311229	85918	89449
115 906	G56778		290 079	G55661		310 315	G63366		311229	89449	
124 390	69952		290 082	G55591		310 317	G63349		311230	85956	
124693	85708		290 083	G55591		310 322	G52025		311631	85906	89407
14170000370	89450		290 236	G52165		310 325	G63662		311631	89407	
14170000373	85061	89450	290 237	G52164		310 325	G63675		311632	85909	
14170000373	85061	89502	290 238	G51881		310 325	G63959		311633	85900	
14170000373	89502		290 239	G52145		310 328	G63803		311634	85001	89410
14170000378	83160		290 240	G52144		310 328	G63893		311634	89410	
14170000380	85061	89450	290 379	G63918		310 343	G63813		311635	85030	89440
14170000380	85061	89502	290 561	G56591		310 350	G63299		311635	89440	
14170000380	89502		290 780	G55911		310 425	G51900		311793	85916	89430
14170000440	85066	89448	290 781	G55911		310 684	G56616		311793	89430	
14170000440	89448		290 949	G52237		310 685	G56615		312 130	G51718	
14170000443	85066	89448	290 950	G52238		310 688	G63845		312 131	G63842	
14170000443	89448		290146	85012	89413	310 706	69813		312 134	G51738	
141700002626	85061	89450	290146	89413		310 718	G52199		312 138	G56758	
141700002626	85061	89502	290460	85005	89430	310 719	G52200		312 139	G56759	
141700002626	89502		290460	89430		310 720	70034		312 154	70000	
141700002630	89450		290465	83125		310 838	G52275		312 170	G51883	
141700005838	85061	89450	290488	85040		310 839	G52274		312 170	G51969	
141700005838	85061	89502	300 138	G56791		310 842	G51841		312 178	G56672	
141700005838	89502		303 903	70041		310 886	G51772		312 179	G56671	
141700005839	85061	89450	310 027	69946		310 897	G63712		312 180	G56684	
141700005839	85061	89502	310 032	G51087		310 950	G51799		312 181	G56683	
141700005839	89502		310 173	G63413		310 985	G52142		312 182	G56686	
141700005840	89502		310 175	G63905		310 986	G52143		312 183	G56685	
141700131809	85029		310 178	G63661		311 013	G56899		312 184	G51727	
141700131810	83160		310 183	G63359		311 041	69604		312 186	G52009	
141700131975	83160		310 190	G63683		311 041	69724		312 187	G52008	
141700131980	83160		310 191	G63425		311 120	G63958		312 188	G51798	
152C030010	83317		310 202	G56620		311 120	G64043		312 209	G51767	
152E030030	85014		310 203	G63426		311 121	G63961		312 211	G52019	
170 160	G44986		310 203	G63690		311 121	G64044		312 214	G51739	
170 811	G51097		310 218	G63622		311 122	G51728		312 215	G63885	
170 819	G51742		310 218	G63929		311 123	G63844		312 215	G64029	
170 823	69903		310 219	G63624		311 212	G63817		312 215	G64030	
170 828	69903		310 224	G63716		311 233	G64046		312 218	G51804	
230 003	G51063		310 225	G63678		311 237	G63720		312 222	G52108	
230 048	G63799		310 225	G63775		311 312	G56729		312 222	G56798	

Important Note: Competitive Interchanges are to be used for stocking purposes only. Where multiple crosses are identified, please reference the applications section of this catalog. / **Remarque importante:** Les interchanges concurrentiels ne s'utilisent qu'aux fins de stocks. Dans le cas de références multiples, consulter la section des applications du catalogue. / **Nota importante:** Dans le cas de referencias multiples, consultar la sección de aplicaciones del catálogo. / **Nota importante:** Se pueden usar intercambios competitivos para propósitos de almacenamiento solamente. Cuando se identifican intercambios múltiples, consulte la sección de aplicaciones de este catálogo.

COMPETITIVE & O.E.M. INTERCHANGE LIST
Lista de Intercambios contra Competidores y Equipo Original.
Liste dinterchange de produits comptitifs & dquipement original (OEM)

Sachs... cont'd

Sachs	Gabriel	Upgrade	Sachs	Gabriel	Upgrade	Sachs	Gabriel	Upgrade	Sachs	Gabriel	Upgrade
312 223	G52107		313 263	G56807		313 839	G55870		314 846	G52004	
312 223	G56797		313 264	G64012		313 849	G56894		314 863	G64026	
312 278	G44461		313 265	G51715		313 854	G51811		314 894	G52439	
312 280	G44461		313 277	G56514		313 854	G51859		314 895	G52440	
312 326	G56539		313 278	G56506		313 854	G51897		314 994	G56819	
312 327	G56540		313 279	G55676		313 855	G51810		314 995	G56820	
312 433	G51252		313 280	G55675		313 855	G51859		314 996	G56822	
312 473	G64016		313 281	G51256		313 855	G51896		314 997	G56821	
312 475	G63892		313 411	G52005		313 856	69591		315 087	G56606	
312 485	G52110		313 415	G52006		313 861	G51794		315 127	G56810	
312 486	G52111		313 419	70003		313 866	G51737		315 128	G56810	
312 587	G56568		313 450	G56889		313 866	G51737		315 128	G56810	
312 588	G56601		313 451	G56888		313 880	G511004		315 129	G63872	
312 589	69900		313 451	G56888		313 881	G52300		315 129	G64015	
312 702	G63847		313 455	G52184		313 882	G52299		315 129	G64140	
312 703	G63829		313 456	G52185		313 882	G52299		315 129	G64140	
312 739	G52018		313 474	G63884		313 977	G51841		315 148	G51850	
312 740	G52017		313 474	G63884		313 983	G63883		315 150	70052	
312 743	G56893		313 475	G63882		314 007	70098		315 171	G52162	
312 744	G56892		313 477	G63875		314 037	G52174		315 172	G52163	
312 782	70024		313 517	G52154		314 038	G52173		315 197	G51908	
312 784	69586		313 518	G52155		314 044	G64050		315 227	G51807	
312 880	G56680		313 520	G52257		314 125	G52295		315 251	G52383	
312 881	G56679		313 521	G52258		314 166	69714		315 252	G52382	
312 901	G56733		313 522	G64071		314 167	69795		315 278	G56773	
312 902	G56732		313 522	G64071		314 168	69811		315 279	G56774	
312 929	G51795		313 523	G511054		314 220	69622		315 280	G51870	
312 932	G51814		313 524	G511055		314 225	69755		315 280	G51870	
312 933	G51813		313 526	70078		314 225	69755		315 306	G56562	
312 963	G51812		313 527	G52160		314 226	G55856		315 307	G56561	
312 984	G52082		313 528	G52161		314 243	G63673		315 308	69907	
312 985	G52081		313 588	G56633		314 258	G63710		315 641	G52148	
312 986	G51842		313 589	G56634		314 259	G55994		315 642	G52149	
312724	85311	89424	313 620	G56841		314 260	G63937		315 644	G52117	
312724	89424		313 621	G56840		314 261	G63620		315 645	G52118	
313 093	G56660		313 622	G64037		314 270	G55993		315 646	G51863	
313 094	G56661		313 624	G63889		314 288	G63904		315 785	G51815	
313 096	G55774		313 624	G64006		314 288	G63909		315 786	G51855	
313 097	G55774		313 625	G64009		314 299	G63495		315 787	G64038	
313 123	G63610		313 625	G64011		314 299	G63611		315 789	G52273	
313 125	G63173		313 626	G56537		314 300	69715		315 790	G51910	
313 186	G51255		313 627	G56538		314 355	69587		315 791	G52272	
313 202	G52175		313 660	G52282		314 356	69589		315 792	G51858	
313 203	G52176		313 661	G52283		314 423	G63890		315 793	70010	
313 237	G52095		313 663	G51833		314 423	G63891		315 796	G52253	
313 238	G52094		313 665	G52275		314 461	G52348		315 797	G52254	
313 239	70027		313 667	G52274		314 462	G52349		315 801	G51919	
313 243	G52122		313 669	70056		314 463	G51928		315 804	G51860	
313 244	G52121		313 671	69595		314 469	G64032		315 805	G51861	
313 245	70089		313 672	69594		314 621	69464		315 809	G52182	
313 252	G51993		313 738	G52297		314 660	G52335		315 810	G52183	
313 254	G52142		313 739	G52298		314 661	G52336		315 826	G51911	
313 255	G52143		313 741	G51934		314 752	G51783		315 854	70040	
313 258	G51723		313 747	G56799		314 754	70036		315 897	G51983	
313 262	69592		313 767	G56800		314 757	G56842		315 898	G51983	
313 262	69593		313 768	G56800		314 758	G56843		315 918	G52129	
			313 769	G51286		314 766	G56886		315 919	G52130	
			313 785	G64033		314 767	G56887		315 924	G52131	
			313 808	G56581		314 845	G52007		315 925	G64042	
			313 809	G56582							

Important Note: Competitive Interchanges are to be used for stocking purposes only. Where multiple crosses are identified, please reference the applications section of this catalog./ **Remarque importante:** Les interchanges concurrentiels ne s'utilisent qu'aux fins de stocks. Dans le cas de rfrences multiples, consulter la section des applications du catalogue./ **Nota importante:** En el caso de referencias multiples, consultar la seccion de aplicaciones del catalogo./ **Nota importante:** Se pueden usar intercambios competitivos para propósitos de almacenamiento solamente. Cuando se identifican intercambios múltiples, consulte la sección de aplicaciones de este catálogo.

COMPETITIVE & O.E.M. INTERCHANGE LIST
Lista de Intercambios contra Competidores y Equipo Original.
Liste d'interchange de produits comptitifs & d'equipement original (OEM)

Sachs... cont'd

Sachs	Gabriel	Upgrade	Sachs	Gabriel	Upgrade	Sachs	Gabriel	Upgrade	Sachs	Gabriel	Upgrade
315389	85090		315542	85005	89430	315610	83026		316 424	G52250	
315390	85918	89449	315542	89406		315611	85006		316 425	G52249	
315390	89449		315542	89430		315612	85006		316 426	G64003	
315391	85956		315543	85734		315613	85030	89440	316 426	G64080	
315392	85007		315544	83124	89407	315613	85909		316 427	G52141	
315392	85329		315544	85014		315613	89440		316 428	G52140	
315393	85331		315544	89407		315614	83125		316 434	G51884	
315394	85921		315545	85316	89426	315615	83027		316 438	70053	
315395	85724	89443	315545	85333		315616	83038		316 439	G52331	
315395	89443		315545	89426		315617	85918	89449	316 440	G52332	
315396	85335		315546	85005	89430	315617	89449		316 441	G64048	
315397	83120		315546	89430		315618	83160		316 442	G51852	
315398	85058	89431	315547	85924	89457	315619	83160		316 443	G52096	
315398	89431		315547	89457		315620	85080		316 444	G52097	
315399	85005	89430	315548	85070	89459	315621	85080		316 445	G52158	
315399	89430		315548	89459		315622	85081		316 446	G52159	
315400	85006		315549	85033	89427	315623	85918	89449	316 447	G52264	
315401	85331		315549	89427		315623	89449		316 448	G52265	
315402	85900		315550	85311	89424	315624	85959		316 457	G511020	
315403	85919		315550	89424		315626	85933	89454	316 458	G511019	
315404	85900		315551	85310	89423	315626	89454		316 462	G63888	
315406	85918	89449	315551	89423		315654	85070	89459	316 463	G64111	
315406	89449		315552	83389	89436	315654	89459		316 467	G52375	
315411	83128	89436	315552	85000	89436	315655	85937		316 468	G51961	
315411	89436		315552	89436		315656	83040		316 469	G52374	
315412	85106		315553	85900		315657	83039		316 496	G56509	
315413	85932	89453	315554	83125		315659	83047		316 497	G51832	
315413	89453		315555	83001		315660	83009		316 498	G51880	
315414	85959		315556	83215		315661	85932	89453	316 561	G52245	
315415	85933	89454	315558	85062	89408	315661	89453		316 562	G52246	
315415	89454		315558	89408		315840	83126	89430	316 563	G51898	
315416	85003	89411	315593	85029		315840	89430		316 578	G51864	
315416	89411		315594	85029		316 39	83215		316 579	G51865	
315417	85923	89458	315597	85959		316 396	G52127		316 580	G64079	
315417	85931	89458	315598	85933	89454	316 397	G52128		316 589	70068	
315417	89458		315598	89454		316 398	G56837		316 595	G51806	
315418	83456	89447	315599	85109		316 399	G56836		316 596	G51806	
315418	89447		315600	85918	89449	316 402	G52204		316 597	G52439	
315420	85014		315600	89449		316 403	G52203		316 598	G52440	
315421	85088		315601	85959		316 404	G52202		316 624	G51805	
315422	85708		315603	83134		316 405	G52201		316 625	G52106	
315423	83127		315604	85053	89442	316 408	G52188		316 626	G52105	
315424	85067	89451	315604	89442		316 409	G52187		316 629	G56679	
315424	89451		315606	85061	89450	316 410	G51878		316 630	G56680	
315426	85007		315606	85061	89502	316 411	G51877		316 633	G51765	
315427	85713		315606	89502		316 412	G51892		316 638	G63886	
315431	85014		315607	85061	89450	316 413	G64008		316 638	G63969	
315432	83209	89414	315607	85061	89502	316 414	G64040		316 639	G52152	
315432	85013	89414	315607	89502		316 415	G52125		316 641	G51905	
315432	89414		315608	85061	89450	316 416	G52248		316 645	G52033	
315434	85065		315608	85061	89502	316 417	G52247		316 646	G52032	
315435	85088		315608	85066	89448	316 419	G52104		316 647	G51803	
315536	85086		315608	89448		316 420	G52103		316 651	G52209	
315540	83613		315608	89502		316 421	G52116		316 652	G52210	
315541	85052		315609	85066	89448	316 422	G52157		316 653	G64056	
315542	83122	89406	315609	89448		316 423	G52156		316 654	G52260	

Important Note: Competitive Interchanges are to be used for stocking purposes only. Where multiple crosses are identified, please reference the applications section of this catalog. / **Remarque importante:** Les interchanges concurrentiels ne s'utilisent qu'aux fins de stocks. Dans le cas de références multiples, consulter la section des applications du catalogue. / **Nota importante:** Dans le cas de références multiples, consulter la section des applications du catalogue. / **Nota importante:** Se pueden usar intercambios competitivos para propósitos de almacenamiento solamente. Cuando se identifican intercambios múltiples, consulte la sección de aplicaciones de este catálogo.

COMPETITIVE & O.E.M. INTERCHANGE LIST
Lista de Intercambios contra Competidores y Equipo Original.
Liste dinterchange de produits comptitifs & dquipement original (OEM)

Sachs... cont'd

Sachs	Gabriel	Upgrade	Sachs	Gabriel	Upgrade	Sachs	Gabriel	Upgrade	Sachs	Gabriel	Upgrade
316 655	G52261		316322	85300	89419	317534	85084	89460	317965	83163	
316 662	70060		316322	89419		317534	85989		317966	G63183	
316 664	G52293		316478	85331		317534	89460		40A850	85708	
316 665	G52294		316485	85959		317535	83008		410009	83102	
316 666	G51933		316488	85919		317536	85738		410010	83317	
316 667	70096		316490	85010		317772	83029		410021	83125	
316 668	G51926		316491	85013	89414	317773	85656		410022	85006	
316 669	G51925		316491	89414		317774	83122	89406	410024	85302	89420
316 674	G52150		316493	85010		317774	89406		410024	89420	
316 675	G52151		316814	85026		317776	83209	89414	410025	83215	
316 679	G52026		316815	85030	89440	317776	89414		410026	85918	89449
316 680	G52027		316815	89440		317777	85648		410026	89449	
316 686	G52112		316816	85012	89413	317778	83045		410032	85001	89410
316 687	G52113		316816	89413		317779	85045		410032	89410	
316 707	G51990		316817	85954		317779	85939		410035	85001	89410
316 747	70013		316818	85046	89434	317780	83030		410035	85337	
316 749	G51853		316818	89434		317781	83035		410035	89410	
316 750	G51854		316819	85055	89439	317782	83207	89407	410036	85061	89450
316 772	G51891		316819	89439		317782	89407		410036	85061	89502
316 774	G51891		316820	85012	89413	317783	85024		410036	89502	
316 775	G63866		316820	89413		317928	646177		410037	85081	
316 777	G63866		316821	83111		317929	83019		410040	85909	
316 842	G56721		316822	85978		317930	83025		410042	85310	89423
316 843	G56722		316823	85072		317931	83049		410042	89423	
316 881	G51972		316824	85069	89455	317932	83101		410043	85957	
316 923	G51766		316824	89455		317933	83103		410044	85031	
316 924	G64031		316825	83021		317934	83123	89405	410046	83136	
316302	83163		316826	83031		317934	89405		410047	85071	
316303	83136		316827	83002		317935	83142		410048	85014	
316305	83219		316828	83041		317936	83144		410056	83389	89436
316305	85023	89415	316829	83041		317936	85030	89440	410056	85000	89436
316305	89415		316830	85051		317936	89440		410056	89436	
316306	85319	89428	316831	85043		317937	83148		410057	83137	
316306	89428		316832	83120		317938	85012	89413	410057	85013	89414
316307	85036	89405	316833	83112		317938	89413		410057	89414	
316307	89405		316834	85058	89431	317939	83314		410058	83122	89406
316308	85321		316834	89431		317940	85053	89442	410058	89406	
316309	85901		316835	83110		317940	89442		410068	85030	89440
316310	85311	89424	316836	85055	89439	317941	85302	89420	410068	85054	
316310	89424		316836	89439		317941	89420		410068	89440	
316311	85047	89435	316837	83312	89409	317943	85979		471700000426	85014	
316311	89435		316837	89409		317944	87015		471700000428	85006	
316312	83136		316838	83309		317945	83515		471700000430	85066	89448
316313	85061	89450	316839	83215		317953	85301		471700000430	89448	
316313	85061	89502	316840	83126	89430	317955	632147		471700000431	85066	89448
316313	89502		316840	85030	89440	317956	83025		471700000431	89448	
316314	85064		316840	89430		317957	83225		471700000436	85030	89440
316314	85938		316840	89440		317957	85007		471700000436	89440	
316316	85936	89456	316841	85303	89422	317958	83308		471700000440	85959	
316316	89456		316841	89422		317959	83400		471700000443	85066	89448
316318	85045		317 966	G63183		317960	85054		471700000443	89448	
316318	85052		317529	83154		317961	85338		471700000445	85080	
316319	83130		317530	646155		317962	85311	89424	471700000447	85919	
316320	85030	89440	317531	83048		317962	89424		471700000449	85918	89449
316320	89440		317532	83051		317963	85740		471700000449	89449	
316321	83317		317533	85052		317964	85029		471700000450	85080	

Important Note: Competitive Interchanges are to be used for stocking purposes only. Where multiple crosses are identified, please reference the applications section of this catalog. / **Remarque importante:** Les interchanges concurrentiels ne s'utilisent qu'aux fins de stocks. Dans le cas de rfrences multiples, consulter la section des applications du catalogue. / **Nota importante:** Dans le cas de rfrences multiples, consulte la section des aplicaciones du catalogue. / **Nota importante:** Se pueden usar intercambios competitivos para propósitos de almacenamiento solamente. Cuando se identifican intercambios múltiples, consulte la sección de aplicaciones de este catálogo.

COMPETITIVE & O.E.M. INTERCHANGE LIST
Lista de Intercambios contra Competidores y Equipo Original.
Liste dinterchange de produits comptitifs & dquipement original (OEM)

Sachs... cont'd

Sachs	Gabriel	Upgrade	Sachs	Gabriel	Upgrade	Sachs	Gabriel	Upgrade	Sachs	Gabriel	Upgrade
47170000450	85918	89449	471700006269	85932	89453	481700999386	85736		802 186		143082
47170000450	85919		471700006269	89453		481700999390	85376		802 196		142653
47170000450	89449		471700006270	85932	89453	510 007	85705	89447	802 250		143404
47170000451	85080		471700006270	89453		510 009	85711		802 289		142930
47170000458	85014		471700009646	85088		510001	85303	89422	802 291		142625
47170000459	85030	89440	471700009647	85088		510001	89422		802 292		143204
47170000459	89440		471700009650	85088		510002	85302	89420	802 297		142419
47170000460	85090		471700011530	85181		510002	89420		802 298		143367
47170000460	89414		471700011531	85180		510003	85004		802 299		142649
47170000460	89440		471700013186	85109		510004	85307		802 300		142650
47170000461	89414		471700014316	85061	89450	510005	85303	89422	802 304		143492
47170000464	85090		471700014316	85061	89502	510005	89422		802 306		143201
47170000466	85959		471700014316	89502		510006	85705	89447	802 346		143465
47170000470	85918	89449	471700014318	85188		510006	89447		802 347		143466
47170000470	89449		471700131155	85918	89449	510017	85323	89436	802 349		143087
471700002627	85066	89448	471700131155	89449		510017	85738		802 358		142937
471700002627	89448		471700131160	85918	89449	510017	89436		802 360		143202
471700002630	85066	89448	471700131160	89449		510018	85724	89443	802 377		142252
471700002630	89448		471700131256	85065		510018	89443		802 379		143191
471700002726	85918	89449	471700131258	85081		510019	85916	89430	802 381		142735
471700002726	89449		471700131260	85081		510019	89430		802 399		143239
471700002727	85959		471700131330	85932	89453	510023	85316	89426	802 432		143218
471700002730	85918	89449	471700131330	89453		510023	89426		802 435		143418
471700002730	85959		471700131331	85932	89453	553 870	70033		802 437		143388
471700002730	89449		471700131331	89453		553 871	G56792		802 438		143387
471700002809	85724	89443	471700131545	85006		554 041	G56802		802 444		143491
471700002809	89443		471700131646	85918	89449	554 046	G56802		802 453		142195
471700002810	85724	89443	471700131646	89449		556 271	69420		802 458		143191
471700002810	89443		471700131650	85918	89449	556 271	69945		802 458		143365
471700002861	85014		471700131650	89449		556 277	69946		802 476		143317
471700002919	85106		471700131775	85006		556 873	G56750		802 477		143354
471700002920	85106		471700131778	85331		556 874	G56751		802 478		143355
471700002990	85007		471700131780	85331		556 882	69863		802 479		143323
471700002991	85959		471700131920	85933	89454	557 833	G51097		802 486		143416
471700002992	85331		471700131920	89454		558 301	G51740		802 487		143419
471700002993	85921		471700131921	85933	89454	566 281	G51799		802 490		143398
471700002994	83134		471700131921	89454		610 018	G63479		802 492		143455
471700002995	83134		471700131970	85029		610 018	G63547		802 497		143089
471700002996	85335		471700131974	85029		610 023	G63405		802 501		143385
471700003000	85335		481700000207	85329		610 078	G63403		802 502		143324
471700003009	85006		481700000209	85713		610 092	G63772		802 503		143364
471700003010	89431		481700000210	85329		613 640	G52153		802 504		143369
471700003011	85058	89431	481700000210	85713		802 003	142135		802 504		143468
471700003011	89431		481700000477	85900		802 045	142091		802 513		143408
471700003830	85933	89454	481700000480	85900		802 061	142444		802 536		143473
471700003830	89454		481700000490	85900		802 070	142651		802 540		143422
471700003832	85933	89454	481700000493	85900		802 094	142230		802 582		143495
471700003832	89454		481700125969	85956		802 107	143191		802 583		143318
471700003920	85958		481700125970	85956		802 113	142403		802 585		143391
471700004420	85109		481700131438	85919		802 114	142404		802 586		143390
471700004423	85109		481700131440	85919		802 139	142247		802 590		143415
471700005079	85005	89430	481700131919	85900		802 141	142250		802 594		143363
471700005079	89430		481700131920	85900		802 142	142439		802 595		143462
471700005080	89430		481700999376	85329		802 143	142249		802 596		143461
471700006039	85088		481700999380	85329		802 145	143281		802 598		143460
471700006040	85088		481700999386	85376		802 178	143259		802 609		143342

Important Note: Competitive Interchanges are to be used for stocking purposes only. Where multiple crosses are identified, please reference the applications section of this catalog. / **Remarque importante:** Les interchanges concurrentiels ne s'utilisent qu'aux fins de stocks. Dans le cas de références multiples, consulter la section des applications du catalogue. / **Nota importante:** Dans le cas de referencias multiples, consultar la sección de aplicaciones del catálogo. / **Nota importante:** Se pueden usar intercambios competitivos para propósitos de almacenamiento solamente. Cuando se identifican intercambios múltiples, consulte la sección de aplicaciones de este catálogo.

COMPETITIVE & O.E.M. INTERCHANGE LIST
Lista de Intercambios contra Competidores y Equipo Original.
Liste dinterchange de produits comptitifs & dquipement original (OEM)

Sachs... cont'd

Sachs	Gabriel	Upgrade	Sachs	Gabriel	Upgrade	Sachs	Gabriel	Upgrade	Sachs	Gabriel	Upgrade
802 615	143406		802 767	142329		802 895	143256		814903003483	83039	
802 616	143343		802 780	143209		802 896	143315		814903003486	83047	
802 617	143383		802 782	142843		802 906	143464		814903003496	83009	
802 657	143366		802 786	142949		802 909	143423		814903003500	83026	
802 657	143486		802 791	143458		802 929	143244		814903003501	83027	
802 680	143409		802 844	142828		802 938	143241		814903003528	83038	
802 680	143410		802 849	143197		802 942	142643		814903003530	83038	
802 689	143397		802 850	143325		803 020	143349		820 690	143477	
802 722	142852		802 853	142561		803 022	143305		900 002	143057	
802 730	142842		802 854	142836		803 077	143393		900 003	143058	
802 739	142546		802 861	142530		803 085	143088		900 097	143059	
802 746	142244		802 863	143459		803 097	143339		900 099	143061	
802 747	142245		802 885	142938		814903003480	83039		900 101	143063	
802 762	142840		802 887	143244		814903003480	83040		900 301	143064	
802 764	142317		802 893	142932		814903003482	83040				

SenSen

Sensen	Gabriel	Upgrade	Sensen	Gabriel	Upgrade	Sensen	Gabriel	Upgrade	Sensen	Gabriel	Upgrade
1212-0022	61651		1213-0156	69909		1213-0311	69676		1213-0574	69962	
1212-0022	69813		1213-0157	61609		1213-0311	81481		1213-0574	81927	
1212-0057	81416		1213-0157	81910		1213-0312	69675		1213-0575	G64111	
1212-0066	69585		1213-0158	G64087		1213-0313	69898		1213-0576	G63411	
1212-0066	70001		1213-0159	81872		1213-0313	81794		1213-0587	G64146	
1212-0083	69677		1213-0160	61508		1213-0314	69574		1214-0009	G63828	
1212-0086	69996		1213-0160	61662		1213-0314	69575		1214-0010	G63832	
1212-0088	69715		1213-0160	81507		1213-0315	61615		1214-0106	G63885	
1212-0088	69725		1213-0188	61516		1213-0315	81548		1214-0106	G64029	
1212-0088	69863		1213-0188	61525		1213-0315	81936		1214-0106	G64030	
1212-0090	61560		1213-0188	81039		1213-0317	81559		1214-0125	61710	
1212-0090	81904		1213-0188	81113		1213-0318	G64037		1214-0125	61716	
1212-0091	69787		1213-0189	61524		1213-0331	61679		1214-0126	G63809	
1212-0092	70020		1213-0189	81164		1213-0332	81744		1214-0127	81930	
1212-0093	G63845		1213-0190	G63815		1213-0346	G63782		1214-0128	G63455	
1212-0094	81478		1213-0191	G63432		1213-0347	G63781		1214-0129	81726	
1212-0096	69952		1213-0191	G63548		1213-0351	G64027		1214-0130	61547	
1212-0097	82001		1213-0193	81924		1213-0352	G64028		1214-0130	81082	
1212-0098	61592		1213-0246	G64026		1213-0353	G64048		1214-0131	G63456	
1212-0098	81937		1213-0247	G64032		1213-0353	G64143		1214-0132	81667	
1212-0100	61509		1213-0250	70078		1213-0365	81318		1214-0133	61533	
1212-0100	61606		1213-0271	G64003		1213-0367	G63889		1214-0133	61627	
1212-0100	81541		1213-0272	G64046		1213-0368	G63909		1214-0133	81730	
1212-0134	69465		1213-0273	81147		1213-0369	G64006		1214-0133	81917	
1212-0136	G64052		1213-0276	G63815		1213-0404	70098		1214-0134	61629	
1212-0172	70040		1213-0285	G64050		1213-0470	61777		1214-0134	81540	
1212-0187	70027		1213-0293	81495		1213-0516	G63918		1214-0134	81905	
1213-0030	69591		1213-0299	69587		1213-0547	81675		1214-0134	81918	
1213-0101	70000		1213-0300	69589		1213-0548	G63620		1214-0135	61528	
1213-0144	61552		1213-0302	69473		1213-0549	69600		1214-0135	81482	
1213-0144	81870		1213-0304	61616		1213-0549	81582		1214-0136	61624	
1213-0145	61510		1213-0304	81929		1213-0552	69604		1214-0136	81823	
1213-0145	61699		1213-0305	81516		1213-0552	69724		1214-0136	81890	
1213-0145	61700		1213-0306	69590		1213-0552	81514		1214-0137	81821	
1213-0145	81871		1213-0307	69592		1213-0555	69845		1214-0138	61543	
1213-0146	G63726		1213-0307	69593		1213-0564	69755		1214-0138	81667	
1213-0147	69901		1213-0308	70031		1213-0566	81553				
1213-0153	81911		1213-0309	69464		1213-0569	G63426				
1213-0155	G63299		1213-0309	81935		1213-0571	G63818				
1213-0156	61704		1213-0310	70086		1213-0572	G63707				

Important Note: Competitive Interchanges are to be used for stocking purposes only. Where multiple crosses are identified, please reference the applications section of this catalog. / **Remarque importante:** Les interchanges concurrentiels ne s'utilisent qu'aux fins de stocks. Dans le cas de rfrences multiples, consulter la section des applications du catalogue. / **Nota importante:** En el caso de referencias multiples, consultar la seccion de aplicaciones del catalogo. / **Nota importante:** Se pueden usar intercambios competitivos para propósitos de almacenamiento solamente. Cuando se identifican intercambios múltiples, consulte la sección de aplicaciones de este catálogo.

COMPETITIVE & O.E.M. INTERCHANGE LIST
Lista de Intercambios contra Competidores y Equipo Original.
Liste d'interchange de produits complitifs & d'equipement original (OEM)

SenSen... cont'd

Sensen	Gabriel	Upgrade	Sensen	Gabriel	Upgrade	Sensen	Gabriel	Upgrade	Sensen	Gabriel	Upgrade
1214-0140	61575		1214-0178	81828		1214-0217	81548		3212-0175	70033	
1214-0140	81891		1214-0179	61544		1214-0218	61535		3212-0177	G51254	
1214-0141	61600		1214-0179	61555		1214-0218	81548		3212-0178	G51727	
1214-0141	61642		1214-0179	81668		1214-0219	81691		3212-0181	69946	
1214-0141	81873		1214-0180	G63414		1214-0220	61541		3212-0182	69863	
1214-0142	81873		1214-0182	81446		1214-0220	81583		3212-0182	69903	
1214-0143	61625		1214-0182	81713		1214-0221	61512		3212-0183	70003	
1214-0144	61605		1214-0183	81833		1214-0221	81559		3212-0184	70065	
1214-0144	81878		1214-0184	61546		1214-0222	G64047		3212-0226	G51807	
1214-0145	61542		1214-0184	81490		1214-0223	G63678		3212-0242	G51795	
1214-0145	81726		1214-0185	61599		1214-0235	G63875		3212-0243	G51794	
1214-0146	81923		1214-0185	81928		1214-0235	G64033		3212-0244	69586	
1214-0147	61658		1214-0186	61634		1214-0236	G64031		3212-0246	70028	
1214-0147	81923		1214-0186	61635		1214-0237	G63878		3212-0266	G51990	
1214-0148	G63717		1214-0186	81919		1214-0240	81510		3212-0273	G51863	
1214-0149	G63717		1214-0187	61623		1214-0240	81710		3212-0275	G51252	
1214-0150	81873		1214-0187	61626		1214-0241	G64040		3212-0276	70055	
1214-0151	81921		1214-0187	81893		1214-0242	69594		3212-0277	70041	
1214-0152	61659		1214-0187	81916		1214-0242	69595		3212-0278	G51863	
1214-0153	61676		1214-0188	61504		1214-0243	70010		3212-0353	G51848	
1214-0153	81926		1214-0188	81750		1214-0244	G63864		3212-0366	70052	
1214-0154	G63675		1214-0189	61611		1214-0252	61680		3212-0367	70036	
1214-0155	G63844		1214-0189	81912		1214-0253	61682		3212-0387	G51252	
1214-0156	61691		1214-0190	61638		1214-0253	61713		3212-0429	G51983	
1214-0156	61692		1214-0190	81892		1214-0255	G63888		3213-0033	G51713	
1214-0156	81931		1214-0191	61613		1214-0271	G63883		3213-0041	G51772	
1214-0157	61717		1214-0191	61614		1214-0272	G63907		3213-0046	G55821	
1214-0158	61696		1214-0191	81914		1214-0273	61582		3213-0047	G56591	
1214-0158	61697		1214-0192	61612		1214-0273	81147		3213-0074	G55909	
1214-0159	G64042		1214-0192	81913		1214-0305	61531		3213-0079	G55910	
1214-0161	G63879		1214-0193	61641		1214-0392	G63607		3213-0096	G52037	
1214-0161	G63884		1214-0193	81920		1214-0394	G63837		3213-0097	G52036	
1214-0162	61718		1214-0194	81922		1214-0395	61517		3213-0109	G51736	
1214-0163	61720		1214-0195	G63772		1214-0396	61522		3213-0138	G51256	
1214-0164	61734		1214-0196	61664		1214-0396	81496		3213-0144	G51077	
1214-0165	G63870		1214-0196	81869		1214-0408	81484		3213-0153	G51858	
1214-0166	G63867		1214-0198	81922		1214-0410	61608		3213-0155	G51767	
1214-0166	G64157		1214-0199	61663		1214-0415	G63511		3213-0157	69766	
1214-0167	G63890		1214-0199	81925		1214-0418	G63394		3213-0169	G55825	
1214-0167	G63891		1214-0200	81933		1214-0418	G63625		3213-0171	G51087	
1214-0168	61715		1214-0201	81932		1214-0420	61530		3213-0172	G51063	
1214-0169	G63867		1214-0202	69900		1214-0424	G63616		3213-0197	G51716	
1214-0169	G64079		1214-0203	61601		1214-0428	G64043		3213-0198	G51832	
1214-0170	61675		1214-0203	81836		1214-0429	G64038		3213-0199	G51833	
1214-0171	61690		1214-0204	61711		1214-0433	61554		3213-0200	69907	
1214-0172	61643		1214-0205	G63882		2213-0076	G44461		3213-0201	G51802	
1214-0173	G63958		1214-0206	G63894		2213-0077	69787		3213-0212	G51799	
1214-0174	61712		1214-0207	77803		2213-0120	G44986		3213-0236	G51738	
1214-0174	61714		1214-0210	61654		3212-0057	G51727		3213-0239	G51286	
1214-0175	G63614		1214-0211	61656		3212-0067	G51279		3213-0240	G51881	
1214-0175	G63622		1214-0212	61565		3212-0079	G51794		3213-0241	G51798	
1214-0176	61685		1214-0213	61687		3212-0103	G51254		3213-0245	G51961	
1214-0176	81668		1214-0214	61536		3212-0113	G51838		3213-0252	G56598	
1214-0177	61591		1214-0214	81549		3212-0147	69945		3213-0253	G51740	
1214-0178	61595		1214-0215	81560		3212-0147	81934		3213-0254	G51700	
1214-0178	61646		1214-0216	81837		3212-0170	G51908		3213-0256	G51814	

Important Note: Competitive Interchanges are to be used for stocking purposes only. Where multiple crosses are identified, please reference the applications section of this catalog. / **Remarque importante:** Les interchanges concurrentiels ne s'utilisent qu'aux fins de stocks. Dans le cas de références multiples, consulter la section des applications du catalogue. / **Nota importante:** Dans le cas de références multiples, consulter la section des applications du catalogue. / **Nota importante:** Se pueden usar intercambios competitivos para propósitos de almacenamiento solamente. Cuando se identifican intercambios múltiples, consulte la sección de aplicaciones de este catálogo.

COMPETITIVE & O.E.M. INTERCHANGE LIST
Lista de Intercambios contra Competidores y Equipo Original.
Liste dinterchange de produits complitifs & dquipement original (OEM)

SenSen... cont'd

Sensen	Gabriel	Upgrade	Sensen	Gabriel	Upgrade	Sensen	Gabriel	Upgrade	Sensen	Gabriel	Upgrade
3213-0257	G51813		3214-0114	G51703		4213-0590	G56887		4214-0699	G56671	
3213-0258	G51742		3214-0115	G51719		4213-0591	G56886		4214-0700	G56622	
3213-0259	G51804		3214-0116	G51729		4213-0604	G55879		4214-0701	G56621	
3213-0259	G51805		3214-0117	G56807		4213-0605	G55879		4214-0702	G56758	
3213-0261	70049		3214-0118	G51728		4213-0606	G51878		4214-0703	G56759	
3213-0262	G64049		3214-0119	G51760		4213-0607	G51877		4214-0712	G56561	
3213-0263	70013		3214-0119	G51761		4213-0608	G51892		4214-0713	G56562	
3213-0265	G56597		3214-0119	G51947		4213-0617	G51896		4214-0734	G55901	
3213-0269	G51905		3214-0119	G51948		4213-0617	G51897		4214-0747	G55948	
3213-0271	G511004		3214-0125	G51891		4213-0619	G51854		4214-0767	G56889	
3213-0284	G51815		3214-0132	G51477		4213-0620	G51853		4214-0768	G56888	
3213-0285	G51849		3214-0133	G51766		4213-0640	G52018		4214-0777	G52007	
3213-0288	G51746		3214-0134	G51715		4213-0640	G52162		4214-0778	G52004	
3213-0289	G51267		3214-0136	61590		4213-0641	G52017		4214-0790	G56718	
3213-0290	G51859		3214-0140	G51765		4213-0850	G52155		4214-0795	G52204	
3213-0291	G51842		3214-0150	G51855		4213-0851	G52154		4214-0796	G52203	
3213-0295	G51268		3214-0152	G51856		4213-0944	G55591		4214-0811	G52161	
3213-0305	G51267		3214-0162	G51861		4213-0945	G55591		4214-0812	G52160	
3213-0322	69450		3214-0168	G56838		4213-0958	G52354		4214-0813	G52104	
3213-0326	G63418		3214-0185	61561		4213-0959	G52353		4214-0814	G52103	
3213-0327	G51874		3214-0185	81744		4213-0960	G52440		4214-0815	G52300	
3213-0328	70053		3214-0186	G51850		4213-0961	G52439		4214-0816	G52299	
3213-0330	G51799		3214-0188	G56839		4213-0965	G51918		4214-0838	G56635	
3213-0331	70037		4213-0167	G51811		4213-0966	G51917		4214-0839	G56636	
3213-0337	G51879		4213-0168	G51810		4214-0014	G56606		4214-0840	G56641	
3213-0338	G51803		4213-0242	G52019		4214-0023	G55675		4214-0841	G56640	
3213-0383	70045		4213-0278	G55870		4214-0029	G52244		4214-0846	G56518	
3213-0451	G63720		4213-0279	G55820		4214-0029	G55949		4214-0847	G56518	
3213-0452	G51910		4213-0302	G51255		4214-0032	G55676		4214-0851	G56722	
3213-0513	70096		4213-0305	G55662		4214-0110	G56684		4214-0852	G56721	
3213-0515	G51852		4213-0306	G55661		4214-0111	G56683		4214-0853	G56729	
3213-0545	G511020		4213-0320	G55774		4214-0141	G55999		4214-0854	G56728	
3213-0546	G511019		4213-0321	G55774		4214-0142	G55999		4214-0855	G56802	
3213-0557	G64056		4213-0322	G56894		4214-0167	G56778		4214-0892	G52009	
3213-0599	61593		4213-0359	G52163		4214-0168	G56778		4214-0893	G52008	
3213-0600	G51884		4213-0366	G55999		4214-0191	G56539		4214-0901	G52185	
3213-0601	G51996		4213-0367	G55999		4214-0192	G56540		4214-0902	G52184	
3213-0602	G511001		4213-0368	G55999		4214-0248	G56633		4214-0903	G52169	
3213-0604	70089		4213-0370	G51714		4214-0249	G56634		4214-0904	G52168	
3213-0616	G511043		4213-0377	G56893		4214-0258	G56537		4214-0906	G52159	
3213-0624	70068		4213-0378	G56892		4214-0259	G56538		4214-0907	G52158	
3213-0635	70059		4213-0470	G51737		4214-0484	G56581		4214-1033	G52375	
3214-0032	G51723		4213-0489	G52335		4214-0485	G56582		4214-1034	G52374	
3214-0039	G51722		4213-0489	G52336		4214-0588	G52006		4214-1048	G56678	
3214-0053	G51477		4213-0491	G51806		4214-0589	G52005		4214-1049	G56677	
3214-0091	G51477		4213-0494	G51806		4214-0664	G56514		4214-1076	G52113	
3214-0092	G51739		4213-0501	G52153		4214-0665	G56506		4214-1077	G52112	
3214-0093	G51286		4213-0502	G52152		4214-0668	G55991		4214-1080	G56686	
3214-0094	G51077		4213-0513	G56529		4214-0674	G51097		4214-1081	G56685	
3214-0105	G51870		4213-0514	G56530		4214-0687	G56821		4214-1089	G56660	
3214-0107	G51865		4213-0534	G56517		4214-0688	G56822		4214-1090	G56661	
3214-0108	G51864		4213-0535	G56516		4214-0689	G56820		4214-1091	G52165	
3214-0110	G51724		4213-0583	G52334		4214-0690	G56819		4214-1091	G52298	
3214-0111	G51718		4213-0584	G52333		4214-0694	G55994		4214-1092	G52164	
3214-0112	G51888		4213-0585	G52095		4214-0695	G55993		4214-1092	G52297	
3214-0113	G51704		4213-0586	G52094		4214-0698	G56672		4214-1102	G52210	

Important Note: Competitive Interchanges are to be used for stocking purposes only. Where multiple crosses are identified, please reference the applications section of this catalog. / **Remarque importante:** Les interchanges concurrentiels ne s'utilisent qu'aux fins de stocks. Dans le cas de rfrences multiples, consulter la section des applications du catalogue. / **Nota importante:** Dans le cas de rfrences multiples, consulter la section des applications du catalogue. / **Nota importante:** Se pueden usar intercambios competitivos para propósitos de almacenamiento solamente. Cuando se identifican intercambios múltiples, consulte la sección de aplicaciones de este catálogo.

COMPETITIVE & O.E.M. INTERCHANGE LIST
Lista de Intercambios contra Competidores y Equipo Original.
Liste d'interchange de produits compétitifs & d'équipement original (OEM)

SenSen... cont'd

Sensen	Gabriel	Upgrade	Sensen	Gabriel	Upgrade	Sensen	Gabriel	Upgrade	Sensen	Gabriel	Upgrade
4214-1103	G52209		4214-1336	G56701		4214-2394	G52383		9213-0097	G57419	
4214-1157	G56799		4214-1345	G56784		4214-2395	G52382		9213-0098	G57425	
4214-1158	G56800		4214-1346	G56785		9212-0001	G57036		9213-0099	G57424	
4214-1159	G52098		4214-1347	G52025		9212-0002	G56998		9213-0100	G57208	
4214-1172	G56735		4214-1347	G55948		9212-0003	G57057		9213-0102	G57270	
4214-1173	G56734		4214-1393	G52188		9212-0003	G57058		9213-0103	G57427	
4214-1174	G56680		4214-1394	G52187		9212-0004	G57159		9213-0104	G57148	
4214-1174	G56731		4214-1407	G52128		9212-0004	G57160		9213-0106	G57428	
4214-1175	G56679		4214-1408	G52127		9213-0001	G56996		9213-0107	G57429	
4214-1175	G56730		4214-1409	G52118		9213-0002	G57013		9213-0108	G57430	
4214-1176	G56894		4214-1410	G52117		9213-0003	G56997		9213-0110	G57423	
4214-1177	G52248		4214-1411	G52118		9213-0004	G57014		9213-0113	G57108	
4214-1178	G52247		4214-1412	G52117		9213-0005	G57020		9213-0114	G57107	
4214-1182	G56751		4214-1428	G52122		9213-0010	G56938		9213-0116	G57415	
4214-1183	G56750		4214-1429	G52121		9213-0011	G56950		9213-0117	G57414	
4214-1184	G56688		4214-1432	G52125		9213-0012	G56949		9213-0119	G57682	
4214-1185	G56687		4214-1433	G52332		9213-0024	G57421		9213-0120	G57416	
4214-1186	G52145		4214-1434	G52331		9213-0025	G57420		9213-0121	G57458	
4214-1187	G52144		4214-1437	G52014		9213-0029	G57064		9213-0122	G57457	
4214-1188	G52141		4214-1438	G52013		9213-0030	G56992		9213-0162	G57453	
4214-1189	G52140		4214-1441	G52157		9213-0031	G57026		9213-0162	G57454	
4214-1191	G52106		4214-1442	G52156		9213-0032	G56948		9214-0001	G56936	
4214-1192	G52105		4214-1445	G56843		9213-0033	G57063		9214-0002	G57019	
4214-1198	G56733		4214-1446	G56842		9213-0034	G56948		9214-0004	G57016	
4214-1199	G56732		4214-1447	G52254		9213-0035	G56991		9214-0005	G57021	
4214-1202	G52108		4214-1448	G52253		9213-0038	G57087		9214-0006	G57007	
4214-1202	G56797		4214-1462	G56735		9213-0039	G57086		9214-0007	G57015	
4214-1203	G52107		4214-1463	G56734		9213-0046	G57035		9214-0008	G57022	
4214-1203	G56798		4214-1466	G51758		9213-0047	G57034		9214-0009	G57018	
4214-1257	G52131		4214-1467	G51860		9213-0048	G57033		9214-0010	G57017	
4214-1258	G56620		4214-1476	G52033		9213-0048	G57062		9214-0011	G56927	
4214-1261	G56568		4214-1477	G52032		9213-0049	G57032		9214-0011	G56931	
4214-1262	G56601		4214-1559	G52143		9213-0049	G57061		9214-0012	G56930	
4214-1264	G55681		4214-1560	G52142		9213-0050	G56943		9214-0014	G57060	
4214-1265	G56655		4214-1731	G52258		9213-0051	G57168		9214-0015	G57060	
4214-1267	G56817		4214-1732	G52257		9213-0052	G57167		9214-0016	G56933	
4214-1270	G56836		4214-1775	G52149		9213-0053	G57055		9214-0017	G56931	
4214-1271	G56837		4214-1776	G52148		9213-0054	G57054		9214-0019	G57008	
4214-1272	G56841		4214-1899	G52246		9213-0055	G57089		9214-0020	G56924	
4214-1273	G56840		4214-1900	G52245		9213-0056	G57088		9214-0021	G56925	
4214-1274	G52116		4214-2072	G52281		9213-0057	G57409		9214-0075	G56935	
4214-1275	G52082		4214-2073	G52280		9213-0058	G57146		9214-0076	G56934	
4214-1276	G52081		4214-2076	G52406		9213-0065	G57068		9214-0076	G56937	
4214-1277	G55892		4214-2085	G52295		9213-0066	G57067		9214-0077	G57051	
4214-1280	G55948		4214-2086	G52097		9213-0074	G57404		9214-0078	G56932	
4214-1284	G55856		4214-2087	G52096		9213-0075	G57405		9214-0079	G56963	
4214-1286	G55697		4214-2127	G56700		9213-0076	G57059		9214-0080	G56965	
4214-1288	G56810		4214-2129	G55551		9213-0079	G57279		9214-0081	G56951	
4214-1292	G56809		4214-2131	G55579		9213-0080	G57278		9214-0083	G57066	
4214-1293	G56774		4214-2138	G56518		9213-0081	G57422		9214-0084	G56962	
4214-1294	G56773		4214-2201	G52250		9213-0082	G57056		9214-0089	G57065	
4214-1295	G52027		4214-2202	G52249		9213-0083	G57075		9214-0090	G57085	
4214-1296	G52026		4214-2241	G52174		9213-0084	G57091		9214-0091	G57084	
4214-1302	G56509		4214-2242	G52173		9213-0085	G57090		9214-0099	G57046	
4214-1303	G55896		4214-2390	G52361		9213-0095	G57149		9214-0100	G57045	
4214-1304	G55698		4214-2391	G52360		9213-0096	G57178		9214-0101	G57031	

Important Note: Competitive Interchanges are to be used for stocking purposes only. Where multiple crosses are identified, please reference the applications section of this catalog. / **Remarque importante:** Les interchanges concurrentiels ne s'utilisent qu'aux fins de stocks. Dans le cas de références multiples, consulter la section des applications du catalogue. / **Nota importante:** Dans le cas de références multiples, consulter la section des applications du catalogue. / **Nota importante:** Se pueden usar intercambios competitivos para propósitos de almacenamiento solamente. Cuando se identifican intercambios múltiples, consulte la sección de aplicaciones de este catálogo.

COMPETITIVE & O.E.M. INTERCHANGE LIST
Lista de Intercambios contra Competidores y Equipo Original.
Liste d'interchange de produits compititifs & d'equipement original (OEM)

SenSen... cont'd

Sensen	Gabriel	Upgrade	Sensen	Gabriel	Upgrade	Sensen	Gabriel	Upgrade	Sensen	Gabriel	Upgrade
9214-0102	G57030		9214-0161	G57027		9214-0250	G57218		9214-0353	G57131	
9214-0103	G57050		9214-0162	G57027		9214-0251	G57363		9214-0354	G57130	
9214-0104	G57049		9214-0163	G57125		9214-0252	G57364		9214-0371	G57394	
9214-0107	G57134		9214-0164	G56951		9214-0255	G57370		9214-0372	G57393	
9214-0108	G57133		9214-0169	G57099		9214-0256	G57369		9214-0414	G57494	
9214-0109	G57124		9214-0169	G57100		9214-0257	G57365		9214-0415	G57493	
9214-0110	G57123		9214-0171	G57158		9214-0258	G57366		9214-0416	G57376	
9214-0113	G57012		9214-0177	G57372		9214-0259	G57342		9214-0417	G57375	
9214-0114	G57011		9214-0178	G57373		9214-0260	G57341		9214-0430	G57664	
9214-0119	G57050		9214-0179	G57162		9214-0263	G57340		9214-0431	G57663	
9214-0120	G57049		9214-0180	G57161		9214-0264	G57339		9214-0440	G57274	
9214-0121	G57027		9214-0181	G57191		9214-0265	G57346		9214-0447	G57518	
9214-0122	G57027		9214-0182	G57190		9214-0266	G57345		9214-0448	G57517	
9214-0123	G57077		9214-0183	G57193		9214-0267	G57269		9214-0451	G56726	
9214-0124	G57076		9214-0184	G57192		9214-0268	G57268		9214-0452	G57006	
9214-0125	G57092		9214-0186	G57271		9214-0273	G57223		9214-0456	G56929	
9214-0125	G57118		9214-0187	G57095		9214-0274	G57222		9214-0465	G57177	
9214-0125	G57413		9214-0188	G57096		9214-0275	G57277		9214-0466	G57176	
9214-0125	G57646		9214-0189	G56964		9214-0276	G57324		9214-0475	G56974	
9214-0127	G57039		9214-0190	G57111		9214-0277	G57201		9214-0476	G56973	
9214-0128	G57103		9214-0191	G57110		9214-0278	G57200		9214-0483	G57646	
9214-0128	G57132		9214-0192	G57191		9214-0279	G57109		9214-0484	G57645	
9214-0129	G57053		9214-0193	G57190		9214-0280	G57276		9214-0501	G57198	
9214-0130	G57115		9214-0194	G57113		9214-0281	G57275		9214-0502	G57197	
9214-0131	G57114		9214-0195	G57112		9214-0284	G57609		9214-0543	G57613	
9214-0132	G57048		9214-0196	G57098		9214-0285	G57608		9214-0544	G57612	
9214-0133	G57047		9214-0197	G57097		9214-0286	G57490		9214-0545	G57072	
9214-0134	G57044		9214-0210	G57177		9214-0287	G57489		9214-0546	G57071	
9214-0135	G57043		9214-0211	G57176		9214-0290	G57460		9214-0547	G52273	
9214-0136	G57079		9214-0212	G57120		9214-0291	G57459		9214-0548	G52272	
9214-0137	G57078		9214-0213	G57119		9214-0294	G57153		9214-0562	G57647	
9214-0138	G57042		9214-0214	G57378		9214-0295	G57152		9214-0579	G57145	
9214-0139	G57041		9214-0215	G57377		9214-0296	G57151		9214-0580	G57144	
9214-0140	G56931		9214-0216	G57031		9214-0297	G57150		9214-0592	G57354	
9214-0141	G56930		9214-0217	G57030		9214-0298	G57140		9214-0593	G57353	
9214-0142	G56925		9214-0218	G57142		9214-0299	G57139		9214-0600	G57615	
9214-0143	G56924		9214-0219	G57141		9214-0313	G57474		9214-0601	G57614	
9214-0144	G56957		9214-0220	G57106		9214-0314	G57473		B70090	143063	
9214-0145	G56956		9214-0221	G57105		9214-0319	G57203		B70100	143057	
9214-0146	G57083		9214-0222	G57081		9214-0320	G57202		B70120	143058	
9214-0147	G57083		9214-0223	G57082		9214-0321	G57334		B70150	143057	
9214-0148	G57070		9214-0226	G57312		9214-0322	G57333		B70160	143059	
9214-0148	G57122		9214-0227	G57311		9214-0325	G57362		B70170	143061	
9214-0149	G57069		9214-0234	G57338		9214-0326	G57361		B70250	143058	
9214-0149	G57121		9214-0235	G57337		9214-0327	G57391		B72270	143058	
9214-0150	G57010		9214-0236	G57282		9214-0328	G57390		M70000	142651	
9214-0151	G57010		9214-0237	G56975		9214-0329	G57573		M70040	142650	
9214-0152	G57060		9214-0238	G57031		9214-0330	G57572		M70070	142649	
9214-0153	G57071		9214-0239	G57030		9214-0331	G57456		M70135	143477	
9214-0155	G57000		9214-0240	G57164		9214-0332	G57455		M70140	143281	
9214-0155	G57023		9214-0241	G57163		9214-0333	G57332		M70150	143088	
9214-0156	G57147		9214-0242	G57267		9214-0334	G57331		M70170	143315	
9214-0157	G57172		9214-0243	G57266		9214-0341	G57488		M70205	143365	
9214-0158	G57080		9214-0244	G57206		9214-0342	G57487		M70215	143531	
9214-0159	G57173		9214-0247	G56924		9214-0351	G57185		M70220	142836	
9214-0160	G56928		9214-0249	G57219		9214-0352	G57184		M70230	142546	

Important Note: Competitive Interchanges are to be used for stocking purposes only. Where multiple crosses are identified, please reference the applications section of this catalog. / **Remarque importante:** Les interchanges concurrentiels ne s'utilisent qu'aux fins de stocks. Dans le cas de rfrences multiples, consulter la section des applications du catalogue. / **Nota importante:** Dans le cas de rfrences multiples, consulter la section des applications du catalogue. / **Nota importante:** Se pueden usar intercambios competitivos para propósitos de almacenamiento solamente. Cuando se identifican intercambios múltiples, consulte la sección de aplicaciones de este catálogo.

COMPETITIVE & O.E.M. INTERCHANGE LIST
Lista de Intercambios contra Competidores y Equipo Original.
Liste dinterchange de produits comptitifs & dquipement original (OEM)

SenSen... cont'd

Sensen	Gabriel	Upgrade	Sensen	Gabriel	Upgrade	Sensen	Gabriel	Upgrade	Sensen	Gabriel	Upgrade
M70265	143390		M71190	142403		M72770	143317		M73620	143464	
M70275	143391		M71200	142852		M72780	143244		M73630	143202	
M70280	142252		M71280	143404		M72790	143266		M73690	143318	
M70285	143383		M71730	143191		M72800	143255		M73700	143353	
M70290	143492		M71800	142735		M72810	143323		M73710	143353	
M70300	143367		M71950	142230		M72820	143355		M73770	143204	
M70330	142938		M71950	142419		M72830	143354		M73780	143201	
M70350	142949		M71950	143423		M72840	143316		M73805	143341	
M70375	143344		M72030	143218		M72860	143385		M73855	143335	
M70440	143082		M72070	143388		M72880	143364		M73970	143345	
M70450	143325		M72080	143387		M72890	143369		M74045	143089	
M70490	142625		M72180	143087		M72890	143468		M74055	143363	
M70510	142561		M72440	142530		M72910	143319		M74065	143342	
M70550	142444		M72470	142244		M73080	142547		M75125	143339	
M70660	143458		M72500	142245		M73090	142937		M75140	143393	
M70690	142195		M72600	143074		M73120	143305		M75155	143406	
M70700	142135		M72610	143073		M73280	143324		M75165	143360	
M70820	142250		M72630	142526		M73510	142439		M75170	143361	
M70870	143209		M72680	142828		M73520	143256		M75175	143495	
M70920	143197		M72690	142932		M73540	143191		M75235	143473	
M71180	142404		M72700	142930		M73590	143241				

Stellantis

Stellantis	Gabriel	Upgrade	Stellantis	Gabriel	Upgrade	Stellantis	Gabriel	Upgrade	Stellantis	Gabriel	Upgrade
0489 5466AC	G51948		4684 779	81459		4886 509AI	61536		5105 171AH	G57176	
0489 5467AC	G51947		4694 773	69632		489 5747AA	G57071		5105 790AL	G51863	
05168284AC	85649		4694 773	81459		489 5747AA	G57072		5114 318AB	81936	
05168295AB	85649		4721 686AE	G64042		489 5748AB	G57071		5135 538AA	G56620	
05168296AA	85650		4721 687AB	G64042		489 5748AB	G57072		5135 573AJ	G56807	
2174 915AG	G57053		4743 125	G63426		4895 000AE	G55856		5161 265AC	G57146	
2516 009	G63183		4743 127	G63426		4895 516AC	G57194		5161 273AC	G57146	
2516009	G63183		4743 128	G63426		4895 516AC	G57195		5161 274AB	G57146	
2960 707	G63183		4743 224AA	61605		4897 412AD	81548		5166 820AI	G56807	
2960707	G63183		4743 225AA	61605		4897 412AH	61535		5168 236AB	143336	
2961 043	G63183		4743 229AA	61605		4897 413AA	81691		5170 297AG	G57053	
2961043	G63183		4743 413AC	81878		4897 413AG	81548		5170 298AG	G57053	
3633 643	G63183		4743 866AD	G51848		4897 414AG	61535		5170 298AH	G57053	
3633 744	G63183		4764 523AA	G51267		4897 414AG	81691		5171 093AC	143336	
3633643	G63183		4766 053AF	G51863		4897 443AD	81928		5171 122AC	143336	
3633744	G63183		4766 124	G63426		4897 451AA	G55697		5174 300AH	G57053	
3638 112	G63183		4766 957AD	G51848		4897 472AD	81919		5174 563AF	G57146	
3638 631	G63605		4766 958AD	G51848		4897 567AA	81936		5174 915AH	G57053	
3638112	G63183		478 2643AD	G57194		5014 730AA	81869		5174 997AD	G51758	
3638631	G63605		478 2643AD	G57195		5014 732AG	81869		518 0998AA	G57071	
4036 892	G63605		478 2731AE	G57071		5015 442AD	81836		518 0998AA	G57072	
4036892	G63605		478 2731AE	G57072		5016 354AB	81836		5180 998AA	G57194	
4443 482	81825		478 2731AE	G57194		5066 334AA	G56620		5180 998AA	G57195	
4656 439AH	69473		478 2731AE	G57195		5066 336AA	G56620		52038134	81559	
4656 449AD	G55896		478 2732AE	G57071		5073 263AC	81932		52038135	81559	
4656 612AH	69473		478 2732AE	G57072		5073 265AC	81932		52038910	81837	
4670 468AA	143385		4782 644AD	G57194		5085 461AB	143495		52038912	81837	
4684 681AB	81878		4782 644AD	G57195		5103 514AC	81933		52038914	81837	
4684 682AB	81878		4782 732AE	G57194		5105 096AG	G57177		52039302	81560	
4684 770	69632		4782 732AE	G57195		5105 097AG	G57176		52039303	81560	
4684 770	81459		4782 733AD	G57194		5105 105AF	G57178				
4684 777	69632		4782 733AD	G57195		5105 170AF	G57177				
4684 777	81459		4782 734AD	G57194		5105 170AH	G57177				
4684 779	69632		4782 734AD	G57195		5105 171AF	G57176				

Important Note: Competitive Interchanges are to be used for stocking purposes only. Where multiple crosses are identified, please reference the applications section of this catalog. / **Remarque importante:** Les interchanges concurrentiels ne s'utilisent qu'aux fins de stocks. Dans le cas de références multiples, consulter la section des applications du catalogue. / **Nota importante:** Dans le cas de referencias multiples, consultar la sección de aplicaciones del catálogo. / **Nota importante:** Se pueden usar intercambios competitivos para propósitos de almacenamiento solamente. Cuando se identifican intercambios múltiples, consulte la sección de aplicaciones de este catálogo.

COMPETITIVE & O.E.M. INTERCHANGE LIST
Lista de Intercambios contra Competidores y Equipo Original.
Liste dinterchange de produits comptitifs & dquipement original (OEM)

Stellantis... cont'd

Stellantis	Gabriel	Upgrade	Stellantis	Gabriel	Upgrade	Stellantis	Gabriel	Upgrade	Stellantis	Gabriel	Upgrade
5208 7777AF	61536		6802 6142AD	G52118		6804 7814AB	G63966		6815 6980AB	G52131	
5208 777AF	81549		6802 6143AC	G52117		6805 3860AA	14040		6815 7795AD	G57800	
5208 7948AF	61536		6802 6143AD	G52117		6805 7374AA	G64043		6815 7795AD	G57801	
5208 7948AF	81549		6802 6148AD	G52118		6805 8866AA	G51842		6817 0198AB	G51856	
5208 8221AG	81926		6802 6149AC	G52117		6806 7325AA	G64043		6817 0199AB	G51856	
5208 8235AE	81926		6802 6149AD	G52117		6806 7515AD	G63967		6818 5556AE	G57800	
5208 8654AB	81929		6802 6158AD	G52118		6806 7516AF	G64008		6818 5556AE	G57801	
5208 9751AL	61715		6802 6159AD	G52117		6808 7339AA	G52131		6821 0451AA	G64008	
52087901	81891		6802 6528AD	G52118		6808 7359AF	G64008		6821 0452AA	G63966	
5210 6928AB	81923		6802 6529AD	G52117		6808 7362AD	G63967		6822 4858AD	G511038	
5210 6955AB	81923		6803 3950AB	G52131		6808 7363AC	G63967		6822 4861AD	G511038	
5210 9912AD	G63844		6803 9638AF	G52149		6809 2726AA	G64042		6823 4553AD	61712	
5211 0211AB	81931		6803 9639AF	G52148		6811 1104AB	85649		6824 5775AA	G57800	
5211 0214AB	81931		6803 9640AB	G52149		6811 1104AB-001	85649		6824 5775AA	G57801	
5272 325AE	G55892		6803 9640AE	G52149		6811 1104AB001	85649		6827 0280AA	G57800	
5272 612AK	G51863		6803 9641AB	G52148		6811 1105AC	85649		6827 0280AA	G57801	
5272 613AL	G51863		6803 9641AE	G52148		6811 1105AC-001	85649		G0060043	81834	
5272 706AE	G57178		6803 9642AF	G52149		6811 1105AC001	85649		MB109561	G63950	
5272 706AH	G57178		6803 9643AF	G52148		6811 1107AA	85650		MB111216	G63419	
5285 3460AE	G64044		6804 0880AG	G64011		6811 1107AA-001	85650		MB242146	81147	
5285 5333AF	G63892		6804 0882AD	G64011		6811 1107AA001	85650		MB515371	81147	
5285 5334AD	G63892		6804 2864AC	G52131		6813 8247AC	G64042		MB910496	G55820	
5285 5791AC	G64044		6804 3990AB	G52149		6813 8247AE	G64042		SG23086	81496	
6800 1151AB	61720		6804 3991AB	G52148		6813 8775AB	G64008		SG23095	69632	
6800 3952AC	G51728		6804 6314AB	G57007		6813 9381AA	61712		SG23095	81459	
6800 3954AB	G51728		6804 6314AC	G57007		6814 4549AE	G64042		SG23127	81096	
6802 6140AD	G52118		6804 6314AD	G57007		6814 8548AC	G52149		SG81819	G55526	
6802 6141AD	G52117		6804 6318AB	G57007		6814 8549AC	G52148				
6802 6142AC	G52118		6804 7812AD	G64008		6815 5259AC	G57007				

Subaru

Subaru	Gabriel	Upgrade	Subaru	Gabriel	Upgrade	Subaru	Gabriel	Upgrade	Subaru	Gabriel	Upgrade
20310 AG04A	G52273		20310 SC102	G52375		20360 SA1919L	G52182		20365SC021	G51961	
20310 AG05A	G52272		20310 SC112	G52374		20365 AE05A	G51767		20365SC051	G51961	
20310 SC062	G52375		20320 AA100	143492		20365 AG14A	G51910				
20310 SC072	G52374		20360 SA1819L	G52183		20365SC001	G51961				

Suzuki

Suzuki	Gabriel	Upgrade	Suzuki	Gabriel	Upgrade	Suzuki	Gabriel	Upgrade	Suzuki	Gabriel	Upgrade
88946326	143204										

SYD

Syd	Gabriel	Upgrade	Syd	Gabriel	Upgrade	Syd	Gabriel	Upgrade	Syd	Gabriel	Upgrade
1209003	G51917		1909016	G52297		6709120	G51766		7000035	81933	
1209004	G51918		1909017	G52298		6709121	G63907		7000036	61691	
1209005	G51919		1909019	G51934		7000007	70003		7000036	61692	
1209006	G51919		1909026	G52314		7000008	81934		7000039	G63969	
1209010	G52250		1909027	G52314		7000009	70056		7000040	77968	
1209011	G52249		2709080	G52396		7000010	70041		7000041	G63716	
1209012	G64080		2709081	G52395		7000011	70027		7000044	81490	
1209013	G52187		2709083	G52280		7000012	69587		7000045	81713	
1209014	G52188		2709084	G52281		7000018	69945		7000048	81928	
1209015	G51966		4009076	G52352		7000020	81147		7000049	61600	
1209016	G52141		4009077	G52351		7000022	61508		7000050	61500	
1209017	G52140		4709033	70207		7000024	61531		7000056	81082	
1209018	G64003		5009031	G64104		7000025	G63608		7000057	G63813	
1609006	G51740		5009032	G52361		7000026	81730				
1909013	G52164		5009033	G52360		7000027	81878				
1909014	G52165		5009034	G51972		7000028	61504				
1909015	G51881		6709082	G63907		7000034	G63875				

Important Note: Competitive Interchanges are to be used for stocking purposes only. Where multiple crosses are identified, please reference the applications section of this catalog. / **Remarque importante:** Les interchanges concurrentiels ne s'utilisent qu'aux fins de stocks. Dans le cas de rferences multiples, consulter la section des applications du catalogue. / **Nota importante:** Dans le cas de rferences multiples, consulter la section des applications du catalogue. / **Nota importante:** Se pueden usar intercambios competitivos para propósitos de almacenamiento solamente. Cuando se identifican intercambios múltiples, consulte la sección de aplicaciones de este catálogo.

COMPETITIVE & O.E.M. INTERCHANGE LIST
Lista de Intercambios contra Competidores y Equipo Original.
Liste dinterchange de produits comptitifs & dquipement original (OEM)

SYD... cont'd

Syd	Gabriel	Upgrade	Syd	Gabriel	Upgrade	Syd	Gabriel	Upgrade	Syd	Gabriel	Upgrade
7000058	81668		7000158	81446		7000259	G51804		7000344	G52299	
7000059	81667		7000160	81495		7000260	61711		7000345	G52261	
7000060	81918		7000162	81459		7000261	G511004		7000346	G52260	
7000062	61629		7000164	61663		7000264	69946		7000350	G52188	
7000064	G63776		7000164	81922		7000265	G51870		7000351	G52187	
7000064	G63868		7000164	81925		7000270	G56838		7000352	G52149	
7000065	G63678		7000166	61641		7000271	G56839		7000353	G52148	
7000066	G63844		7000166	81920		7000272	G52131		7000354	G51848	
7000067	69900		7000167	81873		7000273	G51838		7000359	G52256	
7000068	G64026		7000167	81921		7000275	G51279		7000360	G52255	
7000068	G64151		7000170	G63929		7000276	G55909		7000361	G52128	
7000073	G51815		7000171	G63624		7000277	G55910		7000361	G64015	
7000075	G51268		7000172	G63608		7000278	G51087		7000362	G52127	
7000077	G51700		7000173	G63813		7000279	G51722		7000363	G52200	
7000078	G56672		7000175	G63873		7000280	G51724		7000364	G52199	
7000079	G56671		7000176	G51891		7000281	G51727		7000365	G52174	
7000080	G56622		7000177	G63866		7000282	G51740		7000366	G52173	
7000081	G56621		7000179	G51863		7000283	69586		7000367	G64050	
7000082	G56606		7000180	G52118		7000285	G51887		7000374	61734	
7000083	G51267		7000181	G52117		7000286	G51738		7000375	61715	
7000084	G51728		7000182	G56517		7000287	G56807		7000385	G64042	
7000085	G55892		7000183	G56516		7000288	G51723		7000386	G51983	
7000086	G56568		7000184	G52238		7000289	G56684		7000393	81318	
7000087	G56601		7000184	G56751		7000290	G56683		7000397	6847SE	
7000088	G55948		7000185	G52237		7000291	G55896		7000398	81872	
7000088	G55949		7000185	G56750		7000292	G52244		7000400	82156	
7000089	G55526		7000186	G55870		7000309	G56655		7000403	81541	
7000099	G56810		7000188	G51737		7000310	G56817		7000404	G63937	
7000100	70086		7000191	G52025		7000311	G56678		7000405	G51077	
7000101	G52006		7000192	G51859		7000312	G56677		7000406	6853SE	
7000102	G52005		7000195	G52143		7000313	69592		7000407	61699	
7000103	G52007		7000196	G52142		7000313	69593		7000408	81869	
7000104	G52004		7000210	G55825		7000314	G56722		7000410	81926	
7000105	G56887		7000212	G55698		7000315	G56721		7000411	G51739	
7000106	G56886		7000214	61718		7000316	G56728		7000411	G51853	
7000108	G56899		7000215	61720		7000317	G56729		7000411	G51854	
7000109	G52275		7000218	6804SE		7000318	G56774		7000414	81478	
7000110	G52274		7000219	6828SE		7000319	G56773		7000415	G63905	
7000113	G52081		7000220	14071		7000320	G56797		7000417	61700	
7000114	G52082		7000223	70060		7000321	G56798		7000418	G63915	
7000115	G52095		7000224	G52283		7000324	G56841		7000419	81923	
7000116	G52094		7000225	G52282		7000325	G56840		7000420	G63716	
7000117	G51842		7000227	70045		7000326	G64037		7000420	G63809	
7000130	G56620		7000229	70052		7000329	G56843		7000426	G511044	
7000134	G55697		7000233	G63547		7000330	G56842		7000427	G51990	
7000135	G63679		7000234	69465		7000331	G52155		7000433	G52494	
7000136	G63890		7000235	69473		7000332	G52154		7000434	G52495	
7000136	G63891		7000238	82130		7000333	G56889		7000435	G511030	
7000149	G55991		7000239	G63717		7000334	G56888		7000436	G51949	
7000151	G51807		7000241	81076		7000335	G52104		7000439	G63867	
7000152	70036		7000243	61643		7000336	G52103		7000443	69590	
7000153	G51783		7000244	G63778		7000339	G52108		7000445	G52025	
7000155	69589		7000247	G63622		7000340	G52107		7000446	G51971	
7000156	69591		7000248	61646		7000341	G52106		7000452	G51860	
7000157	69464		7000250	81726		7000342	G52105		7000453	G51861	
7000157	81935		7000258	G63772		7000343	G52300		7000454	G51850	

Important Note: Competitive Interchanges are to be used for stocking purposes only. Where multiple crosses are identified, please reference the applications section of this catalog. / **Remarque importante:** Les interchanges concurrentiels ne s'utilisent qu'aux fins de stocks. Dans le cas de références multiples, consulter la section des applications du catalogue. / **Nota importante:** Dans le cas de referencias multiples, consultar la sección de aplicaciones del catálogo. / **Nota importante:** Se pueden usar intercambios competitivos para propósitos de almacenamiento solamente. Cuando se identifican intercambios múltiples, consulte la sección de aplicaciones de este catálogo.

COMPETITIVE & O.E.M. INTERCHANGE LIST
Lista de Intercambios contra Competidores y Equipo Original.
Liste dinterchange de produits compititifs & equipement original (OEM)

SYD... cont'd

Syd	Gabriel	Upgrade	Syd	Gabriel	Upgrade	Syd	Gabriel	Upgrade	Syd	Gabriel	Upgrade
7000455	G63882		7000516	G51766		7000575	G51858		7000691	G511142	
7000456	G63884		7000517	G51842		7000579	G64111		7000692	G64148	
7000457	G63879		7000518	G52082		7000581	G52293		7000693	G64121	
7000458	G51718		7000519	G52081		7000582	G52294		7000694	G52209	
7000459	61717		7000520	G52354		7000583	G51933		7000695	G52210	
7000460	G52125		7000521	G52353		7000584	G64052		7000696	G64056	
7000461	G64040		7000522	70095		7000586	G52281		7000699	G511001	
7000462	G51878		7000522	70098		7000587	G52280		7000719	G56778	
7000463	G51877		7000522	70208		7000588	G51916		7000721	G63918	
7000464	G51892		7000528	G52171		7000589	G52395		7000722	G63918	
7000465	G52153		7000529	G52170		7000590	G52396		7000745	G64216	
7000466	G52152		7000530	G51884		7000596	G52352		7000746	69813	
7000467	G51905		7000539	G52360		7000597	G52351		7000747	G56582	
7000475	G56660		7000540	G52361		7000602	G51874		7000748	G52185	
7000476	G56661		7000541	G64104		7000603	G52121		7000749	G52184	
7000477	G51736		7000546	G52254		7000604	G52122		7000750	G51879	
7000478	G52246		7000547	G52253		7000608	G51972		7000753	G63862	
7000479	G52245		7000548	G511002		7000609	G511092		7000753	G64047	
7000480	G51898		7000548	G511134		7000616	81904		7000763	70207	
7000487	G51798		7000548	G511135		7000622	G63889		7000764	G52410	
7000487	G52009		7000554	G52406		7000622	G64006		7000765	G52411	
7000488	G52008		7000555	G52301		7000625	G52278		7000791	G51908	
7000490	G51766		7000556	G51993		7000626	G52279		7000797	G52439	
7000491	G64031		7000557	82001		7000628	G511000		7000798	G52440	
7000493	G64089		7000563	G64063		7000638	G51897		7000802	G511078	
7000495	G63907		7000567	81904		7000639	G51896		8709033	G63815	
7000501	G56799		7000568	70034		7000647	G511122		8709034	G51477	
7000502	G56800		7000569	70059		7000647	G511123		8709056	G51855	
7000503	G51286		7000570	G63860		7000651	70010		8709057	G64038	
7000504	G56758		7000571	G511007		7000652	G52525		8709073	G52245	
7000505	G56759		7000573	G52112		7000653	G52524		8709074	G52246	
7000506	61704		7000574	G52113		7000688	G511038				

Tokico

Tokico	Gabriel	Upgrade	Tokico	Gabriel	Upgrade	Tokico	Gabriel	Upgrade	Tokico	Gabriel	Upgrade
2219	G63909		E3816	G63492		E4125	G63775				
2518	G63492		E4124	G63678		E4153	G63775				

Toyota

Toyota	Gabriel	Upgrade	Toyota	Gabriel	Upgrade	Toyota	Gabriel	Upgrade	Toyota	Gabriel	Upgrade
19294294	143094		48510-09S80	G52246		48510-80516	G57354		48510-A9560	G57027	
48401-47010	143094		48510-09S90	G52246		48510-80528	G52246		48510-A9580	G57027	
48510-09A71	G52246		48510-09T00	G52246		48510-80563	G52246		48510-A9590	G57027	
48510-09L81	G57133		48510-09T10	G52246		48510-80637	G52007		48510-A9690	G52108	
48510-09Q50	G57124		48510-09T90	G52246		48510-8Z010	G52246		48510-A9700	G52106	
48510-09Q63	G57124		48510-09U50	G57133		48510-8Z162	G57124		48510-A9840	G52202	
48510-09Q70	G57124		48510-1A130	G55591		48510-8Z163	G57124		48510-B9810	G52202	
48510-09Q90	G57124		48510-1A260	G55591		48510-8Z254	G57133		48510-B9820	G52202	
48510-09Q92	G57124		48510-49535	G56581		48510-8Z255	G57133		48520-09A71	G52245	
48510-09Q93	G51855		48510-49655	G56680		48510-A9280	G57027		48520-09F00	G51853	
48510-09Q94	G57124		48510-49705	G56581		48510-A9290	G57027		48520-09L10	G52245	
48510-09Q95	G57124		48510-52C31	G57354		48510-A9300	G57027		48520-09L20	G52245	
48510-09R10	G57124		48510-80013	G56721		48510-A9310	G57027		48520-09L30	G52245	
48510-09R20M	G57124		48510-80142	G52097		48510-A9330	G52014		48520-09L40	G52245	
48510-09R30	G57124		48510-80294	G57354		48510-A9360	G56731		48520-09M20	G52245	
48510-09S60	G51937		48510-80307	G51832		48510-A9520	G57027				
48510-09S61	G51937		48510-80480	G52202		48510-A9530	G57027				
48510-09S70	G51937		48510-80497	G51739		48510-A9540	G57027				
48510-09S71	G57453		48510-80498	G57133		48510-A9550	G57027				

Important Note: Competitive Interchanges are to be used for stocking purposes only. Where multiple crosses are identified, please reference the applications section of this catalog. / **Remarque importante:** Les interchanges concurrentiels ne s'utilisent qu'aux fins de stocks. Dans le cas de rfrences multiples, consulter la section des applications du catalogue. / **Nota importante:** Dans le cas de rfrences multiples, consulte la section des aplicaciones del catalogo. / **Nota importante:** Se pueden usar intercambios competitivos para propósitos de almacenamiento solamente. Cuando se identifican intercambios múltiples, consulte la sección de aplicaciones de este catálogo.

COMPETITIVE & O.E.M. INTERCHANGE LIST
Lista de Intercambios contra Competidores y Equipo Original.
Liste d'interchange de produits compititifs & d'equipement original (OEM)

Toyota... cont'd

Toyota	Gabriel	Upgrade	Toyota	Gabriel	Upgrade	Toyota	Gabriel	Upgrade	Toyota	Gabriel	Upgrade
48520-09T60	G52245		48530-09895	G64006		48530-80603	G63885		48603-33021	142649	
48520-29835	G52096		48530-09896	G64006		48530-80604	G63885		48609-06090	143202	
48520-33010	142561		48530-09M90	G64038		48530-A9200	G56735		48609-0C030	143339	
48520-49615	G56582		48530-09N20	G64038		48530-A9210	G56733		48609-0E010	143202	
48520-49715	G56679		48530-09N40	G64038		48530-A9720	G52204		48609-21030	143406	
48520-49775	G56582		48530-09N50	G64038		48530-A9740	G52204		48609-33011	142561	
48520-52141	G57353		48530-09N91	G64038		48531-09850	G51992		48609-33011	142836	
48520-59365	G57353		48530-09N92	G64038		48531-09880	G511007		48609-33121	142650	
48520-80020	G52201		48530-09N93	G64038		48531-0E060	G64186		48609-42012	143367	
48520-80220	G52201		48530-09N94	G64038		48531-0E110	G64186		48609-52011	143194	
48520-80246	G57353		48530-09Q40	G64006		48531-0E132	G64163		48609-52050	143194	
48520-80256	G52245		48530-09Q92	G64006		48531-0R051	G64151		48609-60100	143383	
48520-80283	G52245		48530-39885	G56729		48540-09530	G63889		48609-63002	142836	
48520-80340	G52004		48530-42040	G64026		48540-39465	G56728		48750-06010	142439	
48520-A9190	G52013		48530-49295	G56735		48540-49215	G56732		48750-0E010	143388	
48520-A9220	G56730		48530-49325	G56733		48540-49245	G56734		48750-32070	142439	
48520-A9370	G52105		48530-49415	G56735		48540-49295	G56732		48750-33010	142439	
48520-A9380	G52107		48530-49555	G56733		48540-80004	G52203		48760-06010	142439	
48520-A9530	G52201		48530-49715	G51795		48540-A9150	G56734		48760-0E010	143387	
48520-A9580	G52201		48530-59446	69450		48540-A9160	G56732		48760-32020	142439	
48520-A9590	G52201		48530-80268	G51852		48540-A9370	G52203		48760-33010	142439	
48530-02630	G51898		48530-80428	G52204		48540-A9390	G52203				

TRW

Trw	Gabriel	Upgrade	Trw	Gabriel	Upgrade	Trw	Gabriel	Upgrade	Trw	Gabriel	Upgrade
115 158	G55991		JGM4042S	G56817		JGM4132S	G55901		JGM4201SR	G56729	
JGA4002S	G56927		JGM4057SL	G56640		JGM4134S	G56701		JGM4209SL	G52142	
JGA4006S	G56935		JGM4057SR	G56641		JGM4139SL	G56615		JGM4209SR	G52143	
JGA4011SL	G56956		JGM4060S	G55579		JGM4139SR	G56616		JGM4234S	G56565	
JGA4011SR	G56957		JGM4067SL	G56785		JGM4148S	G55896		JGM4235SL	G56687	
JGA4014S	G56998		JGM4067SR	G56784		JGM4150S	G51268		JGM4235SR	G56688	
JGA4015SL	G56996		JGM4069SL	G56621		JGM4155SL	G55999		JGM4236S	G56571	
JGA4015SR	G56997		JGM4069SR	G56622		JGM4155SR	G55999		JGM4237SL	G56687	
JGA4021SL	G56948		JGM4071SL	G56730		JGM4157SL	G55661		JGM4237SR	G56688	
JGA4021SR	G56948		JGM4071SR	G56731		JGM4157SR	G55662		JGM4242S	G56899	
JGA4023SL	G56949		JGM4073SL	G56734		JGM4159SL	G55591		JGM4244S	G51714	
JGA4023SR	G56950		JGM4073SR	G56735		JGM4159SR	G55591		JGM4245SL	G56759	
JGA4030S	G57178		JGM4075SL	G56677		JGM4163SL	G52164		JGM4245SR	G56758	
JGA4031SL	G57176		JGM4075SR	G56678		JGM4163SR	G52165		JGM4246S	G52098	
JGA4031SR	G57177		JGM4081SL	G52333		JGM4165SL	G52144		JGM4253SL	G56671	
JGA4036S	G56991		JGM4081SR	G52334		JGM4165SR	G52145		JGM4253SR	G56672	
JGA4036S	G56992		JGM4083SL	G56642		JGM4167SL	G55911		JGM4255SL	G56683	
JGA4040S	G56943		JGM4083SR	G56643		JGM4167SR	G55911		JGM4255SR	G56684	
JGA4044S	G57054		JGM4089SL	G56636		JGM4171SL	G52237		JGM4257SL	G56685	
JGA4044S	G57055		JGM4089SR	G56635		JGM4171SR	G52238		JGM4257SR	G56686	
JGA4046S	G57056		JGM4090S	G55681		JGM4175SL	G52237		JGM4259SL	G52008	
JGA4047SL	G57114		JGM4091SL	G52013		JGM4175SR	G52238		JGM4259SR	G52009	
JGA4047SR	G57115		JGM4091SR	G52014		JGM4185SL	G52314		JGM4264S	G56778	
JGC4012S	G44748		JGM4092S	G55697		JGM4185SR	G52314		JGM4267SL	G52019	
JGC4092S	G44461		JGM4093SL	G52168		JGM4193SL	G56615		JGM4270S	G44986	
JGC4094S	G44461		JGM4093SR	G52169		JGM4193SR	G56616		JGM4271SL	G52107	
JGM4001SL	G55774		JGM4114S	G55772		JGM4195SL	G52199		JGM4271SR	G56797	
JGM4001SR	G55774		JGM4126S	G51267		JGM4195SR	G52200		JGM4271SR	G52108	
JGM4007SL	G56506		JGM4127SL	G56518		JGM4197SL	G52274		JGM4271SR	G56798	
JGM4007SR	G56514		JGM4127SR	G56518		JGM4197SR	G52275				
JGM4017SL	G56809		JGM4128S	G55820		JGM4199SL	G52142				
JGM4017SR	G56809		JGM4129SL	G56516		JGM4199SR	G52143				
JGM4040S	G56655		JGM4129SR	G56517		JGM4201SL	G56728				

Important Note: Competitive Interchanges are to be used for stocking purposes only. Where multiple crosses are identified, please reference the applications section of this catalog. / **Remarque importante:** Les interchanges concurrentiels ne s'utilisent qu'aux fins de stocks. Dans le cas de rferences multiples, consulter la section des applications du catalogue. / **Nota importante:** Dans le cas de rferences multiples, consulter la section des applications du catalogue. / **Nota importante:** Se pueden usar intercambios competitivos para propósitos de almacenamiento solamente. Cuando se identifican intercambios múltiples, consulte la sección de aplicaciones de este catálogo.

COMPETITIVE & O.E.M. INTERCHANGE LIST
Lista de Intercambios contra Competidores y Equipo Original.
Liste dinterchange de produits comptitifs & equipement original (OEM)

TRW... cont'd

Trw	Gabriel	Upgrade	Trw	Gabriel	Upgrade	Trw	Gabriel	Upgrade	Trw	Gabriel	Upgrade
JGM4280S	G56899		JGM4362S	G56894		JGM4449SL	G56562		JGM4551SL	G52245	
JGM4283SL	G56539		JGM4365SL	G56634		JGM4449SR	G56561		JGM4551SR	G52246	
JGM4283SR	G56540		JGM4365SR	G56633		JGM4450S	G51933		JGM4569SL	G52127	
JGM4286S	G56791		JGM4368S	G52295		JGM4452S	G51898		JGM4569SR	G52128	
JGM4287SL	G52110		JGM4369SL	G56840		JGM4453SL	G52148		JGM4571SL	G52439	
JGM4287SR	G52111		JGM4369SR	G56841		JGM4453SR	G52149		JGM4571SR	G52440	
JGM4291SL	G56728		JGM4371SL	G56538		JGM4454S	70013		JGM4585SL	G52105	
JGM4291SR	G56729		JGM4371SR	G56537		JGM4455SL	G52117		JGM4585SR	G52106	
JGM4292S	G56620		JGM4376SR	G52298		JGM4455SR	G52118		JGM4589SL	G56679	
JGM4293SL	G56728		JGM4378S	G55856		JGM4456S	69898		JGM4589SR	G56680	
JGM4293SR	G56729		JGM4379SL	G52297		JGM4457SL	G51910		JGM4593SL	G52329	
JGM4296S	G55698		JGM4383SL	G56800		JGM4457SR	G52272		JGM4593SR	G52330	
JGM4297SL	G56601		JGM4383SR	G56799		JGM4461SL	G52253		JGM4595SL	G52152	
JGM4297SR	G56568		JGM4389SL	G56582		JGM4461SR	G52254		JGM4595SR	G52153	
JGM4300S	G52025		JGM4389SR	G56581		JGM4462S	G56792		JGM4597SL	G52032	
JGM4303SL	G52017		JGM4395SL	G52299		JGM4464S	G56802		JGM4597SR	G52033	
JGM4303SR	G52018		JGM4395SR	G52300		JGM4466S	G56802		JGM4601SL	G52209	
JGM4304S	G56899		JGM4404S	G52273		JGM4469SL	G52182		JGM4601SR	G52210	
JGM4305SL	G56892		JGM4405SL	G52156		JGM4469SR	G52183		JGM4603SL	G52260	
JGM4305SR	G56893		JGM4405SR	G52157		JGM4479SR	G56886		JGM4603SR	G52261	
JGM4306S	G56899		JGM4406S	G51911		JGM4491SL	G52129		JGM4607SL	G52282	
JGM4308S	G52276		JGM4407SL	G52173		JGM4491SR	G52130		JGM4607SR	G52283	
JGM4313SL	G56679		JGM4407SR	G52174		JGM4497SL	G52103		JGM4609SL	G52293	
JGM4313SR	G56680		JGM4412S	G52131		JGM4497SR	G52104		JGM4609SR	G52294	
JGM4316S	G51718		JGM4415SL	G52335		JGM4501SL	G52127		JGM4611SL	G51925	
JGM4318S	G56899		JGM4415SR	G52336		JGM4501SR	G52128		JGM4611SR	G51926	
JGM4321SL	G56732		JGM4416S	G55949		JGM4503SL	G56836		JGM4613SL	G52150	
JGM4321SR	G56733		JGM4420S	G56509		JGM4503SR	G56837		JGM4613SR	G52151	
JGM4325SL	G52081		JGM4422S	G51898		JGM4507SL	G52203		JGM4617SL	G52026	
JGM4325SR	G52082		JGM4423SL	G56842		JGM4507SR	G52204		JGM4617SR	G52027	
JGM4329SL	G56661		JGM4423SR	G56843		JGM4509SL	G52201		JGM4625SL	G51853	
JGM4329SR	G56660		JGM4424S	G51864		JGM4509SR	G52202		JGM4625SR	G51854	
JGM4332S	G56899		JGM4425SL	G56886		JGM4513SL	G52187		JGM4629SL	G56721	
JGM4335SL	G52175		JGM4425SR	G56887		JGM4513SR	G52188		JGM4629SR	G56722	
JGM4335SR	G52176		JGM4426S	G51980		JGM4515SL	G51877		JGM4637SL	G56750	
JGM4339SL	G52094		JGM4427SL	G52004		JGM4515SR	G51878		JGM4637SR	G56751	
JGM4339SR	G52095		JGM4427SR	G52007		JGM4517SL	G52247		JGM4657SL	G52005	
JGM4341SL	G52121		JGM4431SL	G52439		JGM4517SR	G52248		JGM4657SR	G52006	
JGM4341SR	G52122		JGM4431SR	G52440		JGM4519SL	G52103		JGM4661SL	G52274	
JGM4343SL	G52142		JGM4432S	70013		JGM4519SR	G52104		JGM4661SR	G52275	
JGM4343SR	G52143		JGM4433SL	G56819		JGM4521SL	G52156		JGM4671SL	G55993	
JGM4345SL	G56506		JGM4433SR	G56820		JGM4521SR	G52157		JGM4671SR	G55994	
JGM4345SR	G56514		JGM4434S	G51806		JGM4523SL	G52249		JGM4672S	G56606	
JGM4347SL	G55675		JGM4435SL	G56822		JGM4523SR	G52250		JGM4673SL	G52112	
JGM4347SR	G55676		JGM4435SR	G56821		JGM4525SL	G52140		JGM4673SR	G52113	
JGM4351SL	G56888		JGM4437SL	G56810		JGM4525SR	G52141		JGM4685SL	G52187	
JGM4351SR	G56889		JGM4437SR	G56810		JGM4527SL	G56888		JGM4685SR	G52188	
JGM4355SL	G52184		JGM4439SL	G52162		JGM4527SR	G56889		JGM4687SL	G56800	
JGM4355SR	G52185		JGM4439SR	G52163		JGM4533SL	G52331		JGM4687SR	G56799	
JGM4357SL	G52154		JGM4442S	G51765		JGM4533SR	G52332		JGM4751SR	G52202	
JGM4357SR	G52155		JGM4444S	70013		JGM4535SL	G52096		JGM4821SL	G52255	
JGM4359SL	G52257		JGM4445SL	G52382		JGM4535SR	G52097		JGM4821SR	G52256	
JGM4359SR	G52258		JGM4445SR	G52383		JGM4537SL	G52158		JGM4861SL	G52245	
JGM4360S	G56899		JGM4447SL	G56773		JGM4537SR	G52159		JGM4861SR	G52246	
JGM4361SL	G52160		JGM4447SR	G56774		JGM4539SL	G52264		JGM9086SL	G52008	
JGM4361SR	G52161		JGM4448S	G51833		JGM4539SR	G52265		JGM9086SR	G52009	

Important Note: Competitive Interchanges are to be used for stocking purposes only. Where multiple crosses are identified, please reference the applications section of this catalog. / **Remarque importante:** Les interchanges concurrentiels ne s'utilisent qu'aux fins de stocks. Dans le cas de rferences multiples, consulter la section des applications du catalogue. / **Nota importante:** Dans le cas de rferences multiples, consultar la section des applications du catalogue. / **Nota importante:** Se pueden usar intercambios competitivos para propósitos de almacenamiento solamente. Cuando se identifican intercambios múltiples, consulte la sección de aplicaciones de este catálogo.

COMPETITIVE & O.E.M. INTERCHANGE LIST
Lista de Intercambios contra Competidores y Equipo Original.
Liste dinterchange de produits comptitifs & dquipement original (OEM)

TRW... cont'd

Trw	Gabriel	Upgrade	Trw	Gabriel	Upgrade	Trw	Gabriel	Upgrade	Trw	Gabriel	Upgrade
JGM9134SL	G56732		JGS4406S	G51865		JGT4096S	G63950		JGT4322S	G51802	
JGM9134SR	G56733		JGT4000S	G51888		JGT4098S	69625		JGT4324S	70028	
JGM9300SL	G56601		JGT4002S	G51887		JGT4106S	81270		JGT4328S	G51838	
JGM9300SR	G56568		JGT4003SL	G51761		JGT4116S	G63867		JGT4332S	G63845	
JGM9889SL	G56888		JGT4003SR	G51760		JGT4116S	G64157		JGT4334S	G51849	
JGM9889SR	G56889		JGT4005SL	G51813		JGT4118S	G63870		JGT4344S	69901	
JGM9901SL	G56842		JGT4005SR	G51814		JGT4120S	69574		JGT4362S	G51097	
JGM9901SR	G56843		JGT4006S	G63357		JGT4122S	69575		JGT4366S	69903	
JGP4006S	G63783		JGT4007SL	G511054		JGT4124S	G63878		JGT4368S	69903	
JGP4014S	G51891		JGT4007SR	G511055		JGT4128S	G51724		JGT4372S	G63799	
JGP4018S	G51891		JGT4008S	G63375		JGT4138S	82156		JGT4374S	69465	
JGP4020S	G63866		JGT4008S	G63894		JGT4142S	69845		JGT4376S	69450	
JGP4024S	G63866		JGT4009SL	G51810		JGT4144S	69898		JGT4380S	G64028	
JGP4458S	G63803		JGT4009SL	G51859		JGT4146S	G51254		JGT4382S	G63832	
JGS236S	G51737		JGT4009SL	G51896		JGT4152S	G63443		JGT4384S	G63828	
JGS4000S	G51759		JGT4009SR	G51811		JGT4156S	G63671		JGT4386S	G63860	
JGS4003S	G51934		JGT4009SR	G51859		JGT4156S	G63678		JGT4388S	G64027	
JGS4012S	G51704		JGT4009SR	G51897		JGT4158S	G63411		JGT4394S	69946	
JGS4014S	G51703		JGT4010S	G63386		JGT4162S	G63524		JGT4396S	69946	
JGS4020S	G55825		JGT4012S	G63406		JGT4168S	G63623		JGT4400S	G63413	
JGS4058S	G51736		JGT4014S	G63421		JGT4170S	G63638		JGT4402S	G63905	
JGS4084S	G51742		JGT4015SL	G52348		JGT4170S	G63896		JGT4404S	G63661	
JGS4098S	G51063		JGT4015SR	G52349		JGT4172S	G63717		JGT4406S	G63359	
JGS4100S	G51841		JGT4016S	G63422		JGT4174S	G63722		JGT4408S	G63424	
JGS4126S	G51722		JGT4018S	G63423		JGT4188S	69473		JGT4410S	G63683	
JGS4148S	G51881		JGT4020S	G63424		JGT4192S	82090		JGT4412S	G63425	
JGS4152S	G56591		JGT4020S	G63721		JGT4194S	G63837		JGT4414S	G63866	
JGS4154S	G51087		JGT4022S	G63454		JGT4214S	G63848		JGT4416S	G63426	
JGS4156S	G63678		JGT4024S	G63461		JGT4216S	G63882		JGT4416S	G63690	
JGS4156S	G63775		JGT4026S	G63607		JGT4220S	G63773		JGT4418S	G63614	
JGS4158S	G51900		JGT4027SL	G511019		JGT4222S	G63775		JGT4418S	G63622	
JGS4168S	G51841		JGT4027SR	G511020		JGT4224S	69962		JGT4418S	G63929	
JGS4174S	70040		JGT4028S	G63608		JGT4228S	G63810		JGT4420S	G63714	
JGS4176S	70040		JGT4028S	G63614		JGT4234S	69590		JGT4422S	G63716	
JGS4186S	G51252		JGT4030S	G63614		JGT4238S	G63962		JGT4424S	G63679	
JGS4192S	G51723		JGT4031SL	G51961		JGT4240S	G63810		JGT4426S	G63414	
JGS4194S	G56807		JGT4031SR	G52374		JGT4242S	G63808		JGT4428S	G63778	
JGS4196S	G51715		JGT4032S	G63609		JGT4244S	G64087		JGT4430S	G63614	
JGS4198S	G51256		JGT4032S	G63818		JGT4252S	G63494		JGT4430S	G63622	
JGS4206S	G64006		JGT4034S	G63907		JGT4254S	G63404		JGT4432S	G63809	
JGS4208S	G64009		JGT4038S	69600		JGT4266S	G63548		JGT4434S	69606	
JGS4208S	G64011		JGT4042S	69675		JGT4272S	G63616		JGT4436S	G63715	
JGS4210S	G51841		JGT4044S	69676		JGT4274S	G63903		JGT4438S	81916	
JGS4214S	70036		JGT4058S	G63350		JGT4282S	G63782		JGT4440S	G63525	
JGS42222S	G51850		JGT4060S	G63353		JGT4284S	G63707		JGT4442S	G63676	
JGS4226S	G51870		JGT4062S	G63360		JGT4286S	G63708		JGT4442S	G63873	
JGS4230S	G51848		JGT4066S	G63377		JGT4288S	G63726		JGT4442S	G64042	
JGS4232S	G51863		JGT4068S	G63387		JGT4294S	G63813		JGT4444S	G63776	
JGS4234S	G51815		JGT4074S	G63409		JGT4296S	G51279		JGT4444S	G63869	
JGS4236S	G51799		JGT4078S	G63418		JGT4298S	G51713		JGT4446S	G63489	
JGS4244S	G51097		JGT4080S	G63524		JGT4300S	G63864		JGT4448S	G63488	
JGS4252S	G51740		JGT4082S	G63455		JGT4302S	G51716		JGT4450S	G63783	
JGS4314S	G51286		JGT4088S	G63490		JGT4306S	G63815		JGT4452S	G63355	
JGS4316S	G51766		JGT4090S	G63492		JGT4308S	G63815		JGT4452S	G63366	
JGS4346S	G51279		JGT4090S	G63928		JGT4310S	G64105		JGT4454S	G63349	
JGS4362S	G51815		JGT4094S	G63915		JGT4318S	70001		JGT4456S	G63662	

Important Note: Competitive Interchanges are to be used for stocking purposes only. Where multiple crosses are identified, please reference the applications section of this catalog. / **Remarque importante:** Les interchanges concurrentiels ne s'utilisent qu'aux fins de stocks. Dans le cas de rferences multiples, consulter la section des applications du catalogue. / **Nota importante:** Dans le cas de rferences multiples, consulter la section des applications du catalogue. / **Nota importante:** Se pueden usar intercambios competitivos para propósitos de almacenamiento solamente. Cuando se identifican intercambios múltiples, consulte la sección de aplicaciones de este catálogo.

COMPETITIVE & O.E.M. INTERCHANGE LIST
Lista de Intercambios contra Competidores y Equipo Original.
Liste dinterchange de produits comptitifs & dquipement original (OEM)

TRW... cont'd

Trw	Gabriel	Upgrade	Trw	Gabriel	Upgrade	Trw	Gabriel	Upgrade	Trw	Gabriel	Upgrade
JGT4456S	G63675		JGT4610S	G51842		JGT4772S	G64026		JGT4942S	69595	
JGT4456S	G63959		JGT4618S	G51254		JGT4776S	70102		JGT4944S	69594	
JGT4458S	G63893		JGT4622S	G63610		JGT4782S	G63872		JGT4950S	G51990	
JGT4460S	G63813		JGT4624S	G63173		JGT4782S	G64015		JGT4964S	69945	
JGT4462S	G63299		JGT4630S	G51255		JGT4782S	G64140		JGT4966S	69945	
JGT4464S	69945		JGT4632S	70027		JGT4784S	70052		JGT4972S	69946	
JGT4466S	69813		JGT4634S	70089		JGT4788S	G51908		JGT4980S	69863	
JGT4468S	70034		JGT4636S	G51993		JGT4790S	G51807		JGT4982S	81559	
JGT4470S	G51772		JGT4640S	69592		JGT4792S	70089		JGT4984S	G63929	
JGT4472S	G63712		JGT4640S	69593		JGT4796S	69907		JGT4986S	81446	
JGT4474S	G51799		JGT4642S	G64012		JGT4798S	G63967		JGT4988S	81750	
JGT4478S	G51799		JGT4656S	70003		JGT4814S	G51855		JGT4990S	81494	
JGT4480S	69604		JGT4658S	G63884		JGT4816S	G64038		JGT4994S	G63675	
JGT4480S	69724		JGT4660S	G63879		JGT4818S	G51858		JGT4998S	G63829	
JGT4482S	G63958		JGT4662S	G63875		JGT4820S	70010		JGT5000S	81937	
JGT4482S	G64043		JGT4664S	69587		JGT4824S	G51919		JGT5006S	69675	
JGT4484S	G63961		JGT4666S	G64071		JGT4826S	G51860		JGT5008S	81892	
JGT4484S	G64044		JGT4668S	70078		JGT4828S	G51861		JGT5014S	G63479	
JGT4486S	G51728		JGT4670S	69946		JGT4834S	G64104		JGT5014S	G63547	
JGT4488S	G63844		JGT4672S	G63889		JGT4840S	G51983		JGT5016S	81871	
JGT4490S	G63817		JGT4672S	G64006		JGT4842S	G51983		JGT5018S	G63638	
JGT4492S	G64046		JGT4674S	70056		JGT4846S	G64042		JGT5020S	81928	
JGT4494S	G63720		JGT4680S	G51286		JGT4850S	G511044		JGT5022S	81878	
JGT4496S	G51799		JGT4682S	G64033		JGT4852S	G51874		JGT5024S	G63405	
JGT4500S	G64049		JGT4684S	G55870		JGT4854S	G51892		JGT5026S	81516	
JGT4502S	70045		JGT4688S	69591		JGT4856S	G64008		JGT5028S	G63609	
JGT4504S	70045		JGT4690S	G51794		JGT4858S	G64040		JGT5030S	G63425	
JGT4508S	70039		JGT4692S	G51737		JGT4860S	G52125		JGT5034S	81082	
JGT4514S	69909		JGT4694S	G511004		JGT4864S	G52116		JGT5036S	G63683	
JGT4516S	69585		JGT4696S	70041		JGT4866S	G64080		JGT5038S	81914	
JGT4518S	G63717		JGT4698S	G63883		JGT4868S	G64003		JGT5040S	81713	
JGT4520S	G63714		JGT4700S	70098		JGT4870S	G51884		JGT5044S	81924	
JGT4530S	G63842		JGT4704S	G64050		JGT4872S	70053		JGT5046S	81890	
JGT4532S	G51738		JGT4708S	69714		JGT4874S	G64048		JGT5048S	81918	
JGT4534S	70000		JGT4710S	69795		JGT4876S	G51852		JGT5050S	81482	
JGT4538S	G51883		JGT4712S	69811		JGT4880S	G63888		JGT5056S	81917	
JGT4538S	G51969		JGT4720S	69622		JGT4882S	G64111		JGT5058S	81893	
JGT4542S	G51727		JGT4722S	69755		JGT4886S	G52375		JGT5060S	81668	
JGT4544S	G51798		JGT4724S	G63673		JGT4888S	G51832		JGT5064S	81667	
JGT4546S	G51767		JGT4726S	G63710		JGT4890S	G51880		JGT5068S	81836	
JGT4548S	G51739		JGT4728S	G63937		JGT4894S	G511092		JGT5076S	81113	
JGT4550S	G63885		JGT4730S	G63620		JGT4896S	G511092		JGT5078S	81873	
JGT4550S	G64029		JGT4736S	G63904		JGT4898S	G51865		JGT5084S	81318	
JGT4550S	G64030		JGT4736S	G63909		JGT4900S	G64079		JGT5086S	G63403	
JGT4552S	G51804		JGT4738S	G63495		JGT4906S	70068		JGT5088S	81490	
JGT4556S	81318		JGT4738S	G63611		JGT4914S	G51805		JGT5090S	81920	
JGT4560S	G51721		JGT4740S	69715		JGT4918S	70013		JGT5092S	G63847	
JGT4576S	69900		JGT4744S	69587		JGT4920S	G63886		JGT5094S	81912	
JGT4578S	G51799		JGT4746S	69589		JGT4920S	G63969		JGT5096S	G63772	
JGT4580S	G51799		JGT4748S	G63890		JGT4922S	G51905		JGT5098S	G63424	
JGT4590S	G63847		JGT4748S	G63891		JGT4926S	G64121		JGT5100S	G63803	
JGT4592S	G63829		JGT4754S	G51928		JGT4928S	G51803		JGT5102S	81514	
JGT4594S	69586		JGT4756S	G64032		JGT4930S	G51812		JGT5406S	G63624	
JGT4596S	69586		JGT4762S	69464		JGT4932S	G64056		JGT5412S	70068	
JGT4606S	G51795		JGT4766S	70013		JGT4936S	70060		JGT5416S	G51972	
JGT4608S	G51812		JGT4770S	G51783		JGT4938S	70096		JGT5418S	G64031	

Important Note: Competitive Interchanges are to be used for stocking purposes only. Where multiple crosses are identified, please reference the applications section of this catalog. / **Remarque importante:** Les interchanges concurrentiels ne s'utilisent qu'aux fins de stocks. Dans le cas de rfrences multiples, consulter la section des applications du catalogue. / **Nota importante:** Dans le cas de rfrences multiples, consulter la section des applications du catalogue. / **Nota importante:** Se pueden usar intercambios competitivos para propósitos de almacenamiento solamente. Cuando se identifican intercambios múltiples, consulte la sección de aplicaciones de este catálogo.

COMPETITIVE & O.E.M. INTERCHANGE LIST
Lista de Intercambios contra Competidores y Equipo Original.
Liste dinterchange de produits comptitifs & dquipement original (OEM)

TRW... cont'd

Trw	Gabriel	Upgrade	Trw	Gabriel	Upgrade	Trw	Gabriel	Upgrade	Trw	Gabriel	Upgrade
JGT5430S	70010		JOT5320S	G63892		JSB4316S	143419		JSL4007SL	142650	
JGT5432S	G64003		JOT5324S	77425		JSB4326S	143455		JSL4007SR	142649	
JGT5440S	69625		JOT5328S	77829		JSB4344S	143385		JSL4023SL	143354	
JGT5442S	G63915		JOT5336S	70024		JSB4346S	143324		JSL4023SR	143355	
JGT5444S	G63872		JOT5390S	70033		JSB4348S	143364		JSL4136S	142651	
JGT5460S	70052		JSB4003SL	142403		JSB4350S	143369		JSL4144S	142930	
JGT5562S	G64056		JSB4003SR	142404		JSB4350S	143468		JSL4214S	143353	
JGT5572S	G64012		JSB4008S	142135		JSB4368S	143408		JSL4216S	142937	
JGT5574S	82155		JSB4009SL	143465		JSB4390S	143473		JSL4220S	143202	
JGT5578S	G63461		JSB4009SR	143466		JSB4394S	143422		JSL4232S	142252	
JGT5612S	G63722		JSB4021SL	143387		JSB4424S	143318		JSL4248S	143239	
JGT5628S	G51805		JSB4021SR	143388		JSB4464S	143342		JSL4270S	143218	
JGT5632S	G64104		JSB4024S	142091		JSB4476S	143406		JSL4300S	143323	
JGT5924S	G64026		JSB4027SL	143390		JSB4478S	143343		JSL4322S	143398	
JGT5982S	G63867		JSB4027SR	143391		JSB4502S	143366		JSL4336S	143089	
JGT5984S	G63867		JSB4030S	142444		JSB4502S	143486		JSL4418S	143365	
JGT5994S	G63403		JSB4031SL	143461		JSB4566S	142852		JSL4422S	143495	
JGT6032S	G63902		JSB4031SR	143462		JSB4602S	142245		JSL4428S	142930	
JGT6038S	G63662		JSB4036S	142651		JSB4620S	142840		JSL4438S	143363	
JGT6052S	82156		JSB4056S	143191		JSB4624S	142317		JSL4442S	143460	
JGT6056S	G63907		JSB4082S	142247		JSB4650S	143209		JSL4516S	143409	
JGT6060S	G63492		JSB4086S	142250		JSB4654S	142949		JSL4516S	143410	
JGT9038S	G51804		JSB4088S	142439		JSB4658S	142546		JSL4524S	143397	
JGT9042S	G51798		JSB4094S	143281		JSB4720S	142828		JSL4526S	143477	
JGT9161S	G63862		JSB4110S	143259		JSB4726S	143197		JSL4574S	142842	
JGT9246S	G63845		JSB4116S	143082		JSB4728S	143325		JSL4600S	142244	
JHM4486S	G56606		JSB4118S	142653		JSB4734S	142561		JSL4630S	142329	
JHS4254S	49228		JSB4126S	143404		JSB4736S	142836		JSL4652S	142843	
JHS4254S	49255		JSB4146S	142625		JSB4772S	143244		JSL4662S	143458	
JHT5112S	69787		JSB4148S	143204		JSB4782S	142932		JSL4672S	142419	
JHT5168S	G63918		JSB4158S	143367		JSB4784S	143256		JSL4750S	142530	
JHT5778S	G63409		JSB4162S	143492		JSB4790S	143087		JSL4754S	143459	
JOS4292S	G51773		JSB4166S	143201		JSB4810S	143244		JSL4768S	142938	
JOT 5368S	70040		JSB4206S	143087		JSB4824S	142643		JSL4786S	143315	
JOT5244S	G51871		JSB4236S	143191		JSB4876S	143349		JSL4794S	143464	
JOT5246S	G51904		JSB4238S	142735		JSB4934S	143393		JSL4798S	143423	
JOT5250S	69587		JSB4266S	142419		JSB4940S	G51715		JSL4818S	143241	
JOT5254S	77674		JSB4276S	143418		JSK4002T	143057		JSL4878S	143305	
JOT5256S	69996		JSB4288S	143491		JSK4004T	143058		JSL4880S	143383	
JOT5276S	69952		JSB4290S	142195		JSK4092T	143059		JSL4914S	143088	
JOT5306S	G63781		JSB4292S	143365		JSK4096T	143061		JSL4922S	143339	
JOT5310S	G63845		JSB4298S	143317		JSK4100T	143063				
JOT5318S	G64016		JSB4314S	143416		JSK4210T	143064				

Unity

Unity	Gabriel	Upgrade	Unity	Gabriel	Upgrade	Unity	Gabriel	Upgrade	Unity	Gabriel	Upgrade
11010	G56934		11060	G57277		11094	G57146		11130	G57060	
11010	G56937		11061	G57063		11096	G57146		11131	G57088	
11011	G57110		11062	G57064		11100	G57039		11132	G57089	
11012	G57111		11071	G56956		11101	G57404		11133	G57393	
11013	G57495		11072	G56957		11102	G57405		11134	G57394	
11014	G57496		11074	G56965		11110	G56927		11135	G57275	
11020	G57060		11081	G57010		11111	G57022		11136	G57276	
11021	G57359		11082	G57010		11111	G57398		11141	G57268	
11022	G57360		11083	G57081		11112	G57399				
11024	G57141		11084	G57082		11114	G57059				
11030	G56935		11091	G56991		11127	G57608				
11060	G57156		11092	G56992		11128	G57609				

Important Note: Competitive Interchanges are to be used for stocking purposes only. Where multiple crosses are identified, please reference the applications section of this catalog. / **Remarque importante:** Les interchanges concurrentiels ne s'utilisent qu'aux fins de stocks. Dans le cas de rferences multiples, consulter la section des applications du catalogue. / **Nota importante:** Dans le cas de rferences multiples, consulter la section des applications du catalogue. / **Nota importante:** Se pueden usar intercambios competitivos para propósitos de almacenamiento solamente. Cuando se identifican intercambios múltiples, consulte la sección de aplicaciones de este catálogo.

COMPETITIVE & O.E.M. INTERCHANGE LIST
Lista de Intercambios contra Competidores y Equipo Original.
Liste dinterchange de produits comptitifs & dquipement original (OEM)

Unity... cont'd

Unity	Gabriel	Upgrade	Unity	Gabriel	Upgrade	Unity	Gabriel	Upgrade	Unity	Gabriel	Upgrade
11142	G57269		11333	G57030		11564	G57134		11683	G57361	
11150	G56951		11334	G57031		11570	G57282		11684	G57362	
11151	G56948		11335	G57493		11571	G57034		11700	G57324	
11152	G56948		11336	G57494		11572	G57035		11701	G57041	
11160	G57017		11343	G57144		11573	G57329		11702	G57042	
11170	G57557		11344	G57145		11574	G57330		11711	G57076	
11171	G56962		11345	G57144		11580	G57000		11712	G57077	
11172	G56963		11346	G57145		11580	G57023		11713	G57560	
11173	G57112		11350	G56975		11581	G57176		11714	G57561	
11174	G57113		11351	G57037		11582	G57177		11723	G57487	
11180	G57022		11352	G57038		11590	G57125		11733	G57473	
11181	G56930		11353	G57202		11591	G57030		11734	G57474	
11182	G56931		11354	G57203		11592	G57031		11741	G57190	
11190	G57142		11356	G57266		11593	G57030		11742	G57191	
11200	G57019		11357	G57267		11594	G57031		11743	G57218	
11201	G57007		11360	G57051		11595	G57367		11744	G57219	
11202	G57008		11373	G57363		11596	G57368		11745	G57758	
11204	G57020		11374	G57364		11597	G57161		11746	G57759	
11206	G57021		11380	G57015		11598	G57162		11751	G57114	
11210	G57060		11381	G57027		11601	G57047		11752	G57115	
11211	G57083		11382	G57027		11602	G57048		11753	G57558	
11212	G57083		11383	G57454		11605	G57479		11754	G57559	
11220	G57013		11384	G57455		11606	G57480		11761	G57163	
11231	G56996		11403	G57130		11607	G57574		11762	G57164	
11232	G56997		11404	G57131		11608	G57575		11790	G57397	
11235	G57207		11410	G57006		11610	G57053		11800	G57080	
11237	G57417		11411	G57541		11611	G57161		11801	G57369	
11238	G57418		11412	G57542		11612	G57162		11802	G57370	
11253	G57204		11420	G56929		11613	G57161		11805	G57353	
11254	G57205		11423	G57126		11614	G57162		11806	G57354	
11255	G57204		11424	G57127		11615	G57150		11813	G57391	
11256	G57205		11450	G56929		11616	G57151		11814	G57390	
11257	G57105		11453	G57200		11617	G57481		11815	G57390	
11258	G57106		11454	G57201		11618	G57482		11816	G57391	
11260	G57071		11463	G57197		11620	G57147		11821	G57459	
11270	G57099		11464	G57198		11621	G57045		11822	G57460	
11270	G57100		11472	G56931		11622	G57046		11851	G57366	
11271	G57135		11473	G57648		11631	G57049		11852	G57365	
11272	G57136		11474	G57649		11632	G57050		11853	G57341	
11280	G57072		11475	G57184		11643	G57119		11854	G57342	
11281	G56930		11476	G57185		11644	G57120		11871	G57054	
11282	G56931		11493	G57337		11653	G57457		11872	G57055	
11283	G57139		11494	G57338		11654	G57458		11873	G57197	
11284	G57140		11505	G57333		11661	G57011		11874	G57198	
11285	G57471		11506	G57334		11662	G57012		11881	G57377	
11286	G57472		11541	G56993		11663	G57222		11882	G57378	
11290	G57118		11542	G56994		11664	G57223		11890	G57095	
11290	G57413		11543	G57449		11667	G57084		11891	G57105	
11296	G57646		11544	G57450		11668	G57085		11892	G57106	
11300	G57092		11545	G57497		11671	G57069		11893	G57515	
11304	G57132		11546	G57498		11671	G57121		11894	G57516	
11306	G57103		11550	G57040		11672	G57070		11900	G57172	
11311	G57603		11560	G57149		11672	G57122		11901	G57137	
11312	G57604		11561	G57065		11675	G57465		11902	G57138	
11320	G57274		11562	G57066		11676	G57466		11903	G57564	
11330	G57421		11563	G57133		11680	G57109		11904	G57565	

Important Note: Competitive Interchanges are to be used for stocking purposes only. Where multiple crosses are identified, please reference the applications section of this catalog./ **Remarque importante:** Les interchanges concurrentiels ne s'utilisent qu'aux fins de stocks. Dans le cas de rfrences multiples, consulter la section des applications du catalogue./ **Nota importante:** Dans le cas de rfrences multiples, consulter la section des applications du catalogue./ **Nota importante:** Se pueden usar intercambios competitivos para propósitos de almacenamiento solamente. Cuando se identifican intercambios múltiples, consulte la sección de aplicaciones de este catálogo.

COMPETITIVE & O.E.M. INTERCHANGE LIST
Lista de Intercambios contra Competidores y Equipo Original.
Liste d'interchange de produits compétitifs & d'équipement original (OEM)

Unity... cont'd

Unity	Gabriel	Upgrade	Unity	Gabriel	Upgrade	Unity	Gabriel	Upgrade	Unity	Gabriel	Upgrade
11905	G57339		15040	G56936		15344	G57425		210901	G56800	
11906	G57340		15041	G57449		15350	G57036		210902	G56799	
11913	G57673		15042	G57450		15351	G57078		211000	G55948	
11914	G57674		15043	G57449		15352	G57079		211001	G55999	
11921	G57123		15044	G57450		15360	G57437		211002	G55999	
11922	G57124		15050	G57056		15361	G57192		211010	G51746	
11923	G57345		15051	G56949		15362	G57193		211050	G56718	
11924	G57346		15052	G56950		15371	G57067		211060	G55698	
11925	G57477		15060	G57018		15372	G57068		211080	G56700	
11926	G57478		15061	G56924		15373	G57568		211100	G56509	
11927	G57628		15062	G56925		15374	G57569		211110	77803	
11928	G57629		15063	G57451		15380	G57075		211200	G52125	
11931	G57027		15064	G57452		15381	G57032		211201	G56886	
11932	G57027		15071	G57090		15381	G57061		211202	G56887	
11943	G57157		15072	G57091		15382	G57033		211300	G56810	
11944	G57158		15073	G57499		15382	G57062		211400	G52116	
11950	G57271		15074	G57500		15400	G57096		211401	G56773	
11953	G57489		15080	G57016		15410	G57173		211402	G56774	
11954	G57490		15081	G57400		15411	G57658		211500	G51718	
11961	G57097		15082	G57401		15412	G57659		211700	G51850	
11962	G57098		15085	G57416		15413	G57658		211800	G52025	
11970	G57206		15086	G57416		15414	G57659		212001	G56516	
11973	G57517		15111	G57278		15430	G57159		212002	G56517	
11974	G57518		15112	G57279		15430	G57160		212020	G55579	
11980	G57148		15123	G57415		15511	G57344		212030	G55551	
11981	G57375		15124	G57414		15512	G57343		212100	G51722	
11982	G57376		15130	G56928		15580	G57178		212101	G56836	
11985	G57594		15145	G57086		15801	G57428		212102	G56837	
11986	G57595		15146	G57087		15802	G57429		212110	G51887	
11990	G57270		15161	G56932		15850	G57430		212200	G51810	
11990	G57427		15162	G56933		15903	G57533		212200	G51811	
11991	G57373		15170	G56964		15904	G57534		212200	G51859	
11992	G57372		15171	G57509		15905	G57650		212300	G63716	
11993	G57107		15171	G57510		15906	G57651		212400	G51723	
11994	G57108		15180	G57419		15907	G57650		212600	G55681	
12-143000	69675		15190	G57420		15908	G57651		212800	G51703	
12-198000	G64001		15211	G56973		15910	G57423		212810	G51704	
12-199000	G63817		15212	G56974		15911	G57167		212900	G56817	
12-514800-HD	G63842		15220	G56998		15912	G57168		212901	G52026	
12-525000	G64046		15230	G57014		18-125001	G52145		212902	G52027	
12-540000	69606		15270	G57057		18-125002	G52144		213000	G51758	
12-541000	69575		15270	G57058		210010	G51737		213010	G55697	
12-543000	69606		15280	G56943		210020	G55774		213020	G55896	
12-560000	G63717		15301	G57128		210100	G55909		213050	G64040	
12-598000	77983		15302	G57129		210101	G52112		213100	G56807	
13-110900	77803		15310	G57447		210102	G52113		213200	G55892	
13423	G57853		15311	G56924		210160	G64008		213400	G52131	
13424	G57852		15312	G56925		210201	G56621		213500	G56620	
14-510900	49231		15320	G57444		210202	G56622		213501	G52081	
15021	G56924		15321	G56932		210301	G56759		213502	G52082	
15022	G56925		15322	G56933		210302	G56758		213700	G51728	
15025	G57499		15330	G56995		210400	G51255		213800	G51815	
15026	G57500		15340	G57026		210500	G55870		213900	G51267	
15030	G56938		15341	G57043		210800	G51737		214010	G51739	
15031	G56932		15342	G57044		210801	G56677		214011	G56730	
15032	G56933		15343	G57424		210802	G56678		214012	G56731	

Important Note: Competitive Interchanges are to be used for stocking purposes only. Where multiple crosses are identified, please reference the applications section of this catalog. / **Remarque importante:** Les interchanges concurrentiels ne s'utilisent qu'aux fins de stocks. Dans le cas de références multiples, consulter la section des applications du catalogue. / **Nota importante:** Dans le cas de références multiples, consulter la section des applications du catalogue. / **Nota importante:** Se pueden usar intercambios competitivos para propósitos de almacenamiento solamente. Cuando se identifican intercambios múltiples, consulte la sección de aplicaciones de este catálogo.

COMPETITIVE & O.E.M. INTERCHANGE LIST
Lista de Intercambios contra Competidores y Equipo Original.
Liste dinterchange de produits comptitifs & dquipement original (OEM)

Unity... cont'd

Unity	Gabriel	Upgrade	Unity	Gabriel	Upgrade	Unity	Gabriel	Upgrade	Unity	Gabriel	Upgrade
214020	G51855		219301	G56634		252500	G63299		255900	G51802	
214021	G56888		219302	G56633		252600	G64079		256100	G51863	
214022	G56889		219401	G56562		252700	G63676		256200	61716	
214051	G55591		219402	G56561		253000	G51861		256300	G64044	
214052	G55591		219500	G56802		253010	69473		256400	G63891	
214100	G51477		219801	G56601		253020	G63844		257010	69945	
214101	G55993		219802	G56568		253030	G63690		257020	G51799	
214102	G55994		219910	G51806		253040	G51807		259000	G51881	
214200	G51077		231400	G52131		253050	G64042		259020	70003	
214300	G51077		250000	G51858		253100	G51842		259100	G51767	
214301	G56506		250020	69909		253200	G51268		259110	G64080	
214302	G56514		250030	G64003		253500	G55856		259120	G64012	
214400	G51477		250310	70010		253600	G51721		259130	G63966	
214701	G56661		250500	G51256		253610	69676		259130	G63967	
214702	G56660		250600	G51738		253620	G51884		259140	G51980	
214801	G52013		25100	G51715		254001	G55675		259150	70036	
214802	G52014		251010	69589		254002	G55676		259201	G56640	
214901	G56721		251020	G63842		254010	G63726		259202	G56641	
214902	G56722		251020	G64014		254020	G64038		259300	G51759	
215001	G56683		251030	69587		254030	G63885		259320	69901	
215002	G56684		251040	69590		254030	G64029		259340	69901	
215011	G52008		251050	G51700		254030	G64030		259340	70040	
215012	G52009		251060	G55949		254040	G51804		259350	70028	
215021	G52121		251090	G55825		254051	61699		259400	G51794	
215022	G52122		251100	G55949		254052	61700		259401	G52335	
215101	G56671		251120	G63842		254060	G64026		259402	G52336	
215102	G56672		251130	G63776		254070	G63889		259420	G64056	
215200	G51765		251130	G63869		254070	G64006		259500	G51286	
215201	G56685		251140	G63872		254080	G63610		259700	G51713	
215202	G56686		251140	G64015		254090	G64087		259710	70045	
215300	G51766		251160	70031		254300	G51736		259800	69907	
215401	G56615		251201	G55661		254301	G56728		259810	70013	
215402	G56616		251202	G55662		254302	G56729		259820	69813	
215901	G52094		251400	G63866		254700	G63815		259830	70000	
215902	G52095		251500	G63959		254800	G63815		259850	G64032	
217000	G55991		251600	G63868		255030	70089		259870	G64000	
217100	G51097		252000	G56838		255040	G63875		259880	G64071	
217101	G52237		252010	69900		255050	G64033		259890	70037	
217102	G52238		252020	69465		255100	G51087		801940	142230	
217200	G56606		252030	69464		255110	G51812		801940	142419	
219001	G52164		252040	G64047		255130	70089		801940	143353	
219002	G52165		252080	69591		255200	G51279		804975	143315	
219010	G56894		252090	G63870		255210	G51955		805606	143239	
219011	G56642		252100	G51724		255300	G51727		805904	143305	
219012	G56643		252110	G63867		255400	G63878		805907	143323	
219020	G51810		252110	G64157		255410	G64031		805908	143355	
219020	G51811		252130	70096		255420	G63712		805909	143354	
219021	G52005		252200	G63717		255500	G63883		805966	143468	
219022	G52006		252300	G55901		255510	G64050		805983	143342	
219030	G56809		252310	G64037		255600	G51798		806914	142937	
219201	G56539		252400	69592		255610	G51803		806980	143365	
219202	G56540		252400	69593		255700	70041				
219300	G51714		252420	G511001		255800	70027				

Volkswagen

Volkswagen	Gabriel	Upgrade	Volkswagen	Gabriel	Upgrade	Volkswagen	Gabriel	Upgrade	Volkswagen	Gabriel	Upgrade
1J0 413 031 GC	G56606		1K0 412 331 B	143344							
1J0 513 025 DP	69945		1K0 412 331 C	143344							

Important Note: Competitive Interchanges are to be used for stocking purposes only. Where multiple crosses are identified, please reference the applications section of this catalog. / **Remarque importante:** Les interchanges concurrentiels ne s'utilisent qu'aux fins de stocks. Dans le cas de rferences multiples, consulter la section des applications du catalogue. / **Nota importante:** En el caso de rferencias multiples, consultar la seccion de aplicaciones del catalogo. / **Nota importante:** Se pueden usar intercambios competitivos para propósitos de almacenamiento solamente. Cuando se identifican intercambios múltiples, consulte la sección de aplicaciones de este catálogo.

COMPETITIVE & O.E.M. INTERCHANGE LIST
Lista de Intercambios contra Competidores y Equipo Original.
Liste dinterchange de produits comptitifs & dquipement original (OEM)

Volkswagen... cont'd

Volkswagen	Gabriel	Upgrade	Volkswagen	Gabriel	Upgrade	Volkswagen	Gabriel	Upgrade	Volkswagen	Gabriel	Upgrade
1K0 513 029 FP	G51799		3AA 413 031 M	G56899		5N0 413 031 AK	G52301		7B0 412 031 B	G52131	
1K0 513 029 HM	G51799		3C0 413 031 AS	G56899		5N0 413 031 AS	G52301		7B0 412 031 C	G52131	
1K0 513 029 HN	G51799		3C0 413 031 AT	G56899		5N0 512 011 AA	G51993		7B0 513 031 N	G64042	
1K0 513 029 HQ	G51799		3C0 413 031 M	G56899		5N0 513 049 AB	G51993		7B0 513 031 P	G64042	
1K0 513 029 ME	G51799		3C0 513 049 BD	G51799		5N0 513 049 AC	G51993		7L6 413 031 S	G52348	
1K0 513 029 MF	G51799		3C0 513 049 BH	G51799		5N0 513 049 AJ	G51993		7L6 413 031 T	G52348	
1K0 513 029 MG	G51799		3C0 513 049 CP	G51799		5N0 513 049 AK	G51993		7L6 413 032 S	G52349	
1K0 513 353 G	143345		3C0 513 353 C	143345		5N0 513 049 AP	G51993		7L6 413 032 T	G52349	
1T0 413 031 EQ	G56899		5C0 413 031 BB	G56899		5N0 513 049 AQ	G51993		7L6 513 029 N	G51928	
1T0 413 031 HK	G56899		5C0 513 025 H	G51799		5N0 513 049 BF	G51993		7L6 513 029 P	G51928	
1T0 413 031 HM	G56899		5C0 513 049 BS	G51799		5N0 513 049 BG	G51993				
1T0 413 031 HN	G56899		5N0 413 031 AA	G52301		5N0 513 049 T	G51993				
1T0 413 031 HP	G56899		5N0 413 031 AC	G52301		7B0 412 031 A	G52131				

Watson & Chalin Mfg. Inc.

Watson & chalin mfg. inc.	Gabriel	Upgrade	Watson & chalin mfg. inc.	Gabriel	Upgrade	Watson & chalin mfg. inc.	Gabriel	Upgrade	Watson & chalin mfg. inc.	Gabriel	Upgrade
10147	83203	89436	17186	85323	89436	19603	85939		727603	83203	89436
10147	89436		17186	89436		3946219	83400		727603	89436	
10147HD	85000	89436	17186-01	85323	89436	53000070-001	646177		727604	83204	
10147HD	89436		17186-01	89436		665724	85000	89436	A-20345	85345	
10148	83204		1718601	85323	89436	665724	89436		A20345	85345	
10634	G63357		1718601	89436		665727	85005	89430	B-23649	85064	
11418	646155		17218	85029		665727	89430		B-23650	85052	
11418	646177		17297	85064		665728	85060		B-23651	85045	
11604	83125		17300	85052		665769	85052		B-23743	85938	
11724	83123	89405	17306	85938		665770	85064		B23649	85064	
11724	89405		17382	85014		665862	85000	89436	B23650	85052	
12128	85005	89430	17430	85321		665862	89436		B23651	85045	
12128	89430		17474	85009		680547	85323	89436	B23743	85938	
17069	632147		19036	85934		680547	89436				
17079	85300	89419	19249	85939		680584	85938				
17079	89419		19250	85382		680714	85934				

Important Note: Competitive Interchanges are to be used for stocking purposes only. Where multiple crosses are identified, please reference the applications section of this catalog. / **Remarque importante:** Les interchanges concurrentiels ne s'utilisent qu'aux fins de stocks. Dans le cas de références multiples, consulter la section des applications du catalogue. / **Nota importante:** Dans le cas de références multiples, consulter la section des applications du catalogue. / **Nota importante:** Se pueden usar intercambios competitivos para propósitos de almacenamiento solamente. Cuando se identifican intercambios múltiples, consulte la sección de aplicaciones de este catálogo.

LEFT/RIGHT COMBINATIONS

ProGuard				G52121	FL	G52122	FR	G52329	FL	G52330	FR
61699	RL	61700	RR	G52127	FL	G52128	FR	G52331	FL	G52332	FR
Suspension Mounts				G52129	FL	G52130	FR	G52335	RL	G52336	RR
142650	FL	142649	FR	G52140	FL	G52141	FR	G52348	FL	G52349	FR
143071	RL	143072	RR	G52142	FL	G52143	FR	G52351	FL	G52352	FR
143073	RL	143074	RR	G52144	FL	G52145	FR	G52353	FL	G52354	FR
143354	FL	143355	FR	G52148	FL	G52149	FR	G52355	FL	G52356	FR
143387	RL	143388	RR	G52150	FL	G52151	FR	G52360	FL	G52361	FR
143390	RL	143391	RR	G52152	FL	G52153	FR	G52374	FL	G52375	FR
143409	FL	143410	FR	G52154	FL	G52155	FR	G52382	FL	G52383	FR
143461	RL	143462	RR	G52156	FL	G52157	FR	G52395	FL	G52396	FR
143465	RL	143466	RR	G52158	FL	G52159	FR	G52398	FL	G52399	FR
Ultra Struts				G52160	FL	G52161	FR	G52410	FL	G52411	FR
G511054	FL	G511055	FR	G52162	RL	G52163	RR	G52437	FL	G52438	FR
G51761	FL	G51760	FR	G52164	FL	G52165	FR	G52439	FL	G52440	FR
G51813	FL	G51814	FR	G52168	FL	G52169	FR	G52449	FL	G52450	FR
G51853	FL	G51854	FR	G52170	FL	G52171	FR	G52494	FL	G52495	FR
G51877	FL	G51878	FR	G52173	FL	G52174	FR	G52524	FL	G52525	FR
G51896	FL	G51897	FR	G52175	FL	G52176	FR	G52906	FL	G52907	FR
G51920	FL	G51921	FR	G52182	RL	G52183	RR	G55661	RL	G55662	RR
G51925	FL	G51926	FR	G52184	FL	G52185	FR	G55675	RL	G55676	RR
G51947	FL	G51948	FR	G52187	FL	G52188	FR	G55993	FL	G55994	FR
G52004	FL	G52007	FR	G52199	FL	G52200	FR	G56506	FL	G56514	FR
G52005	FL	G52006	FR	G52201	FL	G52202	FR	G56516	FL	G56517	FR
G52008	FL	G52009	FR	G52203	RL	G52204	RR	G56530	FL	G56529	FR
G52013	FL	G52014	FR	G52209	FL	G52210	FR	G56538	RL	G56537	RR
G52017	RL	G52018	RR	G52237	FL	G52238	FR	G56539	FL	G56540	FR
G52026	FL	G52027	FR	G52245	FL	G52246	FR	G56562	FL	G56561	FR
G52032	FL	G52033	FR	G52247	FL	G52248	FR	G56582	FL	G56581	FR
G52036	FL	G52037	FR	G52249	FL	G52250	FR	G56601	FL	G56568	FR
G52081	FL	G52082	FR	G52253	FL	G52254	FR	G56615	FL	G56616	FR
G52094	FL	G52095	FR	G52255	FL	G52256	FR	G56621	FL	G56622	FR
G52096	FL	G52097	FR	G52257	FL	G52258	FR	G56634	FL	G56633	FR
G52103	RL	G52104	RR	G52260	FL	G52261	FR	G56636	FL	G56635	FR
G52105	FL	G52106	FR	G52264	FL	G52265	FR	G56637	RL	G56571	RR
G52107	FL	G52108	FR	G52274	FL	G52275	FR	G56640	RL	G56641	RR
G52110	FL	G52111	FR	G52278	FL	G52279	FR	G56640	RL	G56641	RR
G52112	FL	G52113	FR	G52280	FL	G52281	FR	G56661	FL	G56660	FR
G52117	FL	G52118	FR	G52282	FL	G52283	FR	G56671	FL	G56672	FR
				G52293	FL	G52294	FR	G56679	FL	G56680	FR
				G52297	FL	G52298	FR	G56687	FL	G56688	FR
				G52299	FL	G52300	FR	G56721	FL	G56722	FR

LEFT/RIGHT COMBINATIONS

G56728	RL	G56729	RR	G57054	FL	G57055	FR	G57159	RL	G57160	RR
G56730	FL	G56731	FR	G57057	RL	G57058	RR	G57161	FL	G57162	FR
G56732	RL	G56733	RR	G57061	RL	G57062	RR	G57163	FL	G57164	FR
G56734	RL	G56735	RR	G57063	FL	G57064	FR	G57167	RL	G57168	RR
G56759	FL	G56758	FR	G57065	FL	G57066	FR	G57176	FL	G57177	FR
G56773	FL	G56774	FR	G57067	RL	G57068	RR	G57184	FL	G57185	FR
G56798	FL	G56797	FR	G57069	FL	G57070	FR	G57190	FL	G57191	FR
G56800	FL	G56799	FR	G57071	FL	G57072	FR	G57192	RL	G57193	RR
G56819	FL	G56820	FR	G57076	FL	G57077	FR	G57194	FL	G57195	FR
G56822	RL	G56821	RR	G57078	RL	G57079	RR	G57197	FL	G57198	FR
G56836	FL	G56837	FR	G57081	FL	G57082	FR	G57200	FL	G57201	FR
G56840	FL	G56841	FR	G57084	FL	G57085	FR	G57202	FL	G57203	FR
G56842	FL	G56843	FR	G57086	RL	G57087	RR	G57204	FL	G57205	FR
G56886	FL	G56887	FR	G57088	FL	G57089	FR	G57207	FL	G57208	FR
G56892	FL	G56893	FR	G57090	RL	G57091	RR	G57218	FL	G57219	FR
Ultra Readymounts				G57097	FL	G57098	FR	G57220	FL	G57221	FR
G56924	RL	G56925	RR	G57099	FL	G57100	FR	G57222	FL	G57223	FR
G56930	FL	G56931	FR	G57105	FL	G57106	FR	G57266	FL	G57267	FR
G56932	RL	G56933	RR	G57107	FL	G57108	FR	G57268	FL	G57269	FR
G56934	FL	G56937	FR	G57110	FL	G57111	FR	G57275	FL	G57276	FR
G56949	RL	G56950	RR	G57112	FL	G57113	FR	G57278	RL	G57279	RR
G56956	FL	G56957	FR	G57114	FL	G57115	FR	G57322	FL	G57323	FR
G56962	FL	G56963	FR	G57119	FL	G57120	FR	G57329	FL	G57330	FR
G56973	RL	G56974	RR	G57121	FL	G57122	FR	G57331	FL	G57332	FR
G56991	FL	G56992	FR	G57123	FL	G57124	FR	G57333	FL	G57334	FR
G56993	FL	G56994	FR	G57126	FL	G57127	FR	G57335	FL	G57336	FR
G56996	FL	G56997	FR	G57128	RL	G57129	RR	G57337	FL	G57338	FR
G57007	FL	G57008	FR	G57130	FL	G57131	FR	G57339	FL	G57340	FR
G57011	FL	G57012	FR	G57133	FL	G57134	FR	G57341	FL	G57342	FR
G57030	FL	G57031	FR	G57135	FL	G57136	FR	G57343	RL	G57344	RR
G57032	RL	G57033	RR	G57137	FL	G57138	FR	G57345	FL	G57346	FR
G57034	FL	G57035	FR	G57139	FL	G57140	FR	G57349	FL	G57350	FR
G57037	FL	G57038	FR	G57144	FL	G57145	FR	G57353	FL	G57354	FR
G57041	FL	G57042	FR	G57150	FL	G57151	FR	G57357	FL	G57358	FR
G57043	RL	G57044	RR	G57152	RL	G57153	RR	G57359	FL	G57360	FR
G57045	FL	G57046	FR	G57157	FL	G57158	FR	G57363	FL	G57364	FR
G57047	FL	G57048	FR								
G57049	FL	G57050	FR								

LEFT/RIGHT COMBINATIONS

G57367	FL	G57368	FR	G57539	FL	G57540	FR	G57732	FL	G57733	FR
G57369	FL	G57370	FR	G57541	FL	G57542	FR	G57734	FL	G57735	FR
G57372	FL	G57373	FR	G57543	FL	G57544	FR	G57738	FL	G57739	FR
G57375	FL	G57376	FR	G57545	FL	G57546	FR	G57740	FL	G57741	FR
G57377	FL	G57378	FR	G57549	FL	G57550	FR	G57742	FL	G57743	FR
G57390	FL	G57391	FR	G57558	FL	G57559	FR	G57744	FL	G57745	FR
G57393	FL	G57394	FR	G57560	FL	G57561	FR	G57746	FL	G57747	FR
G57398	FL	G57399	FR	G57562	FL	G57563	FR	G57749	FL	G57825	FR
G57400	RL	G57401	RR	G57564	FL	G57565	FR	G57750	FL	G57751	FR
G57404	FL	G57405	FR	G57566	FL	G57567	FR	G57752	FL	G57753	FR
G57414	RL	G57415	RR	G57572	RL	G57573	RR	G57758	FL	G57759	FR
G57416	RL	G57682	RR	G57577	FL	G57578	FR	G57764	FL	G57765	FR
G57417	FL	G57418	FR	G57582	FL	G57583	FR	G57768	FL	G57769	FR
G57424	RL	G57425	RR	G57586	RL	G57587	RR	G57772	FL	G57773	FR
G57428	RL	G57429	RR	G57594	FL	G57595	FR	G57774	FL	G57775	FR
G57449	RL	G57450	RR	G57597	RL	G57598	RR	G57776	FL	G57777	FR
G57451	RL	G57452	RR	G57603	FL	G57604	FR	G57778	FL	G57779	FR
G57454	FL	G57453	FR	G57605	FL	G57606	FR	G57780	FL	G57781	FR
G57455	FL	G57456	FR	G57612	RL	G57613	RR	G57782	FL	G57783	FR
G57459	FL	G57460	FR	G57628	FL	G57629	FR	G57784	FL	G57785	FR
G57464	FL	G57463	FR	G57634	RL	G57635	RR	G57790	FL	G57791	FR
G57465	FL	G57466	FR	G57644	FL	G57645	FR	G57792	RL	G57793	RR
G57471	FL	G57472	FR	G57648	FL	G57649	FR	G57795	RL	G57796	RR
G57473	FL	G57474	FR	G57658	RL	G57659	RR	G57800	FL	G57801	FR
G57479	FL	G57480	FR	G57663	FL	G57664	FR	G57803	FL	G57804	FR
G57481	FL	G57482	FR	G57665	FL	G57666	FR	G57817	FL	G57818	FR
G57483	RL	G57484	RR	G57673	FL	G57674	FR	G57819	FL	G57820	FR
G57489	FL	G57490	FR	G57676	FL	G57677	FR	G57852	FL	G57853	FR
G57493	FL	G57494	FR	G57689	FL	G57690	FR				
G57495	FL	G57496	FR	G57691	FL	G57692	FR				
G57497	FL	G57498	FR	G57693	FL	G57694	FR				
G57499	RL	G57500	RR	G57695	FL	G57696	FR				
G57515	FL	G57516	FR	G57697	FL	G57698	FR				
G57517	FL	G57518	FR	G57699	FL	G57700	FR				
G57521	FL	G57522	FR	G57701	FL	G57702	FR				
G57533	RL	G57534	RR	G57704	FL	G57705	FR				
G57535	FL	G57536	FR	G57712	FL	G57713	FR				
				G57716	FL	G57717	FR				
				G57720	FL	G57721	FR				
				G57722	FL	G57723	FR				
				G57724	FL	G57725	FR				
				G57726	FL	G57727	FR				
				G57730	FL	G57731	FR				

Guardian Struts

M55913	FL	M55912	FR
M55920	FL	M55921	FR

EXPLANATION OF SPECIFICATIONS

Part Number:	The catalog number for the individual shock absorber.
Extended Length*:	The length of the shock absorber when it is fully extended. See "How to Measure" instructions.
Collapsed Length*:	The length of the shock absorber when it is fully collapsed. See "How to Measure" instructions.
Stroke:	This is the approximate length of the stroke of the individual shock absorber being described.
Mounting Codes:	Indicates the type of mounting ends for the upper and lower end of each shock absorber. They are listed as follows: Top mounts ("TM") Eye ring and bushing with sleeve mounts ("ES") Stud type mounts ("S" & "DS") Eye ring and bushing with bar pin mounts ("BP") Special mounting codes ("SP") Eye ring and bushing mounts ("EB") Clevis mounts ("CL") Pinch socket mounts ("LP") U joint mounts ("LU")

CONVERSION CHART

Fraction (Inches)	Decimal (Inches)	Metric (MM)	Fraction (Inches)	Decimal (Inches)	Metric (MM)
1/64	0.016	0.397	33/64	0.516	13.097
1/32	0.031	0.794	17/32	0.531	13.494
3/64	0.047	1.191	35/64	0.547	13.891
1/16	0.063	1.588	9/16	0.563	14.288
5/64	0.078	1.984	37/64	0.578	14.684
3/32	0.094	2.381	19/32	0.594	15.081
7/64	0.109	2.778	39/64	0.609	15.478
1/8	0.125	3.175	5/8	0.625	15.875
9/64	0.141	3.572	41/64	0.641	16.272
5/32	0.156	3.969	21/32	0.656	16.669
11/64	0.172	4.366	43/64	0.672	17.066
3/16	0.188	4.763	11/16	0.688	17.463
13/64	0.203	5.159	45/64	0.703	17.859
7/32	0.219	5.556	23/32	0.719	18.256
15/64	0.234	5.953	47/64	0.734	18.653
1/4	0.250	6.350	3/4	0.750	19.050
17/64	0.266	6.747	49/64	0.766	19.447
9/32	0.281	7.144	25/32	0.781	19.844
19/64	0.297	7.541	51/64	0.797	20.241
5/16	0.313	7.938	13/16	0.813	20.638
21/64	0.328	8.334	53/64	0.828	21.034
11/32	0.344	8.731	27/32	0.844	21.431
23/64	0.359	9.128	55/64	0.859	21.828
3/8	0.375	9.525	7/8	0.875	22.225
25/64	0.391	9.922	57/64	0.891	22.622
13/32	0.406	10.319	29/32	0.906	23.019
27/64	0.422	10.716	59/64	0.922	23.416
7/16	0.438	11.113	15/16	0.938	23.813
29/64	0.453	11.509	61/64	0.953	24.209
15/32	0.469	11.906	31/32	0.969	24.606
31/64	0.484	12.303	63/64	0.984	25.003
1/2	0.500	12.700	1	1.000	25.400

METRIC CONVERSION CHART

MILLIMETERS	INCHES	MILLIMETERS	INCHES	MILLIMETERS	INCHES
1	0.03937	10	0.39370	19	0.74803
2	0.07874	11	0.43307	20	0.78740
3	0.11811	12	0.47244	21	0.82677
4	0.15748	13	0.51181	22	0.86614
5	0.19685	14	0.55118	23	0.90551
6	0.23622	15	0.59055	24	0.94488
7	0.27559	16	0.62992	25	0.98425
8	0.31496	17	0.66929		
9	0.35433	18	0.70866		

HOW TO MEASURE EXTENDED & COLLAPSED LENGTHS OF SHOCK ABSORBERS

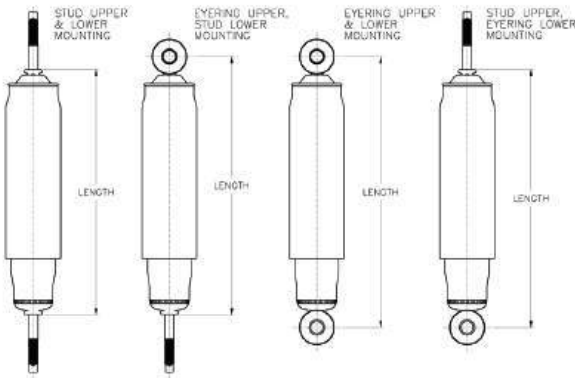

Instructions

1. Using the proper measuring points as shown above find the nearest replacement shock absorber from the listing increments of extended length.
2. Identify the proper mounting form the mounting codes and match these requirements by carefully measuring the mounting dimensions (top and bottom) of the shock absorber to be replaced.
3. Carefully take note of the following requirements:
 - a. **Mounting Accessories** - Contents and descriptions of parts are shown in this manual.
 - b. **Dust tubes** - This requirement should be noted in comparison with the shock absorber to be replaced. Shock absorber environment in its application makes this requirement necessary for piston rod protection and extended shock absorber life.
 - c. **Recoil Cutoff and Compression Bumper** - Carefully note these specifications- deviation of length requirements should not exceed $\pm\frac{1}{2}$ ". These shock absorber designs are footnoted for easy identification.
 - d. **Limited Environment Application** - Most conventional shock absorbers are offered in "straight" construction to fit limited environment applications. These shock absorber designs are footnoted.

SHOCK ABSORBER DIAMETERS

Shown below are measuring points for diameters by type of shock absorber. Refer to the chart below which lists diameters for the various bore sizes available for each type.

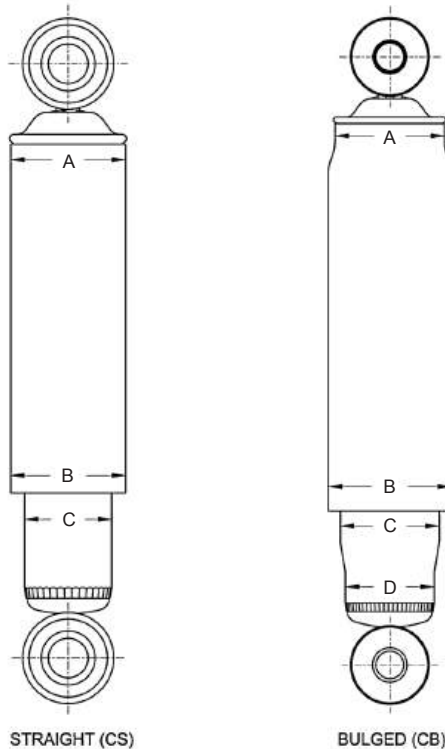

BORE SIZE	SHOCK ABSORBERS	TYPE (Shown Above)	Diameters			
			A	B	C	D
1 3/16"	Classic, Guardian, Ultra Pass. Car	CS	2.06	2.00	1.63	NA
1 3/16"	Classic, Guardian, Ultra Pass. Car	CB	2.06	2.19	1.81	1.63
1 3/8"	Ultra Truck	CS	NA	2.37	2.00	NA
1 3/8"	Ultra Truck	CB	2.37	2.50	2.19	2.00

MOUNTING CODE "TM" TOP MOUNT

T M # # #

1st & 2nd digit - "Top Mount"

3rd digit - Part type/shape from the five categories listed below

4th digit - Number of studs / bolts (the amount of mounting points to the vehicle (see example below)

5th digit - Design of the mounting point - Stud (S) Bolt (B) Clip (C) (see example below)

TOP MOUNT DESIGN SHAPES



EXAMPLES

The fourth digit will note how many mounting points to the vehicle body exist.
The final digits indicate the type of mounting point **Stud (S)** **Bolt (B)** **Clip (C)**
(a combination is used for multiple mounting points)

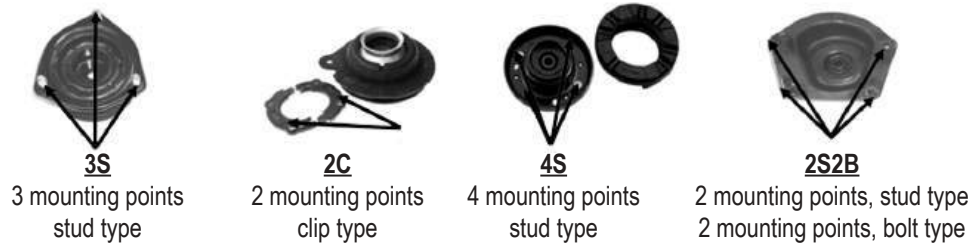

TOP MOUNT CODE	TOP MOUNT DESIGN	MOUNTING TYPE
TMC0	Circle	
TMC2B	Circle	2 Bolt
TMC2S	Circle	2 Stud
TMC2S1B	Circle	2 Stud, 1 Bolt
TMC3B	Circle	3 Bolt
TMC3S	Circle	3 Stud
TMC4B	Circle	4 Bolt
TMC4S	Circle	4 Stud
TMC5S	Circle	5 Stud
TMO2B	Oval	2 Bolt
TMO2S	Oval	2 Stud
TMO3S	Oval	3 Stud
TMO4B	Oval	4 Bolt
TMR2S	Rectangle	2 Stud
TMR3S	Rectangle	3 Stud
TMR4S	Rectangle	4 Stud
TMS3S	Square	3 Stud

TOP MOUNT CODE	TOP MOUNT DESIGN	MOUNTING TYPE
TMS3S1B	Square	3 Stud 1 Bolt
TMS4S	Square	4 Stud
TMT3B	Triangle	3 Bolt
TMT3S	Triangle	3 Stud
TMU2B	Unique	2 bolt
TMU2B1S	Unique	2 Bolt, 1 Stud
TMU2S	Unique	2 Stud
TMU2S1B	Unique	2 Stud, 1 Bolt
TMU2S2B	Unique	2 Stud, 2 Bolt
TMU3B	Unique	3 Bolt
TMU3B1S	Unique	3 Bolt, 1 Stud
TMU3S	Unique	3 Stud
TMU3S1B	Unique	3 Stud 1 Bolt
TMU4B	Unique	4 Bolt
TMU4S	Unique	4 Stud
TMU5S	Unique	5 Stud

MOUNTING CODE "ES" EYE RING AND BUSHING WITH STEEL SLEEVE

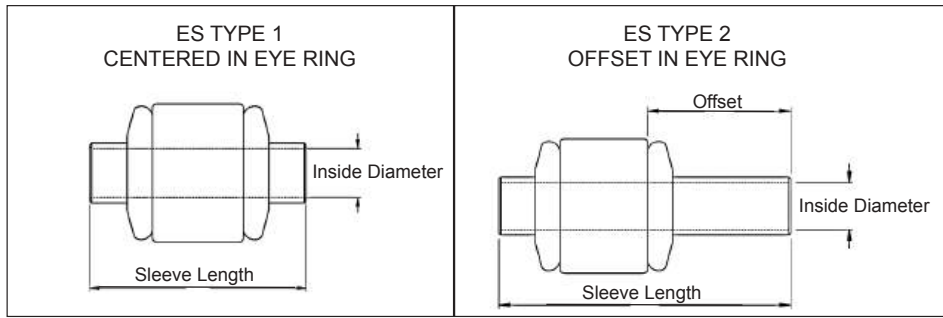

MOUNTING CODE	TYPE	DIMENSION					
		Inside Diameter		Sleeve Length		Offset (type 2 only)	
		(inches)	(mm)	(inches)	(mm)	(inches)	(mm)
ES1	1	0.39	10.00	1.25	31.75	--	--
ES2	1	0.39	10.00	1.42	36.07	--	--
ES3	1	0.39	10.00	1.56	39.62	--	--
ES4	2	0.50	12.70	2.20	55.88	0.77	19.558
ES5	1	0.39	10.00	2.07	52.58	--	--
ES6	1	0.39	10.00	2.35	59.69	--	--
ES7	1	0.56	14.29	1.25	31.75	--	--
ES8	1	0.44	11.11	1.25	31.75	--	--
ES9	1	0.44	11.11	1.31	33.27	--	--
ES10	1	0.44	11.11	1.38	35.05	--	--
ES11	1	0.44	11.11	1.50	38.10	--	--
ES12	1	0.44	11.11	1.62	41.15	--	--
ES13	1	0.56	14.29	1.89	48.01	--	--
ES14	1	0.44	11.11	1.88	47.75	--	--
ES15	1	0.56	14.29	2.79	70.87	--	--
ES16	1	0.44	11.11	3.15	80.01	--	--
ES17	1	0.47	12.00	1.25	31.75	--	--
ES18	1	0.47	12.00	1.65	41.91	--	--
ES19	1	0.47	12.00	1.88	47.75	--	--
ES20	1	0.47	12.00	1.95	49.53	--	--
ES21	1	0.47	12.00	2.28	57.91	--	--
ES22	1	0.50	12.70	1.25	31.75	--	--
ES23	1	0.50	12.70	1.31	33.27	--	--
ES24	1	0.50	12.70	1.38	35.05	--	--
ES25	1	0.50	12.70	1.50	38.10	--	--
ES26	1	0.50	12.70	1.56	39.62	--	--
ES27	1	0.50	12.70	1.62	41.15	--	--
ES28	1	0.56	14.29	3.15	80.01	--	--
ES29	1	0.39	10.00	2.95	74.93	--	--
ES30	1	0.47	12.00	2.57	65.28	--	--
ES31	2	0.50	12.70	2.25	57.15	1.00	25.4
ES32	1	0.50	12.70	3.34	84.84	--	--
ES33	1	0.47	12.00	3.15	80.01	--	--
ES34	1	0.56	14.29	1.66	42.16	--	--
ES35	1	0.63	15.88	1.38	35.05	--	--
ES36	1	0.75	19.05	1.75	44.45	--	--
ES37	1	0.47	12.00	1.01	25.65	--	--
ES38	1	0.44	11.11	2.18	55.37	--	--
ES39	1	0.39	10.00	1.31	33.27	--	--
ES40	1	0.44	11.11	3.38	85.85	--	--
ES41	1	0.47	12.00	3.48	88.39	--	--
ES42	1	0.47	12.00	3.77	95.76	--	--
ES43	1	0.51	13.00	1.31	33.27	--	--
ES44	1	0.39	10.00	2.28	57.91	--	--
ES45	1	0.51	13.00	1.68	42.67	--	--
ES46	1	0.51	13.00	1.73	43.94	--	--
ES47	1	0.51	13.00	2.50	63.50	--	--
ES48	1	0.55	14.00	1.42	36.07	--	--
ES49	1	0.55	14.00	1.66	42.16	--	--
ES50	1	0.55	14.00	1.81	45.97	--	--
ES51	1	0.55	14.00	1.89	48.01	--	--
ES52	1	0.55	14.00	1.96	49.78	--	--
ES53	1	0.39	10.00	1.38	35.05	--	--
ES54	1	0.47	12.00	2.91	73.91	--	--
ES55	1	0.55	14.00	2.00	50.80	--	--
ES56	1	0.55	14.00	1.58	40.13	--	--

MOUNTING CODE	TYPE	DIMENSION					
		Inside Diameter		Sleeve Length		Offset (type 2 only)	
		(inches)	(mm)	(inches)	(mm)	(inches)	(mm)
ES57	1	0.39	10.00	1.03	26.16	--	--
ES58	1	0.55	14.00	2.13	54.10	--	--
ES59	1	0.59	15.00	1.56	39.62	--	--
ES60	1	0.55	14.00	1.26	32.00	--	--
ES61	1	0.47	12.00	1.76	44.70	--	--
ES62	1	0.47	12.00	0.98	24.89	--	--
ES63	1	0.59	15.00	2.28	57.91	--	--
ES64	1	0.63	16.00	1.25	31.75	--	--
ES65	1	0.47	12.00	1.38	35.05	--	--
ES66	1	0.63	16.00	1.38	35.05	--	--
ES67	1	0.63	16.00	1.56	39.62	--	--
ES68	1	0.56	14.29	1.35	34.29	--	--
ES69	1	0.47	12.00	1.58	40.13	--	--
ES70	2	0.44	11.11	1.88	47.75	0.70	17.78
ES71	1	0.59	15.00	2.15	54.61	--	--
ES72	1	0.63	16.00	1.65	41.91	--	--
ES73	1	0.63	16.00	1.74	44.20	--	--
ES74	1	0.63	16.00	1.93	49.02	--	--
ES75	1	0.63	16.00	2.04	51.82	--	--
ES76	1	0.53	13.49	1.49	37.85	--	--
ES77	1	0.79	20.00	2.35	59.69	--	--
ES78	1	0.39	10.00	1.92	48.77	--	--
ES79	1	0.66	16.67	1.58	40.13	--	--
ES80	2	0.78	19.84	1.69	42.93	0.07	1.778
ES81	1	0.48	12.30	1.26	32.00	--	--
ES82	1	0.48	12.30	1.53	38.86	--	--
ES83	1	0.47	12.00	1.48	37.59	--	--
ES84	1	0.39	10.00	1.62	41.15	--	--
ES85	1	0.47	12.00	2.36	59.94	--	--
ES86	1	0.55	14.00	2.44	61.98	--	--
ES87	1	0.48	12.30	1.65	41.91	--	--
ES88	1	0.47	12.00	1.81	45.97	--	--
ES89	1	0.61	15.48	2.16	54.86	--	--
ES90	1	0.63	15.88	2.00	50.80	--	--
ES91	1	0.50	12.70	2.10	53.34	--	--
ES92	2	0.61	15.48	2.20	55.88	0.88	22.35
ES93	2	0.61	15.48	2.57	65.28	0.79	20.07
ES94	1	0.50	12.70	2.15	54.61	--	--
ES95	1	0.64	16.27	2.00	50.80	--	--
ES96	1	0.70	17.86	1.57	39.88	--	--
ES99	1	0.55	14.00	1.42	36.07	--	--
ES102	1	0.39	10.00	1.77	44.96	--	--
ES104	1	0.79	20.00	1.58	40.13	--	--
ES106	1	0.39	10.00	1.48	37.59	--	--
ES107	1	0.47	12.00	2.15	54.61	--	--
ES109	1	0.39	10.00	0.95	24.13	--	--
ES110	1	0.63	16.00	1.61	40.89	--	--
ES111	1	0.35	9.00	1.78	45.21	--	--
ES112	1	0.47	12.00	1.08	27.43	--	--
ES113	1	0.63	16.00	1.49	37.85	--	--
ES114	1	0.47	12.00	2.04	51.82	--	--
ES115	1	0.39	10.00	2.02	51.31	--	--
ES118	1	0.47	12.00	1.31	33.27	--	--
ES120	1	0.75	19.05	2.76	70.10	--	--
ES121	1	0.75	19.05	2.06	52.32	--	--
ES123	1	0.63	16.00	1.57	39.88	--	--

MOUNTING CODE "ES" EYE RING AND BUSHING WITH STEEL SLEEVE CONT'D

MOUNTING CODE	TYPE	DIMENSION					
		Inside Diameter		Sleeve Length		Offset (type 2 only)	
		(inches)	(mm)	(inches)	(mm)	(inches)	(mm)
ES126	1	0.50	12.70	2.44	61.98	--	--
ES128	1	0.50	12.70	1.66	42.16	--	--
ES130	1	0.50	12.70	1.56	39.62	--	--
ES133	1	0.47	12.00	1.93	49.02	--	--
ES136	1	0.63	15.88	1.75	44.45	--	--
ES137	1	0.50	12.70	1.73	43.94	--	--
ES138	1	0.63	15.88	1.70	43.18	--	--
ES139	1	0.47	12.00	1.35	34.29	--	--
ES141	1	0.47	12.00	1.61	40.89	--	--
ES142	1	0.63	16.00	1.43	36.32	--	--
ES143	1	0.56	14.29	1.60	40.64	--	--
ES145	1	0.44	11.11	2.25	57.15	--	--
ES146	1	0.47	12.00	1.37	34.80	--	--
ES147	1	0.47	12.00	1.97	50.04	--	--
ES149	1	0.50	12.70	2.36	59.94	--	--
ES150	1	0.75	19.05	2.24	56.90	--	--
ES152	1	0.79	20.00	1.69	42.93	--	--
ES153	1	0.55	14.00	1.55	39.37	--	--
ES157	2	0.50	12.70	2.05	52.07	0.95	24.13
ES158	1	0.75	19.05	3.80	96.52	--	--
ES159	2	0.75	19.05	3.21	81.53	1.03	26.162
ES160	1	1.00	25.40	2.01	51.05	--	--
ES161	1	0.63	16.00	3.95	100.33	--	--
ES162	1	0.63	16.00	2.60	66.04	--	--
ES163	1	0.44	11.11	2.50	63.50	--	--
ES164	1	0.50	12.70	2.26	57.40	--	--
ES165	1	0.50	12.70	1.75	44.45	--	--
ES166	1	0.63	15.88	2.97	75.44	--	--
ES167	1	0.55	14.00	2.31	58.67	--	--
ES168	1	0.55	14.00	2.62	66.55	--	--
ES169	1	0.55	14.00	1.91	48.51	--	--
ES171	1	0.50	12.70	1.88	47.75	--	--
ES172	1	0.50	12.70	2.72	69.09	--	--
ES173	1	0.88	22.23	2.28	57.91	--	--
ES174	1	0.63	15.88	3.25	82.55	--	--
ES175	1	0.63	16.00	1.96	49.78	--	--
ES176	1	0.63	16.00	3.72	94.49	--	--
ES177	1	0.63	16.00	3.55	90.17	--	--
ES178	1	0.75	19.05	1.96	49.78	--	--
ES179	1	0.79	20.00	1.75	44.45	--	--
ES181	1	0.44	11.11	1.98	50.29	--	--
ES182	1	0.79	20.00	1.96	49.78	--	--
ES183	1	0.79	20.00	3.80	96.52	--	--
ES184	1	0.79	20.00	2.44	61.98	--	--
ES185	1	0.47	12.00	2.44	61.98	--	--
ES187	1	1.00	25.40	1.75	44.45	--	--
ES188	1	0.63	16.00	1.81	45.97	--	--
ES190	1	0.87	22.00	1.75	44.45	--	--
ES191	1	1.00	25.40	2.44	61.98	--	--
ES192	1	0.94	24.00	2.44	61.98	--	--
ES193	1	0.94	24.00	2.28	57.91	--	--
ES194	1	0.88	22.23	2.28	57.91	--	--
ES195	1	0.48	12.30	2.17	54.99	--	--
ES196	1	0.39	10.00	0.95	24.00	--	--
ES197	1	0.71	18.00	1.58	40.01	--	--
ES198	2	0.39	10.00	3.15	80.00	1.1811	30
ES199	1	0.40	10.19	1.97	50.04	--	--
ES200	1	0.48	12.05	2.20	55.75	--	--
ES201	1	0.57	14.40	1.94	49.28	--	--
ES202	1	1.11	28.15	2.60	66.04	--	--
ES203	1	1.11	28.15	3.94	100.08	--	--
ES204	1	0.57	14.48	1.68	42.67	--	--
ES205	1	0.39	10.00	1.57	40.00	--	--
ES206	1	0.50	12.70	3.13	79.50	--	--
ES207	1	0.51	12.87	1.58	40.01	--	--
ES208	1	0.73	18.50	2.50	63.50	--	--
ES209	1	0.65	16.50	2.38	60.50	--	--

MOUNTING CODE	TYPE	DIMENSION					
		Inside Diameter		Sleeve Length		Offset (type 2 only)	
		(inches)	(mm)	(inches)	(mm)	(inches)	(mm)
ES210	1	0.73	18.50	1.87	47.50	--	--
ES211	1	0.48	12.08	3.94	100.00	--	--
ES212	1	0.87	22.00	1.97	50.00	--	--
ES213	1	0.79	20.00	4.08	103.51	--	--
ES214	1	0.87	22.00	1.57	40.00	--	--
ES215	1	0.56	14.30	2.14	54.30	--	--
ES216	1	0.57	14.50	3.15	80.00	--	--
ES217	1	0.40	10.21	1.39	35.31	--	--
ES218	1	0.40	10.21	1.18	30.00	--	--
ES219	1	0.47	12.00	1.41	35.90	--	--
ES220	1	0.55	14.00	2.95	75.00	--	--

“S” STUD MOUNT

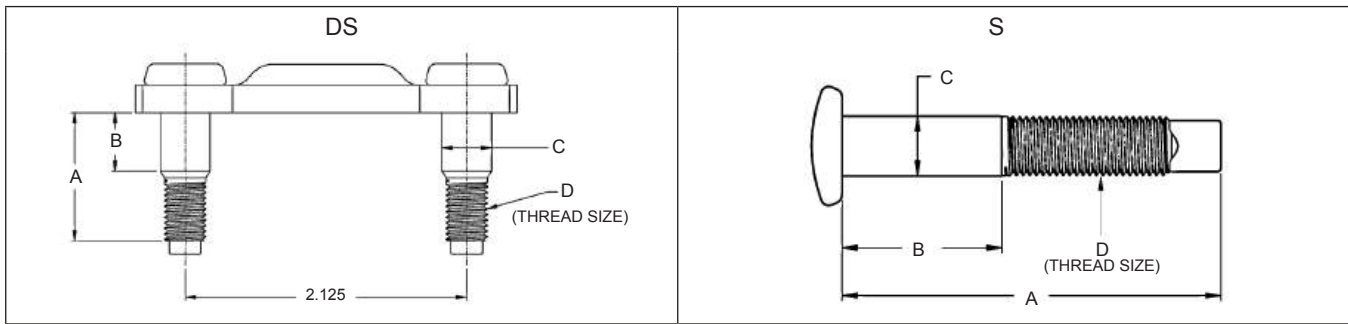

MOUNTING CODE	DIMENSION						
	A		B		C		D
	(inches)	(mm)	(inches)	(mm)	(inches)	(mm)	(thread)
DS1	1.27	32.26	0.66	16.76	0.38	9.53	5/16-24
S1	2.37	60.20	1.00	25.40	0.38	9.53	3/8-24
S2	2.06	52.32	1.00	25.40	0.38	9.53	3/8-24
S3	2.67	67.82	1.37	34.80	0.39	10.00	3/8-16
S4	1.85	46.99	1.00	25.40	0.38	9.53	3/8-24
S5	1.29	32.77	1.14	28.96	0.51	13.00	3/8-24
S6	2.47	62.74	1.47	37.34	0.44	11.11	3/8-24
S7	1.97	50.04	1.00	25.40	0.38	9.53	3/8-24
S8	1.75	44.45	1.00	25.40	0.39	10.00	3/8-24
S9	1.84	46.74	1.05	26.67	0.44	11.11	3/8-24
S10	2.37	60.20	1.33	33.78	0.44	11.11	3/8-24
S11	3.00	76.20	1.12	28.45	0.38	9.53	3/8-24
S12	2.37	60.20	1.15	29.21	0.44	11.11	3/8-24
S13	2.06	52.32	1.35	34.29	0.38	9.53	3/8-24
S14	2.25	57.15	1.33	33.78	0.44	11.11	3/8-24
S15	3.29	83.57	1.98	50.29	0.38	9.53	3/8-24
S16	2.95	74.93	1.45	36.83	0.63	16.00	M16x1.5
S17	2.15	54.61	1.03	26.16	0.44	11.11	3/8-24
S18	2.67	67.82	1.81	45.97	0.39	10.00	M10x1.25
S19	1.34	34.04	0.41	10.41	0.44	11.11	M10x1
S20	1.34	34.04	0.41	10.41	0.39	10.00	M10x1
S21	3.28	83.31	1.75	44.45	0.63	15.88	5/8-18
S22	0.75	19.05	0.35	8.89	0.39	10.00	M10x1
S23	1.84	46.74	1.05	26.67	0.38	9.53	3/8-24
S24	1.22	30.99	0.31	7.87	0.43	11.00	M10x1
S25	1.81	45.97	1.50	38.10	0.38	9.53	M10x1
S26	2.02	51.31	0.82	20.83	0.47	12.00	M10x1
S27	2.36	59.94	1.14	28.96	0.39	10.00	M10x1
S28	2.44	61.98	1.37	34.80	0.47	12.00	M10x1
S29	2.99	75.95	1.87	47.50	0.38	9.53	3/8-24
S30	2.59	65.79	1.41	35.81	0.39	10.00	M10x1
S32	2.31	58.67	1.38	35.05	0.55	14.00	M12x1.25
S33	3.44	87.38	2.17	55.12	0.39	10.00	M10x1
S34	1.06	26.92	0.59	14.99	0.31	7.94	M8x1.25
S35	2.60	66.04	1.12	28.45	0.44	11.11	3/8-24
S36	2.49	63.25	1.33	33.78	0.44	11.11	3/8-24
S37	3.18	80.77	1.41	35.81	0.47	12.00	M10x1
S38	2.75	69.85	1.70	43.18	0.55	14.00	M12x1.25
S39	2.20	55.88	1.31	33.27	0.39	10.00	M10x1.25
S40	2.52	64.01	1.33	33.78	0.44	11.11	3/8-24
S41	3.48	88.39	2.32	58.93	0.63	15.88	1/2-20
S42	3.50	88.90	2.00	50.80	0.63	15.88	5/8-18
S43	2.75	69.85	1.25	31.75	0.63	15.88	5/8-18
S44	1.57	39.88	0.39	9.91	0.39	10.00	M10x1.25
S45	2.36	59.94	1.00	25.40	0.39	10.00	M10x1.25
S46	1.57	39.88	1.18	29.97	0.39	10.00	M10x1.25
S47	2.20	55.88	1.31	33.27	0.39	10.00	M10x1.25
S48	2.55	64.77	1.51	38.35	0.39	10.00	M10x1.25
S49	2.67	67.82	1.29	32.77	0.39	10.00	M10x1.25
S50	2.95	74.93	1.57	39.88	0.39	10.00	M10x1.25
S51	3.00	76.20	1.65	41.91	0.39	10.00	M10x1.25
S52	1.18	29.97	0.74	18.80	0.39	10.00	M10x1.5
S53	2.16	54.86	1.89	48.01	0.39	10.00	M10x1.5
S54	2.42	61.47	1.28	32.51	0.59	15.00	M10x1.5

"S" STUD MOUNTS CONT'D

MOUNTING CODE	DIMENSION						
	A		B		C		D
	(inches)	(mm)	(inches)	(mm)	(inches)	(mm)	(thread)
S55	2.51	63.75	1.39	35.31	0.39	10.00	M10x1.5
S56	2.67	67.82	1.53	38.86	0.43	11.00	M10x1.5
S57	2.95	74.93	1.40	35.56	0.42	10.72	M10x1.5
S58	2.98	75.69	1.68	42.67	0.39	10.00	M10x1.5
S59	2.98	75.69	1.68	42.67	0.47	12.00	M10x1.5
S60	3.46	87.88	1.96	49.78	0.56	14.29	M10x1.5
S61	3.11	78.99	1.45	36.83	0.55	14.00	M12x1.25
S62	3.24	82.30	1.70	43.18	0.56	14.29	M12x1.25
S63	3.54	89.92	2.24	56.90	0.67	17.00	M12x1.25
S64	2.36	59.94	1.18	29.97	0.47	12.00	M12x1.5
S65	2.89	73.41	1.65	41.91	0.47	12.00	M12x1.5
S66	1.39	35.31	0.15	3.81	0.47	12.00	M12x1.75
S67	2.40	60.96	1.53	38.86	0.56	14.29	M14x1.5
S68	2.95	74.93	1.45	36.83	0.63	15.88	M16x1.5
S69	1.32	33.53	1.37	34.80	0.61	15.48	M16x2
S70	1.88	47.75	0.90	22.86	0.44	11.11	M8x1.25
S71	1.42	36.07	0.71	18.03	0.39	10.00	M10x1.5
S72	1.88	47.63	0.58	14.73	0.43	11.00	M8x1.25
S73	3.13	79.50	1.52	38.50	0.47	12.00	M10x1
S74	2.66	67.50	1.24	31.50	0.39	10.00	M10x1
S75	1.57	40.00	0.47	12.00	0.39	10.00	M10x1.25
S76	3.41	86.66	1.67	42.42	0.43	10.80	M10x1
S77	2.21	56.13	0.39	9.91	0.39	9.89	M10x1
S78	2.76	70.00	1.57	40.00	0.47	12.00	M12x1.5
S79	2.93	74.30	2.02	51.31	0.39	10.00	M10x1.25
S80	1.18	30.00	0.39	10.01	0.47	12.00	M12x1.25
S81	2.80	71.12	1.53	38.89	0.47	12.00	M12x1.25
S82	3.70	94.00	1.54	39.00	0.39	10.00	M10x1.5
S83	3.17	80.52	2.14	54.36	0.39	10.00	M10x1.25
S84	1.18	30.00	0.20	5.00	0.47	12.00	M12x1.5
S85	3.35	85.00	1.85	47.00	0.43	11.00	M10x1
S86	2.90	73.66	1.65	41.91	0.39	10.00	M10x1.25
S87	3.21	81.53	2.09	53.06	0.39	10.00	M10x1.25
S88	2.55	64.64	1.30	33.02	0.47	12.00	M12x1.25
S89	3.35	85.09	2.18	55.25	0.39	10.00	M10x1.25
S90	3.08	78.23	2.00	50.70	0.39	10.00	M10x1.25
S91	1.20	30.50	0.79	20.00	0.39	10.00	M10x1.25
S92	1.42	35.99	0.63	16.00	0.41	10.50	M12x1.25
S93	3.15	80.01	1.93	49.02	0.39	10.00	M10x1.5
S94	2.83	72.00	1.77	45.00	0.39	10.00	M10x1
S95	2.52	64.00	1.34	34.00	0.47	12.00	M12x1.25
S96	2.56	65.00	0.98	25.00	0.39	10.00	M10x1.25
S97	1.50	38.00	0.51	13.00	0.47	12.00	M12x1.75
S98	2.72	69.00	1.34	34.00	0.47	12.00	M12x1.5
S99	3.07	78.00	1.61	41.00	0.47	12.00	M10x1
S100	1.89	48.00	1.38	35.00	0.47	12.00	M12x1.25
S101	1.77	45.00	1.22	31.00	0.39	10.00	M10x1.5
S102	2.72	69.20	1.18	30.00	0.55	14.00	M10x1.25
S103	1.50	38.00	0.59	15.00	0.55	14.00	M14x1.5
S104	0.98	25.00	0.08	2.00	0.47	12.00	M12x1.25
S105	2.19	55.50	1.02	26.00	0.55	14.00	M14x2
S106	1.54	39.00	1.22	31.00	0.55	14.00	M14x2
S107	2.36	60.00	1.30	33.00	0.67	17.00	M16x2
S108	1.69	43.00	1.46	37.00	0.87	22.00	M14x2
S109	1.93	49.00	0.63	16.00	0.55	14.00	M12x1.5
S110	1.10	28.00	0.08	2.00	0.87	22.00	M14x1.5
S111	2.72	69.09	1.26	32.00	0.87	22.00	M14x2
S112	2.73	69.27	1.47	37.21	0.87	22.00	M14x1.5
S113	3.30	83.82	0.20	5.08	0.87	22.00	M15x2.00
S114	1.38	35.00	0.01	0.35	0.87	22.00	M14x1.5
S115	3.96	100.48	1.47	37.26	0.79	20.00	M12x1.75
S116	1.71	43.51	0.85	21.49	0.87	22.00	M14x1.5
S117	1.16	29.36	0.84	21.34	0.79	20.00	M14x2
S118	2.08	52.76	1.78	45.26	0.79	20.00	M12x1.75
S118	3.40	86.36	3.15	80.01	0.87	22.00	M16x2
S119	2.95	74.93	1.38	35.00	0.98	25.00	M16x2
S120	2.05	52.00	1.10	28.00	0.47	12.00	M12x1.25
S121	1.46	37.00	1.34	34.00	0.87	22.00	M14x1.25
S122	3.05	77.50	1.26	32.00	0.63	16.00	M14x1.5

MOUNTING CODE "BP" EYE RING AND BUSHING WITH BAR PIN

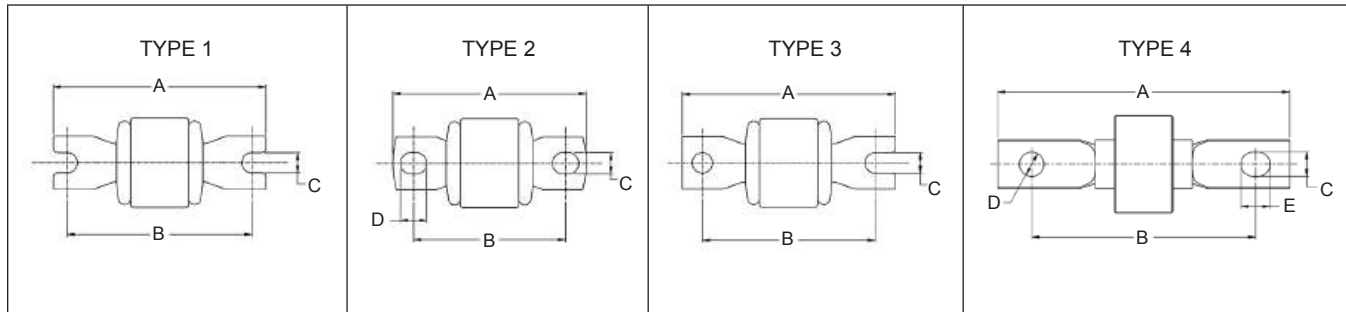

MOUNTING CODE	TYPE	DIMENSION									
		A		B		C		D		E	
		(inches)	(mm)	(inches)	(mm)	(inches)	(mm)	(inches)	(mm)	(inches)	(mm)
BP1	1	2.72	69.09	2.20	55.88	0.33	8.38	--	--	--	--
BP2	1	3.59	91.19	3.12	79.25	0.32	8.13	--	--	--	--
BP3	1	2.82	71.63	2.38	60.45	0.33	8.38	--	--	--	--
BP4	1	3.19	81.03	2.38	60.45	0.33	8.38	--	--	--	--
BP5	1	3.19	81.03	2.75	69.85	0.33	8.38	--	--	--	--
BP6	1	4.25	107.95	3.62	91.95	0.33	8.38	--	--	--	--
BP7	2	3.13	79.50	2.50	63.50	0.35	8.89	0.42	10.67	--	--
BP8	2	3.50	88.90	2.87	72.90	0.35	8.89	0.42	10.67	--	--
BP9	1	3.38	85.85	2.60	66.04	0.35	8.89	0.57	14.48	--	--
BP10	2	3.50	88.90	2.74	69.60	0.50	12.70	0.50	12.70	--	--
BP11	1	2.96	75.18	2.52	64.01	0.33	8.38	--	--	--	--
BP12	1	3.75	95.25	3.14	79.76	0.33	8.38	--	--	--	--
BP13	1	3.45	87.63	3.00	76.20	0.33	8.38	--	--	--	--
BP14	2	3.43	87.12	2.87	72.90	0.45	11.43	--	--	--	--
BP15	4	4.56	115.82	3.62	91.95	0.39	9.91	0.47	11.94	0.39	9.91
BP17	1	3.11	78.99	2.61	66.29	0.33	8.38	--	--	--	--
BP18	1	3.75	95.25	3.14	79.76	0.39	9.91	--	--	--	--
BP19	1	3.19	81.03	2.62	66.55	0.33	8.38	--	--	--	--
BP20	1	3.59	91.19	3.12	79.25	0.33	8.38	--	--	--	--
BP26	3	3.06	77.72	2.37	60.20	0.26	6.60	--	--	--	--
BP27	2	4.00	101.60	2.95	74.93	0.52	13.21	0.50	12.70	--	--
BP29	2	4.00	101.60	2.95	74.93	0.37	9.40	0.49	12.45	--	--
BP30	1	3.00	76.20	2.25	57.15	0.34	8.64	--	--	--	--
BP31	3	3.50	88.90	2.87	72.90	0.35	8.89	--	--	--	--
BP32	2	3.45	87.63	2.83	71.88	0.42	10.67	--	--	--	--
BP33	2	4.44	112.78	3.62	91.95	0.39	9.91	0.47	11.94	--	--
BP34	1	3.81	96.77	2.99	75.95	0.41	10.41	--	--	--	--
BP35	2	3.53	89.66	2.73	69.34	0.38	9.65	0.38	9.65	--	--
BP36	2	4.72	119.89	3.38	85.85	0.52	13.21	0.52	13.21	--	--
BP37	4	5.16	131.06	3.29	83.58	0.38	9.66	0.38	9.66	--	--
BP38	2	3.22	81.90	1.54	39.06	0.40	10.08	0.40	10.08	--	--
BP39	1	2.96	75.18	2.19	55.63	0.33	8.38	--	--	--	--

MOUNTING CODE "SP" SPECIAL MOUNTS

Part numbers with "SP" mounting codes are unique to the application.

Please reference the specific OE or Gabriel part for dimensions. If you have any further questions or concerns, contact the Gabriel® AnswerGarage® at 1.800.999.3903.

MOUNTING CODE "EB" EYE RING AND BUSHING

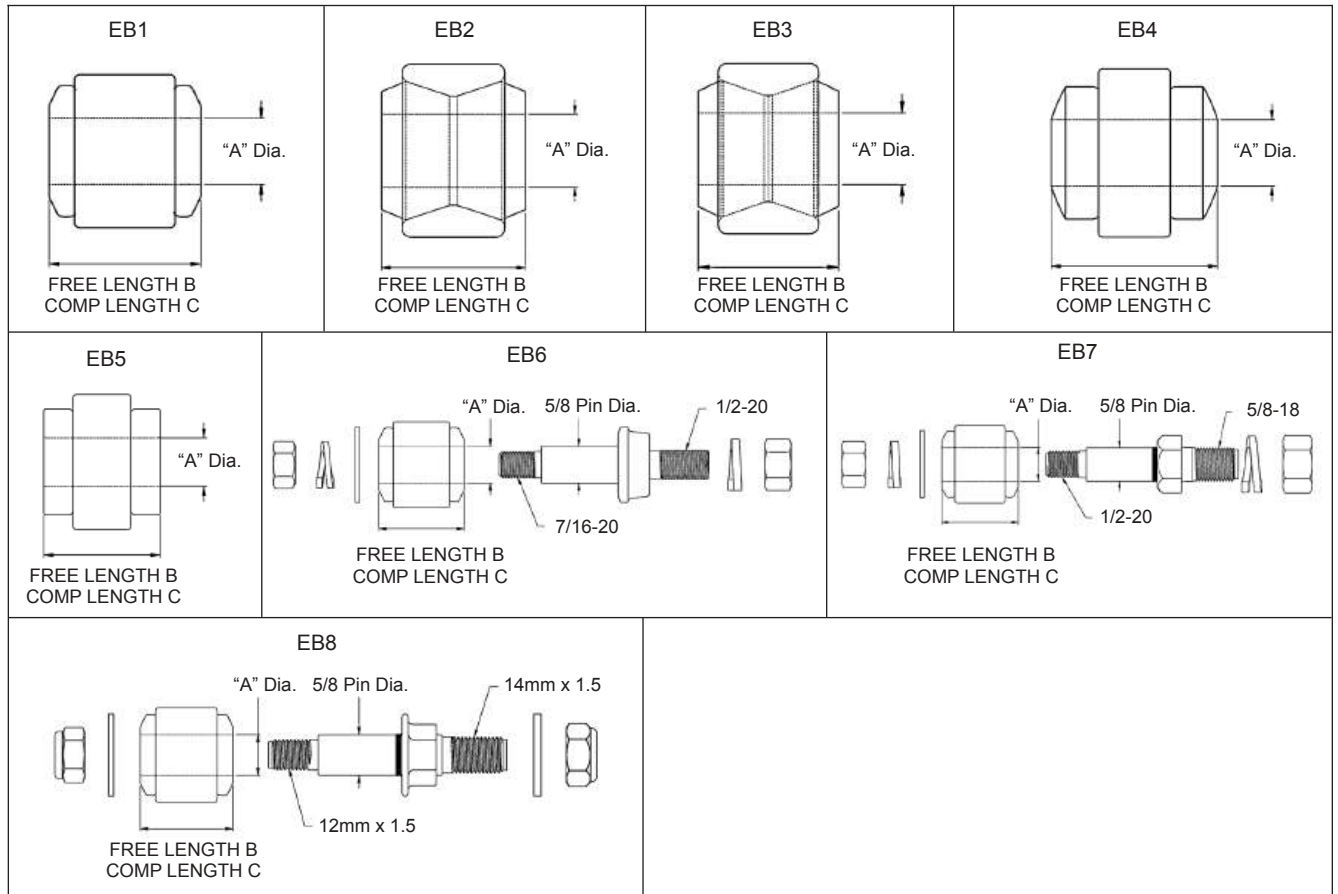

MOUNTING CODE	A DIAMETER	B FREE LENGTH	C COMP. LENGTH	VEHICLE MOUNTING PIN DIAMETER
EB1	5/8	1.44	1.31	5/8
EB2	3/4	1.75	1.50	3/4
EB3	1.00	1.91	1.75	1.00
EB4	11/16	1.72	1.55	11/16
EB5	5/8	1.51	1.25	5/8
EB6	5/8	1.44	1.31	Mounting pin furnished with shock absorber for 1/2 diameter vehicle mounting hole.
EB7	5/8	1.44	1.31	Mounting pin furnished with shock absorber for 5/8 diameter vehicle mounting hole.
EB8	5/8	1.44	1.31	Mounting pin furnished with shock absorber for 14MM diameter vehicle mounting hole.
EB9	1	1.75	--	1
EB10	1.00	1.00	--	1.00
EB11	3/8	0.83	--	3/8
EB12	10MM	1.18	--	10MM
EB13	12MM	1.03	--	12MM
EB14	15MM	1.41	--	15MM
EB15	15MM	1.76	--	15MM

MOUNTING CODE "EB" EYE RING AND BUSHING CONT'D

MOUNTING CODE	A DIAMETER	B FREE LENGTH	C COMP. LENGTH	VEHICLE MOUNTING PIN DIAMETER
EB16	16MM	1.5	--	16MM
EB17	17MM	1.18	--	17MM
EB18	19MM	1.65	--	19MM
EB19	20MM	1.75	1.25	20MM
EB20	45/64	1.05	--	45/64
EB21	45/64	1.39	--	45/64
EB22	20MM	1.575	--	20MM
EB23	24	1.654	--	24
EB24	20MM	1.693	--	20MM
EB25	22 MM	1.5	--	22 MM

MOUNTING CODE "CL" CLEVIS

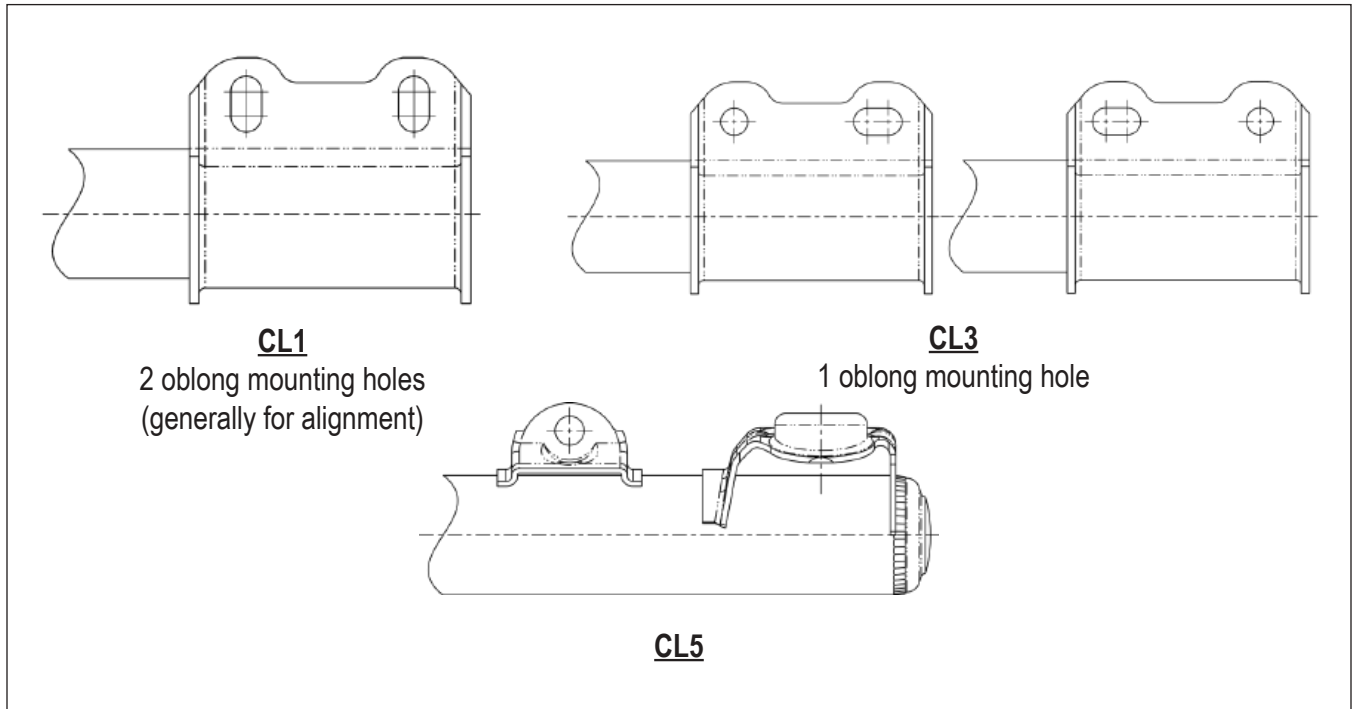

MOUNTING CODE "LP" PINCH SOCKET

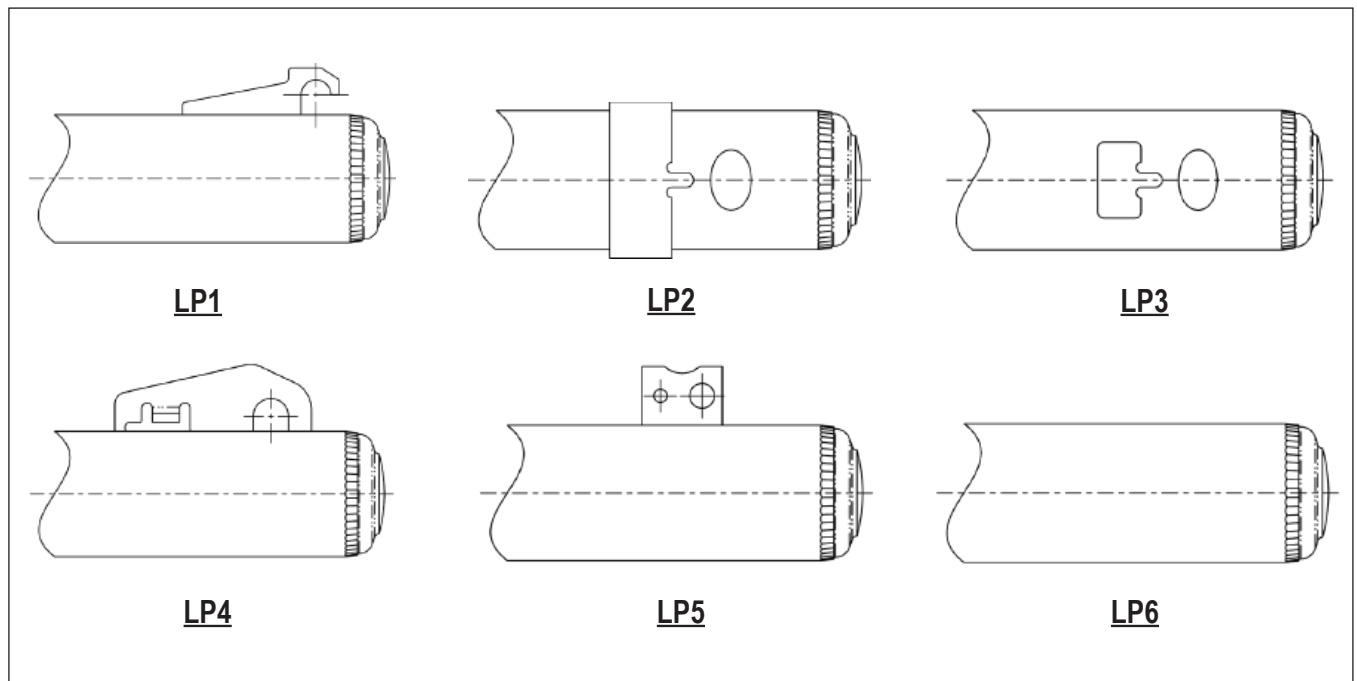

MOUNTING CODE "LU" U JOINT

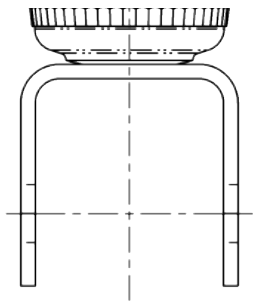

LU1

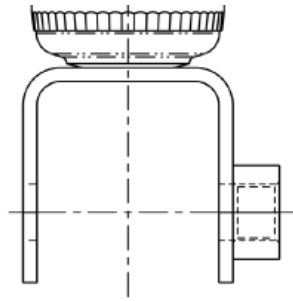
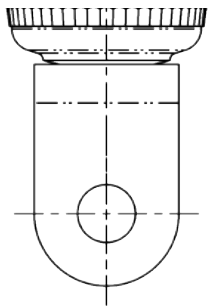

LU2

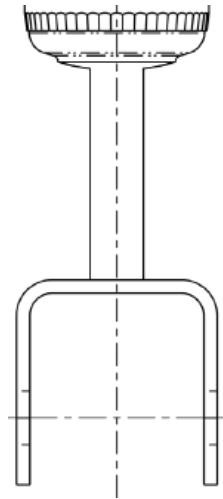
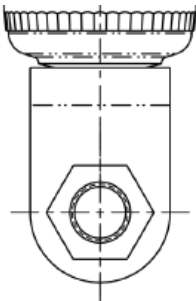

LU3

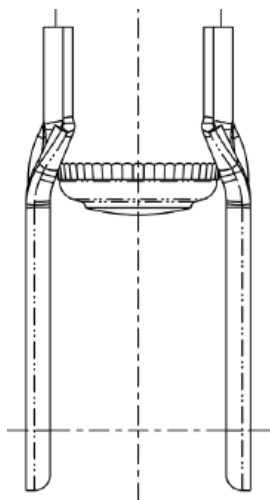
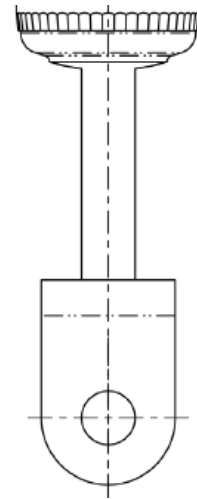

LU4

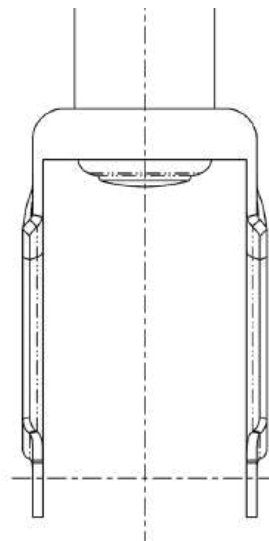
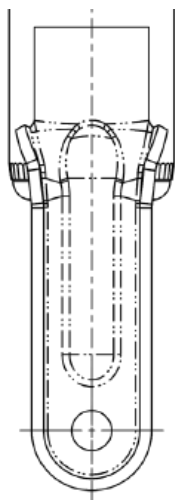

LU5

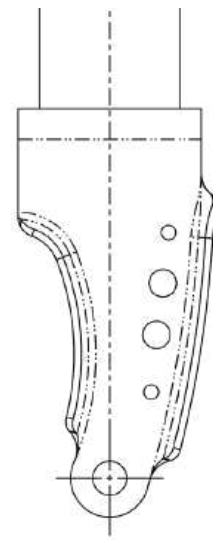

SPECIFICATIONS BY PART NUMBER

AXLE SHAFT DAMPER

CATALOG PART NO.	EXTENDED LENGTH	COLLAPSED LENGTH	STROKE	UPPER MTG CODE	LOWER MTG CODE
14039	15.73	12.12	3.51	ES41	ES41

CLASSIC SHOCK ABSORBERS

CATALOG PART NO.	EXTENDED LENGTH	COLLAPSED LENGTH	STROKE	UPPER MTG CODE	LOWER MTG CODE	CATALOG PART NO.	EXTENDED LENGTH	COLLAPSED LENGTH	STROKE	UPPER MTG CODE	LOWER MTG CODE
82001	15.98	10.37	5.61	ES17	ES17	82086	25.54	14.93	10.61	ES35	ES35
82003	18.55	11.44	7.11	ES24	ES24	82087	14.61	9.25	5.36	S1	BP20
82004	14.17	8.81	5.36	S17	S1	82090	16.11	10	6.11	S1	ES8
82005	17.2	12.44	4.76	S1	ES64	82099	14.09	9.06	5.11	S1	BP19
82007	18.23	11.37	6.86	EB1	EB1	82103	22.7	13.34	9.36	ES145	S1
82010	16.63	12.47	4.16	ES34	ES34	82104	14.2	9.44	4.76	BP19	DS1
82011	12.11	8	4.11	S1	ES11	82109	13.64	8.74	4.90	S1	ES32
82012	16.04	10.53	5.51	BP6	ES25	82110	14.1	8.99	5.11	S1	BP8
82025	12.95	9.19	3.76	S36	BP17	82118	15.24	10.16	5.25	S5	BP19
82026	13.42	8.56	4.86	S1	S1	82125	20.67	12.06	8.61	S8	S1
82032	22.73	13.87	8.86	ES64	ES64	82126	14.25	9.24	5.01	S36	DS1
82034	22.17	12.81	9.36	S1	S1	82128	11.2	8.19	3.01	S36	ES40
82035	14.64	9.53	5.11	ES24	EB1	82130	17.7	10.84	6.86	EB1	S36
82039	17.7	10.84	6.86	S1	EB1	82131	22.39	13.53	8.86	ES27	EB4
82040	21.7	12.84	8.86	S1	ES10	82138	15.1	9.49	5.61	S1	BP3
82047	20.23	12.37	7.86	EB1	EB1	82147	23.23	13.87	9.36	EB1	ES25
82051	22.14	13.28	8.86	BP8	EB1	82151	23.23	13.87	9.36	ES145	ES70
82060	23.23	13.87	9.36	EB1	EB1	82155	20.7	12.34	8.36	S1	EB1
82065	19.04	11.93	7.11	EB4	EB4	82156	20.23	12.37	7.86	EB1	EB1
82066	22.7	13.34	9.36	S1	EB1	82601	13.61	8.75	4.86	S1	ES16
82069	14.59	9.31	5.28	S1	S1	82602	23.23	13.87	9.36	BP8	EB1
82070	15.75	9.99	5.76	S1	DS1	82609	25.64	15.03	10.61	EB1	ES35
82072	11.61	7.75	3.86	S1	ES8	82615	15.69	10.43	5.26	EB4	BP11
82075	16.1	10.34	5.76	S1	BP10	82618	25.73	15.12	10.61	BP14	EB1
82076	18.7	11.34	7.36	ES66	S1						
82079	15.54	9.93	5.61	ES9	BP20						

FRONT LOAD CARRIERS

CATALOG PART NO.	EXTENDED LENGTH	COLLAPSED LENGTH	STROKE	UPPER MTG CODE	LOWER MTG CODE	CATALOG PART NO.	EXTENDED LENGTH	COLLAPSED LENGTH	STROKE	UPPER MTG CODE	LOWER MTG CODE
34036	14.16	9.53	4.63	EB1	ES24	34058	17.13	11.01	n/a	S12	ES3
34051	13.28	8.67	4.61	S1	BP30	34073	14.29	9.37	4.92	S1	BP7
34052	13.62	9	4.62	S1	BP13	34076	14.59	9.87	n/a	S36	EB1
34057	15.01	10.13	4.87	S12	E83						

SPECIFICATIONS BY PART NUMBER

GUARDIAN SHOCKS

CATALOG PART NO.	EXTENDED LENGTH	COLLAPSED LENGTH	STROKE	UPPER MTG CODE	LOWER MTG CODE	CATALOG PART NO.	EXTENDED LENGTH	COLLAPSED LENGTH	STROKE	UPPER MTG CODE	LOWER MTG CODE
81039	14.73	9.62	5.11	EB1	ES24	81667	26.95	16.19	10.76	BP14	ES34
81076	14.2	9.44	4.76	BP4	DS1	81668	14.32	9.56	4.76	S29	BP11
81082	23.23	13.87	9.36	EB1	ES83	81675	15.7	9.84	5.86	S1	EB1
81091	25.14	15.28	9.86	ES27	EB4	81676	17.73	11.12	6.61	EB1	EB1
81095	21.7	12.84	8.86	BP14	S1	81691	24.2	14.09	10.11	S1	ES25
81096	13.7	8.84	4.86	S1	BP13	81710	21.73	13.12	8.61	EB1	ES185
81113	18.23	11.37	6.86	ES31	ES24	81713	14.42	9.31	5.11	S29	BP7
81147	20.23	12.37	7.86	EB1	EB1	81726	16.48	10.87	5.61	ES126	ES128
81153	11.61	7.75	3.86	S1	ES38	81730	23.23	13.87	9.36	EB1	ES185
81164	23.23	13.87	9.36	EB1	ES34	81744	14.52	9.76	4.76	S36	EB1
81242	19.2	11.59	7.61	S1	ES25	81750	13.61	8.75	4.86	S1	BP30
81270	17.67	10.56	7.11	S1	S1	81794	19.85	14.19	5.66	S1	ES185
81318	22.73	13.87	8.86	EB1	EB1	81798	21.85	13.5	8.36	EB1	EB1
81340	20.7	12.34	8.36	S1	EB1	81821	23.23	13.87	9.36	ES83	ES83
81342	28.89	16.78	12.11	ES27	EB4	81825	21.1	12.99	8.11	EB4	EB4
81394	17.47	11.21	6.26	S36	ES25	81828	22.72	14.21	8.51	S36	ES83
81416	18.6	11.59	7.01	S9	EB1	81833	20.21	12.45	7.76	S36	ES83
81440	24.6	14.59	10.01	S17	EB1	81834	15.7	9.84	5.86	S1	BP13
81446	14.61	9.25	5.36	S1	BP7	81836	14.75	9.39	5.36	S1	ES83
81469	22.54	13.68	8.86	EB4	EB4	81837	26.28	15.42	10.86	BP13	ES27
81478	12.6	8.59	4.01	S1	ES64	81845	26.36	15.25	11.11	S1	ES1
81481	19.7	11.84	7.86	S1	EB1	81869	20.6	12.59	8.01	S1	BP7
81482	24.23	14.37	9.86	BP14	ES34	81870	13.86	9	4.86	S1	ES113
81484	20.23	12.37	7.86	EB1	ES25	81871	22.04	13.43	8.61	EB2	EB2
81490	14.85	9.84	5.01	S12	ES83	81872	14.95	9.59	5.36	S1	ES17
81491	13	8.74	4.26	S12	DS1	81873	24.74	14.88	9.86	ES34	ES34
81492	20.64	12.78	7.86	BP31	EB1	81878	17.73	11.12	6.61	ES18	ES18
81494	13.61	8.75	4.86	S1	BP30	81880	14.73	9.62	5.11	ES10	EB1
81495	20.2	12.34	7.86	S1	EB1	81890	25.28	14.92	10.36	BP14	ES83
81496	20.49	12.63	7.86	ES27	ES27	81891	21.09	13.33	7.76	EB5	ES24
81502	14.1	9.34	4.76	S1	BP4	81892	24.2	14.09	10.11	S12	ES171
81507	14.26	9.15	5.11	S1	ES17	81893	18.27	13.51	4.76	S36	BP7
81510	25.73	15.12	10.61	EB1	ES83	81904	18.46	11.7	6.76	S1	ES83
81514	22.14	13.28	8.86	BP31	EB1	81905	26.97	15.86	11.11	EB1	ES185
81516	16.73	10.62	6.11	ES26	ES26	81910	22.48	13.62	8.86	ES19	ES110
81540	25.73	15.12	10.61	EB1	ES106	81911	19.04	11.68	7.36	S1	ES153
81541	14.7	9.34	5.36	S1	BP14	81912	15.48	9.87	5.61	S62	BP7
81548	20.6	12.59	8.01	S1	BP7	81913	28.39	16.28	12.11	S12	ES171
81549	20.73	12.62	8.11	BP20	EB1	81914	15.48	9.87	5.61	S62	ES26
81553	15.2	9.59	5.61	S1	ES64	81916	13.72	9.46	4.26	S36	BP10
81556	24.7	14.34	10.36	S1	EB1	81917	23.03	13.92	9.11	EB1	ES83
81559	13.2	8.59	4.61	S1	BP7	81918	26.97	15.86	11.11	EB1	ES83
81560	23.14	13.78	9.36	BP13	ES27	81919	22.3	13.54	8.76	S38	ES34
81582	13.45	8.84	4.61	S1	BP4	81920	14.71	10.1	4.61	S12	BP11
81583	18.39	11.53	6.86	EB5	ES25	81921	26.76	15.67	11.09	ES34	ES34

SPECIFICATIONS BY PART NUMBER

GUARDIAN SHOCKS (CONT'D)

CATALOG PART NO.	EXTENDED LENGTH	COLLAPSED LENGTH	STROKE	UPPER MTG CODE	LOWER MTG CODE
81922	15.35	10.24	5.11	S12	LU1
81923	24.47	14.61	9.86	ES26	ES26
81924	20.78	12.67	8.11	ES83	ES83
81925	14.7	9.59	5.11	S12	ES7
81926	21.25	13.24	8.01	ES88	ES65
81928	13.78	9.52	4.26	S38	ES34
81929	19.49	12.13	7.36	BP20	ES24
81930	22.81	13.95	8.86	ES34	ES34

CATALOG PART NO.	EXTENDED LENGTH	COLLAPSED LENGTH	STROKE	UPPER MTG CODE	LOWER MTG CODE
81931	26.53	16.02	10.51	ES34	ES34
81932	15.87	10.51	5.36	S38	ES34
81933	13.97	9.11	4.86	S29	BP13
81934	26.14	16.45	9.69	S20	ES84
81935	24.19	15.93	8.26	S70	ES41
81936	20.3	12.19	8.11	S12	BP11
81937	21.44	13.18	8.26	S47	EB1

GUARDIAN STRUT

CATALOG PART NO.	EXTENDED LENGTH	COLLAPSED LENGTH	STROKE	UPPER MTG CODE	LOWER MTG CODE
M55693	24.59	15.59	9	S95	LP1
M55697	19.7	13.19	6.51	S103	CL1
M55786	24.75	16.50	8.25	n/a	n/a
M55802	15.31	10.37	4.94	S102	LP2
M55848	20.16	11.87	8.30	S32	CL1
M55871	25.31	16.56	8.75	S86	ES199
M55877	15.24	10.55	4.7	S86	LP3
M55892	20.19	14.09	6.9	S117	CL1
M55896	20.2	14.1	6.10	S117	CL1
M55901	20.41	13.65	6.76	S111	LP4
M55912	19.32	12.31	7.02	S104	CL1
M55913	19.32	12.31	7.02	S104	CL1
M55920	16.87	11.13	5.74	S100	CL1
M55921	16.87	11.13	5.74	S100	CL1

CATALOG PART NO.	EXTENDED LENGTH	COLLAPSED LENGTH	STROKE	UPPER MTG CODE	LOWER MTG CODE
M55974	18.01	11.14	6.88	S108	CL1
M56501	20.18	12.01	8.18	S111	CL1
M56502	17.22	10.54	6.68	n/a	n/a
M56622	19.12	13.00	6.12	S120	CL1
M56708	21.85	13.86	7.92	n/a	n/a
M56718	20.91	13.82	7.57	S69	CL1

SPECIFICATIONS BY PART NUMBER

HIJACKERS

CATALOG PART NO.	EXTENDED LENGTH	COLLAPSED LENGTH	STROKE	UPPER MTG CODE	LOWER MTG CODE	CATALOG PART NO.	EXTENDED LENGTH	COLLAPSED LENGTH	STROKE	UPPER MTG CODE	LOWER MTG CODE
49105	18.21	11.23	6.98	S1	S1	49223	23.27	14.29	8.98	EB1	ES83
49106	22.43	13.95	8.48	ES26	EB4	49226	20.77	13.04	7.73	BP20	EB1
49107	19.27	12.29	6.98	ES24	ES24	49228	24.47	14.74	9.73	S15	BP14
49110	22.08	13.85	8.23	EB4	EB4	49230	20.27	12.79	7.48	ES83	ES83
49122	21.62	13.14	8.48	S1	ES10	49231	24.27	14.79	9.48	BP14	ES34
49127	19.87	12.63	7.24	EB1	ES25	49232	25.09	15.16	9.93	BP14	ES83
49128	22.77	14.04	8.73	BP14	EB1	49233	15.67	10.79	4.88	ES69	ES69
49131	22.15	13.67	8.48	BP31	EB1	49234	19.77	13.98	5.79	S1	ES83
49135	21.62	13.14	8.48	BP14	S1	49235	24.77	15.04	9.73	ES34	ES34
49149	24.93	15.64	9.29	ES27	EB4	49236	17.77	11.54	6.23	ES18	ES18
49152	20.27	13.04	7.23	BP31	EB1	49237	24.18	14.45	9.73	S12	ES171
49155	23.27	14.29	8.98	EB1	ES34	49254	17.86	12.45	5.41	S69	ES15
49157	21.37	13.29	8.08	BP14	EB1	49255	24.54	14.66	9.87	S15	BP31
49162	20.02	12.79	7.23	ES24	ES24	49304	14.35	9.75	4.60	ES10	EB1
49173	19.24	12.01	7.23	S1	ES25	49307	16.35	10.75	5.60	ES17	ES17
49178	23.12	13.89	9.23	S1	ES25	49310	20.35	12.75	7.60	EB1	EB1
49203	20.24	12.51	7.73	S1	EB1	49311	22.44	14	8.44	EB1	EB1
49205	21.12	13.13	7.99	S1	EB1	49334	20.7	13.05	7.65	BP31	EB1
49212	21.02	13.29	7.73	ES27	ES27	49369	21.86	13.51	8.35	ES84	ES84
49213	24.27	14.79	9.48	BP14	ES34	49387	21.14	13.03	8.11	S12	EB2
49215	23.02	14.16	8.86	ES18	ES18	49388	21.79	13.39	8.40	S12	EB2
49218	26.34	16.36	9.98	BP14	ES34						
49221	18.36	11.88	6.48	ES141	ES25						

LTV SEVERE DUTY

CATALOG PART NO.	EXTENDED LENGTH	COLLAPSED LENGTH	STROKE	UPPER MTG CODE	LOWER MTG CODE	CATALOG PART NO.	EXTENDED LENGTH	COLLAPSED LENGTH	STROKE	UPPER MTG CODE	LOWER MTG CODE
58357	14.68	10.06	4.62	ES24	ES24	58662	24.68	15.36	9.32	ES34	ES34
58359	13.92	9.14	4.78	S1	BP13	58714	15.26	9.98	5.28	S62	BP7
58403	24.48	14.95	9.53	ES26	ES26	58803	15.24	10.37	4.87	S12	LU1
58412	26.68	16.18	10.50	ES34	ES34	58807	15.24	10.11	5.13	S36	EB1
58421	13.42	8.89	4.53	S1	BP30	58808	28.38	16.75	11.63	EB1	ES83
58422	23.87	14.49	9.38	BP14	ES34	58809	23.65	14.53	9.12	EB1	ES83
58423	16.45	10.67	5.78	ES26	ES26	58810	31.42	18.42	13.00	EB1	ES83
58488	26.69	16.02	10.63	BP14	ES34	58817	15.59	10.96	4.63	S12	ES60
58489	14.64	9.61	5.03	S29	BP11	58901	16.49	10.87	5.62	ES126	ES34
58609	16.49	11.05	5.44	ES126	ES45	58929	14.54	9.76	4.78	S36	EB1
58622	15.04	10.16	4.88	S36	EB1	58930	22.81	14.06	8.75	ES34	ES34
58623	22.54	13.91	8.63	S36	ES83	58944	20.73	13.35	7.38	S62	ES204
58638	23.87	14.49	9.38	BP14	ES34						

SPECIFICATIONS BY PART NUMBER

MAXCONTROL

CATALOG PART NO.	EXTENDED LENGTH	COLLAPSED LENGTH	STROKE	UPPER MTG CODE	LOWER MTG CODE	CATALOG PART NO.	EXTENDED LENGTH	COLLAPSED LENGTH	STROKE	UPPER MTG CODE	LOWER MTG CODE
75676	19.66	11.83	7.83	S1	EB1	77803	15.31	10.32	4.99	S29	LU1
77375	14.14	9.04	5.10	S12	BP7	77807	15.33	10.34	4.99	S36	EB1
77403	24.31	14.78	9.53	ES26	ES26	77808	28.73	16.92	11.81	EB1	ES83
77412	26.77	16.26	10.51	ES34	ES34	77809	22.92	13.9	9.02	EB1	ES83
77414	15.33	10.34	4.99	S36	ES83	77810	31.53	18.5	13.03	EB1	ES83
77422	23.92	14.39	9.53	BP14	ES34	77815	21.97	13.2	8.77	S47	ES64
77423	16.8	10.83	5.97	ES128	ES128	77817	15.73	10.94	4.79	S12	ES60
77425	19.87	12.23	7.64	EB1	BP20	77829	22.33	13.6	8.73	ES88	ES65
77454	22.77	14	8.77	ES141	ES141	77837	28.73	16.92	11.81	BP14	ES83
77455	22.92	13.9	9.02	ES83	ES83	77847	20.34	12.59	7.75	S1	BP7
77461	25.39	15.18	10.21	EB1	ES83	77905	14.64	9.33	5.31	S1	ES83
77479	14.14	9.04	5.10	S1	ES113	77907	19.87	12.23	7.64	EB1	EB1
77488	26.77	16.26	10.51	BP14	ES34	77909	14.14	9.04	5.10	S1	ES17
77489	14.36	9.55	4.81	S29	BP11	77915	13.61	8.85	4.76	S1	BP7
77494	21.78	13.52	8.26	EB2	EB2	77947	15.63	10.88	4.75	S38	ES34
77524	26.87	15.87	11.00	EB1	ES83	77948	23.5	14.75	8.75	S38	ES34
77525	22.9	14	8.90	EB1	ES83	77949	16.16	10.67	5.49	S38	BP27
77607	25.39	15.18	10.21	BP14	ES83	77950	27.5	17.5	10.00	ES34	ES34
77608	14.45	9.64	4.81	S36	EB1	77951	20.5	13	7.50	S38	ES34
77609	16.43	10.95	5.48	ES126	ES128	77952	29.68	17.43	12.25	EB1	ES83
77614	15.04	10.05	4.99	S36	EB1	77953	22.65	13.9	8.75	ES34	ES34
77623	22.38	13.84	8.54	S38	ES83	77954	13.83	9.08	4.75	S29	BP13
77638	24.31	14.78	9.53	BP14	ES34	77967	20.75	13.13	7.62	S62	ES34
77661	13.72	9.5	4.22	S12	ES34	77968	24.71	15.09	9.62	EB1	ES83
77662	24.31	14.78	9.53	ES34	ES34	77969	25.43	15.81	9.62	EB1	ES83
77673	22.38	13.84	8.54	S38	ES34	77971	23.64	14.70	8.94	ES45	ES47
77674	23.27	14.27	9.00	S38	ES34	77973	22.57	14.41	8.16	BP12	ES207
77675	26.25	15.74	10.51	ES34	ES34	77975	23.98	15.69	8.34	ES34	ES34
77678	18.01	13.51	4.50	S36	BP7	77976	24.84	16.07	8.76	ES34	ES34
77679	24.9	14.88	10.02	BP14	ES83	77978	20.26	12.39	7.87	S10	BP39
77683	21.11	13.27	7.84	EB5	ES24	77980	23	14.39	8.61	S38	ES204
77714	15.34	9.84	5.50	S38	BP7	77981	21.77	13.65	8.12	S57	ES26
77715	28.32	16.33	11.99	S12	ES171	77983	24.08	15.23	8.85	BP8	ES204
77716	15.32	9.84	5.48	S38	ES26	77986	31.01	18.65	12.36	EB1	ES48
77717	22.92	13.9	9.02	ES25	ES25	77987	27.24	16.38	10.86	EB1	ES48
77726	20.85	13.05	7.80	S12	EB19	77988	30.12	17.97	12.14	EB1	ES56
77772	14.51	9.72	4.79	S36	BP10						
77783	14.64	10.12	4.52	S12	BP11						

SPECIFICATIONS BY PART NUMBER

PROGUARD

CATALOG PART NO.	EXTENDED LENGTH	COLLAPSED LENGTH	STROKE	UPPER MTG CODE	LOWER MTG CODE	CATALOG PART NO.	EXTENDED LENGTH	COLLAPSED LENGTH	STROKE	UPPER MTG CODE	LOWER MTG CODE
61500	20.23	12.37	7.86	EB1	EB1	61590	25.48	15.2	10.28	BP14	ES83
61501	12.6	8.59	4.01	S1	ES64	61591	14.47	9.71	4.76	S36	EB1
61504	13.7	8.92	4.78	S1	BP30	61592	21.45	13.17	8.28	S47	EB1
61506	21.86	13.58	8.28	EB1	EB1	61593	14.95	9.67	5.28	S1	ES64
61508	14.11	9	5.11	S1	ES17	61595	20.07	12.54	7.53	S36	ES83
61509	14.7	9.34	5.36	S1	BP14	61599	13.8	9.52	4.28	S38	ES34
61510	22.29	13.76	8.53	EB2	EB2	61600	24.51	14.98	9.53	ES34	ES34
61512	13.2	8.59	4.61	S1	BP7	61601	14.71	9.49	5.22	S1	ES83
61516	18.23	11.37	6.86	ES31	ES24	61605	17.98	11.45	6.53	ES18	ES18
61517	14.98	9.95	5.03	ES24	ES24	61606	14.7	9.34	5.36	S1	BP19
61518	18.73	11.7	7.03	S1	ES25	61608	19.64	12.36	7.28	ES99	ES48
61519	19.98	12.45	7.53	EB1	ES25	61611	15.48	9.95	5.53	S62	BP7
61520	15.34	10.31	5.03	S36	ES41	61612	28.39	16.36	12.03	S12	ES171
61521	16.45	10.67	5.78	S12	ES25	61613	15.48	9.95	5.53	S62	ES26
61522	20.49	12.63	7.86	ES27	ES27	61614	22.98	13.95	9.03	ES41	ES41
61523	13.7	8.92	4.78	S1	BP13	61615	20.3	12.27	8.03	S12	BP11
61524	23.26	14.23	9.03	EB1	ES34	61616	19.39	12.23	7.16	BP20	ES24
61525	15.01	9.95	5.06	EB1	ES24	61623	18.04	13.51	4.53	S36	BP7
61528	23.98	14.45	9.53	BP14	ES34	61624	24.98	14.95	10.03	BP14	ES83
61529	14.1	9.34	4.76	S1	BP4	61625	15.48	10.45	5.03	ES69	ES69
61530	25.48	15.2	10.28	EB1	ES83	61626	13.73	9.45	4.28	S36	BP10
61531	16.73	10.7	6.03	ES26	ES26	61627	22.98	13.95	9.03	EB1	ES83
61533	22.98	13.95	9.03	EB1	ES106	61629	26.98	15.95	11.03	EB1	ES83
61535	20.45	12.67	7.78	S1	BP7	61632	20.79	13.01	7.78	EB4	EB4
61536	19.98	12.45	7.53	BP20	EB1	61634	22.3	13.77	8.53	S38	ES34
61539	22.79	14.01	8.78	ES141	ES141	61635	23.27	14.24	9.03	S38	ES34
61541	18.14	11.61	6.53	EB5	ES25	61638	24.45	14.42	10.03	S12	ES171
61542	16.73	10.95	5.78	ES126	ES128	61641	14.7	10.17	4.53	S12	BP11
61543	26.76	16.23	10.53	BP14	ES34	61642	26.76	15.98	10.78	ES34	ES34
61544	14.54	9.75	4.79	S29	BP11	61643	15.36	10.33	5.03	S12	LU1
61546	18.45	11.67	6.78	S1	EB1	61646	22.57	14.29	8.28	S36	ES83
61547	23.01	14.07	8.94	EB1	ES83	61651	24.4	14.64	9.76	S47	EB1
61550	17.73	11.12	6.61	EB1	EB1	61654	28.76	16.98	11.78	EB1	ES83
61552	13.95	9.17	4.78	S1	ES113	61655	23.01	14.07	8.94	ES185	ES185
61554	21.48	13.2	8.28	EB1	ES83	61656	31.51	18.48	13.03	ES185	ES185
61555	14.14	9.11	5.03	S12	BP7	61658	24.48	14.7	9.78	ES26	ES26
61556	14.2	9.09	5.11	S1	BP7	61659	20.76	12.98	7.78	EB1	ES83
61560	18.45	11.67	6.78	S1	ES83	61662	12.23	8.45	3.78	S47	ES17
61561	15.09	10.06	5.03	S36	EB1	61663	15.7	10.92	4.78	S12	ES60
61565	24.26	14.73	9.53	BP14	ES34	61664	20.45	12.67	7.78	S1	BP7
61573	26.98	15.95	11.03	EB1	ES185	61675	22.81	14.12	8.69	ES34	ES34
61575	21.14	13.36	7.78	EB5	ES24	61676	21.25	13.31	7.94	ES88	ES65
61582	24.98	14.95	10.03	EB1	EB1	61679	14.71	9.49	5.22	S1	ES25
61584	25.48	15.2	10.28	BP13	ES26	61680	20.83	13.39	7.44	S38	ES34

SPECIFICATIONS BY PART NUMBER

PROGUARD (CONT'D)

CATALOG PART NO.	EXTENDED LENGTH	COLLAPSED LENGTH	STROKE	UPPER MTG CODE	LOWER MTG CODE
61682	31.36	18.67	12.69	EB1	ES83
61683	15.07	10.44	4.63	S11	LU1
61684	12.82	8.88	3.94	S11	BP9
61685	14.12	9.68	4.44	S11	BP9
61687	23.87	14.68	9.19	BP14	ES34
61690	24.78	15.84	8.94	ES34	ES34
61691	26.51	16.12	10.39	ES34	ES34
61692	26.05	15.87	10.18	ES34	ES34
61696	22.45	14.5	7.95	BP18	ES26
61697	22.62	14.43	8.19	BP18	ES26
61699	19.41	12.65	6.76	EB2	EB2
61700	20.37	13.11	7.26	EB2	EB2
61703	20.15	13.96	6.19	ES83	ES83

CATALOG PART NO.	EXTENDED LENGTH	COLLAPSED LENGTH	STROKE	UPPER MTG CODE	LOWER MTG CODE
61704	16.84	11.28	5.56	ES69	ES69
61710	27.58	17.14	10.44	ES34	ES34
61711	21.8	13.61	8.19	S57	ES26
61712	23.3	14.26	9.04	S38	ES34
61713	26.94	16	10.94	EB1	ES83
61714	23.36	14.22	9.14	S62	ES34
61715	24.12	15.18	8.94	ES88	ES69
61716	26.5	16.33	10.17	ES34	ES34
61717	22.75	14.56	8.19	ES45	ES47
61718	21.33	13.64	7.69	ES45	ES45
61720	15.92	11.23	4.69	ES17	ES19
61734	23.97	15.27	8.69	ES87	ES87
61777	15.62	10.68	4.94	ES164	ES68

REAR LOAD CARRIERS

CATALOG PART NO.	EXTENDED LENGTH	COLLAPSED LENGTH	STROKE	UPPER MTG CODE	LOWER MTG CODE
43048	20.45	12.62	7.83	EB1	EB1
43049	21.86	13.28	8.58	BP31	EB1
43058	19.95	12.37	7.58	EB1	ES25
43060	20.2	12.55	7.65	BP31	EB1
43085	20.61	12.78	n/a	EB4	ES27
43099	19.17	11.77	7.40	S1	ES25
43111	22.9	13.82	9.08	EB7	ES34

CATALOG PART NO.	EXTENDED LENGTH	COLLAPSED LENGTH	STROKE	UPPER MTG CODE	LOWER MTG CODE
43140	20.92	12.84	8.08	S1	EB1
43162	22.99	14.38	8.61	BP14	ES34
43163	25.05	15.69	9.36	BP14	ES34
43167	22.99	13.88	9.11	EB1	ES83
43171	24.74	15.38	9.36	BP14	ES83
43180	23.55	14.19	9.36	BP8	ES34
43181	24.24	14.88	9.36	ES34	ES34

STEERING DAMPERS

CATALOG PART NO.	EXTENDED LENGTH	COLLAPSED LENGTH	STROKE	UPPER MTG CODE	LOWER MTG CODE
14004	17.48	11.28	6.20	S71	ES60
14005	17.32	11.73	5.59	S54	ES60
14011	20.67	12.06	8.61	S1	EB1
14017	24.04	14.43	9.61	EB1	EB1
14018	21.37	12.8	8.57	ES35	EB1
14021	21.25	13.39	7.86	S1	EB1
14022	21.28	12.92	8.36	EB1	EB1

CATALOG PART NO.	EXTENDED LENGTH	COLLAPSED LENGTH	STROKE	UPPER MTG CODE	LOWER MTG CODE
14024	26.53	16.17	10.36	EB1	ES17
14033	24.14	14.28	9.86	ES109	ES17
14040	19.73	12.12	7.61	EB1	ES24
14071	20.7	12.79	7.91	ES53	ES65
14072	28.22	16.49	11.73	ES83	EB18
14074	20.62	13.30	7.32	ES65	ES65
14501	21.78	13.42	8.36	EB1	EB1

STEERING STABILIZERS

CATALOG PART NO.	EXTENDED LENGTH	COLLAPSED LENGTH	STROKE	UPPER MTG CODE	LOWER MTG CODE
6801SE	19.33	12.16	7.17	EB1	EB1
6802SE	20.02	12.11	7.91	S1	S1
6803SE	22.52	13.36	9.16	S1	S1
6804SE	24.08	14.67	9.41	EB1	EB1
6828SE	21.23	12.87	8.36	EB1	EB1
6847SE	23	13.83	9.17	EB1	ES65

CATALOG PART NO.	EXTENDED LENGTH	COLLAPSED LENGTH	STROKE	UPPER MTG CODE	LOWER MTG CODE
6850SE	23.3	13.77	9.53	EB1	S1
6853SE	19.33	12.05	7.28	EB1	ES24
6854SE	23.03	14.27	8.76	EB1	EB1
6855SE	23.83	14.3	9.53	EB1	EB1
6856SE	27.3	15.77	11.53	S1	EB1
6861SE	20.27	11.99	8.28	S1	S1

SPECIFICATIONS BY PART NUMBER

STRUT CUSHION

CATALOG PART NO.	EXTENDED LENGTH	COLLAPSED LENGTH	STROKE	UPPER MTG CODE	LOWER MTG CODE
143057	n/a	n/a	n/a	n/a	n/a
143058	n/a	n/a	n/a	n/a	n/a
143059	n/a	n/a	n/a	n/a	n/a

CATALOG PART NO.	EXTENDED LENGTH	COLLAPSED LENGTH	STROKE	UPPER MTG CODE	LOWER MTG CODE
143061	n/a	n/a	n/a	n/a	n/a
143063	n/a	n/a	n/a	n/a	n/a
143064	n/a	n/a	n/a	n/a	n/a

SUSPENSION MOUNTS

CATALOG PART NO.	EXTENDED LENGTH	COLLAPSED LENGTH	STROKE	UPPER MTG CODE	LOWER MTG CODE
142135	n/a	n/a	n/a	TM02S	n/a
142173	n/a	n/a	n/a	TMC0	n/a
142195	n/a	n/a	n/a	TMC0	n/a
142230	n/a	n/a	n/a	n/a	n/a
142245	n/a	n/a	n/a	TMC3S	n/a
142249	n/a	n/a	n/a	TMT3S	n/a
142251	n/a	n/a	n/a	TMC0	n/a
142252	n/a	n/a	n/a	n/a	n/a
142329	n/a	n/a	n/a	TMO2S	n/a
142402	n/a	n/a	n/a	TMU2B	n/a
142419	n/a	n/a	n/a	n/a	n/a
142444	n/a	n/a	n/a	TMC0	n/a
142526	n/a	n/a	n/a	TMT3S	n/a
142530	n/a	n/a	n/a	TMT3S	n/a
142546	n/a	n/a	n/a	TMT3S	n/a
142547	n/a	n/a	n/a	n/a	n/a
142556	n/a	n/a	n/a	TMC0	n/a
142561	n/a	n/a	n/a	TMC3S	n/a
142569	n/a	n/a	n/a	TMC4S	n/a
142625	n/a	n/a	n/a	TMT3S	n/a
142649	n/a	n/a	n/a	TMC3S	n/a
142650	n/a	n/a	n/a	TMT3S	n/a
142651	n/a	n/a	n/a	TMC0	n/a
142653	n/a	n/a	n/a	n/a	n/a
142746	n/a	n/a	n/a	TMC0	n/a
142747	n/a	n/a	n/a	TMC0	n/a
142755	n/a	n/a	n/a	TMC0	n/a
142828	n/a	n/a	n/a	TMC3S	n/a
142836	n/a	n/a	n/a	TMC3S	n/a
142843	n/a	n/a	n/a	TMCO	n/a
142850	n/a	n/a	n/a	TMT3S	n/a
142852	n/a	n/a	n/a	TMS4S	n/a
142930	n/a	n/a	n/a	TMT3S	n/a
142932	n/a	n/a	n/a	TMT3S	n/a
142933	n/a	n/a	n/a	TMT3S	n/a
142937	n/a	n/a	n/a	TMT3S	n/a
142938	n/a	n/a	n/a	TMT3S	n/a
143030	n/a	n/a	n/a	n/a	n/a

CATALOG PART NO.	EXTENDED LENGTH	COLLAPSED LENGTH	STROKE	UPPER MTG CODE	LOWER MTG CODE
143071	N/A	N/A	N/A	TMU3S	N/A
143072	N/A	N/A	N/A	TMU3S	N/A
143073	n/a	n/a	n/a	TMU3S	n/a
143074	n/a	n/a	n/a	TMU3S	n/a
143082	n/a	n/a	n/a	TMC3S	n/a
143087	n/a	n/a	n/a	TMT3S	n/a
143088	n/a	n/a	n/a	TMT3S	n/a
143089	n/a	n/a	n/a	TMC4B	n/a
143094	n/a	n/a	n/a	TMC0	n/a
143191	n/a	n/a	n/a	TMU3S	n/a
143194	n/a	n/a	n/a	TMT3S	n/a
143197	n/a	n/a	n/a	TMC3S	n/a
143201	n/a	n/a	n/a	TMT3S	n/a
143202	n/a	n/a	n/a	TMT3S	n/a
143204	n/a	n/a	n/a	TMT3S	n/a
143209	n/a	n/a	n/a	TMO2S	n/a
143218	n/a	n/a	n/a	TMS4S	n/a
143227	n/a	n/a	n/a	TMO2S	n/a
143239	n/a	n/a	n/a	TMC0	n/a
143244	n/a	n/a	n/a	TMC3S	n/a
143256	n/a	n/a	n/a	TMC-2S1B	n/a
143277	n/a	n/a	n/a	TMT3S	n/a
143281	n/a	n/a	n/a	TMT3S	n/a
143305	n/a	n/a	n/a	TMT3S	n/a
143315	n/a	n/a	n/a	TMT3S	n/a
143316	n/a	n/a	n/a	TMC3S	n/a
143317	n/a	n/a	n/a	TMC3S	n/a
143318	n/a	n/a	n/a	TMC3S	n/a
143319	n/a	n/a	n/a	TMC3S	n/a
143320	n/a	n/a	n/a	TMR2S	n/a
143321	n/a	n/a	n/a	TMO2S	n/a
143323	n/a	n/a	n/a	TMU3S	n/a
143324	n/a	n/a	n/a	TMT3S	n/a
143325	n/a	n/a	n/a	TMC3S	n/a
143335	n/a	n/a	n/a	TMO2S	n/a
143336	n/a	n/a	n/a	TMT3S	n/a
143339	n/a	n/a	n/a	TMC4S	n/a

SPECIFICATIONS BY PART NUMBER

SUSPENSION MOUNTS (CONT'D)

CATALOG PART NO.	EXTENDED LENGTH	COLLAPSED LENGTH	STROKE	UPPER MTG CODE	LOWER MTG CODE
143340	n/a	n/a	n/a	n/a	n/a
143341	n/a	n/a	n/a	TMC4S	n/a
143342	n/a	n/a	n/a	TMC3S	n/a
143344	n/a	n/a	n/a	TMC3S	n/a
143345	n/a	n/a	n/a	TMU2S	n/a
143346	n/a	n/a	n/a	TMT3S	n/a
143349	n/a	n/a	n/a	TMC0	n/a
143353	n/a	n/a	n/a	TMT3S	n/a
143354	n/a	n/a	n/a	TMC3S	n/a
143355	n/a	n/a	n/a	TMC3S	n/a
143357	n/a	n/a	n/a	n/a	n/a
143359	n/a	n/a	n/a	n/a	n/a
143360	n/a	n/a	n/a	TMC3S	n/a
143361	n/a	n/a	n/a	TMC3S	n/a
143363	n/a	n/a	n/a	TMC3B	n/a
143364	n/a	n/a	n/a	TMU4S	n/a
143365	n/a	n/a	n/a	TMT3B	n/a
143366	n/a	n/a	n/a	TMR3S	n/a
143367	n/a	n/a	n/a	TMT3S	n/a
143369	n/a	n/a	n/a	TMC3S	n/a
143380	n/a	n/a	n/a	TMO2B	n/a
143385	n/a	n/a	n/a	TMT3S	n/a
143387	n/a	n/a	n/a	TMT3S	n/a
143388	n/a	n/a	n/a	TMT3S	n/a
143390	n/a	n/a	n/a	TMR4B	n/a
143391	n/a	n/a	n/a	TMR4B	n/a
143394	n/a	n/a	n/a	n/a	n/a
143396	n/a	n/a	n/a	TMO2S	n/a
143397	n/a	n/a	n/a	TMT3S	n/a
143398	n/a	n/a	n/a	TMT3S	n/a
143401	n/a	n/a	n/a	TMT3S	n/a
143404	n/a	n/a	n/a	TMT3S	n/a
143405	n/a	n/a	n/a	n/a	n/a
143406	n/a	n/a	n/a	TMT3S	n/a

CATALOG PART NO.	EXTENDED LENGTH	COLLAPSED LENGTH	STROKE	UPPER MTG CODE	LOWER MTG CODE
143408	n/a	n/a	n/a	n/a	n/a
143409	n/a	n/a	n/a	TMT3S	n/a
143410	n/a	n/a	n/a	TMT3S	n/a
143412	n/a	n/a	n/a	n/a	n/a
143415	n/a	n/a	n/a	TMC4S	n/a
143416	n/a	n/a	n/a	TMT3S	n/a
143418	n/a	n/a	n/a	TMC3B	n/a
143419	n/a	n/a	n/a	n/a	n/a
143422	n/a	n/a	n/a	n/a	n/a
143423	n/a	n/a	n/a	n/a	n/a
143425	n/a	n/a	n/a	TMU2B	n/a
143455	n/a	n/a	n/a	TMT3S	n/a
143458	n/a	n/a	n/a	TMS4S	n/a
143459	n/a	n/a	n/a	TMC0	n/a
143460	n/a	n/a	n/a	TMC0	n/a
143461	n/a	n/a	n/a	TMU4S	n/a
143462	n/a	n/a	n/a	TMU4S	n/a
143464	n/a	n/a	n/a	n/a	n/a
143465	n/a	n/a	n/a	TMT3S	n/a
143466	n/a	n/a	n/a	TMT3S	n/a
143468	n/a	n/a	n/a	TMC3S	n/a
143473	n/a	n/a	n/a	TMC0	n/a
143474	n/a	n/a	n/a	TMO2S	n/a
143476	n/a	n/a	n/a	TMC0	n/a
143477	n/a	n/a	n/a	TMT3S	n/a
143486	n/a	n/a	n/a	TMR3S	n/a
143491	n/a	n/a	n/a	TMT3S	n/a
143492	n/a	n/a	n/a	TMT3S	n/a
143495	n/a	n/a	n/a	TMT3S	n/a
143496	n/a	n/a	n/a	n/a	n/a
143498	n/a	n/a	n/a	n/a	n/a
143530	n/a	n/a	n/a	n/a	n/a
143531	n/a	n/a	n/a	TMO2B	n/a
143564	n/a	n/a	n/a	TMT3S	n/a

SPECIFICATIONS BY PART NUMBER

ULTRA CARTRIDGE

CATALOG PART NO.	EXTENDED LENGTH	COLLAPSED LENGTH	STROKE	UPPER MTG CODE	LOWER MTG CODE
G44461	20.58	14.67	5.91	S16	LP6

ULTRA READYMOUNTS

CATALOG PART NO.	EXTENDED LENGTH	COLLAPSED LENGTH	STROKE	UPPER MTG CODE	LOWER MTG CODE
G56726	25.15	17.27	7.88	TMO2S	CL1
G56924	23.13	16.09	7.05	TMU3S	CL1
G56925	23.13	16.09	7.05	TMU3S	CL1
G56927	18.01	11.14	6.88	TMC2S1B	CL1
G56928	20.18	12.01	8.18	TMU3B1S	CL1
G56929	17.51	10.62	6.89	TMT3S	CL1
G56930	17.22	10.54	6.68	TMT3S	CL1
G56931	17.22	10.54	6.68	TMT3S	CL1
G56932	20.95	12.25	8.7	TMT3S	CL1
G56933	20.95	12.25	8.7	TMT3S	CL1
G56934	19.51	13.60	5.91	TMU3S	LP4
G56935	20.01	13.49	6.52	TMC3S	LP4
G56936	20.41	13.65	6.76	TMC3S	LP4
G56937	19.51	13.60	5.91	TMU3S	LP4
G56938	22.88	17.33	5.55	TMU2B1S	ES58
G56943	25.31	16.56	8.75	TMO2S	ES199
G56948	16.79	10.81	5.98	TMC3S	CL1
G56949	19.57	11.76	7.81	TMT3S	CL1
G56950	19.57	11.76	7.81	TMC3S	CL1
G56951	19.92	13.14	6.78	TMC2S1B	CL1
G56956	18.6	12.14	6.47	TMC3S	CL1
G56957	18.6	12.14	6.47	TMC3S	CL1
G56962	17.34	11.26	6.09	TMC4S	CL1
G56963	17.34	11.26	6.09	TMC4S	CL1
G56964	23.37	14.26	9.11	TMC3S	LP3
G56965	20.2	14.1	6.10	TMT3S	CL1
G56973	24.41	16.46	7.95	TMU3S1B	CL1
G56974	24.41	16.46	7.95	TMU3S1B	CL1
G56975	20.19	14.09	6.9	TMT3S	CL1
G56991	16.78	11.56	5.22	TMC5S	LP3
G56992	16.78	11.56	5.22	TMC5S	LP3
G56993	15.31	10.37	4.94	TMC2S	LP2
G56994	15.31	10.37	4.94	TMC2S	LP2
G56995	18.92	13.23	5.69	TMO2S	LU1
G56996	15.32	10.38	4.94	TMO2S	LP3
G56997	15.32	10.38	4.94	TMO2S	LP3
G56998	19.02	13.11	5.86	TMO2S	LU2

CATALOG PART NO.	EXTENDED LENGTH	COLLAPSED LENGTH	STROKE	UPPER MTG CODE	LOWER MTG CODE
G57000	17.76	12.87	4.76	TMC3S	BP37
G57005	20.43	13.78	6.65	TMC0	CL1
G57006	18.49	11.34	7.15	TMC0	CL1
G57007	13.87	9.62	4.25	TMU4S	LP6
G57008	13.87	9.62	4.25	TMU4S	LP6
G57010	18.02	12.75	5.27	TMC3S	ES56
G57011	20.98	14.44	6.54	TMT3S	CL1
G57012	20.98	14.44	6.54	TMT3S	CL1
G57013	17.25	10.25	7	TMC3S	CL1
G57014	19.63	12.38	7.25	TMC3S	CL1
G57015	21.05	16.14	4.91	TMC3S	ES77
G57016	21.25	14.21	7.04	TMC3S	ES77
G57017	18.93	16.73	2.2	TMC3S	ES159
G57018	19.28	13.69	5.59	TMC3S	ES162
G57019	18.93	16.73	2.2	TMC3S	ES159
G57020	20.6	16.65	3.95	TMC3S	ES184
G57021	21.69	16.62	5.07	TMC3S	ES184
G57022	16.61	11.41	5.2	TMC2S	LP3
G57023	17.76	12.87	4.76	TMC3S	BP37
G57026	24.48	16.97	7.16	TMO2S	LU1
G57027	18.14	13.36	4.78	TMC3S	ES153
G57030	20.5	13.62	6.87	TMT3S	CL1
G57031	20.5	13.61	6.87	TMT3S	CL1
G57032	14.68	10.35	4.33	TMO2S	ES69
G57033	14.68	10.35	4.33	TMO2S	ES69
G57034	18.75	12.75	6.00	TMT3S	CL1
G57035	18.75	12.75	6.00	TMT3S	CL1
G57036	16.37	11.07	5.3	TMO2S	ES45
G57037	23.31	16.65	6.66	TMT3S	CL1
G57038	23.31	16.65	6.66	TMT3S	CL1
G57039	19.65	13.23	6.42	TMC2B	LP1
G57040	20.39	14.21	6.18	TMR3S	CL1
G57041	18.89	11.48	7.41	TMC3S	CL1
G57042	18.89	11.48	7.41	TMC3S	CL1
G57043	20.95	12.25	8.7	TMC3S	CL1
G57044	20.95	12.25	8.7	TMC3S	CL1
G57045	25	17.75	7.25	TMC4S	CL1

SPECIFICATIONS BY PART NUMBER

ULTRA READYMOUNTS (CONT'D)

CATALOG PART NO.	EXTENDED LENGTH	COLLAPSED LENGTH	STROKE	UPPER MTG CODE	LOWER MTG CODE	CATALOG PART NO.	EXTENDED LENGTH	COLLAPSED LENGTH	STROKE	UPPER MTG CODE	LOWER MTG CODE
G57046	25	17.75	7.25	TMC4S	CL1	G57096	19.33	13.42	5.9	TMC3S	ES209
G57047	20	13.50	6.5	TMU3S	CL1	G57097	21.73	15.16	6.57	TMC3S	CL1
G57048	20	13.50	6.5	TMU3S	CL1	G57098	21.73	15.16	6.57	TMC3S	CL1
G57049	19.87	13.37	6.5	TMT3S	CL1	G57099	19.75	13.12	6.62	TMC4B	CL1
G57050	19.87	13.37	6.5	TMT3S	CL1	G57100	19.75	13.12	6.62	TMC2B	CL1
G57051	16.82	10.66	6.17	TMT3B	CL1	G57103	21.57	17.16	4.41	TMC3S	ES77
G57053	21.5	15.34	5.85	TMC3S	LU1	G57105	20.74	13.59	7.15	TMT3S	CL1
G57054	17.12	12.50	4.62	TMC5S	LP3	G57106	20.74	13.59	7.15	TMT3S	CL1
G57055	17.12	12.50	4.62	TMC5S	LP3	G57107	18.63	14.83	3.8	TMU2S2B	BP37
G57056	24.57	17.09	7.48	TMU2S	ES202	G57108	18.63	14.83	3.8	TMU2S2B	BP37
G57057	17.86	11.91	5.95	TMC2S	ES87	G57109	22	14.13	7.87	TMR3S	CL1
G57058	17.86	11.91	5.95	TMC2S	ES87	G57110	20.94	12.87	8.07	TMC3S	CL1
G57059	16.79	11.99	4.8	TMT3S	LP2	G57111	20.94	12.87	8.07	TMC3S	CL1
G57060	16.5	10.71	5.79	TMT3S	CL1	G57112	20.8	13.38	7.42	TMU3S	CL1
G57061	14.68	10.35	4.33	TMO2S	ES112	G57113	20.8	13.38	7.42	TMU3S	CL1
G57062	14.68	10.35	4.33	TMO2S	ES112	G57114	19.62	13.87	5.75	TMT3S	CL1
G57063	20.22	13.94	6.28	TMT3S	LP1	G57115	19.62	13.87	5.75	TMT3S	CL1
G57064	20.22	14.02	6.2	TMT3S	LP1	G57118	15.56	10.99	4.57	TMC3S	ES49
G57065	18.02	12.75	5.27	TMC3S	ES56	G57119	27.75	14.50	13.25	TMT3S	CL1
G57066	18.02	12.75	5.27	TMC3S	ES56	G57120	21.75	14.50	7.25	TMT3S	CL1
G57067	16.5	11.50	5	TMU2S1B	ES104	G57121	20.47	12.68	7.79	TMC3S	CL1
G57068	16.5	11.50	5	TMU2S1B	ES104	G57122	20.47	13.07	7.40	TMC3S	CL1
G57069	20.47	12.68	7.79	TMC3S	CL1	G57123	23.26	17.55	5.7	TMC4S	ES67
G57070	20.47	13.07	7.40	TMC3S	CL1	G57124	23.26	17.55	5.7	TMC4S	ES67
G57071	25.17	19.37	5.8	TMC3S	LU2	G57125	17.8	13.54	4.26	TMC3S	BP37
G57072	25.17	19.37	5.8	TMC3S	LU2	G57126	20.44	13.69	6.75	TMC0	CL1
G57075	21.3	14.3	7	TMC3S	ES96	G57127	20.44	13.69	6.75	TMC0	CL1
G57076	18.91	11.48	7.43	TMT3S	CL1	G57128	22.34	14.9	7.44	TMT3S	CL1
G57077	18.91	11.48	7.43	TMT3S	CL1	G57129	22.34	14.9	7.44	TMT3S	CL1
G57078	20.95	12.25	8.7	TMT3S	CL1	G57130	20.09	13.79	6.30	TMC0	CL1
G57079	20.95	12.25	8.7	TMT3S	CL1	G57131	20.09	13.79	6.30	TMC0	CL1
G57080	15.55	12.09	3.46	TMC3S	ES75	G57132	20.86	16.45	4.4	TMC3S	ES77
G57081	18.84	13.12	5.72	TMT3S	LP1	G57133	21.36	16.79	4.57	TMC3S	ES153
G57082	18.84	13.12	5.72	TMT3S	LP1	G57134	21.36	16.79	4.57	TMC3S	ES153
G57083	21	14.25	6.75	TMU4S	LP4	G57135	22.05	18.19	3.86	TMC2S	LU3
G57084	21.1	14.53	6.57	TMT3S	CL1	G57136	22.05	18.19	3.86	TMC2S	LU3
G57085	21.1	14.53	6.57	TMT3S	CL1	G57137	24.88	17.95	6.92	TMT3S	CL1
G57086	15.65	10.84	4.81	TMO2S	ES165	G57138	24.88	17.95	6.92	TMT3S	CL1
G57087	15.65	10.84	4.81	TMO2S	ES165	G57139	23	16.37	6.62	TMT3S	CL1
G57088	19.62	13.37	6.25	TMT3S	CL1	G57140	23	16.37	6.62	TMT3S	CL1
G57089	19.62	13.37	6.25	TMT3S	CL1	G57141	19.6	13.07	6.53	TMT3S	CL1
G57090	22	15.69	6.31	TMC0	ES104	G57142	19.6	13.14	6.45	TMT3S	CL1
G57091	22	15.69	6.31	TMC0	ES104	G57144	22.56	15.98	6.58	TMT3S	CL1
G57092	14.92	10.43	4.49	TMC4S	ES49	G57145	22.56	15.98	6.58	TMT3S	CL1
G57095	20.11	17.44	2.51	TMC3S	ES208	G57146	18.07	13.46	4.61	TMU3S	LU1

SPECIFICATIONS BY PART NUMBER

ULTRA READYMOUNTS (CONT'D)

CATALOG PART NO.	EXTENDED LENGTH	COLLAPSED LENGTH	STROKE	UPPER MTG CODE	LOWER MTG CODE	CATALOG PART NO.	EXTENDED LENGTH	COLLAPSED LENGTH	STROKE	UPPER MTG CODE	LOWER MTG CODE
G57147	21.18	15.11	6.06	TMT3S	LU1	G57220	23.27	17.56	5.70	TMU4S	ES67
G57148	18.5	14.29	4.21	TMT3S	LP3	G57221	23.27	17.56	5.70	TMU4S	ES67
G57149	15.74	11.34	4.4	TMC3S	LP3	G57222	21.46	14.45	7.40	TMT3S	CL1
G57150	23.72	16.95	6.77	TMT3S	CL1	G57223	21.46	14.45	7.40	TMT3S	CL1
G57151	23.72	16.95	6.77	TMT3S	CL1	G57266	22.13	14.84	7.29	TMT3S	CL1
G57152	22.99	15.08	7.91	TMT3S	CL1	G57267	22.13	14.84	7.28	TMT3S	CL1
G57153	22.99	15.08	7.91	TMT3S	CL1	G57268	18.82	12.52	6.29	TMT3S	CL1
G57156	21.1	14.8	6.30	TMT3S	LP5	G57269	18.82	12.52	6.29	TMT3S	CL1
G57157	21.14	13.66	7.48	TMT3S	CL1	G57270	19.65	14.09	5.55	TMT3S	LP3
G57158	21.14	13.66	7.48	TMT3S	CL1	G57271	21.69	16.02	5.66	TMC4S	CL1
G57159	17.62	12.87	4.75	TMC2S	ES18	G57274	19.76	13.30	6.45	TMT3S	CL1
G57160	17.62	12.87	4.75	TMC2S	ES18	G57275	19.21	12.44	6.77	TMT3S	CL1
G57161	17.51	13.3	4.21	TMT3B	CL1	G57276	19.21	12.44	6.77	TMT3S	CL1
G57162	17.51	13.3	4.21	TMT3B	CL1	G57277	21.77	16.39	6.37	TMT3S	LP5
G57163	22.2	15.04	7.16	TMC3S	CL1	G57278	22.28	13.93	8.34	TMT3S	CL1
G57164	22.2	15.04	7.16	TMC3S	CL1	G57279	22.28	13.93	8.34	TMT3S	CL1
G57167	22.12	14.37	7.75	TMC3S	CL1	G57282	15.86	11.06	4.8	TMC3S	ES56
G57168	22.12	14.37	7.75	TMC3S	CL1	G57314	22.05	14.21	7.87	TMR3S	CL1
G57172	19.96	16.29	3.67	TMC3S	ES77	G57322	23.39	14.37	7.7	TMC3S	CL1
G57173	19.21	15.15	4.05	TMC3S	ES77	G57323	23.39	14.37	7.7	TMC3S	CL1
G57176	22.83	16.3	6.53	TMT3S	CL1	G57324	19.29	13.07	6.22	TMT3S	CL1
G57177	22.83	16.3	6.53	TMT3S	CL1	G57329	20.43	13.5	7.13	TMT3S	CL1
G57178	19.05	12.75	6.30	TMO2S	ES19	G57330	20.43	13.5	7.13	TMT3S	CL1
G57184	21.53	14.13	7.40	TMT3S	CL1	G57331	23.19	14.96	8.46	TMU5S	CL1
G57185	21.53	14.13	7.40	TMT3S	CL1	G57332	23.19	14.96	8.46	TMU5S	CL1
G57190	21.5	14.49	6.89	TMT3S	CL1	G57333	24.84	16.77	7.99	TMT3S	CL1
G57191	21.5	14.37	6.89	TMT3S	CL1	G57334	24.84	16.77	7.99	TMT3S	CL1
G57192	24.13	15.82	8.30	TMT3S	CL1	G57335	20.83	13.98	6.63	TMU3S	CL1
G57193	24.13	15.82	8.30	TMT3S	CL1	G57336	20.83	13.98	6.63	TMU3S	CL1
G57194	25	19.41	5.59	TMC3S	LU1	G57337	21.18	15.07	6.1	TMC3S	LP2
G57195	25	19.41	5.59	TMC3S	LU1	G57338	21.18	15.07	6.1	TMC3S	LP2
G57197	23.47	14.37	7.7	TMC3S	CL1	G57339	20.87	14.65	5.55	TMT3S	CL1
G57198	23.47	14.37	7.7	TMC3S	CL1	G57340	20.87	14.65	5.55	TMT3S	CL1
G57200	19.72	12.87	4.25	TMT3S	CL1	G57341	21.69	15.79	5.98	TMT3S	CL1
G57201	19.72	12.87	4.25	TMT3S	CL1	G57342	21.69	15.79	5.98	TMT3S	CL1
G57202	19.09	14.29	4.8	TMT3S	CL1	G57343	23.35	15.47	7.36	TMS3S	CL1
G57203	19.09	14.29	4.8	TMT3S	CL1	G57344	23.35	15.47	7.36	TMS3S	CL1
G57204	21.02	14.69	6.33	TMT3S	CL1	G57345	19.88	13.5	6.3	TMT3S	CL1
G57205	21.02	14.69	6.33	TMT3S	CL1	G57346	19.88	13.5	6.3	TMT3S	CL1
G57206	22.71	15.74	6.97	TMT3S	CL1	G57349	20.75	15.31	7.15	TMT3S	CL1
G57207	17.67	12.91	4.76	TMC3S	LP3	G57350	20.75	15.31	7.15	TMT3S	CL1
G57208	17.67	12.91	4.76	TMC3S	LP3	G57353	21.61	14.92	6.06	TMC0	CL1
G57212	21.02	16.1	4.14	TMC3S	ES77	G57354	21.61	14.92	6.06	TMC0	CL1
G57218	21.46	14.72	6.61	TMT3S	CL1	G57357	20.63	13.35	7.02	TMT3S	CL1
G57219	21.46	14.72	6.61	TMT3S	CL1	G57358	20.63	13.35	7.02	TMT3S	CL1

SPECIFICATIONS BY PART NUMBER

ULTRA READYMOUNTS (CONT'D)

CATALOG PART NO.	EXTENDED LENGTH	COLLAPSED LENGTH	STROKE	UPPER MTG CODE	LOWER MTG CODE	CATALOG PART NO.	EXTENDED LENGTH	COLLAPSED LENGTH	STROKE	UPPER MTG CODE	LOWER MTG CODE
G57359	19.53	12.72	6.88	TMC4S	LP4	G57450	18.11	12.4	5.71	TMU3B	ES206
G57360	19.53	12.72	6.88	TMC4S	LP4	G57451	17.76	11.77	5.99	TMU2S1B	ES214
G57363	18.43	14.13	4.33	TMC3S	LP4	G57452	14.8	10.75	4.05	TMU2S1B	ES89
G57364	18.43	14.13	4.33	TMC3S	LP4	G57453	22.05	17.87	4.18	TMS4S	ES67
G57367	19.72	13.07	4.21	TMT3S	CL1	G57454	22.05	17.87	4.18	TMS4S	ES67
G57368	19.72	13.07	4.21	TMT3S	CL1	G57455	19.53	14.37	5.16	TMC3S	LP3
G57369	20.67	13.39	7.28	TMT3S	CL1	G57456	19.53	14.37	5.16	TMC3S	LP3
G57370	20.67	13.39	7.28	TMT3S	CL1	G57459	22.2	14.96	7.24	TMT3S	CL3
G57372	23.78	16.3	6.73	TMC3S	CL1	G57460	22.2	14.96	7.24	TMT3S	CL3
G57373	23.78	16.3	6.73	TMC3S	CL1	G57463	18.66	11.42	7.24	TMT3S	CL1
G57375	23.27	16.69	6.73	TMC3S	CL1	G57464	18.66	11.42	7.24	TMT3S	CL1
G57376	23.27	16.69	6.73	TMC3S	CL1	G57465	21.93	14.8	7.13	TMT3S	CL3
G57377	19.06	15.08	4.09	TMC0	CL1	G57466	21.93	14.8	7.13	TMT3S	CL3
G57378	19.06	15.08	4.09	TMC0	CL1	G57471	22.99	15.94	7.05	TMT3S	CL3
G57390	20.12	13.11	6.93	TMT3S	CL1	G57472	22.99	15.94	7.05	TMT3S	CL3
G57391	20.12	13.11	6.93	TMT3S	CL1	G57473	23.19	15.83	7.36	TMU3S	CL1
G57393	19.76	12.48	7.25	TMT3S	CL1	G57474	23.19	15.83	7.36	TMU3S	CL1
G57394	19.76	12.48	7.25	TMT3S	CL1	G57479	23.19	14.72	8.47	TMU5S	CL1
G57397	20.51	13.46	6.89	TMT3S	CL1	G57480	23.19	14.72	8.47	TMU5S	CL1
G57398	19.65	13.19	6.16	TMT3S	CL1	G57481	23.78	16.06	7.72	TMT3S	CL3
G57399	19.65	13.19	6.16	TMT3S	CL1	G57482	23.78	16.06	7.72	TMT3S	CL3
G57400	21.34	13.9	7.07	TMU3S	CL1	G57483	26.34	18.03	8.31	TMU3S	CL1
G57401	21.34	13.9	7.07	TMU3S	CL1	G57484	26.34	18.03	8.31	TMU3S	CL1
G57404	20.47	13.31	7.16	TMT3S	CL1	G57489	20.38	14.41	5.97	TMS4S	CL1
G57405	20.47	13.31	7.16	TMT3S	CL1	G57490	20.38	14.41	5.97	TMS4S	CL1
G57409	18.07	13.46	4.61	TMT3S	LU1	G57493	19.88	13.31	6.57	TMT3S	CL1
G57413	15.12	10.95	4.17	TMC3S	ES49	G57494	19.88	13.31	6.57	TMT3S	CL1
G57414	18.43	11.81	6.42	TMT3S	ES197	G57495	19.17	11.93	7.24	TMC4S	LP4
G57415	18.43	11.81	6.42	TMT3S	ES197	G57496	19.17	11.93	7.24	TMC4S	LP4
G57416	15.67	10.94	4.73	TMO2S	ES50	G57497	18.62	11.38	7.24	TMC4S	LP4
G57417	18	13.23	4.76	TMC3S	LP3	G57498	18.62	11.38	7.24	TMC4S	LP4
G57418	18	13.23	4.76	TMC3S	LP3	G57499	22.99	15.98	7.01	TMT3S	CL1
G57419	23.03	15.87	7.14	TMC2S	LU2	G57500	22.99	15.98	7.01	TMT3S	CL1
G57420	25	16.96	8.34	TMC3S	ES52	G57515	20.75	14.29	6.46	TMT3S	CL1
G57421	20.63	15.51	5	TMC3S	ES201	G57516	20.75	14.29	6.46	TMT3S	CL1
G57422	24.48	16.97	7.16	TMC3S	LU1	G57517	22.56	15.59	6.97	TMT3S	LP3
G57423	16.23	10.43	5.48	TMO2S	ES49	G57518	22.56	15.59	6.97	TMT3S	LP3
G57424	15.12	11.14	3.98	TMO2S	ES50	G57521	19.25	12.72	6.53	TMT3S	CL1
G57425	15.12	11.14	3.98	TMO2S	ES50	G57522	19.25	12.72	6.53	TMT3S	CL1
G57427	19.69	13.94	4.45	TMC3S	LP3	G57533	24.21	16.85	7.36	TMT3S	CL1
G57428	14.8	10.75	4.05	TMU3S	ES71	G57534	24.21	16.85	7.36	TMT3S	CL1
G57429	14.8	10.74	4.06	TMU3S	ES71	G57535	23.31	15.28	8.03	TMC3S	CL3
G57444	18.7	12.01	6.69	TMU2S1B	ES104	G57536	23.31	15.28	8.03	TMC3S	CL3
G57447	20.31	12.48	7.83	TMO2S	ES88	G57539	21.38	14.53	6.85	TMT3S	CL1
G57449	18.11	12.4	5.71	TMU3B	ES206	G57540	21.38	14.53	6.85	TMT3S	CL1

SPECIFICATIONS BY PART NUMBER

ULTRA READYMOUNTS (CONT'D)

CATALOG PART NO.	EXTENDED LENGTH	COLLAPSED LENGTH	STROKE	UPPER MTG CODE	LOWER MTG CODE
G57541	20.79	13.82	6.97	TMC0	CL1
G57542	20.79	13.82	6.97	TMC0	CL1
G57543	20.16	13.39	6.77	TMT3S	CL3
G57544	20.16	13.39	6.77	TMT3S	CL3
G57545	20.79	17.83	2.96	TMT3S	CL3
G57546	20.79	17.83	2.96	TMT3S	CL3
G57549	22.8	15.47	7.33	TMC3S	CL1
G57550	22.8	15.47	7.33	TMC3S	CL1
G57558	19.09	12.52	6.57	TMT3S	CL1
G57559	16.61	10.61	6	TMT3S	CL1
G57560	24.69	16.89	7.8	TMT3S	CL1
G57561	24.69	16.89	7.8	TMT3S	CL1
G57562	23.31	15.98	7.33	TMT3S	CL1
G57563	23.31	15.98	7.33	TMT3S	CL1
G57564	25.31	16.54	8.77	TMT3S	CL3
G57565	25.31	16.54	8.77	TMT3S	CL3
G57566	20.55	13.43	7.12	TMT3S	CL1
G57567	20.55	13.43	7.12	TMT3S	CL1
G57572	14.8	10.75	4.05	TMU3S	ES75
G57573	14.8	10.75	4.05	TMU3S	ES89
G57577	21.93	14.8	7.13	TMT3S	CL1
G57578	21.93	14.8	7.13	TMT3S	CL1
G57579	20.28	13.5	6.78	TMU2S	ES19
G57582	24.17	16.5	7.67	TMU4S	CL1
G57583	24.17	16.5	7.67	TMU4S	CL1
G57586	24.33	16.81	7.52	TMT3S	CL3
G57587	24.33	16.81	7.52	TMT3S	CL3
G57594	19.61	14.09	5.52	TMU3S	LP3
G57595	19.61	14.09	5.52	TMU3S	LP3
G57597	16.69	12.36	4.33	TMO2S	ES50
G57598	16.69	12.36	4.33	TMO2S	ES50
G57603	21.73	14.13	7.6	TMC0	CL1
G57604	21.73	14.13	7.6	TMC0	CL1
G57605	24.09	16.85	7.24	TMT3S	CL1
G57606	24.09	16.85	7.24	TMT3S	CL1
G57607	19.06	12.76	6.3	TMU2S	ES19
G57612	25.94	17.83	8.11	TMT3S	CL3
G57613	25.94	17.83	8.11	TMT3S	CL3
G57628	21.3	15.24	6.06	TMT3S	CL1
G57629	21.3	15.24	6.06	TMT3S	CL1
G57634	23.9	15.75	8.15	TMT3S	CL3
G57635	23.9	15.75	8.15	TMT3S	CL3
G57644	19.72	13.07	6.65	TMT3S	CL1
G57645	19.72	13.07	6.65	TMT3S	CL1
G57646	15.04	10.71	4.33	TMC3S	ES49

CATALOG PART NO.	EXTENDED LENGTH	COLLAPSED LENGTH	STROKE	UPPER MTG CODE	LOWER MTG CODE
G57647	15.04	10.75	4.29	TMC3S	ES49
G57648	21.69	16.14	5.55	TMC3S	CL3
G57649	21.69	16.14	5.55	TMC3S	CL3
G57658	24.53	16.5	8.03	TMU3S	CL3
G57659	24.53	16.5	8.03	TMU3S	CL3
G57663	23.27	16.1	7.17	TMC3S	CL3
G57664	23.27	16.1	7.17	TMC3S	CL3
G57665	23.27	16.65	6.62	TMC3S	CL3
G57666	23.27	16.65	6.62	TMC3S	CL3
G57673	20.87	14.45	6.42	TMT3S	CL1
G57674	20.87	14.45	6.42	TMT3S	CL1
G57675	16.65	11.06	5.59	TMO2S	ES107
G57676	23.27	15.79	7.48	TMC3S	ES107
G57677	23.27	15.79	7.48	TMC3S	ES107
G57680	21.73	15.28	6.45	TMT3S	LP6
G57682	15.71	10.94	4.77	TMO2S	ES46
G57683	22.56	n/a	n/a	TMC3S	BP15
G57689	23.62	15.75	7.87	TMT3S	CL1
G57690	23.62	15.75	7.87	TMT3S	CL1
G57691	22.68	15.39	7.29	TMS4S	CL3
G57692	22.68	15.39	7.29	TMS4S	CL3
G57693	22.68	15.39	7.29	TMS4S	CL3
G57694	22.68	15.39	7.29	TMS4S	CL3
G57695	24.61	17.05	7.56	TMT3S	CL1
G57696	24.61	17.05	7.56	TMT3S	CL1
G57697	23.15	15.04	8.11	TMC4S	CL1
G57698	23.15	15.04	8.11	TMC4S	CL1
G57699	23.15	15.04	8.11	TMC4S	CL3
G57700	23.15	15.04	8.11	TMC4S	CL3
G57701	19.76	13.5	6.26	TMT3S	CL1
G57702	19.76	13.5	6.26	TMT3S	CL1
G57703	17.13	10.94	6.19	TMO2S	ES107
G57704	21.25	15	6.25	TMT3S	CL3
G57705	21.25	15	6.25	TMT3S	CL3
G57706	18.94	13.11	5.83	TMO2S	ES107
G57709	20.59	14.29	6.3	TMS3S	CL1
G57712	19.96	13.66	6.3	TMT3S	CL3
G57713	19.96	13.66	6.3	TMT3S	CL3
G57716	22.02	10.06	11.96	TMC0	n/a
G57717	22.02	10.06	11.96	TMC0	n/a
G57720	23.78	16.06	7.72	TMT3S	CL1
G57721	23.78	16.06	7.72	TMT3S	CL1
G57722	19.48	12.72	6.77	TMT3S	n/a
G57723	19.48	12.72	6.77	TMT3S	n/a
G57724	17.91	11.34	6.57	TMT3S	LP3

SPECIFICATIONS BY PART NUMBER

ULTRA READYMOUNTS (CONT'D)

CATALOG PART NO.	EXTENDED LENGTH	COLLAPSED LENGTH	STROKE	UPPER MTG CODE	LOWER MTG CODE	CATALOG PART NO.	EXTENDED LENGTH	COLLAPSED LENGTH	STROKE	UPPER MTG CODE	LOWER MTG CODE
G57725	17.91	11.34	6.57	TMT3S	LP3	G57775	19.76	13.23	6.53	TMT3S	LP3
G57726	21.18	14.45	6.73	TMT3S	LP3	G57776	22.17	15.79	6.38	TMT3S	CL1
G57727	21.18	14.45	6.73	TMT3S	CL3	G57777	22.17	15.79	6.38	TMT3S	CL1
G57730	23.46	16.77	6.69	TMT3S	CL1	G57778	18.94	13.23	5.71	TMU3S	CL3
G57731	23.46	16.77	6.69	TMT3S	CL1	G57779	18.94	13.23	5.71	TMU3S	CL3
G57732	23.74	16.3	7.44	TMT3S	CL1	G57780	22.55	16.73	5.82	TMT3S	n/a
G57733	23.74	16.3	7.44	TMT3S	CL1	G57781	22.55	16.73	5.82	TMT3S	n/a
G57734	23.5	16.73	6.77	TMT3S	CL1	G57782	23.62	15.9	7.71	TMT3S	n/a
G57735	23.5	16.73	6.77	TMT3S	CL1	G57783	23.62	15.9	7.71	TMT3S	n/a
G57738	19.49	12.72	6.77	TMT3S	CL3	G57784	21.54	14.53	7.01	TMT3S	CL1
G57739	19.49	12.72	6.77	TMT3S	CL3	G57785	21.54	14.53	7.01	TMT3S	CL1
G57740	19.65	13.27	6.38	TMT3S	CL3	G57786	20.51	16.81	3.7	TMT3S	n/a
G57741	19.65	13.27	6.38	TMT3S	CL3	G57790	26.34	18.19	8.15	TMT3S	CL1
G57742	19.06	13.66	5.4	TMT3S	CL3	G57791	26.34	18.19	8.15	TMT3S	CL1
G57743	19.06	13.66	5.4	TMT3S	CL3	G57792	17	12	5	TMO2S	n/a
G57744	21.1	14.09	7.01	TMC4S	CL1	G57793	17	12	5	TMO2S	n/a
G57745	21.1	14.09	7.01	TMC4S	CL1	G57794	19.05	12.75	6.3	TMO2S	n/a
G57746	21.1	14.09	7.01	TMC4S	CL1	G57795	24.51	n/a	n/a	TMT3B	CL3
G57747	21.1	14.09	7.01	TMC4S	CL1	G57796	24.51	n/a	n/a	TMT3B	CL3
G57748	19.21	14.72	4.48	TMC3S	ES56	G57799	19.29	13.38	5.9	TMO2S	n/a
G57749	22.32	16.14	6.18	TMO3S	LU1	G57800	26.73	19.49	7.24	TMU2B1S	LP4
G57750	19.09	12.36	6.73	TMT3S	CL1	G57801	26.73	19.49	7.24	TMU2B1S	LP4
G57751	19.09	12.36	6.73	TMT3S	CL1	G57802	17.20	9.96	7.24	TMR4S	CL3
G57752	22.36	14.8	7.55	TMC3S	CL3	G57803	19.9	13.62	6.28	TMT3S	CL1
G57753	22.36	14.8	7.55	TMC3S	CL3	G57804	19.9	13.62	6.28	TMT3S	CL1
G57758	21.42	13.94	7.48	TMT3S	CL3	G57812	20.63	13.94	6.69	TMC3B	CL1
G57759	21.42	13.94	7.48	TMT3S	CL3	G57816	27.17	18.98	8.19	TMT3S	LP4
G57764	31.69	26.26	5.43	TMO3S	LU4	G57817	20.83	13.94	6.89	TMC3B	CL1
G57765	31.69	26.26	5.43	TMO3S	LU4	G57818	20.83	13.94	6.89	TMC3B	CL1
G57768	22.44	n/a	n/a	TMT3S	CL3	G57819	23.15	15.04	8.11	TMC4S	CL1
G57769	22.44	n/a	n/a	TMT3S	CL3	G57820	23.15	15.04	8.11	TMC4S	CL1
G57772	23.39	16.38	7.01	TMT3S	CL3	G57825	22.32	16.14	6.18	TM30S	LU1
G57773	23.39	16.38	7.01	TMT3S	CL3	G57852	21.28	n/a	n/a	TMU3S	CL1
G57774	19.76	13.23	6.53	TMT3S	LP3	G57853	21.28	n/a	n/a	TMU3S	CL1

SPECIFICATIONS BY PART NUMBER

ULTRA SHOCKS

CATALOG PART NO.	EXTENDED LENGTH	COLLAPSED LENGTH	STROKE	UPPER MTG CODE	LOWER MTG CODE
69420	22.81	14.68	8.13	S1	EB3
69450	26.25	16	10.25	S48	EB5
69464	24.2	15.93	8.27	S70	ES41
69465	17.94	12.78	5.16	ES162	ES65
69473	18.29	11.43	6.86	ES85	ES30
69574	20.26	12.5	7.76	S36	ES7
69575	20.16	12.4	7.76	S36	ES162
69585	22.5	13.99	8.51	BP18	ES18
69586	23.5	15.62	7.88	S20	ES89
69587	15.9	10.64	5.26	ES19	ES56
69589	17.54	11.53	6.01	ES19	ES59
69590	17.82	11.21	6.61	S58	ES59
69591	17.73	11.72	6.01	ES185	ES185
69592	20.07	12.56	7.51	S1	ES107
69593	20.07	12.56	7.51	S1	ES107
69594	19.42	12.41	7.01	EB1	ES34
69595	20.34	12.83	7.51	EB1	ES34
69600	13.61	8.75	4.86	S1	BP30
69604	20.64	12.78	7.86	BP31	EB1
69606	20.2	12.34	7.86	S1	EB1
69622	14.73	9.62	5.11	ES10	EB1
69624	21.7	12.84	8.86	BP14	S1
69625	14.11	9	5.11	S1	BP19
69632	21.78	13.42	8.36	ES84	ES84
69675	14.61	9.25	5.36	S1	BP7
69676	19.7	11.84	7.86	S1	EB1
69677	18.45	11.34	7.11	S1	ES8
69714	14.1	9.94	4.16	S1	BP17
69715	13.98	9.37	4.61	ES18	ES110
69724	22.14	13.28	8.86	BP31	EB1
69725	21.6	13.09	8.51	S1	ES69
69755	20.45	12.34	8.11	S1	ES185
69757	24.6	17.54	7.06	S1	ES85
69766	17.48	10.95	6.53	S36	EB21
69779	24.6	14.59	10.01	S17	EB1
69787	17.79	11.53	6.26	ES27	ES19
69795	15.2	9.59	5.61	S12	ES110
69811	13.6	9.69	3.91	S36	BP14
69813	24.26	14.15	10.11	S1	EB1
69845	19.2	13.94	5.26	S36	ES143
69863	24.43	14.91	9.52	S27	ES18
69898	19.85	14.19	5.66	S1	ES83
69900	24.91	14.8	10.11	S1	ES67

CATALOG PART NO.	EXTENDED LENGTH	COLLAPSED LENGTH	STROKE	UPPER MTG CODE	LOWER MTG CODE
69901	16.69	10.51	6.18	S52	ES143
69903	21.69	12.99	8.70	S27	ES18
69907	23.35	15.16	8.19	S50	ES113
69909	16.63	10.88	5.75	ES69	ES69
69916	26.36	15.25	11.11	S1	ES55
69945	26.35	16.45	9.90	S19	ES84
69946	24.04	14.33	9.71	S25	ES6
69952	21.45	18.38	3.07	S33	ES3
69962	21.11	15.1	6.01	S36	LU1
69966	17.62	11.27	6.35	S33	ES3
69996	19.1	15.04	4.06	S36	ES169
69998	17.91	14.09	3.82	S67	ES92
70000	19.57	12.09	7.48	S64	ES113
70001	22.52	13.94	8.58	BP34	ES72
70003	26.55	18.62	7.93	S34	ES147
70010	22.56	14.09	8.47	BP15	ES69
70013	22.95	14.88	8.07	S44	ES113
70020	21.89	13.14	8.75	S60	ES53
70024	23.39	19.48	3.9	S84	ES114
70027	17.82	12.95	4.88	ES29	ES141
70028	25.39	16.42	8.98	S96	ES197
70031	21.89	14.41	7.48	S53	LU2
70033	22.44	15.51	6.93	S37	ES205
70034	22.95	17.39	5.55	S30	ES18
70036	23.86	14.49	9.36	S18	ES107
70037	21.34	13.7	7.64	S75	LP1
70038	23.11	15.67	7.44	S22	ES78
70039	16.69	10.51	6.18	S3	ES56
70040	18.03	11.38	6.65	S66	ES54
70041	21.38	14.8	6.57	S18	ES69
70045	20.51	14.37	6.14	S74	S54
70049	21.57	15.08	6.5	S75	LU1
70052	26.41	16.18	10.23	S34	ES69
70053	23.81	14.52	9.28	S95	ES85
70055	23.89	14.84	9.05	S96	ES199
70056	27.67	18.54	9.13	S34	ES65
70059	22.2	13.77	8.43	S101	ES153
70060	20.78	17.28	3.5	S50	ES102
70063	22.13	14.57	7.56	S56	ES2
70064	20.31	15.23	5.07	S99	ES3
70065	19.8	12.75	7.04	S37	ES3
70068	22.52	14.88	7.63	S46	LU1
70078	19.68	12.12	7.55	S61	ES34

SPECIFICATIONS BY PART NUMBER

ULTRA SHOCKS (CONT'D)

CATALOG PART NO.	EXTENDED LENGTH	COLLAPSED LENGTH	STROKE	UPPER MTG CODE	LOWER MTG CODE
70086	25.27	18.66	6.61	S56	ES19
70089	20.43	16.45	3.97	S51	LU2
70095	15.27	10.02	5.23	ES19	EB19
70096	23.14	15.27	7.87	S97	LU2
70098	15.03	10.47	4.56	ES19	ES69
70102	15.28	10.35	4.93	ES88	ES69
70203	17.09	11.57	5.52	ES75	ES113
70204	22.24	14.25	7.99	S18	ES56
70207	25.63	16.81	8.82	S34	EB13
70208	14.76	10.28	4.48	ES19	ES69
70209	22.44	14.72	7.72	S75	LU1
70210	17.09	11.85	5.24	ES160	ES113
70213	17.09	11.85	5.24	ES160	ES113
70231	22.48	14.29	8.19	S102	ES107
G511000	20.91	16.14	4.77	S92	LU1
G511001	25.35	16.02	9.33	S34	ES83
G511002	28.58	18.77	9.84	S34	ES65
G511004	17.12	12.24	4.88	S51	ES107
G511007	26.82	16.7	10.12	S95	EB25
G511030	24.88	15.04	9.84	S52	ES153
G511037	23.23	15.08	8.15	S18	ES3
G511038	25.91	19.21	6.7	S75	ES56
G511043	16.85	12.20	4.64	S1	ES61
G511044	20.31	15.08	5.23	S1	ES26
G511078	26.38	16.46	9.92	S34	ES50
G511092	21.54	14.33	7.21	S1	ES26
G511122	24.45	16.95	7.5	S90	ES61
G511134	27.95	18.74	9.21	S34	ES65
G511135	20.67	13.78	6.89	S34	ES83
G511142	27.01	20.71	6.3	S91	LU1
G51721	24.88	17.95	6.94	S55	ES87

CATALOG PART NO.	EXTENDED LENGTH	COLLAPSED LENGTH	STROKE	UPPER MTG CODE	LOWER MTG CODE
G51783	24.41	14.45	9.96	S96	ES205
G51798	15.35	11.1	4.25	S61	ES61
G51799	23.03	14.65	8.38	S71	ES48
G51802	20.83	14.09	6.74	S51	LP2
G51803	14.41	10.12	4.29	S61	ES61
G51804	26.18	15.83	10.35	S88	ES214
G51805	27.13	16.61	10.52	S88	ES214
G51807	21.93	17.48	4.45	S47	ES69
G51812	19.96	13.94	6.02	S87	LU2
G51841	20.98	14.29	6.69	S50	ES199
G51871	15.7	11.77	3.93	S71	LU1
G51874	20.43	16.41	4.01	S90	LU2
G51884	16.53	13.5	3.03	S1	ES88
G51904	16.22	11.5	4.72	S55	BP13
G51905	23.74	17.79	5.95	S91	ES3
G51930	22.28	15.27	7	S51	ES152
G51965	19.69	12.52	7.17	S71	BP27
G51966	21.49	14.68	6.81	S97	LU2
G51971	25.47	17.60	7.87	S52	ES153
G51972	17	12	5	S96	ES50
G51975	15.78	11.37	4.4	S38	ES168
G51980	24.52	16.41	8.11	S97	LU2
G51982	22.24	13.97	8.26	S101	ES60
G51983	26.5	18.58	7.92	S34	ES83
G51990	23.34	14.68	8.66	S18	ES69
G51992	25.78	15.82	9.96	S95	
G51993	24.84	15.11	9.72	S20	ES48
G51994	23.18	14.88	8.29	n/a	n/a
G51996	23.15	15.24	7.91	S97	LU2

SPECIFICATIONS BY PART NUMBER

ULTRA STRUTS

CATALOG PART NO.	EXTENDED LENGTH	COLLAPSED LENGTH	STROKE	UPPER MTG CODE	LOWER MTG CODE	CATALOG PART NO.	EXTENDED LENGTH	COLLAPSED LENGTH	STROKE	UPPER MTG CODE	LOWER MTG CODE
G51077	18.02	12.75	5.27	S88	ES56	G51815	18.07	13.46	4.61	S97	LU1
G51087	17.86	11.91	5.95	S83	ES87	G51825	22.48	16.1	6.38	S51	ES152
G51097	22.83	18.07	4.76	S84	LU3	G51832	22.13	17.48	4.65	S92	ES49
G511003	22.63	15.82	6.81	S83	LU2	G51833	25.51	16.29	9.21	S92	ES49
G511054	19.48	15.15	4.33	S88	ES72	G51838	19.02	12.72	6.3	S86	ES19
G511055	19.48	15.15	4.33	S88	ES72	G51842	19.05	12.75	6.30	S51	ES19
G51267	14.25	10.7	3.54	S60	LP3	G51847	24.8	17.04	7.76	S49	ES61
G51268	24.48	16.97	7.16	S82	CL1	G51848	21.41	13.66	7.75	S90	ES88
G51477	18.14	13.36	4.78	S38	ES153	G51849	17.95	12.36	5.59	S118	ES206
G51700	14.68	10.35	4.33	S55	CL5	G51850	16.1	11.06	5.04	S96	ES56
G51703	20.6	16.65	3.95	S55	ES184	G51852	13.89	10.66	3.23	S32	ES71
G51704	21.69	16.62	5.07	S55	ES184	G51853	16.85	12	4.84	S80	ES56
G51714	16.79	11.99	4.8	S102	LP2	G51854	16.85	12	4.84	S80	ES56
G51715	14.92	10.43	4.49	S89	ES49	G51855	23.26	17.55	5.7	S61	ES67
G51716	14.68	10.35	4.33	S48	ES112	G51856	21.18	15.11	6.07	S92	LU1
G51718	16.61	11.41	5.2	S48	LP3	G51858	15.35	11.18	4.17	S96	ES50
G51719	19.84	15.70	4.14	S55	ES77	G51859	18.5	14.29	4.21	S91	LP3
G51722	18.93	16.73	2.2	S38	ES159	G51860	19.96	16.29	3.67	S32	ES77
G51723	18.93	16.73	2.2	S38	ES159	G51861	19.21	15.15	4.05	S32	ES77
G51724	19.28	13.69	5.59	S38	ES162	G51863	20.3	12.48	7.83	S90	ES88
G51727	17.62	12.87	4.75	S90	ES18	G51864	21.57	17.16	4.41	S38	ES77
G51728	13.87	9.62	4.25	S102	LP6	G51865	20.86	16.45	4.41	S38	ES77
G51729	21.5	14.26	7.24	S55	ES77	G51870	17.76	12.87	4.76	S101	BP37
G51736	16.5	11.50	5	S32	ES104	G51877	17.67	12.91	4.76	S49	LP3
G51738	24.57	17.09	7.48	S50	ES202	G51878	17.67	12.91	4.76	S49	LP3
G51739	21.36	16.79	4.57	S98	ES153	G51879	15.67	10.94	4.73	S45	ES50
G51740	24.5	19	5.50	SS4	LU1	G51880	18.42	12	6.42	S45	ES197
G51742	22.12	17.37	4.75	S2	ES85	G51881	16.57	11.65	4.92	S27	ES52
G51746	22.12	17.37	4.75	SS2	BP36	G51883	19.52	12.48	7.04	S18	ES152
G51758	21.5	15.34	5.85	S66	LU1	G51887	15.55	12.08	3.47	S38	ES95
G51759	23.25	15.12	8.12	SS2	ES63	G51888	15.55	12.08	3.47	S115	ES209
G51760	25.17	19.37	5.8	S32	LU2	G51891	17.8	13.54	4.26	S101	BP37
G51761	25.17	19.37	5.8	S32	LU2	G51892	23	15.86	7.14	S48	LU2
G51765	15.56	10.99	4.01	S62	ES49	G51896	18.54	14.09	4.45	S91	LP3
G51766	15.56	10.99	4.01	S62	ES49	G51897	18.54	14.09	4.45	S91	LP3
G51767	18.19	12.36	5.83	S104	ES49	G51898	16.57	12.09	4.49	S80	ES214
G51773	18	13.5	4.50	S38	ES51	G51899	17.04	11.73	5.31	S102	LP2
G51774	16.73	11.88	4.85	S51	LP2	G51900	22.83	14.92	7.91	S64	ES93
G51794	17.28	11.06	6.22	S86	ES19	G51901	22.4	19.32	3.07	S52	BP6
G51795	18.78	12.01	6.77	S64	ES214	G51908	17.44	11.3	6.14	S47	ES19
G51806	15.74	11.34	4.41	S60	LP3	G51910	18.03	12.36	5.67	S104	ES49
G51813	23.98	19.21	4.77	S92	LU1	G51911	18.86	15	3.86	S48	LP2
G51814	23.98	19.21	4.77	S92	LU1	G51914	15.16	10.94	4.21	S48	ES61

SPECIFICATIONS BY PART NUMBER

ULTRA STRUTS (CONT'D)

CATALOG PART NO.	EXTENDED LENGTH	COLLAPSED LENGTH	STROKE	UPPER MTG CODE	LOWER MTG CODE	CATALOG PART NO.	EXTENDED LENGTH	COLLAPSED LENGTH	STROKE	UPPER MTG CODE	LOWER MTG CODE
G51916	16.33	11.22	5.11	S38	ES168	G52107	23.22	16.18	7.04	S103	CL3
G51919	23.31	15.79	7.52	S102	LU2	G52108	23.22	16.18	7.04	S103	CL3
G51920	20.9	16.88	4.01	S92	ES49	G52110	18.14	11.96	6.19	S105	LP4
G51921	20.9	16.88	4.01	S92	ES49	G52111	18.14	11.96	6.19	S105	LP4
G51922	20.91	16.64	4.25	S61	ES167	G52112	21.41	14	7.41	S95	CL1
G51925	20.9	17.71	3.18	S100	LU1	G52113	21.41	14	7.41	S95	CL1
G51926	20.9	17.71	3.18	S100	LU1	G52116	19.29	13.07	6.22	S107	CL1
G51928	21.33	15.55	5.78	S84	ES147	G52117	21.69	14.76	6.93	S92	CL3
G51933	19.8	12.48	7.32	S91	ES152	G52118	21.69	14.76	6.93	S92	CL3
G51934	16.37	11.57	4.8	S26	ES93	G52121	17.51	13.3	4.21	S100	CL1
G51935	17	12.16	4.84	S55	BP27	G52122	17.51	13.3	4.21	S100	CL1
G51937	21.77	17.79	3.97	S88	ES67	G52125	22	14.13	7.87	S108	CL1
G51947	24.96	19.29	5.67	S118	LU2	G52127	23.3	15.6	7.7	S106	CL1
G51948	24.96	19.29	5.67	S118	LU2	G52128	23.3	15.6	7.7	S106	CL1
G51949	18.27	14.49	3.78	S101	BP37	G52129	17.82	11.49	6.34	S105	LP4
G51961	18.93	13.11	5.82	S91	ES107	G52130	17.82	11.49	6.34	S105	LP4
G51995	21.93	15.55	6.38	S61	ES215	G52131	22.71	15.74	6.97	S92	CL1
G52004	21.02	14.69	6.33	S103	CL1	G52140	24.13	16.97	7.16	S38	CL1
G52005	19.02	11.81	7.21	S104	LP1	G52141	24.13	16.97	7.16	S38	CL1
G52006	19.02	11.81	7.21	S104	LP1	G52142	18.38	14.05	4.33	S109	LP3
G52007	21.02	14.69	6.33	S103	CL1	G52143	18.38	14.05	4.33	S109	LP3
G52008	22.2	15.04	7.16	S92	CL1	G52144	20.35	15.39	4.96	S67	CL1
G52009	22.2	15.04	7.16	S92	CL1	G52145	20.35	15.39	4.96	S67	CL1
G52013	20.52	13.5	7.02	S103	CL1	G52148	22.12	14.76	7.36	S90	ES88
G52014	20.52	13.5	7.02	S103	CL1	G52149	22.12	14.76	7.36	S90	ES88
G52017	21.77	13.9	7.87	S80	CL1	G52150	24.68	16.69	7.99	S81	CL1
G52018	21.77	13.9	7.87	S80	CL1	G52151	24.68	16.69	7.99	S81	CL1
G52025	19.61	13.15	6.46	S105	CL1	G52152	21.77	13.93	7.84	S100	CL1
G52026	22.8	14.84	7.96	S105	CL1	G52153	21.77	13.93	7.84	S100	CL1
G52027	22.8	14.84	7.96	S105	CL1	G52154	19.29	12.52	6.77	S100	CL1
G52032	21.54	14.13	7.41	S92	CL1	G52155	19.29	12.52	6.77	S100	CL1
G52033	21.54	14.13	7.41	S92	CL1	G52156	19.84	12.59	7.25	S100	CL1
G52036	19.37	15.04	4.33	S61	ES56	G52157	19.84	12.59	7.25	S100	CL1
G52037	19.37	15.04	4.33	S61	ES56	G52158	23	15.94	7.06	S80	CL3
G52081	22.83	16.3	6.53	S92	CL1	G52159	23	15.94	7.06	S80	CL3
G52082	22.83	16.3	6.53	S92	CL1	G52160	19.68	13.15	6.53	S100	CL1
G52094	17.28	13.03	4.25	S92	CL1	G52161	19.68	13.15	6.53	S100	CL1
G52095	17.28	13.03	4.25	S92	CL1	G52162	22.2	14.13	8.07	S92	CL1
G52096	20.7	13.42	7.28	S103	CL1	G52163	22.2	14.13	8.07	S92	CL1
G52097	20.7	13.42	7.28	S103	CL1	G52164	16.25	10.78	5.47	S109	LP4
G52098	20.6	13.85	6.75	S92	CL1	G52165	16.25	10.78	5.47	S109	LP4
G52103	24.13	15.82	8.31	S103	CL1	G52168	21.61	14.17	7.44	S92	CL1
G52104	24.13	15.82	8.31	S103	CL1	G52169	21.61	14.17	7.44	S92	CL1
G52105	23.3	16.57	6.73	S103	CL1	G52170	20.9	16.02	4.88	S92	CL1
G52106	23.3	16.57	6.73	S103	CL1	G52171	20.9	16.02	4.88	S92	CL1

SPECIFICATIONS BY PART NUMBER

ULTRA STRUTS (CONT'D)

CATALOG PART NO.	EXTENDED LENGTH	COLLAPSED LENGTH	STROKE	UPPER MTG CODE	LOWER MTG CODE	CATALOG PART NO.	EXTENDED LENGTH	COLLAPSED LENGTH	STROKE	UPPER MTG CODE	LOWER MTG CODE
G52172	20.66	16.32	4.33	S110	CL3	G52282	20.83	13.86	6.97	S120	CL1
G52173	21.61	15.23	6.38	S100	CL1	G52283	20.83	13.86	6.97	S120	CL1
G52174	21.61	15.23	6.38	S100	CL1	G52293	24.4	15.59	8.81	S80	CL1
G52175	20.86	13.85	7	S110	CL1	G52294	24.4	15.59	8.81	S80	CL1
G52176	20.86	13.85	7	S110	CL1	G52295	20.43	15.78	4.63	S111	CL1
G52182	25.35	16.18	9.17	S80	CL1	G52297	16.45	11.14	5.31	S104	LP1
G52183	25.35	16.18	9.17	S80	CL1	G52298	16.45	11.14	5.31	S104	LP1
G52184	22.75	14.96	7.79	S110	CL1	G52299	20.62	15.11	5.51	S80	CL1
G52185	22.75	14.96	7.79	S110	CL1	G52300	20.62	15.11	5.51	S80	CL1
G52187	23.26	14.8	8.46	S104	CL1	G52301	20.23	14.68	5.55	S114	LP5
G52188	23.26	14.8	8.46	S104	CL1	G52314	20.98	16.34	4.65	S116	LP3
G52199	19.44	14.76	4.68	S116	LP6	G52329	20.74	13.5	7.24	S92	CL1
G52200	19.44	14.76	4.68	S116	LP6	G52330	20.74	13.5	7.24	S92	CL1
G52201	22.51	15.94	6.57	S103	CL1	G52331	19.48	12.71	6.77	S103	CL1
G52202	22.51	15.94	6.57	S103	CL1	G52332	19.48	12.71	6.77	S103	CL1
G52203	26.33	17.95	8.38	S116	CL1	G52335	21.46	14.06	7.4	S92	CL1
G52204	26.33	17.95	8.38	S116	CL1	G52336	21.46	14.06	7.4	S92	CL1
G52209	19.21	13.18	6.03	S110	CL1	G52348	26.37	21.53	4.84	S84	LU5
G52210	25.7	17	8.69	S110	CL1	G52349	26.37	21.53	4.84	S84	LU5
G52237	19.64	14.92	4.72	S116	LP6	G52351	24.13	16.69	7.44	S105	CL3
G52238	19.64	14.92	4.72	S116	LP6	G52352	24.13	16.69	7.44	S105	CL3
G52244	23.15	15.82	7.33	S111	CL1	G52353	20.07	13.93	6.14	S100	CL1
G52245	20.51	13.39	7.13	S103	CL1	G52354	20.07	13.93	6.14	S100	CL1
G52246	20.51	13.39	7.13	S103	CL1	G52355	20.43	15.86	4.56	S92	CL1
G52247	20.78	13.66	7.12	S92	CL1	G52356	20.43	15.86	4.56	S92	CL1
G52248	20.78	13.66	7.12	S92	CL1	G52360	24.6	17.04	7.55	S61	CL1
G52249	25.35	16.57	8.77	S104	CL1	G52361	24.6	17.04	7.55	S61	CL1
G52250	17.34	11.25	6.08	S104	CL1	G52374	21.25	15	6.25	S103	CL1
G52253	25.35	16.57	8.77	S104	CL3	G52375	21.25	15	6.25	S103	CL1
G52254	25.35	16.57	8.77	S104	CL3	G52382	17.28	13.3	3.97	S100	CL1
G52255	20.03	13.22	6.81	S80	CL1	G52383	17.28	13.3	3.97	S100	CL1
G52256	20.03	13.22	6.81	S80	CL1	G52395	19.48	12.87	6.61	S103	CL1
G52257	23.5	15.59	7.91	S100	CL1	G52396	19.48	12.87	6.61	S103	CL1
G52258	23.5	15.59	7.91	S100	CL1	G52398	18.62	11.29	7.32	S105	LP4
G52260	25.31	17.28	8.02	S110	CL1	G52399	18.62	11.29	7.32	S105	LP4
G52261	25.31	17.28	8.02	S110	CL1	G52406	22.16	15.66	6.49	S108	CL1
G52264	19.48	12.72	6.77	S103	CL1	G52410	19.76	13.23	6.53	S104	LP3
G52265	19.48	12.72	6.77	S103	CL1	G52411	19.76	13.22	6.53	S104	LP3
G52274	19.72	13.19	6.54	S104	LP1	G52437	20.7	13.54	2.36	S92	CL1
G52275	19.72	13.19	6.54	S104	LP1	G52438	20.7	13.54	2.36	S92	CL1
G52276	18.3	11.3	7.01	S92	LP1	G52439	19.05	13.58	5.47	S100	CL1
G52278	19.45	13.5	5.94	S122	CL1	G52440	19.05	13.58	5.47	S100	CL1
G52279	19.45	13.5	5.94	S122	CL1	G52449	17.91	13.22	4.68	S104	LP1
G52280	19.48	12.87	6.61	S122	CL1	G52450	17.91	13.22	4.68	S104	LP1
G52281	19.48	12.87	6.61	S122	CL1	G52494	20.87	15.16	5.71	S110	CL1

SPECIFICATIONS BY PART NUMBER

ULTRA STRUTS (CONT'D)

CATALOG PART NO.	EXTENDED LENGTH	COLLAPSED LENGTH	STROKE	UPPER MTG CODE	LOWER MTG CODE	CATALOG PART NO.	EXTENDED LENGTH	COLLAPSED LENGTH	STROKE	UPPER MTG CODE	LOWER MTG CODE
G52495	20.87	15.16	5.71	S110	CL1	G56568	25	17.75	7.25	S117	CL1
G52524	21.29	16.41	4.88	S80	CL1	G56571	22.12	14.12	8	S110	CL1
G52525	21.29	16.41	4.88	S80	CL1	G56581	20.74	13.59	7.15	S103	CL1
G52906	21.65	16.06	5.59	S104	CL1	G56582	20.74	13.59	7.15	S103	CL1
G52907	21.65	16.06	5.59	S104	CL1	G56591	17.5	12.12	5.37	SS2	ES185
G55551	24.1	14.50	9.6	S113	CL1	G56597	14.5	9.87	4.62	S102	ES61
G55591	16.94	10.76	6.18	S116	CL1	G56598	19.74	15.23	4.51	S95	ES201
G55661	19.57	11.76	7.81	S114	CL1	G56601	25	17.75	7.25	S117	CL1
G55662	19.57	11.76	7.81	S114	CL1	G56606	19.65	13.23	6.42	S114	LP1
G55675	20.84	12.64	8.20	S116	CL1	G56615	22.62	16.00	6.62	S92	CL1
G55676	20.84	12.64	8.2	S116	CL1	G56616	22.62	16.00	6.62	S92	CL1
G55681	22.44	12.17	10.27	S118	CL1	G56620	18.6	12.14	6.47	S106	CL1
G55697	19.7	13.19	6.51	S106	CL1	G56621	19.12	13.00	6.12	S120	CL1
G55698	19.92	13.14	6.78	S103	CL1	G56622	19.12	13.00	6.12	S120	CL1
G55772	20.35	13.85	6.5	S104	LP3	G56633	20.08	12.52	7.56	S104	CL1
G55774	15.24	10.55	4.7	S45	LP2	G56634	20.08	12.52	7.56	S104	CL1
G55804	18.55	12.05	6.49	S88	ES57	G56635	16.6	10.42	6.18	S120	CL1
G55820	16	11.25	4.75	S51	LP2	G56636	16.6	10.42	6.18	S120	CL1
G55821	23.3	15.95	7.35	S50	ES20	G56637	22.12	14.12	8	S110	CL1
G55825	22.88	17.33	5.55	S114	CL1	G56640	22.12	14.37	7.75	S92	CL1
G55856	23.37	14.26	9.11	S103	LP3	G56641	22.12	14.37	7.75	S92	CL1
G55892	20.19	14.09	6.9	S117	CL1	G56655	20.03	13.38	6.65	S105	LP4
G55896	20.2	14.1	6.10	S117	CL1	G56660	19.62	13.87	5.75	S103	CL1
G55901	20.41	13.65	6.76	S111	LP4	G56661	19.62	13.87	5.75	S103	CL1
G55910	19.23	13.09	6.14	S49	LU1	G56671	20.5	13.62	6.87	S92	CL1
G55911	16.22	9.72	6.5	S18	LU2	G56672	20.5	13.61	6.87	S92	CL1
G55948	16.5	10.71	5.79	S105	CL1	G56679	21.26	15.9	5.36	S103	CL1
G55949	23.13	16.09	7.05	S111	CL1	G56680	21.26	15.9	5.36	S103	CL1
G55993	21.73	15.16	6.57	S103	CL1	G56687	22.56	15.98	6.58	S100	CL1
G55994	21.73	15.16	6.57	S103	CL1	G56688	22.56	15.98	6.58	S100	CL1
G55999	16.79	10.81	5.98	S103	CL1	G56700	17.19	10.57	6.62	S108	CL1
G56506	17.22	10.54	6.68	S116	CL1	G56701	18.49	11.34	7.15	S100	CL1
G56509	16.82	10.66	6.17	S119	CL1	G56718	18.63	11.07	7.57	S69	CL1
G56514	17.22	10.54	6.68	S116	CL1	G56721	18.91	11.48	7.43	S116	CL1
G56516	20.22	14.02	6.2	S104	LP1	G56722	18.91	11.48	7.43	S116	CL1
G56517	20.22	13.94	6.28	S104	LP1	G56728	20.95	12.25	8.7	S103	CL1
G56529	16.9	10.55	6.35	S92	CL1	G56729	20.95	12.25	8.7	S103	CL1
G56530	16.9	10.55	6.35	S92	CL1	G56730	23.72	16.95	6.77	S116	CL1
G56537	23.39	15.00	8.39	S32	CL1	G56731	23.72	16.95	6.77	S116	CL1
G56538	23.39	15.00	8.39	S32	CL1	G56732	22.91	15.41	7.50	S116	CL1
G56539	19.62	13.37	6.25	S100	CL1	G56733	22.91	15.41	7.50	S116	CL1
G56540	19.62	13.37	6.25	S100	CL1	G56734	24.31	17.32	6.99	S116	CL1
G56561	23	16.37	6.62	S100	CL1	G56735	24.31	17.32	6.99	S116	CL1
G56562	23	16.37	6.62	S100	CL1	G56758	21.75	14.50	7.25	S81	CL1
G56565	16.77	11.81	4.96	S102	LP3	G56759	27.75	14.50	13.25	S81	CL1

SPECIFICATIONS BY PART NUMBER

ULTRA STRUTS (CONT'D)

CATALOG PART NO.	EXTENDED LENGTH	COLLAPSED LENGTH	STROKE	UPPER MTG CODE	LOWER MTG CODE
G56773	20.94	12.87	8.07	S112	CL1
G56774	20.94	12.87	8.07	S112	CL1
G56778	21.37	14.37	7	S68	CL1
G56791	20.25	16.12	4.13	S110	CL5
G56792	19.5	16.12	3.38	S112	CL5
G56797	23.82	16.54	7.28	S103	CL1
G56798	23.54	16.34	7.2	S103	CL1
G56799	21.1	14.53	6.57	S120	CL1
G56800	21.1	14.53	6.57	S120	CL1
G56802	20.75	14.12	6.63	S111	CL1
G56807	21	14.25	6.75	S115	LP4
G56809	19.75	13.12	6.62	S117	CL1
G56810	20	13.50	6.5	S117	CL1
G56817	16.59	10.9	5.69	S112	CL1
G56819	21.35	15.18	6.16	S100	CL1
G56820	21.35	15.18	6.16	S100	CL1

CATALOG PART NO.	EXTENDED LENGTH	COLLAPSED LENGTH	STROKE	UPPER MTG CODE	LOWER MTG CODE
G56821	23.27	15.90	7.36	S92	CL1
G56822	23.27	15.90	7.36	S92	CL1
G56836	18.84	13.12	5.72	S100	LP1
G56837	18.84	13.12	5.72	S100	LP1
G56838	21.06	17.99	3.07	S38	ES208
G56839	19.33	13.42	5.91	S38	ES209
G56840	20.51	13.63	6.88	S105	CL3
G56841	20.51	13.63	6.88	S105	CL3
G56842	19.47	13.41	6.06	S32	CL1
G56843	19.47	13.41	6.06	S32	CL1
G56886	20.09	13.79	6.30	S116	CL1
G56887	20.09	13.79	6.30	S116	CL1
G56892	17.87	12.24	5.63	S100	CL1
G56893	17.87	12.24	5.63	S100	CL1
G56894	20.98	14.29	6.69	S92	CL1
G56899	21.1	14.8	6.30	S114	LP5

ULTRA TRUCK SHOCKS

CATALOG PART NO.	EXTENDED LENGTH	COLLAPSED LENGTH	STROKE	UPPER MTG CODE	LOWER MTG CODE
G63173	21.86	13.58	8.28	EB1	EB1
G63183	20.79	13.01	7.78	EB4	EB4
G63299	18.08	11.55	6.53	EB1	EB1
G63306	19.85	12.57	7.28	ES24	ES24
G63326	22.03	13.66	8.37	BP8	ES25
G63347	18.08	11.55	6.53	ES31	ES24
G63349	23.33	14.3	9.03	EB1	ES34
G63350	18.82	11.79	7.03	S1	ES25
G63353	24.74	14.96	9.78	ES27	EB4
G63355	14.98	9.95	5.03	EB1	ES24
G63357	14.98	9.95	5.03	ES24	ES24
G63359	13.7	8.92	4.78	S1	BP13
G63360	15.7	9.92	5.78	S1	BP13
G63366	23.26	14.23	9.03	ES34	ES34
G63375	14.14	9.11	5.03	S12	BP7
G63377	20.08	12.55	7.53	EB1	ES25
G63386	16.11	10.58	5.53	S36	ES25
G63387	23.32	14.04	9.28	S1	ES25
G63394	16.01	10.48	5.53	EB1	ES24
G63403	24.58	14.8	9.78	ES26	ES26
G63404	17.05	11.02	6.03	S1	ES64
G63405	20.01	12.48	7.53	EB1	EB1
G63409	21.48	13.2	8.28	EB1	ES185

CATALOG PART NO.	EXTENDED LENGTH	COLLAPSED LENGTH	STROKE	UPPER MTG CODE	LOWER MTG CODE
G63410	18.55	11.77	6.78	S12	EB1
G63411	18.58	11.8	6.78	ES31	ES26
G63413	20.76	12.98	7.78	ES27	ES27
G63414	15.09	10.06	5.03	S36	ES41
G63418	13.95	9.17	4.78	S1	BP11
G63419	24.08	14.55	9.53	EB1	EB1
G63421	13.7	8.92	4.78	S1	BP30
G63422	24.01	14.48	9.53	BP14	ES34
G63423	16.76	10.73	6.03	ES26	ES26
G63424	20.45	12.67	7.78	S1	BP7
G63425	20.01	12.48	7.53	BP20	EB1
G63426	18.01	11.48	6.53	ES18	ES18
G63432	21.11	12.83	8.28	S1	EB19
G63443	23.33	13.95	9.38	EB1	EB1
G63454	22.79	14.01	8.78	ES141	ES141
G63455	22.98	13.95	9.03	ES83	ES83
G63456	26.85	16.07	10.78	EB1	ES83
G63461	25.51	15.23	10.28	EB1	ES83
G63479	13.95	9.17	4.78	S1	ES113
G63488	26.61	16.33	10.28	BP14	ES34
G63489	14.42	9.64	4.78	S29	BP11
G63490	19.08	12.05	7.03	EB1	ES25
G63492	22.58	13.8	8.78	EB1	EB1

SPECIFICATIONS BY PART NUMBER

ULTRA TRUCK SHOCKS (CONT'D)

CATALOG PART NO.	EXTENDED LENGTH	COLLAPSED LENGTH	STROKE	UPPER MTG CODE	LOWER MTG CODE
G63494	22.39	13.86	8.53	EB2	EB2
G63495	14.95	9.67	5.28	S1	ES64
G63506	21.4	12.64	8.76	S32	S32
G63510	21.29	13.26	8.03	EB19	EB19
G63511	22.45	13.42	9.03	S1	ES25
G63516	22.61	13.58	9.03	S1	EB1
G63524	27.08	16.05	11.03	EB1	ES185
G63525	22.98	13.95	9.03	EB1	ES185
G63546	24.29	15.01	9.25	EB2	S32
G63547	13.61	9.08	4.53	S1	ES113
G63548	21.11	13.08	8.03	S12	EB19
G63600	18.56	11.53	7.03	S32	EB1
G63604	19.74	12.46	7.28	EB1	ES142
G63605	24.24	14.71	9.53	EB19	ES27
G63607	25.58	15.3	10.28	BP14	ES83
G63608	14.56	9.78	4.78	S36	EB1
G63609	16.5	10.97	5.53	ES126	ES128
G63610	21.95	13.17	8.78	S47	EB1
G63611	14.95	9.67	5.28	S1	ES64
G63614	15.09	10.06	5.03	S36	EB1
G63615	23.66	13.88	9.78	S38	S38
G63616	23.78	14.25	9.53	S38	EB19
G63620	19.55	12.27	7.28	EB1	S17
G63622	15.32	10.29	5.03	S36	EB1
G63623	22.57	14.29	8.28	S36	ES83
G63624	20.17	12.64	7.53	S36	ES83
G63625	22.56	13.78	8.78	EB1	ES24
G63635	14.45	9.42	5.03	S1	ES69
G63638	24.33	14.8	9.53	BP14	ES34
G63661	13.8	9.52	4.28	S38	ES34
G63662	24.58	15.05	9.53	ES34	ES34
G63671	22.48	13.7	8.78	ES26	ES26
G63673	22.3	13.77	8.53	S38	ES34
G63674	23.39	14.36	9.03	S38	ES34
G63675	26.86	16.08	10.78	ES34	ES34
G63676	15.48	10.45	5.03	ES69	ES69
G63678	18.09	13.56	4.53	S36	BP7
G63679	25.01	14.98	10.03	BP14	ES83
G63683	21.14	13.36	7.78	EB5	ES24
G63687	19.56	12.03	7.53	S38	EB2
G63689	19.08	12.05	7.03	EB1	EB1
G63690	18.01	11.48	6.53	ES18	ES18
G63692	27.58	16.3	11.28	EB1	EB1
G63694	22.18	13.4	8.78	S38	EB20
G63707	15.89	10.11	5.78	S12	ES64
G63708	19.74	12.46	7.28	ES48	EB19

CATALOG PART NO.	EXTENDED LENGTH	COLLAPSED LENGTH	STROKE	UPPER MTG CODE	LOWER MTG CODE
G63710	18.96	11.93	7.03	S1	ES153
G63712	22.48	13.7	8.78	ES110	ES19
G63714	15.39	9.86	5.53	S62	BP7
G63715	28.55	16.52	12.03	S12	ES171
G63716	16.39	9.86	6.53	S62	ES26
G63717	22.98	13.95	9.03	ES83	ES83
G63720	21.39	12.86	8.53	S36	ES22
G63721	20.21	12.43	7.78	S12	BP11
G63722	19.49	12.21	7.28	BP20	ES24
G63726	21.05	12.77	8.28	S12	EB19
G63772	13.73	9.45	4.28	S36	BP10
G63773	22.98	13.95	9.03	EB1	ES185
G63775	27.08	16.05	11.03	EB1	ES83
G63776	20.76	12.98	7.78	ES83	ES83
G63778	24.55	14.52	10.03	S12	ES171
G63781	18.45	11.93	6.52	S1	ES113
G63782	13.7	9.09	4.61	S1	ES118
G63783	14.59	10.21	4.38	S12	BP11
G63799	18.55	11.77	6.78	S1	ES83
G63803	15.36	10.33	5.03	S12	LU1
G63808	28.86	17.08	11.78	EB1	ES83
G63809	22.98	13.95	9.03	EB1	ES83
G63810	31.6	18.57	13.03	EB1	ES185
G63813	12.23	8.45	3.78	S47	ES17
G63815	21.95	13.17	8.78	S47	ES64
G63817	15.8	11.02	4.78	S12	ES60
G63818	16.51	10.98	5.53	ES126	ES128
G63828	23.16	15.13	8.03	S21	EB20
G63829	22.52	13.74	8.78	ES88	ES65
G63832	17.16	11.38	5.78	S21	ES153
G63837	28.23	17.95	10.28	BP14	ES83
G63842	23.33	14.8	8.53	ES18	ES126
G63844	22.52	13.74	8.78	ES87	ES19
G63845	24.58	14.8	9.78	ES18	ES73
G63847	20.45	12.67	7.78	S1	BP7
G63848	15.87	10.59	5.28	S38	ES34
G63860	24.33	14.39	9.94	S1	EB1
G63862	25.07	14.94	10.13	S1	ES67
G63864	15	10.56	4.44	ES67	ES61
G63866	22.81	14.12	8.69	ES34	ES34
G63867	27.31	16.37	10.94	ES82	ES82
G63868	15.61	10.67	4.94	ES164	ES68
G63869	20.26	12.82	7.44	ES41	ES41
G63870	24.89	15.2	9.69	ES82	ES82
G63872	21.65	13.29	8.36	ES128	ES128
G63873	15.75	10.56	5.19	ES82	ES82

SPECIFICATIONS BY PART NUMBER

ULTRA TRUCK SHOCKS (CONT'D)

CATALOG PART NO.	EXTENDED LENGTH	COLLAPSED LENGTH	STROKE	UPPER MTG CODE	LOWER MTG CODE	CATALOG PART NO.	EXTENDED LENGTH	COLLAPSED LENGTH	STROKE	UPPER MTG CODE	LOWER MTG CODE
G63875	17.67	11.73	5.94	ES13	ES13	G64006	22.75	13.81	8.94	S1	ES81
G63878	24.16	14.97	9.19	ES34	ES13	G64008	21.79	13.6	8.19	S57	ES26
G63879	23	14.31	8.69	BP10	ES34	G64009	23.29	14.25	9.04	S38	ES34
G63882	21	13.31	7.69	BP10	ES34	G64010	26.94	16	10.94	EB1	ES83
G63883	22.82	14.38	8.44	ES49	ES49	G64011	23.36	14.21	9.15	S62	ES87
G63884	14.72	9.78	4.94	S47	EB13	G64012	24.11	15.17	8.94	ES88	ES69
G63885	22.24	13.56	8.68	S59	ES36	G64013	26.52	16.33	10.19	ES34	ES34
G63886	20.8	13.36	7.44	S38	ES34	G64014	22.75	14.56	8.19	ES47	ES45
G63888	31.36	18.67	12.69	EB1	ES83	G64015	21.32	13.63	7.69	ES45	ES128
G63889	20.44	12.75	7.69	S1	ES81	G64016	15.91	11.22	4.69	ES19	ES17
G63890	23.97	15.28	8.69	ES87	ES87	G64026	16.26	11.57	4.69	ES61	ES61
G63891	23.97	15.28	8.69	ES87	ES87	G64027	13.62	8.74	4.88	S47	ES118
G63892	23.97	15.28	8.69	ES19	ES87	G64028	20.75	13.19	7.56	EB16	ES113
G63893	15.07	10.44	4.63	S11	LU1	G64029	21.73	13.54	8.19	S38	ES36
G63894	12.82	8.88	3.94	S11	BP9	G64030	22.56	13.86	8.70	S38	ES36
G63895	14.12	9.68	4.44	S11	BP9	G64031	21.19	13.5	7.69	EB1	ES34
G63896	22.36	13.92	8.44	BP14	ES34	G64032	18.7	12.09	6.61	ES49	ES49
G63897	23.87	14.68	9.19	BP14	ES34	G64033	14.72	10.36	4.36	ES51	ES51
G63902	12.6	8.59	4.01	S1	ES64	G64037	26.37	15.47	10.9	S55	ES147
G63903	14.7	9.34	5.36	S1	BP14	G64038	24.48	15.07	9.41	S63	ES69
G63904	14.95	9.95	5.00	S1	ES64	G64040	15.9	11.1	4.8	ES42	ES50
G63905	14.7	9.34	5.36	S1	ES76	G64042	14.92	10.55	4.37	ES18	ES18
G63907	20.23	12.37	7.86	EB1	EB1	G64043	14.09	9.68	4.41	S61	BP38
G63909	14.11	9	5.11	S1	ES17	G64046	18.62	14.72	3.9	S65	ES93
G63915	13.2	8.59	4.61	S1	BP7	G64047	25.03	15	10.03	S56	ES67
G63918	21.25	13.56	7.69	ES34	ES141	G64048	17.16	11.57	5.59	ES75	ES113
G63923	19.89	12.28	7.61	EB1	EB1	G64049	14.96	11.65	3.31	S51	ES55
G63928	22.73	13.87	8.86	EB1	EB1	G64050	19.55	12.91	6.65	ES30	ES137
G63929	14.72	9.71	5.01	S36	EB1	G64052	20.86	13.11	7.75	ES83	ES83
G63937	14.7	9.34	5.36	S1	BP19	G64056	20.51	13.11	7.4	S18	ES83
G63940	24.2	14.09	10.11	S1	ES17	G64063	19.17	13.26	5.9	ES201	ES141
G63950	14.2	9.09	5.11	S1	BP7	G64071	18.66	12.12	6.53	ES167	ES113
G63958	13.8	9.13	4.67	S29	BP13	G64079	29.37	17.32	12.05	ES83	ES83
G63959	24.78	15.84	8.94	ES34	ES34	G64080	21.57	17.72	3.85	ES69	ES33
G63961	26.51	16.12	10.39	ES34	ES34	G64087	22.63	13.78	8.85	S29	ES36
G63962	26.05	15.87	10.18	ES34	ES34	G64089	20.43	13.03	7.4	ES56	ES56
G63965	24.14	15.2	8.94	BP14	ES34	G64101	23.81	15.7	8.11	ES35	ES35
G63966	22.45	14.5	7.95	BP18	ES26	G64104	21.54	14.25	7.29	BP36	ES33
G63967	22.62	14.43	8.19	BP18	ES26	G64111	26.54	15.71	10.83	S57	ES123
G63969	20.75	13.31	7.44	S62	ES34	G64121	25.35	16.17	9.18	ES34	ES34
G63971	27.58	17.14	10.44	ES34	ES34	G64140	22.4	14.02	8.39	ES45	ES45
G64000	27.36	17.68	9.68	ES34	ES34	G64143	18.9	12.8	6.1	ES210	ES67
G64001	14.67	11.47	3.20	S11	LU1	G64146	18.34	11.77	5.78	ES69	ES69
G64002	20.15	13.96	6.19	ES83	ES83	G64148	18.39	14.09	4.3	LU1	DS1
G64003	16.84	11.28	5.56	ES69	ES69	G64151	16.26	11.46	4.8	ES61	ES61

SPECIFICATIONS BY PART NUMBER

ULTRA TRUCK SHOCKS (CONT'D)

CATALOG PART NO.	EXTENDED LENGTH	COLLAPSED LENGTH	STROKE	UPPER MTG CODE	LOWER MTG CODE
G64157	28.27	16.83	11.44	ES82	ES82
G64163	15.45	10.25	5.19	ES153	ES147
G64164	19.95	12.81	7.14	ES210	ES13
G64177	25.86	16.1	9.76	ES216	ES19

CATALOG PART NO.	EXTENDED LENGTH	COLLAPSED LENGTH	STROKE	UPPER MTG CODE	LOWER MTG CODE
G64186	19.01	12.79	6.22	ES56	ES147
G64216	22.8	14.18	8.62	ES36	ES36
G64268	31.34	18.7	12.64	EB1	ES56
G64269	26.93	16.04	10.89	EB1	ES56

DISPOSAL OF OLD OR DEFECTIVE GAS-PRESSURIZED SHOCKS & STRUTS

STORAGE OF USED SHOCK ABSORBERS AND STRUTS

Used struts and shocks should be stored so that any oil leakage will be properly collected. Those containers used to store this product should be labeled "USED OIL".

Used struts and shocks can either be punctured to recycle the shock oil or disposed of in a manner consistent with local or state programs.

RECYCLING OF SHOCK AND STRUT OIL

1. FOR YOUR SAFETY, ALWAYS WEAR SAFETY GLASSES AND PROTECTIVE GLOVES WHEN PUNCTURING STRUTS AND SHOCKS.
2. Securely mount the strut or shock in a vice in the horizontal position. Make sure that the piston rod is fully extended prior to drilling the unit (Fig. #1).
3. Using a 1/16" or 1/8" drill bit, drill a hole in a downward direction approximately 1.0" from the bottom of the strut or shock (Fig #2). It is important to cover the area where the hole is being drilled with a towel or some type of shield to prevent spraying gas and oil upon initial penetration of the drill bit.
4. After the gas pressure is released continue drilling into the inner cylinder of the strut or shock unit, approximately 1/2" deep. Drill a second 1/2" hole near the top of the unit.
5. Remove the strut or shock from the vice and hold it over a container to collect the used oil. Hand stroke the unit to completely purge the oil from the cylinder of the unit (Fig #3).
6. Collect all used oil, **being careful not to mix this oil with any other waste or refuse**. Store in DOT approved containers labeled "USED OIL".
7. Dispose of the remaining strut or shock body and internal parts in accordance with local or state regulations (e.g., scrap metal recycler).
8. Store, dispose, and/or transport used oil in accordance with EPA regulations and your state's used oil program.

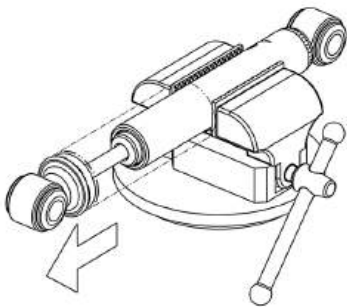

FIG. #1

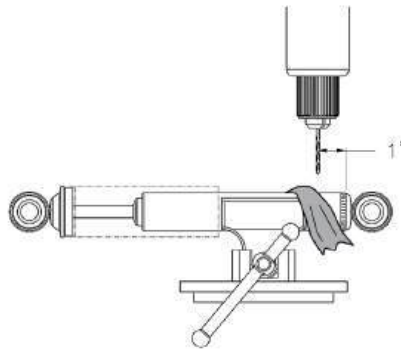

FIG. #2

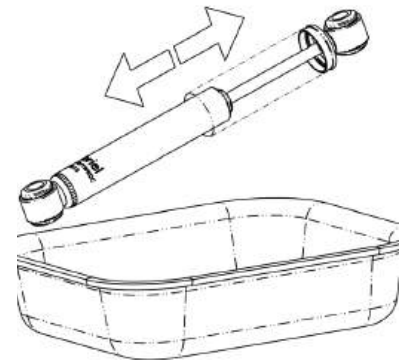

FIG. #3

DISPOSITION DE VIEUX OU DÉFECTUEUX CHOCS ET DE CONTREFICHES DE GAS-PRESSURIZED STOCKAGE DES AMORTISSEURS ET DES CONTREFICHES UTILISÉS

Des contrefiches utilisées et les chocs devraient être stockés de sorte que n'importe quelle fuite d'huile soit correctement rassemblée. Ces récipients stockaient ce produit devraient être marqués "HUILE USÉE".

Des contrefiches utilisées et les chocs peuvent se crever pour réutiliser l'huile de choc ou en quelque sorte le conformé débarassé aux programmes de gens du pays ou d'état.

RÉUTILISATION DU CHOC ET DE L'HUILE DE CONTREFICHE

1. POUR VOTRE SÛRETÉ, TOUJOURS VERRES DE SÛRETÉ D'USAGE ET GANTS PROTECTEURS EN CREVANT DES CONTREFICHES ET DES CHOCS.
2. Montez solidement la contrefiche ou la choquez dans un vice en position horizontale. Assurez-vous que la tige de piston est entièrement prolongée avant de forer l'unité (Fig. # 1).
3. Emploi d'un morceau de foret de 1/16" ou de 1/8", forez un trou dans un sens de haut en bas approximativement 1.0" du fond de la contrefiche ou le choquez (Fig. # 2). Il est important de couvrir le domaine où le trou est foré avec un essuie-main ou un certain type d'écran protecteur pour empêcher pulvériser le gas et le pétrole sur la pénétration initiale du morceau de foret.
4. Après que la pression de gaz soit libérée continuent de forer dans le cylindre intérieur de la contrefiche ou choquez l'unité, approximativement 1/2" profondément. Trou forez deuxième 1/2" près du dessus de l'unité.
5. Enlevez la contrefiche ou la choquez du vice et tenez-l'au-dessus d'un récipient pour rassembler la huile usée. Course de main l'unité pour purger complet l'huile du cylindre de l'unité (Fig. # 3).
6. Rassemblez toute la huile usée, **faisant attention à ne pas mélanger cette huile à tout autre erte ou à ne pas refuser.** Le magasin dans le POINT a reconnu des récipients marqués "HUILE USÉE."
7. Débarassez-vous de la contrefiche restante ou choquez le corps et les pièces internes selon les règlements de gens du pays ou d'état (e.g., recycleur en métal de chute).
8. Magasin, disposez, etou le transport a employé l'huile selon des règlements d'EPA et le programme de la huile usée de votre état.

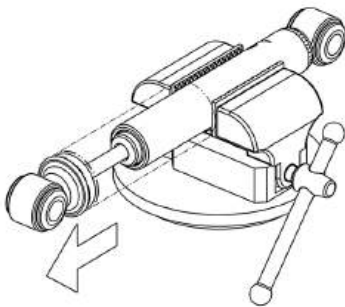

FIG. #1

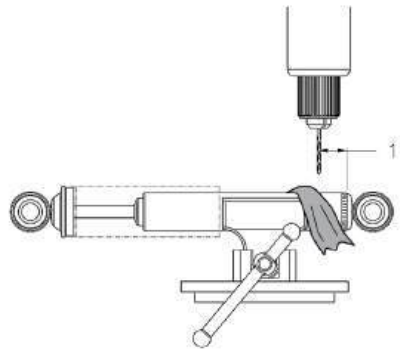

FIG. #2

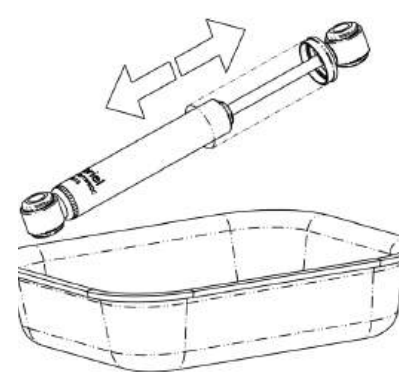

FIG. #3

COMO DESHACERSE DE AMORTIGUADORES Y STRUTS VIEJOS O DEFECTUOSOS -SIN PRESURIZACION CON GAS ALMACENAJE DE AMORTIGUADORES Y STRUTS USADOS

Los struts y amortiguadores deben almacenarse para que el aceite se pueda recoger. Los recipientes que se usen para almacenar este producto deben tener una etiqueta que diga: "ACEITE USADO".

Los struts y amortiguadores pueden ser perforados para reciclar el aceite o deshacerse de una manera constante con un programa local o del estado.

RECYCLAJE DEL ACEITE DE AMORTIGUADOR Y STRUT

1. PARA SU SEGURIDAD, SIEMPRE USE ANTEOJOS DE SEGURIDAD Y GANTES CUANDO PERFORE LOS STRUTS Y LOS AMORTIGUADORES.
2. Asegure la montura del strut o amortiguador sobre una manija horizontalmente. Asegúrese de que la varilla del pistón este totalmente extendida antes de taladrar la unidad (Fig. #1).
3. Use una broca de taladro de 1/16" o de 1/8", taladre un hueco de para abajo, aproximadamente de 1.0" en la parte de abajo del strut o amortiguador (Fig. #2). Es importante cubrir el área en que taladre con una toalla o cualquier otra manera de protección, para evitar que el gas y el aceite salten por todas partes cuando haga la primera incisión con la broca.
4. Después de que la presión del gas salga continúe taladrando dentro del cilindro interior del strut o amortiguador, aproximadamente 1/2" de profundidad. Taladre un Segundo hueco de 1/2" cerca de la parte de arriba de la unidad.
5. Remueva el strut o amortiguador del la manija y sosténgala sobre un recipiente para coleccionar el aceite usado. Sacuda la unidad para sacarle completamente el aceite del cilindro de la unidad (Fig. #3).
6. Recoja el aceite usado, **tenga cuidado de no mezclar este aceite con otro desperdicio o basura.** Almacene en recipientes aprobados por el DOT con una etiqueta que diga: "ACEITE USADO."
7. Deshágase de los sobrados del strut o amortiguador y las partes interiores de acuerdo con las regulaciones locales o del estado (por ejemplo: reciclaje para sobras de metal).
8. Almacene, deshágase, y/o lleve el aceite usado de acuerdo con las regulaciones del EPA y el programa de aceite usado.

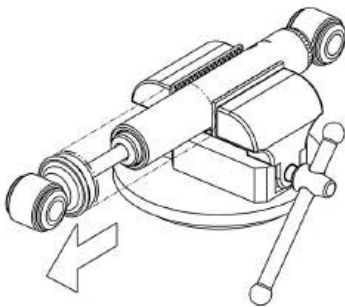

FIG. #1

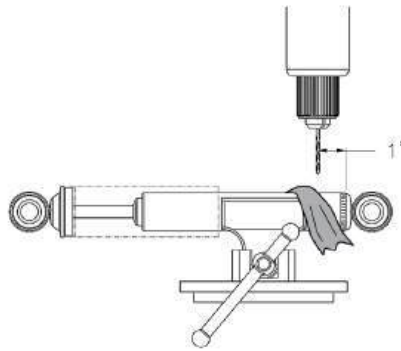

FIG. #2

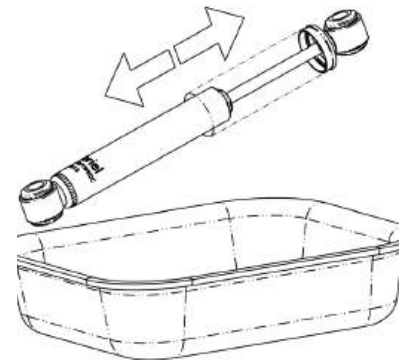

FIG. #3

AIR ADJUSTABLE HOSE KITS

Hose kit **141099** is packaged with all Air Adjustable Shocks listed in this catalog. For those vehicles equipped with G.M. Self-Leveling Systems, it may be necessary to purchase adapter kit **141248**. Hose kit **140656** with separate fill valves can be installed on vehicles to allow Air Adjustable Shocks to be filled individually.

REPLACEMENT AIR FITTINGS KITS

Each kit packaged in individual plastic bags.

KIT PART NUMBER	CONTENTS OF KIT	
140701 Replacement Air Fill Valve.	1 Tee Valve 1 Cap 1 Metal Washer	1 Rubber Washer 2 Nuts 1 Air Pressure Warning Circle

G.M. SELF-LEVELING SYSTEM / HOSE KIT CROSS REFERENCE

General Motors vehicles equipped with factory installed G.M. Self-Leveling Systems require an adapter hose kit to operate with our Air Adjustable Shocks. See chart below for the correct application for your vehicle.

Use of conventional shock absorbers on these applications would require deactivation of the air compressor.

APPLICATION	AIR ADJUSTABLE NO.	HOSE KIT(S) REQUIRED
G.M. vehicles with electrically operated self-leveling system or vacuum operated self-leveling system (except above listings)	Listed with Vehicle	141099 and 141248**

* 141099 and 141248 are packaged with the Air Adjustable shocks. Shown for reference if replacement is required.

** 141099 is packaged with the Air Adjustable shocks. 141248 must be purchased separately and used with hose kit packaged with shocks.

No. 141099 Kit Contains:

- 4 - Tube Nuts
- 4 - Tube Clamps
- 10 - Packing 'O' Rings
- 1 - Tube
- 1 - Tee Block Air Valve Fitting
- 1 - Valve Core
- 6 - Tubing Clips
- 1 - Valve Cap
- 1 - Washer
- 2 - Hex Nuts
- 1 - Seal
- 1 - Warning Tag
- 1 - Instruction Sheet

*** Used in conjunction with Hose Kit #141099.

No. 141248*** Kit Contains:

- 3 - Tube Nuts
- 3 - Tube Clamps
- 8 - Packing 'O' Rings
- 2 - Tubing Clips
- 1 - Valve stem adapter & seal sub-assy
- 1 - Valve stem adapter
- 1 - Self-tapping screw
- 1 - Coupling (brass)
- 1 - Compression Spring
- 1 - Valve core
- 1 - Tee clip
- 1 - Valve cap
- 1 - Instruction sheet

EQUIPOS DE MANGUERA DE AIRE AJUSTABLE

El paquete de manguera **141099** viene con todos los Amortiguadores de Aire Ajustables en este catalogo. Para los autos equipados con Sistema de Auto Nivelación G.M., puede ser necesario comprar el paquete con adaptador **141248**. El paquete de manguera **140656** con válvulas separadas puede ser instalado en el auto para permitir que los amortiguadores de Aire Ajustable puedan ser cargados individualmente.

PAQUETES PARA REEMPLAZAR EQUIPOS DE AIRE

Cada paquete esta empacado en bolsas plásticas.

NUMERO DE PARTE	CONTENIDO	
140701 Válvula de aire para reemplazo.	1 Válvula de arriba 1 Tapa 1 Arandela de metal	1 Arandela de caucho 2 Tuercas 1 Anillo de alerta de presión de aire

SYSTEMA G.M. AUTO NIVELACION / PAQUETE DE MANGUERA PARA REMISION

Los autos de General Motors con equipos de fábrica de Sistema de Auto-Nivelación G.M. requieren un adaptador de manguera para operar con nuestro Aire Ajustable. Vea la lista de abajo para la aplicación correcta para su auto.

El uso del amortiguador convencional en esta instalación requerirá la desactivación del compresor del aire.

APLICACION	AIR- AJUSTABLE NO.	PAQUETE(S) DE MANGUERA EQUERIDO
Los autos G.M. con sistema de auto-nivelación operados electrónicamente o los operados con sistema de auto nivelación al vacío (excepto los de la lista de arriba)	Información viene en el manual	141099 y 141248**

* 141099 y 141248 están empacados con amortiguadores de Aire Ajustable. En lista como referencia, si es necesario reemplazarlos.

** 141099 esta empacado con los amortiguadores de Aire Ajustable. 141248 deben comprarse separadamente y usarlos con el paquete de manguera empacados con amortiguadores.

No. 141099 Empaque contiene:

- 4 - Tuercas de tubo
- 4 - Ganchos de tubo
- 10 - Empaque de 'O' anillos
- 1 - Tubo
- 1 - Equipo de válvula de aire de bloqueo de arriba
- 1 - Válvula central
- 6 - Agarraderas para tubo
- 1 - Tapa de válvula
- 1 - Arandela
- 2 - Tuercas hexagonales
- 1 - Sello
- 1 - Tiquete de advertencia
- 1 - Hoja de instrucciones

*** Use junto con el paquete de manguera # 141099.

No. 141248*** Empaque contiene:

- 3 - Tuercas de tubo
- 3 - Ganchos de tubo
- 8 - Empaque de 'O' anillos
- 2 - Agarraderas para tubo
- 1 - Válvula con adaptador de tubo & sellado subalterno
- 1 - Válvula con adaptador de tubo
- 1 - Tornillo auto-golpes
- 1 - Combinación (latón)
- 1 - Resorte de compresión
- 1 - Válvula central
- 1 - Agarradera de arriba
- 1 - Tapa de válvula
- 1 - Hoja de instrucciones

ENSEMBLES DE BOYAUX POUR HI JACKER

Kit de tuyau 141099 est emballé avec tous les amortisseurs réglables à Air répertoriés dans ce catalogue.
 Pour les véhicules équipés de systèmes de Self-Leveling de G.M., il peut être nécessaire d'acheter la trousse 141248.
 Kit de tuyau 140656 avec les robinets de remplissage séparé peut être installé sur les véhicules afin de permettre un réglage uniforme de chacun des amortisseurs à Air.

ENSEMBLES DE QUINCAILLERIE DE REMPLACEMENT POUR SYSTEME DE COMPRESSION

Chaque ensemble est emballé individuellement dans des sachets plastiques.

NUMÉRO DE PIÈCE	CONTENU DE L'ENSEMBLE	
140701 Soupape de remplissage d'air de remplacement.	1 Valve en "T" 1 Capuchon 1 Rondelle de métal	1 Rondelle de métal 2 Écrous 1 Anneau indicateur de

LISTE DE RENVOIS POUR ENSEMBLES DE BOYAUX "SELF LEVELING SYSTEM" DE GM

Les véhicules General Motors équipé d'un "Self Leveling System" installé en usine requièrent un ensemble d'adaptateurs de boyaux pour fonctionner avec notre système Hi Jacker. Consultez le tableau ci-dessous pour l'application appropriée à votre véhicule.

Pour utiliser des amortisseurs conventionnels avec ces applications, on doit désactiver le compresseur d'air.

APPLICATION	NUMÉRO AIR RÉGLABLE	ENSEMBLE DE TUYAU REQUIS
G.M. avec système Auto Réglage électrique ou avec système Auto Réglage a air (sauf la liste au dessus)	En vente avec un véhicule	141099 et 141248**

* 141099 et 141248 sont emballés avec les amortisseurs d'Air réglable.
 Voir les références si le remplacement est nécessaire.

** 141099 est emballé avec les Amortisseurs d'Air réglable.
 141248 doit être acheté séparément et utilisé avec l'ensemble de tuyau emballé avec les Amortisseurs.

No 141099 Ensemble:

- 4 - Écrous pour tuyau
- 4 - Colliers de serrage pour tuyau
- 10 - Joints toriques
- 1 - Tuyau
- 1 - Raccord de soupape en "T"
- 1 - Noyau de valve
- 6 - Brides pour tuyau
- 1 - Capuchon de soupape
- 1 - Rondelle
- 2 - Écrous à hexagonaux
- 1 - Joint d'étanchéité
- 1 - Étiquette de prévention
- 1 - Feuille d'instructions

*** Utiliser conjointement avec l'ensemble de boyaux no. 141099.

No 141248 Ensemble:***

- 3 - Écrous pour tuyau
- 3 - Colliers de serrage pour tuyau
- 8 - Joints toriques
- 2 - Brides de tuyau
- 1 - Sous-ensemble d'adaptateurs de corps de valve et de joint d'étanchéité
- 1 - Adaptateur de corps de valve
- 1 - Vis à tôle autotaraudeuse
- 1 - Raccord en cuivre
- 1 - Ressort de compression
- 1 - Obus de valve
- 1 - Bride en "T"
- 1 - Bouchon de valve
- 1 - Feuille d'instructions



HERE TO HELP



800.999.3903 | ANSWERGARAGE.COM

Gabriel®

THE ORIGINAL

Ride Control AnswerGarage/Tech Line:

800.999.3903

For application, technical and product questions
Monday - Friday, 9AM - 4PM ET

Gabriel Customer Service:

800.251.5932

To place and track orders
Monday - Friday, 7AM - 5PM CT

Watch our Videos:

Good Shocks vs. Bad Shocks



HiJackers® Installation



ReadyMount® Installation



Load Carrier™ Installation



MaxControl™ Installation



FIND MORE AT GABRIEL.COM
part lookup, product info, technical help & training



Ride Control, LLC, 39300 Country Club Dr.
Farmington Hills, MI 48331, 248.247.7600