

Gabriel®

THE ORIGINAL

2024

LAST MILE DELIVERY & MEDIUM DUTY
SHOCKS & STRUTS



Gabriel.com

Table of Contents

Last Mile Delivery

Last Mile Delivery Shocks & Struts - Application Listing.....	3
Last Mile Delivery Shocks & Struts - Numerical Listing.....	75

Medium Duty

Medium Duty Shocks - Application Listing.....	96
Medium Duty Shocks - Numerical Listing	267

Competitive & OEM Interchange.....	288
------------------------------------	-----

End Mount Specifications.....	339
-------------------------------	-----

Specifications by End Mount	346
-----------------------------------	-----

Specifications by Part Number.....	359
------------------------------------	-----



Last Mile Delivery Shocks & Struts

(Alphabetical Listing)

(Numerical Listing)

**Amortiguadores y Struts
para entrega de
última final**

(Lista alfabética)
(Listado numérico)

**Amortisseurs et Jambes de Force
pour la livraison du dernier
kilomètre**

(Liste alphabétique)
(Ordre numérique)

Gabriel[®]

THE ORIGINAL



SCAN TO WATCH!

For more information
on Last Mile Delivery



[Gabriel.com/LastMile](https://gabriel.com/LastMile)

APPLICATION GUIDE

Year	Fitment Notes	OEM#								
			Fleetline\ Gas SLX	Classic\ Ultra\ ProGuard\ Guardian	Max Control\ LTV Severe Duty\ Load Carrier	Steering Dampers\ Steering Stabilizer\ Cab Shock	Fleetline\ Gas SLX	Classic\ Ultra\ ProGuard\ Guardian	Max Control\ LTV Severe Duty\ Load Carrier\ HiJackers	Steering Dampers\ Steering Stabilizer\ Cab Shock

CHEVROLET

CHEVROLET

B7

93-02	With 15000, 19000, 21000 lb Multileaf Springs	15174902 22064232			85071
-------	---	----------------------	--	-------	-------	-------	-------	--	-------	-------	-------	-------

C60 KODIAK

90-96	Conventional Cab w/ Front Shock with O.E.M. Number	88982682 15588554 15887728 15174898 19152843 22064230 15123676		83136
	Conventional Cab w/19000, 21000, 23000 lb Taperleaf Springs (EXC Low Profile Vehicle)	22064233			83136
	Truck Cabs with Link Cabmate Model GMC104TK	12020054 12010054 1201-0054 1202-0054	OO	83021	

C70 KODIAK

90-96	Truck Cabs with Link Cabmate Model GMC104TK	12020054 12010054 1201-0054 1202-0054	OO	83021	
-------	---	--	----	-------	-------	-------	-------	--	-------	-------	-------	-------



C3500HD

91-02	HD Solid Front Axle			OO	61543	43163 ^ø 58488
-------	---------------------	--	--	-------	-------	-------	-------	----	-------	-------	-----------------------------	-------

C4500 KODIAK

03-09	C Chassis - Conventional Cab	88982682 15588554 15887728 19152843 22064230 15123676		83136
	C Chassis - Conventional Cab w/19000, 21000, 23000 lb Taperleaf Springs (EXC Low Profile Vehicle)	22064233			83136
	C Chassis - Conventional Cab With 15000, 19000, 21000 lb Multileaf Springs	15174902 88982686 22064232			85071
	Truck Cabs with Link Cabmate Model GMC104TK	12020054 12010054 1201-0054 1202-0054	OO	83021	
90-02	C Chassis - Conventional Cab	88982682 15588554 15887728 19152843 22064230 15123676		83136
	C Chassis - Conventional Cab w/19000, 21000, 23000 lb Taperleaf Springs (EXC Low Profile Vehicle)	22064233			83136
	C Chassis - Conventional Cab With 15000, 19000, 21000 lb Multileaf Springs	15174902 88982686 22064232			85071
83-99	C Chassis - Conventional Cab with 9100 to 17500 lb Rear Axle	22064432	OO		83221

APPLICATION GUIDE

Year	Fitment Notes	OEM#								
			Fleetline\ Gas SLX	Classic\ Ultra\ ProGuard\ Guardian	Max Control\ LTV Severe Duty\ Load Carrier	Steering Dampers\ Steering Stabilizer\ Cab Shock	Fleetline\ Gas SLX	Classic\ Ultra\ ProGuard\ Guardian	Max Control\ LTV Severe Duty\ Load Carrier\ Hijackers	Steering Dampers\ Steering Stabilizer\ Cab Shock

CHEVROLET

CHEVROLET



C5500 KODIAK

03-09	C Chassis - Conventional Cab	88982682 15588554 15887728 19152843 22064230 15123676		83136
	C Chassis - Conventional Cab w/19000, 21000, 23000 lb Taperleaf Springs (EXC Low Profile Vehicle)	22064233		83136
	C Chassis - Conventional Cab With 15000, 19000, 21000 lb Multileaf Springs	15174902 88982686 22064232		85071
	Truck Cabs with Link Cabmate Model GMC104TK	12020054 12010054 1201-0054 1202-0054	O	83021
92-02	C Chassis - Conventional Cab	88982682 15588554 15887728 19152843 22064230 15123676		83136
	C Chassis - Conventional Cab w/19000, 21000, 23000 lb Taperleaf Springs (EXC Low Profile Vehicle)	22064233		83136
	C Chassis - Conventional Cab With 15000, 19000, 21000 lb Multileaf Springs	15174902 88982686 22064232		85071
92-99	C Chassis - Conventional Cab with 9100 to 17500 lb Rear Axle	22064432	O	83221
90-91	C Chassis - Conventional Cab	88982682 15588554 15887728 19152843 22064230 15123676		83136
	C Chassis - Conventional Cab w/19000, 21000, 23000 lb Taperleaf Springs (EXC Low Profile Vehicle)	22064233		83136
	C Chassis - Conventional Cab With 15000, 19000, 21000 lb Multileaf Springs	15174902 88982686 22064232		85071
	C Chassis - Conventional Cab with 9100 to 17500 lb Rear Axle	22064432	O	83221
	Truck Cabs with Link Cabmate Model GMC104TK	12020054 12010054 1201-0054 1202-0054	O	83021
83-89	C Chassis - Conventional Cab with 9100 to 17500 lb Rear Axle	22064432	O	83221

C6500 KODIAK

97-09	Models with Hendrickson Air Suspension with O.E.M. Number	60670-005 060665-003 12474917 15740554 59057-001 47902-29	O	83137
-------	---	--	---	------	------	------	------	------	-------	------	------	------

APPLICATION GUIDE

Year	Fitment Notes	OEM#								
			Fleetline/ Gas SLX	Classic/ Ultra/ ProGuard/ Guardian	Max Control/ LTV Severe Duty/ Load Carrier	Steering Dampers/ Steering Stabilizer/ Cab Shock	Fleetline/ Gas SLX	Classic/ Ultra/ ProGuard/ Guardian	Max Control/ LTV Severe Duty/ Load Carrier/ HiJackers	Steering Dampers/ Steering Stabilizer/ Cab Shock

CHEVROLET

CHEVROLET

C6500 KODIAK (cont)

83-96	Conventional Cab with 9100 to 17500 lb Rear Axle	22064432
-------	--	----------	-------	-------	-------	-------	-------	-------	-------	-------	-------	-------	-------

C7500 KODIAK

97-09	Conventional Cab w/ Front Shock with O.E.M. Number	88982682 15588554 15887728 15174898 19152843 22064230 15123676	83136
	Conventional Cab w/15000, 19000, 21000 lb Multileaf Springs	15174902 88982686 22064232	85071
	Conventional Cab w/19000, 21000, 23000 lb Taperleaf Springs (EXC Low Profile Vehicle)	22064233	83136
	Models with Hendrickson Air Suspension (Stamping number 47902-13)	12474915 15963161	83122 89406
	Truck Cabs with Link Cabmate Model GMC104TK	12020054 12010054 1201-0054 1202-0054	83021
97-99	Conventional Cab with 9100 to 17500 lb Rear Axle	22064432	83221

EXPRESS 4500

09-22	All	61685 G63895	61687 G63897	58638 77638
-------	-----	-------	-------	-----------------	-------	-------	-------	-------	-----------------	----------------	-------	-------	-------

LCF 3500

16-23	All	98381010 98232671	83515
		98380746	83159

LCF 3500HD

18	All	98381010 98232671	83515
		98380746	83159
16-17	All	98381010 98232671	83515
		98380746	83159

P60

92-96	Motorhome Chassis	22064233	83136
-------	-------------------	----------	-------	-------	-------	-------	-------	-------	-------	-------	-------	-------	-------

P6000

92-96	Motorhome Chassis	22064233	83136
-------	-------------------	----------	-------	-------	-------	-------	-------	-------	-------	-------	-------	-------	-------

PICKUP 3/4 TON, C20



75-86	All	61525 81039 G63355
		Crew Cab Pickup	34036 ⁸	G63366
		Standard Cab Pickup	34036 ⁸	61524 81164 G63349	43111 ⁸ 49155 ⁷
63-86	Single System Steering Stabilizer	6802SE ⁸⁴

7 Pair Packs, Air hose kit included.;

8 Pair Packs.;

84 Replacement damper for vehicles with the Gabriel Aftermarket mounting kit;

APPLICATION GUIDE

Year	Fitment Notes	OEM#								
			Fleetline\ Gas SLX	Classic\ Ultra\ ProGuard\ Guardian	Max Control\ LTV Severe Duty\ Load Carrier	Steering Dampers\ Steering Stabilizer\ Cab Shock	Fleetline\ Gas SLX	Classic\ Ultra\ ProGuard\ Guardian	Max Control\ LTV Severe Duty\ Load Carrier\ HiJackers	Steering Dampers\ Steering Stabilizer\ Cab Shock

CHEVROLET

CHEVROLET

PICKUP 3/4 TON, C20 (cont)

73-74	Crew Cab Pickup		O O	61525 81039 G63355	34036 ⁸	O O
	Standard Cab Pickup		O O	O O	61524 81164	43111 ⁸ 49155 ⁷
67-72	All		O O	61525 81039 G63355	34036 ⁸	O O	G63306
	Coil(RearSpringType)		O O	O O	82003	49107 ⁷
	Leaf(RearSpringType)		O O	O O	49162 ⁷
63-66	All		O O	61525 81039 G63355	34036 ⁸	O O	G63306	49162 ⁷
60-62	All		O O	82035	O O	82086

PICKUP 3/4 TON, C25 / C2500

88-00	All		O O	61544 81668 G63489	34073 ⁸ 58489 77489	O O	61543 81667 G63488	43163 ⁸ 49218 ⁷ 58488 77488
92-99	Exc. OE Unit		O O	6853SE ⁸⁶								

PICKUP 3/4 TON, K20

81-86	Exc. Lift Kit		O O	G63347	O O	61524 81164 G63349	43111 ⁸
	Quad Suspension Long Shock; Exc. Lift Kit		O O	61522 ⁵ 81496 ⁹	O O
	Quad Suspension Short Shock; Exc. Lift Kit		O O	61516 ⁹	O O
	Standard Suspension; Exc. Lift Kit		O O	81113 ⁵	O O	49155 ⁷
73-86	All		O O	14017	O O
	Steering Stabilizer		O O	6804SE ⁸⁰								
67-86	Dual System Steering Stabilizer		O O	6802SE ⁸⁴								
75-80	Exc. Lift Kit		O O	61516 ⁵ 81113 ⁵ G63347	O O	61524 81164 G63349	43111 ⁸ 49155 ⁷
73-74	Exc. Lift Kit		O O	61516 ⁵ 81113 ⁵ G63347	O O	61524 81164	43111 ⁸ 49155 ⁷
69-72	Exc. Lift Kit		O O	61516 ⁵ 81113 ⁵ G63347	O O
61-72	Steering Stabilizer		O O	6803SE ⁸⁴								

PICKUP 3/4 TON, K25 / K2500

99-00	Exc. OE Unit		O O	6853SE ⁸⁶								
88-00	All		O O	61542 81726 G63609	58609 77609	O O	61543 81667 G63488	43163 ⁸ 49218 ⁷ 58488 77488

6 It is recommended that when replacing shocks on vehicles with "quad shocks" all 4 shocks should be matched by series.;

8 Pair Packs.;



84 Replacement damper for vehicles with the Gabriel Aftermarket mounting kit;

7 Pair Packs, Air hose kit included.;

80 Mounting bracket not required, install on O.E. Shock Mounts. See Ref. C for optional Steering Stabilizer Boots;

86 Exc. OE Unit;

APPLICATION GUIDE

Year	Fitment Notes	OEM#								
			Fleetline/ Gas SLX	Classic/ Ultra/ ProGuard/ Guardian	Max Control/ LTV Severe Duty/ Load Carrier	Steering Dampers/ Steering Stabilizer/ Cab Shock	Fleetline/ Gas SLX	Classic/ Ultra/ ProGuard/ Guardian	Max Control/ LTV Severe Duty/ Load Carrier/ HiJackers	Steering Dampers/ Steering Stabilizer/ Cab Shock

CHEVROLET

CHEVROLET

PICKUP 3/4 TON, R20

87-88	All		O O	61525 81039 G63355	O O	
	Crew Cab Pickup		O O	34036 ⁸	O O	G63366
	Single System Steering Stabilizer		O O	6802SE ⁸⁴								
87	Standard Cab Pickup		O O	O O	61524 81164 G63349	43111 ⁸ 49155 ⁷

PICKUP 3/4 TON, R2500

89	All		O O	61525 81039 G63355	34036 ⁸	O O	G63366
	Single System Steering Stabilizer		O O	6802SE ⁸⁴								

PICKUP 3/4 TON, SILVERADO 2500

11-18	All		O O	O O	G64121
05-08	All		I O	61663 81925 G63817	58817 77817	O O	61642 81921 G63675	58412 77412
99-04	All		O O	O O	61642 81921 G63675	58412 77412
	4WD		I O	61663 81925 G63817	58817 77817	O O
	RWD, Exc. Electronic Adjustable Suspension		I O	61641 81920 G63783	77783	O O

PICKUP 3/4 TON, SILVERADO 2500 HD

11-23	All		O O	G64148	O O	G64121	43181 ⁸ 77976
05-10	9200# GVW		I O	61663 G63817	58817 77817	O O
01-10	All		O O	O O	61642 81921 G63675	58412 77412
01-09	9200# GVW w/ OE Unit - 15059138 15155638		O O	6853SE ⁸²								
	9200# GVW w/o OE Unit - 15059138 15155638		O O	6803SE ⁸⁴								
01-04	9200# GVW		I O	58817 77817	O O
	4WD, 9200# GVW		I O	61663 G63817	O O
	RWD		I O	61641 81920 G63783	77783	O O

PICKUP 3/4 TON, V20

87	All		O O	14017	O O	49155 ⁷
	Exc. Quad Suspension and Lift Kit		O O	61516 G63347	O O	61524 81164 G63349	43111 ⁸
	Quad Suspension Long Shock; Exc. Lift Kit		O O	61522 ⁶ 81496 ⁶	O O
	Dual System Steering Stabilizer		O O	6802SE ⁸⁴								



6 It is recommended that when replacing shocks on vehicles with "quad shocks" all 4 shocks should be matched by series.; 7 Pair Packs, Air hose kit included.;

82 Use kit if listed, See Ref. C for optional Steering Stabilizer Boots.;

8 Pair Packs.;

84 Replacement damper for vehicles with the Gabriel Aftermarket mounting kit;

APPLICATION GUIDE

Year	Fitment Notes	OEM#								
			Fleetline\ Gas SLX	Classic\ Ultra\ ProGuard\ Guardian	Max Control\ LTV Severe Duty\ Load Carrier	Steering Dampers\ Steering Stabilizer\ Cab Shock	Fleetline\ Gas SLX	Classic\ Ultra\ ProGuard\ Guardian	Max Control\ LTV Severe Duty\ Load Carrier\ HiJackers	Steering Dampers\ Steering Stabilizer\ Cab Shock

CHEVROLET

CHEVROLET

PICKUP 3/4 TON, V20 (cont)

87	Steering Stabilizer		O	O					6804SE ⁸⁰
----	---------------------	--	---	---	--	--	--	--	----------------------

PICKUP 1 TON, C30

75-86	All		O	O	61525 81039 G63355	34036 ⁸			O		G63366		
	Single System Steering Stabilizer; with Cooler		O	O	6802SE ⁸⁴								

PICKUP 1 TON, C35/3500

98-00	Crew Cab; Exc. HD Straight Front Axle		I	O	61544 G63489	58489			O		G63488		
92-00	Exc. HD Straight Front Axle		I	O	81668	O
	Exc. HD Straight Front Axle		I	O	61544 G63489	58489 77489	O	G63488
	Extended & Standard Cab; Exc. HD Straight Front Axle		I	O	O	81667
91-00	All		I	O	O	49218 ⁷ 77488
88-00	Extended & Standard Cab; Exc. Straight Front Axle		I	O	34073 ⁸	O
92-97	Crew Cab; Exc. HD Straight Front Axle		I	O	61544 G63489	58489 77489	O	G63488
88-91	Cab & Chassis; Exc. HD Solid Front Axle		O	O	61525 81039 G63355	34036 ⁸	O	G63366
91	Extended & Standard Cab; Exc. HD Straight Front Axle		I	O	61544 81668 G63489	58489 77489	O	81667 G63488
88-90	Extended & Standard Cab; Exc. HD Straight Front Axle		I	O	61544 81668 G63489	58489 77489	O	61543 81667 G63488	43163 ⁸ 49218 ⁷ 58488 77488

PICKUP 1 TON, K30

77-86	All		O	O	G63411		14017		O		61642 81921 G63675	58412 77412	
	Dual System Steering Stabilizer		O	O	6802SE ⁸⁴								
	Steering Stabilizer		O	O	6804SE ⁸⁰								
73-74	All		O	O	14017	O

PICKUP 1 TON, K35 / K3500

95-00	Exc. OE Unit		O	O	6853SE ⁸⁶								
88-00	All		O	O	61542 81726 G63609	58609 77609	O	61543 81667 G63488	43163 ⁸ 49218 ⁷ 58488 77488

PICKUP 1 TON, R30

87-88	All		O	O	61525 81039 G63355	34036 ⁸			O		G63366		
	Single System Steering Stabilizer; with Cooler		O	O	6802SE ⁸⁴								

7 Pair Packs, Air hose kit included.;



80 Mounting bracket not required, install on O.E. Shock Mounts. See Ref. C for optional Steering Stabilizer Boots;

86 Exc. OE Unit;

8 Pair Packs.;

84 Replacement damper for vehicles with the Gabriel Aftermarket mounting kit;

APPLICATION GUIDE

Year	Fitment Notes	OEM#								
			Fleetline/ Gas SLX	Classic/ Ultra/ ProGuard/ Guardian	Max Control/ LTV Severe Duty/ Load Carrier	Steering Dampers/ Steering Stabilizer/ Cab Shock	Fleetline/ Gas SLX	Classic/ Ultra/ ProGuard/ Guardian	Max Control/ LTV Severe Duty/ Load Carrier/ HiJackers	Steering Dampers/ Steering Stabilizer/ Cab Shock

CHEVROLET

CHEVROLET

PICKUP 1 TON, R3500

90-91	All		O O	81039 G63411	14017	O O	61642 81921 G63675	58412 77412
89-91	Single System Steering Stabilizer; with Cooler		O O	6802SE ⁸⁴								
89	All		O O	81039	14017	O O
	Exc. Standard Cab		O O	G63411	O O	61642 81921 G63675	58412 77412
	Standard Cab Pickup		O O	61525 G63355	34036 ⁸	O O	G63366

PICKUP 1 TON, SILVERADO 3500

15-18	All		I O	O O	G64121
11-13	All		I O	O O	G64121
01-09	All		I O	61663 81925 G63817	58817 77817	O O	61642 81921 G63675	58412 77412

PICKUP 1 TON, SILVERADO 3500 HD

11-23	All		O O	G64148	O O	G64121	43181 ⁸ 77976
08-10	All		I O	61663 G63817	58817 77817	O O	61642 81921 G63675	58412 77412
07	All		I O	61663 G63817	58817 77817	O O	61642 G63675	58412
	Classic		I O	O O	77412

PICKUP 1 TON, V30

87-88	All		O O	G63411	14017	O O	61642 81921 G63675	58412 77412
-------	-----	--	--------	------	--------	------	-------	--------	------	--------------------------	----------------	------

PICKUP 1 TON, V3000 / V3500

89-91	All		O O	G63411	14017	O O	61642 81921 G63675	58412 77412
-------	-----	--	--------	------	--------	------	-------	--------	------	--------------------------	----------------	------

SILVERADO 2500 HD CLASSIC

07	All		I O	61663 G63817	77817	O O	61642 G63675	58412 77412
	9200# GVW		I O	58817	O O

SILVERADO 3500 CLASSIC

07	All		I O	O O	81921	58412
	Heavy Duty		I O	58817	O O

SILVERADO 4500 HD

19-22	Diesel Low Cab Forward models with 14,000 to 15,000 lb Rear	8983807460 8-98380-746-0	I O	O O	83159
	Diesel Low Cab Forward models with 14,500 lb GVWR	8983810100 8-98381-010-0	I O	83515	O O
	Diesel Low Cab Forward models with 15,000 to 16,000 lb Rear	8983807470 8-98380-747-0	I O	O O	83159
	Diesel Low Cab Forward models with 16,000 lb to 19,500 lb GVWR	8983810120 8-98381-012-0	I O	83515	O O

APPLICATION GUIDE

Year	Fitment Notes	OEM#								
			Fleetline\ Gas SLX	Classic\ Ultra\ ProGuard\ Guardian	Max Control\ LTV Severe Duty\ Load Carrier	Steering Dampers\ Steering Stabilizer\ Cab Shock	Fleetline\ Gas SLX	Classic\ Ultra\ ProGuard\ Guardian	Max Control\ LTV Severe Duty\ Load Carrier\ HiJackers	Steering Dampers\ Steering Stabilizer\ Cab Shock

CHEVROLET

CHEVROLET

SILVERADO 4500 HD (cont)

19-22	Models with 11K, 13.5K or 15.5K VARI-RATE Rear Suspension	4208946C1 4206863C1			83398
	Models with 7,000 to 8,000 lb Front Axle	3989717C1		83135
	Models with IROS Rear	4214011C2			85670
	Models with Taperleaf Front	4109582C1 4089293C1 4109583C1 4207304C1		83397
19-21	Models with 4 x 4 Rear	4109458C2			83243

SILVERADO 5500 HD

19-23	Models with 11K, 13.5K or 15.5K VARI-RATE Rear Suspension	4208946C1 4206863C1			83398
	Models with Taperleaf Front	4109582C1 4089293C1 4109583C1 4207304C1		83397
19-22	Diesel Low Cab Forward models with 14,000 to 15,000 lb Rear	8983807460 8-98380-746-0			83159
	Diesel Low Cab Forward models with 14,500 lb GVWR	8983810100 8-98381-010-0		83515
	Diesel Low Cab Forward models with 15,000 to 16,000 lb Rear	8983807470 8-98380-747-0			83159
	Diesel Low Cab Forward models with 16,000 lb to 19,500 lb GVWR	8983810120 8-98381-012-0		83515
	Models with 4 x 4 Rear	4109458C2			83243
	Models with 7,000 to 8,000 lb Front Axle	3989717C1		83135
	Models with IROS Rear	4214011C2			85670



SILVERADO 6500 HD

19-23	Models with 11K, 13.5K or 15.5K VARI-RATE Rear Suspension	4208946C1 4206863C1			83398
	Models with Taperleaf Front	4109582C1 4089293C1 4109583C1 4207304C1		83397
19-22	Models with 4 x 4 Rear	4109458C2			83243
	Models with 7,000 to 8,000 lb Front Axle	3989717C1		83135
	Models with IROS Rear	4214011C2			85670

T6500

04-09	FL1 Tilt Cab with 8100 lb Axle	22165188 22165187 22064804 22064805		83136
	FL2 Tilt Cab with 5000 to 11000 lb Axle	22166442 22064807		83136

APPLICATION GUIDE

Year	Fitment Notes	OEM#								
			Fleetline/ Gas SLX	Classic/ Ultra/ ProGuard/ Guardian	Max Control/ LTV Severe Duty/ Load Carrier	Steering Dampers/ Steering Stabilizer/ Cab Shock	Fleetline/ Gas SLX	Classic/ Ultra/ ProGuard/ Guardian	Max Control/ LTV Severe Duty/ Load Carrier/ HiJackers	Steering Dampers/ Steering Stabilizer/ Cab Shock

CHEVROLET

CHEVROLET

T6500 (cont)

04-09	FL3 Tilt Cab with 14575 lb Axle	22165189 22064806	 T	83136
04-06	Tilt Cab w/15000, 19000, 21000 lb Multileaf Springs	15174902 22064232	 T	85071
97-02	FL1 Tilt Cab with 8100 lb Axle	22165188 22165187 22064804 22064805	 T	83136
	FL2 Tilt Cab with 5000 to 11000 lb Axle	22166442 22064807	 T	83136
	FL3 Tilt Cab with 14575 lb Axle	22165189 22064806	 T	83136
	Tilt Cab w/15000, 19000, 21000 lb Multileaf Springs	15174902 22064232	 T	85071
97-99	Tilt Cab w/19000, 21000, 23000 lb Taperleaf Springs (EXC Low Profile Veh.)	22064233	 T	83136
99	Models with Hendrickson Air Suspension (Stamping number 47902-13)	12474915 15963161	 O	83122 89406

VAN 3/4 TON, G / EXPRESS

21-23	All		 O	61685 G63895	 O	61687 G63897	43180 ⁶
17-20	All		 O	61685 G63895	 O	61687 G63897	43180 ⁶ 77638
10-16	All		 O	 O	61687 G63897	43180 ⁶ 77638
03-16	Coil(FrontSpringType)		 O	61685 G63895	 O
03-12	Torsion Bar (FrontSpringType)		 O	61683 G63893	 O
07-09	All		 O	 O	61687 G63897	43180 ⁶ 58638 77638
03-06	All		 O	 O	61687 G63897	43180 ⁶ 77638
96-02	Exc. 8600# GVW		 O	61555 81713 ⁵ G63375 ⁵	34073 ⁸ 77375	 O	61565 G63638	43180 ⁶ 49231 ⁷ 58638 77638
78-95	All		 O	G63357 ⁵	 O
	Exc. 8600# GVW		 O	61517	58357	 O	61522 81496 ⁶ G63413	49212 ⁷
70-95	Single System Steering Stabilizer		 O	6802SE ⁸⁴								
71-77	All		 O	61517 G63357 ⁵	58357	 O	G63306	49162 ⁷
70	All		 O	58357	 O	G63306	49162 ⁷
	Independent Front Suspension		 O	61517 G63357 ⁵	 O
67-69	All		 O	 O	G63306	49162 ⁷

VAN 3/4 TON, P SERIES

79-89	All		 O	61525 81039 G63355	34036 ⁸	 O	G63366	77662
-------	-----	--	-------	------	--------------------------	--------------------	------	-------	------	--------	-------	------

5 Use kit No. 140719 to replace O.E. hardware for lower shock absorber mounting when studs break or self-tapping screws are not longer useable.;



7 Pair Packs, Air hose kit included.;

84 Replacement damper for vehicles with the Gabriel Aftermarket mounting kit;

6 It is recommended that when replacing shocks on vehicles with "quad shocks" all 4 shocks should be matched by series.;

8 Pair Packs.;

APPLICATION GUIDE

Year	Fitment Notes	OEM#								
			Fleetline\ Gas SLX	Classic\ Ultra\ ProGuard\ Guardian	Max Control\ LTV Severe Duty\ Load Carrier	Steering Dampers\ Steering Stabilizer\ Cab Shock	Fleetline\ Gas SLX	Classic\ Ultra\ ProGuard\ Guardian	Max Control\ LTV Severe Duty\ Load Carrier\ HiJackers	Steering Dampers\ Steering Stabilizer\ Cab Shock

CHEVROLET

CHEVROLET

VAN 3/4 TON, P SERIES (cont)

73-78	All		O O	61525 81039 G63355	34036 ⁶	O O	61524 81164 G63349	43111 ⁸ 49155 ⁷
68-72	All		O O	61525 81039 G63355	34036 ⁶	O O	G63306	49162 ⁷
63-67	All		O O	82047	O O
61-62	All		O O	82047	I O	82155	43140 ⁸

VAN 1 TON, G / EXPRESS

23	All		I O	61685 G63895	O O	61687 G63897	43180 ⁸
17-22	All		I O	61685 G63895	O O	61687 G63897	43180 ⁸ 77638
13-16	All		I O	O O	61687 G63897	43180 ⁸ 77638
03-16	Coil(FrontSpringType)		I O	61685 G63895	O O
10-12	All		I O	O O	43180 ⁸ 58638 77638
03-12	Single Rear Wheels		I O	O O	61687 G63897
	Torsion Bar (FrontSpringType)		I O	G63893	O O
07-09	All		I O	O O	43180 ⁸ 77638
03-06	All		I O	O O	43180 ⁸ 58638 77638
97-02	All		I O	61555 81713 ⁵ G63375 ⁵	77375	O O	61565	43180 ⁸ 49231 ⁷
	Exc. 8600# GVW		I O	34073 ⁸	O O	G63638
96	All		O O	61517 61555 81713 ⁵ G63357 G63375 ⁵	58357 77375	O O	43180 ⁸ 49231 ⁷
	Exc. 8600# GVW		I O	34073 ⁸	O O	61565
	Cutaway Van		O O	58357	O O	G63671
94-95	Single System Steering Stabilizer; HD with Straight Front Axle & Tilt Hood		O O	6804SE ⁸⁰								
92-95	9200# GVW		O O	O O	77403
	Cutaway Van		O O	O O	61522 81496 ⁶ G63671	49212 ⁷ 58403
78-95	All		O O	61517 G63357	58357	O O
	Exc. Cutaway Van		O O	O O	G63413
71-95	Single System Steering Stabilizer		O O	6802SE ⁸⁴								
79-91	9200# GVW		O O	O O	G63403	77403
	Cutaway Van		O O	O O	61522 81496 ⁶	49212 ⁷ 58403
78	Cutaway Van		O O	O O	61522 81496 ⁶	49212 ⁷

5 Use kit No. 140719 to replace O.E. hardware for lower shock absorber mounting when studs break or self-tapping screws are not longer useable.;

7 Pair Packs, Air hose kit included.;





80 Mounting bracket not required, install on O.E. Shock Mounts. See Ref. C for optional Steering Stabilizer Boots;

6 It is recommended that when replacing shocks on vehicles with "quad shocks" all 4 shocks should be matched by series.;

8 Pair Packs.;

84 Replacement damper for vehicles with the Gabriel Aftermarket mounting kit;











APPLICATION GUIDE

Year	Fitment Notes	OEM#								
			 Fleetline\ Gas SLX	Classic\ Ultra\ ProGuard\ Guardian	Max Control\ LTV Severe Duty\ Load Carrier	Steering Dampers\ Steering Stabilizer\ Cab Shock	 Fleetline\ Gas SLX	Classic\ Ultra\ ProGuard\ Guardian	Max Control\ LTV Severe Duty\ Load Carrier\ HiJackers	Steering Dampers\ Steering Stabilizer\ Cab Shock

























CHEVROLET

CHEVROLET



VAN 1 TON, G / EXPRESS (cont)

76-77	All			G63357		G63306	49162 ⁷
75	110.0 / 279.4(WheelBase)				G63306	49162 ⁷
	125.0 / 317.5(WheelBase)				G63306	49162 ⁷
	146.0 / 370.8(WheelBase)			61517 G63357	58357	
71-74	All			61517 G63357	58357		G63306	49162 ⁷



VAN 1 TON, P SERIES

86-99	Motorhome Chassis w/ I-Beam Front Suspension			G63625			
85-99	Motorhome Chassis w/ Independent Front Suspension			G63394			
73-99	All				G63366		
92-96	Motorhome Chassis	22064233			83136		
85-93	Single System Steering Stabilizer; w/ I-Beam Front Suspension			6804SE ⁸⁰										
73-90	Cutaway Chassis			61525 81039 G63355	34036 ⁸			
85	Motorhome Chassis w/ I-Beam Front Suspension			G63403	58403 77403			
74-84	Motorhome Chassis			G63394			
68-72	All			34036 ⁸			
	Cutaway Chassis			61525 81039 G63355			
	Exc. 11,000# Rear Axle				G63306	49162 ⁷		
63-67	All			82047			
61-62	All			82047		82155	43140 ⁸		



W4500 TILTMASER

87-10	Models with 11000 lb & 13000 lb Suspension	9516306471 97083029 94454987 98232671 97083027 8972536200 97253620 8-97253-620-0 8944549870 8944549860 9-51630-647-1 8-94454-986-0 8-94454-987-0		83515	
-------	--	--	---	-------	------	------	------	---	------	------	------	------

W5500 TILTMASER

88-10	Models with 11000 lb & 13000 lb Suspension	97253620		83515	
-------	--	----------	---	-------	------	------	------	---	------	------	------	------

W6500 TILTMASER



87-96	Models with 11000 lb & 13000 lb Suspension	1516301681 1-51630-168-1		83515	
-------	--	-----------------------------	---	-------	------	------	------	---	------	------	------	------

7 Pair Packs, Air hose kit included.;

8 Pair Packs.;

80 Mounting bracket not required, install on O.E. Shock Mounts. See Ref. C for optional Steering Stabilizer Boots;

APPLICATION GUIDE

Year	Fitment Notes	OEM#								
			Fleetline\ Gas SLX	Classic\ Ultra\ ProGuard\ Guardian	Max Control\ LTV Severe Duty\ Load Carrier	Steering Dampers\ Steering Stabilizer\ Cab Shock	Fleetline\ Gas SLX	Classic\ Ultra\ ProGuard\ Guardian	Max Control\ LTV Severe Duty\ Load Carrier\ HiJackers	Steering Dampers\ Steering Stabilizer\ Cab Shock

DODGE

DODGE

M300

74	All		O O	G63605	O O	82065 G63183
----	-----	--	--------	------	--------	------	------	--------	------	-----------------	------	------

M350

74	All		O O	G63605	O O	82065
----	-----	--	--------	------	--------	------	------	--------	------	-------	------	------

PICKUP 3/4 TON, D200 SERIES

82-93	All		O O	O O	81091 G63353	49149 ⁷
	Exc. Heavy Duty Package		 O	61523 ³⁵ 81096 ³⁵ G63359 ³⁵	34052 ² 58359 ³⁵	 O
	Heavy Duty Package		 O	81834 G63360 ³⁵	 O
73-93	Single System Steering Stabilizer		O O	6802SE ⁸⁴								
75-81	Heavy Duty Package		 O	G63360 ³⁵	 O
	165.0 / 419.1(WheelBase) Heavy Duty Package		 O	81834	 O
81	All		O O	O O	81091 G63353
	Exc. Heavy Duty Package		 O	61523 ³⁵ 81096 ³⁵ G63359 ³⁵	34052 ² 58359 ³⁵	 O	49149 ⁷
72-80	All		O O	O O	81091 G63353	49149 ⁷
	Exc. Heavy Duty Package		 O	61523 ³⁵ 81096 ³⁵ G63359 ³⁵	34052 ² 58359 ³⁵	 O
72-74	Heavy Duty Package		 O	81834 G63360 ³⁵	 O
60-71	Single System Steering Stabilizer; with I Beam Axle		O O	6802SE ⁸⁴								
60	All		O O	82065	 O

PICKUP 3/4 TON, W200 SERIES

90-93	Single System Steering Stabilizer		O O	6802SE ⁸⁴								
81-93	Exc. Crew Cab & Lift Kit		O O	61632 81825 G63183	O O	81342
69-89	Single System Steering Stabilizer		O O	6803SE ⁸⁴								
60-86	Dual System Steering Stabilizer; Exc. Vacuum Servo Mounted on Drivers Side of Axle		O O	6802SE ⁸⁴								
72-80	All		O O	61632 81825 G63183	O O	81342
69-71	All		O O	61632 81825 G63183	 O
61-67	All		O O	61632 81825 G63183	 O
60-67	Single System Steering Stabilizer		O O	6803SE ⁸⁴								
60	All		O O	82065	 O



7 Pair Packs, Air hose kit included.;

35 Slight grinding of control arm opening is required to install product made before

8 Pair Packs.;

84 Replacement damper for vehicles with the Gabriel Aftermarket mounting kit;

APPLICATION GUIDE

Year	Fitment Notes	OEM#								
			Fleetline\ Gas SLX	Classic\ Ultra\ ProGuard\ Guardian	Max Control\ LTV Severe Duty\ Load Carrier	Steering Dampers\ Steering Stabilizer\ Cab Shock	Fleetline\ Gas SLX	Classic\ Ultra\ ProGuard\ Guardian	Max Control\ LTV Severe Duty\ Load Carrier\ HiJackers	Steering Dampers\ Steering Stabilizer\ Cab Shock

DODGE

DODGE

PICKUP 1 TON, D300 SERIES

75-93	Single System Steering Stabilizer		○	6802SE ⁸⁴								
72-93	All		○	○	81091 G63353	49149 ⁷
	Heavy Duty Package		○	81834 G63360 ³⁵	○
72-74	Single System Steering Stabilizer; with Coil Spring Front Suspension		○	6802SE ⁸⁴								
61-71	All		○	○	82065
60-71	Single System Steering Stabilizer; with I Beam Axle		○	6802SE ⁸⁴								

PICKUP 1 TON, W300 SERIES

90-93	Single System Steering Stabilizer		○	6802SE ⁸⁴								
81-93	Exc. Quad Suspension and Lift Kit		○	61632 81825 G63183	○	81342
60-89	Single System Steering Stabilizer		○	6803SE ⁸⁴								
60-86	Dual System Steering Stabilizer; Exc. Vacuum Servo Mounted on Drivers Side of Axle		○	6802SE ⁸⁴								
72-80	All		○	61632 81825 G63183	○	81342
61-71	All		○	61632 81825 G63183	○	61632 81825 G63183

PICKUP 3/4 TON, RAM 2500 (SEE RAM 2500)

09-10	4WD		○	77948	○	61716
03-10	All		○	○	77950
	4WD, 8800# GVW		○	○	G64013
	RWD		○	77949	○
07-08	4WD		○	61714 G64011	77948	○	61716
03-08	RWD, Crew Cab Pickup		○	○	61710 G63971
00-07	4WD; With OEM # 52106909AB, AC, AD		○	6847SE ⁸²								
06	4WD		○	61714 G64011	○	61716
	4WD; Exc. 5.7L		○	77948	○
	4WD; w/5.7L		○	77980	○
05	4WD		○	61714 G64011	77948	○	61716
03-04	4WD		○	77948	○	61716
03	Exc. 8800# GVW		○	○	61600 81873 G63662
99-02	4WD, Exc. 8800# GVW		○	61634 81919 G63673	77673	○
94-02	Exc. 8800# GVW		○	○	61600 81873 G63662	49235 ⁷ 58662 77662



7 Pair Packs, Air hose kit included.;

82 Use kit if listed, See Ref. C for optional Steering Stabilizer Boots.;

35 Slight grinding of control arm opening is required to install product made before Aug 1988.;

84 Replacement damper for vehicles with the Gabriel Aftermarket mounting kit;

APPLICATION GUIDE

Year	Fitment Notes	OEM#								
			Fleetline\ Gas SLX	Classic\ Ultra\ ProGuard\ Guardian	Max Control\ LTV Severe Duty\ Load Carrier	Steering Dampers\ Steering Stabilizer\ Cab Shock	Fleetline\ Gas SLX	Classic\ Ultra\ ProGuard\ Guardian	Max Control\ LTV Severe Duty\ Load Carrier\ HiJackers	Steering Dampers\ Steering Stabilizer\ Cab Shock

DODGE

DODGE

PICKUP 3/4 TON, RAM 2500 (SEE RAM 2500) (cont)

94-02	4WD, 8800# GVW		 O	61635 G63674	77674	 O	61642 81921 G63675	77675
	RWD		 O	61599 81928 G63661	77661	 O
96-98	4WD, Exc. 8800# GVW		 O	61634 G63673	77673	 O
94-97	4WD; With OEM 52038276		 O	6804SE ⁸⁰								
94-95	4WD, Exc. 8800# GVW		 O	61634 81919 G63673	77673	 O

PICKUP 1 TON, RAM 3500 (SEE RAM 3500)

07-10	4WD		 O	G63673	77948	 O
03-10	All		 O	 O	77950
	RWD		 O	77949	 O
03-07	RWD, Crew Cab Pickup		 O	 O	61710 G63971
00-07	4WD; With OEM # 52106909AB, AC, AD		 O	6847SE ⁸²								
	RWD; With OEM # 52106909AB, AC, AD and Solid Front Axle		 O	6847SE ⁸²								
06	4WD		 O	G63673	 O
	4WD, Exc. 5.9L		 O	77948	 O
	4WD; w/5.7L		 O	77980	 O
03-05	4WD		 O	G63673	77948	 O
94-02	4WD		 O	61635 G63674	77674	 O	61642 81921 G63675	77675
	RWD, Exc. Solid Front Axle		 O	61599 81928 G63661	77661	 O	61600 81873 G63662	43181 ⁸ 49235 ⁷ 58662 77662
	RWD, Solid Front Axle		 O	61635 G63674	77674	 O	61642 81921 G63675	77675
94-97	4WD; With OEM 52038276		 O	6804SE ⁸⁰								
	RWD; w/ OEM 52038276 Solid Front Axle		 O	6804SE ⁸⁰								

RD200

78-80	All		 O	81825 G63183	 O	81342
-------	-----	--	-------	------	-----------------	------	------	-------	------	-------	------	------

SPRINTER 2500

07-09	All		 O	G57802 ⁸⁰	 O
	Single Rear Wheels		 O	 O	G63918
03-06	All		 O	G56778	 O
	Exc. Dual Rear Wheels		 O	 O	G63918

7 Pair Packs, Air hose kit included.;





40 Complete Assembled Unit.;

82 Use kit if listed, See Ref. C for optional Steering Stabilizer Boots.;

8 Pair Packs.;

80 Mounting bracket not required, install on O.E. Shock Mounts. See Ref. C for optional Steering Stabilizer Boots.;









APPLICATION GUIDE

Year	Fitment Notes	OEM#								
			 Fleetline/ Gas SLX	Classic/ Ultra/ ProGuard/ Guardian	Max Control/ LTV Severe Duty/ Load Carrier	Steering Dampers/ Steering Stabilizer/ Cab Shock	 Fleetline/ Gas SLX	Classic/ Ultra/ ProGuard/ Guardian	Max Control/ LTV Severe Duty/ Load Carrier/ HiJackers	Steering Dampers/ Steering Stabilizer/ Cab Shock











DODGE

DODGE















SPRINTER 3500

07-09	All			G57802 ⁴⁰	
	Single Rear Wheels				G63918
03-06	All			G56778	
	Exc. Dual Rear Wheels				G63918





VAN 3/4 TON, A / B SERIES / RAM

81-03	All			61523 ³⁵ 81096 ³⁵ G63359 ³⁵	34052 ⁸ 58359 ³⁵		61522 ⁸ 81496 G63413	43085 ⁸ 49212 ⁷
80-87	Single System Steering Stabilizer			6803SE ⁸⁴								
71-80	All			61523 ³⁵ 81096 ³⁵	34052 ⁸ 58359 ³⁵		61522 ⁸ 81496 G63413	43085 ⁸ 49212 ⁷
	Exc. 4000# Front Axle			G63359 ³⁵	
78-79	Van Charger Special			6803SE ⁸⁴								
71-77	Single System Steering Stabilizer			6803SE ⁸⁴								
71	Single System Steering Stabilizer; with I Beam Axle			6802SE ⁸⁴								







VAN 1 TON, A / B SERIES / RAM

95-03	All			61523 ³⁵ 81096 ³⁵ G63359 ³⁵	34052 ⁸ 58359 ³⁵		61522 ⁸ 81496 G63413	43085 ⁸ 49212 ⁷
94	All				61522 ⁸ 81496	43085 ⁸ 49212 ⁷
	Exc. 4000# Front Axle			61523 ³⁵ 81096 ³⁵ G63359 ³⁵	34052 ⁸ 58359 ³⁵		G63413
71-93	All				61522 ⁸ 81496 G63413	43085 ⁸ 49212 ⁷
	4000# Front Axle			81834 G63360 ³⁵	
	Exc. 4000# Front Axle			61523 ³⁵ 81096 ³⁵ G63359 ³⁵	34052 ⁸ 58359 ³⁵	
71-87	Single System Steering Stabilizer			6803SE ⁸⁴								
71	Single System Steering Stabilizer; with I Beam Axle			6802SE ⁸⁴								

VAN 1 TON, P SERIES

66-72	All				82065
61-64	All				82065

VAN, CB300

78-80	All				61522 ⁸ 81496 G63413	43085 ⁸ 49212 ⁷
	Exc. 4000# Front Axle			61523 ³⁵ 81096 ³⁵ G63359 ³⁵	34052 ⁸ 58359 ³⁵	
74-80	4000# Front Axle			81834 G63360 ³⁵	

6 It is recommended that when replacing shocks on vehicles with "quad shocks" all 4 shocks should be matched by series.;

8 Pair Packs.;



40 Complete Assembled Unit.;

7 Pair Packs, Air hose kit included.;

35 Slight grinding of control arm opening is required to install product made before Aug 1988.;

84 Replacement damper for vehicles with the Gabriel Aftermarket mounting kit.;

APPLICATION GUIDE

Year	Fitment Notes	OEM#								
			Fleetline\ Gas SLX	Classic\ Ultra\ ProGuard\ Guardian	Max Control\ LTV Severe Duty\ Load Carrier	Steering Dampers\ Steering Stabilizer\ Cab Shock	Fleetline\ Gas SLX	Classic\ Ultra\ ProGuard\ Guardian	Max Control\ LTV Severe Duty\ Load Carrier\ HiJackers	Steering Dampers\ Steering Stabilizer\ Cab Shock

DODGE

DODGE

VAN, CB300 (cont)

74-77	Exc. 4000# Front Axle		I ⊖	61523 ³⁵ 81096 ³⁵ G63359 ³⁵
	Up through 8300# GVW		I ⊖	34052 ⁸ 58359 ³⁵
77	All		O O	61522 ⁶ 81496 G63413	43085 ⁶
	Over 8300# GVW		O O	49212 ⁷
75-76	All		O O	61522 ⁶ 81496 G63413	43085 ⁶ 49212 ⁷
74	All		O O	61522 ⁶ 81496 G63413	43085 ⁶
	Over 8300# GVW		O O	49212 ⁷

FORD

FORD

B-600

80-94	B - Series - Bus Cowl Chassis	F1HT18045AA F1HT-18045-AA E0HT18045AA E0HT18045AB E0HT-18045-AB E0HT-18045-AA	O O	83309
-------	-------------------------------	--	--------	-------	------	------	------	------	------	------	------

B-700

80-94	B - Series - Bus Cowl Chassis	F1HT18045AA F1HT-18045-AA E0HT18045AA E0HT18045AB E0HT-18045-AB E0HT-18045-AA	O O	83309
94	Models with with 14600 lb Multileaf Spring	F4HT-18045-EA F4HT18045EA	O O	83125
	Models with with 15000, 17500, 19000 lb Taperleaf Springs	F4HT18080AA F4HT-18080-AB F4HT-18080-AA F4HT18080AB	O O	85314 89425

B-7000

83-87	B - Series - Bus Cowl Chassis	F1HT18045AA F1HT-18045-AA E0HT18045AA E0HT18045AB E0HT-18045-AB E0HT-18045-AA	O O	83309
-------	-------------------------------	--	--------	-------	------	------	------	------	------	------	------

C600

80-86	Models with 3100 lb Spring and 7000 lb Axle	D7HT18045JA D7HT-18045-JA	O O	83308
	Models with 4040, 5040 lb Springs and 7000, 9000, 12000 lb Axles	D2EF18045AA D2EF-18045-AA	O O	83312

C700



80-86	Models with 3100 lb Spring and 7000 lb Axle	D7HT18045JA D7HT-18045-JA	O O	83308
	Models with 4040, 5040 lb Springs and 7000, 9000, 12000 lb Axles	D2EF18045AA D2EF-18045-AA	O O	83312

6 It is recommended that when replacing shocks on vehicles with "quad shocks" all 4 shocks should be matched by series.;

7 Pair Packs, Air hose kit included.;

35 Slight grinding of control arm opening is required to install product made before Aug 1988.;

APPLICATION GUIDE

Year	Fitment Notes	OEM#								
			Fleetline\ Gas SLX	Classic\ Ultra\ ProGuard\ Guardian	Max Control\ LTV Severe Duty\ Load Carrier	Steering Dampers\ Steering Stabilizer\ Cab Shock	Fleetline\ Gas SLX	Classic\ Ultra\ ProGuard\ Guardian	Max Control\ LTV Severe Duty\ Load Carrier\ HiJackers	Steering Dampers\ Steering Stabilizer\ Cab Shock

FORD

FORD

C7000

80-86	Models with 3100 lb Spring and 7000 lb Axle	D7HT-18045JA D7HT-18045-JA	<input type="radio"/>	83308	<input type="radio"/>
	Models with 4040, 5040 lb Springs and 7000, 9000, 12000 lb Axles	D2EF-18045AA D2EF-18045-AA	<input type="radio"/>	83312	<input type="radio"/>

CF7000

96-97	Models with 16000 lb. Multileaf Spring	F6HT-18045-AA F6HT-18045AA	<input type="radio"/>	85054	<input type="radio"/>
92-97	Models with 9000 lb Axle	F2HT-18045CA F2HT-18045BA F2HZ-18124A F2HZ-18124-A F6HT-18045LA F2HT-18045-BA F2HT-18045-CA F6HT-18045-LA	<input type="radio"/>	85376	<input type="radio"/>
86-97	Models with 12000 lb or 13000 lb Axle	87HU-18045-AA 87HU-18045AA E6HZ-18124A E6HZ-18124-A E5HT-18045AA E7HZ-18124A E5HT-18045-AA E7HZ-18124-A	<input type="radio"/>	85301	<input type="radio"/>
	<input type="radio"/>	<input type="radio"/>	85302 89420

E-450 ECONOLINE SUPER DUTY

00-02	All		<input type="radio"/>	G63622	58622 77614	<input type="radio"/>	61646 G63623	58623 77623
	Exc. Cutaway Chassis		<input type="radio"/>	<input type="radio"/>	77623
	Steering Stabilizer		<input type="radio"/>	6828SE ⁸⁰								

E-550 ECONOLINE SUPER DUTY

02	All		<input type="radio"/>	<input type="radio"/>	61655
	Steering Stabilizer		<input type="radio"/>	6828SE ⁸⁰								

E-550 SUPER DUTY

03	All		<input type="radio"/>	<input type="radio"/>	61655
	Steering Stabilizer		<input type="radio"/>	6828SE ⁸⁰								

ECONOLINE SUPER DUTY



96-99	All		<input type="radio"/>	77614	<input type="radio"/>	77623
	Steering Stabilizer		<input type="radio"/>	6828SE ⁸⁰								

EXCURSION

00-05	4WD		<input type="radio"/>	G63809	77809	<input type="radio"/>	G63837	77837
	4WD; With OE Unit		<input type="radio"/>	6854SE ⁸⁰								
	RWD		<input type="radio"/>	G63614	77614	<input type="radio"/>	G63607	77607

80 Mounting bracket not required, install on O.E. Shock Mounts. See Ref. C for optional Steering Stabilizer Boots;

APPLICATION GUIDE

Year	Fitment Notes	OEM#								
			Fleetline\ Gas SLX	Classic\ Ultra\ ProGuard\ Guardian	Max Control\ LTV Severe Duty\ Load Carrier	Steering Dampers\ Steering Stabilizer\ Cab Shock	Fleetline\ Gas SLX	Classic\ Ultra\ ProGuard\ Guardian	Max Control\ LTV Severe Duty\ Load Carrier\ HiJackers	Steering Dampers\ Steering Stabilizer\ Cab Shock



FORD

FORD

F-53

08-23	F-53 Chassis with 16,000 lb GVW to 18,000 lb GVW	9U9Z18125A ASH-1206 ASH137 9U9Z18125B AT-621 ASH-25825 ASH-25824 ASH25825 ASH-1023 ASH25824 ASH-1230 9U9418080AA HU9Z-18125-B ASH1230 ASH1023 9U94-18080-AA 9U9Z-18125-B 9U9Z-18125-A AT621 ASH1206 ASH-137 HU9Z18125B	83122 89406
	F53 Chassis with 24,000 lb GVW to 26,000 lb GVW	ASH1161 ASH25821 ASH-25821 ASH-1161 HU9Z18124A HU9Z-18124-A	85006
	F53 Chassis with 16,000 lb GVW to 22,000 lb GVW	ASH25820 ASH1162 ASH-25820 ASH-1162	85005 89430
06-23	F53 Chassis with 16,000 lb GVW to 22,000 lb GVW	ASH-1229 ASH-1228 9U94-18045-AA ASH-1205 AT-620 ASH25823 ASH-1022 HU9418045BA ASH1022 1C3418045JA ASH-25822 ASH1205 ASH-25823 ASH1228 ASH1229 HU9Z18124B AT620 HU9Z18124C 1C34-18045-JA AT766 9U9Z18124A 9U9Z18124B ASH294 1C3418045AA HU9418045AA ASH-294 9U9418045AA 9U9Z-18124-A ASH25822 AT-766	83209
11-20	F53 Stripped Chassis Commercial Stripped Chassis, 19,500 lb to 22,000 lb GVW	47 1700 007 203 ASH24634 DU94-18045-CB	85013
	F53 Stripped Chassis With BT Delivery Van Pack, 16,000 LB. GVW	471700009775 DU9418080CA DU94-18080-CA 471700007117 DU94-18080-CB DU9418080CB	85010

APPLICATION GUIDE

Year	Fitment Notes	OEM#								
			Fleetline\ Gas SLX	Classic\ Ultra\ ProGuard\ Guardian	Max Control\ LTV Severe Duty\ Load Carrier	Steering Dampers\ Steering Stabilizer\ Cab Shock	Fleetline\ Gas SLX	Classic\ Ultra\ ProGuard\ Guardian	Max Control\ LTV Severe Duty\ Load Carrier\ HiJackers	Steering Dampers\ Steering Stabilizer\ Cab Shock



FORD

FORD

F-53 (cont)

06-07	F-53 Chassis with 16,000 lb GVW to 18,000 lb GVW	9U9Z18125A ASH-1206 ASH137 AT-621 ASH-25824 ASH-1023 ASH25824 ASH-1230 9U9418080AA HU9Z-18125-B ASH1230 ASH1023 9U94-18080-AA 9U9Z-18125-A AT621 ASH1206 ASH-137 HU9Z18125B	83122 89406
99-04	F-53 Chassis with 16,000 lb GVW to 18,000 lb GVW	9U9Z18125A ASH-1206 ASH137 AT-621 ASH-25824 ASH-1023 ASH25824 ASH-1230 9U9418080AA HU9Z-18125-B ASH1230 ASH1023 9U94-18080-AA 9U9Z-18125-A AT621 ASH1206 ASH-137 HU9Z18125B	83122 89406
	F53 Chassis with 16,000 lb GVW to 22,000 lb GVW	ASH-1229 ASH-1228 9U94-18045-AA ASH-1205 AT-620 ASH25823 ASH-1022 HU9418045BA ASH1022 1C3418045JA ASH-25822 ASH1205 ASH-25823 ASH1228 ASH1229 HU9Z18124B AT620 HU9Z18124C 1C34-18045-JA AT766 9U9Z18124A 9U9Z18124B ASH294 1C3418045AA HU9418045AA ASH-294 9U9418045AA 9U9Z-18124-A ASH25822 AT-766	83209

APPLICATION GUIDE

Year	Fitment Notes	OEM#								
			Fleetline\ Gas SLX	Classic\ Ultra\ ProGuard\ Guardian	Max Control\ LTV Severe Duty\ Load Carrier	Steering Dampers\ Steering Stabilizer\ Cab Shock	Fleetline\ Gas SLX	Classic\ Ultra\ ProGuard\ Guardian	Max Control\ LTV Severe Duty\ Load Carrier\ HiJackers	Steering Dampers\ Steering Stabilizer\ Cab Shock

FORD

FORD





F-53 (cont)

88-97	F53 Chassis with 16,000 lb GVW to 22,000 lb GVW	ASH-1229 ASH-1228 9U94-18045-AA ASH-1205 AT-620 ASH25823 ASH-1022 HU9418045BA ASH1022 1C3418045JA ASH-25822 ASH1205 ASH-25823 ASH1228 ASH1229 HU9Z18124B AT620 HU9Z18124C 1C34-18045-JA AT766 9U9Z18124A 9U9Z18124B ASH294 1C3418045AA HU9418045AA ASH-294 9U9418045AA 9U9Z-18124-A ASH25822 AT-766	83209
-------	---	--	-------	------	------	------	------	------	------	------

F-59 COMMERCIAL STRIPPED CHASSIS

11-24	MotorHomes with Ford F59 Commercial Chassis with 24,000 lb GVW to 26,000 lb GVW	ASH1161 ASH25821 ASH-25821 ASH-1161 HU9Z18124A HU9Z-18124-A	85006
11-21	F59 Commercial Chassis with 16,000 lb or 19,500 GVW	471700009775 ASH-12261 DU9418080CA CU9Z18125A BU9Z-18125-A 471700007117 BU9Z18125A ASH12261 DU9Z-18125-A DU9418080CB DU9Z-18125-B CU9Z-18125-A ASH-24523 ASH-24589 ASH24589 DU94-18080-CA ASH-24474 ASH24474 DU94-18080-CB DU9Z18125A DU9Z18125B	85010
	F59 Commercial Chassis with 16,000 lb to 22,000 GVW	ASH-12251 BU9Z-18124-A CU9Z18124A BU9Z18124A DU9Z-18124-A DU9Z-18124-B ASH12251 CU9Z-18124-A DU9Z18124B ASH-24473 ASH24634 ASH-24522 ASH24522 ASH-24634 ASH24473 DU9Z18124A	85013



APPLICATION GUIDE

Year	Fitment Notes	OEM#								
			 Fleetline/ Gas SLX	Classic/ Ultra/ ProGuard/ Guardian	Max Control/ LTV Severe Duty/ Load Carrier	Steering Dampers/ Steering Stabilizer/ Cab Shock	 Fleetline/ Gas SLX	Classic/ Ultra/ ProGuard/ Guardian	Max Control/ LTV Severe Duty/ Load Carrier/ HiJackers	Steering Dampers/ Steering Stabilizer/ Cab Shock

FORD

FORD



F-59 COMMERCIAL STRIPPED CHASSIS (cont)

89-97	F59 Commercial Chassis with 16,000 lb or 19,500 GVW	471700009775 ASH-12261 DU9418080CA CU9Z18125A BU9Z-18125-A 471700007117 BU9Z18125A ASH12261 DU9Z-18125-A DU9418080CB DU9Z-18125-B CU9Z-18125-A ASH-24523 ASH-24589 ASH24589 DU94-18080-CA ASH-24474 ASH24474 DU94-18080-CB DU9Z18125A DU9Z18125B		85010
88-97	F59 Commercial Chassis with 16,000 lb to 22,000 GVW	ASH-12251 BU9Z-18124-A CU9Z18124A BU9Z18124A DU9Z-18124-A DU9Z-18124-B ASH12251 CU9Z-18124-A DU9Z18124B ASH-24473 ASH24634 ASH-24522 ASH24522 ASH-24634 ASH24473 DU9Z18124A		85013
88	F59 Commercial Chassis with 16,000 lb or 19,500 GVW	ASH-12261 CU9Z18125A BU9Z-18125-A BU9Z18125A ASH12261 DU9Z-18125-A DU9Z-18125-B CU9Z-18125-A ASH-24523 ASH-24589 ASH24589 ASH-24474 ASH24474 DU9Z18125A DU9Z18125B		85010

F-200

86-90	All			81490
-------	-----	--	---	-------	-------	-------	-------	-------	-------	-------



F-250 HD

97	All			77809	
	4WD			61614 81821 G63455	77414	61530 81510 G63461	77461
	RWD			61520 81490 G63414	61547 81082 G63406	43167 ^s

F-600

86-94	Models with O.E.M. Number	E6HZ18125D AX-310 AX310 E6HT18080AA ASH-24446 ASH24446 E6HT-18080-AA E6HZ-18125-D		83215
80-94	Exc. 9000 lb Axle with H.D. Suspension & 12000 lb Axle	E0HT18045AA E0HT18045AB E0HT-18045-AB E0HT-18045-AA		83309

APPLICATION GUIDE

Year	Fitment Notes	OEM#								
			Fleetline\ Gas SLX	Classic\ Ultra\ ProGuard\ Guardian	Max Control\ LTV Severe Duty\ Load Carrier	Steering Dampers\ Steering Stabilizer\ Cab Shock	Fleetline\ Gas SLX	Classic\ Ultra\ ProGuard\ Guardian	Max Control\ LTV Severe Duty\ Load Carrier\ HiJackers	Steering Dampers\ Steering Stabilizer\ Cab Shock

FORD

FORD

F-600 (cont)

80-90	Models with 17000 & 18000 lb Rear Axle	D7HT-18080-DA D7HF18080AA D7HT18080DA D7HF-18080-AA	83215
70-90	Models with 13000 & 15000 lb Rear Axle	D7HT18080BA D7HT-18080-BA	83225
90	Models with Multileaf Spring	F1HT18045AA F1HT-18045-AA	83309
83-89	Models with 9000 lb Axle with H.D. Suspension & 12000 lb Axle	D7HT-18045-CA D2HF-18045-AA D2HF18045AA D7HT18045CA	83314

F-600 LPO

90-94	Models with O.E.M. Number	E9HS-18080-AA E9HS18080AA	85716
-------	---------------------------	------------------------------	------	------	------	------	------	-------	------	------	------



F-700

94-98	Models with Taperleaf Springs and with 6000, 7000, 8500, 9000 lb Axle	F4HT18045AC F4HT18045AB F5HZ-18124-A F4HT-18045-AB F4HT-18045-AC F5HZ18124A	83314
	Models with with 15000, 17500, 19000 lb Taperleaf Springs	F4HT18080AA F4HT-18080-AB F5HZ-18125-A F4HT-18080-AA F5HZ18125A F4HT18080AB	85314 89425
86-98	Models with O.E.M. Number	E6HZ18125D AX-310 AX310 E6HT18080AA ASH-24446 ASH24446 E6HT-18080-AA E6HZ-18125-D	83215
94-97	Models with 52" or 54" Taperleaf Springs and with 10000 or 12000 lb Axle	F4HT-18045-DA F5HZ-18124-C F5HZ18124C F4HT18045DA	85063
	w/ Multileaf Spring and w/ 10000, 12000 or 13200 lb Axle	F4HT-18045-CB F5HZ-18124-B F5HZ18124B F4HT18045CB	83107
80-94	Exc. 9000 lb Axle with H.D. Suspension & 12000 lb Axle	E0HT18045AA E0HT18045AB E0HT-18045-AB E0HT-18045-AA	83309
94	Models with with 14600 lb Multileaf Spring	F4HT-18045-EA F5HZ-18124-D F5HZ18124D F4HT18045EA	83125
80-90	Models with 17000 & 18000 lb Rear Axle	D7HT-18080-DA D7HF18080AA D7HT18080DA D7HF-18080-AA	83215
70-90	Models with 13000 & 15000 lb Rear Axle	D7HT18080BA D7HT-18080-BA	83225
90	Models with Multileaf Spring	F1HT18045AA F1HT-18045-AA	83309
83-89	Models with 9000 lb Axle with H.D. Suspension & 12000 lb Axle	D7HT-18045-CA D2HF-18045-AA D2HF18045AA D7HT18045CA	83314

F-700 LPO

90-94	Models with O.E.M. Number	E9HS-18080-AA E9HS18080AA	85716
-------	---------------------------	------------------------------	------	------	------	------	------	-------	------	------	------

APPLICATION GUIDE

Year	Fitment Notes	OEM#								
			Fleetline/ Gas SLX	Classic/ Ultra/ ProGuard/ Guardian	Max Control/ LTV Severe Duty/ Load Carrier	Steering Dampers/ Steering Stabilizer/ Cab Shock	Fleetline/ Gas SLX	Classic/ Ultra/ ProGuard/ Guardian	Max Control/ LTV Severe Duty/ Load Carrier/ HiJackers	Steering Dampers/ Steering Stabilizer/ Cab Shock

FORD

FORD

F-800

94-98	Models with Taperleaf Springs and with 6000, 7000, 8500, 9000 lb Axle	F4HT18045AC F4HT18045AB F5HZ-18124-A F4HT-18045-AB F4HT-18045-AC F5HZ18124A	83314	
	Models with with 15000, 17500, 19000 lb Taperleaf Springs	F4HT18080AA F4HT-18080-AB F5HZ-18125-A F4HT-18080-AA F5HZ18125A F4HT18080AB	85314 89425
94-97	Models with 21000 Taperleaf Springs	F4HT18080BA F4HT-18080-BA	85001 89410
	Models with 52" or 54" Taperleaf Springs and with 10000 or 12000 lb Axle	F4HT-18045-DA F5HZ-18124-C F5HZ18124C F4HT18045DA	85063
86-97	Models with O.E.M. Number	E6HZ18125D AX-310 AX310 E6HT18080AA ASH-24446 ASH24446 E6HT-18080-AA E6HZ-18125-D	83215
80-94	Exc. 9000 lb Axle with H.D. Suspension & 12000 lb Axle	E0HT18045AA E0HT18045AB E0HT-18045-AB E0HT-18045-AA	83309
94	Models with with 14600 lb Multileaf Spring	F4HT-18045-EA F5HZ-18124-D F5HZ18124D F4HT18045EA	83125
	w/ Multileaf Spring and w/ 10000, 12000 or 13200 lb Axle	F4HT-18045-CB F5HZ-18124-B F5HZ18124B F4HT18045CB	83107
80-90	Models with 17000 & 18000 lb Rear Axle	D7HT-18080-DA D7HF18080AA D7HT18080DA D7HF-18080-AA	83215
90	Models with 13000 & 15000 lb Rear Axle	D7HT18080BA	83225
	Models with Multileaf Spring	F1HT18045AA F1HT-18045-AA	83309
83-89	Models with 9000 lb Axle with H.D. Suspension & 12000 lb Axle	D7HT-18045-CA D2HF-18045-AA D2HF18045AA D7HT18045CA	83314
80-89	Models with 13000 & 15000 lb Rear Axle	D7HT18080BA D7HT-18080-BA	83225





F-7000

83-87	Models with 9000 lb Axle with H.D. Suspension & 12000 lb Axle	D7HT-18045-CA D2HF-18045-AA D2HF18045AA D7HT18045CA	83314
80-87	Exc. 9000 lb Axle with H.D. Suspension & 12000 lb Axle	E0HT18045AA E0HT18045AB E0HT-18045-AB E0HT-18045-AA	83309

LN600

80-85	Models with 11000, 13000, 15000, 17000 lb Axles	D7HT18080BA D7HT-18080-BA	83225
	Models with 3000, 3300 lb Springs and 5000, 5500, 6000, 7000 lb Axles	D7HT18045GA D7HT-18045-GA	83308
	Models with 4400 lb Spring and 7000, 9000 lb Axles	D2EF18045AA D2EF-18045-AA	83312





APPLICATION GUIDE

Year	Fitment Notes	OEM#								
			 Fleetline/ Gas SLX	Classic/ Ultra/ ProGuard/ Guardian	Max Control/ LTV Severe Duty/ Load Carrier	Steering Dampers/ Ultra/ Steering Stabilizer/ Cab Shock	 Fleetline/ Gas SLX	Classic/ Ultra/ ProGuard/ Guardian	Max Control/ LTV Severe Duty/ Load Carrier/ HiJackers	Steering Dampers/ Ultra/ Steering Stabilizer/ Cab Shock

FORD

FORD

PICKUP 3/4 TON, F-250 / SUPERDUTY

23	4WD								G64268	77988	
	RWD								G64269	
17-22	4WD				61680	77951	14072			G64268	77988
	RWD					58807 77807				G64269
	RWD, Exc. Off Road				G63622							
13-16	4WD				61680 G63886	77951	14072			61682	77952
	RWD					58807 77807				G63888
12-16	RWD, w/ Off Road Package				G63886					61682	
11-16	RWD, Exc. Off Road				G63622					61713 G64010	
11-12	RWD					58807 77807					
08-12	4WD				61680 G63886	77951	14072			61682 G63888	77952
05-10	RWD				G63622	58807 77807				G64010	
00-10	Steering Stabilizer			6828SE ⁸⁰								
10	RWD, Exc. Off Road									61713	
05-09	RWD, Exc. Off Road				G63622					61713	
99-09	RWD, w/ Off Road				G63886						
05-07	4WD				61680 G63886	77951				61682 G63888	77952
	4WD, Exc. OE Unit			6856SE ⁸⁶								
01-04	4WD				61655 61680 G63809 G63886	58809 77809 77951				61656 G63810	58810 77810
99-04	4WD; Replacement Kit			6855SE ⁸²								
	Exc. OE Unit			6850SE ⁸⁶								
	RWD				G63622	58807 77807				61654 G63808	58808 77808
	RWD, Exc. Off Road				G63622						
99-03	4WD; With OE Unit			6854SE ⁸⁰								
00	4WD				61655 G63809	58809 77809				61656 G63810	58810 77810
97-99	4WD, Up through 8500# GVW				61613 81914 G63716	77716				61612 81913 G63715	77715
	RWD, Up through 8500# GVW				61611 81912 G63714	58714 77714				61638 81892 G63778	49237 ⁷
99	4WD				61655 61680 G63809 G63886	58809 77809 77951				61656 G63810	58810 77810
	Steering Stabilizer			6828SE ⁸⁰	6828SE ⁸⁰ 6861SE ⁸²	6828SE ⁸⁰ 6861SE ⁸²	6828SE ⁸⁰ 6861SE ⁸²		6828SE ⁸⁰ 6861SE ⁸²	6828SE ⁸⁰ 6861SE ⁸²	6828SE ⁸⁰ 6861SE ⁸²	6828SE ⁸⁰ 6861SE ⁸²
98	4WD, Over 8500# GVW				61614 G63455	77455					
	Steering Stabilizer			6861SE ⁸²								



7 Pair Packs, Air hose kit included.;

82 Use kit if listed, See Ref. C for optional Steering Stabilizer Boots.;

80 Mounting bracket not required, install on O.E. Shock Mounts. See Ref. C for optional Steering Stabilizer Boots.;

86 Exc. OE Unit.;

APPLICATION GUIDE

Year	Fitment Notes	OEM#								
			Fleetline\ Gas SLX	Classic\ Ultra\ ProGuard\ Guardian	Max Control\ LTV Severe Duty\ Load Carrier	Steering Dampers\ Steering Stabilizer\ Cab Shock	Fleetline\ Gas SLX	Classic\ Ultra\ ProGuard\ Guardian	Max Control\ LTV Severe Duty\ Load Carrier\ HiJackers	Steering Dampers\ Steering Stabilizer\ Cab Shock

FORD

FORD

PICKUP 3/4 TON, F-250 / SUPERDUTY (cont)

97	4WD, Over 8500# GVW	O O	61614 81821 G63455	77455	O O	61530 81510 G63461	77461
	RWD, Over 8500# GVW	I O	61520 ⁶ 81490 G63414	77414 ⁶	O O	61547 81082 G63406	43167 ⁸ 77809
	Steering Stabilizer	O O	6828SE ⁸⁰	6828SE ⁸⁰ 6861SE ⁸²	6828SE ⁸⁰ 6861SE ⁸²	6828SE ⁸⁰ 6861SE ⁸²	O O	6828SE ⁸⁰ 6861SE ⁸²	6828SE ⁸⁰ 6861SE ⁸²	6828SE ⁸⁰ 6861SE ⁸²
92-96	Steering Stabilizer	O O	6828SE ⁸⁰								
87-96	4WD	O O	61614 81821 G63455	77455	O O	61530 81510 G63461	77461
80-96	4WD; Single System Steering Stabilizer	O O	6802SE ⁸⁴								
	RWD	I O	61520 ⁶ 81490 G63414	77414 ⁶	O O	61547 81082 G63406	43167 ⁸ 77809
96	RWD, Up through 8500# GVW	I O	61611	58714 77714	O O
86	4WD	O O	O O	81510 G63461
	4WD, Clevis Type Lower Front Mount; Exc. Dual Rear Wheels or Lift Kit	O O	O O	61530	77461
82-85	4WD, Clevis Type Lower Front Mount; Exc. Dual Rear Wheels or Lift Kit	O O	O O	61530 81510 G63461	77461
80-82	4WD, Standard Cab Pickup	I O	G63410	O O
82	4WD	I O	61546 ⁶	O O
80-81	4WD	I O	61546 ⁶	O O	61530 81510 G63461	77461
77-79	4WD; Standard Cab, Cab & Chassis; All From Serial No. Y20001	I O	O O	G63387	49178 ⁷
75-79	RWD	I O	G63386	O O
	RWD, Cab & Chassis	I O	O O	81242 G63350	43058 ⁸ 49127 ⁷
	RWD, Extended Cab Pickup	O O	O O	61519 81484 G63377	43058 ⁸ 49127 ⁷
	RWD, Standard Cab Pickup	I O	O O	81242 G63350	43099 ⁸ 49173 ⁷
	RWD; Exc. Extended & Crew Cab	I O	O O	61518
	RWD; Single System Steering Stabilizer	O O	6802SE ⁸⁴								
70-79	RWD, 4WD Quad Suspension Rearward of Front Axle	I O	61521 ⁶ 81394 ⁶	34058 ⁸	O O
78	4WD, Up through Serial No. Y20000	I T	82034	O O
75-77	4WD; Up through Serial No. Y20000	I T	82034	O O	82147
	Single System Steering Stabilizer	O O	6803SE ⁸⁴								

6 It is recommended that when replacing shocks on vehicles with "quad shocks" all 4 shocks should be matched by series.;

8 Pair Packs.;



82 Use kit if listed, See Ref. C for optional Steering Stabilizer Boots.;

7 Pair Packs, Air hose kit included.;

80 Mounting bracket not required, install on O.E. Shock Mounts. See Ref. C for optional Steering Stabilizer Boots.;

84 Replacement damper for vehicles with the Gabriel Aftermarket mounting kit.;

APPLICATION GUIDE

Year	Fitment Notes	OEM#								
			Fleetline\ Gas SLX	Classic\ Ultra\ ProGuard\ Guardian	Max Control\ LTV Severe Duty\ Load Carrier	Steering Dampers\ Steering Stabilizer\ Cab Shock	Fleetline\ Gas SLX	Classic\ Ultra\ ProGuard\ Guardian	Max Control\ LTV Severe Duty\ Load Carrier\ HiJackers	Steering Dampers\ Steering Stabilizer\ Cab Shock

FORD

FORD

PICKUP 3/4 TON, F-250 / SUPERDUTY (cont)

71-74	RWD; Exc. Extended Cab & Chassis Cab		49173 ⁷
70-74	RWD; Exc. Supercab		81242
	RWD; Standard Cab Pickup		43099 ⁸
68-74	4WD; Up through Serial No. Y2000		82147
65-74	Exc. Supercab		G63350
	RWD		61518
	RWD, 4WD Quad Suspension Rearward of Front Axle, Non Quad Suspension	G63386
	RWD; Supercab		G63377
	RWD		43058 ⁸
	RWD; Supercab		61519 81484
60-74	Steering Stabilizer		6803SE ⁸⁴			
74	4WD; Up through Serial No. Y20000		82034
68-73	4WD; Up through Serial No. Y20000		82034
65-69	Supercab		49127 ⁷
	RWD, 4WD Quad Suspension Rearward of Front Axle	61521 ⁸ 81394 ⁸
66-67	4WD; Up through Serial No. Y2000		82034	82147
61-65	4WD		82034
61-64	All		81147	61500 G63405	43048 ⁸
60	All		81270
53-55	All		81676

PICKUP 1 TON, F-350 / SUPERDUTY



23	4WD		G64268	77988
	RWD		G64269
17-22	4WD		61680 G63886	77951	14072	G64268	77988
	RWD		G63622	77807	G64269
13-16	All		61680 G63886	58807 77807
	4WD		61680	77951	14072	G63888	77952
	4WD, Exc. Off Road		G63886
	4WD, w/ Off Road Package		61682
11-16	4WD		77951
	Exc. Off Road		G63622
05-16	RWD		G63622	58807 77807	G64010

6 It is recommended that when replacing shocks on vehicles with "quad shocks" all 4 shocks should be matched by series.;

7 Pair Packs, Air hose kit included.;

84 Replacement damper for vehicles with the Gabriel Aftermarket mounting kit;

APPLICATION GUIDE

Year	Fitment Notes	OEM#								
			Fleetline/ Gas SLX	Classic/ Ultra/ ProGuard/ Guardian	Max Control/ LTV Severe Duty/ Load Carrier	Steering Dampers/ Steering Stabilizer/ Cab Shock	Fleetline/ Gas SLX	Classic/ Ultra/ ProGuard/ Guardian	Max Control/ LTV Severe Duty/ Load Carrier/ HiJackers	Steering Dampers/ Steering Stabilizer/ Cab Shock

FORD

FORD

PICKUP 1 TON, F-350 / SUPERDUTY (cont)

05-16	RWD, Exc. Off Road		I O	O O	61713
11-12	All		I O	61680 G63886	77807	O O
08-12	4WD		I O	61680 G63886	77951	14072	O O
05-12	4WD; Single Rear Wheels; Exc. Cab & Chassis		I O	O O	61682 G63888	77952
99-10	Steering Stabilizer		O O	6828SE ⁸⁰								
99-09	All		I O	61680 G63886	77807	O O
	4WD		I O	77951	O O
	Exc. Off Road		I O	G63622	O O
05-07	4WD		I O	61680 G63886	77951	O O
99-04	4WD		O O	61655 G63809	58809 77809	O O	61656 G63810	58810 77810
	4WD; Replacement Kit		O O	6855SE ⁸²								
	Exc. OE Unit		O O	6850SE ⁸⁶								
	RWD		I O	G63622	58807 77807	O O	61654 G63808	58808 77808
99-03	4WD; With OE Unit		O O	6854SE ⁸⁰								
86-97	4WD		O O	61614 81821 G63455	77455	O O
	4WD, Dual Rear Wheels		O O	O O	61530 81510 G63461	77461
	4WD, Exc. Dual Rear Wheels		O O	O O	G63456
80-97	RWD		I O	61520 ⁶ 81490 G63414	77414 ⁶	O O
	RWD, Dual Rear Wheels		O O	O O	61554 81710 G63409
	RWD, Exc. Dual Rear Wheels		O O	O O	61547 81082 G63406	43167 ⁸ 77809
97	Steering Stabilizer		O O	6802SE ⁸⁴	6802SE ⁸⁴ 6828SE ⁸⁰	6802SE ⁸⁴ 6828SE ⁸⁰	6802SE ⁸⁴ 6828SE ⁸⁰	O O	6802SE ⁸⁴ 6828SE ⁸⁰	6802SE ⁸⁴ 6828SE ⁸⁰	6802SE ⁸⁴ 6828SE ⁸⁰	6802SE ⁸⁴ 6828SE ⁸⁰
			O O	6802SE ⁸⁴								
92-96	RWD; Dual System Steering Stabilizer		O O	6828SE ⁸⁰								
	Steering Stabilizer		O O	6802SE ⁸⁴								
89-91	RWD; Single System Steering Stabilizer		O O	6802SE ⁸⁴								
82-88	RWD; Single System Steering Stabilizer; w/o Anti-Sway Bar		O O	6802SE ⁸⁴								
82-85	4WD, Clevis Type Lower Front Mount; Exc. Dual Rear Wheels or Lift Kit		I O	O O	61530 81510 G63461	77461
80-81	4WD		I O	61546 ⁹ G63410	O O	61530 81510 G63461	77461

6 It is recommended that when replacing shocks on vehicles with "quad shocks" all 4 shocks should be matched by series;

80 Mounting bracket not required, install on O.E. Shock Mounts. See Ref. C for optional Steering Stabilizer Boots;



84 Replacement damper for vehicles with the Gabriel Aftermarket mounting kit;

8 Pair Packs.;

82 Use kit if listed, See Ref. C for optional Steering Stabilizer Boots.;

86 Exc. OE Unit;

APPLICATION GUIDE

Year	Fitment Notes	OEM#								
			Fleetline\ Gas SLX	Classic\ Ultra\ ProGuard\ Guardian	Max Control\ LTV Severe Duty\ Load Carrier	Steering Dampers\ Steering Stabilizer\ Cab Shock	Fleetline\ Gas SLX	Classic\ Ultra\ ProGuard\ Guardian	Max Control\ LTV Severe Duty\ Load Carrier\ HiJackers	Steering Dampers\ Steering Stabilizer\ Cab Shock

FORD

FORD

PICKUP 1 TON, F-350 / SUPERDUTY (cont)

79-81	RWD; Dual System Steering Stabilizer		 O	6802SE ⁸⁴							
75-79	RWD, RWD, 4WD Quad Suspension Rearward of Front Axle, Non Quad Suspension		 O		G63386						
	RWD, Cab & Chassis		 O							43099 ⁸ 49173 ⁷	
	RWD, Extended Cab Pickup		 O						61518 G63350	43099 ⁸ 49173 ⁷	
	RWD, Standard Cab Pickup		 O						61519 81484 G63377	43058 ⁸	
	RWD; Supercab		 O						81242		
73-79	RWD, 4WD Quad Suspension Rearward of Front Axle		 O		61521 ⁸ 81394 ⁸	34058 ⁸					
	RWD; Standard Cab Pickup		 O							49127 ⁷	
79	4WD		 O						G63387	49178 ⁷	
75-78	Dual System Steering Stabilizer		 O	6802SE ⁸⁴							
75-77	Single System Steering Stabilizer		 O	6803SE ⁸⁴							
73-74	RWD; Supercab		 O						G63377		
	RWD; Exc. Supercab		 O						61519 81484		
	RWD; Supercab		 O							43058 ⁸	
67-74	Extended Cab		 O						G63350		
	RWD, 4WD Quad Suspension Rearward of Front Axle, Non Quad Suspension		 O		G63386						
	RWD, Extended Cab		 O						61518		
65-74	Single System Steering Stabilizer; w/ Twin I Beam Axle		 O	6802SE ⁸⁴							
	Steering Stabilizer		 O	6803SE ⁸⁴							
74	RWD, Extended Cab & Chassis		 O							49173 ⁷	
	RWD, Supercab		 O							43099 ⁸	
67-72	RWD, 4WD Quad Suspension Rearward of Front Axle		 O		61521 ⁸ 81394 ⁸						
61-66	All		 O		81147				61500 G63405	43048 ⁸	
60-64	Steering Stabilizer		 O	6802SE ⁸⁴	6802SE ⁸⁴ 6803SE ⁸⁴	6802SE ⁸⁴ 6803SE ⁸⁴	6802SE ⁸⁴ 6803SE ⁸⁴	6802SE ⁸⁴ 6803SE ⁸⁴	6802SE ⁸⁴ 6803SE ⁸⁴	6802SE ⁸⁴ 6803SE ⁸⁴	6802SE ⁸⁴ 6803SE ⁸⁴
60	All		 O						81270		
53-55	All		 O						81676		



PICKUP P350

76	Up through 8000# GVW		 O		61500 G63405						
----	----------------------	--	-------	--	-----------------	--	--	--	--	--	--

6 It is recommended that when replacing shocks on vehicles with "quad shocks" all 4 shocks should be matched by series;

7 Pair Packs, Air hose kit included.;
84 Replacement damper for vehicles with the Gabriel Aftermarket mounting kit;

APPLICATION GUIDE

Year	Fitment Notes	OEM#								
			Fleetline\ Gas SLX	Classic\ Ultra\ ProGuard\ Guardian	Max Control\ LTV Severe Duty\ Load Carrier	Steering Dampers\ Steering Stabilizer\ Cab Shock	Fleetline\ Gas SLX	Classic\ Ultra\ ProGuard\ Guardian	Max Control\ LTV Severe Duty\ Load Carrier\ HiJackers	Steering Dampers\ Steering Stabilizer\ Cab Shock

FORD

FORD

PICKUP P350 (cont)

68-75	Up through 8000# GVW		OO	61500 81147 G63405
68-73	Single System Steering Stabilizer		OO	6802SE ⁸⁴						

PICKUP P400

75-76	Up through 8000# GVW		OO	61500 81147 G63405
-------	----------------------	--	----	------	--------------------------	------	------	------	------	------

PICKUP, F-450 SUPERDUTY

17-23	Models with 4WD and OEM number	ASH-85927 LC3Z-18125-W ASH-866127 ASH-866139 LC3Z-18125-J HC3Z-18125-EP HC3Z-18125-X ASH-85789	OO	77986
	Models with RWD and OEM number	ASH-25770 HC3Z-18125-ED HC3Z-18125-EE HC3Z-18125-B ASH-85857 ASH-85856	OO	77987
13-23	All		I	77967
17-22	4 X 4		OO	14072
13-16	4 X 2		OO	77968
	4 X 4		OO	14072	77969
09-12	All		OO	58944
08-12	4 X 4		OO	14072
07-08	All		O	G63969	58944 77967
05-07	4 X 2		OO	77968
	4 X 4		OO	77969
99-07	Models with single or dual rear wheels with 165" or 201" wheel base	ASH247 AT-611 AT-610 F81Z-18125-DC F81A-18080-DCA F81Z18125DC F81A18080DCA AT610 ASH-23488 AT611 ASH23488 ASH23486 ASH-247 ASH-23486	OO	G63461
05-06	All		I	G63969	77967
99-04	All		OO	61655 G63809	58809 77809	77461
	Steering Stabilizer		OO	6854SE ⁸⁰						
97	All		OO	G63692	61554 G63409	43167 ⁸⁰

PICKUP, F-550 SUPERDUTY



17-23	Models with 4WD and OEM number	ASH-85927 LC3Z-18125-W ASH-866127 ASH-866139 LC3Z-18125-J HC3Z-18125-EP HC3Z-18125-X ASH-85789	OO	77986
-------	--------------------------------	---	----	------	------	------	------	------	-------	------

8 Pair Packs.;

84 Replacement damper for vehicles with the Gabriel Aftermarket mounting kit;

80 Mounting bracket not required, install on O.E. Shock Mounts. See Ref. C for optional Steering Stabilizer Boots;

APPLICATION GUIDE

Year	Fitment Notes	OEM#								
			Fleetline\ Gas SLX	Classic\ Ultra\ ProGuard\ Guardian	Max Control\ LTV Severe Duty\ Load Carrier	Steering Dampers\ Steering Stabilizer\ Cab Shock	Fleetline\ Gas SLX	Classic\ Ultra\ ProGuard\ Guardian	Max Control\ LTV Severe Duty\ Load Carrier\ HiJackers	Steering Dampers\ Steering Stabilizer\ Cab Shock

FORD

FORD

PICKUP, F-550 SUPERDUTY (cont)

17-23	Models with RWD and OEM number	ASH-25770 HC3Z-18125-ED HC3Z-18125-EE HC3Z-18125-B ASH-85857 ASH-85886		77987
13-23	All			77967
17-22	4 X 4			14072	
13-16	4 X 2			77968
	4 X 4			14072		77969
10-12	All			58944
08-12	4 X 4			14072	
05-07	All			G63969	77967
	4 X 2			77968
	4 X 4			77969
99-07	Models with single or dual rear wheels with 165" or 201" wheel base	ASH247 AT-611 AT-610 F81Z-18125-DC F81A-18080-DCA F81Z18125DC F81A18080DCA AT610 ASH-23488 AT611 ASH23488 ASH23486 ASH-247 ASH-23486		G63461
99-04	All			61655 G63809	58809 77809	77461
	Steering Stabilizer			6854SE ⁸⁰								

TRANSIT-150

15-22	All			G57816 ⁴⁰	G64177
-------	-----	--	--	------	----------------------	------	------	--	------	--------	------	------

TRANSIT-250

15-22	All			G57816 ⁴⁰	G64177
-------	-----	--	--	------	----------------------	------	------	--	------	--------	------	------

TRANSIT-350

15-22	All			G57816 ⁴⁰	G64177
-------	-----	--	--	------	----------------------	------	------	--	------	--------	------	------

VAN 3/4 TON, ECONOLINE / CLUB WAGON / SUPERDUTY

03-14	All			81744 ⁴⁸ G63622	34076 ⁸ 58622 77614	61646 81828 G63623	49178 ⁷ 58623 77623
96-04	Steering Stabilizer			6828SE ⁸⁰								
92-02	All			61591 81744 ⁴⁸ G63622	34076 ⁸ 58622 77614	61646 81828 G63623	49178 ⁷ 58623 77623
75-91	All			81394	G63387	49178 ⁷
	RWD, 4WD Quad Suspension Rearward of Front Axle			34058 ⁸

7 Pair Packs, Air hose kit included.;



40 Complete Assembled Unit.;

80 Mounting bracket not required, install on O.E. Shock Mounts. See Ref. C for optional Steering Stabilizer Boots;

8 Pair Packs.;

48 Installation Hardware Included.;

APPLICATION GUIDE

Year	Fitment Notes	OEM#								
			Fleetline/ Gas SLX	Classic/ Ultra/ ProGuard/ Guardian	Max Control/ LTV Severe Duty/ Load Carrier	Steering Dampers/ Steering Stabilizer/ Cab Shock	Fleetline/ Gas SLX	Classic/ Ultra/ ProGuard/ Guardian	Max Control/ LTV Severe Duty/ Load Carrier/ HiJackers	Steering Dampers/ Steering Stabilizer/ Cab Shock

FORD

FORD

VAN 3/4 TON, ECONOLINE / CLUB WAGON / SUPERDUTY (cont)

75-91	RWD, 4WD Quad Suspension Rearward of Front Axle, Non Quad Suspension		 O	61521 ⁶ 81394 G63386	 O	
74-79	QuadraVan Special		 O	6803SE ⁸⁴								
69-74	All		 O	82012	 O	61519 81484 G63377	43058 ⁸ 49127 ⁷
	Single System Steering Stabilizer; with Twin I-Beam Axle		 O	6802SE ⁸⁴								



VAN 1 TON, ECONOLINE / CLUB WAGON / SUPERDUTY

23-24	All		 O	81744 ⁴⁸	58622 77614	 O	61646 81828	49178 ⁷ 58623 77623
21-24	Steering Stabilizer		 O	6828SE ⁸⁰								
21-22	All		 O	81744 ⁴⁸ G63622	58622 77614	 O	61646 81828 G63623	49178 ⁷ 58623 77623
12-19	All		 O	81744 ⁴⁸ G63622	34076 ⁸ 58622 77614	 O	61646 81828 G63623	49178 ⁷ 58623
	Exc. Cutaway Chassis		 O	77614	 O	81828	58623 77623
92-19	Steering Stabilizer		 O	6828SE ⁸⁰								
10-11	All		 O	61591 81744 ⁴⁸ G63622	34076 ⁸ 58622 77614	 O	61646 81828 G63623	49178 ⁷ 58623
08-11	Exc. Cutaway Chassis		 O	58622 77614	 O	61646 81828 G63623	58623 77623
09	All		 O	61591 81744 ⁴⁸ G63622	34076 ⁸ 58622 77614	 O	61646 G63623	49178 ⁷ 58623
07-08	All		 O	61591 81744 ⁴⁸ G63622	34076 ⁸ 58622 77614	 O	61646 G63623	49178 ⁷ 58623 77623
	Cutaway Chassis		 O	58622	 O	58623
07	Exc. Cutaway Chassis		 O	G63622	58622 77614	 O	61646 81828 G63623	49178 ⁷ 58623 77623
04-06	Exc. Cutaway Chassis		 O	58622	 O	61646 81828 G63623	58623 77623
06	All		 O	61591 81744 ⁴⁸ G63622	34076 ⁸ 58622 77614	 O	61646 G63623	49178 ⁷ 58623
04-05	All		 O	61591 81744 ⁴⁸ G63622	34076 ⁸ 58622 77614	 O	61646 81828 G63623	49178 ⁷ 58623
92-05	Cutaway Chassis		 O	G63622	58622 77614	 O	G63623	58623 77623
99-03	All		 O	61591 81744 ⁴⁸ G63622	34076 ⁸ 58622 77614	 O	61646 81828 G63623	49178 ⁷ 58623 77623
03	Exc. Cutaway Chassis		 O	 O	77623
92-98	All		 O	61591 81744 ⁴⁸	34076 ⁸	 O	61646 81828	49178 ⁷
77-91	All		 O	 O	49178 ⁷

6 It is recommended that when replacing shocks on vehicles with "quad shocks" all 4 shocks should be matched by series;
8 Pair Packs;
80 Mounting bracket not required, install on O.E. Shock Mounts. See Ref. C for optional Steering Stabilizer Boots;

7 Pair Packs, Air hose kit included.;
48 Installation Hardware Included;
84 Replacement damper for vehicles with the Gabriel Aftermarket mounting kit;

APPLICATION GUIDE

Year	Fitment Notes	OEM#								
			Fleetline\ Gas SLX	Classic\ Ultra\ ProGuard\ Guardian	Max Control\ LTV Severe Duty\ Load Carrier	Steering Dampers\ Steering Stabilizer\ Cab Shock	Fleetline\ Gas SLX	Classic\ Ultra\ ProGuard\ Guardian	Max Control\ LTV Severe Duty\ Load Carrier\ HiJackers	Steering Dampers\ Steering Stabilizer\ Cab Shock

FORD

FORD

VAN 1 TON, ECONOLINE / CLUB WAGON / SUPERDUTY (cont)

77-91	RWD, 4WD Quad Suspension Rearward of Front Axle		 O	34058 ⁸	
75-91	Cutaway Chassis		 O	
	Cutaway Chassis RWD, 4WD Quad Suspension Rearward of Front Axle, Non Quad Suspension		 O	G63386	
	Exc. Cutaway Chassis		 O	81394	49178 ⁷	
	Exc. Cutaway Chassis RWD, 4WD Quad Suspension Rearward of Front Axle		 O	34058 ⁸
	Exc. Cutaway Chassis RWD, 4WD Quad Suspension Rearward of Front Axle, Non Quad Suspension		 O	61521 ⁶ 81394
69-74	All		O O	82012	61519 81484 G63377	43058 ⁸ 49127 ⁷

FREIGHTLINER

FREIGHTLINER

B2

05-23	Models with 12000 lb Taperleaf Front Suspension	10-13634-000 10-13211-000 1013211000 1013634000	O O	85918	
	Models with FAS II (40,000 lb) Rear Air Suspension	16-15817-000 1618708000 1613957000 1615817000 16-13957-000 16-18708-000 481700006848 680611 471700002809 SDA471700002809	O O	85724 89443
05-22	Models with 15,000 lb Rear Suspension	6803260000	O I	83120



FC70

05-07	Models with 10,000 to 18,000 lb Suspension	6803230300 1013759000 471700003009 10-13759-000 GBL665538	O O	85006
	Models with 6000 to 9000 lb Front Axle	654654 6803230200	O O	85043
	Models with Freightliner FAS II Rear Air Suspension	16-15817-000 1613957000 1615817000 16-13957-000 680611 680339	O O	85724 89443
99-04	Models with 10,000 to 18,000 lb Suspension	6803230300 1013759000 471700003009 10-13759-000 GBL665538	O O	85006
	Models with 6000 to 9000 lb Front axle	654654 6803230200	O O	85043

6 It is recommended that when replacing shocks on vehicles with "quad shocks" all 4 7 Pair Packs, Air hose kit included.;

shocks should be matched by series.;

APPLICATION GUIDE

Year	Fitment Notes	OEM#								
			Fleetline\ Gas SLX	Classic\ Ultra\ ProGuard\ Guardian	Max Control\ LTV Severe Duty\ Load Carrier	Steering Dampers\ Steering Stabilizer\ Cab Shock	Fleetline\ Gas SLX	Classic\ Ultra\ ProGuard\ Guardian	Max Control\ LTV Severe Duty\ Load Carrier\ HiJackers	Steering Dampers\ Steering Stabilizer\ Cab Shock

FREIGHTLINER

FL50

95-05	Day Cab Suspensions with O.E.M. Number	1832999001 18-32999-001 18-60295-000 1830378000 18-30378-000 1860295000	OO	83006
	Models with 10,000 to 18,000 lb Suspension	6803230300 1013759000 471700003009 10-13759-000 GBL665538	OO	85006
	Models with 15,000 lb Rear Suspension	6803260000 GBL654725	O	83120
	Models with 6000 to 9000 lb Front axle	654654 6803230200	OO	85043
	Models with FAS II (40,000 lb) Rear Air Suspension	16-15817-000 1613957000 1615817000 16-13957-000 680611 680339	OO	85724 89443

FREIGHTLINER



FL60

96-05	Day Cab Suspensions with O.E.M. Number	1832999001 18-32999-001 18-60295-000 1830378000 18-30378-000 1860295000	OO	83006
	Models with 10,000 to 18,000 lb Suspension	6803230300 1013759000 471700003009 10-13759-000 GBL665538	OO	85006
91-05	Models with 6000 to 9000 lb Front axle	654654 6803230200	OO	85043
	Models with FAS II (40,000 lb) Rear Air Suspension	16-15817-000 1613957000 1615817000 16-13957-000 680611 680339	OO	85724 89443
	Trucks with Link Cabmate Models FRT153BC-A , FRT106BC or FRT106HD-A	12020054 12010054 1201-0054 1202-0054	OO	83021
	w/ 15000 lb Rear Suspension	6803260000 GBL654725	O	83120

M2

	Models O.E.M. Number	10-13592-000 1013592000 471700000440	OO	85959
05-21	Models with FAS II (40,000 lb) Rear Air Suspension	16-15817-000 1618708000 1615817000 16-18708-000 481700006848 680611 471700002809 SDA471700002809	OO	85724 89443
	Models with Freightliner TufTrac Rear Air Suspension	1615770000 481700125969 16-15770-000	OO	85956
	Models with Hendrickson HMX 400/460 Haulmax with 16.5" Saddle	H60680004 60680-004L 60680-004 60680004 60680004L	O	83143
	Models with Hendrickson HMX 400/460 Haulmax with 17.5" & 18.5" Saddle	60680-005L 60680005L 60680005 HDR60680-005 HDR60680005 60680-005	O	83142

APPLICATION GUIDE

Year	Fitment Notes	OEM#								
			Fleetline\ Gas SLX	Classic\ Ultra\ ProGuard\ Guardian	Max Control\ LTV Severe Duty\ Load Carrier	Steering Dampers\ Ultra\ Steering Stabilizer\ Cab Shock	Fleetline\ Gas SLX	Classic\ Ultra\ ProGuard\ Guardian	Max Control\ LTV Severe Duty\ Load Carrier\ Hijackers	Steering Dampers\ Ultra\ Steering Stabilizer\ Cab Shock

FREIGHTLINER

FREIGHTLINER



M2 (cont)

05-21	Models with Rear 10000 lb - 15000 lb Low Profile AirLiner	16-18711-000 16-16577-000 1616577000 1618711000 471700002996	O O	85335
	Models with Rear 52" Spring ,10000 lb - 15000 lb	16-16486-000 16-18710-000 1616486000 1618710000 471700002995	O I	83134
	Models with Rear 52" Spring ,18000 lb - 23000 lb	1616442000 1618709000 471700002994 16-16442-000 16-18709-000	O I	83134
	Models with Rear 60" Spring ,18000 lb - 23000 lb	1618707000 16-15765-000 471700002993 1615765000 16-18707-000	O I	85921
05-15	Models with Freightliner Low Profile Rear Air Suspension (18,000 to 40,000 lb)	16-14259-000 1614259000 1618706000 680511 471700002992 16-18706-000	O O	85331

M2 100

02-10	Models with FAS II (40,000 lb) Rear Air Suspension	16-15817-000 1618708000 1615817000 16-18708-000 481700006848 680611 471700002809 SDA471700002809	O O	85724 89443
	Models with Freightliner Low Profile Rear Air Suspension (18,000 to 40,000 lb)	16-14259-000 1614259000 1618706000 680511 471700002992 16-18706-000	O O	85331
	Models with Freightliner TufTrac Rear Air Suspension	1615770000 481700125969 16-15770-000	O O	85956
	Models with Hendrickson HMX 400/460 Haulmax with 16.5" Saddle	H60680004 60680-004L 60680-004 60680004 60680004L	O I	83143
	Models with Hendrickson HMX 400/460 Haulmax with 17.5" & 18.5" Saddle	60680-005L 60680005L 60680005 HDR60680-005 HDR60680005 60680-005	O I	83142
	Models with Rear 10000 lb - 15000 lb Low Profile AirLiner	16-18711-000 16-16577-000 1616577000 1618711000 471700002996	O O	85335
	Models with Rear 52" Spring ,10000 lb - 15000 lb	16-16486-000 16-18710-000 1616486000 1618710000 471700002995	O I	83134
	Models with Rear 52" Spring ,18000 lb - 23000 lb	1616442000 1618709000 471700002994 16-16442-000 16-18709-000	O I	83134
	Models with Rear 60" Spring ,18000 lb - 23000 lb	1618707000 16-15765-000 471700002993 1615765000 16-18707-000	O I	85921

APPLICATION GUIDE

Year	Fitment Notes	OEM#								
			Fleetline\ Gas SLX	Classic\ Ultra\ ProGuard\ Guardian	Max Control\ LTV Severe Duty\ Load Carrier	Steering Dampers\ Steering Stabilizer\ Cab Shock	Fleetline\ Gas SLX	Classic\ Ultra\ ProGuard\ Guardian	Max Control\ LTV Severe Duty\ Load Carrier\ HiJackers	Steering Dampers\ Steering Stabilizer\ Cab Shock

FREIGHTLINER



M2 106

09-24	Models with 8000 to 16000 lb Front Axle and Taperleaf Spring	10-13760-000 1013760000 10-13592-000 47170000440 471700002991 SDA471700002991	85959
02-24	Day Cab Models with Spring Suspensions	1860766000 18-47350-000 18-60766-000 814903003482 1847350000	83040
	Models with FAS II (40,000 lb) Rear Air Suspension	16-15817-000 1618708000 1615817000 16-18708-000 481700006848 680611 471700002809 SDA471700002809	85724 89443
	Models with Freightliner TufTrac Rear Air Suspension	1615770000 481700125969 16-15770-000	85956
	Models with Hendrickson HMX 400/460 Haulmax with 16.5" Saddle	H60680004 60680-004L 60680-004 60680004 60680004L	83143
	Models with Hendrickson HMX 400/460 Haulmax with 17.5" & 18.5" Saddle	60680-005L 60680005L 606800005 HDR60680-005 HDR60680005 60680-005	83142
02-23	Models with Rear 10000 lb - 15000 lb Low Profile AirLiner	16-18711-000 16-16577-000 1616577000 1618711000 471700002996	85335
	Models with Rear 52" Spring, 10000 lb - 15000 lb	16-16486-000 16-18710-000 1616486000 1618710000 471700002995	83134
	Models with Rear 52" Spring, 18000 lb - 23000 lb	1616442000 1618709000 471700002994 16-16442-000 16-18709-000	83134
	Models with Rear 60" Spring, 18000 lb - 23000 lb	1618707000 16-15765-000 471700002993 1615765000 16-18707-000	85921
	Models with Reyco 79KB Rear Steel Spring Suspension	19495-01 1672501 16725-01 1949501	83126 89430
02-15	Models with Freightliner Low Profile Rear Air Suspension (18,000 to 40,000 lb)	16-14259-000 1614259000 1618706000 680511 471700002992 16-18706-000	85331
02-08	Models with 10000 to 12000 lb. Taperleaf Spring Suspension	1012390000 10-12390-000	85920
	Models with 6000 to 9000 lb Front axle	10-12388-000 1012388000	85920

MT45

98-23	Step Van Models with O.E.M. Number	16-20628-000 471700003011 1619138000 16-22004-000 471700011302 16-19138-000	85058
-------	------------------------------------	--	-------	------	------	------	------	------	------	------	------

APPLICATION GUIDE

Year	Fitment Notes	OEM#								
			Fleetline\ Gas SLX	Classic\ Ultra\ ProGuard\ Guardian	Max Control\ LTV Severe Duty\ Load Carrier	Steering Dampers\ Steering Stabilizer\ Cab Shock	Fleetline\ Gas SLX	Classic\ Ultra\ ProGuard\ Guardian	Max Control\ LTV Severe Duty\ Load Carrier\ HiJackers	Steering Dampers\ Steering Stabilizer\ Cab Shock

FREIGHTLINER

MT45 (cont)

98-23	Walkin Step Van Models (18 Foot) with O.E.M. Number	1615064000 16-20552-000 16-16542-000 16-15064-000 471700010991 16-15436-000 1620552000 1615436000 1616542000			83154
99-20	MT45 Step Van - w/35" Front Spring	1615473000 1615474000 16-15473-000 16-15474-000		83157
	MT45 Step Van - w/38" Front Spring	16-15475-000 1615475000		83164
98-20	Models with O.E.M. Number	16-15394-000 1615394000			83120

FREIGHTLINER

MT55

	MT55 Models w/8000 lb. flat leaf front suspension	1615676000 16-17684-000 16-15676-000		85058
		1617684000		85058
	MT55 Step Van with O.E.M. Number	16-16542-000 16-15436-000 1615436000 1616542000			83154
99-23	Models with Freightliner Low Profile Rear Air Suspension	1618706000 16-18706-000			85331
	MT55 Chassis with O.E.M. Number	16-17759-000 1620632000 471700000447 16-20632-000 1617759000		85919
99-20	MT55 Step Van - w/35" Front Spring	1615473000 1615474000 16-15473-000 16-15474-000		83157
	MT55 Step Van - w/38" Front Spring	16-15475-000 1615475000		83164
99-11	Models with O.E.M. Number	1615934000 1615705000 16-16262-000 1616262000 16-15934-000 16-15705-000			83120

SPRINTER 2500

07-18	All			G57802 ⁴⁰
02-06	All			G56778	G63918



SPRINTER 3500

07-18	All			G57802 ⁴⁰	G64089
-------	-----	--	--	------	----------------------	------	------	--	------	--------	------	------

VARIOUS

	M-Line Walk in Van with O.E.M. Number	P117099 MAE 16949			83120
	Step Van Models with O.E.M. Number	471700003011 1619138000 16-19138-000		85058

APPLICATION GUIDE

Year	Fitment Notes	OEM#								
			Fleetline/ Gas SLX	Classic/ Ultra/ ProGuard/ Guardian	Max Control/ LTV Severe Duty/ Load Carrier	Steering Dampers/ Steering Stabilizer/ Cab Shock	Fleetline/ Gas SLX	Classic/ Ultra/ ProGuard/ Guardian	Max Control/ LTV Severe Duty/ Load Carrier/ HiJackers	Steering Dampers/ Steering Stabilizer/ Cab Shock

GMC

GMC

B7

93-02	Models with O.E.M. Number	88982682 15588554 22064230 15123676	83136
	School Bus Chassis w/15000, 19000, 21000 lb Multileaf Springs	15174902 22064232	85071

C3500HD

01-02	All		61543
91-02	HD Solid Front Axle		43163 ⁸
	HD Solid Front Axle		58488
91-00	Solid Front Axle		61543



C4500 TOPKICK

03-09	C Chassis - Conventional Cab with 15000, 19000, 21000 lb Multileaf Springs	15174902 88982686 22064232	85071
	C Chassis - Conventional Cab with 19000, 21000, 23000 lb Taperleaf Springs (EXC Low Profile Vehicle)	22064233	83136
	C Chassis - Conventional Cab with Front Shock with O.E.M. Number	88982682 15588554 15887728 19152843 22064230 15123676	83136
	Models with Link Cabmate Model GMT560	12021043 12011043 1201-1043 1202-1043	83025
	Truck Cabs with Link Cabmate Model GMC104TK	12020054 12010054 1201-0054 1202-0054	83021
90-02	C Chassis - Conventional Cab with 15000, 19000, 21000 lb Multileaf Springs	15174902 88982686 22064232	85071
	C Chassis - Conventional Cab with 19000, 21000, 23000 lb Taperleaf Springs (EXC Low Profile Vehicle)	22064233	83136
	C Chassis - Conventional Cab with Front Shock with O.E.M. Number	88982682 15588554 15887728 19152843 22064230 15123676	83136

C5500 TOPKICK

03-09	C Chassis - Conventional Cab with 15000, 19000, 21000 lb Multileaf Springs	15174902 88982686 22064232	85071
	C Chassis - Conventional Cab with 19000, 21000, 23000 lb Taperleaf Springs (EXC Low Profile Vehicle)	22064233	83136

APPLICATION GUIDE

Year	Fitment Notes	OEM#								
			Fleetline\ Gas SLX	Classic\ Ultra\ ProGuard\ Guardian	Max Control\ LTV Severe Duty\ Load Carrier	Steering Dampers\ Steering Stabilizer\ Cab Shock	Fleetline\ Gas SLX	Classic\ Ultra\ ProGuard\ Guardian	Max Control\ LTV Severe Duty\ Load Carrier\ HiJackers	Steering Dampers\ Steering Stabilizer\ Cab Shock

GMC

GMC

C5500 TOPKICK (cont)

03-09	C Chassis - Conventional Cab with Front Shock with O.E.M. Number	88982682 15588554 15887728 19152843 22064230 15123676	 	83136
	Models with Link Cabmate Model GMT560	12021043 12011043 1201-1043 1202-1043	O O	83025
	Truck Cabs with Link Cabmate Model GMC104TK	12020054 12010054 1201-0054 1202-0054	O O	83021
90-02	C Chassis - Conventional Cab with 15000, 19000, 21000 lb Multileaf Springs	15174902 88982686 22064232	 	85071
	C Chassis - Conventional Cab with 19000, 21000, 23000 lb Taperleaf Springs (EXC Low Profile Vehicle)	22064233	 	83136
	C Chassis - Conventional Cab with Front Shock with O.E.M. Number	88982682 15588554 15887728 19152843 22064230 15123676	 	83136

C6000 TOPKICK

90-96	Truck Cabs with Link Cabmate Model GMC104TK	12020054 12010054 1201-0054 1202-0054	O O	83021
-------	---	--	--------	------	------	------	------	-------	------	------	------

C6500 TOPKICK

03-09	Truck Cabs with Link Cabmate Model GMC104TK	12020054 12010054 1201-0054 1202-0054	O O	83021
97-01	Truck Cabs with Link Cabmate Model GMC104TK	12020054 12010054 1201-0054 1202-0054	O O	83021

C7000 TOPKICK

90-96	Truck Cabs with Link Cabmate Model GMC104TK	12020054 12010054 1201-0054 1202-0054	O O	83021
-------	---	--	--------	------	------	------	------	-------	------	------	------



C7500 TOPKICK

97-09	Truck Cabs with Link Cabmate Model GMC104TK	12020054 12010054 1201-0054 1202-0054	O O	83021
-------	---	--	--------	------	------	------	------	-------	------	------	------

PICKUP 3/4 TON, C25 / C2500

88-00	All		 ⊖	61544 81668 G63489	34073 ⁸ 58489 77489	O	61543 81667 G63488	43163 ⁸ 49218 ⁷ 58488 77488
85-86	Crew Cab Pickup		 	O	G63366
83-86	All		O O	81039	O	81164
	Cab & Chassis		 	O	61524 G63349	43111 ⁸ 49155 ⁷
	Exc. Extended Cab		O O	61525 G63355	34036 ⁸	O
	Standard Cab Pickup		 	O	61524 G63349	43111 ⁸ 49155 ⁷

APPLICATION GUIDE

Year	Fitment Notes	OEM#								
			Fleetline/ Gas SLX	Classic/ Ultra/ ProGuard/ Guardian	Max Control/ LTV Severe Duty/ Load Carrier	Steering Dampers/ Steering Stabilizer/ Cab Shock	Fleetline/ Gas SLX	Classic/ Ultra/ ProGuard/ Guardian	Max Control/ LTV Severe Duty/ Load Carrier/ HiJackers	Steering Dampers/ Steering Stabilizer/ Cab Shock

GMC

GMC

PICKUP 3/4 TON, C25 / C2500 (cont)

67-86	Single System Steering Stabilizer		OO	6802SE ⁸⁴								
73-83	Crew Cab Pickup		OO	6802SE ⁸⁴	G63366
79-82	Cab & Chassis		OO	61524 81164 G63349	43111 ⁸ 49155 ⁷
	Exc. Extended Cab		OO	61525 81039 G63355	34036 ⁸
	Standard Cab Pickup		OO	61524 81164 G63349	43111 ⁸ 49155 ⁷
75-78	Cab & Chassis		OO	81164	49155 ⁷
	Exc. Extended Cab		OO	61525 81039 G63355	34036 ⁸	61524 G63349	43111 ⁸
	Standard Cab Pickup		OO	81164	49155 ⁷
73-74	All		OO	61525 81039 G63355	34036 ⁸	43111 ⁸ 49155 ⁷
	Exc. Crew Cab & Bonus Cab		OO	61524 G63349
67-72	Coil(RearSpringType)		OO	82003	49107 ⁷
72	All		OO	61525 81039 G63355	34036 ⁸
	Leaf(RearSpringType)		OO	G63306	49162 ⁷
71	All		OO	61525 81039 G63355	34036 ⁸	G63306
	Leaf(RearSpringType)		OO	49162 ⁷
67-70	All		OO	61525 81039 G63355	34036 ⁸
	Leaf(RearSpringType)		OO	G63306	49162 ⁷

PICKUP 3/4 TON, K25 / K2500

99-00	9200# GVW with OE Unit - 15059138 15155638		OO	6853SE ⁸²								
88-00	All		OO	61542 81726 G63609	58609 77609	61543 81667 G63488	43163 ⁸ 49218 ⁷ 58488 77488
81-86	Quad Suspension Long Shock; Exc. Lift Kit		OO	61522 ⁶ 81496 ⁶
73-86	All		OO	14017
	Exc. Lift Kit		OO	61524 81164 G63349	43111 ⁸
	Exc. Quad Suspension and Lift Kit		OO	61516 81113 ⁶ G63347	49155 ⁷
	Single System Steering Stabilizer		OO	6804SE ⁸⁰								

6 It is recommended that when replacing shocks on vehicles with "quad shocks" all 4 shocks should be matched by series.;

8 Pair Packs.;



82 Use kit if listed, See Ref. C for optional Steering Stabilizer Boots.;

7 Pair Packs, Air hose kit included.;

80 Mounting bracket not required, install on O.E. Shock Mounts. See Ref. C for optional Steering Stabilizer Boots;

84 Replacement damper for vehicles with the Gabriel Aftermarket mounting kit;

APPLICATION GUIDE

Year	Fitment Notes	OEM#								
			Fleetline\ Gas SLX	Classic\ Ultra\ ProGuard\ Guardian	Max Control\ LTV Severe Duty\ Load Carrier	Steering Dampers\ Steering Stabilizer\ Cab Shock	Fleetline\ Gas SLX	Classic\ Ultra\ ProGuard\ Guardian	Max Control\ LTV Severe Duty\ Load Carrier\ HiJackers	Steering Dampers\ Steering Stabilizer\ Cab Shock

GMC

GMC

PICKUP 3/4 TON, K25 / K2500 (cont)

67-86	Dual System Steering Stabilizer			6802SE ⁸⁴						
69-72	Exc. Quad Suspension and Lift Kit			61516 81113 ⁵ G63347						
67-72	Single System Steering Stabilizer			6803SE ⁸⁴						

PICKUP 3/4 TON, R2500

87-89	Crew Cab Pickup												
	Exc. Crew Cab & Bonus Cab			61525 81039 G63355	34036 ⁶								
	Single System Steering Stabilizer			6802SE ⁸⁴									

PICKUP 3/4 TON, V2500

87	All						14017							
	Exc. Lift Kit			G63347								61524 81164 G63349	43111 ⁵ 49155 ⁷	
	Quad Suspension Long Shock; Exc. Lift Kit			61522 ⁵ 81496 ⁵										
	Quad Suspension Short Shock; Exc. Lift Kit			61516 81113 ⁵										
	Single System Steering Stabilizer			6804SE ⁸⁰										
	Steering Stabilizer			6802SE ⁸⁴										



PICKUP 1 TON, C35/3500

99-00	Exc. HD Straight Front Axle												49218 ⁷	
92-00	Exc. HD Straight Front Axle			81668										
	Crew Cab Pickup Exc. HD Straight Front Axle			61544 G63489	58489 77489							G63488		
91-00	All				34073 ⁸								77488	
	Extended Cab Pickup Exc. HD Straight Front Axle			61544 G63489	58489 77489							81667 G63488		
	Standard Cab Pickup Exc. HD Straight Front Axle			61544 G63489	58489 77489							81667 G63488		
00	HD Solid Front Axle												61543	43163 ⁹
91-99	HD Solid Front Axle												61543	43163 ⁹ 58488
92-98	Cab & Chassis Exc. HD Straight Front Axle													49218 ⁷
88-91	Cab & Chassis			81039										
	Cab & Chassis HD Solid Front Axle			61525	34036 ⁸									
91	Exc. HD Straight Front Axle			81668										49218 ⁷
	Cab & Chassis Exc. HD Solid Front Axle											G63366		
89-90	Extended Cab Pickup Exc. HD Straight Front Axle			61544 G63489	58489 77489							81667 G63488	43163 ⁹ 77488	

6 It is recommended that when replacing shocks on vehicles with "quad shocks" all 4 shocks should be matched by series.;
8 Pair Packs.;

7 Pair Packs, Air hose kit included.;;
80 Mounting bracket not required, install on O.E. Shock Mounts. See Ref. C for optional Steering Stabilizer Boots;

APPLICATION GUIDE

Year	Fitment Notes	OEM#								
			Fleetline/ Gas SLX	Classic/ Ultra/ ProGuard/ Guardian	Max Control/ LTV Severe Duty/ Load Carrier	Steering Dampers/ Steering Stabilizer/ Cab Shock	Fleetline/ Gas SLX	Classic/ Ultra/ ProGuard/ Guardian	Max Control/ LTV Severe Duty/ Load Carrier/ HiJackers	Steering Dampers/ Steering Stabilizer/ Cab Shock

GMC

GMC

PICKUP 1 TON, C35/3500 (cont)

88-90	All		I O	34073 ⁸
	Exc. HD Straight Front Axle		I O	81668	61543	49218 ⁷
	Cab & Chassis Exc. HD Solid Front Axle		O O	G63355	G63366
	HD Solid Front Axle		I O	58488
	Standard Cab Pickup Exc. HD Straight Front Axle		I O	61544 G63489	58489 77489	81667 G63488	43163 ⁸ 77488
88	Extended Cab Pickup Exc. HD Straight Front Axle		I O	61544 G63489	58489 77489	G63488	43163 ⁸ 77488
80-86	All		O O	81039
72-86	Steering Stabilizer		O O	6802SE ⁸⁴							
73-78	All		O O	61525 81039 G63355	34036 ⁸	G63366
67-72	All		O O	61525 81039 G63355	34036 ⁸
	Exc. 11,000# Rear Axle		O O	G63306	49162 ⁷

PICKUP 1 TON, K35 / K3500

91-00	All		O O	61542 81726 G63609	58609 77609	81667 G63488	43163 ⁸ 49218 ⁷ 58488 77488
88-90	All		O O	61542 81726 G63609	58609 77609	61543 81667 G63488	43163 ⁸ 49218 ⁷ 58488 77488
77-86	All		O O	G63411	14017	61642 81921 G63675	58412 77412
73-74	All		O O	14017

PICKUP 1 TON, R3500

87-91	All		O O	61525 81039 G63355	34036 ⁸	G63366
-------	-----	--	--------	-------	--------------------------	--------------------	-------	-------	--------	-------	-------

PICKUP 1 TON, V3000 / V3500

87-91	All		O O	G63411	14017	61642 81921 G63675	58412 77412
87-88	Quad Suspension Long Shock; Exc. Lift Kit		O O	81496 ⁶

PICKUP 2500 SERIES

66	All		O O	61525 81039 G63355
61-62	All		O O	82035

SAVANA 4500

10-20	All		I O	61685 G63895	61687 G63897	77638
-------	-----	--	--------	-------	-----------------	-------	-------	-------	-----------------	-------	-------

SIERRA 2500

99-04	All		I O	58817	61642 81921 G63675	58412 77412
-------	-----	--	--------	-------	-------	-------	-------	-------	--------------------------	----------------	-------

6 It is recommended that when replacing shocks on vehicles with "quad shocks" all 4 shocks



should be matched by series.;

8 Pair Packs.;

7 Pair Packs, Air hose kit included.;

84 Replacement damper for vehicles with the Gabriel Aftermarket mounting kit;

APPLICATION GUIDE

Year	Fitment Notes	OEM#								
			Fleetline\ Gas SLX	Classic\ Ultra\ ProGuard\ Guardian	Max Control\ LTV Severe Duty\ Load Carrier	Steering Dampers\ Steering Stabilizer\ Cab Shock	Fleetline\ Gas SLX	Classic\ Ultra\ ProGuard\ Guardian	Max Control\ LTV Severe Duty\ Load Carrier\ HiJackers	Steering Dampers\ Steering Stabilizer\ Cab Shock

GMC

GMC

SIERRA 2500 (cont)

99-04	4WD		 O		61663 81925 G63817	77817					
	4WD; Up through 8600# GVW; Exc. OE Steering Stabilizer		O O	6853SE ⁸²							
	RWD, Exc. Electronic Adjustable Suspension		 O		61641 81920 G63783	77783					

SIERRA 2500 HD

22-23	All		O O		G64148			O O		G64121	43181 ⁸	
11-21	All		O O		G64148			O O		G64121	43181 ⁸ 77976	
01-10	All		 O			58817		O O		61642 81921 G63675	58412 77412	
	4WD		 O		61663 G63817	77817		 O				
01-09	9200# GVW with OE Unit - 15059138 15155638		O O	6853SE ⁸²								
01-04	RWD		 O		61641 81920 G63783	77783		 O				

SIERRA 2500 HD CLASSIC

07	All		 O					O O			58412	
	4WD		 O					O O			77412	

SIERRA 3500

01-06	All		 O		61663 G63817	58817 77817		O O		61642 81921 G63675	58412 77412	
-------	-----	--	-------	--	-----------------	----------------	--	--------	--	--------------------------	----------------	--

SIERRA 3500 CLASSIC

07	All		 O		61663	58817		O O		61642	58412 77412	
----	-----	--	-------	--	-------	-------	--	--------	--	-------	----------------	--



SIERRA 3500 HD

22-23	All		O O		G64148			O O		G64121	43181 ⁸	
11-21	All		O O		G64148			O O		G64121	43181 ⁸ 77976	
07-10	All		 O					O O		61642 81921 G63675	58412 77412	
	Torsion Bar(FrontSpringType)		 O		61663 G63817	58817 77817		 O				

T6500

04-09	FL1 Tilt Cab with 8100 lb Axle	22165188 22165187 22064804 22064805	 I		83136			 I				
	FL2 Tilt Cab with 5000 to 11000 lb Axle	22166442 22064807	 I		83136			 I				
	FL3 Tilt Cab with 14575 lb Axle	22165189 22064806	 I		83136			 I				
04-06	Tilt Cab with 15000, 19000, 21000 lb Multileaf Springs	15174902 22064232	 I					 I		85071		

APPLICATION GUIDE

Year	Fitment Notes	OEM#								
			Fleetline/ Gas SLX	Classic/ Ultra/ ProGuard/ Guardian	Max Control/ LTV Severe Duty/ Load Carrier	Steering Dampers/ Steering Stabilizer/ Cab Shock	Fleetline/ Gas SLX	Classic/ Ultra/ ProGuard/ Guardian	Max Control/ LTV Severe Duty/ Load Carrier/ HiJackers	Steering Dampers/ Steering Stabilizer/ Cab Shock

GMC

GMC

T6500 (cont)

97-02	FL1 Tilt Cab with 8100 lb Axle	22165188 22165187 22064804 22064805		83136
	FL2 Tilt Cab with 5000 to 11000 lb Axle	22166442 22064807		83136
	FL3 Tilt Cab with 14575 lb Axle	22165189 22064806		83136
	Tilt Cab with 15000, 19000, 21000 lb Multileaf Springs	15174902 22064232		85071
97-99	Tilt Cab with 19000, 21000, 23000 lb Taperleaf Springs (EXC Low Profile Veh.)	22064233		83136
99	Models with Hendrickson Air Suspension (Stamping number 47902-13)	12474915 15963161		83122 89406

VAN 3/4 TON, G / SAVANA

23	All			61685 G63895	61687 G63897	43180 ⁶
17-22	All			61685 G63895	61687 G63897	43180 ⁶ 77638
03-16	All			61687 G63897	43180 ⁶ 77638
	Coil(FrontSpringType)			61685 G63895
03-12	Torsion Bar (FrontSpringType)			61683 G63893
96-02	Exc. 8600# GVW			61555 81713 ⁵ G63375 ⁵	34073 ⁸ 77375	61565 G63638	43180 ⁶ 49231 ⁷ 58638 77638
78-95	Exc. 8600# GVW			61517 G63357	58357	61522 81496 G63413	49212 ⁷
70-95	Single System Steering Stabilizer			6802SE ⁶⁴							
71-77	All			61517 G63357	58357	G63306	49162 ⁷
67-70	All			G63306	49162 ⁷
70	Independent Front Suspension			61517 G63357	58357

VAN 3/4 TON, P SERIES

79-89	All			61525 81039 G63355	34036 ⁶	G63366
73-78	All			61525 81039 G63355	34036 ⁶	61524 81164 G63349	43111 ⁸ 49155 ⁷
68-72	All			61525 81039 G63355	34036 ⁶	G63306	49162 ⁷
67	All			82047





VAN 1 TON, G / SAVANA

23	All			61685 G63895	61687 G63897	43180 ⁶
17-22	All			61685 G63895	61687 G63897	43180 ⁶ 77638

5 Use kit No. 140719 to replace O.E. hardware for lower shock absorber mounting when studs break or self-tapping screws are not longer useable;
8 Pair Packs.;

7 Pair Packs, Air hose kit included.;
84 Replacement damper for vehicles with the Gabriel Aftermarket mounting kit;

APPLICATION GUIDE

Year	Fitment Notes	OEM#								
			 Fleetline\ Gas SLX	Classic\ Ultra\ ProGuard\ Guardian	Max Control\ LTV Severe Duty\ Load Carrier	Steering Dampers\ Steering Stabilizer\ Cab Shock	 Fleetline\ Gas SLX	Classic\ Ultra\ ProGuard\ Guardian	Max Control\ LTV Severe Duty\ Load Carrier\ HiJackers	Steering Dampers\ Steering Stabilizer\ Cab Shock

GMC

GMC

VAN 1 TON, G / SAVANA (cont)

13-16	All			61687 G63897	43180 ⁸ 77638
03-16	Coil(FrontSpringType)			61685 G63895
04-12	All			43180 ⁸ 77638
03-12	Single Rear Wheels			61687 G63897
	Torsion Bar (FrontSpringType)			G63893
03	All			43180 ⁸
97-02	All			61555 81713 ⁵ G63375 ⁵	77375	43180 ⁸ 49231 ⁷
96-02	Exc. 8600# GVW			34073 ⁸	61565 G63638	58638 77638
96	All			61555 81713 ⁵ G63375 ⁵	58357 77375	43180 ⁸ 49231 ⁷
	7100, 7400 and 8600# GVW			77638
	Cutaway Van			G63671
	Cutaway Van 9200# GVW			G63403
	Exc. Cutaway Van			61522 ⁶ 81496 G63413
94-95	Single System Steering Stabilizer, HD with Straight Front Axle & Tilt Hood			6804SE ⁸⁰								
93-95	Cutaway Van 9200# GVW			G63403	77403
92-95	Cutaway Van			G63671	58403
79-95	Exc. Cutaway Van			61522 ⁶ 81496 G63413	49212 ⁷
78-95	All			61517 G63357	58357
71-95	Single System Steering Stabilizer			6802SE ⁸⁴								
92	Cutaway Van 9200# GVW			77403
79-91	Cutaway Van			58403
	Cutaway Van 9200# GVW			G63403	77403
78	Cutaway Van			61522 ⁶ 81496 G63413	49212 ⁷
76-77	All			61517 G63357	58357	G63306	49162 ⁷
75	110.0 / 279.4(WheelBase)			61517	58357	G63306	49162 ⁷
	125.0 / 317.5(WheelBase)			61517	58357	G63306	49162 ⁷
	146.0 / 370.8(WheelBase)			G63357
71-74	All			61517 G63357	58357	G63306
	Exc. 146" Wheelbase			49162 ⁷

5 Use kit No. 140719 to replace O.E. hardware for lower shock absorber mounting when studs break or self-tapping screws are not longer useable.;

7 Pair Packs, Air hose kit included.;

80 Mounting bracket not required, install on O.E. Shock Mounts. See Ref. C for



optional Steering Stabilizer Boots;

6 It is recommended that when replacing shocks on vehicles with "quad shocks" all 4 shocks should be matched by series.;

8 Pair Packs.;

84 Replacement damper for vehicles with the Gabriel Aftermarket mounting kit;

APPLICATION GUIDE

Year	Fitment Notes	OEM#								
			Fleetline\ Gas SLX	Classic\ Ultra\ ProGuard\ Guardian	Max Control\ LTV Severe Duty\ Load Carrier	Steering Dampers\ Steering Stabilizer\ Cab Shock	Fleetline\ Gas SLX	Classic\ Ultra\ ProGuard\ Guardian	Max Control\ LTV Severe Duty\ Load Carrier\ HiJackers	Steering Dampers\ Steering Stabilizer\ Cab Shock

GMC

GMC

VAN 1 TON, P SERIES

86-99	Motorhome Chassis w/ I-Beam Front Suspension		O O	G63625
85-99	Motorhome Chassis w/ Independent Front Suspension		O O	G63394
75-99	All		O O	G63366	77662
75-90	Cutaway Chassis		O O	61525 81039 G63355	34036 ⁸
85	Motorhome Chassis w/ I-Beam Front Suspension		O O	G63403	58403 77403
75-84	Motorhome Chassis		O O	G63394
73-74	All		O O	G63366
74	Cutaway Chassis		O O	34036 ⁸
	Base, Cutaway Chassis		O O	61525 81039 G63355	77662
	Motorhome		O O	G63394	77662
73	Base, Cutaway Chassis		O O	61525 81039 G63355	34036 ⁸	77662
68-72	All		O O	61525 81039 G63355	34036 ⁸
	Exc. 11,000# Rear Axle		O O	G63306	49162 ⁷
67	All		O O	82047

W4500 FORWARD

92-10	Models with 11000 lb & 13000 lb Suspension	9516306471 97083029 94454987 98232671 97083027 8972536200 97253620 8-97253-620-0 8944549870 8944549860 9-51630-647-1 8-94454-986-0 8-94454-987-0	I O	83515
-------	--	--	--------	-------	------	------	------	------	------	------	------

W5500 FORWARD

88-10	Models with 11000 lb & 13000 lb Suspension	97253620	I O	83515
-------	--	----------	--------	-------	------	------	------	------	------	------	------

W6500 FORWARD

87-96	Models with 11000 lb & 13000 lb Suspension	1516301681 1-51630-168-1	I O	83515
-------	--	-----------------------------	--------	-------	------	------	------	------	------	------	------

HINO

HINO



145

05-10	Models with O.E.M. Number	485003710A S4850-03710 48500-3710	O O	83126
-------	---------------------------	---	--------	-------	------	------	------	------	------	------	------

155

16-20	Models with O.E.M. Number	48531-37351 4853137351	O O	83519
13-20	Models with O.E.M. Number	4851137320 48511-80162 48511-37320	I O	83518

APPLICATION GUIDE

Year	Fitment Notes	OEM#								
			Fleetline\ Gas SLX	Classic\ Ultra\ ProGuard\ Guardian	Max Control\ LTV Severe Duty\ Load Carrier	Steering Dampers\ Steering Stabilizer\ Cab Shock	Fleetline\ Gas SLX	Classic\ Ultra\ ProGuard\ Guardian	Max Control\ LTV Severe Duty\ Load Carrier\ HiJackers	Steering Dampers\ Steering Stabilizer\ Cab Shock

HINO

HINO

165

05-10	Models with O.E.M. Number	485003710A S4850-03710 48500-3710	O	83126
-------	---------------------------	---	---	-------	------	------	------	------	------	------	------

185

05-10	Models with O.E.M. Number	485003710A S4850-03710 48500-3710	O	83126
		48500-3720 S4850-03720	O	83140

195

21	Models with O.E.M. Number	4851137320 4851180162 48511-80162 48511-37320	I O	83518
		48531-37362 48531-37361 4853137362 4853137361	O	83519
12-20	Models with O.E.M. Number	4851137320 4851180162 48511-80162 48511-37320	I O	83518
		48531-37362 48531-37361 4853137362 4853137361	O	83519

238

08-14	Models with Hendrickson Comfort Air (Single Axle - 19K)	48530E0100 48530-E0100 60670-014L 60670014L 60670-031L 60670019L 60670029L 60670-019L 60670031L 60670-029L	O	83166
05-14	Models with O.E.M. Number	485003720 S485003720 48500-3720 S4850-03720	O	83140





258

08-23	Models with Hendrickson Comfort Air (Single Axle - 19K)	48530E0100 48530-E0100 60670-014L 60670014L 48530-E0390 60670-031L 60670019L 60670029L 48530E0390 60670-019L 60670031L 60670-029L	O	83166
15-21	Models with O.E.M. Number	48500-E0420 48500E0420	O	83391
06-14	Models with O.E.M. Number	485003720 S485003720 48500-3720 S4850-03720	O	83140

258ALP

08-14	Models with Hendrickson Comfort Air (Single Axle - 19K)	48530E0100 48530-E0100 60670-014L 60670014L 60670-031L 60670019L 60670029L 60670-019L 60670031L 60670-029L	O	83166
-------	---	---	---	-------	------	------	------	------	------	------	------



APPLICATION GUIDE

Year	Fitment Notes	OEM#								
			 Fleetline\ Gas SLX	Classic\ Ultra\ ProGuard\ Guardian	Max Control\ LTV Severe Duty\ Load Carrier	Steering Dampers\ Steering Stabilizer\ Cab Shock	 Fleetline\ Gas SLX	Classic\ Ultra\ ProGuard\ Guardian	Max Control\ LTV Severe Duty\ Load Carrier\ HiJackers	Steering Dampers\ Steering Stabilizer\ Cab Shock

HINO

HINO



268

08-23	Models with Hendrickson Comfort Air (Single Axle - 19K)	48530E0100 48530-E0100 60670-014L 60670014L 48530-E0390 60670-031L 60670019L 60670029L 48530E0390 60670-019L 60670031L 60670-029L		83166
15-22	Models with O.E.M. Number	48500-E0420 48500E0420		83391
05-14	Models with O.E.M. Number	485003720 S485003720 48500-3720 S4850-03720		83140



268, 268A SERIES

	Models with Hendrickson Rear Air Suspension (Shock stamping #)	60670012 60670-012		83168
--	--	-----------------------	---	-------	------	------	------	------	------	------	------

268A

08-14	Models with Hendrickson Comfort Air (Single Axle - 19K)	48530E0100 48530-E0100 60670-014L 60670014L 60670-031L 60670019L 60670029L 60670-019L 60670031L 60670-029L		83166
	Models with O.E.M. Number	485003720 S485003720 48500-3720 S4850-03720		83140

ADDITIONAL APPLICATIONS

	Conventional Hino Models with Hendrickson Comfort Air Suspension	60670020 60670-020		83148
	Conventional Hino Models with Hendrickson Comfort Air Suspension (19,000 lb & 21,000 lb Capacity)	60670013 60670-013		83148



FA, FB SERIES

98	FA1517, FA1817, FB1817		G63419
----	------------------------	------	---	------	------	------	------	------	--------	------	------



FA14

89-91	Models with O.E.M. Number	S4850-01950 48500-1950 48500-2750 S4850-02750 66639		G63610
-------	---------------------------	---	---	--------	------	------	------	------	------	------	------

FA15

92	FA, FB Models Trucks with:	S4850-01950 48500-1950 48500-2750 S4850-02750 66639		G63610
		S4853-02510 S4853-01910 48530-2510 34802 48530-1910		83216

APPLICATION GUIDE

Year	Fitment Notes	OEM#								
			Fleetline\ Gas SLX	Classic\ Ultra\ ProGuard\ Guardian	Max Control\ LTV Severe Duty\ Load Carrier	Steering Dampers\ Steering Stabilizer\ Cab Shock	Fleetline\ Gas SLX	Classic\ Ultra\ ProGuard\ Guardian	Max Control\ LTV Severe Duty\ Load Carrier\ HiJackers	Steering Dampers\ Steering Stabilizer\ Cab Shock

HINO

HINO

FA1415

93-97	(FA15)	48500-1950	 ○		G63610
		48530-1910	 ○		83216
	FA, FB Models Trucks with:	S4850-01950 48500-1950 48500-2750 S4850-02750 66639	 ○		G63610
		S4853-02510 S4853-01910 48530-2510 34802 48530-1910	 ○		83216
		FA1415 (FA15), FB1715 (FB15)	 ○		G63610
	48530-1910	 ○		83216

FA1517

98-04	FA, FB Models Trucks with:	S4850-01950 48500-1950 48500-2750 S4850-02750 66639	 ○		G63610
		S4853-02510 S4853-01910 48530-2510 34802 48530-1910	 ○		83216
98	All	48530-2510	 ○		83216
	FA1517, FA1817, FB1817	48530-2510	 ○		83216

FA1817

98	All	48530-2510	 ○		83216
----	-----	------------	-------	--	------	------	------	------	-------	------	------	------

FB14

89-91	FA, FB Models Trucks with:	S4850-01950 48500-1950 48500-2750 S4850-02750 66639	 ○		G63610
		S4853-02510 S4853-01910 48530-2510 34802 48530-1910	 ○		83216



FB15

92	FA, FB Models Trucks with:	S4850-01950 48500-1950 48500-2750 S4850-02750 66639	 ○		G63610
		S4853-02510 S4853-01910 48530-2510 34802 48530-1910	 ○		83216

FB1715

93-97	FA, FB Models Trucks with:	S4850-01950 48500-1950 48500-2750 S4850-02750 66639	 ○		G63610
		S4853-02510 S4853-01910 48530-2510 34802 48530-1910	 ○		83216
	FA1415 (FA15), FB1715 (FB15)	48500-1950	 ○		G63610
		48530-1910	 ○		83216

APPLICATION GUIDE

Year	Fitment Notes	OEM#								
			Fleetline\ Gas SLX	Classic\ Ultra\ ProGuard\ Guardian	Max Control\ LTV Severe Duty\ Load Carrier	Steering Dampers\ Steering Stabilizer\ Cab Shock	Fleetline\ Gas SLX	Classic\ Ultra\ ProGuard\ Guardian	Max Control\ LTV Severe Duty\ Load Carrier\ HiJackers	Steering Dampers\ Steering Stabilizer\ Cab Shock

HINO

HINO

FB1817

98-04	FA, FB Models Trucks with:	S4850-01950 48500-1950 48500-2750 S4850-02750 66639	 ○	G63610	
		S4853-02510 S4853-01910 48530-2510 34802 48530-1910	 ○	83216
	FE Models Trucks with:	S4850-01941 48500-1941	 ○	83141	
98	All	48530-2510	 ○	83216
	FA1517, FA1817, FB1817	48530-2510	 ○	83216

FD16

86-87	Models with O.E.M. Number	48530-1880 485301880	 ○	83215
-------	---------------------------	-------------------------	-------	-------	-------	-------	-------	-------	-------	-------	-------	-------

FD17

88-92	Models with O.E.M. Number	48530-1880 485301880	 ○	83215
-------	---------------------------	-------------------------	-------	-------	-------	-------	-------	-------	-------	-------	-------	-------

FD2218

93-97	(FD5H). FE5H, FF5H	48500-1801	 ○	83216
		48530-1880	 ○	83215

FD2218LD

93-97	(FD5H). FE5H, FF5H	48530-1880 485301880	 ○	83215
-------	--------------------	-------------------------	-------	-------	-------	-------	-------	-------	-------	-------	-------	-------

FD2218LP

93-97	Models with O.E.M. Number	48500-1801	 ○	83216
		48530-1880	 ○	83215

FE SERIES

98-04	Models Trucks with O.E.M. Number	485001941 S4850-01941 S485001941 48500-1941	 ○	83141
-------	----------------------------------	--	-------	-------	-------	-------	-------	-------	-------	-------	-------	-------

FE16

86-87	All	48500-1801	 ○	83216
-------	-----	------------	-------	-------	-------	-------	-------	-------	-------	-------	-------	-------

FE2620

98	All	48530-1880 485301880	 ○	83215
----	-----	-------------------------	-------	-------	-------	-------	-------	-------	-------	-------	-------	-------

FF SERIES

98	FF3320	48530-1880 485301880	 ○	83215
----	--------	-------------------------	-------	-------	-------	-------	-------	-------	-------	-------	-------	-------

FF3020

03	FF Models Trucks with O.E.M. Number	485001941 48500-1941	 ○	83141
----	-------------------------------------	-------------------------	-------	-------	-------	-------	-------	-------	-------	-------	-------	-------



GC17

90-91	GC17	48500-1801	 ○	83216
-------	------	------------	-------	-------	-------	-------	-------	-------	-------	-------	-------	-------

GC20

92	GC20	48500-1801	 ○	83216
----	------	------------	-------	-------	-------	-------	-------	-------	-------	-------	-------	-------

APPLICATION GUIDE

Year	Fitment Notes	OEM#								
			Fleetline\ Gas SLX	Classic\ Ultra\ ProGuard\ Guardian	Max Control\ LTV Severe Duty\ Load Carrier	Steering Dampers\ Steering Stabilizer\ Cab Shock	Fleetline\ Gas SLX	Classic\ Ultra\ ProGuard\ Guardian	Max Control\ LTV Severe Duty\ Load Carrier\ HiJackers	Steering Dampers\ Steering Stabilizer\ Cab Shock

HINO

HINO

L6

22-23	Models with Hendrickson Comfort Air (Single Axle - 19K)	48530E0100 48530-E0100 60670-014L 60670014L 48530-E0390 60670-031L 60670019L 60670029L 48530E0390 60670-019L 60670031L 60670-029L	83166
	Models with O.E.M. Number	48500-E0420 48500E0420	83391
21	Models with Hendrickson Comfort Air (Single Axle - 19K)	48530E0100 48530-E0100 60670-014L 60670014L 60670-031L 60670019L 60670029L 60670-019L 60670031L 60670-029L	83166
	Models with O.E.M. Number	48500-E0420 48500E0420	83391

INTERNATIONAL

INTERNATIONAL

200

74-75	Steering Stabilizer									6802SE ⁸⁴
-------	---------------------	--	--	--	--	--	--	--	--	----------------------

1200C

68	Exc. 166" Wheelbase		...	61500 81147 82007 G63405	61500 81147 G63405	43048 ⁸ 49310 ⁷	...
	Single System Steering Stabilizer; 1/2 Ton, 3/4 Ton & Travelall									6802SE ⁸⁴	

1200D

69-70	Single System Steering Stabilizer; 1/2 Ton, 3/4 Ton & Travelall									6802SE ⁸⁴
-------	---	--	--	--	--	--	--	--	--	----------------------

1210

71-73	Single System Steering Stabilizer; 1/2 Ton, 3/4 Ton & Travelall									6802SE ⁸⁴
-------	---	--	--	--	--	--	--	--	--	----------------------

1300C

68	Exc. 166" Wheelbase		...	61500 81147 82007 G63405	61500 81147 G63405	43048 ⁸ 49310 ⁷	...
	Single System Steering Stabilizer; 1/2 Ton, 3/4 Ton & Travelall									6802SE ⁸⁴	



1300D

69-70	Single System Steering Stabilizer; 1/2 Ton, 3/4 Ton & Travelall									6802SE ⁸⁴
-------	---	--	--	--	--	--	--	--	--	----------------------

7 Pair Packs, Air hose kit included.;

8 Pair Packs.;

APPLICATION GUIDE

Year	Fitment Notes	OEM#								
			Fleetline\ Gas SLX	Classic\ Ultra\ ProGuard\ Guardian	Max Control\ LTV Severe Duty\ Load Carrier	Steering Dampers\ Steering Stabilizer\ Cab Shock	Fleetline\ Gas SLX	Classic\ Ultra\ ProGuard\ Guardian	Max Control\ LTV Severe Duty\ Load Carrier\ HiJackers	Steering Dampers\ Steering Stabilizer\ Cab Shock

INTERNATIONAL

1310

71-73	Single System Steering Stabilizer; 1/2 Ton, 3/4 Ton & Travelall		OO							6802SE ⁸⁴
-------	---	--	----	--	--	--	--	--	--	----------------------

INTERNATIONAL

4300

02-20	Models with 6,000 to 8,000 lb Front Suspension	3533356C1 3533356C2	OO	83135							
	Models with Hendrickson HAS - 230 or 460 Rear Air Suspension	60675-003 H60675-003 57905001 3514952C1 60675-003L 57905-001 60675003L 60675003 H60675003		OO					85976		
	Models with O.E.M. Number	2509223C92 2509223C91 2509221C91		OO				83054			
02-15	Models with 12,000 lb Front axle	3533357C1 3533357C2 3533357C3	OO	85957							
02-13	Models with 22,000 lb Rear Spring Suspension	501906C91 501906C92 OE13424S	OO						83317		
08-09	Models with 9,000 to 10,000 lb Front Suspension	6127088C1 3578105C2	OO	83163							
	Models with International 40,000 lb Rear Air Suspension	3549099C2	OO						85923 89458		





4300LP

02-19	Models with O.E.M. Number	2509223C92 2509223C91 2509221C91	OO							
13	Models with O.E.M. Number	1660846C92	OO	83101						

4400

02-20	Models with 6,000 to 8,000 lb Front Suspension	3533356C1 3533356C2	OO	83135						
	Models with Hendrickson HAS - 230 or 460 Rear Air Suspension	60675-003 H60675-003 57905001 3514952C1 60675-003L 57905-001 60675003L 60675003 H60675003		OO					85976	
	Models with O.E.M. Number	2509223C92 2509223C91 2509221C91		OO				83054		
02-15	Models with 12,000 lb Front axle	3533357C1 3533357C2 3533357C3	OO	85957						
02-13	Models with 22,000 lb Rear Spring Suspension	501906C91 501906C92 OE13424S	OO						83317	
08-09	Models with 9,000 to 10,000 lb Front Suspension	6127088C1 3578105C2	OO	83163						
	Models with International 40,000 lb Rear Air Suspension	3549099C2	OO						85923 89458	

APPLICATION GUIDE

Year	Fitment Notes	OEM#								
			 Fleetline\ Gas SLX	Classic\ Ultra\ ProGuard\ Guardian	Max Control\ LTV Severe Duty\ Load Carrier	Steering Dampers\ Steering Stabilizer\ Cab Shock	 Fleetline\ Gas SLX	Classic\ Ultra\ ProGuard\ Guardian	Max Control\ LTV Severe Duty\ Load Carrier\ Hijackers	Steering Dampers\ Steering Stabilizer\ Cab Shock

INTERNATIONAL

4400LP

02-19	Models with O.E.M. Number	2509223C92 2509223C91 2509221C91	O	O	O	O	83054	O	O	O	O
-------	---------------------------	--	---	---	---	---	-------	---	---	---	---

CV515

24	Models with 11K, 13.5K or 15.5K VARI-RATE Rear Suspension	4208946C1 4206863C1	O	O	O	O	O	83398	O	O	O
	Models with Taperleaf Front	4109582C1 4089293C1 4109583C1 4207304C1	O	O	O	O	O	83397	O	O	O
19-23	Models with 11K, 13.5K or 15.5K VARI-RATE Rear Suspension	4208946C1 4206863C1	O	O	O	O	O	83398	O	O	O
	Models with 4 x 4 Rear	4109458C2	O	O	O	O	O	83243	O	O	O
	Models with IROS Rear	4214011C2	O	O	O	O	O	85670	O	O	O
	Models with Taperleaf Front	4109582C1 4089293C1 4109583C1 4207304C1	O	O	O	O	O	83397	O	O	O

CXT SERIES



	CXT Models with 9,000 to 10,000 lb Front Suspension	3606770C2 3606770C1	O	O	O	O	O	83163	O	O	O
--	---	------------------------	---	---	---	---	---	-------	---	---	---

DURASTAR

16-20	Models with 10,500 or 13,500 lb Vari-Rate Rear Spring Suspension	6127087C1 3586902C2 3586902C3	O	O	O	O	O	83364	O	O	O
	Models with 11,000 lb to 14,000 lb Front axle	6127714C1	O	O	O	O	O	85928	O	O	O
15-20	Models with 6,000 to 8,000 lb Front Suspension	6127688C1 3533356C3	O	O	O	O	O	83169	O	O	O
	Models with Hendrickson HAS - 230 or 460 Rear Air Suspension	60675-003 H60675-003 57905001 3514952C1 60675-003L 57905-001 60675003L 60675003 H60675003	O	O	O	O	O	O	85976	O	O
	Models with O.E.M. Number	2509223C92 2509223C91 2509221C91	O	O	O	O	O	O	83054	O	O
16-19	Models with 20,000 lb International IROS Air Suspension	6127713C1	O	O	O	O	O	85656	O	O	O
15-19	Models with 9,000 to 10,000 lb Front Suspension	6127088C1 OE13402S 3578105C2 3578105C1	O	O	O	O	O	83163	O	O	O
16-17	Models with Vari-Rate Rear Spring Suspension	6127700C1	O	O	O	O	O	83395	O	O	O
15	Models with 12,000 lb Front axle	3533357C1 3533357C2 3533357C3	O	O	O	O	O	85957	O	O	O
13	Models with 12,000 lb Front axle	3533357C1 3533357C2 3533357C3	O	O	O	O	O	85957	O	O	O
	Models with 22,000 lb Rear Spring Suspension	501906C91 501906C92 OE13424S	O	O	O	O	O	83317	O	O	O

INTERNATIONAL

APPLICATION GUIDE

Year	Fitment Notes	OEM#								
			Fleetline\ Gas SLX	Classic\ Ultra\ ProGuard\ Guardian	Max Control\ LTV Severe Duty\ Load Carrier	Steering Dampers\ Steering Stabilizer\ Cab Shock	Fleetline\ Gas SLX	Classic\ Ultra\ ProGuard\ Guardian	Max Control\ LTV Severe Duty\ Load Carrier\ HiJackers	Steering Dampers\ Steering Stabilizer\ Cab Shock

INTERNATIONAL

DURASTAR (cont)

13	Models with 6,000 to 8,000 lb Front Suspension	6127688C1 3533356C3	OO	83169	
	Models with 9,000 to 10,000 lb Front Suspension	6127088C1 OE13402S 3578105C2 3578105C1	OO	83163	
	Models with Hendrickson HAS - 230 or 460 Rear Air Suspension	60675-003 H60675-003 57905001 3514952C1 60675-003L 57905-001 60675003L 60675003 H60675003	OO	85976
	Models with O.E.M. Number	2509223C92 2509223C91 2509221C91	OO	83054

INTERNATIONAL

DURASTAR - 1000 SERIES

1300 Models	56110T8129 66400 56110-T8123 56110-T8129 56110T8123	O	G63432
-------------	---	---	------	--------	------	------	------	------	------	------

DURASTAR - 4300, 4400 SERIES

	Models with 20,000 lb International IROS Air Suspension	3578858C1 3578858C2	OO	85656
	Models with International IROS Air Suspension	3553628C1 3553628C2 3553628C3 3553628C4	OO	85927
	Models with O.E.M. Number	6127690C1	OO	85923 89458
16-20	Models with 11,000 lb to 14,000 lb Front axle	6127714C1	OO	85928
16-19	Models with 20,000 lb International IROS Air Suspension	6127713C1	OO	85656
13-18	Models with 6,000 to 8,000 lb Front Suspension	6127688C1 3533356C3	OO	83169
10-15	Models with 12,000 lb Front axle	3533357C1 3533357C2 3533357C3	OO	85957
10-12	Models with 6,000 to 8,000 lb Front Suspension	3533356C1 3533356C2	OO	83135
	School Bus models with 6,000 to 8,000 lb Front Suspension	3533356C1 3533356C2	OO	83135
10-11	Models with 40,000 lb Rear Air Suspension	3549099C2	OO	85923 89458



EMV607

23	Models with 12,000 lb Parabolic Taper Leaf Springs	6127714C1	OO	85928
----	--	-----------	----	-------	------	------	------	------	------	------	------

HV607

19-23	Models with 11,000 lb to 14,000 lb Taper-leaf Springs	6127714C1	OO	85928
	Models with Hendrickson Primaax 230/460 Air Suspension with 9" Ride Height	60657-003 60657003 60657003L 3626571C2 H60657003 60657-003L	OO	85072

APPLICATION GUIDE

Year	Fitment Notes	OEM#								
			Fleetline\ Gas SLX	Classic\ Ultra\ ProGuard\ Guardian	Max Control\ LTV Severe Duty\ Load Carrier	Steering Dampers\ Steering Stabilizer\ Cab Shock	Fleetline\ Gas SLX	Classic\ Ultra\ ProGuard\ Guardian	Max Control\ LTV Severe Duty\ Load Carrier\ HiJackers	Steering Dampers\ Steering Stabilizer\ Cab Shock

INTERNATIONAL

HV607 (cont)

19-23	Models with O.E.M. Number	12019008 1201-9008 2509223C92 2509223C91	OO	83054	OO
19-22	Models with Hendrickson HMX 400/460 Haulmax with 16.5" Saddle	60680-004L 60680-004 60680004 60680004L	OO	OO	83143
	Models with Hendrickson HMX 400/460 Haulmax with 17.5" & 18.5" Saddle	60680-005L 60680005L 60680005 HDR60680-005 HDR60680005 60680-005	OO	OO	83142
19-21	Models with 18,000 to 20,000 lb (Set Forward) Front Axle	3868265C1	OO	85995	OO
19-20	Models with 16,000 lb to 23,000 lb Parabolic Taperleaf Springs	3576464C2	OO	85957	OO

INTERNATIONAL

M1100 / M1200

68-72	All		OO	82007	OO	61500 81147 G63405	43048 ⁸ 49310 ⁷
	Single System Steering Stabilizer; 1/2 & 3/4 Ton with I-Beam Axle		OO	6802SE ⁸⁴								

M1400

69	All		OO	82007	OO	61500 81147 G63405	43048 ⁸ 49310 ⁷
	Single System Steering Stabilizer; 1/2 & 3/4 Ton with I-Beam Axle		OO	6802SE ⁸⁴								

MV SERIES

19-22	MV607 Models with 11,000 lb to 14,000 lb Front axle	6127714C1	OO	85928	OO
19	MV607 Models with 20,000 lb International IROS Air Suspension	6127713C1	OO	OO	85656
	MV607 Models with 40,000 lb Rear Air Suspension	3549099C3	OO	OO	85923 89458
	MV607 Models with 8,000 lb Front Suspension	3533356C3	OO	83169	OO



MV607

20-22	Models with 20,000 lb International IROS Air Suspension	6127713C2	OO	OO	85656
19-22	Models with 9,000 to 10,000 lb Front Suspension	6127088C1	OO	83163	OO
	Models with Hendrickson HAS - 230 or 460 Rear Air Suspension	60675-003 H60675-003 3514952C1 60675-003L 60675003L 60675003 H60675003	OO	OO	85976

7 Pair Packs, Air hose kit included.;

8 Pair Packs.;

APPLICATION GUIDE

Year	Fitment Notes	OEM#								
			Fleetline\ Gas SLX	Classic\ Ultra\ ProGuard\ Guardian	Max Control\ LTV Severe Duty\ Load Carrier	Steering Dampers\ Steering Stabilizer\ Cab Shock	Fleetline\ Gas SLX	Classic\ Ultra\ ProGuard\ Guardian	Max Control\ LTV Severe Duty\ Load Carrier\ HiJackers	Steering Dampers\ Steering Stabilizer\ Cab Shock

INTERNATIONAL TERRASTAR

12-18	Models with 6,000 to 7,000 lb Front Axle	3989717C1 3991991C1 OE 18513 3902993C1 3902993C3 OE17103	83135
12-17	Models with 10,000 & 13,500 lb Vari-Rate Rear Spring Suspension	3586902C2	83364
	Models with 10,500 or 13,500 lb Vari-Rate Rear Spring Suspension	6127087C1 3586902C3	83364
14	4 WD Models with Rear Spring Suspension	6127096C1 3945165C1	83180

INTERNATIONAL

TRAVELALL

75	Single System Steering Stabilizer						6803SE ⁶⁴			
	Steering Stabilizer						6802SE ⁶⁴			

ISUZU

ISUZU

ADDITIONAL APPLICATIONS

85	KS22 Models (All)	8-97083-027-0	83515
		9-51630-666-2 9516306660 9-51630-666-0 9516306662	85012 89413

ALL MODELS WITH

	Models with O.E.M. Number	8-97253-623-0 8972019600 8972536160 8-97253-621-0 8-97253-616-0 898098-1250 8980981270 898098-1270 8972536210 8972536230 8980981250	83515
--	---------------------------	---	-------	------	------	------	------	------	------	------



FRR

00-03	All	1-51630-219-1 1-51630-219-0 51630219	83114
99	Models with O.E.M. Number	1-51630-219-1 1-51630-219-0 51630219	83114
95-98	All	1-51630-219-1 1-51630-219-0 51630219	83114

FSR

97-02	Models with 15000, 19000, 21000 lb Multileaf Springs	8-22064232-0 8220642320	85071
	Models with 19000, 21000, 23000 lb Taperleaf Springs (EXC Low Profile Veh.)	8220642330 8-22064233-0	83136
	Models with FL1 Tilt Cab with 8100 lb Axle (Including Low Profile)	8-22064804-0 8-22064805-0 8220648050 8220648040	83136
87-96	FSR Models	1-51630-217-1	83114
		1-51630-167-0 1516301670	83613

APPLICATION GUIDE

Year	Fitment Notes	OEM#								
			Fleetline\ Gas SLX	Classic\ Ultra\ ProGuard\ Guardian	Max Control\ LTV Severe Duty\ Load Carrier	Steering Dampers\ Steering Stabilizer\ Cab Shock	Fleetline\ Gas SLX	Classic\ Ultra\ ProGuard\ Guardian	Max Control\ LTV Severe Duty\ Load Carrier\ HiJackers	Steering Dampers\ Steering Stabilizer\ Cab Shock

ISUZU

ISUZU

FSR (cont)

87-92	FSR Models	1516301600 1-51630-160-0	 ○	83162
		1516301681 51630168 1-51630-168-1	 ○	83515
86	Models with O.E.M. Number	1-51630-217-1	 ○	83114
		1516301600 1-51630-160-0	 ○	83162
		1516301681 51630168 1-51630-168-1	 ○	83515



FTR

18-22	Models with Hendrickson HAS suspension	8-97517-966-1 60670-005 60670005L 8975179661 8975179660 60670-005L 60670005 8-97517-966-0	 ○	83137	 ○	83137
18-20	FTR Diesel Models with Std Cab	8-98321-912-1 8983219121	 	85071	 	85071
00-11	Models with Hendrickson HAS suspension	8-97517-966-1 60670-005 60670005L 8975179661 8975179660 60670-005L 60670005 8-97517-966-0	 ○	83137	 ○	83137
05-09	Models with O.E.M. Number	98098127 8980981270 8982326720 8-98098-127-0	 ○	83515	 ○	83515
		98098059 8983162280 8-98098-059-0 8-98098-059-1 8-98316-228-0 8980980590 8980980591	 ○	83159	 ○	83159
97-09	Models with 19000, 21000, 23000 lb Taperleaf Springs (EXC Low Profile Veh.)	8220642330 8-22064233-0	 	83136	 	83136
		88982682 8220648070 8220648060 8-22064-806-0 8-22064-807-0 15123676	 	83136	 	83136
90-09	Models with 15000, 19000, 21000 lb Multileaf Springs	15174902 8-22064232-0 8220642320 88982686	 	85071	 	85071
90-96	Models with O.E.M. Number	88982682	 	83136	 	83136
88-96	Models with O.E.M. Number	1-51630-167-0 1516301670	 	83613	 	83613

FVR

	Models with Hendrickson HAS suspension	12474915	 ○	83122 89406	 ○	83122 89406
00-11	Models with Hendrickson HAS suspension	8-97517-966-1 60670-005 60670005L 8975179661 8975179660 60670-005L 60670005 8-97517-966-0	 ○	83137	 ○	83137

APPLICATION GUIDE

Year	Fitment Notes	OEM#								
			Fleetline/ Gas SLX	Classic/ Ultra/ ProGuard/ Guardian	Max Control/ LTV Severe Duty/ Load Carrier	Steering Dampers/ Steering Stabilizer/ Cab Shock	Fleetline/ Gas SLX	Classic/ Ultra/ ProGuard/ Guardian	Max Control/ LTV Severe Duty/ Load Carrier/ HiJackers	Steering Dampers/ Steering Stabilizer/ Cab Shock

ISUZU

ISUZU



FVR (cont)

97-09	Models with 19000, 21000, 23000 lb Taperleaf Springs (EXC Low Profile Veh.)	8220642330 8-22064233-0			83136
	Models with O.E.M. Number	88982682 8220648070 15887728 8220648060 8-22064-806-0 8-22064-807-0 19152843		83136
94-09	Models with 15000, 19000, 21000 lb Multileaf Springs	8-22064232-0 8220642320 88982686			85071
94-96	FVR Short & Middle Chassis	1516301600 1-51630-160-0		83162
	Models with O.E.M. Number	1-51630-167-0 1516301670			83613
90-92	Models with 15000, 19000, 21000 lb Multileaf Springs	8-22064232-0 8220642320 88982686			85071
88-92	FVR Short & Middle Chassis	1516301600 1-51630-160-0		83162
	Models with O.E.M. Number	1-51630-167-0 1516301670			83613

NPR

19-23	Models with O.E.M. Number	8-97253-620-1 98098125 8-98381-012-0 97083029 94454987 98232671 8-98381-010-0 97083027 8-98232671-1 8-98232671-0 97253620 8-94454-647-1 8-97253-620-0 8-98098-125-0 8983810120 8-97083-027-0 8983810100 9-51630-647-1 8-97083-029-0 51630647 94454986 8-94454-986-0 8-94454-987-0 8982326710		83515
19	Models with O.E.M. Number	8-97253-665-0 898098-0581 8-98098-058-0 8-98098-058-1 8-98098-059-0 8-98098-059-1 8-98316227-0 8-98316-228-0			83159
95-18	Models with O.E.M. Number	98098059 8-97253-665-0 898098-0581 98098058 8-97253-651-2 8-97253-664-0 97253664 98316227 97253665 97253651 8-98098-058-0 8-98098-058-1 8-98098-059-0 8-98098-059-1 8-98316227-0 8-98316-228-0			83159

APPLICATION GUIDE

Year	Fitment Notes	OEM#								
			Fleetline\ Gas SLX	Classic\ Ultra\ ProGuard\ Guardian	Max Control\ LTV Severe Duty\ Load Carrier	Steering Dampers\ Steering Stabilizer\ Cab Shock	Fleetline\ Gas SLX	Classic\ Ultra\ ProGuard\ Guardian	Max Control\ LTV Severe Duty\ Load Carrier\ HiJackers	Steering Dampers\ Steering Stabilizer\ Cab Shock

ISUZU

ISUZU



NPR (cont)

86-18	Models with O.E.M. Number	8-97253-620-1 98098125 8-98381-012-0 97083029 94454987 98232671 8-98381-010-0 97083027 8-98232671-1 8-98232671-0 97253620 8-94454-647-1 8-97253-620-0 8-98098-125-0 8983810120 8-97083-027-0 8983810100 9-51630-647-1 8-97083-029-0 51630647 94454986 8-94454-986-0 8-94454-987-0 8982326710	83515
86-95	All	9-51630-666-2 51630666 9516306660 9-51630-666-0 9516306662	85012 89413
84-85	Models with O.E.M. Number	8-97253-620-1 98098125 8-98381-012-0 97083029 94454987 98232671 8-98381-010-0 97083027 8-98232671-1 8-98232671-0 97253620 8-94454-647-1 8-97253-620-0 8-98098-125-0 8983810120 8-97083-027-0 8983810100 9-51630-647-1 8-97083-029-0 51630647 94454986 8-94454-986-0 8-94454-987-0 8982326710	83515

NPR-HD

20-23	Models with 14,000 to 15,000 lb Rear	8983807460 8-98380-746-0	83159
	Models with 15,000 to 16,000 lb Rear	8983807470 8-98380-747-0	83159
99-23	Models with O.E.M. Number	8-97253-620-1 98098125 8-98381-012-0 97083029 94454987 98232671 8-98381-010-0 97083027 8-98232671-1 8-98232671-0 97253620 8-94454-647-1 8-97253-620-0 8-98098-125-0 8983810120 8-97083-027-0 8983810100 9-51630-647-1 8-97083-029-0 51630647 94454986 8-94454-986-0 8-94454-987-0 8982326710	83515

APPLICATION GUIDE

Year	Fitment Notes	OEM#								
			Fleetline\ Gas SLX	Classic\ Ultra\ ProGuard\ Guardian	Max Control\ LTV Severe Duty\ Load Carrier	Steering Dampers\ Steering Stabilizer\ Cab Shock	Fleetline\ Gas SLX	Classic\ Ultra\ ProGuard\ Guardian	Max Control\ LTV Severe Duty\ Load Carrier\ HiJackers	Steering Dampers\ Steering Stabilizer\ Cab Shock

ISUZU

ISUZU

NPR-HD (cont)

18-19	Models with O.E.M. Number	8-97253-665-0 898098-0581 8-98098-058-0 8-98098-058-1 8-98098-059-0 8-98098-059-1 8-98316227-0 8-98316-228-0			83159
03-17	Models with O.E.M. Number	98098059 8-97253-665-0 898098-0581 98098058 8-98098-058-0 8-98098-058-1 8-98098-059-0 8-98098-059-1 8-98316227-0 8-98316-228-0 98316227 97253665			83159



NPR-XD

23	Models with 14,000 to 15,000 lb GVW	8983810100 8-98381-010-0		83515	
		8983807460 8-98380-746-0	 O		83159	
	Models with 15,000 to 16,000 lb GVW	8-98381-012-0	 O	83515
		8983807470 8-98380-747-0	 O		83159
15-22	Models with 14,000 to 15,000 lb GVW	8983810100 8-98381-010-0	 O	83515	
		8983807460 8-98380-746-0	 O		83159
	Models with 15,000 to 16,000 lb GVW	8983810120 8-98381-012-0	 O	83515
		8983807470 8-98380-747-0	 O		83159

NQR

20-23	Models with 15,000 to 16,000 lb Rear	8983807470 8-98380-747-0			83159
94-23	Models with O.E.M. Number	8-97253-620-1 98098125 8-98381-012-0 97083029 94454987 98232671 8-98381-010-0 97083027 8-98232671-1 8-98232671-0 97253620 8-94454-647-1 8-97253-620-0 8-98098-125-0 8983810120 8-97083-027-0 8983810100 9-51630-647-1 8-97083-029-0 51630647 94454986 8-94454-986-0 8-94454-987-0 8982326710		83515
		8-98381-010-0	 O
03-19	Models with O.E.M. Number	98098059 8-97253-665-0 8-98098-059-0 8-98098-059-1 8-98343986-0 8-98316-228-0 97253665 98343986			83159
02	Diesel	8-97253-664-0 97253664			83159
95-97	Diesel	8-97253-664-0 97253664			83159

APPLICATION GUIDE

Year	Fitment Notes	OEM#								
			Fleetline\ Gas SLX	Classic\ Ultra\ ProGuard\ Guardian	Max Control\ LTV Severe Duty\ Load Carrier	Steering Dampers\ Steering Stabilizer\ Cab Shock	Fleetline\ Gas SLX	Classic\ Ultra\ ProGuard\ Guardian	Max Control\ LTV Severe Duty\ Load Carrier\ HiJackers	Steering Dampers\ Steering Stabilizer\ Cab Shock

ISUZU

ISUZU

NRR

20-23	Models with 15,000 to 16,000 lb Rear	8983807470 8-98380-747-0		83159		83159
05-23	Models with O.E.M. Number	8-97253-620-1 98098125 8-98381-012-0 97083029 94454987 98232671 8-98381-010-0 97083027 8-98232671-1 8-98232671-0 97253620 8-94454-647-1 8-97253-620-0 8-98098-125-0 8983810120 8-97083-027-0 8983810100 9-51630-647-1 8-97083-029-0 51630647 94454986 8-94454-986-0 8-94454-987-0 8982326710	 O	83159	 O	83159
05-19	Models with O.E.M. Number	98098059 8-97253-665-0 8-98098-059-0 8-98098-059-1 8-98343986-0 8-98316-228-0 97253665 98343986		83159	 O	83159
88-94	All	1-51630-219-1 1-51630-217-1 1-51630-217-0 51630217	 O	83114		83114
	Models with O.E.M. Number	8-97253-620-1 98098125 8-98381-012-0 97083029 94454987 98232671 8-98381-010-0 97083027 8-98232671-1 8-98232671-0 97253620 8-94454-647-1 8-97253-620-0 8-98098-125-0 8983810120 8-97083-027-0 8983810100 9-51630-647-1 8-97083-029-0 51630647 94454986 8-94454-986-0 8-94454-987-0 8982326710	 O	83159	 O	83159

REACH

11-15	Models with O.E.M. Number	8983810100 8-98381-010-0	 O	83515		83515
		8983807460 8-98380-746-0		83159	 O	83159



KENWORTH

KENWORTH

K270

13-24	Models with 10,000 lb to 12,000 lb Front Axle	1707378PAC BFRG 072	 T	85182		85182
	Models with Hendrickson HAS - 210L or HAS - 230L Rear Air Suspension	60670008L 60670-008 60670-008L 60670008		83123 89405	 O	83123 89405

APPLICATION GUIDE

Year	Fitment Notes	OEM#								
			Fleetline/ Gas SLX	Classic/ Ultra/ ProGuard/ Guardian	Max Control/ LTV Severe Duty/ Load Carrier	Steering Dampers/ Steering Stabilizer/ Cab Shock	Fleetline/ Gas SLX	Classic/ Ultra/ ProGuard/ Guardian	Max Control/ LTV Severe Duty/ Load Carrier/ HiJackers	Steering Dampers/ Steering Stabilizer/ Cab Shock

KENWORTH

KENWORTH

K270 (cont)

13-24	Models with Reyco 102 or 79KB Suspension (Drive Axle)	19495-01 1672501 16725-01 1949501	83126 89430
13-23	Models with Hendrickson HAS - 230 Rear Air Suspension	60670-005 60670005L 60670-005PLUS-2 60670-005L 60670005	83137

K300

93-05	All with Air Glide 100 Suspension with 8 air bags, 4 units required	K374-29 K37432 K374-32 K37429	85310 89423
	All with Air Glide 200 with 40,000 lb Suspension with 8 air bags, 4 units required	665903 70701 665944	85900
	All with Air Glide 200 with 46,000 lb Suspension with 8 air bags, 4 units required	665945 665906	85902
	K300 COE Medium Duty	665565	85007
	Models with 12,000 lb Taper Leaf Front Springs (5/8" Top Mounting bolt)	665617 B71-1000 B711000	85031
	Models with Hendrickson Rear Air Suspension	4790219 47902-19	83123 89405
	Models with Multiple Leaf Springs on Front Axle (3/4" Mounting bolts)	B71-1003 B711003 K374-33 K3743 K37433 K374-3	83312
	Models with Reyco 102 or 79KB Suspension (Drive Axle)	19495-01 1672501 16725-01 1949501	83126 89430
	Models with Reyco 1209 or 1212 Suspension (Steer Axle)	19495-01 1949501	83126
Models with Taper Leaf Springs on Front Axle (1" Mounting bolts)	B71-1002 B711002 K374-16 K374-27 K374-26 K37416 K37427 K37426	85001	
Models with Woodhead Shock (Stamping Number ACHB 966)	ACHB966	83136	



T170

08-22	Models with Reyco 79KB Rear Steel Spring Suspension	19495-01 1672501 16725-01	83126 89430
08-13	Models with 8,000 lb Taper Leaf Front Springs	665617	85031

T270

24	Models with AG210L Rear Air Suspension	C71-1017 C711017 C711011 C71-1011	85069
08-23	Models with AG210L Rear Air Suspension	C71-1017 C711017 C711011 C71-1011	85069 89455

APPLICATION GUIDE

Year	Fitment Notes	OEM#								
			Fleetline\ Gas SLX	Classic\ Ultra\ ProGuard\ Guardian	Max Control\ LTV Severe Duty\ Load Carrier	Steering Dampers\ Steering Stabilizer\ Cab Shock	Fleetline\ Gas SLX	Classic\ Ultra\ ProGuard\ Guardian	Max Control\ LTV Severe Duty\ Load Carrier\ Hijackers	Steering Dampers\ Steering Stabilizer\ Cab Shock

KENWORTH

KENWORTH

T270 (cont)

08-23	Models with Hendrickson HMX 400/460 Haulmax with 16.5" Saddle	60680-004L 60680-004 64178-001 60680004 60680004L 64178001	83143
15-22	Models with 10,000 lb to 14,600 lb Taperleaf Springs and Set Back Front Axles	B71-6019 B716019	85989
	Models with 16,000 lb to 20,000 lb Taperleaf Springs and Set Back Front Axles	B716020 B71-6020	85989
08-22	Models with Hendrickson HAS - 210L or HAS - 230L Rear Air Suspension	60670008L 60670-008 60670-008L 60670008	83123 89405
	Models with Hendrickson Primaax 230, 232, 460, 462, 690 and 692 Air Suspension (8-1/2" to 10" Ride Height)	60657-003 60657003 60657003L 60657-003L	85072
	Models with Reyco 102 or 79KB Suspension (Drive Axle)	19495-01 1672501 16725-01 1949501 TK19679	83126 89430
10-14	Models with 10,000 lb to 12,000 lb Front Axle	B71-6005 B716005	85084
	Models with 13,200 lb to 14,600 lb Front Axle	B71-6006 B716006	85084
	Models with 8,000 lb Front Axle	B71-6004 B716004	85084
08-14	Models with Hendrickson HAS - 400 (Standard) Rear Air Suspension	60670-005 60670005L 60670-005L 60670005	83137
08-10	Models with 12,000 lb Front Axle	665617	85031



T280

21-24	Models with Reyco 102 or 79KB Suspension (Drive Axle)	19495-01 1949501	83126 89430
24	Models with 10,000 lb to 12,000 lb Mono-leaf front springs	B71-6019 B716019	85989

T300

	All with Air Glide 100 Suspension with 8 air bags, 4 units required	K374-29 K37432 K374-32 K37429	85310 89423
	All with Air Glide 200 with 40,000 lb Suspension with 8 air bags, 4 units required	665903 70701 665944	85900
	Models with Hendrickson Rear Air Suspension	60670004 4790219	83123 89405
	Models with Multiple Leaf Springs on Front Axle (3/4" Mounting bolts)	B71-1003 B711003 K374-33 K3743 K37433 K374-3	83312

APPLICATION GUIDE

Year	Fitment Notes	OEM#								
			Fleetline\ Gas SLX	Classic\ Ultra\ ProGuard\ Guardian	Max Control\ LTV Severe Duty\ Load Carrier	Steering Dampers\ Steering Stabilizer\ Cab Shock	Fleetline\ Gas SLX	Classic\ Ultra\ ProGuard\ Guardian	Max Control\ LTV Severe Duty\ Load Carrier\ HiJackers	Steering Dampers\ Steering Stabilizer\ Cab Shock

KENWORTH

KENWORTH

T300 (cont)

	Models with Reyco 102 or 79KB Suspension (Drive Axle)	19495-01 1672501 16725-01 1949501	OO	83126	89430	83126	89430	83126	89430	83126	89430	83126	89430
	Models with Reyco 1209 or 1212 Suspension (Steer Axle)	19495-01 1949501	OO	83126	89430	83126	89430	83126	89430	83126	89430	83126	89430
	Models with Taper Leaf Springs on Front Axle (1" Mounting bolts)	B71-1002 B711002 K374-16 K374-27 K374-26 K37416 K37427 K37426	OO	85001	89430	85001	89430	85001	89430	85001	89430	85001	89430
	Models with Woodhead Shock (Stamping Number ACHB 966)	ACHB966	OO	83136	89430	83136	89430	83136	89430	83136	89430	83136	89430
99-08	Models with 12,000 lb Taper Leaf Front Springs (5/8" Top Mounting bolt)	665617 B71-1000 B711000	OO	85031	89430	85031	89430	85031	89430	85031	89430	85031	89430
	Models with Reyco 102 or 79KB Suspension (Drive Axle)	19495-01 1672501 16725-01 1949501	OO	83126	89430	83126	89430	83126	89430	83126	89430	83126	89430
	Models with Reyco 1209 or 1212 Suspension (Steer Axle)	19495-01 1949501	OO	83126	89430	83126	89430	83126	89430	83126	89430	83126	89430
95-08	All with Air Glide 200 with 46,000 lb Suspension with 8 air bags, 4 units required	665945 665906	OO	85902	89405	85902	89405	85902	89405	85902	89405	85902	89405
	Models with Hendrickson HAS - 210L or HAS - 230L Rear Air Suspension	60670008L 60670-008 60670-008L 60670008	OO	83123	89405	83123	89405	83123	89405	83123	89405	83123	89405

T700

11-16	Models with 13,000 lb Front Axle	665858 B71-1001 B711001	OO	85070	89430	85070	89430	85070	89430	85070	89430	85070	89430
	Models with 86" Sleepers with O.E.M. Number	12021286 1202K286 T71-1003 1202-1286 T711003	OO	83056	89430	83056	89430	83056	89430	83056	89430	83056	89430
	Models with Air Glide 230 (AG230) Rear Air Suspension	671656 C71-1013 C711013	OO	85985	89430	85985	89430	85985	89430	85985	89430	85985	89430
	Models with Air Glide 380 (AG380) Rear Air Suspension	C71-1016 C711016 C71-1002 C71-6015 C711002 C716015	OO	85067	89451	85067	89451	85067	89451	85067	89451	85067	89451
	Models with Air Glide 400 (AG400) Rear Air Suspension	671962 C71-1014 C711014	OO	85936	89456	85936	89456	85936	89456	85936	89456	85936	89456
	Models with Air Glide 400L (AG400L) Rear Air Suspension	03-08781 C71-1017 0308781 C711017 C711011 C71-1011	OO	85069	89455	85069	89455	85069	89455	85069	89455	85069	89455
	Models with Extended Sleeper Cab	R71-1005 12021064 R711005 1202-1064 1202K064	OO	83024	89430	83024	89430	83024	89430	83024	89430	83024	89430

APPLICATION GUIDE

Year	Fitment Notes	OEM#								
			Fleetline\ Gas SLX	Classic\ Ultra\ ProGuard\ Guardian	Max Control\ LTV Severe Duty\ Load Carrier	Steering Dampers\ Steering Stabilizer\ Cab Shock	Fleetline\ Gas SLX	Classic\ Ultra\ ProGuard\ Guardian	Max Control\ LTV Severe Duty\ Load Carrier\ HiJackers	Steering Dampers\ Steering Stabilizer\ Cab Shock

LION

LION

LION 6

	Electric Truck Models with Hendrickson Comfort Air Suspension (21K Capacity)	60670-018 60670-030L 60670030 60670018L 60670-030 60670030L 60670-018L 60670018					83166			
--	--	--	--	--	--	--	-------	--	--	--

MACK

MACK

MD6

24	Models with 10,000 lb Taperleaf Springs	78530771 471700015341		83127						
	Models with O.E.M. Number	23145372				83066				
		23159760					85188			
23	Models with 10,000 lb Taperleaf Springs	78530771 471700015341		83127						
	Models with O.E.M. Number	23159760					85188			
		23145372							83066	
21-22	Models with 10,000 lb Taperleaf Springs	78530771 471700015341		83127						
	Models with O.E.M. Number	23145372				83066				
		23159760					85188			

MARMON HERRINGTON

MARMON HERRINGTON

57 GLIDER

96-97	Conventional Tractors with Link Cabmate Model MARC57-B	12020054 12010054 1201-0054 1202-0054				83021				
90-94	Conventional Tractors with Link Cabmate Model MARC57-B	12020054 12010054 1201-0054 1202-0054				83021				

MERCEDES-BENZ

MERCEDES-BENZ

SPRINTER 2500

10-18	All				G57802 ⁴⁰					
-------	-----	--	--	--	----------------------	--	--	--	--	--

SPRINTER 3500

19-20	All					G64089				
11-18	All				G57802 ⁴⁰		G64089			
10	All				G57802 ⁴⁰					



MITSUBISHI FUSO

MITSUBISHI FUSO

FE

96-04	Model with O.E.M. Number	MC114595				G63405				
	Models with O.E.M. Number	MK433638		G63610						
		MA302296					G63299			
87-04	Model with O.E.M. Number	MB161497								

APPLICATION GUIDE

Year	Fitment Notes	OEM#								
			Fleetline\ Gas SLX	Classic\ Ultra\ ProGuard\ Guardian	Max Control\ LTV Severe Duty\ Load Carrier	Steering Dampers\ Steering Stabilizer\ Cab Shock	Fleetline\ Gas SLX	Classic\ Ultra\ ProGuard\ Guardian	Max Control\ LTV Severe Duty\ Load Carrier\ HiJackers	Steering Dampers\ Steering Stabilizer\ Cab Shock

MITSUBISHI FUSO

MITSUBISHI FUSO

FE145

05-11	Models with O.E.M. Number	MK433638 MK302296	I O	G63610
-------	---------------------------	----------------------	--------	------	--------	------	------	------	------	------	------

FG

98-04	Model with O.E.M. Number	MC714595	I O
-------	--------------------------	----------	--------	------	--	------	------	------	------	------	------

FH

88-04	Models with O.E.M. Number	MC826268	I O	G63610
-------	---------------------------	----------	--------	------	--------	------	------	------	------	------	------

FK

91-94	FK457 Models with O.E.M. Number	MC814614	I O	85009	
88-91	FK455 Models with O.E.M. Number	MC814614	I O	85009	

FM330

05-11	Models with O.E.M. Number	MC091950	I O	83162	
-------	---------------------------	----------	--------	-------	--	------	------	------	------	------	------

NISSAN

NISSAN

NV1500

12-19	All		I O
-------	-----	--	--------	------	--	------	------	------	------	------	------

NV2500

12-19	All		I O
-------	-----	--	--------	------	--	------	------	------	------	------	------

NV3500

12-19	All		I O
-------	-----	--	--------	------	--	------	------	------	------	------	------

PETERBILT

PETERBILT



210

08-15	Models with Reyco 102 or 79KB Suspension (Drive Axle)	19495-01 1672501 16725-01 1949501 TK19679	I O
-------	---	---	--------	------	--	------	------	------	------	------	------

220

13-24	Models with Hendrickson HAS - 210L or HAS - 230L Rear Air Suspension	60670-008PLUS-2 60670008L 60670-008 60670-008L 60670008	I O
	Models with Reyco 102 or 79KB Suspension (Drive Axle)	19495-01 1672501 16725-01 1949501 TK19679	I O
13-23	Models with 12,000 lb Front Axle	1707378PAC BFRG 072	I T	85182	
13-22	Models with Reyco 102AR (Standard) Rear Air Suspension	1288701 12887-02 12887-01 1288702	I O
13	Models with 12,000 lb Front Axle	0202738 B71-6016A B71-6016 B716016A 02-02738 B716016	I O	85012	
10	Models with 12,000 lb Front Axle	0202738 B71-6016A B71-6016 B716016A 02-02738 B716016	I O	85012	

APPLICATION GUIDE

Year	Fitment Notes	OEM#								
			Fleetline\ Gas SLX	Classic\ Ultra\ ProGuard\ Guardian	Max Control\ LTV Severe Duty\ Load Carrier	Steering Dampers\ Steering Stabilizer\ Cab Shock	Fleetline\ Gas SLX	Classic\ Ultra\ ProGuard\ Guardian	Max Control\ LTV Severe Duty\ Load Carrier\ Hijackers	Steering Dampers\ Steering Stabilizer\ Cab Shock

PETERBILT

PETERBILT

220 (cont)

10	Models with Hendrickson HAS - 210L or HAS - 230L Rear Air Suspension	60670-008PLUS-2 60670008L 60670-008 60670-008L 60670008	83123 89405
	Models with Reyco 102 or 79KB Suspension (Drive Axle)	19495-01 1672501 16725-01 1949501 TK19679	83126 89430
	Models with Reyco 102AR (Standard) Rear Air Suspension	1288701 12887-02 12887-01 1288702	85013 89414
07	Models with 12,000 lb Front Axle	0202738 B71-6016A B71-6016 B716016A 02-02738 B716016	85012
	Models with Hendrickson HAS - 210L or HAS - 230L Rear Air Suspension	60670-008PLUS-2 60670008L 60670-008 60670-008L 60670008	83123 89405
	Models with Reyco 102 or 79KB Suspension (Drive Axle)	19495-01 1672501 16725-01 1949501 TK19679	83126 89430
	Models with Reyco 102AR (Standard) Rear Air Suspension	1288701 12887-02 12887-01 1288702	85013 89414



325

08-19	Models with 12000 lb Set Back Front Axle	0202738 B71-6016A B71-6016 B716016A 02-02738 B716016	85012
	Models with Reyco 102 or 79KB Suspension (Drive Axle)	19495-01 1949501 TK19679	83126 89430
08-15	Models with 8,000 lb Front Axle	B71-6004 B716004	85084

330

	Models with O.E.M. Number	0203020 B71-6017 02-03020 B716017	85910
16-22	Models with 10,000 lb to 14,600 lb Taperleaf Springs and Set Back Front Axles	B71-6019 B716019	85989
07-22	Models with Peterbilt Low Air Leaf Suspension	03-08781 C71-1017 0308781 C711017 C711011 C71-1011	85069 89455
	Models with Reyco 79KB Rear Steel Spring Suspension	19495-01 1672501 16725-01 1949501 TK19679	83126 89430
14-21	Models with Air Trac Suspension (40,000 lb)	C71-6003 C716003	85988
07-21	Models with Air Trac Suspension (46,000 lb)	0307421 C71-6002 03-07421 C716002	85311 89424

APPLICATION GUIDE

Year	Fitment Notes	OEM#								
			Fleetline/ Gas SLX	Classic/ Ultra/ ProGuard/ Guardian	Max Control/ LTV Severe Duty/ Load Carrier	Steering Dampers/ Steering Stabilizer/ Cab Shock	Fleetline/ Gas SLX	Classic/ Ultra/ ProGuard/ Guardian	Max Control/ LTV Severe Duty/ Load Carrier/ HiJackers	Steering Dampers/ Steering Stabilizer/ Cab Shock

PETERBILT

PETERBILT

330 (cont)

07-21	Models with Reyco 102AR (Standard) Rear Air Suspension	1288701 12887-02 12887-01 1288702	85013 89414
07-16	Models with 12000 lb Set Back Front Axle	0202738 B71-6016A B71-6016 B716016A 02-02738 B716016	OO	85012
03-05	Models with Peterbilt Low Air Leaf Suspension	03-08781 C71-1017 0308781 C711017 C711011 C71-1011	85069 89455
95-05	Models with 12000 lb Set Back Front Axle	0202738 B71-6016A B71-6016 B716016A 02-02738 B716016	OO	85012
	Models with Air Trac Suspension (46,000 lb)	0307421 C71-6002 03-07421 C716002	85311 89424
	Models with Reyco 102AR (Standard) Rear Air Suspension	1288701 12887-02 12887-01 1288702	85013 89414
	Models with Reyco 79KB Rear Steel Spring Suspension	19495-01 1672501 16725-01 1949501 TK19679	83126 89430
95-02	Models with Peterbilt 40000 lb Low Air Leaf Suspension	03-07423 0307423	85033 89427

536

22-24	Models with 10,000 lb to 14,600 lb Taperleaf Springs and Set Back Front Axles	B71-6019 B716019	OO	85989
	Models with Air Trac Suspension (40,000 lb)	C71-6003 C716003	85988
	Models with Peterbilt Low Air Leaf Suspension	C71-1017 C711017	85069 89455

PLYMOUTH

PLYMOUTH

VAN 3/4 TON, PB SERIES

74-83	All		61523 ³⁵ 81096 ³⁵ G63359 ³⁵	34052 ⁸ 58359 ³⁵	61522 ⁸ 81496 G63413	43085 ⁸ 49212 ⁷
-------	-----	--	-------	--	---	-------	-------	---------------------------------------	--	-------

VAN 1 TON, PB SERIES

74-83	All		61523 ³⁵ 81096 ³⁵ G63359 ³⁵	34052 ⁸ 58359 ³⁵	61522 ⁸ 81496 G63413	43085 ⁸ 49212 ⁷
	4000# Front Axle		81834 G63360 ³⁵
	Exc. 4000# Front Axle		61523 ³⁵ 81096 ³⁵ G63359 ³⁵	34052 ⁸ 58359 ³⁵

6 It is recommended that when replacing shocks on vehicles with "quad shocks" all 4 shocks should be matched by series;
8 Pair Packs.;

7 Pair Packs, Air hose kit included.;

35 Slight grinding of control arm opening is required to install product made before Aug 1988.;

APPLICATION GUIDE

Year	Fitment Notes	OEM#								
			Fleetline\ Gas SLX	Classic\ Ultra\ ProGuard\ Guardian	Max Control\ LTV Severe Duty\ Load Carrier	Steering Dampers\ Steering Stabilizer\ Cab Shock	Fleetline\ Gas SLX	Classic\ Ultra\ ProGuard\ Guardian	Max Control\ LTV Severe Duty\ Load Carrier\ Hijackers	Steering Dampers\ Steering Stabilizer\ Cab Shock

RAM

RAM

1500 CLASSIC

19-22	Old Body Style			58412
19-20	All			77412
	4WD			G64044
	4WD, Old Body Style			G51856 G57147 ⁴⁰
	RWD, Old Body Style			G64043

1500 (SEE DODGE RAM 1500)

16-18	4WD, Exc. Air Suspension			G51856 G57147 ⁴⁰
	RWD, Exc. Air Suspension			G64043
11-18	All			G64044	58412 77412
11-15	4WD			G51856 G57147 ⁴⁰
	RWD			G64043

2500 (SEE DODGE RAM 2500)

15-18	Power Wagon			77948
	Power Wagon, 4WD			G64009
14-15	RWD			77949
	RWD, Standard Cab Pickup			G64043
14	4WD			G64009	77948
11-13	All			77950
	4WD			G64009	77948	61716 G64013
	RWD, Standard Cab Pickup			G64043	77949



3500 (SEE DODGE RAM 3500)

16-20	4WD			G63673	G64121	43181 ⁸ 77976
14-15	4WD			G63673	77948	G64121	43181 ⁸ 77976
11-15	RWD			77949
	RWD, Standard Cab Pickup			G64043
11-13	All			77950
	4WD			G63673	77948

4500

12-18	Models with O.E.M. Number	6811 1105AC001 05168295AB 05168284AC 6811 1104AB-001 6811 1105AC 6811 1105AC-001 6811 1104AB 6811 1104AB001		85649
		05168296AA 6811 1107AA 6811 1107AA-001 6811 1107AA001		85650

APPLICATION GUIDE

Year	Fitment Notes	OEM#								
			Fleetline\ Gas SLX	Classic\ Ultra\ ProGuard\ Guardian	Max Control\ LTV Severe Duty\ Load Carrier	Steering Dampers\ Steering Stabilizer\ Cab Shock	Fleetline\ Gas SLX	Classic\ Ultra\ ProGuard\ Guardian	Max Control\ LTV Severe Duty\ Load Carrier\ HiJackers	Steering Dampers\ Steering Stabilizer\ Cab Shock

RAM

RAM

5500

12-18	Models with O.E.M. Number	6811 1105AC001 05168295AB 05168284AC 6811 1104AB-001 6811 1105AC 6811 1105AC-001 6811 1104AB 6811 1104AB001	LO	85649				
		05168296AA 6811 1107AA 6811 1107AA-001 6811 1107AA001		85650

PROMASTER 1500

14-22	Left		LO		G57800 ⁴⁰				
	Right		LO		G57801 ⁴⁰				

PROMASTER 2500

14-22	Left		LO		G57800 ⁴⁰				
	Right		LO		G57801 ⁴⁰				

PROMASTER 3500

14-22	Left		LO		G57800 ⁴⁰				
	Right		LO		G57801 ⁴⁰				

SPARTAN MOTORS

SPARTAN MOTORS

HIGHLANDER

97-00	With I Beam Front Suspension	B462151 B461732		85030
-------	------------------------------	--------------------	--	------	------	------	------	-------	------	------	------



STERLING TRUCK

STERLING TRUCK

ACTERRA

	Models with 11000 to 12000 lb Front axle	6803230300	LO	85006				
03-10	All Models with Freightliner TufTrac Rear Air Suspension	1615770000 481700125969 16-15770-000	LO	85956
	Models with 15000 lb Rear Suspension	6803260000	LO	83120
	Models with FAS II (40,000 lb) Rear Air Suspension	16-15817-000 1613957000 1615817000 16-13957-000 680611 680339 XC4518080BA XC45-18080-BA	LO	85724 89443
	Models with Hendrickson Front Airtek	58913003 58913003L 58913-003L 471700131331 58913-003	LO	85932
01-09	Models with 10000 to 12000 lb. Taper-leaf Spring Suspension	1012390000 10-12390-000	LO	85920
	Models with 6000 to 9000 lb Front axle	10-12388-000 1012388000	LO	85920

APPLICATION GUIDE

Year	Fitment Notes	OEM#								
			Fleetline\ Gas SLX	Classic\ Ultra\ ProGuard\ Guardian	Max Control\ LTV Severe Duty\ Load Carrier	Steering Dampers\ Steering Stabilizer\ Cab Shock	Fleetline\ Gas SLX	Classic\ Ultra\ ProGuard\ Guardian	Max Control\ LTV Severe Duty\ Load Carrier\ Hijackers	Steering Dampers\ Steering Stabilizer\ Cab Shock

STERLING TRUCK

STERLING TRUCK

ACTERRA 5500

01-07	Models with 15000 lb Rear Suspension	6803260000	O I	83120
	Models with FAS II (40,000 lb) Rear Air Suspension	16-15817-000 1613957000 1615817000 16-13957-000 680611 680339 XC4518080BA XC45-18080-BA	O O	85724 89443
	Models with Hendrickson Front Airtek	58913003 58913003L 58913-003L 471700131331 58913-003	O O	85932

ACTERRA 6500

01-07	Models with 15000 lb Rear Suspension	6803260000	O I	83120
	Models with FAS II (40,000 lb) Rear Air Suspension	16-15817-000 1613957000 1615817000 16-13957-000 680611 680339 XC4518080BA XC45-18080-BA	O O	85724 89443
	Models with Hendrickson Front Airtek	58913003 58913003L 58913-003L 471700131331 58913-003	O O	85932

BULLET 45

08-10	Models with O.E.M. Number	6811 1105AC001 05168295AB 05168284AC 6811 1104AB-001 6811 1105AC 6811 1105AC-001 6811 1104AB 6811 1104AB001	I O	85649
		05168296AA 6811 1107AA 6811 1107AA-001 6811 1107AA001	O O	85650

BULLET 55

08-10	Models with O.E.M. Number	6811 1105AC001 05168295AB 05168284AC 6811 1104AB-001 6811 1105AC 6811 1105AC-001 6811 1104AB 6811 1104AB001	I O	85649
		05168296AA 6811 1107AA 6811 1107AA-001 6811 1107AA001	O O	85650



UD

UD

550T

89-91	Models with O.E.M. Number	56110-Z5014 56101Z5014 56110-Z5017 56110Z5017 56101Z5017 56101-Z5014 56110Z5014 56101-Z5017	I O	83162
-------	---------------------------	--	--------	-------	------	------	------	------	------	------	------

APPLICATION GUIDE

Year	Fitment Notes	OEM#								
			Fleetline\ Gas SLX	Classic\ Ultra\ ProGuard\ Guardian	Max Control\ LTV Severe Duty\ Load Carrier	Steering Dampers\ Steering Stabilizer\ Cab Shock	Fleetline\ Gas SLX	Classic\ Ultra\ ProGuard\ Guardian	Max Control\ LTV Severe Duty\ Load Carrier\ HiJackers	Steering Dampers\ Steering Stabilizer\ Cab Shock

UD

UD

600T

92-94	Models with O.E.M. Number	56110-Z5014 56101Z5014 56110-Z5017 56110Z5017 56101Z5017 56101-Z5014 56110Z5014 56101-Z5017	I O	83162
-------	---------------------------	--	--------	-------	------	------	------	------	------	------	------	------

1200

99-04	Models with O.E.M. Number	E61000T825 561000T825	I O	83515
-------	---------------------------	--------------------------	--------	-------	------	------	------	------	------	------	------	------

1300

05-07	Models with O.E.M. Number	E61000T825 561000T825	I O	83515
-------	---------------------------	--------------------------	--------	-------	------	------	------	------	------	------	------	------

1400

94-10	Models with O.E.M. Number	E61000T825 561000T825	I O	83515
-------	---------------------------	--------------------------	--------	-------	------	------	------	------	------	------	------	------

1800

89-94	Models with O.E.M. Number	56101-Z5008 56110-Z5008 56110Z5008 56101Z5008	I O	83114
-------	---------------------------	--	--------	-------	------	------	------	------	------	------	------	------

1800CS

99-04	Models with O.E.M. Number	56101-Z5008 56110-Z5008 56110Z5008 56101Z5008	I O	83114
-------	---------------------------	--	--------	-------	------	------	------	------	------	------	------	------

2000

89-94	Models with O.E.M. Number	56101-Z5008 56110-Z5008 56110Z5008 56101Z5008	I O	83114
-------	---------------------------	--	--------	-------	------	------	------	------	------	------	------	------

2600

89-13	Models with O.E.M. Number	56110-Z5014 56101Z5014 56110-Z5017 56110Z5017 56101Z5017 56101-Z5014 56110Z5014 56101-Z5017	I O	83162
-------	---------------------------	--	--------	-------	------	------	------	------	------	------	------	------

UD 18HD SERIES

99-10	Models with 22.5" Tires	56110-30Z02 56101-30Z02	I O	G63610
-------	-------------------------	----------------------------	--------	------	--------	------	------	------	------	------	------	------

UD 1300

	UD 1300 Models Steer Axle	56110T8129 66400 56110-T8123 56110-T8129 56110T8123	I O	G63432
--	---------------------------	---	--------	------	--------	------	------	------	------	------	------	------

UD 1800 SERIES

11-13	Models with 22.5" Tires	56110-30Z02 56101-30Z02	I O	G63610
-------	-------------------------	----------------------------	--------	------	--------	------	------	------	------	------	------	------

95-98	Models with 22.5" Tires	56110-30Z02 56101-30Z02	I O	G63610
-------	-------------------------	----------------------------	--------	------	--------	------	------	------	------	------	------	------

UD 2000 SERIES

95-13	Models with 22.5" Tires	56110-30Z02 56101-30Z02	I O	G63610
-------	-------------------------	----------------------------	--------	------	--------	------	------	------	------	------	------	------



UPS TRUCK

UPS TRUCK

VARIOUS

	Models with O.E.M. Number	P117099	I O	83120
--	---------------------------	---------	--------	------	------	------	------	------	------	-------	------	------	------

APPLICATION GUIDE

Year	Fitment Notes	OEM#								
			Fleetline\ Gas SLX	Classic\ Ultra\ ProGuard\ Guardian	Max Control\ LTV Severe Duty\ Load Carrier	Steering Dampers\ Steering Stabilizer\ Cab Shock	Fleetline\ Gas SLX	Classic\ Ultra\ ProGuard\ Guardian	Max Control\ LTV Severe Duty\ Load Carrier\ HiJackers	Steering Dampers\ Steering Stabilizer\ Cab Shock

WORKHORSE

W20

04-09	Models with O.E.M. Number	W0005663 F4-BE5-F325-HO 24-153256	 	85124
01-09	All	24-153249 F4-BE5-B492-HO W0005662 W0006254 24-186629 F4-BE5-A832-MO F4-BE5-F324-HO	85125

W22

04-09	Models with O.E.M. Number	W0005663 F4-BE5-F325-HO 24-153256	 	85124
01-09	All	24-153249 F4-BE5-B492-HO W0005662 W0006254 24-186629 F4-BE5-A832-MO F4-BE5-F324-HO	85125

W24

04-09	All	24-153249 F4-BE5-B492-HO W0005662 W0006254 24-186629 F4-BE5-A832-MO F4-BE5-F324-HO	85125
	Models with O.E.M. Number	W0005663 F4-BE5-F325-HO 24-153256	 	85124

Numerical listing

Shock	POP	Alternative No.	MTG Acc. Supplied
Pos.	Year	Application	

Steering Stabilizer

Shock	POP	Alternative No.	MTG Acc. Supplied
Pos.	Year	Application	
6802SE A 141998			
F	82-86	CHEVROLET PICKUP 1 TON, C30 6.2L 8Cyl V (379), 3.98 101.0(Bore)3.82 97.0(Stroke) Single System Steering Stabilizer; w/ Cooler All models with factory frame bracket. Kit 143168 required to install to linkage.	
F	75-86	PICKUP 1 TON, C30 4.8L 6Cyl L (292), 3.88 98.4(Bore)4.13 104.8(Stroke) Single System Steering Stabilizer; w/ Cooler All models with factory frame bracket. Kit 143168 required to install to linkage.	
F	75-86	PICKUP 1 TON, C30 5.7L 8Cyl V (350), 4.00 101.6(Bore)3.48 88.5(Stroke) Single System Steering Stabilizer; w/ Cooler All models with factory frame bracket. Kit 143168 required to install to linkage.	
F	80	PICKUP 1 TON, C30 4.1L 6Cyl L (250), 3.68 93.5(Bore)3.91 99.3(Stroke) Single System Steering Stabilizer; w/ Cooler All models with factory frame bracket. Kit 143168 required to install to linkage.	
F	79	PICKUP 1 TON, C30 4.1L 6Cyl L (250) Single System Steering Stabilizer; w/ Cooler All models with factory frame bracket. Kit 143168 required to install to linkage.	
F	76-78	PICKUP 1 TON, C30 6.6L 8Cyl V (400), 4.13 104.8(Bore)3.76 95.5(Stroke) Single System Steering Stabilizer; w/ Cooler All models with factory frame bracket. Kit 143168 required to install to linkage.	
F	78	PICKUP 1 TON, C30 4.1L 6Cyl L (250), 3.68 93.5(Bore)3.91 99.3(Stroke) Single System Steering Stabilizer; w/ Cooler All models with factory frame bracket. Kit 143168 required to install to linkage.	
F	78	PICKUP 1 TON, C30 5.0L 8Cyl V (305), 3.74 94.9(Bore)3.48 88.4(Stroke) Single System Steering Stabilizer; w/ Cooler All models with factory frame bracket. Kit 143168 required to install to linkage.	
F	75	PICKUP 1 TON, C30 4.1L 6Cyl L (250), 3.68 93.5(Bore)3.91 99.3(Stroke) Single System Steering Stabilizer; w/ Cooler All models with factory frame bracket. Kit 143168 required to install to linkage.	
F	77-86	PICKUP 1 TON, K30 All Dual System Steering Stabilizer All models with factory frame bracket. Kit 143168 required to install to linkage.	
F	87-88	PICKUP 1 TON, R30 4.8L 6Cyl L (292), 3.88 98.4(Bore)4.13 104.8(Stroke) Single System Steering Stabilizer; w/ Cooler All models with factory frame bracket. Kit 143168 required to install to linkage.	
F	87-88	PICKUP 1 TON, R30 6.2L 8Cyl V (379), 3.98 101.0(Bore)3.82 97.0(Stroke) Single System Steering Stabilizer; w/ Cooler All models with factory frame bracket. Kit 143168 required to install to linkage.	
F	89-91	PICKUP 1 TON, R3500 5.7L 8Cyl V (350), 4.00 101.6(Bore)3.48 88.5(Stroke) Single System Steering Stabilizer; w/ Cooler All models with factory frame bracket. Kit 143168 required to install to linkage.	
F	63-86	PICKUP 3/4 TON, C20 All Single System Steering Stabilizer All models with factory frame bracket. Kit 143168 required to install to linkage.	

Steering Stabilizer

Shock	POP	Alternative No.	MTG Acc. Supplied
Pos.	Year	Application	

6802SE A (cont) 141998			
F	67-86	PICKUP 3/4 TON, K20 All Dual System Steering Stabilizer All models with factory frame bracket. Kit 143168 required to install to linkage.	
F	87-88	PICKUP 3/4 TON, R20 All Single System Steering Stabilizer All models with factory frame bracket. Kit 143168 required to install to linkage.	
F	89	PICKUP 3/4 TON, R2500 All Single System Steering Stabilizer All models with factory frame bracket. Kit 143168 required to install to linkage.	
F	87	PICKUP 3/4 TON, V20 All Dual System Steering Stabilizer All models with factory frame bracket. Kit 143168 required to install to linkage.	
F	71-95	VAN 1 TON, G / EXPRESS All Single System Steering Stabilizer All models with factory frame bracket. Kit 143168 required to install to linkage.	
F	70-95	VAN 3/4 TON, G / EXPRESS All Single System Steering Stabilizer All models with factory frame bracket. Kit 143168 required to install to linkage.	
F	75-93	DODGE PICKUP 1 TON, D300 SERIES All Single System Steering Stabilizer All models with factory frame bracket. Kit 143168 required to install to linkage.	
F	72-74	PICKUP 1 TON, D300 SERIES All Single System Steering Stabilizer; w/ Coil Spring Front Suspension All models with factory frame bracket. Kit 143168 required to install to linkage.	
F	60-71	PICKUP 1 TON, D300 SERIES All Single System Steering Stabilizer; w/ I-Beam Axle All models with factory frame bracket. Kit 143168 required to install to linkage.	
F	90-93	PICKUP 1 TON, W300 SERIES All Single System Steering Stabilizer All models with factory frame bracket. Kit 143168 required to install to linkage.	
F	60-86	PICKUP 1 TON, W300 SERIES All Dual System Steering Stabilizer; Exc. Vacuum Servo Mounted on Drivers Side of Axle All models with factory frame bracket. Kit 143168 required to install to linkage.	
F	73-93	PICKUP 3/4 TON, D200 SERIES All Single System Steering Stabilizer All models with factory frame bracket. Kit 143168 required to install to linkage.	
F	60-71	PICKUP 3/4 TON, D200 SERIES All Single System Steering Stabilizer; w/ I-Beam Axle All models with factory frame bracket. Kit 143168 required to install to linkage.	
F	90-93	PICKUP 3/4 TON, W200 SERIES All Single System Steering Stabilizer All models with factory frame bracket. Kit 143168 required to install to linkage.	
F	60-86	PICKUP 3/4 TON, W200 SERIES All Dual System Steering Stabilizer; Exc. Vacuum Servo Mounted on Drivers Side of Axle All models with factory frame bracket. Kit 143168 required to install to linkage.	
F	71	VAN 1 TON, A / B SERIES / RAM All Single System Steering Stabilizer; w/ I-Beam Axle All models with factory frame bracket. Kit 143168 required to install to linkage.	
F	71	VAN 3/4 TON, A / B SERIES / RAM All Single System Steering Stabilizer; w/ I-Beam Axle All models with factory frame bracket. Kit 143168 required to install to linkage.	
F	92-97	FORD PICKUP 1 TON, F-350 / SUPERDUTY RWD Dual System Steering Stabilizer All models with factory frame bracket. Kit 143168 required to install to linkage.	

Numerical listing

Shock	POP	Alternative No.	MTG Acc. Supplied
Pos.	Year	Application	

6802SE A (cont) 141998			
F	89-91	PICKUP 1 TON, F-350 / SUPERDUTY RWD Single System Steering Stabilizer All models with factory frame bracket. Kit 143168 required to install to linkage.	
F	82-88	PICKUP 1 TON, F-350 / SUPERDUTY RWD Single System Steering Stabilizer; Exc. Anti-Sway Bar All models with factory frame bracket. Kit 143168 required to install to linkage.	
F	79-81	PICKUP 1 TON, F-350 / SUPERDUTY RWD Dual System Steering Stabilizer All models with factory frame bracket. Kit 143168 required to install to linkage.	
F	75-78	PICKUP 1 TON, F-350 / SUPERDUTY All Dual System Steering Stabilizer All models with factory frame bracket. Kit 143168 required to install to linkage.	
F	65-74	PICKUP 1 TON, F-350 / SUPERDUTY All Single System Steering Stabilizer; w/ Twin I Beam Axle All models with factory frame bracket. Kit 143168 required to install to linkage.	
F	60-64	PICKUP 1 TON, F-350 / SUPERDUTY All Single System Steering Stabilizer w/ I Beam Axle All models with factory frame bracket. Kit 143168 required to install to linkage.	
F	80-96	PICKUP 3/4 TON, F-250 / SUPERDUTY 4WD Single System Steering Stabilizer All models with factory frame bracket. Kit 143168 required to install to linkage.	
F	75-79	PICKUP 3/4 TON, F-250 / SUPERDUTY RWD Single System Steering Stabilizer All models with factory frame bracket. Kit 143168 required to install to linkage.	
F	68-73	PICKUP P350 All Single System Steering Stabilizer All models with factory frame bracket. Kit 143168 required to install to linkage.	
F	69-74	VAN 3/4 TON, ECONOLINE / CLUB WAGON / SUPERDUTY All Single System Steering Stabilizer; w/ Twin I-Beam Axle All models with factory frame bracket. Kit 143168 required to install to linkage.	
F	75-86	GMC PICKUP 1 TON, C35/3500 Crew Cab Pickup Single System Steering Stabilizer All models with factory frame bracket. Kit 143168 required to install to linkage.	
F	72-74	PICKUP 1 TON, C35/3500 All Single System Steering Stabilizer All models with factory frame bracket. Kit 143168 required to install to linkage.	
F	67-86	PICKUP 3/4 TON, C25 / C2500 All Single System Steering Stabilizer All models with factory frame bracket. Kit 143168 required to install to linkage.	
F	67-86	PICKUP 3/4 TON, K25 / K2500 All Dual System Steering Stabilizer All models with factory frame bracket. Kit 143168 required to install to linkage.	
F	87-89	PICKUP 3/4 TON, R2500 All Single System Steering Stabilizer All models with factory frame bracket. Kit 143168 required to install to linkage.	
F	87	PICKUP 3/4 TON, V2500 All AN49 All models with factory frame bracket. Kit 143168 required to install to linkage.	
F	71-95	VAN 1 TON, G / SAVANA All Single System Steering Stabilizer All models with factory frame bracket. Kit 143168 required to install to linkage.	
F	70-95	VAN 3/4 TON, G / SAVANA All Single System Steering Stabilizer All models with factory frame bracket. Kit 143168 required to install to linkage.	

Numerical listing

Shock	POP	Alternative No.	MTG Acc. Supplied
Pos.	Year	Application	
6802SE	A (cont)		141998
F	74-75	INTERNATIONAL 200 All Single System Steering Stabilizer All models with factory frame bracket. Kit 143168 required to install to linkage.	
F	68	1200C All Single System Steering Stabilizer; 1/2 Ton, 3/4 Ton & Travelall All models with factory frame bracket. Kit 143168 required to install to linkage.	
F	69-70	1200D All Single System Steering Stabilizer; 1/2 Ton, 3/4 Ton & Travelall All models with factory frame bracket. Kit 143168 required to install to linkage.	
F	71-73	1210 All Single System Steering Stabilizer; 1/2 Ton, 3/4 Ton & Travelall All models with factory frame bracket. Kit 143168 required to install to linkage.	
F	68	1300C All Single System Steering Stabilizer; 1/2 Ton, 3/4 Ton & Travelall All models with factory frame bracket. Kit 143168 required to install to linkage.	
F	69-70	1300D All Single System Steering Stabilizer; 1/2 Ton, 3/4 Ton & Travelall All models with factory frame bracket. Kit 143168 required to install to linkage.	
F	71-73	1310 All Single System Steering Stabilizer; 1/2 Ton, 3/4 Ton & Travelall All models with factory frame bracket. Kit 143168 required to install to linkage.	
F	68-72	M1100 / M1200 All Single System Steering Stabilizer; 1/2 and 3/4 Ton I-Beam Axle All models with factory frame bracket. Kit 143168 required to install to linkage.	
F	69	M1400 All Single System Steering Stabilizer; 1/2 and 3/4 Ton I-Beam Axle All models with factory frame bracket. Kit 143168 required to install to linkage.	
F	75	TRAVELALL RWD Single System Steering Stabilizer All models with factory frame bracket. Kit 143168 required to install to linkage.	
6803SE	C		141998
F	61-72	CHEVROLET PICKUP 3/4 TON, K20 All Single System Steering Stabilizer	
F	01-09	PICKUP 3/4 TON, SILVERADO 2500 HD All 9200# GVW w/o OE Unit - 15059138 15155638	
F	60-89	DODGE PICKUP 1 TON, W300 SERIES All Single System Steering Stabilizer	
F	69-89	PICKUP 3/4 TON, W200 SERIES All Single System Steering Stabilizer	
F	60-67	PICKUP 3/4 TON, W200 SERIES All Single System Steering Stabilizer	
F	71-87	VAN 1 TON, A / B SERIES / RAM All Single System Steering Stabilizer	
F	80-87	VAN 3/4 TON, A / B SERIES / RAM All Single System Steering Stabilizer	
F	78-79	VAN 3/4 TON, A / B SERIES / RAM All Van Charger Special	
F	71-77	VAN 3/4 TON, A / B SERIES / RAM All Single System Steering Stabilizer	
F	75-77	FORD PICKUP 1 TON, F-350 / SUPERDUTY Manual Steering Single System Steering Stabilizer	
F	60-74	PICKUP 1 TON, F-350 / SUPERDUTY All Single System Steering Stabilizer	
F	75-77	PICKUP 3/4 TON, F-250 / SUPERDUTY 4WD, Manual Steering Single System Steering Stabilizer	
F	60-74	PICKUP 3/4 TON, F-250 / SUPERDUTY All Single System Steering Stabilizer	
F	74-79	VAN 3/4 TON, ECONOLINE / CLUB WAGON / SUPERDUTY All QuadraVan Special	
F	67-72	GMC PICKUP 3/4 TON, K25 / K2500 All Single System Steering Stabilizer	
F	75	INTERNATIONAL TRAVELALL 4WD Single System Steering Stabilizer	

Steering Stabilizer, Front Load Carrier

Shock	POP	Alternative No.	MTG Acc. Supplied
Pos.	Year	Application	
6804SE	B		500498,141397
F	77-86	CHEVROLET PICKUP 1 TON, K30 All Single System Steering Stabilizer	
F	73-86	PICKUP 3/4 TON, K20 All Single System Steering Stabilizer	
F	87	PICKUP 3/4 TON, V20 All Single System Steering Stabilizer	
F	94-95	VAN 1 TON, G / EXPRESS All Single System Steering Stabilizer; HD w/ Straight Front Axle & Tilt Hood	
F	85-93	VAN 1 TON, P SERIES All Single System Steering Stabilizer; w/ I-Beam Front Suspension	
F	94-97	DODGE PICKUP 1 TON, RAM 3500 (SEE RAM 3500) 4WD With OEM 52038276	
F	94-97	PICKUP 1 TON, RAM 3500 (SEE RAM 3500) RWD w/ OEM 52038276 Solid Front Axle	
F	94-97	PICKUP 3/4 TON, RAM 2500 (SEE RAM 2500) 4WD With OEM 52038276	
F	73-86	GMC PICKUP 3/4 TON, K25 / K2500 All Single System Steering Stabilizer	
F	87	PICKUP 3/4 TON, V2500 All Single System Steering Stabilizer	
F	94-95	VAN 1 TON, G / SAVANA All Single System Steering Stabilizer; HD w/ Straight Front Axle & Tilt Hood	
6828SE	C		142718
F	00-02	FORD E-450 ECONOLINE SUPER DUTY All Single System Steering Stabilizer	
F	02	E-550 ECONOLINE SUPER DUTY All Single System Steering Stabilizer	
F	03	E-550 SUPER DUTY All Single System Steering Stabilizer	
F	96-99	ECONOLINE SUPER DUTY All Single System Steering Stabilizer	
F	99-10	PICKUP 1 TON, F-350 / SUPERDUTY RWD Single System Steering Stabilizer	
F	92-97	PICKUP 1 TON, F-350 / SUPERDUTY RWD Single System Steering Stabilizer	
F	99-10	PICKUP 3/4 TON, F-250 / SUPERDUTY RWD Single System Steering Stabilizer	
F	92-97	PICKUP 3/4 TON, F-250 / SUPERDUTY RWD Single System Steering Stabilizer	
F	21-24	VAN 1 TON, ECONOLINE / CLUB WAGON / SUPERDUTY All Single System Steering Stabilizer	
F	92-19	VAN 1 TON, ECONOLINE / CLUB WAGON / SUPERDUTY All Single System Steering Stabilizer	
F	96-04	VAN 3/4 TON, ECONOLINE / CLUB WAGON / SUPERDUTY All Single System Steering Stabilizer	
6847SE	B		143081
F	00-07	DODGE PICKUP 1 TON, RAM 3500 (SEE RAM 3500) 4WD With OEM # 52106909AB, AC, AD	
F	00-07	PICKUP 1 TON, RAM 3500 (SEE RAM 3500) RWD With OEM # 52106909AB, AC, AD and Solid Front Axle	
F	00-07	PICKUP 3/4 TON, RAM 2500 (SEE RAM 2500) 4WD With OEM # 52106909AB, AC, AD	
6850SE	D		143168
F	99-04	FORD PICKUP 1 TON, F-350 / SUPERDUTY 4WD Exc. OE Unit	
F	99-04	PICKUP 3/4 TON, F-250 / SUPERDUTY 4WD Exc. OE Unit	
6853SE	B		143155
F	95-00	CHEVROLET PICKUP 1 TON, K35 / K3500 All Exc. OE Unit	
F	92-99	PICKUP 3/4 TON, C25 / C2500 All Exc. OE Unit	
F	99-00	PICKUP 3/4 TON, K25 / K2500 All Exc. OE Unit	
F	01-09	PICKUP 3/4 TON, SILVERADO 2500 HD 4WD 9200# GVW w/ OE Unit - 15059138 15155638	
F	99-00	GMC PICKUP 3/4 TON, K25 / K2500 4WD 9200# GVW w/ OE Unit - 15059138 15155638	

Numerical listing

Shock	POP	Alternative No.	MTG Acc. Supplied
Pos.	Year	Application	
6853SE	B (cont)		143155
F	99-04	SIERRA 2500 4WD Single System Steering Stabilizer; Up through 8600# GVW; Exc. OE Steering Stabilizer	
F	01-09	SIERRA 2500 HD 4WD 9200# GVW w/ OE Unit - 15059138 15155638	
6854SE	C		142718
F	00-05	FORD EXCURSION 4WD With OE Unit	
F	99-03	PICKUP 1 TON, F-350 / SUPERDUTY 4WD With OE Unit	
F	99-03	PICKUP 3/4 TON, F-250 / SUPERDUTY 4WD With OE Unit	
F	99-04	PICKUP, F-450 SUPERDUTY 4 X 4 Single System Steering Stabilizer	
F	99-04	PICKUP, F-550 SUPERDUTY 4 X 4 Single System Steering Stabilizer	
6855SE	D		143154
F	99-04	FORD PICKUP 1 TON, F-350 / SUPERDUTY 4WD Replacement Kit	
F	99-04	PICKUP 3/4 TON, F-250 / SUPERDUTY 4WD Replacement Kit	
6856SE	D		143156,143077
F	05-07	FORD PICKUP 3/4 TON, F-250 / SUPERDUTY 4WD Exc. OE Unit	
6861SE	D		143160
F	97-99	FORD PICKUP 3/4 TON, F-250 / SUPERDUTY 4WD, Torsion Bar (FrontSpringType) Single System Steering Stabilizer	
Front Load Carrier			
34036	B		140357
F	75-86	CHEVROLET PICKUP 1 TON, C30 All	
F	88-91	PICKUP 1 TON, C35/3500 Cab & Chassis Exc. HD Solid Front Axle	
F	87-88	PICKUP 1 TON, R30 All	
F	89	PICKUP 1 TON, R3500 Standard Cab Pickup	
F	75-86	PICKUP 3/4 TON, C20 Crew Cab Pickup	
F	75-86	PICKUP 3/4 TON, C20 Standard Cab Pickup	
F	63-74	PICKUP 3/4 TON, C20 All	
F	87-88	PICKUP 3/4 TON, R20 Crew Cab Pickup	
F	89	PICKUP 3/4 TON, R2500 All	
F	73-90	VAN 1 TON, P SERIES All Cutaway Chassis	
F	68-72	VAN 1 TON, P SERIES All	
F	68-89	VAN 3/4 TON, P SERIES All	
F	88-91	GMC PICKUP 1 TON, C35/3500 Cab & Chassis HD Solid Front Axle	
F	67-78	PICKUP 1 TON, C35/3500 All	
F	87-91	PICKUP 1 TON, R3500 All	
F	75-86	PICKUP 3/4 TON, C25 / C2500 Cab & Chassis	
F	75-86	PICKUP 3/4 TON, C25 / C2500 Crew Cab Pickup	
F	75-86	PICKUP 3/4 TON, C25 / C2500 Standard Cab Pickup	
F	67-74	PICKUP 3/4 TON, C25 / C2500 All	
F	87-89	PICKUP 3/4 TON, R2500 All Exc. Crew Cab & Bonus Cab	
F	74-90	VAN 1 TON, P SERIES All Cutaway Chassis	
F	73	VAN 1 TON, P SERIES Base Cutaway Chassis	
F	68-72	VAN 1 TON, P SERIES All	
F	68-89	VAN 3/4 TON, P SERIES All	
34052	A		140126
F	72-93	DODGE PICKUP 3/4 TON, D200 SERIES All Exc. Heavy Duty Package	
F	95-03	VAN 1 TON, A / B SERIES / RAM All	
F	71-94	VAN 1 TON, A / B SERIES / RAM All Exc. 4000# Front Axle	
F	71-03	VAN 3/4 TON, A / B SERIES / RAM All	
F	78-80	VAN, CB300 All Exc. 4000# Front Axle	
F	74-77	VAN, CB300 All Up through 8300# GVW	
F	74-83	PLYMOUTH VAN 1 TON, PB SERIES All Exc. 4000# Front Axle	
F	74-83	VAN 3/4 TON, PB SERIES All	

Numerical listing

Shock	POP	Alternative No.	MTG Acc. Supplied
Pos.	Year	Application	
34058	B		140780
F	73-79	FORD PICKUP 1 TON, F-350 / SUPERDUTY All Quad Suspension Rearward of Front Axle	
F	70-79	PICKUP 3/4 TON, F-250 / SUPERDUTY All Quad Suspension Rearward of Front Axle	
F	77-91	VAN 1 TON, ECONOLINE / CLUB WAGON / SUPERDUTY All RWD, 4WD Quad Suspension Rearward of Front Axle	
F	75-91	VAN 1 TON, ECONOLINE / CLUB WAGON / SUPERDUTY All Exc. Cutaway Chassis RWD, 4WD Quad Suspension Rearward of Front Axle	
F	75-91	VAN 3/4 TON, ECONOLINE / CLUB WAGON / SUPERDUTY All RWD, 4WD Quad Suspension Rearward of Front Axle	
34073	A		141041
F	92-00	CHEVROLET PICKUP 1 TON, C35/3500 All Exc. Straight Front Axle	
F	88-91	PICKUP 1 TON, C35/3500 Extended Cab Pickup Exc. Straight Front Axle	
F	88-91	PICKUP 1 TON, C35/3500 Standard Cab Pickup Exc. Straight Front Axle	
F	88-00	PICKUP 3/4 TON, C25 / C2500 All	
F	96-02	VAN 1 TON, G / EXPRESS All Exc. 8600# GVW	
F	96-02	VAN 3/4 TON, G / EXPRESS All Exc. 8600# GVW	
F	88-00	GMC PICKUP 1 TON, C35/3500 All	
F	88-00	PICKUP 3/4 TON, C25 / C2500 All	
F	96-02	VAN 1 TON, G / SAVANA All Exc. 8600# GVW	
F	96-02	VAN 3/4 TON, G / SAVANA All Exc. 8600# GVW	
34076	A		140780
F	92-19	FORD VAN 1 TON, ECONOLINE / CLUB WAGON / SUPERDUTY All	
F	92-14	VAN 3/4 TON, ECONOLINE / CLUB WAGON / SUPERDUTY All	
Rear Load Carrier			
43048	A		
R	61-66	FORD PICKUP 1 TON, F-350 / SUPERDUTY All	
R	61-64	PICKUP 3/4 TON, F-250 / SUPERDUTY All	
F	68-76	PICKUP P350 All Up through 8000# GVW	
F	75-76	PICKUP P400 All Up through 8000# GVW	
F	68	INTERNATIONAL 1200C All Exc. 166" Wheelbase	
R	68	1200C All Exc. 166" Wheelbase	
F	68	1300C All Exc. 166" Wheelbase	
R	68	1300C All Exc. 166" Wheelbase	
R	68-72	M1100 / M1200 All	
R	69	M1400 All	
43058	B		140739
R	75-79	FORD PICKUP 1 TON, F-350 / SUPERDUTY Standard Cab Pickup, RWD	
R	73-74	PICKUP 1 TON, F-350 / SUPERDUTY Standard Cab Pickup RWD	
R	75-79	PICKUP 3/4 TON, F-250 / SUPERDUTY Cab & Chassis, RWD	
R	75-79	PICKUP 3/4 TON, F-250 / SUPERDUTY Extended Cab Pickup, RWD	
R	73-74	PICKUP 3/4 TON, F-250 / SUPERDUTY RWD	
R	65-72	PICKUP 3/4 TON, F-250 / SUPERDUTY All RWD	
R	69-74	VAN 1 TON, ECONOLINE / CLUB WAGON / SUPERDUTY All	
R	69-74	VAN 3/4 TON, ECONOLINE / CLUB WAGON / SUPERDUTY All	
43085	C		140724
R	71-03	DODGE VAN 1 TON, A / B SERIES / RAM All	
R	71-03	VAN 3/4 TON, A / B SERIES / RAM All	
R	74-80	VAN, CB300 All	
R	74-83	PLYMOUTH VAN 1 TON, PB SERIES All	
R	74-83	VAN 3/4 TON, PB SERIES All	

Front Load Carrier, Rear Load Carrier, HiJackers

Shock	POP	Alternative No.	MTG Acc. Supplied
Pos.	Year	Application	
43099	A		140126
R	75-79	FORD PICKUP 1 TON, F-350 / SUPERDUTY Cab & Chassis, RWD	
R	75-79	PICKUP 1 TON, F-350 / SUPERDUTY Extended Cab Pickup, RWD	
R	74	PICKUP 1 TON, F-350 / SUPERDUTY RWD Supercab	
R	75-79	PICKUP 3/4 TON, F-250 / SUPERDUTY Standard Cab Pickup, RWD	
R	73-74	PICKUP 3/4 TON, F-250 / SUPERDUTY RWD Standard Cab Pickup	
R	70-72	PICKUP 3/4 TON, F-250 / SUPERDUTY All RWD; Standard Cab Pickup	
43111	B		140702
R	75-86	CHEVROLET PICKUP 3/4 TON, C20 Standard Cab Pickup	
R	73-74	PICKUP 3/4 TON, C20 All Standard Cab Pickup	
R	73-86	PICKUP 3/4 TON, K20 All Exc. Lift Kit	
R	87	PICKUP 3/4 TON, R20 Standard Cab Pickup	
R	87	PICKUP 3/4 TON, V20 All Exc. Quad Suspension and Lift Kit	
R	73-78	VAN 3/4 TON, P SERIES All	
R	75-86	GMC PICKUP 3/4 TON, C25 / C2500 Cab & Chassis	
R	75-86	PICKUP 3/4 TON, C25 / C2500 Standard Cab Pickup	
R	73-74	PICKUP 3/4 TON, C25 / C2500 All	
R	73-86	PICKUP 3/4 TON, K25 / K2500 All Exc. Lift Kit	
R	88-89	PICKUP 3/4 TON, R2500 All Exc. Crew Cab & Bonus Cab	
R	87	PICKUP 3/4 TON, R2500 Cab & Chassis Exc. Crew Cab & Bonus Cab	
R	87	PICKUP 3/4 TON, R2500 Standard Cab Pickup Exc. Crew Cab & Bonus Cab	
R	87	PICKUP 3/4 TON, V2500 All Exc. Lift Kit	
R	73-78	VAN 3/4 TON, P SERIES All	
43140	A		141150
R	61-62	CHEVROLET VAN 1 TON, P SERIES All	
R	61-62	VAN 3/4 TON, P SERIES All	
43163	A		
R	91-02	CHEVROLET C3500HD All Solid Front Axle	
R	88-90	PICKUP 1 TON, C35/3500 Extended Cab Pickup Exc. HD Straight Front Axle	
R	88-90	PICKUP 1 TON, C35/3500 Standard Cab Pickup Exc. HD Straight Front Axle	
R	88-00	PICKUP 1 TON, K35 / K3500 All	
R	88-00	PICKUP 3/4 TON, C25 / C2500 All	
R	88-00	PICKUP 3/4 TON, K25 / K2500 All	
R	91-02	GMC C3500HD All HD Solid Front Axle	
R	91-00	PICKUP 1 TON, C35/3500 All HD Solid Front Axle	
R	88-90	PICKUP 1 TON, C35/3500 Extended Cab Pickup Exc. HD Straight Front Axle	
R	88-90	PICKUP 1 TON, C35/3500 Standard Cab Pickup Exc. HD Straight Front Axle	
R	88-00	PICKUP 1 TON, K35 / K3500 All	
R	88-00	PICKUP 3/4 TON, C25 / C2500 All	
R	88-00	PICKUP 3/4 TON, K25 / K2500 All	
43167	A		
R	97	FORD F-250 HD RWD	
R	80-97	PICKUP 1 TON, F-350 / SUPERDUTY RWD Exc. Dual Rear Wheels	
R	97	PICKUP 3/4 TON, F-250 / SUPERDUTY RWD Over 8500# GVW	
R	80-96	PICKUP 3/4 TON, F-250 / SUPERDUTY RWD	
R	97	PICKUP, F-450 SUPERDUTY All	
43180	A		
R	96-23	CHEVROLET VAN 1 TON, G / EXPRESS All	
R	03-23	VAN 3/4 TON, G / EXPRESS All	

Numerical listing

Shock	POP	Alternative No.	MTG Acc. Supplied
Pos.	Year	Application	
43180	A (cont)		
R	96-02	VAN 3/4 TON, G / EXPRESS All Exc. 8600# GVW	
R	96-23	GMC VAN 1 TON, G / SAVANA All	
R	03-23	VAN 3/4 TON, G / SAVANA All	
R	96-02	VAN 3/4 TON, G / SAVANA All Exc. 8600# GVW	
43181	A		
R	11-23	CHEVROLET PICKUP 1 TON, SILVERADO 3500 HD All	
R	11-23	PICKUP 3/4 TON, SILVERADO 2500 HD All	
R	94-02	DODGE PICKUP 1 TON, RAM 3500 (SEE RAM 3500) RWD Exc. Solid Front Axle	
R	11-23	GMC SIERRA 2500 HD All	
R	11-23	SIERRA 3500 HD All	
R	14-20	RAM 3500 (SEE DODGE RAM 3500) 4WD	
HiJackers			
49107	C		141099
R	67-72	CHEVROLET PICKUP 3/4 TON, C20 All Coil(RearSpringType)	
R	67-72	GMC PICKUP 3/4 TON, C25 / C2500 All Coil(RearSpringType)	
49127	C		140739,141137,141099
R	75-79	FORD PICKUP 1 TON, F-350 / SUPERDUTY Standard Cab Pickup, RWD	
R	73-74	PICKUP 1 TON, F-350 / SUPERDUTY Standard Cab Pickup RWD	
R	75-79	PICKUP 3/4 TON, F-250 / SUPERDUTY Cab & Chassis, RWD	
R	75-79	PICKUP 3/4 TON, F-250 / SUPERDUTY Extended Cab Pickup, RWD	
R	65-69	PICKUP 3/4 TON, F-250 / SUPERDUTY All Supercab	
R	69-74	VAN 1 TON, ECONOLINE / CLUB WAGON / SUPERDUTY All	
R	69-74	VAN 3/4 TON, ECONOLINE / CLUB WAGON / SUPERDUTY All	
49149	C		141099
R	72-93	DODGE PICKUP 1 TON, D300 SERIES All	
R	82-93	PICKUP 3/4 TON, D200 SERIES All	
R	81	PICKUP 3/4 TON, D200 SERIES All Exc. Heavy Duty Package	
R	72-80	PICKUP 3/4 TON, D200 SERIES All	
49155	B		140702,141099
R	75-86	CHEVROLET PICKUP 3/4 TON, C20 Standard Cab Pickup	
R	73-74	PICKUP 3/4 TON, C20 All Standard Cab Pickup	
R	81-86	PICKUP 3/4 TON, K20 All Standard Suspension; Exc. Lift Kit	
R	73-80	PICKUP 3/4 TON, K20 All Exc. Lift Kit	
R	87	PICKUP 3/4 TON, R20 Standard Cab Pickup	
R	87	PICKUP 3/4 TON, V20 All	
R	73-78	VAN 3/4 TON, P SERIES All	
R	75-86	GMC PICKUP 3/4 TON, C25 / C2500 Cab & Chassis	
R	75-86	PICKUP 3/4 TON, C25 / C2500 Standard Cab Pickup	
R	73-74	PICKUP 3/4 TON, C25 / C2500 All	
R	73-86	PICKUP 3/4 TON, K25 / K2500 All Exc. Quad Suspension and Lift Kit	
R	88-89	PICKUP 3/4 TON, R2500 All Exc. Crew Cab & Bonus Cab	
R	87	PICKUP 3/4 TON, R2500 Cab & Chassis Exc. Crew Cab & Bonus Cab	
R	87	PICKUP 3/4 TON, R2500 Standard Cab Pickup Exc. Crew Cab & Bonus Cab	
R	87	PICKUP 3/4 TON, V2500 All Exc. Lift Kit	
R	73-78	VAN 3/4 TON, P SERIES All	
49162	D		141058,141099
R	67-72	CHEVROLET PICKUP 3/4 TON, C20 All Leaf(RearSpringType)	
R	63-66	PICKUP 3/4 TON, C20 All	
R	76-77	VAN 1 TON, G / EXPRESS All	
R	75	VAN 1 TON, G / EXPRESS 110.0 / 279.4 (WheelBase)	

Numerical listing

HiJackers, Ultra Struts, Ultra ReadyMount, LTV Severe Duty

Numerical listing

Shock	POP	Alternative No.	MTG Acc. Supplied
Pos.	Year	Application	
49162	D (cont)	141058,141099	
R 75	VAN 1 TON, G / EXPRESS 125.0 / 317.5 (WheelBase)		
R 71-74	VAN 1 TON, G / EXPRESS All		
R 68-72	VAN 1 TON, P SERIES All Exc. 11,000# Rear Axle		
R 67-77	VAN 3/4 TON, G / EXPRESS All		
R 68-72	VAN 3/4 TON, P SERIES All		
R 67-72	GMC PICKUP 1 TON, C35/3500 All Exc. 11,000# Rear Axle		
R 67-72	PICKUP 3/4 TON, C25 / C2500 All Leaf(RearSpringType)		
R 76-77	VAN 1 TON, G / SAVANA All		
R 75	VAN 1 TON, G / SAVANA 110.0 / 279.4 (WheelBase)		
R 75	VAN 1 TON, G / SAVANA 125.0 / 317.5 (WheelBase)		
R 71-74	VAN 1 TON, G / SAVANA All Exc. 146" Wheelbase		
R 68-72	VAN 1 TON, P SERIES All Exc. 11,000# Rear Axle		
R 67-77	VAN 3/4 TON, G / SAVANA All		
R 68-72	VAN 3/4 TON, P SERIES All		
49173	C	140126,141099	
R 75-79	FORD PICKUP 1 TON, F-350 / SUPERDUTY Cab & Chassis, RWD		
R 75-79	PICKUP 1 TON, F-350 / SUPERDUTY Extended Cab Pickup, RWD		
R 74	PICKUP 1 TON, F-350 / SUPERDUTY RWD Extended Cab & Chassis Cab		
R 75-79	PICKUP 3/4 TON, F-250 / SUPERDUTY Standard Cab Pickup, RWD		
R 71-74	PICKUP 3/4 TON, F-250 / SUPERDUTY All RWD; Exc. Extended Cab & Chassis Cab		
49178	B	140126,141099	
R 79	FORD PICKUP 1 TON, F-350 / SUPERDUTY 4WD		
R 77-79	PICKUP 3/4 TON, F-250 / SUPERDUTY Cab & Chassis, 4WD All From Serial No. Y20001		
R 77-79	PICKUP 3/4 TON, F-250 / SUPERDUTY Standard Cab Pickup, 4WD All From Serial No. Y20001		
R 21-24	VAN 1 TON, ECONOLINE / CLUB WAGON / SUPERDUTY All		
R 77-19	VAN 1 TON, ECONOLINE / CLUB WAGON / SUPERDUTY All		
R 07	VAN 1 TON, ECONOLINE / CLUB WAGON / SUPERDUTY All Exc. Cutaway Chassis		
R 75-91	VAN 1 TON, ECONOLINE / CLUB WAGON / SUPERDUTY All Exc. Cutaway Chassis		
R 75-14	VAN 3/4 TON, ECONOLINE / CLUB WAGON / SUPERDUTY All		
49212	C	141099	
R 78-95	CHEVROLET VAN 1 TON, G / EXPRESS Cutaway Van		
R 78-95	VAN 3/4 TON, G / EXPRESS All Exc. 8600# GVW		
R 71-03	DODGE VAN 1 TON, A / B SERIES / RAM All		
R 71-03	VAN 3/4 TON, A / B SERIES / RAM All		
R 78-80	VAN, CB300 All		
R 77	VAN, CB300 All Over 8300# GVW		
R 75-76	VAN, CB300 All		
R 74	VAN, CB300 All Over 8300# GVW		
R 85-95	GMC VAN 1 TON, G / SAVANA Extended Cargo Van		
R 85-95	VAN 1 TON, G / SAVANA Extended Passenger Van		
R 79-95	VAN 1 TON, G / SAVANA Standard Cargo Van		
R 79-95	VAN 1 TON, G / SAVANA Standard Passenger Van		
R 78	VAN 1 TON, G / SAVANA Cutaway Van		
R 78-95	VAN 3/4 TON, G / SAVANA All Exc. 8600# GVW		
R 74-83	PLYMOUTH VAN 1 TON, PB SERIES All		
R 74-83	VAN 3/4 TON, PB SERIES All		
49218	C	141099	
R 91-00	CHEVROLET PICKUP 1 TON, C35/3500 All		
R 88-90	PICKUP 1 TON, C35/3500 Extended Cab Pickup		

Shock	POP	Alternative No.	MTG Acc. Supplied
Pos.	Year	Application	
49218	C (cont)	141099	
R 88-90	PICKUP 1 TON, C35/3500 Standard Cab Pickup		
R 88-00	PICKUP 1 TON, K35 / K3500 All		
R 88-00	PICKUP 3/4 TON, C25 / C2500 All		
R 88-00	PICKUP 3/4 TON, K25 / K2500 All		
R 92-00	GMC PICKUP 1 TON, C35/3500 Cab & Chassis Exc. HD Straight Front Axle		
R 88-91	PICKUP 1 TON, C35/3500 All Exc. HD Straight Front Axle		
R 88-00	PICKUP 1 TON, K35 / K3500 All		
R 88-00	PICKUP 3/4 TON, C25 / C2500 All		
R 88-00	PICKUP 3/4 TON, K25 / K2500 All		
49231	B	141099	
R 96-02	CHEVROLET VAN 1 TON, G / EXPRESS All		
R 96-02	VAN 3/4 TON, G / EXPRESS All Exc. 8600# GVW		
R 96-02	GMC VAN 1 TON, G / SAVANA All		
R 96-02	VAN 3/4 TON, G / SAVANA All Exc. 8600# GVW		
49235	A	141099	
R 94-02	DODGE PICKUP 1 TON, RAM 3500 (SEE RAM 3500) RWD Exc. Solid Front Axle		
R 94-02	PICKUP 3/4 TON, RAM 2500 (SEE RAM 2500) All Exc. 8800# GVW		
49237	C	142700,141099	
R 97-99	FORD PICKUP 3/4 TON, F-250 / SUPERDUTY RWD Up through 8500# GVW		
49310	C	140788,141099	
R 68	INTERNATIONAL 1200C All Exc. 166" Wheelbase		
R 68	1300C All Exc. 166" Wheelbase		
R 68-72	M1100 / M1200 All		
R 69	M1400 All		
Ultra Struts			
G51856	A		
F 16-18	RAM 1500 (SEE DODGE RAM 1500) 4WD Exc. Air Suspension		
F 11-15	1500 (SEE DODGE RAM 1500) 4WD		
F 19-20	1500 CLASSIC 4WD Old Body Style		
G56778	C	143172	
F 03-06	DODGE SPRINTER 2500 All		
F 03-06	SPRINTER 3500 All		
F 02-06	FREIGHTLINER SPRINTER 2500 All		
Ultra ReadyMount			
G57147	A		
F 16-18	RAM 1500 (SEE DODGE RAM 1500) 4WD Exc. Air Suspension		
F 11-15	1500 (SEE DODGE RAM 1500) 4WD		
F 19-20	1500 CLASSIC 4WD Old Body Style		
G57800	A		
F 14-22	RAM PROMASTER 1500 All Left		
F 14-22	PROMASTER 2500 All Left		
F 14-22	PROMASTER 3500 All Left		
G57801	A		
F 14-22	RAM PROMASTER 1500 All Right		
F 14-22	PROMASTER 2500 All Right		
F 14-22	PROMASTER 3500 All Right		
G57802	C		
F 07-09	DODGE SPRINTER 2500 All		
F 07-09	SPRINTER 3500 All		
F 07-18	FREIGHTLINER SPRINTER 2500 All		
F 07-18	SPRINTER 3500 All		
F 10-18	MERCEDES-BENZ SPRINTER 2500 All		
F 10-18	SPRINTER 3500 All		
G57816	C		
F 15-22	FORD TRANSIT-150 All		
F 15-22	TRANSIT-250 All		
F 15-22	TRANSIT-350 All		
LTV Severe Duty			
58357	D		
F 78-96	CHEVROLET VAN 1 TON, G / EXPRESS All		

Shock	POP	Alternative No.	MTG Acc. Supplied
Pos.	Year	Application	
58357	D (cont)		
F 96	VAN 1 TON, G / EXPRESS Cutaway Van		
F 75	VAN 1 TON, G / EXPRESS 146.0 / 370.8 (WheelBase)		
F 71-74	VAN 1 TON, G / EXPRESS All		
F 78-95	VAN 3/4 TON, G / EXPRESS All Exc. 8600# GVW		
F 70-77	VAN 3/4 TON, G / EXPRESS All		
F 76-96	GMC VAN 1 TON, G / SAVANA All		
F 75	VAN 1 TON, G / SAVANA 110.0 / 279.4 (WheelBase)		
F 75	VAN 1 TON, G / SAVANA 125.0 / 317.5 (WheelBase)		
F 71-74	VAN 1 TON, G / SAVANA All		
F 78-95	VAN 3/4 TON, G / SAVANA All Exc. 8600# GVW		
F 71-77	VAN 3/4 TON, G / SAVANA All		
F 70	VAN 3/4 TON, G / SAVANA All Independent Front Suspension		
58359	C	140126	
F 72-93	DODGE PICKUP 3/4 TON, D200 SERIES All Exc. Heavy Duty Package		
F 95-03	VAN 1 TON, A / B SERIES / RAM All		
F 71-94	VAN 1 TON, A / B SERIES / RAM All Exc. 4000# Front Axle		
F 71-03	VAN 3/4 TON, A / B SERIES / RAM All		
F 78-80	VAN, CB300 All Exc. 4000# Front Axle		
F 74-77	VAN, CB300 All Up through 8300# GVW		
F 74-83	PLYMOUTH VAN 1 TON, PB SERIES All Exc. 4000# Front Axle		
F 74-83	VAN 3/4 TON, PB SERIES All		
58403	D		
R 79-95	CHEVROLET VAN 1 TON, G / EXPRESS Cutaway Van		
F 85	VAN 1 TON, P SERIES All Motorhome Chassis w/ I-Beam Front Suspension		
R 79-95	GMC VAN 1 TON, G / SAVANA Cutaway Van		
F 85	VAN 1 TON, P SERIES All Motorhome Chassis w/ I-Beam Front Suspension		
58412	A		
R 77-86	CHEVROLET PICKUP 1 TON, K30 All		
R 90-91	PICKUP 1 TON, R3500 All		
R 89	PICKUP 1 TON, R3500 Cab & Chassis		
R 89	PICKUP 1 TON, R3500 Crew Cab Pickup		
R 01-09	PICKUP 1 TON, SILVERADO 3500 All		
R 07-10	PICKUP 1 TON, SILVERADO 3500 HD All		
R 87-88	PICKUP 1 TON, V30 All		
R 89-91	PICKUP 1 TON, V3000 / V3500 All		
R 99-08	PICKUP 3/4 TON, SILVERADO 2500 All		
R 01-10	PICKUP 3/4 TON, SILVERADO 2500 HD All		
R 07	SILVERADO 2500 HD CLASSIC All		
R 07	SILVERADO 3500 CLASSIC All		
R 77-86	GMC PICKUP 1 TON, K35 / K3500 All		
R 87-91	PICKUP 1 TON, V3000 / V3500 All		
R 99-04	SIERRA 2500 All		
R 01-10	SIERRA 2500 HD All		
R 07	SIERRA 2500 HD CLASSIC All		
R 01-06	SIERRA 3500 All		
R 07	SIERRA 3500 CLASSIC All		
R 07-10	SIERRA 3500 HD All		
R 11-18	RAM 1500 (SEE DODGE RAM 1500) All		
R 19-22	1500 CLASSIC All Old Body Style		
58488	C		
R 91-02	CHEVROLET C3500HD All Solid Front Axle		
R 88-90	PICKUP 1 TON, C35/3500 Extended Cab Pickup Exc. HD Straight Front Axle		
R 88-90	PICKUP 1 TON, C35/3500 Standard Cab Pickup Exc. HD Straight Front Axle		
R 88-00	PICKUP 1 TON, K35 / K3500 All		
R 88-00	PICKUP 3/4 TON, C25 / C2500 All		
R 88-00	PICKUP 3/4 TON, K25 / K2500 All		
R 91-02	GMC C3500HD All Solid Front Axle		

Numerical listing

Shock	POP	Alternative No.	MTG Acc. Supplied
Pos.	Year	Application	
58488	C (cont)		142731
R	98-99	PICKUP 1 TON, C35/3500 Cab & Chassis HD Solid Front Axle	
R	88-97	PICKUP 1 TON, C35/3500 All HD Solid Front Axle	
R	88-00	PICKUP 1 TON, K35 / K3500 All	
R	88-00	PICKUP 3/4 TON, C25 / C2500 All	
R	88-00	PICKUP 3/4 TON, K25 / K2500 All	
58489	B		141537
F	92-00	CHEVROLET PICKUP 1 TON, C35/3500 Crew Cab Pickup Exc. HD Straight Front Axle	
F	88-00	PICKUP 1 TON, C35/3500 Extended Cab Pickup Exc. HD Straight Front Axle	
F	88-00	PICKUP 1 TON, C35/3500 Standard Cab Pickup Exc. HD Straight Front Axle	
F	88-00	PICKUP 3/4 TON, C25 / C2500 All	
F	92-00	GMC PICKUP 1 TON, C35/3500 Crew Cab Pickup Exc. HD Straight Front Axle	
F	88-00	PICKUP 1 TON, C35/3500 Extended Cab Pickup Exc. HD Straight Front Axle	
F	88-00	PICKUP 1 TON, C35/3500 Standard Cab Pickup Exc. HD Straight Front Axle	
F	88-00	PICKUP 3/4 TON, C25 / C2500 All	
58609	B		140780
F	88-00	CHEVROLET PICKUP 1 TON, K35 / K3500 All	
F	88-00	PICKUP 3/4 TON, K25 / K2500 All	
F	88-00	GMC PICKUP 1 TON, K35 / K3500 All	
F	88-00	PICKUP 3/4 TON, K25 / K2500 All	
58622	C		142617
F	00-02	FORD E-450 ECONOLINE SUPER DUTY All	
F	21-24	VAN 1 TON, ECONOLINE / CLUB WAGON / SUPERDUTY All	
F	99-19	VAN 1 TON, ECONOLINE / CLUB WAGON / SUPERDUTY All	
F	04-11	VAN 1 TON, ECONOLINE / CLUB WAGON / SUPERDUTY All Exc. Cutaway Chassis	
F	07-08	VAN 1 TON, ECONOLINE / CLUB WAGON / SUPERDUTY All Cutaway Chassis	
F	92-05	VAN 1 TON, ECONOLINE / CLUB WAGON / SUPERDUTY All Cutaway Chassis	
F	92-14	VAN 3/4 TON, ECONOLINE / CLUB WAGON / SUPERDUTY All	
58623	C		142617
R	00-02	FORD E-450 ECONOLINE SUPER DUTY All	
R	21-24	VAN 1 TON, ECONOLINE / CLUB WAGON / SUPERDUTY All	
R	04-19	VAN 1 TON, ECONOLINE / CLUB WAGON / SUPERDUTY All Exc. Cutaway Chassis	
R	99-19	VAN 1 TON, ECONOLINE / CLUB WAGON / SUPERDUTY All	
R	07-08	VAN 1 TON, ECONOLINE / CLUB WAGON / SUPERDUTY All Cutaway Chassis	
R	92-05	VAN 1 TON, ECONOLINE / CLUB WAGON / SUPERDUTY All Cutaway Chassis	
R	92-14	VAN 3/4 TON, ECONOLINE / CLUB WAGON / SUPERDUTY All	
58638	C		
R	09-22	CHEVROLET EXPRESS 4500 All	
R	10-12	VAN 1 TON, G / EXPRESS All	
R	03-06	VAN 1 TON, G / EXPRESS All	
R	07-09	VAN 3/4 TON, G / EXPRESS All	
R	96-02	VAN 3/4 TON, G / EXPRESS All Exc. 8600# GVW	
R	96-02	GMC VAN 1 TON, G / SAVANA All Exc. 8600# GVW	
R	96-02	VAN 3/4 TON, G / SAVANA All Exc. 8600# GVW	
58662	D		
R	94-02	DODGE PICKUP 1 TON, RAM 3500 (SEE RAM 3500) RWD Exc. Solid Front Axle	
R	94-02	PICKUP 3/4 TON, RAM 2500 (SEE RAM 2500) All Exc. 8800# GVW	

LTV Severe Duty, Ultra Truck Shock

Shock	POP	Alternative No.	MTG Acc. Supplied
Pos.	Year	Application	
58714	C		142731
F	96-99	FORD PICKUP 3/4 TON, F-250 / SUPERDUTY RWD Up through 8500# GVW	
58807	C		142617
F	13-16	FORD PICKUP 1 TON, F-350 / SUPERDUTY All	
F	99-16	PICKUP 1 TON, F-350 / SUPERDUTY RWD	
F	99-22	PICKUP 3/4 TON, F-250 / SUPERDUTY RWD	
58808	C		
R	99-04	FORD PICKUP 1 TON, F-350 / SUPERDUTY RWD	
R	99-04	PICKUP 3/4 TON, F-250 / SUPERDUTY RWD	
58809	B		
F	99-04	FORD PICKUP 1 TON, F-350 / SUPERDUTY 4WD	
F	99-04	PICKUP 3/4 TON, F-250 / SUPERDUTY 4WD	
F	99-04	PICKUP, F-450 SUPERDUTY All	
F	99-04	PICKUP, F-550 SUPERDUTY All	
58810	C		
R	99-04	FORD PICKUP 1 TON, F-350 / SUPERDUTY 4WD	
R	99-04	PICKUP 3/4 TON, F-250 / SUPERDUTY 4WD	
58817	A		141665
F	01-09	CHEVROLET PICKUP 1 TON, SILVERADO 3500 All	
F	07-10	PICKUP 1 TON, SILVERADO 3500 HD All	
F	05-08	PICKUP 3/4 TON, SILVERADO 2500 All	
F	99-04	PICKUP 3/4 TON, SILVERADO 2500 4WD	
F	01-10	PICKUP 3/4 TON, SILVERADO 2500 HD All 9200# GVW	
F	07	SILVERADO 2500 HD CLASSIC All 9200# GVW	
F	07	SILVERADO 3500 CLASSIC All Heavy Duty	
F	99-04	GMC SIERRA 2500 All	
F	01-10	SIERRA 2500 HD All	
F	01-06	SIERRA 3500 All	
F	07	SIERRA 3500 CLASSIC All	
F	07-10	SIERRA 3500 HD Torsion Bar (FrontSpringType)	
58944	D		
F	07-12	FORD PICKUP, F-450 SUPERDUTY All	
F	10-12	PICKUP, F-550 SUPERDUTY All	
Ultra Truck Shock			
G63183	C		
R	74	DODGE M300 All	
F	81-93	PICKUP 1 TON, W300 SERIES All Exc. Quad Suspension and Lift Kit	
F	61-80	PICKUP 1 TON, W300 SERIES All	
R	61-71	PICKUP 1 TON, W300 SERIES All	
F	90-93	PICKUP 3/4 TON, W200 SERIES Extended Cab Pickup Exc. Lift Kit	
F	88-93	PICKUP 3/4 TON, W200 SERIES Cab & Chassis Exc. Lift Kit	
F	81-93	PICKUP 3/4 TON, W200 SERIES Standard Cab Pickup Exc. Lift Kit	
F	86	PICKUP 3/4 TON, W200 SERIES Cab & Chassis Exc. Lift Kit	
F	81-83	PICKUP 3/4 TON, W200 SERIES Cab & Chassis Exc. Lift Kit	
F	81-82	PICKUP 3/4 TON, W200 SERIES Extended Cab Pickup Exc. Lift Kit	
F	69-80	PICKUP 3/4 TON, W200 SERIES All	
F	61-67	PICKUP 3/4 TON, W200 SERIES All	
F	78-80	RD200 All	
G63299	A		140885
R	87-04	MITSUBISHI FUSO FE All Model with O.E.M. Number	
G63306	C		
R	63-72	CHEVROLET PICKUP 3/4 TON, C20 All	
R	76-77	VAN 1 TON, G / EXPRESS All	
R	75	VAN 1 TON, G / EXPRESS 110.0 / 279.4 (WheelBase)	
R	75	VAN 1 TON, G / EXPRESS 125.0 / 317.5 (WheelBase)	
R	71-74	VAN 1 TON, G / EXPRESS All	

Numerical listing

Shock	POP	Alternative No.	MTG Acc. Supplied
Pos.	Year	Application	
G63306	C (cont)		
R	68-72	VAN 1 TON, P SERIES All Exc. 11,000# Rear Axle	
R	67-77	VAN 3/4 TON, G / EXPRESS All	
R	68-72	VAN 3/4 TON, P SERIES All	
R	67-72	GMC PICKUP 1 TON, C35/3500 All Exc. 11,000# Rear Axle	
R	72	PICKUP 3/4 TON, C25 / C2500 All Leaf(RearSpringType)	
R	71	PICKUP 3/4 TON, C25 / C2500 All	
R	67-70	PICKUP 3/4 TON, C25 / C2500 All Leaf(RearSpringType)	
R	76-77	VAN 1 TON, G / SAVANA All	
R	75	VAN 1 TON, G / SAVANA 110.0 / 279.4 (WheelBase)	
R	75	VAN 1 TON, G / SAVANA 125.0 / 317.5 (WheelBase)	
R	71-74	VAN 1 TON, G / SAVANA All	
R	68-72	VAN 1 TON, P SERIES All Exc. 11,000# Rear Axle	
R	67-77	VAN 3/4 TON, G / SAVANA All	
R	68-72	VAN 3/4 TON, P SERIES All	
G63347	B		
F	69-86	CHEVROLET PICKUP 3/4 TON, K20 All Exc. Lift Kit	
F	87	PICKUP 3/4 TON, V20 All Exc. Quad Suspension and Lift Kit	
F	69-86	GMC PICKUP 3/4 TON, K25 / K2500 All Exc. Quad Suspension and Lift Kit	
F	87	PICKUP 3/4 TON, V2500 All Exc. Lift Kit	
G63349	A		140357
R	75-86	CHEVROLET PICKUP 3/4 TON, C20 Standard Cab Pickup	
R	75-86	PICKUP 3/4 TON, K20 All Exc. Lift Kit	
R	87	PICKUP 3/4 TON, R20 Standard Cab Pickup	
R	87	PICKUP 3/4 TON, V20 All Exc. Quad Suspension and Lift Kit	
R	73-78	VAN 3/4 TON, P SERIES All	
R	75-86	GMC PICKUP 3/4 TON, C25 / C2500 Cab & Chassis	
R	75-86	PICKUP 3/4 TON, C25 / C2500 Standard Cab Pickup	
R	73-74	PICKUP 3/4 TON, C25 / C2500 All Exc. Crew Cab & Bonus Cab	
R	73-86	PICKUP 3/4 TON, K25 / K2500 All Exc. Lift Kit	
R	88-89	PICKUP 3/4 TON, R2500 All Exc. Crew Cab & Bonus Cab	
R	87	PICKUP 3/4 TON, R2500 Cab & Chassis Exc. Crew Cab & Bonus Cab	
R	87	PICKUP 3/4 TON, R2500 Standard Cab Pickup Exc. Crew Cab & Bonus Cab	
R	87	PICKUP 3/4 TON, V2500 All Exc. Lift Kit	
R	73-78	VAN 3/4 TON, P SERIES All	
G63350	C		140126
R	75-79	FORD PICKUP 1 TON, F-350 / SUPERDUTY Extended Cab Pickup, RWD	
R	67-74	PICKUP 1 TON, F-350 / SUPERDUTY All Extended Cab	
R	75-79	PICKUP 3/4 TON, F-250 / SUPERDUTY Cab & Chassis, RWD	
R	75-79	PICKUP 3/4 TON, F-250 / SUPERDUTY Standard Cab Pickup, RWD	
R	65-74	PICKUP 3/4 TON, F-250 / SUPERDUTY All Exc. Supercab	
G63353	C		
R	72-93	DODGE PICKUP 1 TON, D300 SERIES All	
R	72-93	PICKUP 3/4 TON, D200 SERIES All	
G63355	A		140702
F	75-86	CHEVROLET PICKUP 1 TON, C30 All	
F	88-91	PICKUP 1 TON, C35/3500 Cab & Chassis Exc. HD Solid Front Axle	
F	87-88	PICKUP 1 TON, R30 All	
F	89	PICKUP 1 TON, R3500 Standard Cab Pickup	
F	63-86	PICKUP 3/4 TON, C20 All	
F	87-88	PICKUP 3/4 TON, R20 All	
F	89	PICKUP 3/4 TON, R2500 All	
F	68-90	VAN 1 TON, P SERIES All Cutaway Chassis	

Numerical listing

Shock	POP	Alternative No.	MTG Acc. Supplied
Pos.	Year	Application	
G63355	A (cont)		140702
F	68-89	VAN 3/4 TON, P SERIES All	
F	88-90	GMC PICKUP 1 TON, C35/3500 Cab & Chassis Exc. HD Solid Front Axle	
F	67-78	PICKUP 1 TON, C35/3500 All	
F	87-91	PICKUP 1 TON, R3500 All	
F	85-86	PICKUP 3/4 TON, C25 / C2500 Crew Cab Pickup	
F	75-86	PICKUP 3/4 TON, C25 / C2500 Cab & Chassis	
F	75-86	PICKUP 3/4 TON, C25 / C2500 Standard Cab Pickup	
F	75-83	PICKUP 3/4 TON, C25 / C2500 Crew Cab Pickup	
F	67-74	PICKUP 3/4 TON, C25 / C2500 All	
F	87-89	PICKUP 3/4 TON, R2500 All Exc. Crew Cab & Bonus Cab	
F	66	PICKUP 2500 SERIES All	
F	75-90	VAN 1 TON, P SERIES All Cutaway Chassis	
F	73-74	VAN 1 TON, P SERIES Base Cutaway Chassis	
F	68-72	VAN 1 TON, P SERIES All	
F	68-89	VAN 3/4 TON, P SERIES All	
G63357	B		
F	76-96	CHEVROLET VAN 1 TON, G / EXPRESS All	
F	75	VAN 1 TON, G / EXPRESS 146.0 / 370.8 (WheelBase)	
F	71-74	VAN 1 TON, G / EXPRESS All	
F	71-95	VAN 3/4 TON, G / EXPRESS All	
F	70	VAN 3/4 TON, G / EXPRESS All Independent Front Suspension	
F	76-95	GMC VAN 1 TON, G / SAVANA All	
F	75	VAN 1 TON, G / SAVANA 146.0 / 370.8 (WheelBase)	
F	71-74	VAN 1 TON, G / SAVANA All	
F	78-95	VAN 3/4 TON, G / SAVANA All Exc. 8600# GVW	
F	71-77	VAN 3/4 TON, G / SAVANA All	
F	70	VAN 3/4 TON, G / SAVANA All Independent Front Suspension	
G63359	B		140126
F	72-93	DODGE PICKUP 3/4 TON, D200 SERIES All Exc. Heavy Duty Package	
F	95-03	VAN 1 TON, A / B SERIES / RAM All	
F	71-94	VAN 1 TON, A / B SERIES / RAM All Exc. 4000# Front Axle	
F	81-03	VAN 3/4 TON, A / B SERIES / RAM All	
F	71-80	VAN 3/4 TON, A / B SERIES / RAM All Exc. 4000# Front Axle	
F	74-80	VAN, CB300 All Exc. 4000# Front Axle	
F	74-83	PLYMOUTH VAN 1 TON, PB SERIES All Exc. 4000# Front Axle	
F	74-83	VAN 3/4 TON, PB SERIES All	
G63360	C		140126
F	72-93	DODGE PICKUP 1 TON, D300 SERIES All Heavy Duty Package	
F	72-93	PICKUP 3/4 TON, D200 SERIES All Heavy Duty Package	
F	71-93	VAN 1 TON, A / B SERIES / RAM All 4000# Front Axle	
F	74-80	VAN, CB300 All 4000# Front Axle	
F	74-83	PLYMOUTH VAN 1 TON, PB SERIES All 4000# Front Axle	
G63366	A		
R	75-86	CHEVROLET PICKUP 1 TON, C30 All	
R	88-91	PICKUP 1 TON, C35/3500 Cab & Chassis Exc. HD Solid Front Axle	
R	87-88	PICKUP 1 TON, R30 All	
R	89	PICKUP 1 TON, R3500 Standard Cab Pickup	
R	75-86	PICKUP 3/4 TON, C20 Crew Cab Pickup	
R	87-88	PICKUP 3/4 TON, R20 Crew Cab Pickup	
R	89	PICKUP 3/4 TON, R2500 All	
R	73-99	VAN 1 TON, P SERIES All	
R	79-89	VAN 3/4 TON, P SERIES All	
R	88-91	GMC PICKUP 1 TON, C35/3500 Cab & Chassis Exc. HD Solid Front Axle	
R	73-78	PICKUP 1 TON, C35/3500 All	
R	87-91	PICKUP 1 TON, R3500 All	
R	85-86	PICKUP 3/4 TON, C25 / C2500 Crew Cab Pickup	

Ultra Truck Shock

Shock	POP	Alternative No.	MTG Acc. Supplied
Pos.	Year	Application	
G63366	A (cont)		
R	75-83	PICKUP 3/4 TON, C25 / C2500 Crew Cab Pickup	
R	73-74	PICKUP 3/4 TON, C25 / C2500 All Crew Cab	
R	87-89	PICKUP 3/4 TON, R2500 Crew Cab Pickup	
R	73-99	VAN 1 TON, P SERIES All	
R	79-89	VAN 3/4 TON, P SERIES All	
G63375	B		140780,142615
F	96-02	CHEVROLET VAN 1 TON, G / EXPRESS All	
F	96-02	VAN 3/4 TON, G / EXPRESS All Exc. 8600# GVW	
F	96-02	GMC VAN 1 TON, G / SAVANA All	
F	96-02	VAN 3/4 TON, G / SAVANA All Exc. 8600# GVW	
G63377	B		141137
R	75-79	FORD PICKUP 1 TON, F-350 / SUPERDUTY Standard Cab Pickup, RWD	
R	73-74	PICKUP 1 TON, F-350 / SUPERDUTY All RWD; Supercab	
R	75-79	PICKUP 3/4 TON, F-250 / SUPERDUTY Extended Cab Pickup, RWD	
R	65-74	PICKUP 3/4 TON, F-250 / SUPERDUTY All RWD; Supercab	
R	69-74	VAN 1 TON, ECONOLINE / CLUB WAGON / SUPERDUTY All	
R	69-74	VAN 3/4 TON, ECONOLINE / CLUB WAGON / SUPERDUTY All	
G63386	B		140780
F	75-79	FORD PICKUP 1 TON, F-350 / SUPERDUTY RWD RWD, 4WD Quad Suspension Rearward of Front Axle, Non Quad Suspension	
F	67-74	PICKUP 1 TON, F-350 / SUPERDUTY All RWD, 4WD Quad Suspension Rearward of Front Axle, Non Quad Suspension	
F	75-79	PICKUP 3/4 TON, F-250 / SUPERDUTY RWD RWD, 4WD Quad Suspension Rearward of Front Axle, Non Quad Suspension	
F	65-74	PICKUP 3/4 TON, F-250 / SUPERDUTY All RWD, 4WD Quad Suspension Rearward of Front Axle, Non Quad Suspension	
F	75-91	VAN 1 TON, ECONOLINE / CLUB WAGON / SUPERDUTY All Cutaway Chassis RWD, 4WD Quad Suspension Rearward of Front Axle, Non Quad Suspension	
F	75-91	VAN 3/4 TON, ECONOLINE / CLUB WAGON / SUPERDUTY All RWD, 4WD Quad Suspension Rearward of Front Axle, Non Quad Suspension	
G63387	C		140126
R	79	FORD PICKUP 1 TON, F-350 / SUPERDUTY 4WD	
R	77-79	PICKUP 3/4 TON, F-250 / SUPERDUTY Cab & Chassis, 4WD All From Serial No. Y20001	
R	77-79	PICKUP 3/4 TON, F-250 / SUPERDUTY Standard Cab Pickup, 4WD All From Serial No. Y20001	
R	75-91	VAN 1 TON, ECONOLINE / CLUB WAGON / SUPERDUTY All Cutaway Chassis	
R	75-91	VAN 3/4 TON, ECONOLINE / CLUB WAGON / SUPERDUTY All	
G63394	C		140702
F	85-99	CHEVROLET VAN 1 TON, P SERIES All Motorhome Chassis w/ Independent Front Suspension	
F	74-84	VAN 1 TON, P SERIES All Motorhome Chassis	
F	85-99	GMC VAN 1 TON, P SERIES All Motorhome Chassis w/ Independent Front Suspension	
F	75-84	VAN 1 TON, P SERIES All Motorhome Chassis	
F	74	VAN 1 TON, P SERIES Motorhome	
G63403	B (cont)		
R	93-96	GMC VAN 1 TON, G / SAVANA Cutaway Van 9200# GVW	
R	79-91	VAN 1 TON, G / SAVANA Cutaway Van 9200# GVW	
F	85	VAN 1 TON, P SERIES All Motorhome Chassis w/ I-Beam Front Suspension	
G63405	A		140884
R	61-66	FORD PICKUP 1 TON, F-350 / SUPERDUTY All	
R	61-64	PICKUP 3/4 TON, F-250 / SUPERDUTY All	
F	68-76	PICKUP P350 All Up through 8000# GVW	
F	75-76	PICKUP P400 All Up through 8000# GVW	
F	68	INTERNATIONAL 1200C All Exc. 166" Wheelbase	
R	68	1200C All Exc. 166" Wheelbase	
F	68	1300C All Exc. 166" Wheelbase	
R	68	1300C All Exc. 166" Wheelbase	
R	68-72	M1100 / M1200 All	
R	69	M1400 All	
R	96-04	MITSUBISHI FUSO FE All Model with O.E.M. Number	
R	98-04	FG All Model with O.E.M. Number	
G63406	B		
R	97	FORD F-250 HD RWD	
R	80-97	PICKUP 1 TON, F-350 / SUPERDUTY RWD Exc. Dual Rear Wheels	
R	97	PICKUP 3/4 TON, F-250 / SUPERDUTY RWD Over 8500# GVW	
R	80-96	PICKUP 3/4 TON, F-250 / SUPERDUTY RWD	
G63409	C		
R	80-97	FORD PICKUP 1 TON, F-350 / SUPERDUTY RWD Dual Rear Wheels	
R	97	PICKUP, F-450 SUPERDUTY All	
G63410	C		141047
F	80-81	FORD PICKUP 1 TON, F-350 / SUPERDUTY 4WD	
F	80-82	PICKUP 3/4 TON, F-250 / SUPERDUTY Standard Cab Pickup, 4WD	
G63411	C		
F	77-86	CHEVROLET PICKUP 1 TON, K30 All	
F	90-91	PICKUP 1 TON, R3500 All	
F	89	PICKUP 1 TON, R3500 Cab & Chassis	
F	89	PICKUP 1 TON, R3500 Crew Cab Pickup	
F	87-88	PICKUP 1 TON, V30 All	
F	89-91	PICKUP 1 TON, V3000 / V3500 All	
F	77-86	GMC PICKUP 1 TON, K35 / K3500 All	
F	87-91	PICKUP 1 TON, V3000 / V3500 All	
G63413	B		
R	85-95	CHEVROLET VAN 1 TON, G / EXPRESS Extended Cargo Van	
R	85-95	VAN 1 TON, G / EXPRESS Extended Passenger Van	
R	78-95	VAN 1 TON, G / EXPRESS Standard Cargo Van	
R	78-95	VAN 1 TON, G / EXPRESS Standard Passenger Van	
R	78	VAN 1 TON, G / EXPRESS Extended Cargo Van	
R	78-95	VAN 3/4 TON, G / EXPRESS All Exc. 8600# GVW	
R	95-03	DODGE VAN 1 TON, A / B SERIES / RAM All	
R	94	VAN 1 TON, A / B SERIES / RAM All Exc. 4000# Front Axle	
R	71-93	VAN 1 TON, A / B SERIES / RAM All	
R	71-03	VAN 3/4 TON, A / B SERIES / RAM All	
R	74-80	VAN, CB300 All	
R	85-96	GMC VAN 1 TON, G / SAVANA Extended Cargo Van	
R	85-96	VAN 1 TON, G / SAVANA Extended Passenger Van	
R	79-96	VAN 1 TON, G / SAVANA Standard Cargo Van	
R	79-96	VAN 1 TON, G / SAVANA Standard Passenger Van	

Numerical listing

Shock	POP	Alternative No.	MTG Acc. Supplied
Pos.	Year	Application	

Numerical listing

Shock	POP	Alternative No.	MTG Acc. Supplied
Pos.	Year	Application	
G63413	B (cont)		
R 78	VAN 1 TON, G / SAVANA Cutaway Van		
R 78-95	VAN 3/4 TON, G / SAVANA All Exc. 8600# GVW		
R 74-83	PLYMOUTH VAN 1 TON, PB SERIES All		
R 74-83	VAN 3/4 TON, PB SERIES All		
G63414	A		140780
F 97	FORD F-250 HD RWD		
F 80-97	PICKUP 1 TON, F-350 / SUPERDUTY RWD		
F 97	PICKUP 3/4 TON, F-250 / SUPERDUTY RWD Over 8500# GVW		
F 80-96	PICKUP 3/4 TON, F-250 / SUPERDUTY RWD		
G63419	C		
R 98	HINO FA, FB SERIES		
G63432	B		141349,140169
F	INTERNATIONAL DURASTAR - 1000 SERIES		
F	UD UD 1300		
G63455	C		
F 97	FORD F-250 HD 4WD		
F 86-97	PICKUP 1 TON, F-350 / SUPERDUTY 4WD		
F 97-98	PICKUP 3/4 TON, F-250 / SUPERDUTY 4WD Over 8500# GVW		
F 87-96	PICKUP 3/4 TON, F-250 / SUPERDUTY 4WD		
G63456	C		
R 86-97	FORD PICKUP 1 TON, F-350 / SUPERDUTY 4WD Exc. Dual Rear Wheels		
G63461	B		
R 97	FORD F-250 HD 4WD		
R 86-97	PICKUP 1 TON, F-350 / SUPERDUTY 4WD Dual Rear Wheels		
R 82-85	PICKUP 1 TON, F-350 / SUPERDUTY 4WD Clevis Type Lower Front Mount; Exc. Dual Rear Wheels or Lift Kit		
R 80-81	PICKUP 1 TON, F-350 / SUPERDUTY 4WD		
R 97	PICKUP 3/4 TON, F-250 / SUPERDUTY 4WD Over 8500# GVW		
R 86-96	PICKUP 3/4 TON, F-250 / SUPERDUTY 4WD		
R 82-85	PICKUP 3/4 TON, F-250 / SUPERDUTY 4WD Clevis Type Lower Front Mount; Exc. Dual Rear Wheels or Lift Kit		
R 80-81	PICKUP 3/4 TON, F-250 / SUPERDUTY 4WD		
R 99-07	PICKUP, F-450 SUPERDUTY All Models with single or dual rear wheels with 165" or 201" wheel base		
R 99-07	PICKUP, F-550 SUPERDUTY All Models with single or dual rear wheels with 165" or 201" wheel base		
G63488	A		
R 92-00	CHEVROLET PICKUP 1 TON, C35/3500 Crew Cab Pickup Exc. HD Straight Front Axle		
R 92-00	PICKUP 1 TON, C35/3500 Standard Cab Pickup Exc. HD Straight Front Axle		
R 88-00	PICKUP 1 TON, C35/3500 Extended Cab Pickup Exc. HD Straight Front Axle		
R 88-90	PICKUP 1 TON, C35/3500 Standard Cab Pickup Exc. HD Straight Front Axle		
R 88-00	PICKUP 1 TON, K35 / K3500 All		
R 88-00	PICKUP 3/4 TON, C25 / C2500 All		
R 92-00	GMC PICKUP 1 TON, C35/3500 Crew Cab Pickup Exc. HD Straight Front Axle		
R 88-00	PICKUP 1 TON, C35/3500 Extended Cab Pickup Exc. HD Straight Front Axle		
R 88-00	PICKUP 1 TON, C35/3500 Standard Cab Pickup Exc. HD Straight Front Axle		

Ultra Truck Shock

Shock	POP	Alternative No.	MTG Acc. Supplied
Pos.	Year	Application	
G63488	A (cont)		
R 88-00	PICKUP 1 TON, K35 / K3500 All		
R 88-00	PICKUP 3/4 TON, C25 / C2500 All		
R 88-00	PICKUP 3/4 TON, K25 / K2500 All		
G63489	A		141277
F 92-00	CHEVROLET PICKUP 1 TON, C35/3500 Crew Cab Pickup Exc. HD Straight Front Axle		
F 88-00	PICKUP 1 TON, C35/3500 Extended Cab Pickup Exc. HD Straight Front Axle		
F 88-00	PICKUP 1 TON, C35/3500 Standard Cab Pickup Exc. HD Straight Front Axle		
F 88-00	PICKUP 3/4 TON, C25 / C2500 All		
F 92-00	GMC PICKUP 1 TON, C35/3500 Crew Cab Pickup Exc. HD Straight Front Axle		
F 88-00	PICKUP 1 TON, C35/3500 Extended Cab Pickup Exc. HD Straight Front Axle		
F 88-00	PICKUP 1 TON, C35/3500 Standard Cab Pickup Exc. HD Straight Front Axle		
F 88-00	PICKUP 3/4 TON, C25 / C2500 All		
G63605	C		140169
F 74	DODGE M300 All		
F 74	M350 All		
G63607	C		140719
R 00-05	FORD EXCURSION RWD		
G63609	A		
F 88-00	CHEVROLET PICKUP 1 TON, K35 / K3500 All		
F 88-00	PICKUP 3/4 TON, K25 / K2500 All		
F 88-00	GMC PICKUP 1 TON, K35 / K3500 All		
F 88-00	PICKUP 3/4 TON, K25 / K2500 All		
G63610	B		142389
F 89-91	HINO FA14 All Models with O.E.M. Number		
F 92	FA15 All FA, FB Models Trucks with:		
F 93-97	FA1415 All (FA15)		
F 93-97	FA1415 All FA, FB Models Trucks with:		
F 93-97	FA1415 All FA1415 (FA15), FB1715 (FB15)		
F 98-04	FA1517 All FA, FB Models Trucks with:		
F 89-91	FB14 All FA, FB Models Trucks with:		
F 92	FB15 All FA, FB Models Trucks with:		
F 93-97	FB1715 All FA, FB Models Trucks with:		
F 93-97	FB1715 All FA1415 (FA15), FB1715 (FB15)		
F 98-04	FB1817 All FA, FB Models Trucks with:		
F 05-11	MITSUBISHI FUSO FE145 All Models with O.E.M. Number		
F 96-04	FE All Models with O.E.M. Number		
F 88-04	FH All Models with O.E.M. Number		
F 99-10	UD UD 18HD SERIES		
F 11-13	UD 1800 SERIES		
F 95-98	UD 1800 SERIES		
F 95-13	UD 2000 SERIES		
G63614	A		140780
F 00-05	FORD EXCURSION RWD		
G63622	N		142617
F 00-02	FORD E-450 ECONOLINE SUPER DUTY All		
F 99-22	PICKUP 1 TON, F-350 / SUPERDUTY RWD		
F 11-16	PICKUP 1 TON, F-350 / SUPERDUTY All Exc. Off Road		
F 99-09	PICKUP 1 TON, F-350 / SUPERDUTY All Exc. Off Road		
F 11-22	PICKUP 3/4 TON, F-250 / SUPERDUTY RWD Exc. Off Road		
F 99-10	PICKUP 3/4 TON, F-250 / SUPERDUTY RWD		
F 99-09	PICKUP 3/4 TON, F-250 / SUPERDUTY RWD Exc. Off Road		
F 21-22	VAN 1 TON, ECONOLINE / CLUB WAGON / SUPERDUTY All		
F 99-19	VAN 1 TON, ECONOLINE / CLUB WAGON / SUPERDUTY All		

Numerical listing

Shock	POP	Alternative No.	MTG Acc. Supplied
Pos.	Year	Application	
G63622	N (cont)		142617
F 07	VAN 1 TON, ECONOLINE / CLUB WAGON / SUPERDUTY All Exc. Cutaway Chassis		
F 92-05	VAN 1 TON, ECONOLINE / CLUB WAGON / SUPERDUTY All Cutaway Chassis		
F 92-14	VAN 3/4 TON, ECONOLINE / CLUB WAGON / SUPERDUTY All		
G63623	N		142617
R 00-02	FORD E-450 ECONOLINE SUPER DUTY All		
R 21-22	VAN 1 TON, ECONOLINE / CLUB WAGON / SUPERDUTY All		
R 99-19	VAN 1 TON, ECONOLINE / CLUB WAGON / SUPERDUTY All		
R 04-11	VAN 1 TON, ECONOLINE / CLUB WAGON / SUPERDUTY All Exc. Cutaway Chassis		
R 92-05	VAN 1 TON, ECONOLINE / CLUB WAGON / SUPERDUTY All Cutaway Chassis		
R 92-14	VAN 3/4 TON, ECONOLINE / CLUB WAGON / SUPERDUTY All		
G63625	B		140702
F 86-99	CHEVROLET VAN 1 TON, P SERIES All Motorhome Chassis w/ I-Beam Front Suspension		
F 86-99	GMC VAN 1 TON, P SERIES All Motorhome Chassis w/ I-Beam Front Suspension		
G63638	B		
R 97-02	CHEVROLET VAN 1 TON, G / EXPRESS All Exc. 8600# GVW		
R 96-02	VAN 3/4 TON, G / EXPRESS All Exc. 8600# GVW		
R 96-02	GMC VAN 1 TON, G / SAVANA All Exc. 8600# GVW		
R 96-02	VAN 3/4 TON, G / SAVANA All Exc. 8600# GVW		
G63661	B		143000
F 94-02	DODGE PICKUP 1 TON, RAM 3500 (SEE RAM 3500) RWD Exc. Solid Front Axle		
F 94-02	PICKUP 3/4 TON, RAM 2500 (SEE RAM 2500) RWD		
G63662	A		
R 94-02	DODGE PICKUP 1 TON, RAM 3500 (SEE RAM 3500) RWD Exc. Solid Front Axle		
R 94-03	PICKUP 3/4 TON, RAM 2500 (SEE RAM 2500) All Exc. 8800# GVW		
G63671	D		
R 92-96	CHEVROLET VAN 1 TON, G / EXPRESS Cutaway Van		
R 92-96	GMC VAN 1 TON, G / SAVANA Cutaway Van		
G63673	B		143000
F 03-10	DODGE PICKUP 1 TON, RAM 3500 (SEE RAM 3500) 4WD		
F 94-02	PICKUP 3/4 TON, RAM 2500 (SEE RAM 2500) 4WD Exc. 8800# GVW		
F 11-20	RAM 3500 (SEE DODGE RAM 3500) 4WD		
G63674	C		142731
F 94-02	DODGE PICKUP 1 TON, RAM 3500 (SEE RAM 3500) 4WD		
F 94-02	PICKUP 1 TON, RAM 3500 (SEE RAM 3500) RWD Solid Front Axle		
F 94-02	PICKUP 3/4 TON, RAM 2500 (SEE RAM 2500) 4WD 8800# GVW		
G63675	A		
R 77-86	CHEVROLET PICKUP 1 TON, K30 All		
R 90-91	PICKUP 1 TON, R3500 All		
R 89	PICKUP 1 TON, R3500 Cab & Chassis, RWD		
R 89	PICKUP 1 TON, R3500 Crew Cab Pickup, RWD		
R 01-09	PICKUP 1 TON, SILVERADO 3500 All		
R 07-10	PICKUP 1 TON, SILVERADO 3500 HD All		
R 87-88	PICKUP 1 TON, V30 All		
R 89-91	PICKUP 1 TON, V3000 / V3500 All		
R 99-08	PICKUP 3/4 TON, SILVERADO 2500 All		

Numerical listing

Shock	POP	Alternative No.	MTG Acc. Supplied
Pos.	Year	Application	
G63675	A	(cont)	
R	01-10	PICKUP 3/4 TON, SILVERADO 2500 HD All	
R	07	SILVERADO 2500 HD CLASSIC All	
R	94-02	DODGE PICKUP 1 TON, RAM 3500 (SEE RAM 3500) 4WD	
R	94-02	PICKUP 1 TON, RAM 3500 (SEE RAM 3500) RWD Solid Front Axle	
R	94-02	PICKUP 3/4 TON, RAM 2500 (SEE RAM 2500) 4WD 8800# GVW	
R	77-86	GMC PICKUP 1 TON, K35 / K3500 All	
R	87-91	PICKUP 1 TON, V3000 / V3500 All	
R	99-04	SIERRA 2500 All	
R	01-10	SIERRA 2500 HD All	
R	01-06	SIERRA 3500 All	
R	07-10	SIERRA 3500 HD All	
G63692	D		
F	97	FORD PICKUP, F-450 SUPERDUTY All	
G63714	A	142731	
F	97-99	FORD PICKUP 3/4 TON, F-250 / SUPERDUTY RWD Up through 8500# GVW	
G63715	B	142700	
R	97-99	FORD PICKUP 3/4 TON, F-250 / SUPERDUTY 4WD Up through 8500# GVW	
G63716	A	142731	
F	97-99	FORD PICKUP 3/4 TON, F-250 / SUPERDUTY 4WD Up through 8500# GVW	
G63778	A	142700	
R	97-99	FORD PICKUP 3/4 TON, F-250 / SUPERDUTY RWD Up through 8500# GVW	
G63783	A	141665	
F	99-04	CHEVROLET PICKUP 3/4 TON, SILVERADO 2500 RWD Exc. Electronic Adjustable Suspension	
F	01-04	PICKUP 3/4 TON, SILVERADO 2500 HD RWD	
F	99-04	GMC SIERRA 2500 RWD Exc. Electronic Adjustable Suspension	
F	01-04	SIERRA 2500 HD RWD	
G63808	B		
R	99-04	FORD PICKUP 1 TON, F-350 / SUPERDUTY RWD	
R	99-04	PICKUP 3/4 TON, F-250 / SUPERDUTY RWD	
G63809	A		
F	00-05	FORD EXCURSION 4WD	
F	99-04	PICKUP 1 TON, F-350 / SUPERDUTY 4WD	
F	99-04	PICKUP 3/4 TON, F-250 / SUPERDUTY 4WD	
F	99-04	PICKUP, F-450 SUPERDUTY All	
F	99-04	PICKUP, F-550 SUPERDUTY All	
G63810	A		
R	99-04	FORD PICKUP 1 TON, F-350 / SUPERDUTY 4WD	
R	99-04	PICKUP 3/4 TON, F-250 / SUPERDUTY 4WD	
G63817	A	141665	
F	01-09	CHEVROLET PICKUP 1 TON, SILVERADO 3500 All	
F	07-10	PICKUP 1 TON, SILVERADO 3500 HD All	
F	05-08	PICKUP 3/4 TON, SILVERADO 2500 All	
F	99-04	PICKUP 3/4 TON, SILVERADO 2500 4WD	
F	05-10	PICKUP 3/4 TON, SILVERADO 2500 HD All 9200# GVW	
F	01-04	PICKUP 3/4 TON, SILVERADO 2500 HD 4WD 9200# GVW	
F	07	SILVERADO 2500 HD CLASSIC All	
F	99-04	GMC SIERRA 2500 4WD	
F	01-10	SIERRA 2500 HD 4WD	
F	01-06	SIERRA 3500 All	
F	07-10	SIERRA 3500 HD Torsion Bar (FrontSpringType)	
G63837	C		
R	00-05	FORD EXCURSION 4WD	

Ultra Truck Shock

Shock	POP	Alternative No.	MTG Acc. Supplied
Pos.	Year	Application	
G63886	B	142731	
F	17-22	FORD PICKUP 1 TON, F-350 / SUPERDUTY 4WD	
F	13-16	PICKUP 1 TON, F-350 / SUPERDUTY 4WD Exc. Off Road	
F	11-16	PICKUP 1 TON, F-350 / SUPERDUTY All	
F	05-12	PICKUP 1 TON, F-350 / SUPERDUTY 4WD	
F	99-09	PICKUP 1 TON, F-350 / SUPERDUTY All	
F	12-16	PICKUP 3/4 TON, F-250 / SUPERDUTY RWD w/ Off Road Package	
F	01-16	PICKUP 3/4 TON, F-250 / SUPERDUTY 4WD	
F	99-09	PICKUP 3/4 TON, F-250 / SUPERDUTY RWD w/ Off Road	
F	99	PICKUP 3/4 TON, F-250 / SUPERDUTY 4WD	
G63888	A		
R	13-16	FORD PICKUP 1 TON, F-350 / SUPERDUTY 4WD	
R	05-12	PICKUP 1 TON, F-350 / SUPERDUTY Crew Cab Pickup, 4WD Single Rear Wheels	
R	05-12	PICKUP 1 TON, F-350 / SUPERDUTY Extended Cab Pickup, 4WD Single Rear Wheels	
R	05-12	PICKUP 1 TON, F-350 / SUPERDUTY Standard Cab Pickup, 4WD Single Rear Wheels	
R	13-16	PICKUP 3/4 TON, F-250 / SUPERDUTY RWD	
R	05-12	PICKUP 3/4 TON, F-250 / SUPERDUTY 4WD	
G63893	C	143276	
F	03-12	CHEVROLET VAN 1 TON, G / EXPRESS All Torsion Bar (FrontSpringType)	
F	06-12	VAN 3/4 TON, G / EXPRESS All Torsion Bar (FrontSpringType)	
F	03-05	VAN 3/4 TON, G / EXPRESS Torsion Bar (FrontSpringType)	
F	03-12	GMC VAN 1 TON, G / SAVANA All Torsion Bar (FrontSpringType)	
F	04-12	VAN 3/4 TON, G / SAVANA All Torsion Bar (FrontSpringType)	
F	03	VAN 3/4 TON, G / SAVANA Torsion Bar (FrontSpringType)	
G63895	A	143276	
F	09-22	CHEVROLET EXPRESS 4500 All	
F	17-23	VAN 1 TON, G / EXPRESS All	
F	03-16	VAN 1 TON, G / EXPRESS Coil (FrontSpringType)	
F	17-23	VAN 3/4 TON, G / EXPRESS All	
F	03-16	VAN 3/4 TON, G / EXPRESS Coil (FrontSpringType)	
F	10-20	GMC SAVANA 4500 All	
F	17-23	VAN 1 TON, G / SAVANA All	
F	03-16	VAN 1 TON, G / SAVANA Coil (FrontSpringType)	
F	17-23	VAN 3/4 TON, G / SAVANA All	
F	03-16	VAN 3/4 TON, G / SAVANA Coil (FrontSpringType)	
G63897	A		
R	09-22	CHEVROLET EXPRESS 4500 All	
R	13-23	VAN 1 TON, G / EXPRESS All	
R	03-12	VAN 1 TON, G / EXPRESS All Single Rear Wheels	
R	03-23	VAN 3/4 TON, G / EXPRESS All	
R	10-20	GMC SAVANA 4500 All	
R	13-23	VAN 1 TON, G / SAVANA All	
R	03-12	VAN 1 TON, G / SAVANA All Single Rear Wheels	
R	03-23	VAN 3/4 TON, G / SAVANA All	
G63918	C		
R	07-09	DODGE SPRINTER 2500 All Single Rear Wheels	
R	03-06	SPRINTER 2500 All Exc. Dual Rear Wheels	
R	07-09	SPRINTER 3500 All Single Rear Wheels	
R	03-06	SPRINTER 3500 All Exc. Dual Rear Wheels	
R	02-06	FREIGHTLINER SPRINTER 2500 All	
G63969	D	143146	
F	05-08	FORD PICKUP, F-450 SUPERDUTY All	

Numerical listing

Shock	POP	Alternative No.	MTG Acc. Supplied
Pos.	Year	Application	
G63969	D	(cont) 143146	
F	05-07	PICKUP, F-550 SUPERDUTY All	
G63971	C		
R	03-07	DODGE PICKUP 1 TON, RAM 3500 (SEE RAM 3500) Crew Cab Pickup, RWD	
R	03-08	PICKUP 3/4 TON, RAM 2500 (SEE RAM 2500) Crew Cab Pickup, RWD	
G64009	C	142731	
F	15-18	RAM 2500 (SEE DODGE RAM 2500) Power Wagon, 4WD	
F	11-14	2500 (SEE DODGE RAM 2500) 4WD	
G64010	C		
R	05-16	FORD PICKUP 1 TON, F-350 / SUPERDUTY RWD	
R	11-16	PICKUP 3/4 TON, F-250 / SUPERDUTY RWD Exc. Off Road	
R	05-10	PICKUP 3/4 TON, F-250 / SUPERDUTY RWD	
G64011	C	142731	
F	05-08	DODGE PICKUP 3/4 TON, RAM 2500 (SEE RAM 2500) 4WD	
G64013	D		
R	03-10	DODGE PICKUP 3/4 TON, RAM 2500 (SEE RAM 2500) 4WD 8800# GVW	
R	11-13	RAM 2500 (SEE DODGE RAM 2500) 4WD	
G64043	B		
F	16-18	RAM 1500 (SEE DODGE RAM 1500) RWD Exc. Air Suspension	
F	11-15	1500 (SEE DODGE RAM 1500) RWD	
F	19-20	1500 CLASSIC RWD Old Body Style	
F	11-15	2500 (SEE DODGE RAM 2500) Standard Cab Pickup, RWD	
F	11-15	3500 (SEE DODGE RAM 3500) Standard Cab Pickup, RWD	
G64044	A		
R	11-18	RAM 1500 (SEE DODGE RAM 1500) All	
R	19-20	1500 CLASSIC 4WD	
G64089	D		
R	07-18	FREIGHTLINER SPRINTER 3500 All	
R	11-20	MERCEDES-BENZ SPRINTER 3500 All	
G64121	A		
R	15-18	CHEVROLET PICKUP 1 TON, SILVERADO 3500 All	
R	11-13	PICKUP 1 TON, SILVERADO 3500 All	
R	11-23	PICKUP 1 TON, SILVERADO 3500 HD All	
R	11-18	PICKUP 3/4 TON, SILVERADO 2500 All	
R	11-23	PICKUP 3/4 TON, SILVERADO 2500 HD All	
R	11-23	GMC SIERRA 2500 HD All	
R	11-23	SIERRA 3500 HD All	
R	14-20	RAM 3500 (SEE DODGE RAM 3500) 4WD	
G64148	A		
F	11-23	CHEVROLET PICKUP 1 TON, SILVERADO 3500 HD All	
F	11-23	PICKUP 3/4 TON, SILVERADO 2500 HD All	
F	11-23	GMC SIERRA 2500 HD All	
F	11-23	SIERRA 3500 HD All	
G64164	D		
R	12-19	NISSAN NV1500 All	
R	12-19	NV2500 All	
R	12-19	NV3500 All	
G64177	C		
R	15-22	FORD TRANSIT-150 All	
R	15-22	TRANSIT-250 All	
R	15-22	TRANSIT-350 All	
G64268	N		
R	17-23	FORD PICKUP 1 TON, F-350 / SUPERDUTY 4WD	
R	17-23	PICKUP 3/4 TON, F-250 / SUPERDUTY 4WD	

Numerical listing

Shock	POP	Alternative No.	MTG Acc. Supplied
Pos.	Year	Application	
G64269 N			
R	17-23	FORD PICKUP 1 TON, F-350 / SUPERDUTY RWD	
R	17-23	PICKUP 3/4 TON, F-250 / SUPERDUTY RWD	
ProGuard			
61500 A			
R	61-66	FORD PICKUP 1 TON, F-350 / SUPERDUTY All	
R	61-64	PICKUP 3/4 TON, F-250 / SUPERDUTY All	
F	68-76	PICKUP P350 All Up through 8000# GVW	
F	75-76	PICKUP P400 All Up through 8000# GVW	
F	68	INTERNATIONAL 1200C All Exc. 166" Wheelbase	
R	68	1200C All Exc. 166" Wheelbase	
F	68	1300C All Exc. 166" Wheelbase	
R	68	1300C All Exc. 166" Wheelbase	
R	68-72	M1100 / M1200 All	
R	69	M1400 All	
61516 C			
F	81-86	CHEVROLET PICKUP 3/4 TON, K20 All Quad Suspension Short Shock; Exc. Lift Kit	
F	69-80	PICKUP 3/4 TON, K20 All Exc. Lift Kit	
F	87	PICKUP 3/4 TON, V20 All Exc. Quad Suspension and Lift Kit	
F	69-86	GMC PICKUP 3/4 TON, K25 / K2500 All Exc. Quad Suspension and Lift Kit	
F	87	PICKUP 3/4 TON, V2500 All Quad Suspension Short Shock; Exc. Lift Kit	
61517 B			
F	78-96	CHEVROLET VAN 1 TON, G / EXPRESS All	
F	75	VAN 1 TON, G / EXPRESS 146.0 / 370.8 (WheelBase)	
F	71-74	VAN 1 TON, G / EXPRESS All	
F	78-95	VAN 3/4 TON, G / EXPRESS All Exc. 8600# GVW	
F	71-77	VAN 3/4 TON, G / EXPRESS All	
F	70	VAN 3/4 TON, G / EXPRESS All Independent Front Suspension	
F	76-95	GMC VAN 1 TON, G / SAVANA All	
F	75	VAN 1 TON, G / SAVANA 110.0 / 279.4 (WheelBase)	
F	75	VAN 1 TON, G / SAVANA 125.0 / 317.5 (WheelBase)	
F	71-74	VAN 1 TON, G / SAVANA All	
F	78-95	VAN 3/4 TON, G / SAVANA All Exc. 8600# GVW	
F	71-77	VAN 3/4 TON, G / SAVANA All	
F	70	VAN 3/4 TON, G / SAVANA All Independent Front Suspension	
61518 C 140126			
R	75-79	FORD PICKUP 1 TON, F-350 / SUPERDUTY Extended Cab Pickup, RWD	
R	67-74	PICKUP 1 TON, F-350 / SUPERDUTY RWD Extended Cab	
R	75-79	PICKUP 3/4 TON, F-250 / SUPERDUTY Cab & Chassis, RWD	
R	75-79	PICKUP 3/4 TON, F-250 / SUPERDUTY Standard Cab Pickup, RWD	
R	65-74	PICKUP 3/4 TON, F-250 / SUPERDUTY All RWD	
61519 A 141137			
R	75-79	FORD PICKUP 1 TON, F-350 / SUPERDUTY Standard Cab Pickup, RWD	
R	73-74	PICKUP 1 TON, F-350 / SUPERDUTY All RWD; Exc. Supercab	
R	75-79	PICKUP 3/4 TON, F-250 / SUPERDUTY Extended Cab Pickup, RWD	
R	73-74	PICKUP 3/4 TON, F-250 / SUPERDUTY RWD Supercab	
R	65-72	PICKUP 3/4 TON, F-250 / SUPERDUTY All RWD; Supercab	
R	69-74	VAN 1 TON, ECONOLINE / CLUB WAGON / SUPERDUTY All	
R	69-74	VAN 3/4 TON, ECONOLINE / CLUB WAGON / SUPERDUTY All	

Ultra Truck Shock, ProGuard

Shock	POP	Alternative No.	MTG Acc. Supplied
Pos.	Year	Application	
61520 A 140780			
F	97	FORD F-250 HD RWD	
F	80-97	PICKUP 1 TON, F-350 / SUPERDUTY RWD	
F	97	PICKUP 3/4 TON, F-250 / SUPERDUTY RWD Over 8500# GVW	
F	80-96	PICKUP 3/4 TON, F-250 / SUPERDUTY RWD	
61521 B 140780			
F	67-79	FORD PICKUP 1 TON, F-350 / SUPERDUTY All Quad Suspension Rearward of Front Axle	
F	65-79	PICKUP 3/4 TON, F-250 / SUPERDUTY All Quad Suspension Rearward of Front Axle	
F	75-91	VAN 1 TON, ECONOLINE / CLUB WAGON / SUPERDUTY All Exc. Cutaway Chassis RWD, 4WD Quad Suspension Rearward of Front Axle, Non Quad Suspension	
F	75-91	VAN 3/4 TON, ECONOLINE / CLUB WAGON / SUPERDUTY All RWD, 4WD Quad Suspension Rearward of Front Axle, Non Quad Suspension	
61522 B			
F	81-86	CHEVROLET PICKUP 3/4 TON, K20 All Quad Suspension Long Shock; Exc. Lift Kit	
F	87	PICKUP 3/4 TON, V20 All Quad Suspension Long Shock; Exc. Lift Kit	
R	78-95	VAN 1 TON, G / EXPRESS Cutaway Van	
R	78-95	VAN 3/4 TON, G / EXPRESS All Exc. 8600# GVW	
R	71-03	DODGE VAN 1 TON, A / B SERIES / RAM All	
R	71-03	VAN 3/4 TON, A / B SERIES / RAM All	
R	74-80	VAN, CB300 All	
F	81-86	GMC PICKUP 3/4 TON, K25 / K2500 All Quad Suspension Long Shock; Exc. Lift Kit	
F	87	PICKUP 3/4 TON, V2500 All Quad Suspension Long Shock; Exc. Lift Kit	
R	85-96	VAN 1 TON, G / SAVANA Extended Cargo Van	
R	85-96	VAN 1 TON, G / SAVANA Extended Passenger Van	
R	79-96	VAN 1 TON, G / SAVANA Standard Cargo Van	
R	79-96	VAN 1 TON, G / SAVANA Standard Passenger Van	
R	78	VAN 1 TON, G / SAVANA Cutaway Van	
R	78-95	VAN 3/4 TON, G / SAVANA All Exc. 8600# GVW	
R	74-83	PLYMOUTH VAN 1 TON, PB SERIES All	
R	74-83	VAN 3/4 TON, PB SERIES All	
61523 B 140126			
F	72-93	DODGE PICKUP 3/4 TON, D200 SERIES All Exc. Heavy Duty Package	
F	95-03	VAN 1 TON, A / B SERIES / RAM All	
F	71-94	VAN 1 TON, A / B SERIES / RAM All Exc. 4000# Front Axle	
F	71-03	VAN 3/4 TON, A / B SERIES / RAM All	
F	74-80	VAN, CB300 All Exc. 4000# Front Axle	
F	74-83	PLYMOUTH VAN 1 TON, PB SERIES All Exc. 4000# Front Axle	
F	74-83	VAN 3/4 TON, PB SERIES All	
61524 A 140357			
R	75-86	CHEVROLET PICKUP 3/4 TON, C20 Standard Cab Pickup	
R	73-74	PICKUP 3/4 TON, C20 All Standard Cab Pickup	
R	73-86	PICKUP 3/4 TON, K20 All Exc. Lift Kit	
R	87	PICKUP 3/4 TON, R20 Standard Cab Pickup	
R	87	PICKUP 3/4 TON, V20 All Exc. Quad Suspension and Lift Kit	
R	73-78	VAN 3/4 TON, P SERIES All	
R	75-86	GMC PICKUP 3/4 TON, C25 / C2500 Cab & Chassis	
R	75-86	PICKUP 3/4 TON, C25 / C2500 Standard Cab Pickup	
R	73-74	PICKUP 3/4 TON, C25 / C2500 All Exc. Crew Cab & Bonus Cab	

Numerical listing

Shock	POP	Alternative No.	MTG Acc. Supplied
Pos.	Year	Application	
61524 A (cont) 140357			
R	73-86	PICKUP 3/4 TON, K25 / K2500 All Exc. Lift Kit	
R	88-89	PICKUP 3/4 TON, R2500 All Exc. Crew Cab & Bonus Cab	
R	87	PICKUP 3/4 TON, R2500 Cab & Chassis Exc. Crew Cab & Bonus Cab	
R	87	PICKUP 3/4 TON, R2500 Standard Cab Pickup Exc. Crew Cab & Bonus Cab	
R	87	PICKUP 3/4 TON, V2500 All Exc. Lift Kit	
R	73-78	VAN 3/4 TON, P SERIES All	
61525 A 140702			
F	75-86	CHEVROLET PICKUP 1 TON, C30 All	
F	88-91	PICKUP 1 TON, C35/3500 Cab & Chassis Exc. HD Solid Front Axle	
F	87-88	PICKUP 1 TON, R30 All	
F	89	PICKUP 1 TON, R3500 Standard Cab Pickup	
F	63-86	PICKUP 3/4 TON, C20 All	
F	87-88	PICKUP 3/4 TON, R20 All	
F	89	PICKUP 3/4 TON, R2500 All	
F	68-90	VAN 1 TON, P SERIES All Cutaway Chassis	
F	68-89	VAN 3/4 TON, P SERIES All	
F	88-91	GMC PICKUP 1 TON, C35/3500 Cab & Chassis HD Solid Front Axle	
F	67-78	PICKUP 1 TON, C35/3500 All	
F	87-91	PICKUP 1 TON, R3500 All	
F	85-86	PICKUP 3/4 TON, C25 / C2500 Crew Cab Pickup	
F	75-86	PICKUP 3/4 TON, C25 / C2500 Cab & Chassis	
F	75-86	PICKUP 3/4 TON, C25 / C2500 Standard Cab Pickup	
F	75-83	PICKUP 3/4 TON, C25 / C2500 Crew Cab Pickup	
F	67-74	PICKUP 3/4 TON, C25 / C2500 All	
F	87-89	PICKUP 3/4 TON, R2500 All Exc. Crew Cab & Bonus Cab	
F	66	PICKUP 2500 SERIES All	
F	75-90	VAN 1 TON, P SERIES All Cutaway Chassis	
F	73-74	VAN 1 TON, P SERIES Base Cutaway Chassis	
F	68-72	VAN 1 TON, P SERIES All	
F	68-89	VAN 3/4 TON, P SERIES All	
61530 A			
R	97	FORD F-250 HD 4WD	
R	86-97	PICKUP 1 TON, F-350 / SUPERDUTY 4WD Dual Rear Wheels	
R	82-85	PICKUP 1 TON, F-350 / SUPERDUTY 4WD Clevis Type Lower Front Mount; Exc. Dual Rear Wheels or Lift Kit	
R	80-81	PICKUP 1 TON, F-350 / SUPERDUTY 4WD	
R	97	PICKUP 3/4 TON, F-250 / SUPERDUTY 4WD Over 8500# GVW	
R	87-96	PICKUP 3/4 TON, F-250 / SUPERDUTY 4WD	
R	82-86	PICKUP 3/4 TON, F-250 / SUPERDUTY 4WD Clevis Type Lower Front Mount; Exc. Dual Rear Wheels or Lift Kit	
R	80-81	PICKUP 3/4 TON, F-250 / SUPERDUTY 4WD	
61542 A			
F	88-00	CHEVROLET PICKUP 1 TON, K35 / K3500 All	
F	88-00	PICKUP 3/4 TON, K25 / K2500 All	
F	88-00	GMC PICKUP 1 TON, K35 / K3500 All	
F	88-00	PICKUP 3/4 TON, K25 / K2500 All	
61543 A			
R	91-02	CHEVROLET C3500HD All Solid Front Axle	
R	88-90	PICKUP 1 TON, C35/3500 Extended Cab Pickup Exc. HD Straight Front Axle	
R	88-90	PICKUP 1 TON, C35/3500 Standard Cab Pickup Exc. HD Straight Front Axle	
R	88-00	PICKUP 1 TON, K35 / K3500 All	
R	88-00	PICKUP 3/4 TON, C25 / C2500 All	
R	88-00	PICKUP 3/4 TON, K25 / K2500 All	
R	01-02	GMC C3500HD All	

Numerical listing

Shock	POP	Alternative No.	MTG Acc. Supplied	
Pos.	Year	Application		
61543	A (cont)			
R	91-00	C3500HD	All Solid Front Axle	
R	91-00	PICKUP 1 TON, C35/3500	All HD Solid Front Axle	
R	88-90	PICKUP 1 TON, C35/3500	All Exc. HD Straight Front Axle	
R	88-90	PICKUP 1 TON, K35 / K3500	All	
R	88-00	PICKUP 3/4 TON, C25 / C2500	All	
R	88-00	PICKUP 3/4 TON, K25 / K2500	All	
61544	A		141277	
F	92-00	CHEVROLET	PICKUP 1 TON, C35/3500 Crew Cab Pickup Exc. HD Straight Front Axle	
F	88-00	PICKUP 1 TON, C35/3500	Extended Cab Pickup Exc. HD Straight Front Axle	
F	88-00	PICKUP 1 TON, C35/3500	Standard Cab Pickup Exc. HD Straight Front Axle	
F	88-00	PICKUP 3/4 TON, C25 / C2500	All	
F	92-00	GMC	PICKUP 1 TON, C35/3500 Crew Cab Pickup Exc. HD Straight Front Axle	
F	88-00	PICKUP 1 TON, C35/3500	Extended Cab Pickup Exc. HD Straight Front Axle	
F	88-00	PICKUP 1 TON, C35/3500	Standard Cab Pickup Exc. HD Straight Front Axle	
F	88-00	PICKUP 3/4 TON, C25 / C2500	All	
61546	C		141047	
F	80-81	FORD	PICKUP 1 TON, F-350 / SUPERDUTY 4WD	
F	80-82	PICKUP 3/4 TON, F-250 / SUPERDUTY 4WD		
61547	C			
R	97	FORD	F-250 HD RWD	
R	80-97	PICKUP 1 TON, F-350 / SUPERDUTY RWD	Exc. Dual Rear Wheels	
R	97	PICKUP 3/4 TON, F-250 / SUPERDUTY RWD	Over 8500# GVW	
R	80-96	PICKUP 3/4 TON, F-250 / SUPERDUTY RWD		
61554	B			
R	80-97	FORD	PICKUP 1 TON, F-350 / SUPERDUTY RWD	Dual Rear Wheels
R	97	PICKUP, F-450	SUPERDUTY ALL	
61555	D		142615	
F	96-02	CHEVROLET	VAN 1 TON, G / EXPRESS All	
F	96-02	VAN 3/4 TON, G / EXPRESS	All Exc. 8600# GVW	
F	96-02	GMC	VAN 1 TON, G / SAVANA All	
F	96-02	VAN 3/4 TON, G / SAVANA	All Exc. 8600# GVW	
61565	C			
R	97-02	CHEVROLET	VAN 1 TON, G / EXPRESS All	
R	96	VAN 1 TON, G / EXPRESS	All Exc. 8600# GVW	
R	96-02	VAN 3/4 TON, G / EXPRESS	All Exc. 8600# GVW	
R	96-02	GMC	VAN 1 TON, G / SAVANA All	
R	96-02	VAN 3/4 TON, G / SAVANA	All Exc. 8600# GVW	
61591	D		140780	
F	92-11	FORD	VAN 1 TON, ECONOLINE / CLUB WAGON / SUPERDUTY All	
F	92-02	VAN 3/4 TON, ECONOLINE / CLUB WAGON / SUPERDUTY	All	
61599	C		143000	
F	94-02	DODGE	PICKUP 1 TON, RAM 3500 (SEE RAM 3500) RWD	Exc. Solid Front Axle
F	94-02	PICKUP 3/4 TON, RAM 2500	(SEE RAM 2500) RWD	
61600	A			
R	94-02	DODGE	PICKUP 1 TON, RAM 3500 (SEE RAM 3500) RWD	Exc. Solid Front Axle
R	94-03	PICKUP 3/4 TON, RAM 2500	(SEE RAM 2500) All Exc. 8800# GVW	

ProGuard

Shock	POP	Alternative No.	MTG Acc. Supplied	
Pos.	Year	Application		
61611	A		142731	
F	96-99	FORD	PICKUP 3/4 TON, F-250 / SUPERDUTY RWD	Up through 8500# GVW
61612	B		142700	
R	97-99	FORD	PICKUP 3/4 TON, F-250 / SUPERDUTY 4WD	Up through 8500# GVW
61613	B		142731	
F	97-99	FORD	PICKUP 3/4 TON, F-250 / SUPERDUTY 4WD	Up through 8500# GVW
61614	C			
F	97	FORD	F-250 HD 4WD	
F	86-97	PICKUP 1 TON, F-350 / SUPERDUTY 4WD		
F	97-98	PICKUP 3/4 TON, F-250 / SUPERDUTY 4WD	Over 8500# GVW	
F	87-96	PICKUP 3/4 TON, F-250 / SUPERDUTY 4WD		
61632	D			
F	81-93	DODGE	PICKUP 1 TON, W300 SERIES	All Exc. Quad Suspension and Lift Kit
F	61-80	PICKUP 1 TON, W300	SERIES All	
R	61-71	PICKUP 1 TON, W300	SERIES All	
F	90-93	PICKUP 3/4 TON, W200	SERIES Extended Cab Pickup Exc. Lift Kit	
F	88-93	PICKUP 3/4 TON, W200	SERIES Cab & Chassis Exc. Lift Kit	
F	81-93	PICKUP 3/4 TON, W200	SERIES Standard Cab Pickup Exc. Lift Kit	
F	86	PICKUP 3/4 TON, W200	SERIES Cab & Chassis Exc. Lift Kit	
F	81-83	PICKUP 3/4 TON, W200	SERIES Cab & Chassis Exc. Lift Kit	
F	81-82	PICKUP 3/4 TON, W200	SERIES Extended Cab Pickup Exc. Lift Kit	
F	69-80	PICKUP 3/4 TON, W200	SERIES All	
F	61-67	PICKUP 3/4 TON, W200	SERIES All	
61634	D		142731	
F	94-02	DODGE	PICKUP 3/4 TON, RAM 2500 (SEE RAM 2500) 4WD	Exc. 8800# GVW
61635	C		142731	
F	94-02	DODGE	PICKUP 1 TON, RAM 3500 (SEE RAM 3500) 4WD	
F	94-02	PICKUP 1 TON, RAM 3500	(SEE RAM 3500) RWD Solid Front Axle	
F	94-02	PICKUP 3/4 TON, RAM 2500	(SEE RAM 2500) 4WD 8800# GVW	
61638	B		142700	
R	97-99	FORD	PICKUP 3/4 TON, F-250 / SUPERDUTY RWD	Up through 8500# GVW
61641	A		141665	
F	99-04	CHEVROLET	PICKUP 3/4 TON, SILVERADO 2500	RWD Exc. Electronic Adjustable Suspension
F	01-04	PICKUP 3/4 TON, SILVERADO	2500 HD RWD	
F	99-04	GMC	SIERRA 2500 RWD	Exc. Electronic Adjustable Suspension
F	01-04	SIERRA 2500	HD RWD	
61642	A			
R	77-86	CHEVROLET	PICKUP 1 TON, K30 All	
R	90-91	PICKUP 1 TON, R3500	All	
R	89	PICKUP 1 TON, R3500	Cab & Chassis, RWD	
R	89	PICKUP 1 TON, R3500	Crew Cab Pickup, RWD	
R	01-09	PICKUP 1 TON, SILVERADO	3500 All	
R	07-10	PICKUP 1 TON, SILVERADO	3500 HD All	
R	87-88	PICKUP 1 TON, V30	All	
R	89-91	PICKUP 1 TON, V3000 / V3500	All	
R	99-08	PICKUP 3/4 TON, SILVERADO	2500 All	
R	01-10	PICKUP 3/4 TON, SILVERADO	2500 HD All	
R	07	SILVERADO 2500	HD CLASSIC All	
R	94-02	DODGE	PICKUP 1 TON, RAM 3500 (SEE RAM 3500) 4WD	

Numerical listing

Shock	POP	Alternative No.	MTG Acc. Supplied	
Pos.	Year	Application		
61642	A (cont)			
R	94-02	PICKUP 1 TON, RAM 3500	(SEE RAM 3500) RWD Solid Front Axle	
R	94-02	PICKUP 3/4 TON, RAM 2500	(SEE RAM 2500) 4WD 8800# GVW	
R	77-86	GMC	PICKUP 1 TON, K35 / K3500 All	
R	87-91	PICKUP 1 TON, V3000 / V3500	All	
R	99-04	SIERRA 2500	All	
R	01-10	SIERRA 2500	HD All	
R	01-06	SIERRA 3500	All	
R	07	SIERRA 3500	CLASSIC All	
R	07-10	SIERRA 3500	HD All	
61646	D		142617	
R	00-02	FORD	E-450 ECONOLINE SUPER DUTY All	
R	21-24	VAN 1 TON, ECONOLINE / CLUB WAGON / SUPERDUTY	All	
R	92-19	VAN 1 TON, ECONOLINE / CLUB WAGON / SUPERDUTY	All	
R	04-11	VAN 1 TON, ECONOLINE / CLUB WAGON / SUPERDUTY	All Exc. Cutaway Chassis	
R	92-14	VAN 3/4 TON, ECONOLINE / CLUB WAGON / SUPERDUTY	All	
61654	D			
R	99-04	FORD	PICKUP 1 TON, F-350 / SUPERDUTY RWD	
R	99-04	PICKUP 3/4 TON, F-250 / SUPERDUTY RWD		
61655	B			
R	02	FORD	E-550 ECONOLINE SUPER DUTY All	
R	03	E-550	SUPER DUTY All	
F	99-04	PICKUP 1 TON, F-350 / SUPERDUTY 4WD		
F	99-04	PICKUP 3/4 TON, F-250 / SUPERDUTY 4WD		
F	99-04	PICKUP, F-450	SUPERDUTY All	
F	99-04	PICKUP, F-550	SUPERDUTY All	
61656	B			
R	99-04	FORD	PICKUP 1 TON, F-350 / SUPERDUTY 4WD	
R	99-04	PICKUP 3/4 TON, F-250 / SUPERDUTY 4WD		
61663	A		141665	
F	01-09	CHEVROLET	PICKUP 1 TON, SILVERADO 3500 All	
F	07-10	PICKUP 1 TON, SILVERADO	3500 HD All	
F	05-08	PICKUP 3/4 TON, SILVERADO	2500 All	
F	99-04	PICKUP 3/4 TON, SILVERADO	2500 4WD	
F	05-10	PICKUP 3/4 TON, SILVERADO	2500 HD All 9200# GVW	
F	01-04	PICKUP 3/4 TON, SILVERADO	2500 HD 4WD 9200# GVW	
F	07	SILVERADO 2500	HD CLASSIC All	
F	99-04	GMC	SIERRA 2500 4WD	
F	01-10	SIERRA 2500	HD 4WD	
F	01-06	SIERRA 3500	All	
F	07	SIERRA 3500	CLASSIC All	
F	07-10	SIERRA 3500	HD Torsion Bar (FrontSpringType)	
61680	A		142731	
F	05-22	FORD	PICKUP 1 TON, F-350 / SUPERDUTY 4WD	
F	11-16	PICKUP 1 TON, F-350 / SUPERDUTY	All	
F	99-09	PICKUP 1 TON, F-350 / SUPERDUTY	All	
F	01-22	PICKUP 3/4 TON, F-250 / SUPERDUTY 4WD		
F	99	PICKUP 3/4 TON, F-250 / SUPERDUTY 4WD		
61682	A			
R	13-16	FORD	PICKUP 1 TON, F-350 / SUPERDUTY 4WD	w/ Off Road Package
R	05-12	PICKUP 1 TON, F-350 / SUPERDUTY	Crew Cab Pickup, 4WD Single Rear Wheels	
R	05-12	PICKUP 1 TON, F-350 / SUPERDUTY	Extended Cab Pickup, 4WD Single Rear Wheels	
R	05-12	PICKUP 1 TON, F-350 / SUPERDUTY	Standard Cab Pickup, 4WD Single Rear Wheels	

Numerical listing

Shock	POP	Alternative No.	MTG Acc. Supplied
Pos.	Year	Application	
61682 A (cont)			
R	12-16	PICKUP 3/4 TON, F-250 / SUPERDUTY RWD w/ Off Road Package	
R	05-16	PICKUP 3/4 TON, F-250 / SUPERDUTY 4WD	
61683 D 143276			
F	06-12	CHEVROLET VAN 3/4 TON, G / EXPRESS All Torsion Bar (FrontSpringType)	
F	03-05	VAN 3/4 TON, G / EXPRESS Torsion Bar (FrontSpringType)	
F	06-12	GMC VAN 3/4 TON, G / SAVANA All Torsion Bar (FrontSpringType)	
F	03-05	VAN 3/4 TON, G / SAVANA AWD, Torsion Bar (FrontSpringType)	
61685 B 143078			
F	09-22	CHEVROLET EXPRESS 4500 All	
F	17-23	VAN 1 TON, G / EXPRESS All	
F	03-16	VAN 1 TON, G / EXPRESS Coil (FrontSpringType)	
F	17-23	VAN 3/4 TON, G / EXPRESS All	
F	03-16	VAN 3/4 TON, G / EXPRESS Coil (FrontSpringType)	
F	10-20	GMC SAVANA 4500 All	
F	17-23	VAN 1 TON, G / SAVANA All	
F	03-16	VAN 1 TON, G / SAVANA Coil (FrontSpringType)	
F	17-23	VAN 3/4 TON, G / SAVANA All	
F	03-16	VAN 3/4 TON, G / SAVANA Coil (FrontSpringType)	
61687 C			
R	09-22	CHEVROLET EXPRESS 4500 All	
R	13-23	VAN 1 TON, G / EXPRESS All	
R	03-12	VAN 1 TON, G / EXPRESS All Single Rear Wheels	
R	03-23	VAN 3/4 TON, G / EXPRESS All	
R	10-20	GMC SAVANA 4500 All	
R	13-23	VAN 1 TON, G / SAVANA All	
R	03-12	VAN 1 TON, G / SAVANA All Single Rear Wheels	
R	03-23	VAN 3/4 TON, G / SAVANA All	
61710 C			
R	03-07	DODGE PICKUP 1 TON, RAM 3500 (SEE RAM 3500) Crew Cab Pickup, RWD	
R	03-08	PICKUP 3/4 TON, RAM 2500 (SEE RAM 2500) Crew Cab Pickup, RWD	
61713 C			
R	05-16	FORD PICKUP 1 TON, F-350 / SUPERDUTY RWD Exc. Off Road	
R	05-16	PICKUP 3/4 TON, F-250 / SUPERDUTY RWD Exc. Off Road	
61714 C 142731			
F	05-08	DODGE PICKUP 3/4 TON, RAM 2500 (SEE RAM 2500) 4WD	
61716 C			
R	03-10	DODGE PICKUP 3/4 TON, RAM 2500 (SEE RAM 2500) 4WD	
R	11-13	RAM 2500 (SEE DODGE RAM 2500) 4WD	
Steering Dampers			
14017 B 142387			
F	77-86	CHEVROLET PICKUP 1 TON, K30 All	
F	73-74	PICKUP 1 TON, K30 All	
F	89-91	PICKUP 1 TON, R3500 All	
F	87-88	PICKUP 1 TON, V30 All	
F	89-91	PICKUP 1 TON, V3000 / V3500 All	
F	73-86	PICKUP 3/4 TON, K20 All	
F	87	PICKUP 3/4 TON, V20 All	
F	77-86	GMC PICKUP 1 TON, K35 / K3500 All	
F	73-74	PICKUP 1 TON, K35 / K3500 All	
F	87-91	PICKUP 1 TON, V3000 / V3500 All	
F	73-86	PICKUP 3/4 TON, K25 / K2500 All	
F	87	PICKUP 3/4 TON, V2500 All	
14072 B			
F	08-22	FORD PICKUP 1 TON, F-350 / SUPERDUTY 4WD	
F	08-22	PICKUP 3/4 TON, F-250 / SUPERDUTY 4WD	
F	08-22	PICKUP, F-450 SUPERDUTY 4 X 4	
F	08-22	PICKUP, F-550 SUPERDUTY 4 X 4	

ProGuard, Steering Dampers, Max Control

Shock	POP	Alternative No.	MTG Acc. Supplied
Pos.	Year	Application	
Max Control			
77375 B 140780			
F	96-02	CHEVROLET VAN 1 TON, G / EXPRESS All	
F	96-02	VAN 3/4 TON, G / EXPRESS All Exc. 8600# GVW	
F	96-02	GMC VAN 1 TON, G / SAVANA All	
F	96-02	VAN 3/4 TON, G / SAVANA All Exc. 8600# GVW	
77403 B			
R	79-95	CHEVROLET VAN 1 TON, G / EXPRESS All 9200# GVW	
F	85	VAN 1 TON, P SERIES All Motorhome Chassis w/ I-Beam Front Suspension	
R	79-95	GMC VAN 1 TON, G / SAVANA Cutaway Van 9200# GVW	
F	85	VAN 1 TON, P SERIES All Motorhome Chassis w/ I-Beam Front Suspension	
77412 A			
R	77-86	CHEVROLET PICKUP 1 TON, K30 All	
R	90-91	PICKUP 1 TON, R3500 All	
R	89	PICKUP 1 TON, R3500 Cab & Chassis, RWD	
R	89	PICKUP 1 TON, R3500 Crew Cab Pickup, RWD	
R	01-09	PICKUP 1 TON, SILVERADO 3500 All	
R	08-10	PICKUP 1 TON, SILVERADO 3500 HD All	
R	07	PICKUP 1 TON, SILVERADO 3500 HD All Classic	
R	87-88	PICKUP 1 TON, V30 All	
R	89-91	PICKUP 1 TON, V3000 / V3500 All	
R	99-08	PICKUP 3/4 TON, SILVERADO 2500 All	
R	01-10	PICKUP 3/4 TON, SILVERADO 2500 HD All	
R	07	SILVERADO 2500 HD CLASSIC All	
R	77-86	GMC PICKUP 1 TON, K35 / K3500 All	
R	87-91	PICKUP 1 TON, V3000 / V3500 All	
R	99-04	SIERRA 2500 All	
R	01-10	SIERRA 2500 HD All	
R	07	SIERRA 2500 HD CLASSIC 4WD	
R	01-06	SIERRA 3500 All	
R	07	SIERRA 3500 CLASSIC All	
R	07-10	SIERRA 3500 HD All	
R	11-18	RAM 1500 (SEE DODGE RAM 1500) All	
R	19-20	1500 CLASSIC All	
77414 C 140780			
F	97	FORD F-250 HD 4WD	
F	80-97	PICKUP 1 TON, F-350 / SUPERDUTY RWD	
F	97	PICKUP 3/4 TON, F-250 / SUPERDUTY RWD Over 8500# GVW	
F	80-96	PICKUP 3/4 TON, F-250 / SUPERDUTY RWD	
77455 D			
F	86-97	FORD PICKUP 1 TON, F-350 / SUPERDUTY 4WD	
F	97-98	PICKUP 3/4 TON, F-250 / SUPERDUTY 4WD Over 8500# GVW	
F	87-96	PICKUP 3/4 TON, F-250 / SUPERDUTY 4WD	
77461 C			
R	97	FORD F-250 HD 4WD	
R	86-97	PICKUP 1 TON, F-350 / SUPERDUTY 4WD Dual Rear Wheels	
R	82-85	PICKUP 1 TON, F-350 / SUPERDUTY 4WD Clevis Type Lower Front Mount; Exc. Dual Rear Wheels or Lift Kit	
R	80-81	PICKUP 1 TON, F-350 / SUPERDUTY 4WD	
R	97	PICKUP 3/4 TON, F-250 / SUPERDUTY 4WD Over 8500# GVW	
R	87-96	PICKUP 3/4 TON, F-250 / SUPERDUTY 4WD	
R	82-86	PICKUP 3/4 TON, F-250 / SUPERDUTY 4WD Clevis Type Lower Front Mount; Exc. Dual Rear Wheels or Lift Kit	

Numerical listing

Shock	POP	Alternative No.	MTG Acc. Supplied
Pos.	Year	Application	
77461 C (cont)			
R	80-81	PICKUP 3/4 TON, F-250 / SUPERDUTY 4WD	
R	99-04	PICKUP, F-450 SUPERDUTY All	
R	99-04	PICKUP, F-550 SUPERDUTY All	
77488 B			
R	91-00	CHEVROLET PICKUP 1 TON, C35/3500 All	
R	89-90	PICKUP 1 TON, C35/3500 Extended Cab Pickup	
R	89-90	PICKUP 1 TON, C35/3500 Standard Cab Pickup	
R	88	PICKUP 1 TON, C35/3500 Extended Cab Pickup Exc. HD Straight Front Axle	
R	88	PICKUP 1 TON, C35/3500 Standard Cab Pickup Exc. HD Straight Front Axle	
R	88-00	PICKUP 1 TON, K35 / K3500 All	
R	88-00	PICKUP 3/4 TON, C25 / C2500 All	
R	88-00	PICKUP 3/4 TON, K25 / K2500 All	
R	91-00	GMC PICKUP 1 TON, C35/3500 All	
R	88-90	PICKUP 1 TON, C35/3500 Extended Cab Pickup Exc. HD Straight Front Axle	
R	88-90	PICKUP 1 TON, C35/3500 Standard Cab Pickup Exc. HD Straight Front Axle	
R	88-00	PICKUP 1 TON, K35 / K3500 All	
R	88-00	PICKUP 3/4 TON, C25 / C2500 All	
R	88-00	PICKUP 3/4 TON, K25 / K2500 All	
77489 C			
F	98-00	CHEVROLET PICKUP 1 TON, C35/3500 All Exc. HD Straight Front Axle	
F	92-97	PICKUP 1 TON, C35/3500 Crew Cab Pickup Exc. HD Straight Front Axle	
F	88-97	PICKUP 1 TON, C35/3500 Extended Cab Pickup Exc. HD Straight Front Axle	
F	88-97	PICKUP 1 TON, C35/3500 Standard Cab Pickup Exc. HD Straight Front Axle	
F	88-00	PICKUP 3/4 TON, C25 / C2500 All	
F	92-00	GMC PICKUP 1 TON, C35/3500 Crew Cab Pickup Exc. HD Straight Front Axle	
F	88-00	PICKUP 1 TON, C35/3500 Extended Cab Pickup Exc. HD Straight Front Axle	
F	88-00	PICKUP 1 TON, C35/3500 Standard Cab Pickup Exc. HD Straight Front Axle	
F	88-00	PICKUP 3/4 TON, C25 / C2500 All	
77607 D 140719			
R	00-05	FORD EXCURSION RWD	
77609 B			
F	88-00	CHEVROLET PICKUP 1 TON, K35 / K3500 All	
F	88-00	PICKUP 3/4 TON, K25 / K2500 All	
F	88-00	GMC PICKUP 1 TON, K35 / K3500 All	
F	88-00	PICKUP 3/4 TON, K25 / K2500 All	
77614 B 140780			
F	00-02	FORD E-450 ECONOLINE SUPER DUTY All	
F	96-99	ECONOLINE SUPER DUTY All	
F	00-05	EXCURSION RWD	
F	21-24	VAN 1 TON, ECONOLINE / CLUB WAGON / SUPERDUTY All	
F	07-19	VAN 1 TON, ECONOLINE / CLUB WAGON / SUPERDUTY All Exc. Cutaway Chassis	
F	99-19	VAN 1 TON, ECONOLINE / CLUB WAGON / SUPERDUTY All	
F	92-05	VAN 1 TON, ECONOLINE / CLUB WAGON / SUPERDUTY All Cutaway Chassis	
F	92-14	VAN 3/4 TON, ECONOLINE / CLUB WAGON / SUPERDUTY All	
77623 C 142731			
R	00-02	FORD E-450 ECONOLINE SUPER DUTY All	
R	00-02	E-450 ECONOLINE SUPER DUTY All Exc. Cutaway Chassis	
R	96-99	ECONOLINE SUPER DUTY All	
R	21-24	VAN 1 TON, ECONOLINE / CLUB WAGON / SUPERDUTY All	

Numerical listing

Shock	POP	Alternative No.	MTG Acc. Supplied
Pos.	Year	Application	
77623	C (cont)	142731	
R	03-19	VAN 1 TON, ECONOLINE / CLUB WAGON / SUPERDUTY All Exc. Cutaway Chassis	
R	07-08	VAN 1 TON, ECONOLINE / CLUB WAGON / SUPERDUTY All	
R	92-05	VAN 1 TON, ECONOLINE / CLUB WAGON / SUPERDUTY All Cutaway Chassis	
R	99-03	VAN 1 TON, ECONOLINE / CLUB WAGON / SUPERDUTY All	
R	92-14	VAN 3/4 TON, ECONOLINE / CLUB WAGON / SUPERDUTY All	
77638	C		
R	09-22	CHEVROLET EXPRESS 4500 All	
R	03-22	VAN 1 TON, G / EXPRESS All	
R	03-20	VAN 3/4 TON, G / EXPRESS All	
R	96-02	VAN 3/4 TON, G / EXPRESS All Exc. 8600# GVW	
R	10-20	GMC SAVANA 4500 All	
R	04-22	VAN 1 TON, G / SAVANA All	
R	96-02	VAN 1 TON, G / SAVANA All Exc. 8600# GVW	
R	96	VAN 1 TON, G / SAVANA All 7100, 7400 and 8600# GVW	
R	03-22	VAN 3/4 TON, G / SAVANA All	
R	96-02	VAN 3/4 TON, G / SAVANA All Exc. 8600# GVW	
77661	C		
F	94-02	DODGE PICKUP 1 TON, RAM 3500 (SEE RAM 3500) RWD Exc. Solid Front Axle	
F	94-02	PICKUP 3/4 TON, RAM 2500 (SEE RAM 2500) RWD	
77662	B		
R	79-89	CHEVROLET VAN 3/4 TON, P SERIES All	
R	94-02	DODGE PICKUP 1 TON, RAM 3500 (SEE RAM 3500) RWD Exc. Solid Front Axle	
R	94-02	PICKUP 3/4 TON, RAM 2500 (SEE RAM 2500) All Exc. 8800# GVW	
R	75-99	GMC VAN 1 TON, P SERIES All	
R	73-74	VAN 1 TON, P SERIES Base Cutaway Chassis	
R	74	VAN 1 TON, P SERIES Motorhome	
77673	C	142731	
F	94-02	DODGE PICKUP 3/4 TON, RAM 2500 (SEE RAM 2500) 4WD Exc. 8800# GVW	
77674	C	142731	
F	94-02	DODGE PICKUP 1 TON, RAM 3500 (SEE RAM 3500) 4WD	
F	94-02	PICKUP 1 TON, RAM 3500 (SEE RAM 3500) RWD Solid Front Axle	
F	94-02	PICKUP 3/4 TON, RAM 2500 (SEE RAM 2500) 4WD 8800# GVW	
77675	C		
R	94-02	DODGE PICKUP 1 TON, RAM 3500 (SEE RAM 3500) 4WD	
R	94-02	PICKUP 1 TON, RAM 3500 (SEE RAM 3500) RWD Solid Front Axle	
R	94-02	PICKUP 3/4 TON, RAM 2500 (SEE RAM 2500) 4WD 8800# GVW	
77714	C	142731	
F	96-99	FORD PICKUP 3/4 TON, F-250 / SUPERDUTY RWD Up through 8500# GVW	
77715	C	142700	
R	97-99	FORD PICKUP 3/4 TON, F-250 / SUPERDUTY 4WD Up through 8500# GVW	
77716	C	142731	
F	97-99	FORD PICKUP 3/4 TON, F-250 / SUPERDUTY 4WD Up through 8500# GVW	
77783	C	141665	
F	99-04	CHEVROLET PICKUP 3/4 TON, SILVERADO 2500 RWD Exc. Electronic Adjustable Suspension	
F	01-04	PICKUP 3/4 TON, SILVERADO 2500 HD RWD	
F	99-04	GMC SIERRA 2500 RWD Exc. Electronic Adjustable Suspension	
F	01-04	SIERRA 2500 HD RWD	

Max Control

Shock	POP	Alternative No.	MTG Acc. Supplied
Pos.	Year	Application	
77807	C	142617	
F	99-22	FORD PICKUP 1 TON, F-350 / SUPERDUTY RWD	
F	11-16	PICKUP 1 TON, F-350 / SUPERDUTY All	
F	99-09	PICKUP 1 TON, F-350 / SUPERDUTY All	
F	99-22	PICKUP 3/4 TON, F-250 / SUPERDUTY RWD	
77808	D		
R	99-04	FORD PICKUP 1 TON, F-350 / SUPERDUTY RWD	
R	99-04	PICKUP 3/4 TON, F-250 / SUPERDUTY RWD	
77809	B		
F	00-05	FORD EXCURSION 4WD	
R	97	F-250 HD All	
F	99-04	PICKUP 1 TON, F-350 / SUPERDUTY 4WD	
R	80-97	PICKUP 1 TON, F-350 / SUPERDUTY RWD Exc. Dual Rear Wheels	
F	99-04	PICKUP 3/4 TON, F-250 / SUPERDUTY 4WD	
R	97	PICKUP 3/4 TON, F-250 / SUPERDUTY RWD Over 8500# GVW	
R	80-96	PICKUP 3/4 TON, F-250 / SUPERDUTY RWD	
F	99-04	PICKUP, F-450 SUPERDUTY All	
F	99-04	PICKUP, F-550 SUPERDUTY All	
77810	C		
R	99-04	FORD PICKUP 1 TON, F-350 / SUPERDUTY 4WD	
R	99-04	PICKUP 3/4 TON, F-250 / SUPERDUTY 4WD	
77817	A	141665	
F	01-09	CHEVROLET PICKUP 1 TON, SILVERADO 3500 All	
F	07-10	PICKUP 1 TON, SILVERADO 3500 HD All	
F	05-08	PICKUP 3/4 TON, SILVERADO 2500 All	
F	99-04	PICKUP 3/4 TON, SILVERADO 2500 4WD	
F	01-10	PICKUP 3/4 TON, SILVERADO 2500 HD All 9200# GVW	
F	07	SILVERADO 2500 HD CLASSIC All	
F	99-04	GMC SIERRA 2500 4WD	
F	01-10	SIERRA 2500 HD 4WD	
F	01-06	SIERRA 3500 All	
F	07-10	SIERRA 3500 HD Torsion Bar (FrontSpringType)	
77837	C		
R	00-05	FORD EXCURSION 4WD	
77948	B	142731	
F	07-10	DODGE PICKUP 1 TON, RAM 3500 (SEE RAM 3500) 4WD	
F	06	PICKUP 1 TON, RAM 3500 (SEE RAM 3500) 4WD Exc. 5.9L	
F	03-05	PICKUP 1 TON, RAM 3500 (SEE RAM 3500) 4WD	
F	07-10	PICKUP 3/4 TON, RAM 2500 (SEE RAM 2500) 4WD	
F	06	PICKUP 3/4 TON, RAM 2500 (SEE RAM 2500) 4WD, 4.7L 8Cyl V (287), 3.66 93.0(Bore)3.41 86.5(Stroke)	
F	06	PICKUP 3/4 TON, RAM 2500 (SEE RAM 2500) 4WD, 5.9L 6Cyl L (359), 4.02 102.0(Bore)4.72 120.0(Stroke)	
F	03-05	PICKUP 3/4 TON, RAM 2500 (SEE RAM 2500) 4WD	
F	15-18	RAM 2500 (SEE DODGE RAM 2500) Power Wagon	
F	11-14	2500 (SEE DODGE RAM 2500) 4WD	
F	11-15	3500 (SEE DODGE RAM 3500) 4WD	
77949	C	143000	
F	03-10	DODGE PICKUP 1 TON, RAM 3500 (SEE RAM 3500) RWD	
F	03-10	PICKUP 3/4 TON, RAM 2500 (SEE RAM 2500) RWD	
F	14-15	RAM 2500 (SEE DODGE RAM 2500) RWD	
F	11-13	2500 (SEE DODGE RAM 2500) Standard Cab Pickup, RWD	
F	11-15	3500 (SEE DODGE RAM 3500) RWD	

Numerical listing

Shock	POP	Alternative No.	MTG Acc. Supplied
Pos.	Year	Application	
77950	B		
R	03-10	DODGE PICKUP 1 TON, RAM 3500 (SEE RAM 3500) All	
R	03-10	PICKUP 3/4 TON, RAM 2500 (SEE RAM 2500) All	
R	11-13	RAM 2500 (SEE DODGE RAM 2500) All	
R	11-13	3500 (SEE DODGE RAM 3500) All	
77951	A	142731	
F	05-22	FORD PICKUP 1 TON, F-350 / SUPERDUTY 4WD	
F	11-16	PICKUP 1 TON, F-350 / SUPERDUTY All 4WD	
F	99-09	PICKUP 1 TON, F-350 / SUPERDUTY All 4WD	
F	01-22	PICKUP 3/4 TON, F-250 / SUPERDUTY 4WD	
F	99	PICKUP 3/4 TON, F-250 / SUPERDUTY 4WD	
77952	A		
R	13-16	FORD PICKUP 1 TON, F-350 / SUPERDUTY 4WD	
R	05-12	PICKUP 1 TON, F-350 / SUPERDUTY Crew Cab Pickup, 4WD Single Rear Wheels	
R	05-12	PICKUP 1 TON, F-350 / SUPERDUTY Extended Cab Pickup, 4WD Single Rear Wheels	
R	05-12	PICKUP 1 TON, F-350 / SUPERDUTY Standard Cab Pickup, 4WD Single Rear Wheels	
R	05-16	PICKUP 3/4 TON, F-250 / SUPERDUTY 4WD	
77967	C	143146	
F	13-23	FORD PICKUP, F-450 SUPERDUTY All	
F	05-08	PICKUP, F-450 SUPERDUTY All	
F	13-23	PICKUP, F-550 SUPERDUTY All	
F	05-07	PICKUP, F-550 SUPERDUTY All	
77968	D		
R	13-16	FORD PICKUP, F-450 SUPERDUTY 4 X 2	
R	05-07	PICKUP, F-450 SUPERDUTY 4 X 2	
R	13-16	PICKUP, F-550 SUPERDUTY 4 X 2	
R	05-07	PICKUP, F-550 SUPERDUTY 4 X 2	
77969	D		
R	13-16	FORD PICKUP, F-450 SUPERDUTY 4 X 4	
R	05-07	PICKUP, F-450 SUPERDUTY 4 X 4	
R	13-16	PICKUP, F-550 SUPERDUTY 4 X 4	
R	05-07	PICKUP, F-550 SUPERDUTY 4 X 4	
77976	B		
R	11-23	CHEVROLET PICKUP 1 TON, SILVERADO 3500 HD All	
R	11-23	PICKUP 3/4 TON, SILVERADO 2500 HD All	
R	11-21	GMC SIERRA 2500 HD All	
R	11-21	SIERRA 3500 HD All	
R	14-20	RAM 3500 (SEE DODGE RAM 3500) 4WD	
77980	D	142731	
F	06	DODGE PICKUP 1 TON, RAM 3500 (SEE RAM 3500) 4WD, 5.7L 8Cyl V (345), 3.92 99.57(Bore)3.58 90.93(Stroke)	
F	06	PICKUP 3/4 TON, RAM 2500 (SEE RAM 2500) 4WD, 5.7L 8Cyl V (345), 3.92 99.57(Bore)3.58 90.93(Stroke)	
77986	N		
R	17-23	FORD PICKUP, F-450 SUPERDUTY All Models with 4WD and OEM number	
R	17-23	PICKUP, F-550 SUPERDUTY All Models with 4WD and OEM number	
77987	N		
R	17-23	FORD PICKUP, F-450 SUPERDUTY All Models with RWD and OEM number	
R	17-23	PICKUP, F-550 SUPERDUTY All Models with RWD and OEM number	
77988	N		
R	17-23	FORD PICKUP 1 TON, F-350 / SUPERDUTY 4WD	
R	17-23	PICKUP 3/4 TON, F-250 / SUPERDUTY 4WD	

Numerical listing

Shock	POP	Alternative No.	MTG Acc. Supplied
Pos.	Year	Application	
Guardian Shock			
81039	A		140357
F	75-86	CHEVROLET PICKUP 1 TON, C30 All	
F	88-91	PICKUP 1 TON, C35/3500 Cab & Chassis Exc. HD Solid Front Axle	
F	87-88	PICKUP 1 TON, R30 All	
F	89-91	PICKUP 1 TON, R3500 All	
F	63-86	PICKUP 3/4 TON, C20 All	
F	87-88	PICKUP 3/4 TON, R20 All	
F	89	PICKUP 3/4 TON, R2500 All	
F	68-90	VAN 1 TON, P SERIES All Cutaway Chassis	
F	68-89	VAN 3/4 TON, P SERIES All	
F	88-91	GMC PICKUP 1 TON, C35/3500 Cab & Chassis	
F	80-86	PICKUP 1 TON, C35/3500 All	
F	67-78	PICKUP 1 TON, C35/3500 All	
F	87-91	PICKUP 1 TON, R3500 All	
F	83-86	PICKUP 3/4 TON, C25 / C2500 All	
F	75-82	PICKUP 3/4 TON, C25 / C2500 Cab & Chassis	
F	75-82	PICKUP 3/4 TON, C25 / C2500 Crew Cab Pickup	
F	75-82	PICKUP 3/4 TON, C25 / C2500 Standard Cab Pickup	
F	67-74	PICKUP 3/4 TON, C25 / C2500 All	
F	87-89	PICKUP 3/4 TON, R2500 All Exc. Crew Cab & Bonus Cab	
F	66	PICKUP 2500 SERIES All	
F	75-90	VAN 1 TON, P SERIES All Cutaway Chassis	
F	73-74	VAN 1 TON, P SERIES Base Cutaway Chassis	
F	68-72	VAN 1 TON, P SERIES All	
F	68-89	VAN 3/4 TON, P SERIES All	
81082	C		
R	97	FORD F-250 HD RWD	
R	80-97	PICKUP 1 TON, F-350 / SUPERDUTY RWD Exc. Dual Rear Wheels	
R	97	PICKUP 3/4 TON, F-250 / SUPERDUTY RWD Over 8500# GVW	
R	80-96	PICKUP 3/4 TON, F-250 / SUPERDUTY RWD	
81091	B		
R	72-93	DODGE PICKUP 1 TON, D300 SERIES All	
R	72-93	PICKUP 3/4 TON, D200 SERIES All	
81096	B		140126
F	72-93	DODGE PICKUP 3/4 TON, D200 SERIES All Exc. Heavy Duty Package	
F	95-03	VAN 1 TON, A / B SERIES / RAM All	
F	71-94	VAN 1 TON, A / B SERIES / RAM All Exc. 4000# Front Axle	
F	71-03	VAN 3/4 TON, A / B SERIES / RAM All	
F	74-80	VAN, CB300 All Exc. 4000# Front Axle	
F	74-83	PLYMOUTH VAN 1 TON, PB SERIES All Exc. 4000# Front Axle	
F	74-83	VAN 3/4 TON, PB SERIES All	
81113	C		
F	81-86	CHEVROLET PICKUP 3/4 TON, K20 All Standard Suspension; Exc. Lift Kit	
F	69-80	PICKUP 3/4 TON, K20 All Exc. Lift Kit	
F	69-86	GMC PICKUP 3/4 TON, K25 / K2500 All Exc. Quad Suspension and Lift Kit	
F	87	PICKUP 3/4 TON, V2500 All Quad Suspension Short Shock; Exc. Lift Kit	
81147	A		
F	61-66	FORD PICKUP 1 TON, F-350 / SUPERDUTY All	
F	61-64	PICKUP 3/4 TON, F-250 / SUPERDUTY All	
F	68-75	PICKUP P350 All Up through 8000# GVW	
F	75-76	PICKUP P400 All Up through 8000# GVW	
F	68	INTERNATIONAL 1200C All Exc. 166" Wheelbase	
R	68	1200C All Exc. 166" Wheelbase	
F	68	1300C All Exc. 166" Wheelbase	
R	68	1300C All Exc. 166" Wheelbase	

Guardian Shock

Shock	POP	Alternative No.	MTG Acc. Supplied
Pos.	Year	Application	
81147	A (cont)		
R	68-72	M1100 / M1200 All	
R	69	M1400 All	
81164	B		140357
R	75-86	CHEVROLET PICKUP 3/4 TON, C20 Standard Cab Pickup	
R	73-74	PICKUP 3/4 TON, C20 All Standard Cab Pickup	
R	73-86	PICKUP 3/4 TON, K20 All Exc. Lift Kit	
R	87	PICKUP 3/4 TON, R20 Standard Cab Pickup	
R	87	PICKUP 3/4 TON, V20 All Exc. Quad Suspension and Lift Kit	
R	73-78	VAN 3/4 TON, P SERIES All	
R	83-86	GMC PICKUP 3/4 TON, C25 / C2500 All	
R	75-82	PICKUP 3/4 TON, C25 / C2500 Cab & Chassis	
R	75-82	PICKUP 3/4 TON, C25 / C2500 Standard Cab Pickup	
R	73-86	PICKUP 3/4 TON, K25 / K2500 All Exc. Lift Kit	
R	88-89	PICKUP 3/4 TON, R2500 All Exc. Crew Cab & Bonus Cab	
R	87	PICKUP 3/4 TON, R2500 Cab & Chassis Exc. Crew Cab & Bonus Cab	
R	87	PICKUP 3/4 TON, R2500 Standard Cab Pickup Exc. Crew Cab & Bonus Cab	
R	87	PICKUP 3/4 TON, V2500 All Exc. Lift Kit	
R	73-78	VAN 3/4 TON, P SERIES All	
81242	B		140126
R	75-79	FORD PICKUP 1 TON, F-350 / SUPERDUTY Extended Cab Pickup, RWD	
R	75-79	PICKUP 3/4 TON, F-250 / SUPERDUTY Cab & Chassis, RWD	
R	75-79	PICKUP 3/4 TON, F-250 / SUPERDUTY Standard Cab Pickup, RWD	
R	73-74	PICKUP 3/4 TON, F-250 / SUPERDUTY RWD Exc. Supercab	
R	70-72	PICKUP 3/4 TON, F-250 / SUPERDUTY All RWD; Exc. Supercab	
81270	A		140523
R	60	FORD PICKUP 1 TON, F-350 / SUPERDUTY All	
R	60	PICKUP 3/4 TON, F-250 / SUPERDUTY All	
81342	C		
R	81-93	DODGE PICKUP 1 TON, W300 SERIES All Exc. Quad Suspension and Lift Kit	
R	72-80	PICKUP 1 TON, W300 SERIES All	
R	90-93	PICKUP 3/4 TON, W200 SERIES Extended Cab Pickup Exc. Lift Kit	
R	88-93	PICKUP 3/4 TON, W200 SERIES Cab & Chassis Exc. Lift Kit	
R	81-93	PICKUP 3/4 TON, W200 SERIES Standard Cab Pickup Exc. Lift Kit	
R	86	PICKUP 3/4 TON, W200 SERIES Cab & Chassis Exc. Lift Kit	
R	81-83	PICKUP 3/4 TON, W200 SERIES Cab & Chassis Exc. Lift Kit	
R	81-82	PICKUP 3/4 TON, W200 SERIES Extended Cab Pickup Exc. Lift Kit	
R	72-80	PICKUP 3/4 TON, W200 SERIES All	
R	78-80	RD200 All	
81394	B		140780
F	67-79	FORD PICKUP 1 TON, F-350 / SUPERDUTY All Quad Suspension Rearward of Front Axle	
F	65-79	PICKUP 3/4 TON, F-250 / SUPERDUTY All Quad Suspension Rearward of Front Axle	
F	75-91	VAN 1 TON, ECONOLINE / CLUB WAGON / SUPERDUTY All Exc. Cutaway Chassis	
F	75-91	VAN 1 TON, ECONOLINE / CLUB WAGON / SUPERDUTY All Exc. Cutaway Chassis RWD, 4WD Quad Suspension Rearward of Front Axle, Non Quad Suspension	
F	75-91	VAN 3/4 TON, ECONOLINE / CLUB WAGON / SUPERDUTY All	

Numerical listing

Shock	POP	Alternative No.	MTG Acc. Supplied
Pos.	Year	Application	
81394	B (cont)		140780
F	75-91	VAN 3/4 TON, ECONOLINE / CLUB WAGON / SUPERDUTY All RWD, 4WD Quad Suspension Rearward of Front Axle, Non Quad Suspension	
81484	B		141137
R	75-79	FORD PICKUP 1 TON, F-350 / SUPERDUTY Standard Cab Pickup, RWD	
R	73-74	PICKUP 1 TON, F-350 / SUPERDUTY All RWD; Exc. Supercab	
R	75-79	PICKUP 3/4 TON, F-250 / SUPERDUTY Extended Cab Pickup, RWD	
R	73-74	PICKUP 3/4 TON, F-250 / SUPERDUTY RWD Supercab	
R	65-72	PICKUP 3/4 TON, F-250 / SUPERDUTY All RWD; Supercab	
R	69-74	VAN 1 TON, ECONOLINE / CLUB WAGON / SUPERDUTY All	
R	69-74	VAN 3/4 TON, ECONOLINE / CLUB WAGON / SUPERDUTY All	
81490	B		140780
F	86-90	FORD F-200 All	
F	97	F-250 HD RWD	
F	80-97	PICKUP 1 TON, F-350 / SUPERDUTY RWD	
F	97	PICKUP 3/4 TON, F-250 / SUPERDUTY RWD Over 8500# GVW	
F	80-96	PICKUP 3/4 TON, F-250 / SUPERDUTY RWD	
81496	C		
F	81-86	CHEVROLET PICKUP 3/4 TON, K20 All Quad Suspension Long Shock; Exc. Lift Kit	
F	87	PICKUP 3/4 TON, V20 All Quad Suspension Long Shock; Exc. Lift Kit	
R	78-95	VAN 1 TON, G / EXPRESS Cutaway Van	
R	78-95	VAN 3/4 TON, G / EXPRESS All Exc. 8600# GVW	
R	71-03	DODGE VAN 1 TON, A / B SERIES / RAM All	
R	71-03	VAN 3/4 TON, A / B SERIES / RAM All	
R	74-80	VAN, CB300 All	
F	87-88	GMC PICKUP 1 TON, V3000 / V3500 All Quad Suspension Long Shock; Exc. Lift Kit	
F	81-86	PICKUP 3/4 TON, K25 / K2500 All Quad Suspension Long Shock; Exc. Lift Kit	
F	87	PICKUP 3/4 TON, V2500 All Quad Suspension Long Shock; Exc. Lift Kit	
R	85-96	VAN 1 TON, G / SAVANA Extended Cargo Van	
R	85-96	VAN 1 TON, G / SAVANA Extended Passenger Van	
R	79-96	VAN 1 TON, G / SAVANA Standard Cargo Van	
R	79-96	VAN 1 TON, G / SAVANA Standard Passenger Van	
R	78	VAN 1 TON, G / SAVANA Cutaway Van	
R	78-95	VAN 3/4 TON, G / SAVANA All Exc. 8600# GVW	
R	74-83	PLYMOUTH VAN 1 TON, PB SERIES All	
R	74-83	VAN 3/4 TON, PB SERIES All	
81510	C		
R	97	FORD F-250 HD 4WD	
R	86-97	PICKUP 1 TON, F-350 / SUPERDUTY 4WD Dual Rear Wheels	
R	82-85	PICKUP 1 TON, F-350 / SUPERDUTY 4WD Clevis Type Lower Front Mount; Exc. Dual Rear Wheels or Lift Kit	
R	80-81	PICKUP 1 TON, F-350 / SUPERDUTY 4WD	
R	97	PICKUP 3/4 TON, F-250 / SUPERDUTY 4WD Over 8500# GVW	
R	86-96	PICKUP 3/4 TON, F-250 / SUPERDUTY 4WD	
R	82-85	PICKUP 3/4 TON, F-250 / SUPERDUTY 4WD Clevis Type Lower Front Mount; Exc. Dual Rear Wheels or Lift Kit	

Numerical listing

Shock	POP	Alternative No.	MTG Acc. Supplied
Pos.	Year	Application	
81510	C (cont)		
R	80-81	PICKUP 3/4 TON, F-250 / SUPERDUTY 4WD	
81667	B		
R	88-00	CHEVROLET PICKUP 1 TON, C35/3500 Extended Cab Pickup Exc. HD Straight Front Axle	
R	88-00	PICKUP 1 TON, C35/3500 Standard Cab Pickup Exc. HD Straight Front Axle	
R	88-00	PICKUP 1 TON, K35 / K3500 All	
R	88-00	PICKUP 3/4 TON, C25 / C2500 All	
R	88-00	PICKUP 3/4 TON, K25 / K2500 All	
R	89-00	GMC PICKUP 1 TON, C35/3500 Extended Cab Pickup Exc. HD Straight Front Axle	
R	88-00	PICKUP 1 TON, C35/3500 Standard Cab Pickup Exc. HD Straight Front Axle	
R	88-00	PICKUP 1 TON, K35 / K3500 All	
R	88-00	PICKUP 3/4 TON, C25 / C2500 All	
R	88-00	PICKUP 3/4 TON, K25 / K2500 All	
81668	B	141277	
F	92-00	CHEVROLET PICKUP 1 TON, C35/3500 All Exc. HD Straight Front Axle	
F	88-91	PICKUP 1 TON, C35/3500 Extended Cab Pickup Exc. HD Straight Front Axle	
F	88-91	PICKUP 1 TON, C35/3500 Standard Cab Pickup Exc. HD Straight Front Axle	
F	88-00	PICKUP 3/4 TON, C25 / C2500 All	
F	88-00	GMC PICKUP 1 TON, C35/3500 All Exc. HD Straight Front Axle	
F	88-00	PICKUP 3/4 TON, C25 / C2500 All	
81676	A		
R	53-55	FORD PICKUP 1 TON, F-350 / SUPERDUTY All	
R	53-55	PICKUP 3/4 TON, F-250 / SUPERDUTY All	
81710	B		
R	80-97	FORD PICKUP 1 TON, F-350 / SUPERDUTY RWD Dual Rear Wheels	
81713	C	140800	
F	96-02	CHEVROLET VAN 1 TON, G / EXPRESS All	
F	96-02	VAN 3/4 TON, G / EXPRESS All Exc. 8600# GVW	
F	96-02	GMC VAN 1 TON, G / SAVANA All	
F	96-02	VAN 3/4 TON, G / SAVANA All Exc. 8600# GVW	
81726	C		
F	88-00	CHEVROLET PICKUP 1 TON, K35 / K3500 All	
F	88-00	PICKUP 3/4 TON, K25 / K2500 All	
F	88-00	GMC PICKUP 1 TON, K35 / K3500 All	
F	88-00	PICKUP 3/4 TON, K25 / K2500 All	
81744	A	140780	
F	21-24	FORD VAN 1 TON, ECONOLINE / CLUB WAGON / SUPERDUTY All	
F	92-19	VAN 1 TON, ECONOLINE / CLUB WAGON / SUPERDUTY All	
F	92-14	VAN 3/4 TON, ECONOLINE / CLUB WAGON / SUPERDUTY All	
81821	C		
F	97	FORD F-250 HD 4WD	
F	86-97	PICKUP 1 TON, F-350 / SUPERDUTY 4WD	
F	97	PICKUP 3/4 TON, F-250 / SUPERDUTY 4WD Over 8500# GVW	
F	87-96	PICKUP 3/4 TON, F-250 / SUPERDUTY 4WD	
81825	C		
F	81-93	DODGE PICKUP 1 TON, W300 SERIES All Exc. Quad Suspension and Lift Kit	
F	61-80	PICKUP 1 TON, W300 SERIES All	
R	61-71	PICKUP 1 TON, W300 SERIES All	
F	90-93	PICKUP 3/4 TON, W200 SERIES Extended Cab Pickup Exc. Lift Kit	
F	88-93	PICKUP 3/4 TON, W200 SERIES Cab & Chassis Exc. Lift Kit	

Guardian Shock, Classic Shock Absorbers

Shock	POP	Alternative No.	MTG Acc. Supplied
Pos.	Year	Application	
81825	C (cont)		
F	81-93	PICKUP 3/4 TON, W200 SERIES Standard Cab Pickup Exc. Lift Kit	
F	86	PICKUP 3/4 TON, W200 SERIES Cab & Chassis Exc. Lift Kit	
F	81-83	PICKUP 3/4 TON, W200 SERIES Cab & Chassis Exc. Lift Kit	
F	81-82	PICKUP 3/4 TON, W200 SERIES Extended Cab Pickup Exc. Lift Kit	
F	69-80	PICKUP 3/4 TON, W200 SERIES All	
F	61-67	PICKUP 3/4 TON, W200 SERIES All	
F	78-80	RD200 All	
81828	C	142617	
R	21-24	FORD VAN 1 TON, ECONOLINE / CLUB WAGON / SUPERDUTY All	
R	10-19	VAN 1 TON, ECONOLINE / CLUB WAGON / SUPERDUTY All	
R	04-19	VAN 1 TON, ECONOLINE / CLUB WAGON / SUPERDUTY All Exc. Cutaway Chassis	
R	92-05	VAN 1 TON, ECONOLINE / CLUB WAGON / SUPERDUTY All	
R	92-14	VAN 3/4 TON, ECONOLINE / CLUB WAGON / SUPERDUTY All	
81834	C	140126	
F	72-93	DODGE PICKUP 1 TON, D300 SERIES All Heavy Duty Package	
F	82-93	PICKUP 3/4 TON, D200 SERIES All Heavy Duty Package	
F	75-81	PICKUP 3/4 TON, D200 SERIES 165.0 / 419.1 (WheelBase) Heavy Duty Package	
F	72-74	PICKUP 3/4 TON, D200 SERIES All Heavy Duty Package	
F	71-93	VAN 1 TON, A / B SERIES / RAM All 4000# Front Axle	
F	74-80	VAN, CB300 All 4000# Front Axle	
F	74-83	PLYMOUTH VAN 1 TON, PB SERIES All 4000# Front Axle	
81873	A		
R	94-02	DODGE PICKUP 1 TON, RAM 3500 (SEE RAM 3500) RWD Exc. Solid Front Axle	
R	94-03	PICKUP 3/4 TON, RAM 2500 (SEE RAM 2500) All Exc. 8800# GVW	
81892	C	142700	
R	97-99	FORD PICKUP 3/4 TON, F-250 / SUPERDUTY RWD Up through 8500# GVW	
81912	B	142731	
F	97-99	FORD PICKUP 3/4 TON, F-250 / SUPERDUTY RWD Up through 8500# GVW	
81913	C	142700	
R	97-99	FORD PICKUP 3/4 TON, F-250 / SUPERDUTY 4WD Up through 8500# GVW	
81914	C	142731	
F	97-99	FORD PICKUP 3/4 TON, F-250 / SUPERDUTY 4WD Up through 8500# GVW	
81919	C	142731	
F	99-02	DODGE PICKUP 3/4 TON, RAM 2500 (SEE RAM 2500) 4WD Exc. 8800# GVW	
F	94-95	PICKUP 3/4 TON, RAM 2500 (SEE RAM 2500) 4WD Exc. 8800# GVW	
81920	A	141665	
F	99-04	CHEVROLET PICKUP 3/4 TON, SILVERADO 2500 RWD Exc. Electronic Adjustable Suspension	
F	01-04	PICKUP 3/4 TON, SILVERADO 2500 HD RWD	
F	99-04	GMC SIERRA 2500 RWD Exc. Electronic Adjustable Suspension	
F	01-04	SIERRA 2500 HD RWD	
81921	A		
R	77-86	CHEVROLET PICKUP 1 TON, K30 All	
R	90-91	PICKUP 1 TON, R3500 All	
R	89	PICKUP 1 TON, R3500 Cab & Chassis, RWD	
R	89	PICKUP 1 TON, R3500 Crew Cab Pickup, RWD	
R	01-09	PICKUP 1 TON, SILVERADO 3500 All	

Numerical listing

Shock	POP	Alternative No.	MTG Acc. Supplied
Pos.	Year	Application	
81921	A (cont)		
R	08-10	PICKUP 1 TON, SILVERADO 3500 HD All	
R	87-88	PICKUP 1 TON, V30 All	
R	89-91	PICKUP 1 TON, V3000 / V3500 All	
R	99-08	PICKUP 3/4 TON, SILVERADO 2500 All	
R	01-10	PICKUP 3/4 TON, SILVERADO 2500 HD All	
R	07	SILVERADO 3500 CLASSIC All	
R	94-02	DODGE PICKUP 1 TON, RAM 3500 (SEE RAM 3500) 4WD	
R	94-02	PICKUP 1 TON, RAM 3500 (SEE RAM 3500) RWD Solid Front Axle	
R	94-02	PICKUP 3/4 TON, RAM 2500 (SEE RAM 2500) 4WD 8800# GVW	
R	77-86	GMC PICKUP 1 TON, K35 / K3500 All	
R	87-91	PICKUP 1 TON, V3000 / V3500 All	
R	99-04	SIERRA 2500 All	
R	01-10	SIERRA 2500 HD All	
R	01-06	SIERRA 3500 All	
R	07-10	SIERRA 3500 HD All	
81925	C	141665	
F	01-09	CHEVROLET PICKUP 1 TON, SILVERADO 3500 All	
F	05-08	PICKUP 3/4 TON, SILVERADO 2500 All	
F	99-04	PICKUP 3/4 TON, SILVERADO 2500 4WD	
F	99-04	GMC SIERRA 2500 4WD	
81928	C	143000	
F	94-02	DODGE PICKUP 1 TON, RAM 3500 (SEE RAM 3500) RWD Exc. Solid Front Axle	
F	94-02	PICKUP 3/4 TON, RAM 2500 (SEE RAM 2500) RWD	
Classic Shock Absorbers			
82003	B		
R	67-72	CHEVROLET PICKUP 3/4 TON, C20 All Coil(RearSpringType)	
R	67-72	GMC PICKUP 3/4 TON, C25 / C2500 All Coil(RearSpringType)	
82007	B	140349	
F	68	INTERNATIONAL 1200C All Exc. 166" Wheelbase	
F	68	1300C All Exc. 166" Wheelbase	
F	68-72	M1100 / M1200 All	
F	69	M1400 All	
82012	B		
F	69-74	FORD VAN 1 TON, ECONOLINE / CLUB WAGON / SUPERDUTY All	
F	69-74	VAN 3/4 TON, ECONOLINE / CLUB WAGON / SUPERDUTY All	
82034	C	141138	
F	73-78	FORD PICKUP 3/4 TON, F-250 / SUPERDUTY 4WD Up through Serial No. Y20000	
F	66-72	PICKUP 3/4 TON, F-250 / SUPERDUTY All 4WD; Up through Serial No. Y2000	
F	61-65	PICKUP 3/4 TON, F-250 / SUPERDUTY All 4WD	
82035	B	140357	
F	60-62	CHEVROLET PICKUP 3/4 TON, C20 All	
F	61-62	GMC PICKUP 2500 SERIES All	
82047	B	140630	
F	61-67	CHEVROLET VAN 1 TON, P SERIES All	
F	61-67	VAN 3/4 TON, P SERIES All	
F	67	GMC VAN 1 TON, P SERIES All	
F	67	VAN 3/4 TON, P SERIES All	
82065	C	140478	
R	74	DODGE M300 All	
R	74	M350 All	
R	61-71	PICKUP 1 TON, D300 SERIES All	
F	60	PICKUP 3/4 TON, D200 SERIES All	
F	60	PICKUP 3/4 TON, W200 SERIES All	
R	66-72	VAN 1 TON, P SERIES All	
R	61-64	VAN 1 TON, P SERIES All	
82086	B		
R	60-62	CHEVROLET PICKUP 3/4 TON, C20 All	

Numerical listing

Shock	POP	Alternative No.	MTG Acc. Supplied
Pos.	Year	Application	
82147	C		
R	75-77	FORD PICKUP 3/4 TON, F-250 / SUPERDUTY 4WD Up through Serial No. Y2000	
R	66-74	PICKUP 3/4 TON, F-250 / SUPERDUTY All 4WD; Up through Serial No. Y2000	
82155	A		141041
R	61-62	CHEVROLET VAN 1 TON, P SERIES All	
R	61-62	VAN 3/4 TON, P SERIES All	
83000 Series			
83101	C		
F	13	INTERNATIONAL 4300LP All Models with O.E.M. Number	
83107	D		145080 (2)
F	94-97	FORD F-700 All w/ Multileaf Spring and w/ 10000, 12000 or 13200 lb Axle	
F	94	F-800 All w/ Multileaf Spring and w/ 10000, 12000 or 13200 lb Axle	
83114	D		140780 (1)
F	99	ISUZU FRR	
F	00-03	FRR All	
F	95-98	FRR All	
F	86	FSR	
F	87-96	FSR All FSR Models	
F	88-94	NRR All	
F	89-94	UD 1800 All Models with O.E.M. Number	
F	99-04	1800CS All Models with O.E.M. Number	
F	89-94	2000 All Models with O.E.M. Number	
83120	D		145089-000(1)/145143(1)
R	05-22	FREIGHTLINER B2 All Models with 15,000 lb Rear Suspension	
R	95-05	FL50 All Models with 15,000 lb Rear Suspension	
R	91-05	FL60 All w/ 15000 lb Rear Suspension	
R	98-20	MT45 All Models with O.E.M. Number	
R	99-11	MT55 All Models with O.E.M. Number	
R		VARIOUS	
R	03-10	STERLING TRUCK ACTERRA All Models with 15000 lb Rear Suspension	
R	01-07	ACTERRA 5500 All Models with 15000 lb Rear Suspension	
R	01-07	ACTERRA 6500 All Models with 15000 lb Rear Suspension	
R		UPS TRUCK VARIOUS	
83122	C		
R	97-09	CHEVROLET C7500 KODIAK All Models with Hendrickson Air Suspension (Stamping number 47902-13)	
R	99	T6500 All Models with Hendrickson Air Suspension (Stamping number 47902-13)	
R	06-23	FORD F-53	
R	99-04	F-53	
R	99	GMC T6500 All Models with Hendrickson Air Suspension (Stamping number 47902-13)	
R		ISUZU FVR	
83123	C		
R	13-24	KENWORTH K270 All Models with Hendrickson HAS - 210L or HAS - 230L Rear Air Suspension	
R	93-05	K300 All Models with Hendrickson Rear Air Suspension	
R	08-22	T270 All Models with Hendrickson HAS - 210L or HAS - 230L Rear Air Suspension	
R		T300	
R	95-08	T300 All Models with Hendrickson HAS - 210L or HAS - 230L Rear Air Suspension	
R	13-24	PETERBILT 220 All Models with Hendrickson HAS - 210L or HAS - 230L Rear Air Suspension	
R	10	220 All Models with Hendrickson HAS - 210L or HAS - 230L Rear Air Suspension	

Classic Shock Absorbers, 83000 Series

Shock	POP	Alternative No.	MTG Acc. Supplied
Pos.	Year	Application	
83123	C (cont)		
R	07	220 All Models with Hendrickson HAS - 210L or HAS - 230L Rear Air Suspension	
83125	C		
F	94	FORD B-700 All Models with with 14600 lb Multileaf Spring	
F	94	F-700 All Models with with 14600 lb Multileaf Spring	
F	94	F-800 All Models with with 14600 lb Multileaf Spring	
83126	C		
R	02-23	FREIGHTLINER M2 106 All Models with Reyco 79KB Rear Steel Spring Suspension	
F	05-10	HINO 145 All Models with O.E.M. Number	
F	05-10	165 All Models with O.E.M. Number	
F	05-10	185 All Models with O.E.M. Number	
R	13-24	KENWORTH K270 All Models with Reyco 102 or 79KB Suspension (Drive Axle)	
R	93-05	K300 All Models with Reyco 102 or 79KB Suspension (Drive Axle)	
F	93-05	K300 All Models with Reyco 1209 or 1212 Suspension (Steer Axle)	
R	08-22	T170 All Models with Reyco 79KB Rear Steel Spring Suspension	
R	08-22	T270 All Models with Reyco 102 or 79KB Suspension (Drive Axle)	
R	21-24	T280 All Models with Reyco 102 or 79KB Suspension (Drive Axle)	
F		T300	
R		T300	
R	99-08	T300 All Models with Reyco 102 or 79KB Suspension (Drive Axle)	
R	99-08	T300 All Models with Reyco 1209 or 1212 Suspension (Steer Axle)	
R	08-15	PETERBILT 210 All Models with Reyco 102 or 79KB Suspension (Drive Axle)	
R	13-24	220 All Models with Reyco 102 or 79KB Suspension (Drive Axle)	
R	10	220 All Models with Reyco 102 or 79KB Suspension (Drive Axle)	
R	07	220 All Models with Reyco 102 or 79KB Suspension (Drive Axle)	
R	08-19	325 All Models with Reyco 102 or 79KB Suspension (Drive Axle)	
R	07-22	330 All Models with Reyco 79KB Rear Steel Spring Suspension	
R	95-05	330 All Models with Reyco 79KB Rear Steel Spring Suspension	
83127	C		
F	23	MACK MD6	
F	24	MD6 All Models with 10,000 lb Taperleaf Springs	
F	21-22	MD6 All Models with 10,000 lb Taperleaf Springs	
83134	D		145054 (1)
R	05-21	FREIGHTLINER M2 All Models with Rear 52" Spring, 10000 lb - 15000 lb	
R	05-21	M2 All Models with Rear 52" Spring, 18000 lb - 23000 lb	
R	02-10	M2 100 All Models with Rear 52" Spring, 10000 lb - 15000 lb	
R	02-10	M2 100 All Models with Rear 52" Spring, 18000 lb - 23000 lb	
R	02-23	M2 106 All Models with Rear 52" Spring, 10000 lb - 15000 lb	
R	02-23	M2 106 All Models with Rear 52" Spring, 18000 lb - 23000 lb	
83135	C		
F	19-22	CHEVROLET SILVERADO 4500 HD All Models with 7,000 to 8,000 lb Front Axle	
F	19-22	SILVERADO 5500 HD All Models with 7,000 to 8,000 lb Front Axle	
F	19-22	SILVERADO 6500 HD All Models with 7,000 to 8,000 lb Front Axle	
F	02-20	INTERNATIONAL 4300 All Models with 6,000 to 8,000 lb Front Suspension	
F	02-20	4400 All Models with 6,000 to 8,000 lb Front Suspension	
F	10-12	DURASTAR - 4300, 4400 SERIES	
F	12-18	TERRASTAR All Models with 6,000 to 7,000 lb Front Axle	

Numerical listing

Shock	POP	Alternative No.	MTG Acc. Supplied
Pos.	Year	Application	
83136	C		145054 (2)
F	90-96	CHEVROLET C60 KODIAK All Conventional Cab w/ Front Shock with O.E.M. Number	
R	90-96	C60 KODIAK All Conventional Cab w/19000, 21000, 23000 lb Taperleaf Springs (EXC Low Profile Vehicle)	
F	90-02	C4500 KODIAK	
R	90-02	C4500 KODIAK	
F	03-09	C4500 KODIAK All C Chassis - Conventional Cab	
R	03-09	C4500 KODIAK All C Chassis - Conventional Cab w/19000, 21000, 23000 lb Taperleaf Springs (EXC Low Profile Vehicle)	
F	92-02	C5500 KODIAK	
R	92-02	C5500 KODIAK	
F	03-09	C5500 KODIAK All C Chassis - Conventional Cab	
R	03-09	C5500 KODIAK All C Chassis - Conventional Cab w/19000, 21000, 23000 lb Taperleaf Springs (EXC Low Profile Vehicle)	
F	90-91	C5500 KODIAK All C Chassis - Conventional Cab	
R	90-91	C5500 KODIAK All C Chassis - Conventional Cab w/19000, 21000, 23000 lb Taperleaf Springs (EXC Low Profile Vehicle)	
F	97-09	C7500 KODIAK All Conventional Cab w/ Front Shock with O.E.M. Number	
R	97-09	C7500 KODIAK All Conventional Cab w/19000, 21000, 23000 lb Taperleaf Springs (EXC Low Profile Vehicle)	
R	92-96	P60 All Motorhome Chassis	
R	92-96	P6000 All Motorhome Chassis	
F	04-09	T6500 All FL1 Tilt Cab with 8100 lb Axle	
F	04-09	T6500 All FL2 Tilt Cab with 5000 to 11000 lb Axle	
F	04-09	T6500 All FL3 Tilt Cab with 14575 lb Axle	
F	97-02	T6500 All FL1 Tilt Cab with 8100 lb Axle	
F	97-02	T6500 All FL2 Tilt Cab with 5000 to 11000 lb Axle	
F	97-02	T6500 All FL3 Tilt Cab with 14575 lb Axle	
R	97-99	T6500 All Tilt Cab w/19000, 21000, 23000 lb Taperleaf Springs (EXC Low Profile Veh.)	
R	92-96	VAN 1 TON, P SERIES All Motorhome Chassis	
F	93-02	GMC B7 All Models with O.E.M. Number	
F	90-02	C4500 TOPKICK	
R	90-02	C4500 TOPKICK	
R	03-09	C4500 TOPKICK All C Chassis - Conventional Cab with 19000, 21000, 23000 lb Taperleaf Springs (EXC Low Profile Vehicle)	
F	03-09	C4500 TOPKICK All C Chassis - Conventional Cab with Front Shock with O.E.M. Number	
F	04-09	T6500 All FL1 Tilt Cab with 8100 lb Axle	
F	04-09	T6500 All FL2 Tilt Cab with 5000 to 11000 lb Axle	
F	04-09	T6500 All FL3 Tilt Cab with 14575 lb Axle	
F	97-02	T6500 All FL1 Tilt Cab with 8100 lb Axle	
F	97-02	T6500 All FL2 Tilt Cab with 5000 to 11000 lb Axle	
F	97-02	T6500 All FL3 Tilt Cab with 14575 lb Axle	
R	97-99	T6500 All Tilt Cab with 19000, 21000, 23000 lb Taperleaf Springs (EXC Low Profile Veh.)	
R	97-02	ISUZU FSR All Models with 19000, 21000, 23000 lb Taperleaf Springs (EXC Low Profile Veh.)	

Numerical listing

Shock	POP	Alternative No.	MTG Acc. Supplied
Pos.	Year	Application	
83136	C (cont)	145054 (2)	
F	97-02	FSR All Models with FL1 Tilt Cab with 8100 lb Axle (Including Low Profile)	
R	97-09	FTR All Models with 19000, 21000, 23000 lb Taperleaf Springs (EXC Low Profile Veh.)	
F	90-09	FTR All Models with O.E.M. Number	
R	97-09	FVR All Models with 19000, 21000, 23000 lb Taperleaf Springs (EXC Low Profile Veh.)	
F	97-09	FVR All Models with O.E.M. Number	
R	93-05	KENWORTH K300 All Models with Woodhead Shock (Stamping Number ACHB 966) T300	
83137	C	415010-802(2)/145148(2)	
R	97-09	CHEVROLET C6500 KODIAK All Models with Hendrickson Air Suspension with O.E.M. Number	
R	18-22	ISUZU FTR All Models with Hendrickson HAS suspension	
R	00-11	FTR All Models with Hendrickson HAS suspension	
R	00-11	FVR All Models with Hendrickson HAS suspension	
R	13-23	KENWORTH K270 All Models with Hendrickson HAS - 230 Rear Air Suspension	
R	08-14	T270 All Models with Hendrickson HAS - 400 (Standard) Rear Air Suspension	
83140	C	415010-802(2)/145148(2)	
F	05-10	HINO 185 All Models with O.E.M. Number	
F	05-14	238 All Models with O.E.M. Number	
F	06-14	258 All Models with O.E.M. Number	
F	05-14	268 All Models with O.E.M. Number	
F	08-14	268A All Models with O.E.M. Number	
83141	D	415010-802(2)/145148(2)	
F	98-04	HINO FB1817 All FE Models Trucks with:	
F	98-04	FE SERIES	
F	03	FF3020	
83142	C	145128 (1)	
R	05-21	FREIGHTLINER M2 All Models with Hendrickson HMX 400/460 Haulmax with 17.5" & 18.5" Saddle	
R	02-10	M2 100 All Models with Hendrickson HMX 400/460 Haulmax with 17.5" & 18.5" Saddle	
R	02-24	M2 106 All Models with Hendrickson HMX 400/460 Haulmax with 17.5" & 18.5" Saddle	
R	19-22	INTERNATIONAL HV607 All Models with Hendrickson HMX 400/460 Haulmax with 17.5" & 18.5" Saddle	
83143	C	145128 (1)	
R	05-21	FREIGHTLINER M2 All Models with Hendrickson HMX 400/460 Haulmax with 16.5" Saddle	
R	02-10	M2 100 All Models with Hendrickson HMX 400/460 Haulmax with 16.5" Saddle	
R	02-24	M2 106 All Models with Hendrickson HMX 400/460 Haulmax with 16.5" Saddle	
R	19-22	INTERNATIONAL HV607 All Models with Hendrickson HMX 400/460 Haulmax with 16.5" Saddle	
R	08-23	KENWORTH T270 All Models with Hendrickson HMX 400/460 Haulmax with 16.5" Saddle	
83148	D	415089-000 (1)	
R		HINO ADDITIONAL APPLICATIONS	
83154	C	145089-000 (1)	
R	98-23	FREIGHTLINER MT45 All Walkin Step Van Models (18 Foot) with O.E.M. Number	
R		MT55	
83157	D	415089-000 (1)	
F	99-20	FREIGHTLINER MT45 All MT45 Step Van - w/35" Front Spring	
F	99-20	MT55 All MT55 Step Van - w/35" Front Spring	

83000 Series

Shock	POP	Alternative No.	MTG Acc. Supplied
Pos.	Year	Application	
83159	D	TR0027 (4)	
R	16-23	CHEVROLET LCF 3500 All	
R	18	LCF 3500HD	
R	16-17	LCF 3500HD All	
R	19-22	SILVERADO 4500 HD All Diesel Low Cab Forward models with 14,000 to 15,000 lb Rear	
R	19-22	SILVERADO 4500 HD All Diesel Low Cab Forward models with 15,000 to 16,000 lb Rear	
R	19-22	SILVERADO 5500 HD All Diesel Low Cab Forward models with 14,000 to 15,000 lb Rear	
R	19-22	SILVERADO 5500 HD All Diesel Low Cab Forward models with 15,000 to 16,000 lb Rear	
R	05-09	ISUZU FTR All Models with O.E.M. Number	
R	19	NPR	
R	95-18	NPR All Models with O.E.M. Number	
R	20-23	NPR-HD All Models with 14,000 to 15,000 lb Rear	
R	20-23	NPR-HD All Models with 15,000 to 16,000 lb Rear	
R	03-19	NPR-HD All Models with O.E.M. Number	
R	23	NPR-XD	
R	15-22	NPR-XD All Models with 14,000 to 15,000 lb GVW	
R	15-22	NPR-XD All Models with 15,000 to 16,000 lb Rear	
R	20-23	NQR All Models with 15,000 to 16,000 lb Rear	
R	03-19	NQR All Models with O.E.M. Number	
R	02	NQR All Diesel	
R	95-97	NQR All Diesel	
R	20-23	NRR All Models with 15,000 to 16,000 lb Rear	
R	05-19	NRR All Models with O.E.M. Number	
R	11-15	REACH All Models with O.E.M. Number	
83162	D	140780(1)/145116 & 406422 & 415010-802(1)	
F	86	ISUZU FSR	
F	87-92	FSR All FSR Models	
F	94-96	FVR All FVR Short & Middle Chassis	
F	88-92	FVR All FVR Short & Middle Chassis	
F	05-11	MITSUBISHI FUSO FM330 All Models with O.E.M. Number	
F	89-91	UD 550T All Models with O.E.M. Number	
F	92-94	600T All Models with O.E.M. Number	
F	89-13	2600 All Models with O.E.M. Number	
83163	C	415089-000 (1)	
F	08-09	INTERNATIONAL 4300 All Models with 9,000 to 10,000 lb Front Suspension	
F	08-09	4400 All Models with 9,000 to 10,000 lb Front Suspension	
F		CXT SERIES	
F	15-19	DURASTAR All Models with 9,000 to 10,000 lb Front Suspension	
F	13	DURASTAR All Models with 9,000 to 10,000 lb Front Suspension	
F	19-22	MV607 All Models with 9,000 to 10,000 lb Front Suspension	
83164	D	415089-000 (1)	
F	99-20	FREIGHTLINER MT45 All MT45 Step Van - w/38" Front Spring	
F	99-20	MT55 All MT55 Step Van - w/38" Front Spring	
83166	C	145089-000 (1)	
R	08-14	HINO 238 All Models with Hendrickson Comfort Air (Single Axle - 19K)	
R	08-23	258 All Models with Hendrickson Comfort Air (Single Axle - 19K)	
R	08-14	258ALP All Models with Hendrickson Comfort Air (Single Axle - 19K)	
R	08-23	268 All Models with Hendrickson Comfort Air (Single Axle - 19K)	
R	08-14	268A All Models with Hendrickson Comfort Air (Single Axle - 19K)	

Numerical listing

Shock	POP	Alternative No.	MTG Acc. Supplied
Pos.	Year	Application	
83166	C (cont)	145054 (2)	
R	22-23	L6	
R	21	L6 All Models with Hendrickson Comfort Air (Single Axle - 19K)	
R		LION LION 6	
83168	D	415089-000 (1)	
R		HINO 268, 268A SERIES	
83169	D	415089-000 (1)	
F	15-20	INTERNATIONAL DURASTAR All Models with 6,000 to 8,000 lb Front Suspension	
F	13	DURASTAR All Models with 6,000 to 8,000 lb Front Suspension	
F	13-18	DURASTAR - 4300, 4400 SERIES	
F	19	MV SERIES	
83180	W	415089-000 (1)	
R	14	INTERNATIONAL TERRASTAR All 4 WD Models with Rear Spring Suspension	
83209	C	415089-000 (1)	
F	06-23	FORD F-53	
F	99-04	F-53	
F	88-97	F-53	
83215	D	401754 (4)	
R	86-94	FORD F-600 All Models with O.E.M. Number	
R	80-90	F-600 All Models with 17000 & 18000 lb Rear Axle	
R	86-98	F-700 All Models with O.E.M. Number	
R	80-90	F-700 All Models with 17000 & 18000 lb Rear Axle	
R	86-97	F-800 All Models with O.E.M. Number	
R	80-90	F-800 All Models with 17000 & 18000 lb Rear Axle	
R	86-87	HINO FD16 All Models with O.E.M. Number	
R	88-92	FD17 All Models with O.E.M. Number	
R	93-97	FD2218 All (FD5H). FE5H, FF5H	
R	93-97	FD2218LD	
R	93-97	FD2218LP All Models with O.E.M. Number	
R	98	FE2620 All	
R	98	FF SERIES	
83216	D	140149 (1)	
R	92	HINO FA15 All FA, FB Models Trucks with:	
R	93-97	FA1415 All (FA15)	
R	93-97	FA1415 All FA, FB Models Trucks with:	
R	93-97	FA1415 All FA1415 (FA15), FB1715 (FB15)	
R	98-04	FA1517 All FA, FB Models Trucks with:	
R	98	FA1517 All	
R	98	FA1517 All FA1517, FA1817, FB1817	
R	89-91	FB14 All FA, FB Models Trucks with:	
R	92	FB15 All FA, FB Models Trucks with:	
R	93-97	FB1715 All FA, FB Models Trucks with:	
R	93-97	FB1715 All FA1415 (FA15), FB1715 (FB15)	
R	98-04	FB1817 All FA, FB Models Trucks with:	
R	98	FB1817 All	
R	98	FB1817 All FA1517, FA1817, FB1817	
F	93-97	FD2218 All (FD5H). FE5H, FF5H	
F	93-97	FD2218LP All Models with O.E.M. Number	
F	86-87	FE16 All	
F	90-91	GC17 All GC17	
F	92	GC20 All GC20	
83221	D	415089-000 (1)	
R	83-99	CHEVROLET C4500 KODIAK	
R	92-99	C5500 KODIAK	
R	83-89	C5500 KODIAK	
R	90-91	C5500 KODIAK All C Chassis - Conventional Cab with 9100 to 17500 lb Rear Axle	
R	83-96	C6500 KODIAK	
R	97-99	C7500 KODIAK All Conventional Cab with 9100 to 17500 lb Rear Axle	

Numerical listing

Shock	POP	Alternative No.	MTG Acc. Supplied
Pos.	Year	Application	
83225	D		401754 (4)
R	70-90	FORD F-600 All Models with 13000 & 15000 lb Rear Axle	
R	70-90	F-700 All Models with 13000 & 15000 lb Rear Axle	
R	80-90	F-800 All Models with 13000 & 15000 lb Rear Axle	
R	80-85	LN600 All Models with 11000, 13000, 15000, 17000 lb Axles	
83243	N		
R	19-21	CHEVROLET SILVERADO 4500 HD All Models with 4 x 4 Rear	
R	19-22	SILVERADO 5500 HD All Models with 4 x 4 Rear	
R	19-22	SILVERADO 6500 HD All Models with 4 x 4 Rear	
R	19-23	INTERNATIONAL CV515 All Models with 4 x 4 Rear	
83308	D		140149 (1)
F	80-86	FORD C600 All Models with 3100 lb Spring and 7000 lb Axle	
F	80-86	C700 All Models with 3100 lb Spring and 7000 lb Axle	
F	80-86	C7000 All Models with 3100 lb Spring and 7000 lb Axle	
F	80-85	LN600 All Models with 3000, 3300 lb Springs and 5000, 5500, 6000, 7000 lb Axles	
83309	D		140149 (1)
F	80-94	FORD B-600 All B - Series - Bus Cowl Chassis	
F	80-94	B-700 All B - Series - Bus Cowl Chassis	
F	83-87	B-7000 All B - Series - Bus Cowl Chassis	
F	80-94	F-600 All Exc. 9000 lb Axle with H.D. Suspension & 12000 lb Axle	
F	90	F-600 All Models with Multileaf Spring	
F	80-94	F-700 All Exc. 9000 lb Axle with H.D. Suspension & 12000 lb Axle	
F	90	F-700 All Models with Multileaf Spring	
F	80-94	F-800 All Exc. 9000 lb Axle with H.D. Suspension & 12000 lb Axle	
F	90	F-800 All Models with Multileaf Spring	
F	80-87	F-7000 All Exc. 9000 lb Axle with H.D. Suspension & 12000 lb Axle	
83312	D		140149 (1)
F	80-86	FORD C600 All Models with 4040, 5040 lb Springs and 7000, 9000, 12000 lb Axles	
F	80-86	C700 All Models with 4040, 5040 lb Springs and 7000, 9000, 12000 lb Axles	
F	80-86	C7000 All Models with 4040, 5040 lb Springs and 7000, 9000, 12000 lb Axles	
F	80-85	LN600 All Models with 4400 lb Spring and 7000, 9000 lb Axles	
F	93-05	KENWORTH K300 All Models with Multiple Leaf Springs on Front Axle (3/4" Mounting bolts)	
F		T300	
83314	D		140149 (1)
F	83-89	FORD F-600 All Models with 9000 lb Axle with H.D. Suspension & 12000 lb Axle	
F	94-98	F-700 All Models with Taperleaf Springs and with 6000, 7000, 8500, 9000 lb Axle	
F	83-89	F-700 All Models with 9000 lb Axle with H.D. Suspension & 12000 lb Axle	
F	94-98	F-800 All Models with Taperleaf Springs and with 6000, 7000, 8500, 9000 lb Axle	
F	83-89	F-800 All Models with 9000 lb Axle with H.D. Suspension & 12000 lb Axle	
F	83-87	F-7000 All Models with 9000 lb Axle with H.D. Suspension & 12000 lb Axle	
83317	D		141083 (1)
R	02-13	INTERNATIONAL 4300 All Models with 22,000 lb Rear Spring Suspension	
R	02-13	4400 All Models with 22,000 lb Rear Spring Suspension	

83000 Series, 85000 Series

Shock	POP	Alternative No.	MTG Acc. Supplied
Pos.	Year	Application	
83317	D (cont)		141083 (1)
R	13	DURASTAR All Models with 22,000 lb Rear Spring Suspension	
83364	D		
R	16-20	INTERNATIONAL DURASTAR All Models with 10,500 or 13,500 lb Vari-Rate Rear Spring Suspension	
R	12-17	TERRASTAR All Models with 10,000 & 13,500 lb Vari-Rate Rear Spring Suspension	
R	12-17	TERRASTAR All Models with 10,500 or 13,500 lb Vari-Rate Rear Spring Suspension	
83391	D		145177 (2)
F	15-21	HINO 258 All Models with O.E.M. Number	
F	15-22	268 All Models with O.E.M. Number	
F	22-23	L6	
F	21	L6 All Models with O.E.M. Number	
83395	D		145054 (1)
R	16-17	INTERNATIONAL DURASTAR All Models with Vari-Rate Rear Spring Suspension	
83397	N		
F	19-22	CHEVROLET SILVERADO 4500 HD All Models with Taperleaf Front	
F	19-23	SILVERADO 5500 HD All Models with Taperleaf Front	
F	19-23	SILVERADO 6500 HD All Models with Taperleaf Front	
F	24	INTERNATIONAL CV515	
F	19-23	CV515 All Models with Taperleaf Front	
83398	N		
R	19-22	CHEVROLET SILVERADO 4500 HD All Models with 11K, 13.5K or 15.5K VARI-RATE Rear Suspension	
R	19-23	SILVERADO 5500 HD All Models with 11K, 13.5K or 15.5K VARI-RATE Rear Suspension	
R	19-23	SILVERADO 6500 HD All Models with 11K, 13.5K or 15.5K VARI-RATE Rear Suspension	
R	24	INTERNATIONAL CV515	
R	19-23	CV515 All Models with 11K, 13.5K or 15.5K VARI-RATE Rear Suspension	
83515	D		140885 (1)
F	16-23	CHEVROLET LCF 3500 All	
F	18	LCF 3500HD	
F	16-17	LCF 3500HD All	
F	19-22	SILVERADO 4500 HD All Diesel Low Cab Forward models with 14,500 lb GVWR	
F	19-22	SILVERADO 4500 HD All Diesel Low Cab Forward models with 16,000 lb to 19,500 lb GVWR	
F	19-22	SILVERADO 5500 HD All Diesel Low Cab Forward models with 14,500 lb GVWR	
F	19-22	SILVERADO 5500 HD All Diesel Low Cab Forward models with 16,000 lb to 19,500 lb GVWR	
F	87-10	W4500 TILTMMASTER All Models with 11000 lb & 13000 lb Suspension	
F	88-10	W5500 TILTMMASTER All Models with 11000 lb & 13000 lb Suspension	
F	87-96	W6500 TILTMMASTER All Models with 11000 lb & 13000 lb Suspension	
F	92-10	GMC W4500 FORWARD All Models with 11000 lb & 13000 lb Suspension	
F	88-10	W5500 FORWARD All Models with 11000 lb & 13000 lb Suspension	
F	87-96	W6500 FORWARD All Models with 11000 lb & 13000 lb Suspension	
F	85	ISUZU ADDITIONAL APPLICATIONS	
F		ALL MODELS WITH	
F	86	FSR	
F	87-92	FSR All FSR Models	
F	05-09	FTR All Models with O.E.M. Number	
F	19-23	NPR	
F	84-85	NPR	
F	86-18	NPR All Models with O.E.M. Number	

Numerical listing

Shock	POP	Alternative No.	MTG Acc. Supplied
Pos.	Year	Application	
83515	D (cont)		140885 (1)
F	99-23	NPR-HD All Models with O.E.M. Number	
F	23	NPR-XD	
F	15-22	NPR-XD All Models with 14,000 to 15,000 lb GVW	
F	15-22	NPR-XD All Models with 15,000 to 16,000 lb GVW	
F	94-23	NQR All Models with O.E.M. Number	
F	05-23	NRR All Models with O.E.M. Number	
F	88-94	NRR All Models with O.E.M. Number	
F	11-15	REACH All Models with O.E.M. Number	
F	99-04	UD 1200 All Models with O.E.M. Number	
F	05-07	1300 All Models with O.E.M. Number	
F	94-10	1400 All Models with O.E.M. Number	
83518	D		141041 (1)/TR0027 (2)
F	13-20	HINO 155 All Models with O.E.M. Number	
F	21	195	
F	12-20	195 All Models with O.E.M. Number	
83519	D		401011 (4)
R	16-20	HINO 155 All Models with O.E.M. Number	
R	21	195	
R	12-20	195 All Models with O.E.M. Number	
83613	D		141083 (2)
R	87-96	ISUZU FSR All FSR Models	
R	88-96	FTR All Models with O.E.M. Number	
R	94-96	FVR All Models with O.E.M. Number	
R	88-92	FVR All Models with O.E.M. Number	
85000 Series			
85001	B		401754 (4)
R	94-97	FORD F-800 All Models with 21000 Taperleaf Springs	
F	93-05	KENWORTH K300 All Models with Taper Leaf Springs on Front Axle (1" Mounting bolts)	
F		T300	
85005	C		
R	08-23	FORD F-53	
85006	B		
F	08-23	FORD F-53	
F	24	F-59 COMMERCIAL STRIPPED CHASSIS	
F	11-23	F-59 COMMERCIAL STRIPPED CHASSIS All MotorHomes with Ford F59 Commercial Chassis with 24,000 lb GVW to 26,000 lb GVW	
F	05-07	FREIGHTLINER FC70	
F	99-04	FC70 All Models with 10,000 to 18,000 lb Suspension	
F	95-05	FL50 All Models with 10,000 to 18,000 lb Suspension	
F	91-05	FL60 All Models with 10,000 to 18,000 lb Suspension	
F		STERLING TRUCK ACTERRA	
85007	D		401754 (4)
F	93-05	KENWORTH K300 All K300 COE Medium Duty	
85009	D		145054 (1)
F	91-94	MITSUBISHI FUSO FK All FK457 Models with O.E.M. Number	
F	88-91	FK All FK455 Models with O.E.M. Number	
85010	D		
R	11-20	FORD F-53	
R	11-21	F-59 COMMERCIAL STRIPPED CHASSIS All F59 Commercial Chassis with 16,000 lb or 19,500 GVW	
R	88-97	F-59 COMMERCIAL STRIPPED CHASSIS All F59 Commercial Chassis with 16,000 lb or 19,500 GVW	
85012	B		145080 (2)
R	85	ISUZU ADDITIONAL APPLICATIONS	
R	86-95	NPR All	

Numerical listing

Shock	POP	Alternative No.	MTG Acc. Supplied
Pos.	Year	Application	
85012	B (cont)	145080 (2)	
F 13	PETERBILT 220	All Models with 12,000 lb Front Axle	
F 10	220	All Models with 12,000 lb Front Axle	
F 07	220	All Models with 12,000 lb Front Axle	
F 08-19	325	All Models with 12000 lb Set Back Front Axle	
F 07-16	330	All Models with 12000 lb Set Back Front Axle	
F 95-05	330	All Models with 12000 lb Set Back Front Axle	
85013	C	145080 (2)	
F 11-20	FORD F-53		
F 11-21	F-59 COMMERCIAL STRIPPED CHASSIS	All F59 Commercial Chassis with 16,000 lb to 22,000 GVW	
F 88-97	F-59 COMMERCIAL STRIPPED CHASSIS	All F59 Commercial Chassis with 16,000 lb to 22,000 GVW	
R 13-22	PETERBILT 220	All Models with Reyco 102AR (Standard) Rear Air Suspension	
R 10	220	All Models with Reyco 102AR (Standard) Rear Air Suspension	
R 07	220	All Models with Reyco 102AR (Standard) Rear Air Suspension	
R 07-21	330	All Models with Reyco 102AR (Standard) Rear Air Suspension	
R 95-05	330	All Models with Reyco 102AR (Standard) Rear Air Suspension	
85030	C	145099 (1)	
R 97-00	SPARTAN MOTORS HIGHLANDER	All With I Beam Front Suspension	
85031	D	145147(1)/TR0027(2)	
F 93-05	KENWORTH K300	All Models with 12,000 lb Taper Leaf Front Springs (5/8" Top Mounting bolt)	
F 08-13	T170	All Models with 8,000 lb Taper Leaf Front Springs	
F 08-10	T270	All Models with 12,000 lb Front Axle	
F 99-08	T300	All Models with 12,000 lb Taper Leaf Front Springs (5/8" Top Mounting bolt)	
85033	B	145099 (1)	
R 95-02	PETERBILT 330	All Models with Peterbilt 40000 lb Low Air Leaf Suspension	
85043	D	145080 (2)	
F 05-07	FREIGHTLINER FC70		
F 99-04	FC70	All Models with 6000 to 9000 lb Front axle	
F 95-05	FL50	All Models with 6000 to 9000 lb Front axle	
F 91-05	FL60	All Models with 6000 to 9000 lb Front axle	
85054	D	145080 (2)	
F 96-97	FORD CF7000	All Models with 16000 lb. Multileaf Spring	
85058	C	145080 (2)	
F 98-23	FREIGHTLINER MT45	All Step Van Models with O.E.M. Number	
F	MT55		
F	VARIOUS		
85063	D	145080 (2)	
F 94-97	FORD F-700	All Models with 52" or 54" Taperleaf Springs and with 10000 or 12000 lb Axle	
F 94-97	F-800	All Models with 52" or 54" Taperleaf Springs and with 10000 or 12000 lb Axle	
85067	A	145089-000 (2)	
R 11-16	KENWORTH T700	All Models with Air Glide 380 (AG380) Rear Air Suspension	
85069	A	145089-000 (2)	
R 24	KENWORTH T270		
R 08-23	T270	All Models with AG210L Rear Air Suspension	
R 11-16	T700	All Models with Air Glide 400L (AG400L) Rear Air Suspension	

85000 Series

Shock	POP	Alternative No.	MTG Acc. Supplied
Pos.	Year	Application	
85069	A (cont)	145089-000 (2)	
R 07-22	PETERBILT 330	All Models with Peterbilt Low Air Leaf Suspension	
R 03-05	330	All Models with Peterbilt Low Air Leaf Suspension	
R 22-24	536	All Models with Peterbilt Low Air Leaf Suspension	
85070	A	401754 (2)	
F 11-16	KENWORTH T700	All Models with 13,000 lb Front Axle	
85071	D	145054 (2)	
R 93-02	CHEVROLET B7	All With 15000, 19000, 21000 lb Multileaf Springs	
R 90-02	C4500 KODIAK		
R 03-09	C4500 KODIAK	All C Chassis - Conventional Cab With 15000, 19000, 21000 lb Multileaf Springs	
R 92-02	C5500 KODIAK		
R 03-09	C5500 KODIAK	All C Chassis - Conventional Cab With 15000, 19000, 21000 lb Multileaf Springs	
R 90-91	C5500 KODIAK	All C Chassis - Conventional Cab With 15000, 19000, 21000 lb Multileaf Springs	
R 97-09	C7500 KODIAK	All Conventional Cab w/15000, 19000, 21000 lb Multileaf Springs	
R 04-06	T6500	All Tilt Cab w/15000, 19000, 21000 lb Multileaf Springs	
R 97-02	T6500	All Tilt Cab w/15000, 19000, 21000 lb Multileaf Springs	
R 93-02	GMC B7	All School Bus Chassis w/15000, 19000, 21000 lb Multileaf Springs	
R 90-02	C4500 TOPKICK		
R 03-09	C4500 TOPKICK	All C Chassis - Conventional Cab with 15000, 19000, 21000 lb Multileaf Springs	
R 90-02	C5500 TOPKICK		
R 03-09	C5500 TOPKICK	All C Chassis - Conventional Cab with 15000, 19000, 21000 lb Multileaf Springs	
R 04-06	T6500	All Tilt Cab with 15000, 19000, 21000 lb Multileaf Springs	
R 97-02	T6500	All Tilt Cab with 15000, 19000, 21000 lb Multileaf Springs	
R 97-02	ISUZU FSR	All Models with 15000, 19000, 21000 lb Multileaf Springs	
F 18-20	FTR	All FTR Diesel Models with Std Cab	
R 90-09	FTR	All Models with 15000, 19000, 21000 lb Multileaf Springs	
R 94-09	FVR	All Models with 15000, 19000, 21000 lb Multileaf Springs	
R 90-92	FVR	All Models with 15000, 19000, 21000 lb Multileaf Springs	
85072	B	145080 (2)	
R 19-23	INTERNATIONAL HV607	All Models with Hendrickson Primaax 230/460 Air Suspension with 9" Ride Height	
R 08-22	KENWORTH T270	All Models with Hendrickson Primaax 230, 232, 460, 462, 690 and 692 Air Suspension (8-1/2" to 10" Ride Height)	
85084	C	145080 (2)	
F 10-14	KENWORTH T270	All Models with 10,000 lb to 12,000 lb Front Axle	
F 10-14	T270	All Models with 13,200 lb to 14,600 lb Front Axle	
F 10-14	T270	All Models with 8,000 lb Front Axle	
F 08-15	PETERBILT 325	All Models with 8,000 lb Front Axle	
85124	D	145054 (2)	
R 04-09	WORKHORSE W20	All Models with O.E.M. Number	
R 04-09	W22	All Models with O.E.M. Number	
R 04-09	W24	All Models with O.E.M. Number	
85125	D	145089-200 (2)	
F 01-09	WORKHORSE W20	All	
F 01-09	W22	All	
F 04-09	W24	All	
85182	D	145089-200 (2)	
F 13-24	KENWORTH K270	All Models with 10,000 lb to 12,000 lb Front Axle	

Numerical listing

Shock	POP	Alternative No.	MTG Acc. Supplied
Pos.	Year	Application	
85182	D (cont)	145089-200 (2)	
F 13-23	PETERBILT 220	All Models with 12,000 lb Front Axle	
85188	D	141108 (1)	
R 23	MACK MD6		
R 24	MD6	All Models with O.E.M. Number	
R 21-22	MD6	All Models with O.E.M. Number	
85301	D	401754 (4)	
F 86-97	FORD CF7000	All Models with 12000 lb or 13000 lb Axle	
85302	D	401754 (4)	
R 86-97	FORD CF7000	All Models with 12000 lb or 13000 lb Axle	
85310	B	141108 (1)	
R 93-05	KENWORTH K300	All All with Air Glide 100 Suspension with 8 air bags, 4 units required	
R	T300		
85311	A	141247 (1)	
R 07-21	PETERBILT 330	All Models with Air Trac Suspension (46,000 lb)	
R 95-05	330	All Models with Air Trac Suspension (46,000 lb)	
85314	D	401754 (4)	
R 94	FORD B-700	All Models with with 15000, 17500, 19000 lb Taperleaf Springs	
R 94-98	F-700	All Models with with 15000, 17500, 19000 lb Taperleaf Springs	
R 94-98	F-800	All Models with with 15000, 17500, 19000 lb Taperleaf Springs	
85331	C	141108 (1)	
R 05-15	FREIGHTLINER M2	All Models with Freightliner Low Profile Rear Air Suspension (18,000 to 40,000 lb)	
R 02-10	M2 100	All Models with Freightliner Low Profile Rear Air Suspension (18,000 to 40,000 lb)	
R 02-15	M2 106	All Models with Freightliner Low Profile Rear Air Suspension (18,000 to 40,000 lb)	
R 99-23	MT55	All Models with Freightliner Low Profile Rear Air Suspension	
85335	D	141108 (1)	
R 05-21	FREIGHTLINER M2	All Models with Rear 10000 lb - 15000 lb Low Profile AirLiner	
R 02-10	M2 100	All Models with Rear 10000 lb - 15000 lb Low Profile AirLiner	
R 02-23	M2 106	All Models with Rear 10000 lb - 15000 lb Low Profile AirLiner	
85376	D	401754 (4)	
F 92-97	FORD CF7000	All Models with 9000 lb Axle	
85649	D	143146 (1)	
F 12-18	RAM 4500	All Models with O.E.M. Number	
F 12-18	5500	All Models with O.E.M. Number	
F 08-10	STERLING TRUCK BULLET 45	All Models with O.E.M. Number	
F 08-10	BULLET 55	All Models with O.E.M. Number	
85650	D	141108 (1)	
R 12-18	RAM 4500	All Models with O.E.M. Number	
R 12-18	5500	All Models with O.E.M. Number	
R 08-10	STERLING TRUCK BULLET 45	All Models with O.E.M. Number	
R 08-10	BULLET 55	All Models with O.E.M. Number	
85656	C	141108 (1)	
R 16-19	INTERNATIONAL DURASTAR	All Models with 20,000 lb International IROS Air Suspension	
R 16-19	DURASTAR - 4300, 4400 SERIES		
R 20-22	MV607	All Models with 20,000 lb International IROS Air Suspension	
R 19	MV SERIES		

Numerical listing

Shock	POP	Alternative No.	MTG Acc. Supplied
Pos.	Year	Application	
85670	N		
R	19-22	CHEVROLET	SILVERADO 4500 HD All Models with IROS Rear
R	19-22	SILVERADO 5500 HD	All Models with IROS Rear
R	19-22	SILVERADO 6500 HD	All Models with IROS Rear
R	19-23	INTERNATIONAL	CV515 All Models with IROS Rear
85716	D		145093 (1)
R	90-94	FORD	F-600 LPO All Models with O.E.M. Number
R	90-94	F-700 LPO	All Models with O.E.M. Number
85724	A		
R	05-23	FREIGHTLINER	B2 All Models with FAS II (40,000 lb) Rear Air Suspension
R	05-07	FC70	
R	95-05	FL50	All Models with FAS II (40,000 lb) Rear Air Suspension
R	91-05	FL60	All Models with FAS II (40,000 lb) Rear Air Suspension
R	05-21	M2	All Models with FAS II (40,000 lb) Rear Air Suspension
R	02-10	M2 100	All Models with FAS II (40,000 lb) Rear Air Suspension
R	02-24	M2 106	All Models with FAS II (40,000 lb) Rear Air Suspension
R	03-10	STERLING TRUCK	ACTERRA All Models with FAS II (40,000 lb) Rear Air Suspension
R	01-07	ACTERRA 5500	All Models with FAS II (40,000 lb) Rear Air Suspension
R	01-07	ACTERRA 6500	All Models with FAS II (40,000 lb) Rear Air Suspension
85900	B		145054 (2)
R	93-05	KENWORTH	K300 All All with Air Glide 200 with 40,000 lb Suspension with 8 air bags, 4 units required
R		T300	
85902	D		145054 (2)
R	93-05	KENWORTH	K300 All All with Air Glide 200 with 46,000 lb Suspension with 8 air bags, 4 units required
R	95-08	T300	All All with Air Glide 200 with 46,000 lb Suspension with 8 air bags, 4 units required
85910	D		
F		PETERBILT	330
85918	A		
F	05-23	FREIGHTLINER	B2 All Models with 12000 lb Taperleaf Front Suspension
85919	B		
F	99-23	FREIGHTLINER	MT55 All MT55 Chassis with O.E.M. Number
85920	C		
F	02-08	FREIGHTLINER	M2 106 All Models with 10000 to 12000 lb. Taper-leaf Spring Suspension
F	02-08	M2 106	All Models with 6000 to 9000 lb Front axle
F	01-09	STERLING TRUCK	ACTERRA
85921	D		145054 (1)
R	05-21	FREIGHTLINER	M2 All Models with Rear 60" Spring ,18000 lb - 23000 lb
R	02-10	M2 100	All Models with Rear 60" Spring ,18000 lb - 23000 lb
R	02-23	M2 106	All Models with Rear 60" Spring ,18000 lb - 23000 lb
85923	C		
R	08-09	INTERNATIONAL	4300 All Models with International 40,000 lb Rear Air Suspension
R	08-09	4400	All Models with International 40,000 lb Rear Air Suspension
R		DURASTAR - 4300, 4400 SERIES	
R	10-11	DURASTAR - 4300, 4400 SERIES	
R	19	MV SERIES	
85927	D		
R		INTERNATIONAL	DURASTAR - 4300, 4400 SERIES

85000 Series, 89000 Series

Shock	POP	Alternative No.	MTG Acc. Supplied
Pos.	Year	Application	
85928	C		
F	16-20	INTERNATIONAL	DURASTAR All Models with 11,000 lb to 14,000 lb Front axle
F	16-20	DURASTAR - 4300, 4400 SERIES	
F	23	EMV607	
F	19-23	HV607	All Models with 11,000 lb to 14,000 lb Taper-leaf Springs
F	19-22	MV SERIES	
85932	C		
F	03-10	STERLING TRUCK	ACTERRA All Models with Hendrickson Front Airtek
F	01-07	ACTERRA 5500	All Models with Hendrickson Front Airtek
F	01-07	ACTERRA 6500	All Models with Hendrickson Front Airtek
85936	B		145089-200 (1)
R	11-16	KENWORTH	T700 All Models with Air Glide 400 (AG400) Rear Air Suspension
85956	C		
R	05-21	FREIGHTLINER	M2 All Models with Freightliner TufTrac Rear Air Suspension
R	02-10	M2 100	All Models with Freightliner TufTrac Rear Air Suspension
R	02-24	M2 106	All Models with Freightliner TufTrac Rear Air Suspension
R	03-10	STERLING TRUCK	ACTERRA All All Models with Freightliner TufTrac Rear Air Suspension
85957	C		
F	02-15	INTERNATIONAL	4300 All Models with 12,000 lb Front axle
F	02-15	4400	All Models with 12,000 lb Front axle
F	15	DURASTAR	All Models with 12,000 lb Front axle
F	13	DURASTAR	All Models with 12,000 lb Front axle
F	10-15	DURASTAR - 4300, 4400 SERIES	
F	19-20	HV607	All Models with 16,000 lb to 23,000 lb Parabolic Taperleaf Springs
85959	B		
F		FREIGHTLINER	M2
F	09-24	M2 106	All Models with 8000 to 16000 lb Front Axle and Taperleaf Spring
85976	C		
R	02-20	INTERNATIONAL	4300 All Models with Hendrickson HAS - 230 or 460 Rear Air Suspension
R	02-20	4400	All Models with Hendrickson HAS - 230 or 460 Rear Air Suspension
R	15-20	DURASTAR	All Models with Hendrickson HAS - 230 or 460 Rear Air Suspension
R	13	DURASTAR	All Models with Hendrickson HAS - 230 or 460 Rear Air Suspension
R	19-22	MV607	All Models with Hendrickson HAS - 230 or 460 Rear Air Suspension
85985	D		145089-200 (1)
R	11-16	KENWORTH	T700 All Models with Air Glide 230 (AG230) Rear Air Suspension
85988	D		145099 (1)
R	14-21	PETERBILT	330 All Models with Air Trac Suspension (40,000 lb)
R	22-24	536	All Models with Air Trac Suspension (40,000 lb)
85989	B		
F	15-22	KENWORTH	T270 All Models with 10,000 lb to 14,600 lb Taperleaf Springs and Set Back Front Axles
F	15-22	T270	All Models with 16,000 lb to 20,000 lb Taperleaf Springs and Set Back Front Axles
F	24	T280	All Models with 10,000 lb to 12,000 lb Mono-leaf front springs
F	16-22	PETERBILT	330 All Models with 10,000 lb to 14,600 lb Taperleaf Springs and Set Back Front Axles

Numerical listing

Shock	POP	Alternative No.	MTG Acc. Supplied
Pos.	Year	Application	
85989	B (cont)		
F	22-24	536	All Models with 10,000 lb to 14,600 lb Taperleaf Springs and Set Back Front Axles
85995	D		
F	19-21	INTERNATIONAL	HV607 All Models with 18,000 to 20,000 lb (Set Forward) Front Axle
89000 Series			
89405	D		
R	13-24	KENWORTH	K270 All Models with Hendrickson HAS - 210L or HAS - 230L Rear Air Suspension
R	93-05	K300	All Models with Hendrickson Rear Air Suspension
R	08-22	T270	All Models with Hendrickson HAS - 210L or HAS - 230L Rear Air Suspension
R		T300	
R	95-08	T300	All Models with Hendrickson HAS - 210L or HAS - 230L Rear Air Suspension
R	13-24	PETERBILT	220 All Models with Hendrickson HAS - 210L or HAS - 230L Rear Air Suspension
R	10	220	All Models with Hendrickson HAS - 210L or HAS - 230L Rear Air Suspension
R	07	220	All Models with Hendrickson HAS - 210L or HAS - 230L Rear Air Suspension
89406	D		
R	97-09	CHEVROLET	C7500 KODIAK All Models with Hendrickson Air Suspension (Stamping number 47902-13)
R	99	T6500	All Models with Hendrickson Air Suspension (Stamping number 47902-13)
R	06-23	FORD	F-53
R	99-04	F-53	
R	99	GMC	T6500 All Models with Hendrickson Air Suspension (Stamping number 47902-13)
R		ISUZU	FVR
89409	D		140149 (1)
F	80-86	FORD	C600 All Models with 4040, 5040 lb Springs and 7000, 9000, 12000 lb Axles
F	80-86	C700	All Models with 4040, 5040 lb Springs and 7000, 9000, 12000 lb Axles
F	80-86	C7000	All Models with 4040, 5040 lb Springs and 7000, 9000, 12000 lb Axles
F	80-85	LN600	All Models with 4400 lb Spring and 7000, 9000 lb Axles
F	93-05	KENWORTH	K300 All Models with Multiple Leaf Springs on Front Axle (3/4" Mounting bolts)
F		T300	
89410	C		401754 (4)
R	94-97	FORD	F-800 All Models with 21000 Taperleaf Springs
F	93-05	KENWORTH	K300 All Models with Taper Leaf Springs on Front Axle (1" Mounting bolts)
F		T300	
89413	D		145080 (2)
R	85	ISUZU	ADDITIONAL APPLICATIONS
R	86-95	NPR	All
F	13	PETERBILT	220 All Models with 12,000 lb Front Axle
F	10	220	All Models with 12,000 lb Front Axle
F	07	220	All Models with 12,000 lb Front Axle
F	08-19	325	All Models with 12000 lb Set Back Front Axle
F	07-16	330	All Models with 12000 lb Set Back Front Axle
F	95-05	330	All Models with 12000 lb Set Back Front Axle
89414	D		
F	06-23	FORD	F-53
F	99-04	F-53	
F	88-97	F-53	

Numerical listing

Shock	POP	Alternative No.	MTG Acc. Supplied
Pos.	Year	Application	
89414	D	(cont)	
F	11-21	F-59 COMMERCIAL STRIPPED CHASSIS All F59 Commercial Chassis with 16,000 lb to 22,000 GVW	
F	88-97	F-59 COMMERCIAL STRIPPED CHASSIS All F59 Commercial Chassis with 16,000 lb to 22,000 GVW	
R	13-22	PETERBILT 220 All Models with Reyco 102AR (Standard) Rear Air Suspension	
R	10	220 All Models with Reyco 102AR (Standard) Rear Air Suspension	
R	07	220 All Models with Reyco 102AR (Standard) Rear Air Suspension	
R	07-21	330 All Models with Reyco 102AR (Standard) Rear Air Suspension	
R	95-05	330 All Models with Reyco 102AR (Standard) Rear Air Suspension	
89420	D	401754 (4)	
R	86-97	FORD CF7000 All Models with 12000 lb or 13000 lb Axle	
89423	D	141108 (1)	
R	93-05	KENWORTH K300 All All with Air Glide 100 Suspension with 8 air bags, 4 units required	
R		T300	
89424	C	141247 (1)	
R	07-21	PETERBILT 330 All Models with Air Trac Suspension (46,000 lb)	
R	95-05	330 All Models with Air Trac Suspension (46,000 lb)	
89425	D	401754 (4)	
R	94	FORD B-700 All Models with 15000, 17500, 19000 lb Taperleaf Springs	
R	94-98	F-700 All Models with 15000, 17500, 19000 lb Taperleaf Springs	
R	94-98	F-800 All Models with 15000, 17500, 19000 lb Taperleaf Springs	
89427	C	145099 (1)	
R	95-02	PETERBILT 330 All Models with Peterbilt 40000 lb Low Air Leaf Suspension	
89430	C		
R	08-23	FORD F-53	
R	02-23	FREIGHTLINER M2 106 All Models with Reyco 79KB Rear Steel Spring Suspension	
F	05-10	HINO 145 All Models with O.E.M. Number	
F	05-10	165 All Models with O.E.M. Number	
F	05-10	185 All Models with O.E.M. Number	
R	13-24	KENWORTH K270 All Models with Reyco 102 or 79KB Suspension (Drive Axle)	
R	93-05	K300 All Models with Reyco 102 or 79KB Suspension (Drive Axle)	
F	93-05	K300 All Models with Reyco 1209 or 1212 Suspension (Steer Axle)	
R	08-22	T170 All Models with Reyco 79KB Rear Steel Spring Suspension	
R	08-22	T270 All Models with Reyco 102 or 79KB Suspension (Drive Axle)	
R	21-24	T280 All Models with Reyco 102 or 79KB Suspension (Drive Axle)	
F		T300	
R		T300	
R	99-08	T300 All Models with Reyco 102 or 79KB Suspension (Drive Axle)	
R	99-08	T300 All Models with Reyco 1209 or 1212 Suspension (Steer Axle)	
R	08-15	PETERBILT 210 All Models with Reyco 102 or 79KB Suspension (Drive Axle)	
R	13-24	220 All Models with Reyco 102 or 79KB Suspension (Drive Axle)	
R	10	220 All Models with Reyco 102 or 79KB Suspension (Drive Axle)	
R	07	220 All Models with Reyco 102 or 79KB Suspension (Drive Axle)	
R	08-19	325 All Models with Reyco 102 or 79KB Suspension (Drive Axle)	
R	07-22	330 All Models with Reyco 79KB Rear Steel Spring Suspension	
R	95-05	330 All Models with Reyco 79KB Rear Steel Spring Suspension	

89000 Series, Cab Shock

Shock	POP	Alternative No.	MTG Acc. Supplied
Pos.	Year	Application	
89431	D		
F	98-23	FREIGHTLINER MT45 All Step Van Models with O.E.M. Number	
F		MT55	
F		VARIOUS	
89443	C		
R	05-23	FREIGHTLINER B2 All Models with FAS II (40,000 lb) Rear Air Suspension	
R	05-07	FC70	
R	95-05	FL50 All Models with FAS II (40,000 lb) Rear Air Suspension	
R	91-05	FL60 All Models with FAS II (40,000 lb) Rear Air Suspension	
R	05-21	M2 All Models with FAS II (40,000 lb) Rear Air Suspension	
R	02-10	M2 100 All Models with FAS II (40,000 lb) Rear Air Suspension	
R	02-24	M2 106 All Models with FAS II (40,000 lb) Rear Air Suspension	
R	03-10	STERLING TRUCK ACTERRA All Models with FAS II (40,000 lb) Rear Air Suspension	
R	01-07	ACTERRA 5500 All Models with FAS II (40,000 lb) Rear Air Suspension	
R	01-07	ACTERRA 6500 All Models with FAS II (40,000 lb) Rear Air Suspension	
89449	D		
F	05-23	FREIGHTLINER B2 All Models with 12000 lb Taperleaf Front Suspension	
89451	C		
R	11-16	KENWORTH T700 All Models with Air Glide 380 (AG380) Rear Air Suspension	
89453	D		
F	03-10	STERLING TRUCK ACTERRA All Models with Hendrickson Front Airtek	
F	01-07	ACTERRA 5500 All Models with Hendrickson Front Airtek	
F	01-07	ACTERRA 6500 All Models with Hendrickson Front Airtek	
89455	B	141108 (1)	
R	08-23	KENWORTH T270 All Models with AG210L Rear Air Suspension	
R	11-16	T700 All Models with Air Glide 400L (AG400L) Rear Air Suspension	
R	07-22	PETERBILT 330 All Models with Peterbilt Low Air Leaf Suspension	
R	03-05	330 All Models with Peterbilt Low Air Leaf Suspension	
R	22-24	536 All Models with Peterbilt Low Air Leaf Suspension	
89456	D	145089-200 (1)	
R	11-16	KENWORTH T700 All Models with Air Glide 400 (AG400) Rear Air Suspension	
89458	D		
R	08-09	INTERNATIONAL 4300 All Models with International 40,000 lb Rear Air Suspension	
R	08-09	4400 All Models with International 40,000 lb Rear Air Suspension	
R	10-11	DURASTAR - 4300, 4400 SERIES	
R	19	MV SERIES	
89459	D	401754 (2)	
F	11-16	KENWORTH T700 All Models with 13,000 lb Front Axle	
89460	D		
F	10-14	KENWORTH T270 All Models with 10,000 lb to 12,000 lb Front Axle	
F	10-14	T270 All Models with 13,200 lb to 14,600 lb Front Axle	
F	10-14	T270 All Models with 8,000 lb Front Axle	
F	08-15	PETERBILT 325 All Models with 8,000 lb Front Axle	
89503	D		
F	02-08	FREIGHTLINER M2 106 All Models with 10000 to 12000 lb. Taper-leaf Spring Suspension	
F	02-08	M2 106 All Models with 6000 to 9000 lb Front axle	

Numerical listing

Shock	POP	Alternative No.	MTG Acc. Supplied
Pos.	Year	Application	
89503	D	(cont)	
F	01-09	STERLING TRUCK ACTERRA	
Cab Shock			
83006	D		
	95-05	FREIGHTLINER FL50 All Day Cab Suspensions with O.E.M. Number	
	96-05	FL60 All Day Cab Suspensions with O.E.M. Number	
83021	C		
	90-96	CHEVROLET C60 KODIAK All Truck Cabs with Link Cabmate Model GMC104TK	
	90-96	C70 KODIAK All Truck Cabs with Link Cabmate Model GMC104TK	
	03-09	C4500 KODIAK All Truck Cabs with Link Cabmate Model GMC104TK	
	03-09	C5500 KODIAK All Truck Cabs with Link Cabmate Model GMC104TK	
	90-91	C5500 KODIAK All Truck Cabs with Link Cabmate Model GMC104TK	
	97-09	C7500 KODIAK All Truck Cabs with Link Cabmate Model GMC104TK	
	91-05	FREIGHTLINER FL60 All Trucks with Link Cabmate Models	
		FRT153BC-A, FRT106BC or FRT106HD-A	
	03-09	GMC C4500 TOPKICK All Truck Cabs with Link Cabmate Model GMC104TK	
	03-09	C5500 TOPKICK All Truck Cabs with Link Cabmate Model GMC104TK	
	90-96	C6000 TOPKICK All Truck Cabs with Link Cabmate Model GMC104TK	
	03-09	C6500 TOPKICK All Truck Cabs with Link Cabmate Model GMC104TK	
	97-01	C6500 TOPKICK All Truck Cabs with Link Cabmate Model GMC104TK	
	90-96	C7000 TOPKICK All Truck Cabs with Link Cabmate Model GMC104TK	
	97-09	C7500 TOPKICK All Truck Cabs with Link Cabmate Model GMC104TK	
	96-97	MARMON HERRINGTON 57 GLIDER All Conventional Tractors with Link Cabmate Model MARC57-B	
	90-94	57 GLIDER All Conventional Tractors with Link Cabmate Model MARC57-B	
83024	D		
	11-16	KENWORTH T700 All Models with Extended Sleeper Cab	
83025	C		
	03-09	GMC C4500 TOPKICK All Models with Link Cabmate Model GMT560	
	03-09	C5500 TOPKICK All Models with Link Cabmate Model GMT560	
83040	D		
	02-24	FREIGHTLINER M2 106 All Day Cab Models with Spring Suspensions	
83054	D		
	02-20	INTERNATIONAL 4300 All Models with O.E.M. Number	
	02-19	4300LP All Models with O.E.M. Number	
	02-20	4400 All Models with O.E.M. Number	
	02-19	4400LP All Models with O.E.M. Number	
	15-20	DURASTAR All Models with O.E.M. Number	
	13	DURASTAR All Models with O.E.M. Number	
	19-23	HV607 All Models with O.E.M. Number	
83056	D		
	11-16	KENWORTH T700 All Models with 86" Sleepers with O.E.M. Number	
83066	C		
	23	MACK MD6	
	24	MD6 All Models with O.E.M. Number	

Numerical listing

Shock	POP	Alternative No.	MTG Acc. Supplied
Pos.	Year	Application	

83066 C (cont)
 21-22 MD6 All Models with O.E.M.
 Number

Cab Shock

Shock	POP	Alternative No.	MTG Acc. Supplied
Pos.	Year	Application	

Numerical listing

Shock	POP	Alternative No.	MTG Acc. Supplied
Pos.	Year	Application	



Medium Duty Shocks

(Alphabetical Listing)

(Numerical Listing)

Amortiguadores de servicio mediano

(Lista alfabética)

(Listado numérico)



Amortisseurs à usage moyen

(Liste alphabétique)

(Ordre numérique)

Gabriel[®]
THE ORIGINAL

APPLICATION GUIDE

Year	Fitment Notes	OEM#								
			Fleetline\ Gas SLX	Classic\ Ultra\ ProGuard\ Guardian	Max Control\ LTV Severe Duty\ Load Carrier	Steering Dampers\ Ultra\ Steering Stabilizer\ Cab Shock	Fleetline\ Gas SLX	Classic\ Ultra\ ProGuard\ Guardian	Max Control\ LTV Severe Duty\ Load Carrier\ HiJackers	Steering Dampers\ Ultra\ Steering Stabilizer\ Cab Shock

BERKSHIRE COACH

BERKSHIRE COACH

ULTRA 24

17-24	Coaches with Ford E350 or E450 Chassis	ASH1154 8C2418045DA 8C2Z-18124-D 8C2Z18124D 8C24-18045-DA ASH-1154	 ○		G63622	58622 77614				
		8C24-18080-DB 8C2Z18125D ASH-1136 8C2Z-18125-D 8C2418080DB ASH1136	 ○						G63623	58623 77623	

ULTRA 28

17-24	Coaches with Ford E450 Chassis	ASH1154 8C2418045DA 8C2Z-18124-D 8C2Z18124D 8C24-18045-DA ASH-1154	 ○		G63622	58622 77614				
		8C24-18080-DB 8C2Z18125D ASH-1136 8C2Z-18125-D 8C2418080DB ASH1136	 ○						G63623	58623 77623	

BLUE BIRD

BLUE BIRD

MICROBIRD TYPE A SCHOOL BUS

92-24	Models with Ford E350 or E450 Chassis	ASH1154 8C2418045DA 8C2Z-18124-D 8C2Z18124D 8C24-18045-DA ASH-1154 AT163G AT-163G	 ○		G63622	58622 77614				
		8C24-18080-DB 8C2Z18125D ASH-1136 8C2Z-18125-D AT164G 8C2418080DB ASH1136 AT-164G	 ○						G63623	58623 77623	

CHAMPION BUS INC.

CHAMPION BUS INC.



AMERICAN COACH

	Shuttle buses with Ford E350 or E450 Chassis (Up to 2023)	ASH1154 8C2418045DA 8C2Z-18124-D 8C2Z18124D 8C24-18045-DA ASH-1154 AT163G AT-163G	 ○		G63622	58622 77614				
		8C24-18080-DB 8C2Z18125D ASH-1136 8C2Z-18125-D AT164G 8C2418080DB ASH1136 AT-164G	 ○						G63623	58623 77623	

CHALLENGER

	Shuttle buses with Ford E350 or E450 Chassis (Up to 2023)	ASH1154 8C2418045DA 8C2Z-18124-D 8C2Z18124D 8C24-18045-DA ASH-1154 AT163G AT-163G	 ○		G63622	58622 77614				
--	---	--	-------	--	--------	----------------	------	--	--	--	--

APPLICATION GUIDE

Year	Fitment Notes	OEM#								
			Fleetline/ Gas SLX	Classic/ Ultra/ ProGuard/ Guardian	Max Control/ LTV Severe Duty/ Load Carrier	Steering Dampers/ Steering Stabilizer/ Cab Shock	Fleetline/ Gas SLX	Classic/ Ultra/ ProGuard/ Guardian	Max Control/ LTV Severe Duty/ Load Carrier/ HiJackers	Steering Dampers/ Steering Stabilizer/ Cab Shock

CHAMPION BUS INC.

CHAMPION BUS INC.

CHALLENGER (cont)

	Shuttle buses with Ford E350 or E450 Chassis (Up to 2023)	8C24-18080-DB 8C2Z18125D ASH-1136 8C2Z-18125-D AT164G 8C2418080DB ASH1136 AT-164G	 O	83221	 O	83221	G63623	58623 77623
--	---	--	-------	-------	------	------	------	-------	-------	--------	----------------	------

CRUSADER

	Shuttle buses with Ford E350 Chassis	ASH1154 8C2418045DA 8C2Z-18124-D 8C2Z18124D 8C24-18045-DA ASH-1154 AT163G AT-163G	 O	83221	G63622	58622 77614	 O	83221
		8C24-18080-DB 8C2Z18125D ASH-1136 8C2Z-18125-D AT164G 8C2418080DB ASH1136 AT-164G	 O	83221	 O	83221	G63623	58623 77623

LF TRANSPORT

	Shuttle buses with Ford E450 Chassis (Up to 2023)	ASH1154 8C2418045DA 8C2Z-18124-D 8C2Z18124D 8C24-18045-DA ASH-1154 AT163G AT-163G	 O	83221	G63622	58622 77614	 O	83221
		8C24-18080-DB 8C2Z18125D ASH-1136 8C2Z-18125-D AT164G 8C2418080DB ASH1136 AT-164G	 O	83221	 O	83221	G63623	58623 77623

VARIOUS

	GMC P6000 Chassis	22064230	 T	83136	 T	83136
--	-------------------	----------	-------	-------	------	------	------	-------	-------	------	------	------

CHEVROLET

CHEVROLET

4, 40, 4000 & 4500 SERIES

69-72	All - Exc. Tilt Cab	22012096 3192892	O O	83221	 O	83221
67-72	S-40 School Bus	22012096 3192892	O O	83221	 O	83221
69-70	D-D Forward Control with 9000 & 11000 lb. Axles - Exc. Tilt Cab	22012096 3192892	O O	83221	 O	83221
	D-D Forward Control with Tilt Cab	4940606 22012095	O O	83126	 O	83126
67-68	TDM 4 Cycle Detroit Diesel with Tandem Axle - Exc. Tilt Cab	22012096 3192892	O O	83221	 O	83221
60-68	C-40, P-40, SS-40 Models	O O	85005	 O	85005
68	Cowl - Exc. School Bus	22012096 3192892	O O	83221	 O	83221

5, 50, 5000 & 5500 SERIES

76-89	C Chassis - Conventional Cab	22012196	O O	83221	 O	83221
	C, M, S Chassis - Conventional Cab	22012169 22012096	O O	83221	 O	83221

APPLICATION GUIDE

Year	Fitment Notes	OEM#								
			Fleetline/ Gas SLX	Classic/ Ultra/ ProGuard/ Guardian	Max Control/ LTV Severe Duty/ Load Carrier	Steering Dampers/ Steering Stabilizer/ Cab Shock	Fleetline/ Gas SLX	Classic/ Ultra/ ProGuard/ Guardian	Max Control/ LTV Severe Duty/ Load Carrier/ HiJackers	Steering Dampers/ Steering Stabilizer/ Cab Shock

CHEVROLET

CHEVROLET



5, 50, 5000 & 5500 SERIES (cont)

75-80	C, M, S Chassis - Conventional Cab	4975510	○	83221
73-80	C, M, S Chassis - Conventional Cab	22007750 4975494 4975467	○	83207
71-72	TDM 4 Cycle Detroit Diesel with Tandem Axle - Exc. Tilt Cab	4940606 22012095	○	83126 89430
69-72	All - Exc. Tilt Cab	22012096 3192892	○	83221
69-70	D-D Forward Control with 9000 & 11000 lb. Axles - Exc. Tilt Cab	22012096 3192892	○	83221
	D-D Forward Control with Tilt Cab	4940606 22012095	○	83126
63-69	C-50, M-50, S-50, SE-50, T-50 Models	○	85005	83221
67-68	TDM 4 Cycle Detroit Diesel with Tandem Axle - Exc. Tilt Cab	22012096 3192892	○	83221
68	Cowl - Exc. School Bus	22012096 3192892	○	83221

6, 60, 6000 & 6500 SERIES

79-89	B6P042 School Bus (Axle codes F090, F120D)	22007753 22002295 22017531	○	83303
	B6P042 School Bus w/15000 lb. or 17000 lb. Rear Springs	22012169 22012096	○	83221
	B6P042 School Bus w/18500 or 20800 lb. Rear Springs	22012166 22012095	○	83126 89430
79-80	W Chassis - 72" BBC Steel Tilt Cab	22002293	○	83126
		22007751	○	83303
75-80	C, M, S Chassis - Conventional Cab and School Bus	4975510	○	83221
73-80	C, S, T Chassis - Conventional & Tilt Cab and School Bus with 5000 & 7000 lb. Axle	4940606 4975497 22007701 4940662 22002293 3192890 22012095	○	83126
		22007751	○	83303
76-78	SE-60 w/Hydraulic Brakes from Serial # 120000 (1975 2nd Design)	22012169 3192892	○	83221
73-78	S-60 w/Air Brakes	22007751	○	83303
		4940606 22012166 22007701 22012095	○	83126 89430
		3171069	○	85304
69-78	S-60	4975510 3192892	○	83221
73-75	C, M, S Chassis - Conventional Cab and School Bus with 5000 & 7000 lb. Axle	22007750 4975494 4975467	○	83207
		SE, SS-60 thru Serial # 134487 (1975 1st Design)	22007750 4975494 22007700 4975467	○	83207

APPLICATION GUIDE

Year	Fitment Notes	OEM#								
			Fleetline/ Gas SLX	Classic/ Ultra/ ProGuard/ Guardian	Max Control/ LTV Severe Duty/ Load Carrier	Steering Dampers/ Steering Stabilizer/ Cab Shock	Fleetline/ Gas SLX	Classic/ Ultra/ ProGuard/ Guardian	Max Control/ LTV Severe Duty/ Load Carrier/ HiJackers	Steering Dampers/ Steering Stabilizer/ Cab Shock

CHEVROLET

CHEVROLET

6, 60, 6000 & 6500 SERIES (cont)

73-74	SG, SM-60	3192890		83126
	SG, SM-61	4940606		83126
	SG, SM-62	22002293		83126
	SG, SM-63	22007701		83126
	SG, SM-64	22007751		83303
71-72	Conventional Cab & Tilt Cab with 9000 & 11000 lb. Axles	4940606 22012095		83126 89430
	TDM 4 Cycle Detroit Diesel with Tandem Axle	4940606 22012095		83126 89430
69-72	All - Exc. Tilt Cab	22012096 3192892		83221
69-70	D - D Forward Control with 9000 & 11000 lb. Axles - Exc. Tilt Cab	22012096 3192892		83221
68-69	All with 9000 & 11000 lb. Axles - Exc. Tilt Cab	4940606 22012095		83126
67-68	TDM 4 Cycle Detroit Diesel with Tandem Axle - Exc. Tilt Cab	22012096 3192892		83221
68	Cowl - Exc. School Bus	22012096 3192892		83221

B - SERIES - SCHOOL BUS

	Models with O.E.M. Number	88982682 15588554 22064230 15123676		83136
--	---------------------------	--	--	-------	------	------	------	------	------	------	------

B6

90-07	B6, B7 Model School Bus Chassis	15174902 22064232		85071
-------	---------------------------------	----------------------	--	------	------	------	------	-------	------	------	------

B7

93-02	With 15000, 19000, 21000 lb Multileaf Springs	15174902 22064232		85071
-------	---	----------------------	--	------	------	------	------	-------	------	------	------



C - SERIES (C6500, C7500, C8500) KODIAK

	Models with O.E.M. Number	88982684		83136
--	---------------------------	----------	--	-------	------	------	------	------	------	------	------

C60 KODIAK

90-96	Conventional Cab w/ Front Shock with O.E.M. Number	88982682 15588554 15887728 15174898 19152843 22064230 15123676		83136
	Conventional Cab w/15000, 19000, 21000 lb Multileaf Springs	15174902 88982686 22064232		85071
	Conventional Cab w/19000, 21000, 23000 lb Taperleaf Springs (EXC Low Profile Vehicle)	22064233		83136
	Truck Cabs with Link Cabmate Model GMC104TK	12020054 12010054 1201-0054 1202-0054		83021

APPLICATION GUIDE

Year	Fitment Notes	OEM#								
			Fleetline\ Gas SLX	Classic\ Ultra\ ProGuard\ Guardian	Max Control\ LTV Severe Duty\ Load Carrier	Steering Dampers\ Steering Stabilizer\ Cab Shock	Fleetline\ Gas SLX	Classic\ Ultra\ ProGuard\ Guardian	Max Control\ LTV Severe Duty\ Load Carrier\ HiJackers	Steering Dampers\ Steering Stabilizer\ Cab Shock

CHEVROLET

CHEVROLET

C70 KODIAK

90-96	Conventional Cab w/ Front Shock with O.E.M. Number	88982682 15588554 15887728 15174898 19152843 22064230 15123676	 T	83136
	Conventional Cab w/15000, 19000, 21000 lb Multileaf Springs	15174902 88982686 22064232	 T	85071
	Conventional Cab w/19000, 21000, 23000 lb Taperleaf Springs (EXC Low Profile Vehicle)	22064233	 T	83136
	Truck Cabs with Link Cabmate Model GMC104TK	12020054 12010054 1201-0054 1202-0054	O O	83021





C4500 KODIAK

03-09	C Chassis - Conventional Cab	88982682 15588554 15887728 19152843 22064230 15123676	 T	83136
	C Chassis - Conventional Cab w/19000, 21000, 23000 lb Taperleaf Springs (EXC Low Profile Vehicle)	22064233	 T	83136
	C Chassis - Conventional Cab With 15000, 19000, 21000 lb Multileaf Springs	15174902 88982686 22064232	 T	85071
	Truck Cabs with Link Cabmate Model GMC104TK	12020054 12010054 1201-0054 1202-0054	O O	83021
90-02	C Chassis - Conventional Cab	88982682 15588554 15887728 19152843 22064230 15123676	 T	83136
	C Chassis - Conventional Cab w/19000, 21000, 23000 lb Taperleaf Springs (EXC Low Profile Vehicle)	22064233	 T	83136
	C Chassis - Conventional Cab With 15000, 19000, 21000 lb Multileaf Springs	15174902 88982686 22064232	 T	85071
83-99	C Chassis - Conventional Cab with 9100 to 17500 lb Rear Axle	22064432	O O	83221

C5500 KODIAK

03-09	C Chassis - Conventional Cab	88982682 15588554 15887728 19152843 22064230 15123676	 T	83136
	C Chassis - Conventional Cab w/19000, 21000, 23000 lb Taperleaf Springs (EXC Low Profile Vehicle)	22064233	 T	83136

APPLICATION GUIDE

Year	Fitment Notes	OEM#								
			 Fleetline\ Gas SLX	Classic\ Ultra\ ProGuard\ Guardian	Max Control\ LTV Severe Duty\ Load Carrier	Steering Dampers\ Steering Stabilizer\ Cab Shock	 Fleetline\ Gas SLX	Classic\ Ultra\ ProGuard\ Guardian	Max Control\ LTV Severe Duty\ Load Carrier\ HiJackers	Steering Dampers\ Steering Stabilizer\ Cab Shock

CHEVROLET

CHEVROLET

C5500 KODIAK (cont)

03-09	C Chassis - Conventional Cab With 15000, 19000, 21000 lb Multileaf Springs	15174902 88982686 22064232	85071
	Truck Cabs with Link Cabmate Model GMC104TK	12020054 12010054 1201-0054 1202-0054	OO	83021
92-02	C Chassis - Conventional Cab	88982682 15588554 15887728 19152843 22064230 15123676	I	83136
	C Chassis - Conventional Cab w/19000, 21000, 23000 lb Taperleaf Springs (EXC Low Profile Vehicle)	22064233	83136
	C Chassis - Conventional Cab With 15000, 19000, 21000 lb Multileaf Springs	15174902 88982686 22064232	I	85071
92-99	C Chassis - Conventional Cab with 9100 to 17500 lb Rear Axle	22064432	OO	83221
90-91	C Chassis - Conventional Cab	88982682 15588554 15887728 19152843 22064230 15123676	I	83136
	C Chassis - Conventional Cab w/19000, 21000, 23000 lb Taperleaf Springs (EXC Low Profile Vehicle)	22064233	I	83136
	C Chassis - Conventional Cab With 15000, 19000, 21000 lb Multileaf Springs	15174902 88982686 22064232	I	85071
	C Chassis - Conventional Cab with 9100 to 17500 lb Rear Axle	22064432	OO	83221
	Truck Cabs with Link Cabmate Model GMC104TK	12020054 12010054 1201-0054 1202-0054	OO	83021
83-89	C Chassis - Conventional Cab with 9100 to 17500 lb Rear Axle	22064432	OO	83221

C6500 KODIAK

97-09	Conventional Cab w/ Front Shock with O.E.M. Number	88982682 15588554 15887728 15174898 19152843 22064230 15123676	I	83136
	Conventional Cab w/15000, 19000, 21000 lb Multileaf Springs	15174902 88982686 22064232	I	85071
	Conventional Cab w/19000, 21000, 23000 lb Taperleaf Springs (EXC Low Profile Vehicle)	22064233	I	83136

APPLICATION GUIDE

Year	Fitment Notes	OEM#								
			Fleetline\ Gas SLX	Classic\ Ultra\ ProGuard\ Guardian	Max Control\ LTV Severe Duty\ Load Carrier	Steering Dampers\ Steering Stabilizer\ Cab Shock	Fleetline\ Gas SLX	Classic\ Ultra\ ProGuard\ Guardian	Max Control\ LTV Severe Duty\ Load Carrier\ HiJackers	Steering Dampers\ Steering Stabilizer\ Cab Shock

CHEVROLET

CHEVROLET

C6500 KODIAK (cont)

97-09	Models with Hendrickson Air Suspension (Stamping number 47902-13)	12474915 15963161	83122 89406
	Models with Hendrickson Air Suspension with O.E.M. Number	60670-005 060665-003 12474917 15740554 59057-001 47902-29	83137
	Truck Cabs with Link Cabmate Model GMC104TK	12020054 12010054 1201-0054 1202-0054	O O	83021
97-99	Conventional Cab with 9100 to 17500 lb Rear Axle	22064432	83221
83-96	Conventional Cab with 9100 to 17500 lb Rear Axle	22064432	83221

C7500 KODIAK

97-09	Conventional Cab w/ Front Shock with O.E.M. Number	88982682 15588554 15887728 15174898 19152843 22064230 15123676	I I	83136	
	Conventional Cab w/15000, 19000, 21000 lb Multileaf Springs	15174902 88982686 22064232	I I	85071	
	Conventional Cab w/19000, 21000, 23000 lb Taperleaf Springs (EXC Low Profile Vehicle)	22064233	I I	83136	
	Models with Hendrickson Air Suspension (Stamping number 47902-13)	12474915 15963161	O O	83122 89406
	Models with Hendrickson Air Suspension with O.E.M. Number	60670-005 060665-003 12474917 15740554 59057-001 47902-29	O O	83137
	Truck Cabs with Link Cabmate Model GMC104TK	12020054 12010054 1201-0054 1202-0054	O O	83021
97-99	Conventional Cab with 9100 to 17500 lb Rear Axle	22064432	O O	83221	

C8500

03-09	Models with Hendrickson Air Suspension with O.E.M. Number	60670-005 060665-003 12474917 15740554 59057-001 47902-29	O O	83137
-------	---	--	--------	-------	------	------	------	------	------	------



EXPRESS 4500

09-22	All		I O	61685 G63895	O O	61687 G63897	58638 77638
-------	-----	--	--------	------	-----------------	------	------	--------	------	-----------------	----------------	------

LCF 3500

16-23	All	98381010 98232671	I O	83515
		98380746	O O	83159

APPLICATION GUIDE

Year	Fitment Notes	OEM#								
			Fleetline\ Gas SLX	Classic\ Ultra\ ProGuard\ Guardian	Max Control\ LTV Severe Duty\ Load Carrier	Steering Dampers\ Steering Stabilizer\ Cab Shock	Fleetline\ Gas SLX	Classic\ Ultra\ ProGuard\ Guardian	Max Control\ LTV Severe Duty\ Load Carrier\ HiJackers	Steering Dampers\ Steering Stabilizer\ Cab Shock

CHEVROLET

CHEVROLET

LCF 3500HD

18	All	98381010		83515
		98232671	
		98380746	
16-17	All	98381010		83515
		98232671	
		98380746	

P60

92-96	Motorhome Chassis	22064233	
				83136

P6000

92-96	Motorhome Chassis	22064233	
				83136



SILVERADO 4500 HD

19-22	Diesel Low Cab Forward models with 14,000 to 15,000 lb Rear	8983807460 8-98380-746-0	
	Diesel Low Cab Forward models with 14,500 lb GVWR	8983810100 8-98381-010-0		83515
	Diesel Low Cab Forward models with 15,000 to 16,000 lb Rear	8983807470 8-98380-747-0	
	Diesel Low Cab Forward models with 16,000 lb to 19,500 lb GVWR	8983810120 8-98381-012-0		83515
	Models with 11K, 13.5K or 15.5K VARI-RATE Rear Suspension	4208946C1 4206863C1	
	Models with 7,000 to 8,000 lb Front Axle	3989717C1		83135
	Models with IROS Rear	4214011C2	
	Models with Taperleaf Front	4109582C1 4089293C1 4109583C1 4207304C1		83397
19-21	Models with 4 x 4 Rear	4109458C2	

SILVERADO 5500 HD

19-23	Models with 11K, 13.5K or 15.5K VARI-RATE Rear Suspension	4208946C1 4206863C1	
	Models with Taperleaf Front	4109582C1 4089293C1 4109583C1 4207304C1		83397
19-22	Diesel Low Cab Forward models with 14,000 to 15,000 lb Rear	8983807460 8-98380-746-0	
	Diesel Low Cab Forward models with 14,500 lb GVWR	8983810100 8-98381-010-0		83515
	Diesel Low Cab Forward models with 15,000 to 16,000 lb Rear	8983807470 8-98380-747-0	
	Diesel Low Cab Forward models with 16,000 lb to 19,500 lb GVWR	8983810120 8-98381-012-0		83515

APPLICATION GUIDE

Year	Fitment Notes	OEM#								
			Fleetline\ Gas SLX	Classic\ Ultra\ ProGuard\ Guardian	Max Control\ LTV Severe Duty\ Load Carrier	Steering Dampers\ Steering Stabilizer\ Cab Shock	Fleetline\ Gas SLX	Classic\ Ultra\ ProGuard\ Guardian	Max Control\ LTV Severe Duty\ Load Carrier\ HiJackers	Steering Dampers\ Steering Stabilizer\ Cab Shock

CHEVROLET

CHEVROLET

SILVERADO 5500 HD (cont)

19-22	Models with 4 x 4 Rear	4109458C2		83136		83136		83136		83136		83136		83136
	Models with 7,000 to 8,000 lb Front Axle	3989717C1		83136		83136		83136		83136		83136		83136
	Models with IROS Rear	4214011C2		83136		83136		83136		83136		83136		83136

SILVERADO 6500 HD

19-23	Models with 11K, 13.5K or 15.5K VARI-RATE Rear Suspension	4208946C1 4206863C1		83136		83136		83136		83136		83136		83136
	Models with Taperleaf Front	4109582C1 4089293C1 4109583C1 4207304C1		83136		83136		83136		83136		83136		83136
19-22	Models with 4 x 4 Rear	4109458C2		83136		83136		83136		83136		83136		83136
	Models with 7,000 to 8,000 lb Front Axle	3989717C1		83136		83136		83136		83136		83136		83136
	Models with IROS Rear	4214011C2		83136		83136		83136		83136		83136		83136



T5500

97-09	FL1 Tilt Cab with 8100 lb Axle	22165188 22165187 22064804 22064805		83136		83136		83136		83136		83136		83136
	FL2 Tilt Cab with 5000 to 11000 lb Axle	22166442 22064807		83136		83136		83136		83136		83136		83136
	FL3 Tilt Cab with 14575 lb Axle	22165189 22064806		83136		83136		83136		83136		83136		83136
90-06	Tilt Cab w/15000, 19000, 21000 lb Multileaf Springs	15174902 22064232		83136		83136		83136		83136		83136		83136
92-99	Tilt Cab w/19000, 21000, 23000 lb Taperleaf Springs (EXC Low Profile Veh.)	22064233		83136		83136		83136		83136		83136		83136

T6500

04-09	FL1 Tilt Cab with 8100 lb Axle	22165188 22165187 22064804 22064805		83136		83136		83136		83136		83136		83136
	FL2 Tilt Cab with 5000 to 11000 lb Axle	22166442 22064807		83136		83136		83136		83136		83136		83136
	FL3 Tilt Cab with 14575 lb Axle	22165189 22064806		83136		83136		83136		83136		83136		83136
04-06	Tilt Cab w/15000, 19000, 21000 lb Multileaf Springs	15174902 22064232		83136		83136		83136		83136		83136		83136
03	FL1 Tilt Cab with 8100 lb Axle	22165188 22165187 22064804 22064805		83136		83136		83136		83136		83136		83136
	FL2 Tilt Cab with 5000 to 11000 lb Axle	22166442 22064807		83136		83136		83136		83136		83136		83136
	FL3 Tilt Cab with 14575 lb Axle	22165189 22064806		83136		83136		83136		83136		83136		83136
	Tilt Cab w/15000, 19000, 21000 lb Multileaf Springs	15174902 22064232		83136		83136		83136		83136		83136		83136
97-02	FL1 Tilt Cab with 8100 lb Axle	22165188 22165187 22064804 22064805		83136		83136		83136		83136		83136		83136

APPLICATION GUIDE

Year	Fitment Notes	OEM#								
			Fleetline\ Gas SLX	Classic\ Ultra\ ProGuard\ Guardian	Max Control\ LTV Severe Duty\ Load Carrier	Steering Dampers\ Steering Stabilizer\ Cab Shock	Fleetline\ Gas SLX	Classic\ Ultra\ ProGuard\ Guardian	Max Control\ LTV Severe Duty\ Load Carrier\ HiJackers	Steering Dampers\ Steering Stabilizer\ Cab Shock

CHEVROLET

CHEVROLET

T6500 (cont)

97-02	FL2 Tilt Cab with 5000 to 11000 lb Axle	22166442 22064807	 I	83136
	FL3 Tilt Cab with 14575 lb Axle	22165189 22064806	 I	83136
	Tilt Cab w/15000, 19000, 21000 lb Multileaf Springs	15174902 22064232	 I	85071
97-99	Tilt Cab w/19000, 21000, 23000 lb Taperleaf Springs (EXC Low Profile Veh.)	22064233	 I	83136
99	Models with Hendrickson Air Suspension (Stamping number 47902-13)	12474915 15963161	 O	83122 89406
92-96	Tilt Cab w/19000, 21000, 23000 lb Taperleaf Springs (EXC Low Profile Veh.)	22064233	 I	83136
90-96	Tilt Cab w/15000, 19000, 21000 lb Multileaf Springs	15174902 22064232	 I	85071

W4500 TILTMASER

87-10	Models with 11000 lb & 13000 lb Suspension	9516306471 97083029 94454987 98232671 97083027 8972536200 97253620 8-97253-620-0 8944549870 8944549860 9-51630-647-1 8-94454-986-0 8-94454-987-0	 O	83515
-------	--	--	-------	-------	------	------	------	------	------	------	------

W5500 TILTMASER

88-10	Models with 11000 lb & 13000 lb Suspension	97253620	 O	83515
-------	--	----------	-------	-------	------	------	------	------	------	------	------

W6500 TILTMASER

87-96	Models with 11000 lb & 13000 lb Suspension	1516301681 1-51630-168-1	 O	83515
-------	--	-----------------------------	-------	-------	------	------	------	------	------	------	------

CHRYSLER

CHRYSLER

MOTORHOME CHASSIS

73-81	M & R-300, 400, 500 Motorhome Chassis	3638112	 O	G63183
63-72	M-300, M-375 & R-375 Motorhome Chassis	2961043 3633744	 O	G63183





COACH HOUSE

COACH HOUSE

PLATINUM

03-24	Motorhomes with Ford E450 Chassis	ASH1154 8C2418045DA 8C2Z-18124-D 8C2Z18124D 8C24-18045-DA ASH-1154 AT163G AT-163G	 O	G63622	58622 77614
-------	-----------------------------------	--	-------	------	--------	----------------	------	------	------	------	------

APPLICATION GUIDE

Year	Fitment Notes	OEM#								
			 Fleetline\ Gas SLX	Classic\ Ultra\ ProGuard\ Guardian	Max Control\ LTV Severe Duty\ Load Carrier	Steering Dampers\ Steering Stabilizer\ Cab Shock	 Fleetline\ Gas SLX	Classic\ Ultra\ ProGuard\ Guardian	Max Control\ LTV Severe Duty\ Load Carrier\ HiJackers	Steering Dampers\ Steering Stabilizer\ Cab Shock



COACH HOUSE

COACH HOUSE





PLATINUM (cont)

03-24	Motorhomes with Ford E450 Chassis	8C24-18080-DB 8C2Z18125D ASH-1136 8C2Z-18125-D AT164G 8C2418080DB ASH1136 AT-164G		G63623	58623 77623
-------	-----------------------------------	--	-------	-------	-------	-------	---	-------	--------	----------------	-------

PLATINUM III

21-22	MotorHomes with Ford Transit-350 Chassis			G57816 ⁴⁰		G64177
-------	--	--	---	-------	----------------------	-------	-------	---	-------	--------	-------	-------





PLATINUM IV

23-24	Motorhomes with Ford E450 Chassis	ASH1154 8C2418045DA 8C2Z-18124-D 8C2Z18124D 8C24-18045-DA ASH-1154 AT163G AT-163G		G63622	58622 77614	
		8C24-18080-DB 8C2Z18125D ASH-1136 8C2Z-18125-D AT164G 8C2418080DB ASH1136 AT-164G			G63623	58623 77623





COACHMEN

COACHMEN

AURORA

09	MotorHomes with Ford F53 Chassis with 16,000 lb GVW to 22,000 lb GVW	ASH-1229 ASH-1228 9U94-18045-AA ASH-1205 AT-620 ASH25823 ASH-1022 ASH1022 1C3418045JA ASH-25822 ASH1205 ASH-25823 ASH1228 ASH1229 AT620 1C34-18045-JA AT766 9U9Z18124A ASH294 1C3418045AA 1C34-18045-AA ASH-294 9U9418045AA 9U9Z-18124-A ASH25822 AT-766		83209	
		9U9Z18125A ASH-1206 ASH137 AT-621 ASH-25824 ASH-1023 ASH25824 ASH-1230 9U9418080AA ASH1230 ASH1023 9U94-18080-AA 9U9Z-18125-A AT621 ASH1206 ASH-137			83122 89406

APPLICATION GUIDE

Year	Fitment Notes	OEM#								
			 Fleetline\ Gas SLX	Classic\ Ultra\ ProGuard\ Guardian	Max Control\ LTV Severe Duty\ Load Carrier	Steering Dampers\ Steering Stabilizer\ Cab Shock	 Fleetline\ Gas SLX	Classic\ Ultra\ ProGuard\ Guardian	Max Control\ LTV Severe Duty\ Load Carrier\ HiJackers	Steering Dampers\ Steering Stabilizer\ Cab Shock



COACHMEN

COACHMEN

AURORA (cont)

08	MotorHomes with Ford F53 Chassis with 16,000 lb GVW to 22,000 lb GVW	ASH-1229 ASH-1228 9U94-18045-AA ASH-1205 AT-620 ASH25823 ASH-1022 ASH1022 1C3418045JA ASH-25822 ASH1205 ASH-25823 ASH1228 ASH1229 AT620 1C34-18045-JA AT766 9U9Z18124A ASH294 1C3418045AA 1C34-18045-AA ASH-294 9U9418045AA 9U9Z-18124-A ASH25822 AT-766	OO	83209	
		9U9Z18125A ASH-1206 ASH137 AT-621 ASH-25824 ASH-1023 ASH25824 ASH-1230 9U9418080AA ASH1230 ASH1023 9U94-18080-AA 9U9Z-18125-A AT621 ASH1206 ASH-137	OO			OO	83122 89406
07	MotorHomes with Ford F53 Chassis with 16,000 lb GVW to 22,000 lb GVW	ASH-1229 ASH-1228 9U94-18045-AA ASH-1205 AT-620 ASH25823 ASH-1022 ASH1022 1C3418045JA ASH-25822 ASH1205 ASH-25823 ASH1228 ASH1229 AT620 1C34-18045-JA AT766 9U9Z18124A ASH294 1C3418045AA 1C34-18045-AA ASH-294 9U9418045AA 9U9Z-18124-A ASH25822 AT-766	OO	83209	
		9U9Z18125A ASH-1206 ASH137 AT-621 ASH-25824 ASH-1023 ASH25824 ASH-1230 9U9418080AA ASH1230 ASH1023 9U94-18080-AA 9U9Z-18125-A AT621 ASH1206 ASH-137	OO			OO	83122 89406

APPLICATION GUIDE

Year	Fitment Notes	OEM#								
			Fleetline\ Gas SLX	Classic\ Ultra\ ProGuard\ Guardian	Max Control\ LTV Severe Duty\ Load Carrier	Steering Dampers\ Steering Stabilizer\ Cab Shock	Fleetline\ Gas SLX	Classic\ Ultra\ ProGuard\ Guardian	Max Control\ LTV Severe Duty\ Load Carrier\ HiJackers	Steering Dampers\ Steering Stabilizer\ Cab Shock

COACHMEN

COACHMEN

AURORA (cont)

04-06	MotorHomes with Ford F53 Chassis with 16,000 lb GVW to 22,000 lb GVW	ASH-1229 ASH-1228 9U94-18045-AA ASH-1205 AT-620 ASH25823 ASH-1022 ASH1022 1C3418045JA ASH-25822 ASH1205 ASH-25823 ASH1228 ASH1229 AT620 1C34-18045-JA AT766 9U9Z18124A ASH294 1C3418045AA 1C34-18045-AA ASH-294 9U9418045AA 9U9Z-18124-A ASH25822 AT-766	O	83209
		9U9Z18125A ASH-1206 ASH137 AT-621 ASH-25824 ASH-1023 ASH25824 ASH-1230 9U9418080AA ASH1230 ASH1023 9U94-18080-AA 9U9Z-18125-A AT621 ASH1206 ASH-137	O	83122 89406

BEYOND

19-22	MotorHomes with Ford Transit-350 Chassis		I	G57816 ⁴⁰	O	G64177
-------	--	--	---	------	----------------------	------	------	------	---	------	--------	------	------

CATALINA

	MotorHomes with Ford E350 or E450 Chassis	ASH1154 8C2418045DA 8C2Z-18124-D 8C2Z18124D 8C24-18045-DA ASH-1154 AT163G AT-163G	I	G63622	58622 77614	O
		8C24-18080-DB 8C2Z18125D ASH-1136 8C2Z-18125-D AT164G 8C2418080DB ASH1136 AT-164G	O	O	G63623	58623 77623





CLASS A MOTORHOMES

	MotorHomes with Freightliner XC Chassis	66153-002 66153002 F4-BE5-C832-MO F4BE5C832MO	O	83124	O
--	---	--	---	-------	------	------	------	------	---	------	------	------	------

CONCORD

24	MotorHomes with Ford E350 or E450 Chassis	ASH1154 8C2418045DA 8C2Z-18124-D 8C2Z18124D 8C24-18045-DA ASH-1154 AT163G AT-163G	I	G63622	58622 77614	O
----	---	--	---	------	--------	----------------	------	------	---	------	------	------	------

APPLICATION GUIDE

Year	Fitment Notes	OEM#								
			 Fleetline/ Gas SLX	Classic/ Ultra/ ProGuard/ Guardian	Max Control/ LTV Severe Duty/ Load Carrier	Steering Dampers/ Steering Stabilizer/ Cab Shock	 Fleetline/ Gas SLX	Classic/ Ultra/ ProGuard/ Guardian	Max Control/ LTV Severe Duty/ Load Carrier/ HiJackers	Steering Dampers/ Steering Stabilizer/ Cab Shock

COACHMEN

COACHMEN



CONCORD (cont)

24	MotorHomes with Ford E350 or E450 Chassis	8C24-18080-DB 8C2Z18125D ASH-1136 8C2Z-18125-D AT164G 8C2418080DB ASH1136 AT-164G	 O	 O	G63623	58623 77623
23	MotorHomes with Ford E350 or E450 Chassis	8C2418045DA 8C2Z-18124-D 8C2Z18124D 8C24-18045-DA ASH-1154 AT163G AT-163G	 O	G63622	58622 77614	 O
		8C24-18080-DB 8C2Z18125D ASH-1136 8C2Z-18125-D AT164G 8C2418080DB ASH1136 AT-164G	 O	 O	G63623	58623 77623
20-22	MotorHomes with Ford E350 or E450 Chassis	ASH1154 8C2418045DA 8C2Z-18124-D 8C2Z18124D 8C24-18045-DA ASH-1154 AT163G AT-163G	 O	G63622	58622 77614	 O
		8C24-18080-DB 8C2Z18125D ASH-1136 8C2Z-18125-D AT164G 8C2418080DB ASH1136 AT-164G	 O	 O	G63623	58623 77623
07-19	MotorHomes with Ford E350 or E450 Chassis	ASH1154 8C2418045DA 8C2Z-18124-D 8C2Z18124D 8C24-18045-DA ASH-1154 AT163G AT-163G	 O	G63622	58622 77614	 O
		8C24-18080-DB 8C2Z18125D ASH-1136 8C2Z-18125-D AT164G 8C2418080DB ASH1136 AT-164G	 O	 O	G63623	58623 77623
04-06	MotorHomes with Ford E350 or E450 Chassis	ASH1154 8C2418045DA 8C2Z-18124-D 8C2Z18124D 8C24-18045-DA ASH-1154 AT163G AT-163G	 O	G63622	58622 77614	 O
		8C24-18080-DB 8C2Z18125D ASH-1136 8C2Z-18125-D AT164G 8C2418080DB ASH1136 AT-164G	 O	 O	G63623	58623 77623

CROSS COUNTRY

06	MotorHomes with Freightliner XC Chassis	16-16874-000 1616874000 1616737000 16-16737-000 141700131810	 O	83160	 O
		1618103000 16-18103-000 481700000493	 O	85900	 O

APPLICATION GUIDE

Year	Fitment Notes	OEM#								
			Fleetline\ Gas SLX	Classic\ Ultra\ ProGuard\ Guardian	Max Control\ LTV Severe Duty\ Load Carrier	Steering Dampers\ Steering Stabilizer\ Cab Shock	Fleetline\ Gas SLX	Classic\ Ultra\ ProGuard\ Guardian	Max Control\ LTV Severe Duty\ Load Carrier\ HiJackers	Steering Dampers\ Steering Stabilizer\ Cab Shock

COACHMEN

COACHMEN

CROSS COUNTRY (cont)

06	MotorHomes with Freightliner XC Chassis	1616873000 16-16873-000 141700131809 1616736000 16-16736-000		83160		85029
----	---	--	--	-------	------	------	------	------	--	-------	------	------	------

CROSS COUNTRY ELITE

03-05	MotorHomes with Freightliner XC Chassis	16-16874-000 1616874000 1616737000 16-16737-000 141700131810		83160		85029
		1618103000 16-18103-000 481700000493		85900		85029
		1616873000 16-16873-000 141700131809 1616736000 16-16736-000		85029		85029

CROSS COUNTRY SE

03-05	MotorHomes with Freightliner XC Chassis	16-16874-000 1616874000 1616737000 16-16737-000 141700131810		83160		85029
		1618103000 16-18103-000 481700000493		85900		85029
		1616873000 16-16873-000 141700131809 1616736000 16-16736-000		85029		85029



CROSS TRAIL TRANSIT

21-22	MotorHomes with Ford Transit-350 Chassis			83160	G57816 ⁴⁰		85029	G64177
-------	--	--	--	-------	------	----------------------	------	------	--	-------	------	--------	------	------

ENCORE

21-24	MotorHomes with Ford F53 Chassis with 16,000 lb GVW to 22,000 lb GVW	ASH-1229 ASH-1228 9U94-18045-AA ASH-1205 AT-620 ASH25823 ASH-1022 ASH1022 1C3418045JA ASH-25822 ASH1205 ASH-25823 ASH1228 ASH1229 AT620 1C34-18045-JA AT766 9U9Z18124A ASH294 1C3418045AA 1C34-18045-AA ASH-294 9U9418045AA 9U9Z-18124-A ASH25822 AT-766		83209		85029
-------	--	---	--	-------	------	------	------	------	--	-------	------	------	------	------

APPLICATION GUIDE

Year	Fitment Notes	OEM#								
			Fleetline\ Gas SLX	Classic\ Ultra\ ProGuard\ Guardian	Max Control\ LTV Severe Duty\ Load Carrier	Steering Dampers\ Steering Stabilizer\ Cab Shock	Fleetline\ Gas SLX	Classic\ Ultra\ ProGuard\ Guardian	Max Control\ LTV Severe Duty\ Load Carrier\ HiJackers	Steering Dampers\ Steering Stabilizer\ Cab Shock

COACHMEN

COACHMEN

ENCORE (cont)

21-24	MotorHomes with Ford F53 Chassis with 16,000 lb GVW to 22,000 lb GVW	9U9Z18125A ASH-1206 ASH137 AT-621 ASH-25824 ASH-1023 ASH25824 ASH-1230 9U9418080AA ASH1230 ASH1023 9U94-18080-AA 9U9Z-18125-A AT621 ASH1206 ASH-137	83122 89406
-------	--	--	------	------	------	------	----------------	------	------	------





ENCOUNTER

11-16	MotorHomes with Ford F53 Chassis with 16,000 lb GVW to 22,000 lb GVW	ASH-1229 ASH-1228 9U94-18045-AA ASH-1205 AT-620 ASH25823 ASH-1022 ASH1022 1C3418045JA ASH-25822 ASH1205 ASH-25823 ASH1228 ASH1229 AT620 1C34-18045-JA AT766 9U9Z18124A ASH294 1C3418045AA 1C34-18045-AA ASH-294 9U9418045AA 9U9Z-18124-A ASH25822 AT-766	83209
		9U9Z18125A ASH-1206 ASH137 AT-621 ASH-25824 ASH-1023 ASH25824 ASH-1230 9U9418080AA ASH1230 ASH1023 9U94-18080-AA 9U9Z-18125-A AT621 ASH1206 ASH-137	83122 89406

FREEDOM EXPRESS

09	MotorHomes with Ford E350 or E450 Chassis	ASH1154 8C2418045DA 8C2Z-18124-D 8C2Z18124D 8C24-18045-DA ASH-1154 AT163G AT-163G	G63622	58622 77614
		8C24-18080-DB 8C2Z18125D ASH-1136 8C2Z-18125-D AT164G 8C2418080DB ASH1136 AT-164G	G63623	58623 77623
04-08	MotorHomes with Ford E350 or E450 Chassis	ASH1154 8C2418045DA 8C2Z-18124-D 8C2Z18124D 8C24-18045-DA ASH-1154 AT163G AT-163G	G63622	58622 77614

APPLICATION GUIDE

Year	Fitment Notes	OEM#								
			 Fleetline\ Gas SLX	Classic\ Ultra\ ProGuard\ Guardian	Max Control\ LTV Severe Duty\ Load Carrier	Steering Dampers\ Steering Stabilizer\ Cab Shock	 Fleetline\ Gas SLX	Classic\ Ultra\ ProGuard\ Guardian	Max Control\ LTV Severe Duty\ Load Carrier\ Hijackers	Steering Dampers\ Steering Stabilizer\ Cab Shock

COACHMEN

COACHMEN

FREEDOM EXPRESS (cont)

04-08	MotorHomes with Ford E350 or E450 Chassis	8C24-18080-DB 8C2Z18125D ASH-1136 8C2Z-18125-D AT164G 8C2418080DB ASH1136 AT-164G											
-------	---	--	--	--	--	--	--	--	--	--	--	--	--



FREELANDER

08-24	MotorHomes with Ford E350 or E450 Chassis	ASH1154 8C2418045DA 8C2Z-18124-D 8C2Z18124D 8C24-18045-DA ASH-1154 AT163G AT-163G			G63622	58622 77614							
		8C24-18080-DB 8C2Z18125D ASH-1136 8C2Z-18125-D AT164G 8C2418080DB ASH1136 AT-164G							G63623	58623 77623			
03-07	MotorHomes with Ford E350 or E450 Chassis	ASH1154 8C2418045DA 8C2Z-18124-D 8C2Z18124D 8C24-18045-DA ASH-1154 AT163G AT-163G			G63622	58622 77614							
		8C24-18080-DB 8C2Z18125D ASH-1136 8C2Z-18125-D AT164G 8C2418080DB ASH1136 AT-164G							G63623	58623 77623			

LEPRECHAUN

11-23	MotorHomes with Ford E350 or E450 Chassis	ASH1154 8C2418045DA 8C2Z-18124-D 8C2Z18124D 8C24-18045-DA ASH-1154 AT163G AT-163G			G63622	58622 77614							
		8C24-18080-DB 8C2Z18125D ASH-1136 8C2Z-18125-D AT164G 8C2418080DB ASH1136 AT-164G							G63623	58623 77623			
10	MotorHomes with Ford E350 or E450 Chassis	ASH1154 8C2418045DA 8C2Z-18124-D 8C2Z18124D 8C24-18045-DA ASH-1154 AT163G AT-163G			G63622	58622 77614							
		8C24-18080-DB 8C2Z18125D ASH-1136 8C2Z-18125-D AT164G 8C2418080DB ASH1136 AT-164G							G63623	58623 77623			

APPLICATION GUIDE

Year	Fitment Notes	OEM#								
			Fleetline\ Gas SLX	Classic\ Ultra\ ProGuard\ Guardian	Max Control\ LTV Severe Duty\ Load Carrier	Steering Dampers\ Steering Stabilizer\ Cab Shock	Fleetline\ Gas SLX	Classic\ Ultra\ ProGuard\ Guardian	Max Control\ LTV Severe Duty\ Load Carrier\ HiJackers	Steering Dampers\ Steering Stabilizer\ Cab Shock

COACHMEN

COACHMEN





LEPRECHAUN (cont)

08-09	MotorHomes with Ford E350 or E450 Chassis	ASH1154 8C2418045DA 8C2Z-18124-D 8C2Z18124D 8C24-18045-DA ASH-1154 AT163G AT-163G	 O	G63622	58622 77614	 O
		8C24-18080-DB 8C2Z18125D ASH-1136 8C2Z-18125-D AT164G 8C2418080DB ASH1136 AT-164G	 O	G63623	58623 77623
03-07	MotorHomes with Ford E350 or E450 Chassis	ASH1154 8C2418045DA 8C2Z-18124-D 8C2Z18124D 8C24-18045-DA ASH-1154 AT163G AT-163G	 O	G63622	58622 77614	 O
		8C24-18080-DB 8C2Z18125D ASH-1136 8C2Z-18125-D AT164G 8C2418080DB ASH1136 AT-164G	 O	G63623	58623 77623

MIRADA

08-24	MotorHomes with Ford F53 Chassis with 16,000 lb GVW to 22,000 lb GVW	ASH-1229 ASH-1228 9U94-18045-AA ASH-1205 AT-620 ASH25823 ASH-1022 ASH1022 1C3418045JA ASH-25822 ASH1205 ASH-25823 ASH1228 ASH1229 AT620 1C34-18045-JA AT766 9U9Z18124A ASH294 1C3418045AA 1C34-18045-AA ASH-294 9U9418045AA 9U9Z-18124-A ASH25822 AT-766	 O	83209	 O
		9U9Z18125A ASH-1206 ASH137 AT-621 ASH-25824 ASH-1023 ASH25824 ASH-1230 9U9418080AA ASH1230 ASH1023 9U94-18080-AA 9U9Z-18125-A AT621 ASH1206 ASH-137	 O	83122 89406

APPLICATION GUIDE

Year	Fitment Notes	OEM#								
			 Fleetline\ Gas SLX	Classic\ Ultra\ ProGuard\ Guardian	Max Control\ LTV Severe Duty\ Load Carrier	Steering Dampers\ Steering Stabilizer\ Cab Shock	 Fleetline\ Gas SLX	Classic\ Ultra\ ProGuard\ Guardian	Max Control\ LTV Severe Duty\ Load Carrier\ Hijackers	Steering Dampers\ Steering Stabilizer\ Cab Shock

COACHMEN

COACHMEN





MIRADA (cont)

99-07	MotorHomes with Ford F53 Chassis with 16,000 lb GVW to 22,000 lb GVW	ASH-1229 ASH-1228 9U94-18045-AA ASH-1205 AT-620 ASH25823 ASH-1022 ASH1022 1C3418045JA ASH-25822 ASH1205 ASH-25823 ASH1228 ASH1229 AT620 1C34-18045-JA AT766 9U9Z18124A ASH294 1C3418045AA 1C34-18045-AA ASH-294 9U9418045AA 9U9Z-18124-A ASH25822 AT-766	83209
		9U9Z18125A ASH-1206 ASH137 AT-621 ASH-25824 ASH-1023 ASH25824 ASH-1230 9U9418080AA ASH1230 ASH1023 9U94-18080-AA 9U9Z-18125-A AT621 ASH1206 ASH-137		83122 89406

PATHFINDER

98-03	MotorHomes with Ford E350 or E450 Chassis	ASH1154 8C2418045DA 8C2Z-18124-D 8C2Z18124D 8C24-18045-DA ASH-1154 AT163G AT-163G	G63622	58622 77614
		8C24-18080-DB 8C2Z18125D ASH-1136 8C2Z-18125-D AT164G 8C2418080DB ASH1136 AT-164G		G63623	58623 77623

APPLICATION GUIDE

Year	Fitment Notes	OEM#								
			 Fleetline\ Gas SLX	Classic\ Ultra\ ProGuard\ Guardian	Max Control\ LTV Severe Duty\ Load Carrier	Steering Dampers\ Steering Stabilizer\ Cab Shock	 Fleetline\ Gas SLX	Classic\ Ultra\ ProGuard\ Guardian	Max Control\ LTV Severe Duty\ Load Carrier\ HiJackers	Steering Dampers\ Steering Stabilizer\ Cab Shock



COACHMEN

COACHMEN

PURSUIT

13-24	MotorHomes with Ford F53 Chassis with 16,000 lb GVW to 22,000 lb GVW	ASH-1229 ASH-1228 9U94-18045-AA ASH-1205 AT-620 ASH25823 ASH-1022 ASH1022 1C3418045JA ASH-25822 ASH1205 ASH-25823 ASH1228 ASH1229 AT620 1C34-18045-JA AT766 9U9Z18124A ASH294 1C3418045AA 1C34-18045-AA ASH-294 9U9418045AA 9U9Z-18124-A ASH25822 AT-766	OO	83209
		9U9Z18125A ASH-1206 ASH137 AT-621 ASH-25824 ASH-1023 ASH25824 ASH-1230 9U9418080AA ASH1230 ASH1023 9U94-18080-AA 9U9Z-18125-A AT621 ASH1206 ASH-137	OO	83122 89406
04-12	MotorHomes with Ford F53 Chassis with 16,000 lb GVW to 22,000 lb GVW	ASH-1229 ASH-1228 9U94-18045-AA ASH-1205 AT-620 ASH25823 ASH-1022 ASH1022 1C3418045JA ASH-25822 ASH1205 ASH-25823 ASH1228 ASH1229 AT620 1C34-18045-JA AT766 9U9Z18124A ASH294 1C3418045AA 1C34-18045-AA ASH-294 9U9418045AA 9U9Z-18124-A ASH25822 AT-766	OO	83209
		9U9Z18125A ASH-1206 ASH137 AT-621 ASH-25824 ASH-1023 ASH25824 ASH-1230 9U9418080AA ASH1230 ASH1023 9U94-18080-AA 9U9Z-18125-A AT621 ASH1206 ASH-137	OO	83122 89406

APPLICATION GUIDE

Year	Fitment Notes	OEM#								
			Fleetline\ Gas SLX	Classic\ Ultra\ ProGuard\ Guardian	Max Control\ LTV Severe Duty\ Load Carrier	Steering Dampers\ Steering Stabilizer\ Cab Shock	Fleetline\ Gas SLX	Classic\ Ultra\ ProGuard\ Guardian	Max Control\ LTV Severe Duty\ Load Carrier\ HiJackers	Steering Dampers\ Steering Stabilizer\ Cab Shock

COACHMEN

SANTARA

99-06	MotorHomes with Ford E350 or E450 Chassis	ASH1154 8C2418045DA 8C2Z-18124-D 8C2Z18124D 8C24-18045-DA ASH-1154 AT163G AT-163G	I O	G63622	58622 77614
		8C24-18080-DB 8C2Z18125D ASH-1136 8C2Z-18125-D AT164G 8C2418080DB ASH1136 AT-164G	I O	G63623	58623 77623

COACHMEN

COLLINS BUS CORP.

VARIOUS

Type A School Bus models with Ford E350 & E450 Chassis (Up to 2022)	ASH1154 ASH-1154	I O	G63622	58622 77614
	ASH-1136 ASH1136	I O	G63623	58623 77623

COLLINS BUS CORP.

COUNTRY COACH

AFFINITY

01-10	MotorHomes with Neway IFS	O O	85029
00-10	MotorHomes with Gillig Chassis w/ Neway I-beam front	O I	85723
	MotorHomes with Ridewell Rear Suspension	O O	85734
	MotorHomes with Ridewell Suspension	O O	85712
00	MotorHomes with Neway IFS	O O	85029	83124 89407

COUNTRY COACH

ALLURE

00-04	MotorHomes with Gillig Chassis w/ Neway I-beam front	O I	85723
-------	--	--------	-------	------	------	------	------	------	------	------

CONCEPT

00	MotorHomes with Gillig Chassis w/ Neway I-beam front	O I	85723
	MotorHomes with Neway IFS	O O	85029	83124 89407
	MotorHomes with Ridewell Rear Suspension	O O	85734
	MotorHomes with Ridewell Suspension	O O	85712



INTRIGUE

00-04	MotorHomes with Gillig Chassis w/ Neway I-beam front	O I	85723
-------	--	--------	-------	------	------	------	------	------	------	------

MAGNA

00-04	MotorHomes with Gillig Chassis w/ Neway I-beam front	O I	85723
	MotorHomes with Neway IFS	O O	85029	83124 89407
	MotorHomes with Ridewell Rear Suspension	O O	85734

APPLICATION GUIDE

Year	Fitment Notes	OEM#								
			Fleetline\ Gas SLX	Classic\ Ultra\ ProGuard\ Guardian	Max Control\ LTV Severe Duty\ Load Carrier	Steering Dampers\ Steering Stabilizer\ Cab Shock	Fleetline\ Gas SLX	Classic\ Ultra\ ProGuard\ Guardian	Max Control\ LTV Severe Duty\ Load Carrier\ HiJackers	Steering Dampers\ Steering Stabilizer\ Cab Shock

COUNTRY COACH

COUNTRY COACH

MAGNA (cont)

00-04	MotorHomes with Ridewell Suspension		OO	85712				
-------	-------------------------------------	--	----	-------	------	------	------	--	--	--	--

MAGNA 630

05-10	MotorHomes with Gillig Chassis w/ Newway I-beam front		O	85723					
	MotorHomes with Newway IFS		OO	85029	OO	83124 89407
	MotorHomes with Ridewell Rear Suspension		OO	OO	85734
	MotorHomes with Ridewell Suspension		OO	85712	OO

DAMON

DAMON



CHALLENGER

00-14	MotorHomes with Ford F53 Chassis with 16,000 lb GVW to 22,000 lb GVW	ASH-1229 ASH-1228 9U94-18045-AA ASH-1205 AT-620 ASH25823 ASH-1022 ASH1022 1C3418045JA ASH-25822 ASH1205 ASH-25823 ASH1228 ASH1229 AT620 1C34-18045-JA AT766 9U9Z18124A ASH294 1C3418045AA 1C34-18045-AA ASH-294 9U9418045AA 9U9Z-18124-A ASH25822 AT-766	OO	83209				
		9U9Z18125A ASH-1206 ASH137 AT-621 ASH-25824 ASH-1023 ASH25824 ASH-1230 9U9418080AA ASH1230 ASH1023 9U94-18080-AA 9U9Z-18125-A AT621 ASH1206 ASH-137	OO	OO	83122 89406

CLASS A MOTORHOMES

04-11	Models with Workhorse W20 , W22, & W24 MotorHome Chassis with O.E.M. Number	W0005663 F4BE5F325HO F4-BE5-F325-HO 24153256 24-153256						
98-11	Models with Workhorse W20 , W22, & W24 MotorHome Chassis with O.E.M. Number	24-153249 F4-BE5-B492-HO W0005662 W0006254 24153249 24-186629 F4-BE5-A832-MO F4BE5A832MO F4BE5F324HO F4-BE5-F324-HO 24186629 F4BE5B492HO	OO	85125	OO

APPLICATION GUIDE

Year	Fitment Notes	OEM#								
			Fleetline\ Gas SLX	Classic\ Ultra\ ProGuard\ Guardian	Max Control\ LTV Severe Duty\ Load Carrier	Steering Dampers\ Steering Stabilizer\ Cab Shock	Fleetline\ Gas SLX	Classic\ Ultra\ ProGuard\ Guardian	Max Control\ LTV Severe Duty\ Load Carrier\ HiJackers	Steering Dampers\ Steering Stabilizer\ Cab Shock





DAMON

DAMON

DAYBREAK

12-13	MotorHomes with Ford F53 Chassis with 16,000 lb GVW to 22,000 lb GVW	ASH-1229 ASH-1228 9U94-18045-AA ASH-1205 AT-620 ASH25823 ASH-1022 ASH1022 1C3418045JA ASH-25822 ASH1205 ASH-25823 ASH1228 ASH1229 AT620 1C34-18045-JA AT766 9U9Z18124A ASH294 1C3418045AA 1C34-18045-AA ASH-294 9U9418045AA 9U9Z-18124-A ASH25822 AT-766	83209
		OO	OO	OO	OO	OO	OO	OO	OO	OO
00-11	MotorHomes with Ford F53 Chassis with 16,000 lb GVW to 22,000 lb GVW	ASH-1229 ASH-1228 9U94-18045-AA ASH-1205 AT-620 ASH25823 ASH-1022 ASH1022 1C3418045JA ASH-25822 ASH1205 ASH-25823 ASH1228 ASH1229 AT620 1C34-18045-JA AT766 9U9Z18124A ASH294 1C3418045AA 1C34-18045-AA ASH-294 9U9418045AA 9U9Z-18124-A ASH25822 AT-766	83209
		OO	OO	OO	OO	OO	OO	OO	OO	OO

APPLICATION GUIDE

Year	Fitment Notes	OEM#								
			 Fleetline\ Gas SLX	Classic\ Ultra\ ProGuard\ Guardian	Max Control\ LTV Severe Duty\ Load Carrier	Steering Dampers\ Steering Stabilizer\ Cab Shock	 Fleetline\ Gas SLX	Classic\ Ultra\ ProGuard\ Guardian	Max Control\ LTV Severe Duty\ Load Carrier\ HiJackers	Steering Dampers\ Steering Stabilizer\ Cab Shock

DAMON

DAMON



DAYBREAK (cont)

99	MotorHomes with Ford F53 Chassis with 16,000 lb GVW to 22,000 lb GVW	ASH-1229 ASH-1228 9U94-18045-AA ASH-1205 AT-620 ASH25823 ASH-1022 ASH1022 1C3418045JA ASH-25822 ASH1205 ASH-25823 ASH1228 ASH1229 AT620 1C34-18045-JA AT766 9U9Z18124A ASH294 1C3418045AA 1C34-18045-AA ASH-294 9U9418045AA 9U9Z-18124-A ASH25822 AT-766	83209
		O/O					O/O			
		9U9Z18125A ASH-1206 ASH137 AT-621 ASH-25824 ASH-1023 ASH25824 ASH-1230 9U9418080AA ASH1230 ASH1023 9U94-18080-AA 9U9Z-18125-A AT621 ASH1206 ASH-137	83122 89406
		O/O					O/O			

INTRUDER

00-07	MotorHomes with Ford F53 Chassis with 16,000 lb GVW to 22,000 lb GVW	ASH-1229 ASH-1228 9U94-18045-AA ASH-1205 AT-620 ASH25823 ASH-1022 ASH1022 1C3418045JA ASH-25822 ASH1205 ASH-25823 ASH1228 ASH1229 AT620 1C34-18045-JA AT766 9U9Z18124A ASH294 1C3418045AA 1C34-18045-AA ASH-294 9U9418045AA 9U9Z-18124-A ASH25822 AT-766	83209
		O/O					O/O			
		9U9Z18125A ASH-1206 ASH137 AT-621 ASH-25824 ASH-1023 ASH25824 ASH-1230 9U9418080AA ASH1230 ASH1023 9U94-18080-AA 9U9Z-18125-A AT621 ASH1206 ASH-137	83122 89406
		O/O					O/O			

APPLICATION GUIDE

Year	Fitment Notes	OEM#								
			Fleetline\ Gas SLX	Classic\ Ultra\ ProGuard\ Guardian	Max Control\ LTV Severe Duty\ Load Carrier	Steering Dampers\ Steering Stabilizer\ Cab Shock	Fleetline\ Gas SLX	Classic\ Ultra\ ProGuard\ Guardian	Max Control\ LTV Severe Duty\ Load Carrier\ HiJackers	Steering Dampers\ Steering Stabilizer\ Cab Shock

DAMON

DAMON



INTRUDER (cont)

99	MotorHomes with Ford F53 Chassis with 16,000 lb GVW to 22,000 lb GVW	ASH-1229 ASH-1228 9U94-18045-AA ASH-1205 AT-620 ASH25823 ASH-1022 ASH1022 1C3418045JA ASH-25822 ASH1205 ASH-25823 ASH1228 ASH1229 AT620 1C34-18045-JA AT766 9U9Z18124A ASH294 1C3418045AA 1C34-18045-AA ASH-294 9U9418045AA 9U9Z-18124-A ASH25822 AT-766	83209
		OIO
		9U9Z18125A ASH-1206 ASH137 AT-621 ASH-25824 ASH-1023 ASH25824 ASH-1230 9U9418080AA ASH1230 ASH1023 9U94-18080-AA 9U9Z-18125-A AT621 ASH1206 ASH-137	OIO
			83122 89406

OUTLAW

12-14	MotorHomes with Ford F53 Chassis with 16,000 lb GVW to 22,000 lb GVW	ASH-1229 ASH-1228 9U94-18045-AA ASH-1205 AT-620 ASH25823 ASH-1022 ASH1022 1C3418045JA ASH-25822 ASH1205 ASH-25823 ASH1228 ASH1229 AT620 1C34-18045-JA AT766 9U9Z18124A ASH294 1C3418045AA 1C34-18045-AA ASH-294 9U9418045AA 9U9Z-18124-A ASH25822 AT-766	83209
		OIO
		9U9Z18125A ASH-1206 ASH137 AT-621 ASH-25824 ASH-1023 ASH25824 ASH-1230 9U9418080AA ASH1230 ASH1023 9U94-18080-AA 9U9Z-18125-A AT621 ASH1206 ASH-137	OIO
			83122 89406

APPLICATION GUIDE

Year	Fitment Notes	OEM#								
			Fleetline\ Gas SLX	Classic\ Ultra\ ProGuard\ Guardian	Max Control\ LTV Severe Duty\ Load Carrier	Steering Dampers\ Steering Stabilizer\ Cab Shock	Fleetline\ Gas SLX	Classic\ Ultra\ ProGuard\ Guardian	Max Control\ LTV Severe Duty\ Load Carrier\ HiJackers	Steering Dampers\ Steering Stabilizer\ Cab Shock

DAMON

DAMON

OUTLAW (cont)

07-11	MotorHomes with Ford F53 Chassis with 16,000 lb GVW to 22,000 lb GVW	ASH-1229 ASH-1228 9U94-18045-AA ASH-1205 AT-620 ASH25823 ASH-1022 ASH1022 1C3418045JA ASH-25822 ASH1205 ASH-25823 ASH1228 ASH1229 AT620 1C34-18045-JA AT766 9U9Z18124A ASH294 1C3418045AA 1C34-18045-AA ASH-294 9U9418045AA 9U9Z-18124-A ASH25822 AT-766	83209
		9U9Z18125A ASH-1206 ASH137 AT-621 ASH-25824 ASH-1023 ASH25824 ASH-1230 9U9418080AA ASH1230 ASH1023 9U94-18080-AA 9U9Z-18125-A AT621 ASH1206 ASH-137	83122 89406

DENNIS EAGLE

DENNIS EAGLE

PROVIEW

21-23	Models with Hendrickson HN-460 Rear Suspension	60680003 60680-003L 60680-003 60680003L	O T	83112
17	Models with Hendrickson HN-460 Rear Suspension	60680003 60680-003L 60680-003 60680003L	O T	83112

DIAMOND COACH

DIAMOND COACH

SHUTTLE BUSES

	All Shuttle buses with Ford E350 or E450 Chassis	ASH1154 8C2418045DA 8C2Z-18124-D 8C2Z18124D 8C24-18045-DA ASH-1154 AT163G AT-163G	I O	G63622	58622 77614
		8C24-18080-DB 8C2Z18125D ASH-1136 8C2Z-18125-D AT164G 8C2418080DB ASH1136 AT-164G	I O	G63623	58623 77623



DODGE

DODGE

M300

74	All		O O	G63605	O O	82065 G63183
----	-----	--	--------	------	--------	------	------	--------	------	-----------------	------	------

APPLICATION GUIDE

Year	Fitment Notes	OEM#								
			Fleetline\ Gas SLX	Classic\ Ultra\ ProGuard\ Guardian	Max Control\ LTV Severe Duty\ Load Carrier	Steering Dampers\ Steering Stabilizer\ Cab Shock	Fleetline\ Gas SLX	Classic\ Ultra\ ProGuard\ Guardian	Max Control\ LTV Severe Duty\ Load Carrier\ HiJackers	Steering Dampers\ Steering Stabilizer\ Cab Shock

DODGE

DODGE

M350

74	All		O O		G63605		O O		82065
----	-----	--	--------	--	--------	------	------	--	--------	--	-------	------	------

RD200

78-80	All		O O		81825 G63183		O O		81342
-------	-----	--	--------	--	-----------------	------	------	--	--------	--	-------	------	------

DUTCHMEN RV

DUTCHMEN RV

CLASS C MOTORHOMES

92-09	All Motorhomes with Ford E350 or E450 Chassis	ASH1154 8C2418045DA 8C2Z-18124-D 8C2Z18124D 8C24-18045-DA ASH-1154 AT163G AT-163G	I O		G63622	58622 77614		I O		
		8C24-18080-DB 8C2Z18125D ASH-1136 8C2Z-18125-D AT164G 8C2418080DB ASH1136 AT-164G				G63623	58623 77623		I O		

JAMBOREE

15-20	Motorhomes with Ford E350 or E450 Chassis	ASH1154 8C2418045DA 8C2Z-18124-D 8C2Z18124D 8C24-18045-DA ASH-1154 AT163G AT-163G	I O		G63622	58622 77614		I O		
		8C24-18080-DB 8C2Z18125D ASH-1136 8C2Z-18125-D AT164G 8C2418080DB ASH1136 AT-164G				G63623	58623 77623		I O		

DYNAMAX CORP

DYNAMAX CORP





DX3

13-22	Models with 8000 to 16000 lb Front Axle and Taperleaf Spring	10-13760-000 1013760000 471700002991 SDA471700002991	O O	85959		O O		
	Models with Airliner 21,000 lb Rear Air Suspension	16-15817-000 1618708000 1615817000 16-18708-000 481700006848 680611 471700002809 SDA471700002809				85724 89443		O O		

DYNAQUEST

05-07	Models with 10000 to 12000 lb. Taperleaf Spring Suspension	1012390000 10-12390-000	O O	85920		O O		
	Models with Airliner 18,000 lb Rear Air Suspension	16-15817-000 1618708000 1615817000 16-18708-000 481700006848 680611 471700002809 SDA471700002809				85724 89443		O O		

APPLICATION GUIDE

Year	Fitment Notes	OEM#								
			 Fleetline\ Gas SLX	Classic\ Ultra\ ProGuard\ Guardian	Max Control\ LTV Severe Duty\ Load Carrier	Steering Dampers\ Steering Stabilizer\ Cab Shock	 Fleetline\ Gas SLX	Classic\ Ultra\ ProGuard\ Guardian	Max Control\ LTV Severe Duty\ Load Carrier\ HiJackers	Steering Dampers\ Steering Stabilizer\ Cab Shock

DYNAMAX CORP

DYNAMAX CORP

DYNAQUEST ST

09-14	Models with 8000 to 16000 lb Front Axle and Taperleaf Spring	10-13760-000 1013760000 471700002991 SDA471700002991	OO	85959
	Models with Airliner 18,000 lb Rear Air Suspension	16-15817-000 1618708000 1615817000 16-18708-000 481700006848 680611 471700002809 SDA471700002809	OO	85724 89443

DYNAQUEST XL

09-22	Models with 12000 lb to 20000 Front Axle	1013809000 10-13809-000 471700003920	OO	85958
	Models with FAS II (40,000 lb) Rear Air Suspension	16-15817-000 1618708000 1615817000 16-18708-000 481700006848 680611 471700002809 SDA471700002809	OO	85724 89443

EUROPA

21-22	Models with 8000 to 16000 lb Front Axle and Taperleaf Spring	10-13760-000 1013760000 471700002991 SDA471700002991	OO	85959
	Models with Airliner 21,000 lb Rear Air Suspension	16-15817-000 1618708000 1615817000 16-18708-000 481700006848 680611 471700002809 SDA471700002809	OO	85724 89443



FORCE HD

22	Models with 8000 to 16000 lb Front Axle and Taperleaf Spring	10-13760-000 1013760000 471700002991 SDA471700002991	OO	85959
	Models with Airliner 21,000 lb Rear Air Suspension	16-15817-000 1618708000 1615817000 16-18708-000 481700006848 680611 471700002809 SDA471700002809	OO	85724 89443
19-21	Models with 8000 to 16000 lb Front Axle and Taperleaf Spring	10-13760-000 1013760000 471700002991 SDA471700002991	OO	85959
15-18	Models with 8000 to 16000 lb Front Axle and Taperleaf Spring	10-13760-000 1013760000 471700002991 SDA471700002991	OO	85959
	Models with Airliner 21,000 lb Rear Air Suspension	16-15817-000 1618708000 1615817000 16-18708-000 481700006848 680611 471700002809 SDA471700002809	OO	85724 89443

GRAND SPORT

02-04	Models 23,000 lb Airliner Rear Air Suspension	16-15817-000 1618708000 471700002808 1615817000 16-18708-000 481700006848 680611 471700002809 SDA471700002809	OO	85724 89443
-------	---	---	----	------	------	------	------	------	----------------	------	------	------

APPLICATION GUIDE

Year	Fitment Notes	OEM#								
			Fleetline\ Gas SLX	Classic\ Ultra\ ProGuard\ Guardian	Max Control\ LTV Severe Duty\ Load Carrier	Steering Dampers\ Steering Stabilizer\ Cab Shock	Fleetline\ Gas SLX	Classic\ Ultra\ ProGuard\ Guardian	Max Control\ LTV Severe Duty\ Load Carrier\ HiJackers	Steering Dampers\ Steering Stabilizer\ Cab Shock

DYNAMAX CORP

DYNAMAX CORP

GRAND SPORT (cont)

02-04	Models with 12000 lb Taperleaf Front Suspension	1013063000 1013684000 10-13634-000 47170000449 10-13063-000 10-13021-000 10-13684-000 10-13211-000 1013021000 1013211000 471700131155 1013634000	O O	85918
-------	---	---	--------	-------	------	------	------	------	------	------	------	------

GRAND SPORT GT

09-14	Models with 14,600 lb Taperleaf Front Suspension	1013809000 SDA471700003920 10-13809-000	O O	85958
	Models with Freightliner Airliner Rear Air Suspension	16-15817-000 1618708000 1615817000 16-18708-000 481700006848 680611 471700002809 SDA471700002809	O O	O O	85724 89443

GRAND SPORT GT TOY HAULER

09-13	390TH Models with 12000 lb Taperleaf Front Suspension	10-13760-000 1013760000 471700002991 SDA471700002991	O O	85959
	410TH & 450TH Models with 12000 lb Taperleaf Front Suspension	1013809000 SDA471700003920 10-13809-000	O O	85958
07-13	Models 21K or 23K Airliner Rear Air Suspension	16-15817-000 1618708000 471700002808 1615817000 16-18708-000 481700006848 680611 471700002809 SDA471700002809	O O	O O	85724 89443
07-08	390TH Models with 12000 lb Taperleaf Front Suspension	1012390000 10-12390-000	O O	85920
	410TH & 450TH Models with 12000 lb Taperleaf Front Suspension	1013063000 1013684000 10-13634-000 47170000449 10-13063-000 10-13021-000 10-13684-000 10-13211-000 1013021000 1013211000 471700131155 1013634000	O O	85918



GRAND SPORT M2

03-07	Models with 10000 to 12000 lb. Taperleaf Spring Suspension	1012390000 10-12390-000	O O	85920
	Models with Airliner 21,000 lb Rear Air Suspension	16-15817-000 1618708000 1615817000 16-18708-000 481700006848 680611 471700002809 SDA471700002809	O O	O O	85724 89443

GRAND SPORT ULTRA

09-14	Models with 14,000 lb Taperleaf Front Suspension	1013809000 SDA471700003920 10-13809-000	O O	85958
-------	--	---	--------	-------	------	------	------	------	------	------	------	------

APPLICATION GUIDE

Year	Fitment Notes	OEM#								
			Fleetline\ Gas SLX	Classic\ Ultra\ ProGuard\ Guardian	Max Control\ LTV Severe Duty\ Load Carrier	Steering Dampers\ Steering Stabilizer\ Cab Shock	Fleetline\ Gas SLX	Classic\ Ultra\ ProGuard\ Guardian	Max Control\ LTV Severe Duty\ Load Carrier\ HiJackers	Steering Dampers\ Steering Stabilizer\ Cab Shock

DYNAMAX CORP

DYNAMAX CORP

GRAND SPORT ULTRA (cont)

07-14	Models 23,000 lb Airliner Rear Air Suspension	16-15817-000 1618708000 471700002808 1615817000 16-18708-000 481700006848 680611 471700002809 SDA471700002809	 O	85724 89443
07-08	Models with 14,000 lb Taperleaf Front Suspension	1013063000 1013684000 10-13634-000 471700000449 10-13063-000 10-13021-000 10-13684-000 10-13211-000 1013021000 1013211000 471700131155 1013634000	 O	85918

ISATA 4

18-20	MotorHomes with Ford E350 or E450 Chassis	ASH1154 8C2418045DA 8C2Z-18124-D 8C2Z18124D 8C24-18045-DA ASH-1154 AT163G AT-163G	 O	G63622	58622 77614
		8C24-18080-DB 8C2Z18125D ASH-1136 8C2Z-18125-D AT164G 8C2418080DB ASH1136 AT-164G	 O	G63623	58623 77623
92-17	MotorHomes with Ford E350 or E450 Chassis	ASH1154 8C2418045DA 8C2Z-18124-D 8C2Z18124D 8C24-18045-DA ASH-1154 AT163G AT-163G	 O	G63622	58622 77614
		8C24-18080-DB 8C2Z18125D ASH-1136 8C2Z-18125-D AT164G 8C2418080DB ASH1136 AT-164G	 O	G63623	58623 77623



ELDORADO NATIONAL

ELDORADO NATIONAL

ADVANTAGE

	Shuttle Buses with Ford E350 or E450 Chassis	ASH1154 8C2418045DA 8C2Z-18124-D 8C2Z18124D 8C24-18045-DA ASH-1154 AT163G AT-163G	 O	G63622	58622 77614
		8C24-18080-DB 8C2Z18125D ASH-1136 8C2Z-18125-D AT164G 8C2418080DB ASH1136 AT-164G	 O	G63623	58623 77623

APPLICATION GUIDE

Year	Fitment Notes	OEM#								
			Fleetline\ Gas SLX	Classic\ Ultra\ ProGuard\ Guardian	Max Control\ LTV Severe Duty\ Load Carrier	Steering Dampers\ Steering Stabilizer\ Cab Shock	Fleetline\ Gas SLX	Classic\ Ultra\ ProGuard\ Guardian	Max Control\ LTV Severe Duty\ Load Carrier\ HiJackers	Steering Dampers\ Steering Stabilizer\ Cab Shock

ELDORADO NATIONAL

ELDORADO NATIONAL

AEROLITE

	Shuttle Buses with Ford E350 or E450 Chassis	ASH1154 8C2418045DA 8C2Z-18124-D 8C2Z18124D 8C24-18045-DA ASH-1154 AT163G AT-163G	 O	G63622	58622 77614	 O
		8C24-18080-DB 8C2Z18125D ASH-1136 8C2Z-18125-D AT164G 8C2418080DB ASH1136 AT-164G	 O	 O	G63623	58623 77623

AEROTECH

	Shuttle Buses with Ford E350 or E450 Chassis	ASH1154 8C2418045DA 8C2Z-18124-D 8C2Z18124D 8C24-18045-DA ASH-1154 AT163G AT-163G	 O	G63622	58622 77614	 O
		8C24-18080-DB 8C2Z18125D ASH-1136 8C2Z-18125-D AT164G 8C2418080DB ASH1136 AT-164G	 O	 O	G63623	58623 77623

EMERGENCY ONE

EMERGENCY ONE

VARIOUS

	AERM Models with 10K Front Leaf Spring	90-2572	 O	85329	 O
	AERM Models with 21K Front Taper-Leaf Spring	90-2572	 O	85329	 O
	PAEM Models with 19K Front Taper-Leaf Spring	90-2572	 O	85329	 O
	PMPR Models with 19K Front Taper-Leaf Spring	90-2572	 O	85329	 O





ENTEGR COACH

ENTEGR COACH

EMBLEM

19-24	MotorHomes with Ford F53 Chassis with 16,000 lb GVW to 22,000 lb GVW	ASH25822 ASH-25822 ASH25823 ASH-25823	 O	83209	 O
		9U9Z18125A ASH-1206 ASH1137 AT-621 ASH-25824 ASH-1023 ASH25824 ASH-1230 9U9418080AA ASH1230 ASH1023 9U94-18080-AA 9U9Z-18125-A AT621 ASH1206 ASH-137	 O	 O	83122 89406
	MotorHomes with Ford F53 Chassis with 24,000 lb GVW to 26,000 lb GVW	ASH1161 ASH25821 ASH-25821 ASH-1161	 O	85006	 O

APPLICATION GUIDE

Year	Fitment Notes	OEM#								
			 Fleetline\ Gas SLX	Classic\ Ultra\ ProGuard\ Guardian	Max Control\ LTV Severe Duty\ Load Carrier	Steering Dampers\ Steering Stabilizer\ Cab Shock	 Fleetline\ Gas SLX	Classic\ Ultra\ ProGuard\ Guardian	Max Control\ LTV Severe Duty\ Load Carrier\ HiJackers	Steering Dampers\ Steering Stabilizer\ Cab Shock

ENTEGRA COACH

ENTEGRA COACH

EMBLEM (cont)

19-23	MotorHomes with Ford F53 Chassis with 24,000 lb GVW to 26,000 lb GVW	ASH25820 ASH1162 ASH-25820 ASH-1162	85005 89430
-------	--	--	-------	-------	-------	-------	-------	----------------	-------	-------	-------

ESTEEM

18-24	MotorHomes with Ford E350 or E450 Chassis	ASH1154 8C2418045DA 8C2Z-18124-D 8C2Z18124D 8C24-18045-DA ASH-1154 AT163G AT-163G	G63622	58622 77614
		8C24-18080-DB 8C2Z18125D ASH-1136 8C2Z-18125-D AT164G 8C2418080DB ASH1136 AT-164G	G63623	58623 77623
17	MotorHomes with Ford E350 or E450 Chassis	ASH1154 8C2418045DA 8C2Z-18124-D 8C2Z18124D 8C24-18045-DA ASH-1154 AT163G AT-163G	G63622	58622 77614
		8C24-18080-DB 8C2Z18125D ASH-1136 8C2Z-18125-D AT164G 8C2418080DB ASH1136 AT-164G	G63623	58623 77623



ODYSSEY

18-24	MotorHomes with Ford E350 or E450 Chassis	ASH1154 8C2418045DA 8C2Z-18124-D 8C2Z18124D 8C24-18045-DA ASH-1154 AT163G AT-163G	G63622	58622 77614
		8C24-18080-DB 8C2Z18125D ASH-1136 8C2Z-18125-D AT164G 8C2418080DB ASH1136 AT-164G	G63623	58623 77623
17	MotorHomes with Ford E350 or E450 Chassis	ASH1154 8C2418045DA 8C2Z-18124-D 8C2Z18124D 8C24-18045-DA ASH-1154 AT163G AT-163G	G63622	58622 77614
		8C24-18080-DB 8C2Z18125D ASH-1136 8C2Z-18125-D AT164G 8C2418080DB ASH1136 AT-164G	G63623	58623 77623

VISION

19-24	MotorHomes with Ford F53 Chassis with 16,000 lb GVW to 22,000 lb GVW	ASH25822 ASH-25822 ASH25823 ASH-25823	83209
-------	--	--	-------	-------	-------	-------	-------	-------	-------	-------	-------

APPLICATION GUIDE

Year	Fitment Notes	OEM#								
			Fleetline\ Gas SLX	Classic\ Ultra\ ProGuard\ Guardian	Max Control\ LTV Severe Duty\ Load Carrier	Steering Dampers\ Steering Stabilizer\ Cab Shock	Fleetline\ Gas SLX	Classic\ Ultra\ ProGuard\ Guardian	Max Control\ LTV Severe Duty\ Load Carrier\ HiJackers	Steering Dampers\ Steering Stabilizer\ Cab Shock

ENTEGRA COACH

ENTEGRA COACH

VISION (cont)

19-24	MotorHomes with Ford F53 Chassis with 16,000 lb GVW to 22,000 lb GVW	9U9Z18125A ASH-1206 ASH137 AT-621 ASH-25824 ASH-1023 ASH25824 ASH-1230 9U9418080AA ASH1230 ASH1023 9U94-18080-AA 9U9Z-18125-A AT621 ASH1206 ASH-137	I O	83122 89406
-------	--	--	--------	----------------	------	------	------	------	------	------	------	------

VISION XL

20-24	MotorHomes with Ford F53 Chassis with 24,000 lb GVW to 26,000 lb GVW	ASH1161 ASH25821 ASH-25821 ASH-1161	I O	85006
20-23	MotorHomes with Ford F53 Chassis with 24,000 lb GVW to 26,000 lb GVW	ASH25820 ASH1162 ASH-25820 ASH-1162	I O	85005 89430

FEDERAL COACH

FEDERAL COACH

VARIOUS

	Spirit Series Shuttle buses with Ford E450 Chassis	ASH1154 ASH-1154	I O	G63622	58622 77614
		ASH-1136 ASH1136	I O	G63623	58623 77623
09-19	Shuttle buses with Freightliner M2-106 Chassis	10-13760-000 1013760000 471700002991 SDA471700002991	I O	85959
02-19	Shuttle buses with Freightliner M2-106 Chassis	1618708000 16-18708-000 471700002809	I O	85724 89443
02-08	Shuttle buses with Freightliner M2-106 Chassis	10-12388-000 1012390000 10-12390-000 1012388000	I O	85920





FLEETWOOD

FLEETWOOD

AXON

19-20	MotorHomes with Ford F53 Chassis with 16,000 lb GVW to 22,000 lb GVW	ASH-1229 ASH-1228 9U94-18045-AA ASH-1205 AT-620 ASH25823 ASH-1022 ASH1022 1C3418045JA ASH-25822 ASH1205 ASH-25823 ASH1228 ASH1229 AT620 1C34-18045-JA AT766 9U9Z18124A ASH294 1C3418045AA 1C34-18045-AA ASH-294 9U9418045AA 9U9Z-18124-A ASH25822 AT-766	I O	83209
-------	--	---	--------	-------	------	------	------	------	------	------	------	------

APPLICATION GUIDE

Year	Fitment Notes	OEM#								
			 Fleetline\ Gas SLX	Classic\ Ultra\ ProGuard\ Guardian	Max Control\ LTV Severe Duty\ Load Carrier	Steering Dampers\ Steering Stabilizer\ Cab Shock	 Fleetline\ Gas SLX	Classic\ Ultra\ ProGuard\ Guardian	Max Control\ LTV Severe Duty\ Load Carrier\ HiJackers	Steering Dampers\ Steering Stabilizer\ Cab Shock

FLEETWOOD

FLEETWOOD



AXON (cont)

19-20	MotorHomes with Ford F53 Chassis with 16,000 lb GVW to 22,000 lb GVW	9U9Z18125A ASH-1206 ASH137 AT-621 ASH-25824 ASH-1023 ASH25824 ASH-1230 9U9418080AA ASH1230 ASH1023 9U94-18080-AA 9U9Z-18125-A AT621 ASH1206 ASH-137	83122 89406
18	MotorHomes with Ford F53 Chassis with 16,000 lb GVW to 22,000 lb GVW	ASH-1229 ASH-1228 9U94-18045-AA ASH-1205 AT-620 ASH25823 ASH-1022 ASH1022 1C3418045JA ASH-25822 ASH1205 ASH-25823 ASH1228 ASH1229 AT620 1C34-18045-JA AT766 9U9Z18124A ASH294 1C3418045AA 1C34-18045-AA ASH-294 9U9418045AA 9U9Z-18124-A ASH25822 AT-766	83209
		9U9Z18125A ASH-1206 ASH137 AT-621 ASH-25824 ASH-1023 ASH25824 ASH-1230 9U9418080AA ASH1230 ASH1023 9U94-18080-AA 9U9Z-18125-A AT621 ASH1206 ASH-137	83122 89406

BOUNDER

08-24	MotorHomes with Ford F53 Chassis with 24,000 lb GVW to 26,000 lb GVW	ASH1161 ASH25821 ASH-25821 ASH-1161	85006
-------	--	--	-------	-------	-------	-------	-------	-------	-------	-------

APPLICATION GUIDE

Year	Fitment Notes	OEM#								
			Fleetline\ Gas SLX	Classic\ Ultra\ ProGuard\ Guardian	Max Control\ LTV Severe Duty\ Load Carrier	Steering Dampers\ Steering Stabilizer\ Cab Shock	Fleetline\ Gas SLX	Classic\ Ultra\ ProGuard\ Guardian	Max Control\ LTV Severe Duty\ Load Carrier\ HiJackers	Steering Dampers\ Steering Stabilizer\ Cab Shock

FLEETWOOD

FLEETWOOD

BOUNDER (cont)

00-24	MotorHomes with Ford F53 Chassis with 16,000 lb GVW to 22,000 lb GVW	ASH-1229 ASH-1228 9U94-18045-AA ASH-1205 AT-620 ASH25823 ASH-1022 ASH1022 1C3418045JA ASH-25822 ASH1205 ASH-25823 ASH1228 ASH1229 AT620 1C34-18045-JA AT766 9U9Z18124A ASH294 1C3418045AA 1C34-18045-AA ASH-294 9U9418045AA 9U9Z-18124-A ASH25822 AT-766	83209
		OO									
		9U9Z18125A ASH-1206 ASH137 AT-621 ASH-25824 ASH-1023 ASH25824 ASH-1230 9U9418080AA ASH1230 ASH1023 9U94-18080-AA 9U9Z-18125-A AT621 ASH1206 ASH-137	83122 89406
		OO									
08-23	MotorHomes with Ford F53 Chassis with 24,000 lb GVW to 26,000 lb GVW	ASH25820 ASH1162 ASH-25820 ASH-1162	85005 89430
			OO								
02-06	Models with Freightliner XC Chassis with ZF - IFS Front Suspension and 23,000 lb GVW or Greater	1618103000 16-18103-000 481700000493	85900
			I								
	MotorHomes with Freightliner XC Chassis and ADL200 Suspension w/ 20K Rear	1616873000 16-16873-000 141700131809 1616736000 16-16736-000	85029
			OO								
	MotorHomes with Freightliner XC Chassis and AS120 Front Suspension	16-16874-000 1616874000 1616737000 16-16737-000 141700131810	83160
			OO								



CLASS A MOTORHOMES

04-11	Models with Workhorse W20 , W22, & W24 MotorHome Chassis with O.E.M. Number	W0005663 F4BE5F325HO F4-BE5-F325-HO 24153256 24-153256	85124
			I								

DISCOVERY

02-06	Models with Freightliner XC Chassis with ZF - IFS Front Suspension and 23,000 lb GVW or Greater	1618103000 16-18103-000 481700000493	85900
			I								

APPLICATION GUIDE

Year	Fitment Notes	OEM#								
			Fleetline/ Gas SLX	Classic/ Ultra/ ProGuard/ Guardian	Max Control/ LTV Severe Duty/ Load Carrier	Steering Dampers/ Steering Stabilizer/ Cab Shock	Fleetline/ Gas SLX	Classic/ Ultra/ ProGuard/ Guardian	Max Control/ LTV Severe Duty/ Load Carrier/ HiJackers	Steering Dampers/ Steering Stabilizer/ Cab Shock

FLEETWOOD

FLEETWOOD

DISCOVERY (cont)

02-06	MotorHomes with Freightliner XC Chassis and ADL200 Suspension w/ 20K Rear	1616873000 16-16873-000 141700131809 1616736000 16-16736-000	85029
	MotorHomes with Freightliner XC Chassis and AS120 Front Suspension	16-16874-000 1616874000 1616737000 16-16737-000 141700131810	83160

EXCURSION

03-06	Models with Freightliner XC Chassis with ZF - IFS Front Suspension and 23,000 lb GVW or Greater	1618103000 16-18103-000 481700000493	85900
02-06	MotorHomes with Freightliner XC Chassis and ADL200 Suspension w/ 20K Rear	1616873000 16-16873-000 141700131809 1616736000 16-16736-000	85029
	MotorHomes with Freightliner XC Chassis and AS120 Front Suspension	16-16874-000 1616874000 1616737000 16-16737-000 141700131810	83160



EXPEDITION

02-06	Models with Freightliner XC Chassis with ZF - IFS Front Suspension and 23,000 lb GVW or Greater	1618103000 16-18103-000 481700000493	85900
	MotorHomes with Freightliner XC Chassis and AS120 Front Suspension	16-16874-000 1616874000 1616737000 16-16737-000 141700131810	83160

FLAIR

15-24	MotorHomes with Ford F53 Chassis with 16,000 lb GVW to 22,000 lb GVW	ASH-1229 ASH-1228 9U94-18045-AA ASH-1205 AT-620 ASH25823 ASH-1022 ASH1022 1C3418045JA ASH-25822 ASH1205 ASH-25823 ASH1228 ASH1229 AT620 1C34-18045-JA AT766 9U9Z18124A ASH294 1C3418045AA 1C34-18045-AA ASH-294 9U9418045AA 9U9Z-18124-A ASH25822 AT-766	83209
-------	--	---	-------	------	------	------	------	------	------	------

APPLICATION GUIDE

Year	Fitment Notes	OEM#								
			Fleetline\ Gas SLX	Classic\ Ultra\ ProGuard\ Guardian	Max Control\ LTV Severe Duty\ Load Carrier	Steering Dampers\ Steering Stabilizer\ Cab Shock	Fleetline\ Gas SLX	Classic\ Ultra\ ProGuard\ Guardian	Max Control\ LTV Severe Duty\ Load Carrier\ HiJackers	Steering Dampers\ Steering Stabilizer\ Cab Shock

FLEETWOOD

FLEETWOOD





FLAIR (cont)

15-24	MotorHomes with Ford F53 Chassis with 16,000 lb GVW to 22,000 lb GVW	9U9Z18125A ASH-1206 ASH137 AT-621 ASH-25824 ASH-1023 ASH25824 ASH-1230 9U9418080AA ASH1230 ASH1023 9U94-18080-AA 9U9Z-18125-A AT621 ASH1206 ASH-137	83122 89406
			O/O							
00-07	MotorHomes with Ford F53 Chassis with 16,000 lb GVW to 22,000 lb GVW	ASH-1229 ASH-1228 9U94-18045-AA ASH-1205 AT-620 ASH25823 ASH-1022 ASH1022 1C3418045JA ASH-25822 ASH1205 ASH-25823 ASH1228 ASH1229 AT620 1C34-18045-JA AT766 9U9Z18124A ASH294 1C3418045AA 1C34-18045-AA ASH-294 9U9418045AA 9U9Z-18124-A ASH25822 AT-766	83209
			O/O							
		9U9Z18125A ASH-1206 ASH137 AT-621 ASH-25824 ASH-1023 ASH25824 ASH-1230 9U9418080AA ASH1230 ASH1023 9U94-18080-AA 9U9Z-18125-A AT621 ASH1206 ASH-137	83122 89406
			O/O							

FLEX

23-24	MotorHomes with Ford F53 Chassis with 16,000 lb GVW to 22,000 lb GVW	ASH-1229 ASH-1228 9U94-18045-AA ASH-1205 AT-620 ASH25823 ASH-1022 ASH1022 1C3418045JA ASH-25822 ASH1205 ASH-25823 ASH1228 ASH1229 AT620 1C34-18045-JA AT766 9U9Z18124A ASH294 1C3418045AA 1C34-18045-AA ASH-294 9U9418045AA 9U9Z-18124-A ASH25822 AT-766	83209
			O/O							

APPLICATION GUIDE

Year	Fitment Notes	OEM#								
			 Fleetline\ Gas SLX	Classic\ Ultra\ ProGuard\ Guardian	Max Control\ LTV Severe Duty\ Load Carrier	Steering Dampers\ Steering Stabilizer\ Cab Shock	 Fleetline\ Gas SLX	Classic\ Ultra\ ProGuard\ Guardian	Max Control\ LTV Severe Duty\ Load Carrier\ HiJackers	Steering Dampers\ Steering Stabilizer\ Cab Shock

FLEETWOOD

FLEETWOOD

FLEX (cont)

23-24	MotorHomes with Ford F53 Chassis with 16,000 lb GVW to 22,000 lb GVW	9U9Z18125A ASH-1206 ASH137 AT-621 ASH-25824 ASH-1023 ASH25824 ASH-1230 9U9418080AA ASH1230 ASH1023 9U94-18080-AA 9U9Z-18125-A AT621 ASH1206 ASH-137	83122 89406
-------	--	--	------	------	------	------	----------------	------	------	------



FORTIS

20-24	MotorHomes with Ford F53 Chassis with 16,000 lb GVW to 22,000 lb GVW	ASH-1229 ASH-1228 9U94-18045-AA ASH-1205 AT-620 ASH25823 ASH-1022 ASH1022 1C3418045JA ASH-25822 ASH1205 ASH-25823 ASH1228 ASH1229 AT620 1C34-18045-JA AT766 9U9Z18124A ASH294 1C3418045AA 1C34-18045-AA ASH-294 9U9418045AA 9U9Z-18124-A ASH25822 AT-766	83209
		9U9Z18125A ASH-1206 ASH137 AT-621 ASH-25824 ASH-1023 ASH25824 ASH-1230 9U9418080AA ASH1230 ASH1023 9U94-18080-AA 9U9Z-18125-A AT621 ASH1206 ASH-137	83122 89406
	MotorHomes with Ford F53 Chassis with 24,000 lb GVW to 26,000 lb GVW	ASH1161 ASH25821 ASH-25821 ASH-1161	85006
20-23	MotorHomes with Ford F53 Chassis with 24,000 lb GVW to 26,000 lb GVW	ASH25820 ASH1162 ASH-25820 ASH-1162	85005 89430

JAMBOREE

20	MotorHomes with Ford E350 or E450 Chassis	ASH1154 8C2418045DA 8C2Z-18124-D 8C2Z18124D 8C24-18045-DA ASH-1154 AT163G AT-163G	G63622	58622 77614
----	---	--	------	--------	----------------	------	------	------	------	------

APPLICATION GUIDE

Year	Fitment Notes	OEM#								
			Fleetline\ Gas SLX	Classic\ Ultra\ ProGuard\ Guardian	Max Control\ LTV Severe Duty\ Load Carrier	Steering Dampers\ Steering Stabilizer\ Cab Shock	Fleetline\ Gas SLX	Classic\ Ultra\ ProGuard\ Guardian	Max Control\ LTV Severe Duty\ Load Carrier\ HiJackers	Steering Dampers\ Steering Stabilizer\ Cab Shock

FLEETWOOD

FLEETWOOD





JAMBOREE (cont)

20	MotorHomes with Ford E350 or E450 Chassis	8C24-18080-DB 8C2Z18125D ASH-1136 8C2Z-18125-D AT164G 8C2418080DB ASH1136 AT-164G	 O					 O		G63623	58623 77623	
17-19	MotorHomes with Ford E350 or E450 Chassis	ASH1154 8C2418045DA 8C2Z-18124-D 8C2Z18124D 8C24-18045-DA ASH-1154 AT163G AT-163G	 O		G63622	58622 77614		 O				
		8C24-18080-DB 8C2Z18125D ASH-1136 8C2Z-18125-D AT164G 8C2418080DB ASH1136 AT-164G	 O					 O		G63623	58623 77623	
14-16	MotorHomes with Ford E350 or E450 Chassis	ASH1154 8C2418045DA 8C2Z-18124-D 8C2Z18124D 8C24-18045-DA ASH-1154 AT163G AT-163G	 O		G63622	58622 77614		 O				
		8C24-18080-DB 8C2Z18125D ASH-1136 8C2Z-18125-D AT164G 8C2418080DB ASH1136 AT-164G	 O					 O		G63623	58623 77623	
08-13	MotorHomes with Ford E350 or E450 Chassis	ASH1154 8C2418045DA 8C2Z-18124-D 8C2Z18124D 8C24-18045-DA ASH-1154 AT163G AT-163G	 O		G63622	58622 77614		 O				
		8C24-18080-DB 8C2Z18125D ASH-1136 8C2Z-18125-D AT164G 8C2418080DB ASH1136 AT-164G	 O					 O		G63623	58623 77623	
99-07	MotorHomes with Ford E350 or E450 Chassis	ASH1154 8C2418045DA 8C2Z-18124-D 8C2Z18124D 8C24-18045-DA ASH-1154 AT163G AT-163G	 O		G63622	58622 77614		 O				
		8C24-18080-DB 8C2Z18125D ASH-1136 8C2Z-18125-D AT164G 8C2418080DB ASH1136 AT-164G	 O					 O		G63623	58623 77623	

PROVIDENCE

04-06	Models with Freightliner XC Chassis with ZF - IFS Front Suspension and 23,000 lb GVW or Greater	1618103000 16-18103-000 481700000493	 I		85900				 I			
-------	---	--	-------	--	-------	--	--	--	-------	--	--	--

APPLICATION GUIDE

Year	Fitment Notes	OEM#								
			 Fleetline\ Gas SLX	Classic\ Ultra\ ProGuard\ Guardian	Max Control\ LTV Severe Duty\ Load Carrier	Steering Dampers\ Steering Stabilizer\ Cab Shock	 Fleetline\ Gas SLX	Classic\ Ultra\ ProGuard\ Guardian	Max Control\ LTV Severe Duty\ Load Carrier\ HiJackers	Steering Dampers\ Steering Stabilizer\ Cab Shock

FLEETWOOD

FLEETWOOD



PROVIDENCE (cont)

04-06	MotorHomes with Freightliner XC Chassis and ADL200 Suspension w/ 20K Rear	1616873000 16-16873-000 141700131809 1616736000 16-16736-000	85029
	MotorHomes with Freightliner XC Chassis and AS120 Front Suspension	16-16874-000 1616874000 1616737000 16-16737-000 141700131810	83160

SOUTHWIND

08-23	MotorHomes with Ford F53 Chassis with 24,000 lb GVW to 26,000 lb GVW	ASH1161 ASH25821 ASH-25821 ASH-1161	85006
		ASH25820 ASH1162 ASH-25820 ASH-1162	85005 89430
00-23	MotorHomes with Ford F53 Chassis with 16,000 lb GVW to 22,000 lb GVW	ASH-1229 ASH-1228 9U94-18045-AA ASH-1205 AT-620 ASH25823 ASH-1022 ASH1022 1C3418045JA ASH-25822 ASH1205 ASH-25823 ASH1228 ASH1229 AT620 1C34-18045-JA AT766 9U9Z18124A ASH294 1C3418045AA 1C34-18045-AA ASH-294 9U9418045AA 9U9Z-18124-A ASH25822 AT-766	83209
		9U9Z18125A ASH-1206 ASH137 AT-621 ASH-25824 ASH-1023 ASH25824 ASH-1230 9U9418080AA ASH1230 ASH1023 9U94-18080-AA 9U9Z-18125-A AT621 ASH1206 ASH-137	83122 89406

APPLICATION GUIDE



Year	Fitment Notes	OEM#								
			Fleetline\ Gas SLX	Classic\ Ultra\ ProGuard\ Guardian	Max Control\ LTV Severe Duty\ Load Carrier	Steering Dampers\ Steering Stabilizer\ Cab Shock	Fleetline\ Gas SLX	Classic\ Ultra\ ProGuard\ Guardian	Max Control\ LTV Severe Duty\ Load Carrier\ HiJackers	Steering Dampers\ Steering Stabilizer\ Cab Shock

FLEETWOOD STORM

FLEETWOOD

11-18	MotorHomes with Ford F53 Chassis with 16,000 lb GVW to 22,000 lb GVW	ASH-1229 ASH-1228 9U94-18045-AA ASH-1205 AT-620 ASH25823 ASH-1022 ASH1022 1C3418045JA ASH-25822 ASH1205 ASH-25823 ASH1228 ASH1229 AT620 1C34-18045-JA AT766 9U9Z18124A ASH294 1C3418045AA 1C34-18045-AA ASH-294 9U9418045AA 9U9Z-18124-A ASH25822 AT-766	83209
		OO
01-07	MotorHomes with Ford F53 Chassis with 16,000 lb GVW to 22,000 lb GVW	ASH-1229 ASH-1228 9U94-18045-AA ASH-1205 AT-620 ASH25823 ASH-1022 ASH1022 1C3418045JA ASH-25822 ASH1205 ASH-25823 ASH1228 ASH1229 AT620 1C34-18045-JA AT766 9U9Z18124A ASH294 1C3418045AA 1C34-18045-AA ASH-294 9U9418045AA 9U9Z-18124-A ASH25822 AT-766	83209
		OO

APPLICATION GUIDE

Year	Fitment Notes	OEM#								
			Fleetline/ Gas SLX	Classic/ Ultra/ ProGuard/ Guardian	Max Control/ LTV Severe Duty/ Load Carrier	Steering Dampers/ Steering Stabilizer/ Cab Shock	Fleetline/ Gas SLX	Classic/ Ultra/ ProGuard/ Guardian	Max Control/ LTV Severe Duty/ Load Carrier/ HiJackers	Steering Dampers/ Steering Stabilizer/ Cab Shock

FLEETWOOD SURGE



FLEETWOOD

19-20	MotorHomes with Ford E350 or E450 Chassis	ASH1154 8C2418045DA 8C2Z-18124-D 8C2Z18124D 8C24-18045-DA ASH-1154 AT163G AT-163G	 O	G63622	58622 77614	 O
		8C24-18080-DB 8C2Z18125D ASH-1136 8C2Z-18125-D AT164G 8C2418080DB ASH1136 AT-164G	 O	 O	G63623	58623 77623
18	MotorHomes with Ford E350 or E450 Chassis	ASH1154 8C2418045DA 8C2Z-18124-D 8C2Z18124D 8C24-18045-DA ASH-1154 AT163G AT-163G	 O	G63622	58622 77614	 O
		8C24-18080-DB 8C2Z18125D ASH-1136 8C2Z-18125-D AT164G 8C2418080DB ASH1136 AT-164G	 O	 O	G63623	58623 77623

TIOGA

14-16	MotorHomes with Ford E350 or E450 Chassis	ASH1154 8C2418045DA 8C2Z-18124-D 8C2Z18124D 8C24-18045-DA ASH-1154 AT163G AT-163G	 O	G63622	58622 77614	 O
		8C24-18080-DB 8C2Z18125D ASH-1136 8C2Z-18125-D AT164G 8C2418080DB ASH1136 AT-164G	 O	 O	G63623	58623 77623
08-13	MotorHomes with Ford E350 or E450 Chassis	ASH1154 8C2418045DA 8C2Z-18124-D 8C2Z18124D 8C24-18045-DA ASH-1154 AT163G AT-163G	 O	G63622	58622 77614	 O
		8C24-18080-DB 8C2Z18125D ASH-1136 8C2Z-18125-D AT164G 8C2418080DB ASH1136 AT-164G	 O	 O	G63623	58623 77623
99-07	MotorHomes with Ford E350 or E450 Chassis	ASH1154 8C2418045DA 8C2Z-18124-D 8C2Z18124D 8C24-18045-DA ASH-1154 AT163G AT-163G	 O	G63622	58622 77614	 O
		8C24-18080-DB 8C2Z18125D ASH-1136 8C2Z-18125-D AT164G 8C2418080DB ASH1136 AT-164G	 O	 O	G63623	58623 77623

APPLICATION GUIDE

Year	Fitment Notes	OEM#								
			Fleetline\ Gas SLX	Classic\ Ultra\ ProGuard\ Guardian	Max Control\ LTV Severe Duty\ Load Carrier	Steering Dampers\ Steering Stabilizer\ Cab Shock	Fleetline\ Gas SLX	Classic\ Ultra\ ProGuard\ Guardian	Max Control\ LTV Severe Duty\ Load Carrier\ HiJackers	Steering Dampers\ Steering Stabilizer\ Cab Shock

FORD

FORD

B-600

80-94	B - Series - Bus Cowl Chassis	F1HT18045AA F1HT-18045-AA E0HT18045AA E0HT18045AB E0HT-18045-AB E0HT-18045-AA	83309										
-------	-------------------------------	--	-------	--	--	--	--	--	--	--	--	--	--

B-700

80-94	B - Series - Bus Cowl Chassis	F1HT18045AA F1HT-18045-AA E0HT18045AA E0HT18045AB E0HT-18045-AB E0HT-18045-AA	83309										
94	Models with with 14600 lb Multileaf Spring	F4HT-18045-EA F4HT18045EA	83125										
	Models with with 15000, 17500, 19000 lb Taperleaf Springs	F4HT18080AA F4HT-18080-AB F4HT-18080-AA F4HT18080AB	85314 89425										

B-7000

83-87	B - Series - Bus Cowl Chassis	F1HT18045AA F1HT-18045-AA E0HT18045AA E0HT18045AB E0HT-18045-AB E0HT-18045-AA	83309										
-------	-------------------------------	--	-------	--	--	--	--	--	--	--	--	--	--

C600

80-86	Models with 3100 lb Spring and 7000 lb Axle	D7HT18045JA D7HT-18045-JA	83308										
	Models with 4040, 5040 lb Springs and 7000, 9000, 12000 lb Axles	D2EF18045AA D2EF-18045-AA	83312										

C700

80-86	Models with 3100 lb Spring and 7000 lb Axle	D7HT18045JA D7HT-18045-JA	83308										
	Models with 4040, 5040 lb Springs and 7000, 9000, 12000 lb Axles	D2EF18045AA D2EF-18045-AA	83312										





C7000

80-86	Models with 3100 lb Spring and 7000 lb Axle	D7HT18045JA D7HT-18045-JA	83308										
	Models with 4040, 5040 lb Springs and 7000, 9000, 12000 lb Axles	D2EF18045AA D2EF-18045-AA	83312										

CF7000

96-97	Models with 16000 lb. Multileaf Spring	F6HT-18045-AA F6HT18045AA	85054										
92-97	Models with 9000 lb Axle	F2HT18045CA F2HT18045BA F2HZ18124A F2HZ-18124-A F6HT18045LA F2HT-18045-BA F2HT-18045-CA F6HT-18045-LA	85376										
86-97	Models with 12000 lb or 13000 lb Axle	87HU-18045-AA 87HU18045AA E6HZ18124A E6HZ-18124-A E5HT18045AA E7HZ18124A E5HT-18045-AA E7HZ-18124-A	85301										
		85302 89420										







APPLICATION GUIDE

Year	Fitment Notes	OEM#								
			 Fleetline\ Gas SLX	Classic\ Ultra\ ProGuard\ Guardian	Max Control\ LTV Severe Duty\ Load Carrier	Steering Dampers\ Steering Stabilizer\ Cab Shock	 Fleetline\ Gas SLX	Classic\ Ultra\ ProGuard\ Guardian	Max Control\ LTV Severe Duty\ Load Carrier\ HiJackers	Steering Dampers\ Steering Stabilizer\ Cab Shock





FORD

FORD





E-450 ECONOLINE SUPER DUTY

00-02	All			G63622	58622 77614		61646 G63623	58623 77623
	Exc. Cutaway Chassis				77623
	Steering Stabilizer		 	6828SE ⁸⁰								











E-550 ECONOLINE SUPER DUTY

02	All				61655
	Steering Stabilizer		 	6828SE ⁸⁰								

E-550 SUPER DUTY



03	All				61655
	Steering Stabilizer		 	6828SE ⁸⁰								

F-53

08-23	F-53 Chassis with 16,000 lb GVW to 18,000 lb GVW	9U9Z18125A ASH-1206 ASH137 9U9Z18125B AT-621 ASH-25825 ASH-25824 ASH25825 ASH-1023 ASH25824 ASH-1230 9U9418080AA HU9Z-18125-B ASH1230 ASH1023 9U94-18080-AA 9U9Z-18125-B 9U9Z-18125-A AT621 ASH1206 ASH-137 HU9Z18125B		  	83122 89406	
	F53 Chassis with 24,000 lb GVW to 26,000 lb GVW	ASH1161 ASH25821 ASH-25821 ASH-1161 HU9Z18124A HU9Z-18124-A	 	85006	
		ASH25820 ASH1162 ASH-25820 ASH-1162	 	 	85005 89430

80 Mounting bracket not required, install on O.E. Shock Mounts. See Ref. C for optional Steering Stabilizer Boots;

APPLICATION GUIDE

Year	Fitment Notes	OEM#								
			Fleetline\ Gas SLX	Classic\ Ultra\ ProGuard\ Guardian	Max Control\ LTV Severe Duty\ Load Carrier	Steering Dampers\ Steering Stabilizer\ Cab Shock	Fleetline\ Gas SLX	Classic\ Ultra\ ProGuard\ Guardian	Max Control\ LTV Severe Duty\ Load Carrier\ HiJackers	Steering Dampers\ Steering Stabilizer\ Cab Shock





FORD

FORD

F-53 (cont)

06-23	F53 Chassis with 16,000 lb GVW to 22,000 lb GVW	ASH-1229 ASH-1228 9U94-18045-AA ASH-1205 AT-620 ASH25823 ASH-1022 HU9418045BA ASH1022 1C3418045JA ASH-25822 ASH1205 ASH-25823 ASH1228 ASH1229 HU9Z18124B AT620 HU9Z18124C 1C34-18045-JA AT766 9U9Z18124A 9U9Z18124B ASH294 1C3418045AA HU9418045AA ASH-294 9U9418045AA 9U9Z-18124-A ASH25822 AT-766	83209
11-20	F53 Stripped Chassis Commercial Stripped Chassis, 19,500 lb to 22,000 lb GVW	47 1700 007 203 ASH24634 DU94-18045-CB	85013
	F53 Stripped Chassis With BT Delivery Van Pack, 16,000 LB. GVW	471700009775 DU9418080CA DU94-18080-CA 471700007117 DU94-18080-CB DU9418080CB	85010
06-07	F-53 Chassis with 16,000 lb GVW to 18,000 lb GVW	9U9Z18125A ASH-1206 ASH137 AT-621 ASH-25824 ASH-1023 ASH25824 ASH-1230 9U9418080AA HU9Z-18125-B ASH1230 ASH1023 9U94-18080-AA 9U9Z-18125-A AT621 ASH1206 ASH-137 HU9Z18125B	83122 89406
99-04	F-53 Chassis with 16,000 lb GVW to 18,000 lb GVW	9U9Z18125A ASH-1206 ASH137 AT-621 ASH-25824 ASH-1023 ASH25824 ASH-1230 9U9418080AA HU9Z-18125-B ASH1230 ASH1023 9U94-18080-AA 9U9Z-18125-A AT621 ASH1206 ASH-137 HU9Z18125B	83122 89406

APPLICATION GUIDE

Year	Fitment Notes	OEM#								
			 Fleetline\ Gas SLX	Classic\ Ultra\ ProGuard\ Guardian	Max Control\ LTV Severe Duty\ Load Carrier	Steering Dampers\ Steering Stabilizer\ Cab Shock	 Fleetline\ Gas SLX	Classic\ Ultra\ ProGuard\ Guardian	Max Control\ LTV Severe Duty\ Load Carrier\ HiJackers	Steering Dampers\ Steering Stabilizer\ Cab Shock

FORD

FORD



F-53 (cont)

99-04	F53 Chassis with 16,000 lb GVW to 22,000 lb GVW	ASH-1229 ASH-1228 9U94-18045-AA ASH-1205 AT-620 ASH25823 ASH-1022 HU9418045BA ASH1022 1C3418045JA ASH-25822 ASH1205 ASH-25823 ASH1228 ASH1229 HU9Z18124B AT620 HU9Z18124C 1C34-18045-JA AT766 9U9Z18124A 9U9Z18124B ASH294 1C3418045AA HU9418045AA ASH-294 9U9418045AA 9U9Z-18124-A ASH25822 AT-766	83209
88-97	F53 Chassis with 16,000 lb GVW to 22,000 lb GVW	ASH-1229 ASH-1228 9U94-18045-AA ASH-1205 AT-620 ASH25823 ASH-1022 HU9418045BA ASH1022 1C3418045JA ASH-25822 ASH1205 ASH-25823 ASH1228 ASH1229 HU9Z18124B AT620 HU9Z18124C 1C34-18045-JA AT766 9U9Z18124A 9U9Z18124B ASH294 1C3418045AA HU9418045AA ASH-294 9U9418045AA 9U9Z-18124-A ASH25822 AT-766	83209

F-53 MOTORHOME CHASSIS

24	MotorHomes with Ford F53 Chassis with 24,000 lb GVW to 26,000 lb GVW	ASH1161 ASH25821 ASH-25821 ASH-1161 HU9Z18124A HU9Z-18124-A	85006
08-23	Motorhome Chassis with 16,000 lb GVW to 18,000 lb GVW	9U9Z18125B 9U9Z-18125-B ASH-25825 ASH25825	83122 89406
	MotorHomes with Ford F53 Chassis with 24,000 lb GVW to 26,000 lb GVW	ASH1161 ASH25821 ASH-25821 ASH-1161 HU9Z18124A HU9Z-18124-A	85006
		ASH25820 ASH1162 ASH-25820 ASH-1162	85005 89430

APPLICATION GUIDE

Year	Fitment Notes	OEM#								
			Fleetline\ Gas SLX	Classic\ Ultra\ ProGuard\ Guardian	Max Control\ LTV Severe Duty\ Load Carrier	Steering Dampers\ Steering Stabilizer\ Cab Shock	Fleetline\ Gas SLX	Classic\ Ultra\ ProGuard\ Guardian	Max Control\ LTV Severe Duty\ Load Carrier\ HiJackers	Steering Dampers\ Steering Stabilizer\ Cab Shock



FORD

FORD

F-53 MOTORHOME CHASSIS (cont)

06-23	F53 Chassis with 16,000 lb GVW to 22,000 lb GVW	ASH-1229 ASH-1228 9U94-18045-AA ASH-1205 AT-620 ASH25823 ASH-1022 HU9418045BA ASH1022 1C3418045JA ASH-25822 ASH1205 ASH-25823 ASH1228 ASH1229 HU9Z18124B AT620 HU9Z18124C 1C34-18045-JA AT766 9U9Z18124A 9U9Z18124B ASH294 1C3418045AA HU9418045AA ASH-294 9U9418045AA 9U9Z-18124-A ASH25822 AT-766	83209
	OO	Motorhome Chassis with 20,500 lb GVW to 22,000 lb GVW	9U9Z18125A ASH-1206 ASH137 AT-621 ASH-25824 ASH-1023 ASH25824 ASH-1230 9U9418080AA HU9Z-18125-B ASH1230 ASH1023 9U94-18080-AA 9U9Z-18125-A AT621 ASH1206 ASH-137 HU9Z18125B	83122 89406
OO	F53 Stripped Chassis Commercial Stripped Chassis, 19,500 lb to 22,000 lb GVW	47 1700 007 203 ASH24634 DU94-18045-CB	85013
OO	F53 Stripped Chassis With BT Delivery Van Pack, 16,000 LB. GVW	471700009775 DU9418080CA DU94-18080-CA 471700007117 DU94-18080-CB DU9418080CB	85010
OO	MotorHomes with Ford F53 Chassis with 16,000 lb GVW to 22,000 lb GVW	ASH-1229 ASH-1228 9U94-18045-AA ASH-1205 AT-620 ASH25823 ASH-1022 ASH1022 1C3418045JA ASH-25822 ASH1205 ASH-25823 ASH1228 ASH1229 AT620 1C34-18045-JA AT766 9U9Z18124A ASH294 1C3418045AA 1C34-18045-AA ASH-294 9U9418045AA 9U9Z-18124-A ASH25822 AT-766	83209

APPLICATION GUIDE

Year	Fitment Notes	OEM#								
			Fleetline\ Gas SLX	Classic\ Ultra\ ProGuard\ Guardian	Max Control\ LTV Severe Duty\ Load Carrier	Steering Dampers\ Steering Stabilizer\ Cab Shock	Fleetline\ Gas SLX	Classic\ Ultra\ ProGuard\ Guardian	Max Control\ LTV Severe Duty\ Load Carrier\ HiJackers	Steering Dampers\ Steering Stabilizer\ Cab Shock



FORD

FORD

F-53 MOTORHOME CHASSIS (cont)

99-04	F53 Chassis with 16,000 lb GVW to 22,000 lb GVW	ASH-1229 ASH-1228 9U94-18045-AA ASH-1205 AT-620 ASH25823 ASH-1022 HU9418045BA ASH1022 1C3418045JA ASH-25822 ASH1205 ASH-25823 ASH1228 ASH1229 HU9Z18124B AT620 HU9Z18124C 1C34-18045-JA AT766 9U9Z18124A 9U9Z18124B ASH294 1C3418045AA HU9418045AA ASH-294 9U9418045AA 9U9Z-18124-A ASH25822 AT-766	OO	83209
	Motorhome Chassis with 20,500 lb GVW to 22,000 lb GVW	9U9Z18125A ASH-1206 ASH137 AT-621 ASH-25824 ASH-1023 ASH25824 ASH-1230 9U9418080AA HU9Z-18125-B ASH1230 ASH1023 9U94-18080-AA 9U9Z-18125-A AT621 ASH1206 ASH-137 HU9Z18125B	OO	83122 89406
98	MotorHomes with Ford F53 Chassis with 16,000 lb GVW to 22,000 lb GVW	ASH-1229 ASH-1228 9U94-18045-AA ASH-1205 AT-620 ASH25823 ASH-1022 ASH1022 1C3418045JA ASH-25822 ASH1205 ASH-25823 ASH1228 ASH1229 AT620 1C34-18045-JA AT766 9U9Z18124A ASH294 1C3418045AA 1C34-18045-AA ASH-294 9U9418045AA 9U9Z-18124-A ASH25822 AT-766	OO	83209

APPLICATION GUIDE

Year	Fitment Notes	OEM#								
			Fleetline\ Gas SLX	Classic\ Ultra\ ProGuard\ Guardian	Max Control\ LTV Severe Duty\ Load Carrier	Steering Dampers\ Steering Stabilizer\ Cab Shock	Fleetline\ Gas SLX	Classic\ Ultra\ ProGuard\ Guardian	Max Control\ LTV Severe Duty\ Load Carrier\ HiJackers	Steering Dampers\ Steering Stabilizer\ Cab Shock

FORD

FORD





F-53 MOTORHOME CHASSIS (cont)

88-97	F53 Chassis with 16,000 lb GVW to 22,000 lb GVW	ASH-1229 ASH-1228 9U94-18045-AA ASH-1205 AT-620 ASH25823 ASH-1022 HU9418045BA ASH1022 1C3418045JA ASH-25822 ASH1205 ASH-25823 ASH1228 ASH1229 HU9Z18124B AT620 HU9Z18124C 1C34-18045-JA AT766 9U9Z18124A 9U9Z18124B ASH294 1C3418045AA HU9418045AA ASH-294 9U9418045AA 9U9Z-18124-A ASH25822 AT-766	83209
	F53 Motorhome Chassis (Over 30 feet)		83125

F-59 COMMERCIAL STRIPPED CHASSIS

11-24	MotorHomes with Ford F59 Commercial Chassis with 24,000 lb GVW to 26,000 lb GVW	ASH1161 ASH25821 ASH-25821 ASH-1161 HU9Z18124A HU9Z-18124-A	85006
11-21	F59 Commercial Chassis with 16,000 lb or 19,500 GVW	471700009775 ASH-12261 DU9418080CA CU9Z18125A BU9Z-18125-A 471700007117 BU9Z18125A ASH12261 DU9Z-18125-A DU9418080CB DU9Z-18125-B CU9Z-18125-A ASH-24523 ASH-24589 ASH24589 DU94-18080-CA ASH-24474 ASH24474 DU94-18080-CB DU9Z18125A DU9Z18125B	85010	
	F59 Commercial Chassis with 16,000 lb to 22,000 GVW	ASH-12251 BU9Z-18124-A CU9Z18124A BU9Z18124A DU9Z-18124-A DU9Z-18124-B ASH12251 CU9Z-18124-A DU9Z18124B ASH-24473 ASH24634 ASH-24522 ASH24522 ASH-24634 ASH24473 DU9Z18124A	85013	

APPLICATION GUIDE

Year	Fitment Notes	OEM#								
			 Fleetline\ Gas SLX	Classic\ Ultra\ ProGuard\ Guardian	Max Control\ LTV Severe Duty\ Load Carrier	Steering Dampers\ Steering Stabilizer\ Cab Shock	 Fleetline\ Gas SLX	Classic\ Ultra\ ProGuard\ Guardian	Max Control\ LTV Severe Duty\ Load Carrier\ HiJackers	Steering Dampers\ Steering Stabilizer\ Cab Shock

FORD

FORD

F-59 COMMERCIAL STRIPPED CHASSIS (cont)

89-97	F59 Commercial Chassis with 16,000 lb or 19,500 GVW	471700009775 ASH-12261 DU9418080CA CU9Z18125A BU9Z-18125-A 471700007117 BU9Z18125A ASH12261 DU9Z-18125-A DU9418080CB DU9Z-18125-B CU9Z-18125-A ASH-24523 ASH-24589 ASH24589 DU94-18080-CA ASH-24474 ASH24474 DU94-18080-CB DU9Z18125A DU9Z18125B	85010
88-97	F59 Commercial Chassis with 16,000 lb to 22,000 GVW	ASH-12251 BU9Z-18124-A CU9Z18124A BU9Z18124A DU9Z-18124-A DU9Z-18124-B ASH12251 CU9Z-18124-A DU9Z18124B ASH-24473 ASH24634 ASH-24522 ASH24522 ASH-24634 ASH24473 DU9Z18124A	85013
88	F59 Commercial Chassis with 16,000 lb or 19,500 GVW	ASH-12261 CU9Z18125A BU9Z-18125-A BU9Z18125A ASH12261 DU9Z-18125-A DU9Z-18125-B CU9Z-18125-A ASH-24523 ASH-24589 ASH24589 ASH-24474 ASH24474 DU9Z18125A DU9Z18125B	85010



F-600

86-94	Models with O.E.M. Number	E6HZ18125D AX-310 AX310 E6HT18080AA ASH-24446 ASH24446 E6HT-18080-AA E6HZ-18125-D	83215
80-94	Exc. 9000 lb Axle with H.D. Suspension & 12000 lb Axle	E0HT18045AA E0HT18045AB E0HT-18045-AB E0HT-18045-AA	83309
80-90	Models with 17000 & 18000 lb Rear Axle	D7HT-18080-DA D7HF18080AA D7HT18080DA D7HF-18080-AA	83215
70-90	Models with 13000 & 15000 lb Rear Axle	D7HT18080BA D7HT-18080-BA	83225
90	Models with Multileaf Spring	F1HT18045AA F1HT-18045-AA	83309
83-89	Models with 9000 lb Axle with H.D. Suspension & 12000 lb Axle	D7HT-18045-CA D2HF-18045-AA D2HF18045AA D7HT18045CA	83314

F-600 LPO

90-94	Models with O.E.M. Number	E9HS-18080-AA E9HS18080AA	85716
-------	---------------------------	------------------------------	-------	-------	-------	-------	-------	-------	-------	-------

APPLICATION GUIDE

Year	Fitment Notes	OEM#								
			Fleetline\ Gas SLX	Classic\ Ultra\ ProGuard\ Guardian	Max Control\ LTV Severe Duty\ Load Carrier	Steering Dampers\ Steering Stabilizer\ Cab Shock	Fleetline\ Gas SLX	Classic\ Ultra\ ProGuard\ Guardian	Max Control\ LTV Severe Duty\ Load Carrier\ HiJackers	Steering Dampers\ Steering Stabilizer\ Cab Shock





FORD

FORD

F-650

21-24	Models with 19.5" or 22.5" Wheels (22,000 lb GVW)	FC4Z-18124-B FC4Z-18124-A ASH-24659 ASH-24658 ASH24659 ASH24658 471700011530 FC4Z18124B FC4Z18124A FC44-18045-BB FC4418045BB	OO	85181
	Models with 13,500, 15,500 & 19,000 lb Multi-leaf Rear Springs	FC4Z-18125-A FC4418080AB ASH-24660 FC4Z18125A 471700011531 FC44-18080-AB ASH24660	OO	85180
	Models with Hendrickson HAS - 400/460 Rear Air Suspension	60675-014 ASH-25838 60675014 ASH25838 FC4Z-18125-E FC4Z18125E	OO	85978
	Models with Hendrickson Rear Air Suspension	60670-011 60670011 ASH24663 FC4Z-18125-D ASH-24663 FC4Z18125D	OO	83148
		60670012 60670-012 ASH-24662 FC4Z18125C ASH24662 FC4Z-18125-C	OO	83168
20	Models with Hendrickson Rear Air Suspension	60670-011 60670011 ASH24663 FC4Z-18125-D ASH-24663 FC4Z18125D	OO	83148
15-19	Models with 19.5" or 22.5" Wheels (22,000 lb GVW)	FC4Z-18124-B FC4Z-18124-A ASH-24659 ASH-24658 ASH24659 ASH24658 471700011530 FC4Z18124B FC4Z18124A FC44-18045-BB FC4418045BB	OO	85181
	Models with 13,500, 15,500 & 19,000 lb Multi-leaf Rear Springs	FC4Z-18125-A FC4418080AB ASH-24660 FC4Z18125A 471700011531 FC44-18080-AB ASH24660	OO	85180
	Models with Hendrickson HAS - 400/460 Rear Air Suspension	60675-014 ASH-25838 60675014 ASH25838 FC4Z-18125-E FC4Z18125E	OO	85978
	Models with Hendrickson Rear Air Suspension	60670-011 60670011 ASH24663 FC4Z-18125-D ASH-24663 FC4Z18125D	OO	83148
		60670012 60670-012 ASH-24662 FC4Z18125C ASH24662 FC4Z-18125-C	OO	83168

APPLICATION GUIDE

Year	Fitment Notes	OEM#								
			 Fleetline/ Gas SLX	Classic/ Ultra/ ProGuard/ Guardian	Max Control/ LTV Severe Duty/ Load Carrier	Steering Dampers/ Steering Stabilizer/ Cab Shock	 Fleetline/ Gas SLX	Classic/ Ultra/ ProGuard/ Guardian	Max Control/ LTV Severe Duty/ Load Carrier/ HiJackers	Steering Dampers/ Steering Stabilizer/ Cab Shock

FORD

FORD

F-650 (cont)

15	Models with 10,000 lb Front Suspension	4C4Z18124QA ASH24492 3584116C1 3584116C2 ASH-24492 AA616 AA-616 2C4418045BA 2C44-18045-BA 4C4Z-18124-QA	OO	83175
	Models with 12,000 & 13,200 lb Front Springs	4C4Z18124RA 4C4Z-18124-JB 4C4Z18124JB 3584118C2 AA-617 AT812 4C4Z-18124-RA AA617 AT-812	OO	85928
	Models with 21,000 lb Rear Air Suspension	3578858C1 3578858C2 4C4Z-18125-DA 4C4Z18125DA	OO	85656
	Models with 22,000 lb Multi-leaf Rear Springs	4C4Z-18125-B 4C4Z18125B 501906C91 501906C92 ASH-24661 ASH24661	OO	83317
	Models with 8,500 lb Front Suspension	4C4Z18124P 4C4Z-18124-HB 4C4Z18124HB AA615 AA-615 FC4Z-18124-HB 3584117C2 4C4Z-18124-P AT-811 AT811 FC4Z18124HB	OO	83135
	Models with Hendrickson HAS - 230 Rear Air Suspension	4C4Z-18125-CA 60675-003 ASH-1105 ASH-722 60675-003L 60675003L 60675003 4C4Z18125CA ASH1105 ASH722	OO	85976
	Models with International Air Suspension (4x2)	AA-619 3553628C1 3553628C2 AA619	OO	85927
14	Models with 10,000 lb Front Suspension	4C4Z18124QA ASH24492 3584116C1 3584116C2 ASH-24492 AA616 AA-616 2C4418045BA 2C44-18045-BA 4C4Z-18124-QA	OO	83175
	Models with 12,000 & 13,200 lb Front Springs	4C4Z18124RA 4C4Z-18124-JB 4C4Z18124JB 3584118C2 AA-617 AT812 4C4Z-18124-RA AA617 AT-812	OO	85928
	Models with 21,000 lb Rear Air Suspension	3578858C1 3578858C2 4C4Z-18125-DA 4C4Z18125DA	OO	85656
	Models with 22,000 lb Multi-leaf Rear Springs	4C4Z-18125-B 4C4Z18125B 501906C91 501906C92 ASH-24661 ASH24661	OO	83317

APPLICATION GUIDE

Year	Fitment Notes	OEM#								
			Fleetline\ Gas SLX	Classic\ Ultra\ ProGuard\ Guardian	Max Control\ LTV Severe Duty\ Load Carrier	Steering Dampers\ Steering Stabilizer\ Cab Shock	Fleetline\ Gas SLX	Classic\ Ultra\ ProGuard\ Guardian	Max Control\ LTV Severe Duty\ Load Carrier\ HiJackers	Steering Dampers\ Steering Stabilizer\ Cab Shock





FORD

FORD

F-650 (cont)

14	Models with 8,500 lb Front Suspension	4C4Z18124P 4C4Z-18124-HB 4C4Z18124HB AA615 AA-615 FC4Z-18124-HB 3584117C2 4C4Z-18124-P AT-811 AT811 FC4Z18124HB	83135
	Models with Hendrickson HAS - 230 Rear Air Suspension	4C4Z-18125-CA 60675-003 ASH-1105 ASH-722 60675-003L 60675003L 60675003 4C4Z18125CA ASH1105 ASH722	85976
	Models with International Air Suspension (4x2)	AA-619 3553628C1 3553628C2 AA619	85927
04-13	Models with 21,000 lb Rear Air Suspension	3578858C1 3578858C2 4C4Z-18125-DA 4C4Z18125DA	85656
	Models with 22,000 lb Multi-leaf Rear Springs	4C4Z-18125-B 4C4Z18125B 501906C91 501906C92 ASH-24661 ASH24661	83317
	Models with Hendrickson HAS - 230 Rear Air Suspension	4C4Z-18125-CA 60675-003 ASH-1105 ASH-722 60675-003L 60675003L 60675003 4C4Z18125CA ASH1105 ASH722	85976
	Models with International Air Suspension (4x2)	AA-619 3553628C1 3553628C2 AA619	85927
02-13	Models with Vari-Rate Rear Suspension	4C4Z18125CC AA-620 AA620 4C4Z-18125-CC	83101
00-13	Models with 10,000 lb Front Suspension	4C4Z18124QA ASH24492 3584116C1 3584116C2 ASH-24492 AA616 AA-616 2C4418045BA 2C44-18045-BA 4C4Z-18124-QA	83175
	Models with 12,000 & 13,200 lb Front Springs	4C4Z18124RA 4C4Z-18124-JB 4C4Z18124JB 3584118C2 AA-617 AT812 4C4Z-18124-RA AA617 AT-812	85928
	Models with 8,500 lb Front Suspension	4C4Z18124P 4C4Z-18124-HB 4C4Z18124HB AA615 AA-615 FC4Z-18124-HB 3584117C2 4C4Z-18124-P AT-811 AT811 FC4Z18124HB	83135

APPLICATION GUIDE

Year	Fitment Notes	OEM#								
			 Fleetline/ Gas SLX	Classic/ Ultra/ ProGuard/ Guardian	Max Control/ LTV Severe Duty/ Load Carrier	Steering Dampers/ Steering Stabilizer/ Cab Shock	 Fleetline/ Gas SLX	Classic/ Ultra/ ProGuard/ Guardian	Max Control/ LTV Severe Duty/ Load Carrier/ HiJackers	Steering Dampers/ Steering Stabilizer/ Cab Shock

FORD

FORD

F-650 (cont)

00-03	Models with 23,000 lb Multi-leaf Rear Springs	F81Z-18125-ZA AT-696 F81A18080ZC AT696 ASH-2447 ASH2447 F81A-18080-ZC F81Z18125ZA	83140
	Models with Hendrickson HAS - 190 Rear Air Suspension	1C44-18080-AA 60670008L 60670-008 1C4418080AA 60670-008L 60670008	83123 89405
00-02	Models with 8500 or 9000 lb Front Axle	XC3518045JA ASH397 3U2Z-18124-MAA XC3518045AB 3U2Z18124MAA XC35-18045-AB XC3Z-18124-JA XC35-18045-AD XC35-18045-JA XC3518045AD AA-494 ASH-397 AA494 XC3Z18124JA	83131

F-700

94-98	Models with Taperleaf Springs and with 6000, 7000, 8500, 9000 lb Axle	F4HT18045AC F4HT18045AB F5HZ-18124-A F4HT-18045-AB F4HT-18045-AC F5HZ18124A	83314
	Models with with 15000, 17500, 19000 lb Taperleaf Springs	F4HT18080AA F4HT-18080-AB F5HZ-18125-A F4HT-18080-AA F5HZ18125A F4HT18080AB	85314 89425
86-98	Models with O.E.M. Number	E6HZ18125D AX-310 AX310 E6HT18080AA ASH-24446 ASH24446 E6HT-18080-AA E6HZ-18125-D	83215
94-97	Models with 52" or 54" Taperleaf Springs and with 10000 or 12000 lb Axle	F4HT-18045-DA F5HZ-18124-C F5HZ18124C F4HT18045DA	85063
	w/ Multileaf Spring and w/ 10000, 12000 or 13200 lb Axle	F4HT-18045-CB F5HZ-18124-B F5HZ18124B F4HT18045CB	83107
80-94	Exc. 9000 lb Axle with H.D. Suspension & 12000 lb Axle	E0HT18045AA E0HT18045AB E0HT-18045-AB E0HT-18045-AA	83309
94	Models with with 14600 lb Multileaf Spring	F4HT-18045-EA F5HZ-18124-D F5HZ18124D F4HT18045EA	83125
80-90	Models with 17000 & 18000 lb Rear Axle	D7HT-18080-DA D7HF18080AA D7HT18080DA D7HF-18080-AA	83215
70-90	Models with 13000 & 15000 lb Rear Axle	D7HT18080BA D7HT-18080-BA	83225
90	Models with Multileaf Spring	F1HT18045AA F1HT-18045-AA	83309
83-89	Models with 9000 lb Axle with H.D. Suspension & 12000 lb Axle	D7HT-18045-CA D2HF-18045-AA D2HF18045AA D7HT18045CA	83314

APPLICATION GUIDE

Year	Fitment Notes	OEM#								
			Fleetline\ Gas SLX	Classic\ Ultra\ ProGuard\ Guardian	Max Control\ LTV Severe Duty\ Load Carrier	Steering Dampers\ Steering Stabilizer\ Cab Shock	Fleetline\ Gas SLX	Classic\ Ultra\ ProGuard\ Guardian	Max Control\ LTV Severe Duty\ Load Carrier\ HiJackers	Steering Dampers\ Steering Stabilizer\ Cab Shock

FORD

FORD





F-700 LPO

90-94	Models with O.E.M. Number	E9HS-18080-AA E9HS18080AA	O	85716
-------	---------------------------	------------------------------	------	------	------	------	---	-------	------	------	------

F-750

21-24	Models with 19.5" or 22.5" Wheels (22,000 lb GVW)	FC4Z-18124-B FC4Z-18124-A ASH-24659 ASH-24658 ASH24659 ASH24658 471700011530 FC4Z18124B FC4Z18124A FC44-18045-BB FC4418045BB	O	85181	O	
		FC4Z-18125-A FC4418080AB ASH-24660 FC4Z18125A 471700011531 FC44-18080-AB ASH24660	O	O	85180
		60675-014 ASH-25838 60675014 ASH25838 FC4Z-18125-E FC4Z18125E	O	O	85978
		60670-011 60670011 ASH24663 FC4Z-18125-D ASH-24663 FC4Z18125D	O	O	83148
15-19	Models with 19.5" or 22.5" Wheels (22,000 lb GVW)	FC4Z-18124-B FC4Z-18124-A ASH-24659 ASH-24658 ASH24659 ASH24658 471700011530 FC4Z18124B FC4Z18124A FC44-18045-BB FC4418045BB	O	85181	O	
		FC4Z-18125-A FC4418080AB ASH-24660 FC4Z18125A 471700011531 FC44-18080-AB ASH24660	O	O	85180
		60675-014 ASH-25838 60675014 ASH25838 FC4Z-18125-E FC4Z18125E	O	O	85978
		60670-011 60670011 ASH24663 FC4Z-18125-D ASH-24663 FC4Z18125D	O	O	83148
15-19	Models with 19.5" or 22.5" Wheels (22,000 lb GVW)	60670012 60670-012 ASH-24662 FC4Z18125C ASH24662 FC4Z-18125-C	O	O	83168	
		FC4Z-18125-A FC4418080AB ASH-24660 FC4Z18125A 471700011531 FC44-18080-AB ASH24660	O	O	85180
		60675-014 ASH-25838 60675014 ASH25838 FC4Z-18125-E FC4Z18125E	O	O	85978
		60670-011 60670011 ASH24663 FC4Z-18125-D ASH-24663 FC4Z18125D	O	O	83148
15-19	Models with 19.5" or 22.5" Wheels (22,000 lb GVW)	60670012 60670-012 ASH-24662 FC4Z18125C ASH24662 FC4Z-18125-C	O	O	83168	

APPLICATION GUIDE

Year	Fitment Notes	OEM#								
			 Fleetline/ Gas SLX	Classic/ Ultra/ ProGuard/ Guardian	Max Control/ LTV Severe Duty/ Load Carrier	Steering Dampers/ Steering Stabilizer/ Cab Shock	 Fleetline/ Gas SLX	Classic/ Ultra/ ProGuard/ Guardian	Max Control/ LTV Severe Duty/ Load Carrier/ HiJackers	Steering Dampers/ Steering Stabilizer/ Cab Shock



FORD

FORD

F-750 (cont)

15	Models with 10,000 lb Front Suspension	4C4Z18124QA ASH24492 3584116C1 3584116C2 ASH-24492 AA616 AA-616 2C44-18045BA 2C44-18045-BA 4C4Z-18124-QA	OO	83175	
	Models with 12,000 & 13,200 lb Front Springs	4C4Z18124RA 4C4Z-18124-JB 4C4Z18124JB 3584118C2 AA-617 AT812 4C4Z-18124-RA AA617 AT-812	OO	85928	
	Models with 21,000 lb Rear Air Suspension	3578858C1 3578858C2 4C4Z-18125-DA 4C4Z18125DA	OO		85656	
	Models with 22,000 lb Multi-leaf Rear Springs	4C4Z-18125-B 4C4Z18125B 501906C91 501906C92 ASH-24661 ASH24661	OO		83317	
	Models with 8,500 lb Front Suspension	4C4Z18124P 4C4Z-18124-HB 4C4Z18124HB AA615 AA-615 FC4Z-18124-HB 3584117C2 4C4Z-18124-P AT-811 AT811 FC4Z18124HB	OO	83135
	Models with Hendrickson HAS - 230 Rear Air Suspension	4C4Z-18125-CA 60675-003 ASH-1105 ASH-722 60675-003L 60675003L 60675003 4C4Z18125CA ASH1105 ASH722	OO		85976	
	Models with International Air Suspension (4x2)	AA-619 3553628C1 3553628C2 AA619	OO		85927	
04-13	Models with 21,000 lb Rear Air Suspension	3578858C1 3578858C2 4C4Z-18125-DA 4C4Z18125DA	OO		85656	
	Models with 22,000 lb Multi-leaf Rear Springs	4C4Z-18125-B 4C4Z18125B 501906C91 501906C92 ASH-24661 ASH24661	OO		83317	
	Models with Hendrickson HAS - 230 Rear Air Suspension	4C4Z-18125-CA 60675-003 ASH-1105 ASH-722 60675-003L 60675003L 60675003 4C4Z18125CA ASH1105 ASH722	OO		85976	
	Models with International Air Suspension (4x2)	AA-619 3553628C1 3553628C2 AA619	OO		85927	
02-13	Models with Vari-Rate Rear Suspension	4C4Z18125CC AA-620 AA620 4C4Z-18125-CC	OO		83101	

APPLICATION GUIDE

Year	Fitment Notes	OEM#								
			Fleetline\ Gas SLX	Classic\ Ultra\ ProGuard\ Guardian	Max Control\ LTV Severe Duty\ Load Carrier	Steering Dampers\ Steering Stabilizer\ Cab Shock	Fleetline\ Gas SLX	Classic\ Ultra\ ProGuard\ Guardian	Max Control\ LTV Severe Duty\ Load Carrier\ HiJackers	Steering Dampers\ Steering Stabilizer\ Cab Shock

FORD

FORD





F-750 (cont)

00-13	Models with 10,000 lb Front Suspension	4C4Z18124QA ASH24492 3584116C1 3584116C2 ASH-24492 AA616 AA-616 2C44-18045BA 2C44-18045-BA 4C4Z-18124-QA	83175
	Models with 12,000 & 13,200 lb Front Springs	4C4Z18124RA 4C4Z-18124-JB 4C4Z18124JB 3584118C2 AA-617 AT812 4C4Z-18124-RA AA617 AT-812	85928
	Models with 8,500 lb Front Suspension	4C4Z18124P 4C4Z-18124-HB 4C4Z18124HB AA615 AA-615 FC4Z-18124-HB 3584117C2 4C4Z-18124-P AT-811 AT811 FC4Z18124HB	83135
00-03	Models with 23,000 lb Multi-leaf Rear Springs	F81Z-18125-ZA AT-696 F81A18080ZC AT696 ASH-2447 ASH2447 F81A-18080-ZC F81Z18125ZA	83140
	Models with Hendrickson HAS - 190 Rear Air Suspension	1C44-18080-AA 60670008L 60670-008 1C4418080AA 60670-008L 60670008	83123 89405
00-02	Models with 8500 or 9000 lb Front Axle	XC3518045JA ASH397 3U2Z-18124-MAA XC3518045AB 3U2Z18124MAA XC35-18045-AB XC3Z-18124-JA XC35-18045-AD XC35-18045-JA XC3518045AD AA-494 ASH-397 AA494 XC3Z18124JA	83131

F-800

94-98	Models with Taperleaf Springs and with 6000, 7000, 8500, 9000 lb Axle	F4HT18045AC F4HT18045AB F5HZ-18124-A F4HT-18045-AB F4HT-18045-AC F5HZ18124A	83314
	Models with 15000, 17500, 19000 lb Taperleaf Springs	F4HT18080AA F4HT-18080-AB F5HZ-18125-A F4HT-18080-AA F5HZ18125A F4HT18080AB	85314 89425
94-97	Models with 21000 Taperleaf Springs	F4HT18080BA F4HT-18080-BA	85001 89410
	Models with 52" or 54" Taperleaf Springs and with 10000 or 12000 lb Axle	F4HT-18045-DA F5HZ-18124-C F5HZ18124C F4HT18045DA	85063

APPLICATION GUIDE

Year	Fitment Notes	OEM#								
			 Fleetline/ Gas SLX	Classic/ Ultra/ ProGuard/ Guardian	Max Control/ LTV Severe Duty/ Load Carrier	Steering Dampers/ Steering Stabilizer/ Cab Shock	 Fleetline/ Gas SLX	Classic/ Ultra/ ProGuard/ Guardian	Max Control/ LTV Severe Duty/ Load Carrier/ HiJackers	Steering Dampers/ Steering Stabilizer/ Cab Shock

FORD

FORD

F-800 (cont)

86-97	Models with O.E.M. Number	E6HZ18125D AX-310 AX310 E6HT18080AA ASH-24446 ASH24446 E6HT-18080-AA E6HZ-18125-D	O O	83215
80-94	Exc. 9000 lb Axle with H.D. Suspension & 12000 lb Axle	E0HT18045AA E0HT18045AB E0HT-18045-AB E0HT-18045-AA	O O	83309
94	Models with with 14600 lb Multileaf Spring	F4HT-18045-EA F5HZ-18124-D F5HZ18124D F4HT18045EA	O O	83125
	w/ Multileaf Spring and w/ 10000, 12000 or 13200 lb Axle	F4HT-18045-CB F5HZ-18124-B F5HZ18124B F4HT18045CB	O O	83107
80-90	Models with 17000 & 18000 lb Rear Axle	D7HT-18080-DA D7HF18080AA D7HT18080DA D7HF-18080-AA	O O	83215
90	Models with 13000 & 15000 lb Rear Axle	D7HT18080BA	O O	83225
	Models with Multileaf Spring	F1HT18045AA F1HT-18045-AA	O O	83309
83-89	Models with 9000 lb Axle with H.D. Suspension & 12000 lb Axle	D7HT-18045-CA D2HF-18045-AA D2HF18045AA D7HT18045CA	O O	83314
80-89	Models with 13000 & 15000 lb Rear Axle	D7HT18080BA D7HT-18080-BA	O O	83225

F-7000

83-87	Models with 9000 lb Axle with H.D. Suspension & 12000 lb Axle	D7HT-18045-CA D2HF-18045-AA D2HF18045AA D7HT18045CA	O O	83314
80-87	Exc. 9000 lb Axle with H.D. Suspension & 12000 lb Axle	E0HT18045AA E0HT18045AB E0HT-18045-AB E0HT-18045-AA	O O	83309

LN600

80-85	Models with 11000, 13000, 15000, 17000 lb Axles	D7HT18080BA D7HT-18080-BA	O O	83225
	Models with 3000, 3300 lb Springs and 5000, 5500, 6000, 7000 lb Axles	D7HT18045GA D7HT-18045-GA	O O	83308
	Models with 4400 lb Spring and 7000, 9000 lb Axles	D2EF18045AA D2EF-18045-AA	O O	83312



PICKUP P350

76	Up through 8000# GVW		O O	6150 G63405
68-75	Up through 8000# GVW		O O	6150 81147 G63405
68-73	Single System Steering Stabilizer		O O	6802SE SM							

PICKUP P400

75-76	Up through 8000# GVW		O O	6150 81147 G63405
-------	----------------------	--	--------	------	-------------------------	------	------	------	------	------	------

APPLICATION GUIDE

Year	Fitment Notes	OEM#								
			Fleetline\ Gas SLX	Classic\ Ultra\ ProGuard\ Guardian	Max Control\ LTV Severe Duty\ Load Carrier	Steering Dampers\ Steering Stabilizer\ Cab Shock	Fleetline\ Gas SLX	Classic\ Ultra\ ProGuard\ Guardian	Max Control\ LTV Severe Duty\ Load Carrier\ HiJackers	Steering Dampers\ Steering Stabilizer\ Cab Shock

FORD

FORD

PICKUP, F-450 SUPERDUTY

17-23	Models with 4WD and OEM number	ASH-85927 LC3Z-18125-W ASH-866127 ASH-866139 LC3Z-18125-J HC3Z-18125-EP HC3Z-18125-X ASH-85789		77986
	Models with RWD and OEM number	ASH-25770 HC3Z-18125-ED HC3Z-18125-EE HC3Z-18125-B ASH-85857 ASH-85856		77987
13-23	All			77967
17-22	4 X 4			14072	
13-16	4 X 2			77968
	4 X 4			14072		77969
09-12	All			58944
08-12	4 X 4			14072	
07-08	All			G63969	58944 77967
05-07	4 X 2			77968
	4 X 4			77969
99-07	Models with single or dual rear wheels with 165" or 201" wheel base	ASH247 AT-611 AT-610 F81Z-18125-DC F81A-18080-DCA F81Z18125DC F81A18080DCA AT610 ASH-23488 AT611 ASH23488 ASH23486 ASH-247 ASH-23486		G63461
05-06	All			G63969	77967
99-04	All			61655 G63809	58809 77809	77461
	Steering Stabilizer			6854SE ⁸⁰							
97	All			G63692	61554 G63409	43167 ⁸⁰

PICKUP, F-550 SUPERDUTY

17-23	Models with 4WD and OEM number	ASH-85927 LC3Z-18125-W ASH-866127 ASH-866139 LC3Z-18125-J HC3Z-18125-EP HC3Z-18125-X ASH-85789		77986
	Models with RWD and OEM number	ASH-25770 HC3Z-18125-ED HC3Z-18125-EE HC3Z-18125-B ASH-85857 ASH-85856		77987
13-23	All			77967
17-22	4 X 4			14072	
13-16	4 X 2			77968
	4 X 4			14072		77969

8 Pair Packs.;

80 Mounting bracket not required, install on O.E. Shock Mounts. See Ref. C for optional Steering Stabilizer Boots;

APPLICATION GUIDE

Year	Fitment Notes	OEM#								
			Fleetline/ Gas SLX	Classic/ Ultra/ ProGuard/ Guardian	Max Control/ LTV Severe Duty/ Load Carrier	Steering Dampers/ Steering Stabilizer/ Cab Shock	Fleetline/ Gas SLX	Classic/ Ultra/ ProGuard/ Guardian	Max Control/ LTV Severe Duty/ Load Carrier/ HiJackers	Steering Dampers/ Steering Stabilizer/ Cab Shock

FORD

FORD

PICKUP, F-550 SUPERDUTY (cont)

10-12	All			58944	
08-12	4 X 4			14072	
05-07	All			G63969	77967	
	4 X 2			77968	
	4 X 4			77969	
99-07	Models with single or dual rear wheels with 165" or 201" wheel base	ASH247 AT-611 AT-610 F81Z-18125-DC F81A-18080-DCA F81Z18125DC F81A18080DCA AT610 ASH-23488 AT611 ASH23488 ASH23486 ASH-247 ASH-23486		G63461	
99-04	All			61655 G63809	58809 77809	77461	
	Steering Stabilizer			6854SE ⁸⁰						

VAN 1 TON, ECONOLINE / CLUB WAGON / SUPERDUTY

23-24	All			81744 ⁴⁸	58622 77614	61646 81828	58623 77623	
21-24	Steering Stabilizer			6828SE ⁸⁰								
21-22	All			81744 ⁴⁸ G63622	58622 77614	61646 81828 G63623	49178 ⁷ 58623 77623	
10-19	All			81744 ⁴⁸ G63622	34076 ⁸ 58622 77614	61646 81828 G63623	49178 ⁷ 58623	
03-19	Exc. Cutaway Chassis			77623	
	Steering Stabilizer			6828SE ⁸⁰								
03-09	All			G63622	58622 77614	61646 G63623	58623	

FOREST RIVER

FOREST RIVER

ALL AMERICAN

	MotorHomes with Ford E350 or E450 Chassis	ASH1154 8C2418045DA 8C2Z-18124-D 8C2Z18124D 8C24-18045-DA ASH-1154 AT163G AT-163G		G63622	58622 77614
		8C24-18080-DB 8C2Z18125D ASH-1136 8C2Z-18125-D AT164G 8C2418080DB ASH1136 AT-164G		G63623



CLASS A MOTORHOMES

	MotorHomes with Workhorse UFO Chassis with Hendrickson Softek Front Suspension	66153-002 66153002 F4-BE5-C832-MO F4BE5C832MO		83124
--	--	--	--	-------	------	------	------	------	------	------	------

7 Pair Packs, Air hose kit included.;
48 Installation Hardware Included;

8 Pair Packs.;
80 Mounting bracket not required, install on O.E. Shock Mounts. See Ref. C for optional Steering Stabilizer Boots;

APPLICATION GUIDE

Year	Fitment Notes	OEM#								
			Fleetline\ Gas SLX	Classic\ Ultra\ ProGuard\ Guardian	Max Control\ LTV Severe Duty\ Load Carrier	Steering Dampers\ Steering Stabilizer\ Cab Shock	Fleetline\ Gas SLX	Classic\ Ultra\ ProGuard\ Guardian	Max Control\ LTV Severe Duty\ Load Carrier\ HiJackers	Steering Dampers\ Steering Stabilizer\ Cab Shock

FOREST RIVER

FOREST RIVER

FORESTER

20	MotorHomes with Ford E350 or E450 Chassis	ASH1154 8C2418045DA 8C2Z-18124-D 8C2Z18124D 8C24-18045-DA ASH-1154 AT163G AT-163G	 O	G63622	58622 77614	 O
		8C24-18080-DB 8C2Z18125D ASH-1136 8C2Z-18125-D AT164G 8C2418080DB ASH1136 AT-164G	 O	 O	G63623	58623 77623
04-19	MotorHomes with Ford E350 or E450 Chassis	ASH1154 8C2418045DA 8C2Z-18124-D 8C2Z18124D 8C24-18045-DA ASH-1154 AT163G AT-163G	 O	G63622	58622 77614	 O
		8C24-18080-DB 8C2Z18125D ASH-1136 8C2Z-18125-D AT164G 8C2418080DB ASH1136 AT-164G	 O	 O	G63623	58623 77623





FORESTER GTS

15-18	MotorHomes with Ford E350 or E450 Chassis	ASH1154 8C2418045DA 8C2Z-18124-D 8C2Z18124D 8C24-18045-DA ASH-1154 AT163G AT-163G	 O	G63622	58622 77614	 O
		8C24-18080-DB 8C2Z18125D ASH-1136 8C2Z-18125-D AT164G 8C2418080DB ASH1136 AT-164G	 O	 O	G63623	58623 77623

FORESTER TS

17-22	MotorHomes with Ford Transit-350 Chassis	 O	G57816 ⁴⁰	 O	G64177
-------	--	-------	------	----------------------	------	------	-------	------	--------	------	------	------

APPLICATION GUIDE

Year	Fitment Notes	OEM#								
			 Fleetline\ Gas SLX	Classic\ Ultra\ ProGuard\ Guardian	Max Control\ LTV Severe Duty\ Load Carrier	Steering Dampers\ Steering Stabilizer\ Cab Shock	 Fleetline\ Gas SLX	Classic\ Ultra\ ProGuard\ Guardian	Max Control\ LTV Severe Duty\ Load Carrier\ HiJackers	Steering Dampers\ Steering Stabilizer\ Cab Shock

FOREST RIVER

FR3



FOREST RIVER

13-23	MotorHomes with Ford F53 Chassis with 16,000 lb GVW to 22,000 lb GVW	ASH-1229 ASH-1228 9U94-18045-AA ASH-1205 AT-620 ASH25823 ASH-1022 ASH1022 1C3418045JA ASH-25822 ASH1205 ASH-25823 ASH1228 ASH1229 AT620 1C34-18045-JA AT766 9U9Z18124A ASH294 1C3418045AA 1C34-18045-AA ASH-294 9U9418045AA 9U9Z-18124-A ASH25822 AT-766	83209
		O/O	83122 89406
		O/O

GEORGETOWN

08-17	MotorHomes with Ford F53 Chassis with 16,000 lb GVW to 22,000 lb GVW	ASH-1229 ASH-1228 9U94-18045-AA ASH-1205 AT-620 ASH25823 ASH-1022 ASH1022 1C3418045JA ASH-25822 ASH1205 ASH-25823 ASH1228 ASH1229 AT620 1C34-18045-JA AT766 9U9Z18124A ASH294 1C3418045AA 1C34-18045-AA ASH-294 9U9418045AA 9U9Z-18124-A ASH25822 AT-766	83209
		O/O	83122 89406
		O/O

APPLICATION GUIDE

Year	Fitment Notes	OEM#								
			Fleetline\ Gas SLX	Classic\ Ultra\ ProGuard\ Guardian	Max Control\ LTV Severe Duty\ Load Carrier	Steering Dampers\ Steering Stabilizer\ Cab Shock	Fleetline\ Gas SLX	Classic\ Ultra\ ProGuard\ Guardian	Max Control\ LTV Severe Duty\ Load Carrier\ HiJackers	Steering Dampers\ Steering Stabilizer\ Cab Shock

FOREST RIVER

FOREST RIVER





GEORGETOWN GT3

16-23	MotorHomes with Ford F53 Chassis with 16,000 lb GVW to 22,000 lb GVW	ASH-1229 ASH-1228 9U94-18045-AA ASH-1205 AT-620 ASH25823 ASH-1022 ASH1022 1C3418045JA ASH-25822 ASH1205 ASH-25823 ASH1228 ASH1229 AT620 1C34-18045-JA AT766 9U9Z18124A ASH294 1C3418045AA 1C34-18045-AA ASH-294 9U9418045AA 9U9Z-18124-A ASH25822 AT-766	83209	
		OIO	83122 89406
		9U9Z18125A ASH-1206 ASH137 AT-621 ASH-25824 ASH-1023 ASH25824 ASH-1230 9U9418080AA ASH1230 ASH1023 9U94-18080-AA 9U9Z-18125-A AT621 ASH1206 ASH-137	
		OIO	83122 89406

GEORGETOWN GT5

17-23	MotorHomes with Ford F53 Chassis with 16,000 lb GVW to 22,000 lb GVW	ASH-1229 ASH-1228 9U94-18045-AA ASH-1205 AT-620 ASH25823 ASH-1022 ASH1022 1C3418045JA ASH-25822 ASH1205 ASH-25823 ASH1228 ASH1229 AT620 1C34-18045-JA AT766 9U9Z18124A ASH294 1C3418045AA 1C34-18045-AA ASH-294 9U9418045AA 9U9Z-18124-A ASH25822 AT-766	83209	
		OIO
		9U9Z18125A ASH-1206 ASH137 AT-621 ASH-25824 ASH-1023 ASH25824 ASH-1230 9U9418080AA ASH1230 ASH1023 9U94-18080-AA 9U9Z-18125-A AT621 ASH1206 ASH-137	
		OIO	83122 89406

APPLICATION GUIDE

Year	Fitment Notes	OEM#								
			 Fleetline\ Gas SLX	Classic\ Ultra\ ProGuard\ Guardian	Max Control\ LTV Severe Duty\ Load Carrier	Steering Dampers\ Steering Stabilizer\ Cab Shock	 Fleetline\ Gas SLX	Classic\ Ultra\ ProGuard\ Guardian	Max Control\ LTV Severe Duty\ Load Carrier\ HiJackers	Steering Dampers\ Steering Stabilizer\ Cab Shock

FOREST RIVER

FOREST RIVER

GEORGETOWN GT7

20-23	MotorHomes with Ford F53 Chassis with 16,000 lb GVW to 22,000 lb GVW	ASH-1229 ASH-1228 9U94-18045-AA ASH-1205 AT-620 ASH25823 ASH-1022 ASH1022 1C3418045JA ASH-25822 ASH1205 ASH-25823 ASH1228 ASH1229 AT620 1C34-18045-JA AT766 9U9Z18124A ASH294 1C3418045AA 1C34-18045-AA ASH-294 9U9418045AA 9U9Z-18124-A ASH25822 AT-766	83209		
		9U9Z18125A ASH-1206 ASH137 AT-621 ASH-25824 ASH-1023 ASH25824 ASH-1230 9U9418080AA ASH1230 ASH1023 9U94-18080-AA 9U9Z-18125-A AT621 ASH1206 ASH-137	83122 89406
		ASH1161 ASH25821 ASH-25821 ASH-1161	85006
		ASH25820 ASH1162 ASH-25820 ASH-1162	85005 89430



LEXINGTON

03-15	MotorHomes with Ford E350 or E450 Chassis	ASH1154 8C2418045DA 8C2Z-18124-D 8C2Z18124D 8C24-18045-DA ASH-1154 AT163G AT-163G	G63622	58622 77614
		8C24-18080-DB 8C2Z18125D ASH-1136 8C2Z-18125-D AT164G 8C2418080DB ASH1136 AT-164G	G63623	58623 77623

REFLECTION

02-04	MotorHomes with Freightliner XC Chassis & ADL200 Suspension w/ 20K Rear	1616873000 16-16873-000 141700131809 1616736000 16-16736-000	85029
		MotorHomes with Freightliner XC Chassis and AS120 Front Suspension	83160

APPLICATION GUIDE

Year	Fitment Notes	OEM#								
			Fleetline\ Gas SLX	Classic\ Ultra\ ProGuard\ Guardian	Max Control\ LTV Severe Duty\ Load Carrier	Steering Dampers\ Steering Stabilizer\ Cab Shock	Fleetline\ Gas SLX	Classic\ Ultra\ ProGuard\ Guardian	Max Control\ LTV Severe Duty\ Load Carrier\ HiJackers	Steering Dampers\ Steering Stabilizer\ Cab Shock

FOREST RIVER

FOREST RIVER

REFLECTION (cont)

02-04	MotorHomes with Freightliner XC ChassisZF & IFS Front Suspension with 23,000 lb GVW or Greater	1618103000 16-18103-000 481700000493	85900
-------	--	--	-------	------	------	------	------	------	------	------





SOLERA

21-23	MotorHomes with Ford E350 or E450 Chassis	ASH1154 8C2418045DA 8C2Z-18124-D 8C2Z18124D 8C24-18045-DA ASH-1154 AT163G AT-163G	G63622	58622 77614
		8C24-18080-DB 8C2Z18125D ASH-1136 8C2Z-18125-D AT164G 8C2418080DB ASH1136 AT-164G	G63623	58623 77623
10-15	MotorHomes with Ford E350 or E450 Chassis	ASH1154 8C2418045DA 8C2Z-18124-D 8C2Z18124D 8C24-18045-DA ASH-1154 AT163G AT-163G	G63622	58622 77614
		8C24-18080-DB 8C2Z18125D ASH-1136 8C2Z-18125-D AT164G 8C2418080DB ASH1136 AT-164G	G63623	58623 77623

SUNSEEKER

23	MotorHomes with Ford E350 or E450 Chassis	ASH1154 8C2418045DA 8C2Z-18124-D 8C2Z18124D 8C24-18045-DA ASH-1154 AT163G AT-163G	G63622	58622 77614
		8C24-18080-DB 8C2Z18125D ASH-1136 8C2Z-18125-D AT164G 8C2418080DB ASH1136 AT-164G	G63623	58623 77623
07-22	MotorHomes with Ford E350 or E450 Chassis	ASH1154 8C2418045DA 8C2Z-18124-D 8C2Z18124D 8C24-18045-DA ASH-1154 AT163G AT-163G	G63622	58622 77614
		8C24-18080-DB 8C2Z18125D ASH-1136 8C2Z-18125-D AT164G 8C2418080DB ASH1136 AT-164G	G63623	58623 77623
99-06	MotorHomes with Ford E350 or E450 Chassis	ASH1154 8C2418045DA 8C2Z-18124-D 8C2Z18124D 8C24-18045-DA ASH-1154 AT163G AT-163G	G63622	58622 77614

APPLICATION GUIDE

Year	Fitment Notes	OEM#								
			 Fleetline/ Gas SLX	Classic/ Ultra/ ProGuard/ Guardian	Max Control/ LTV Severe Duty/ Load Carrier	Steering Dampers/ Steering Stabilizer/ Cab Shock	 Fleetline/ Gas SLX	Classic/ Ultra/ ProGuard/ Guardian	Max Control/ LTV Severe Duty/ Load Carrier/ HiJackers	Steering Dampers/ Steering Stabilizer/ Cab Shock





FOREST RIVER

FOREST RIVER



SUNSEEKER (cont)

99-06	MotorHomes with Ford E350 or E450 Chassis	8C24-18080-DB 8C2Z18125D ASH-1136 8C2Z-18125-D AT164G 8C2418080DB ASH1136 AT-164G		G63623	58623 77623
-------	---	--	-------	-------	-------	-------	---	--------	----------------	-------



SUNSEEKER GTS

19-20	MotorHomes with Ford E350 or E450 Chassis	ASH1154 8C2418045DA 8C2Z-18124-D 8C2Z18124D 8C24-18045-DA ASH-1154 AT163G AT-163G	G63622	58622 77614	
		8C24-18080-DB 8C2Z18125D ASH-1136 8C2Z-18125-D AT164G 8C2418080DB ASH1136 AT-164G		G63623	58623 77623
15-18	MotorHomes with Ford E350 or E450 Chassis	ASH1154 8C2418045DA 8C2Z-18124-D 8C2Z18124D 8C24-18045-DA ASH-1154 AT163G AT-163G	G63622	58622 77614	
		8C24-18080-DB 8C2Z18125D ASH-1136 8C2Z-18125-D AT164G 8C2418080DB ASH1136 AT-164G		G63623	58623 77623

SUNSEEKER TS

17-22	MotorHomes with Ford Transit-350 Chassis			G57816 ⁴⁰		G64177
-------	--	--	---	-------	----------------------	-------	-------	---	-------	--------	-------	-------

TSUNAMI

02-06	MotorHomes with Freightliner XC Chassis & ADL200 Suspension w/ 20K Rear	1616873000 16-16873-000 141700131809 1616736000 16-16736-000		85029
	MotorHomes with Freightliner XC Chassis and AS120 Front Suspension	16-16874-000 1616874000 1616737000 16-16737-000 141700131810	83160	
	MotorHomes with Freightliner XC ChassisZF & IFS Front Suspension with 23,000 lb GVW or Greater	1618103000 16-18103-000 481700000493	85900	

FREIGHTLINER

FREIGHTLINER

B2

05-23	Models with 12000 lb Taperleaf Front Suspension	10-13634-000 10-13211-000 1013211000 1013634000		85918	
-------	---	--	---	-------	-------	-------	-------	---	-------	-------	-------	-------

APPLICATION GUIDE

Year	Fitment Notes	OEM#								
			Fleetline\ Gas SLX	Classic\ Ultra\ ProGuard\ Guardian	Max Control\ LTV Severe Duty\ Load Carrier	Steering Dampers\ Steering Stabilizer\ Cab Shock	Fleetline\ Gas SLX	Classic\ Ultra\ ProGuard\ Guardian	Max Control\ LTV Severe Duty\ Load Carrier\ HiJackers	Steering Dampers\ Steering Stabilizer\ Cab Shock

FREIGHTLINER

FREIGHTLINER

B2 (cont)

05-23	Models with FAS II (40,000 lb) Rear Air Suspension	16-15817-000 1618708000 1613957000 1615817000 16-13957-000 16-18708-000 48170006848 680611 471700002809 SDA471700002809	O O	85006	85724 89443
05-22	Models with 15,000 lb Rear Suspension	6803260000	O I	83120	83120

BUS CHASSIS

	FB Shuttle bus chassis with O.E.M. Number	16-16765-000 1616765000 471700131775	O O	85006
	School Bus Chassis with 7,000 lb Suspension	471700005079 10-13859-000 1013859000	O O	85005
	Shuttle Bus Chassis	16-16082-000 1616082000	O O	85043
09-12	Type C School bus chassis with O.E.M. Number	16-18713-000 1618713000 471700003070	O I	85122	85122
97-08	F65 School bus chassis with 10,000 to 18,000 lb Suspension	6803230300 1013759000 471700003009 10-13759-000 GBL665538	O O	85006
	F65 School bus chassis with Taperleaf Spring	6803260000 GBL654725	O I	83120	83120

FC70

05-07	Models with 10,000 to 18,000 lb Suspension	6803230300 1013759000 471700003009 10-13759-000 GBL665538	O O	85006
	Models with 6000 to 9000 lb Front Axle	654654 6803230200	O O	85043
	Models with Freightliner FAS II Rear Air Suspension	16-15817-000 1613957000 1615817000 16-13957-000 680611 680339	O O	85006	85724 89443
99-04	Models with 10,000 to 18,000 lb Suspension	6803230300 1013759000 471700003009 10-13759-000 GBL665538	O O	85006
	Models with 6000 to 9000 lb Front axle	654654 6803230200	O O	85043

FL50

95-05	Day Cab Suspensions with O.E.M. Number	1832999001 18-32999-001 18-60295-000 1830378000 18-30378-000 1860295000	O O	83006
	Models with 10,000 to 18,000 lb Suspension	6803230300 1013759000 471700003009 10-13759-000 GBL665538	O O	85006
	Models with 15,000 lb Rear Suspension	6803260000 GBL654725	O I	83120	83120
	Models with 6000 to 9000 lb Front axle	654654 6803230200	O O	85043

APPLICATION GUIDE

Year	Fitment Notes	OEM#								
				Fleetline/ Gas SLX	Classic/ Ultra/ ProGuard/ Guardian	Max Control/ LTV Severe Duty/ Load Carrier	Steering Dampers/ Steering Stabilizer/ Cab Shock		Fleetline/ Gas SLX	Classic/ Ultra/ ProGuard/ Guardian

FREIGHTLINER

FL50 (cont)

95-05	Models with FAS II (40,000 lb) Rear Air Suspension	16-15817-000 1613957000 1615817000 16-13957-000 680611 680339	O O	O O	85724 89443
-------	--	--	--------	-------	-------	-------	-------	--------	----------------	-------	-------	-------



FL60

96-05	Day Cab Suspensions with O.E.M. Number	1832999001 18-32999-001 18-60295-000 1830378000 18-30378-000 1860295000	O O	83006	O O
91-05	Models with 10,000 to 18,000 lb Suspension	6803230300 1013759000 471700003009 10-13759-000 GBL665538	O O O O	85006	O O O O
	Models with 6000 to 9000 lb Front axle	654654 6803230200	O O	85043	O O
	Models with FAS II (40,000 lb) Rear Air Suspension	16-15817-000 1613957000 1615817000 16-13957-000 680611 680339	O O	O O	85724 89443
	Trucks with Link Cabmate Models FRT153BC-A , FRT106BC or FRT106HD-A	12020054 12010054 1201-0054 1202-0054	O O	83021	O O
	w/ 15000 lb Rear Suspension	6803260000 GBL654725	O O	O O	83120

M2

	Models O.E.M. Number	10-13592-000 1013592000 471700000440	O O	85959	O O	
05-21	Models with FAS II (40,000 lb) Rear Air Suspension	16-15817-000 1618708000 1615817000 16-18708-000 481700006848 680611 471700002809 SDA471700002809	O O O O O O	O O O O O O	85724 89443
	Models with Freightliner TufTrac Rear Air Suspension	1615770000 481700125969 16-15770-000	O O	O O	85956
	Models with Hendrickson HMX 400/460 Haulmax with 16.5" Saddle	H60680004 60680-004L 60680-004 60680004 60680004L	O O O O	O O O O	83143
	Models with Hendrickson HMX 400/460 Haulmax with 17.5" & 18.5" Saddle	60680-005L 60680005L 60680005 HDR60680-005 HDR60680005 60680-005	O O O O O	O O O O	83142
	Models with Rear 10000 lb - 15000 lb Low Profile AirLiner	16-18711-000 16-16577-000 1616577000 1618711000 471700002996	O O O O	O O O O	85335
	Models with Rear 52" Spring ,10000 lb - 15000 lb	16-16486-000 16-18710-000 1616486000 1618710000 471700002995	O O O O	O O O O	83134
	Models with Rear 52" Spring ,18000 lb - 23000 lb	1616442000 1618709000 471700002994 16-16442-000 16-18709-000	O O O O	O O O O	83134

APPLICATION GUIDE

Year	Fitment Notes	OEM#								
			Fleetline\ Gas SLX	Classic\ Ultra\ ProGuard\ Guardian	Max Control\ LTV Severe Duty\ Load Carrier	Steering Dampers\ Ultra\ Steering Stabilizer\ Cab Shock	Fleetline\ Gas SLX	Classic\ Ultra\ ProGuard\ Guardian	Max Control\ LTV Severe Duty\ Load Carrier\ Hijackers	Steering Dampers\ Ultra\ Steering Stabilizer\ Cab Shock

FREIGHTLINER

FREIGHTLINER

M2 (cont)

05-21	Models with Rear 60" Spring ,18000 lb - 23000 lb	1618707000 16-15765-000 471700002993 1615765000 16-18707-000	O 	85921
05-15	Models with Freightliner Low Profile Rear Air Suspension (18,000 to 40,000 lb)	16-14259-000 1614259000 1618706000 680511 471700002992 16-18706-000	O O 	85331





M2 100

02-10	Models with FAS II (40,000 lb) Rear Air Suspension	16-15817-000 1618708000 1615817000 16-18708-000 481700006848 680611 471700002809 SDA471700002809	O O 	85724 89443
	Models with Freightliner Low Profile Rear Air Suspension (18,000 to 40,000 lb)	16-14259-000 1614259000 1618706000 680511 471700002992 16-18706-000	O O 	85331
	Models with Freightliner TufTrac Rear Air Suspension	1615770000 481700125969 16-15770-000	O O 	85956
	Models with Hendrickson HMX 400/460 Haulmax with 16.5" Saddle	H60680004 60680-004L 60680-004 60680004 60680004L	O 	83143
	Models with Hendrickson HMX 400/460 Haulmax with 17.5" & 18.5" Saddle	60680-005L 60680005L 60680005 HDR60680-005 HDR60680005 60680-005	O 	83142
	Models with Rear 10000 lb - 15000 lb Low Profile AirLiner	16-18711-000 16-16577-000 1616577000 1618711000 471700002996	O O 	85335
	Models with Rear 52" Spring ,10000 lb - 15000 lb	16-16486-000 16-18710-000 1616486000 1618710000 471700002995	O 	83134
	Models with Rear 52" Spring ,18000 lb - 23000 lb	1616442000 1618709000 471700002994 16-16442-000 16-18709-000	O 	83134
	Models with Rear 60" Spring ,18000 lb - 23000 lb	1618707000 16-15765-000 471700002993 1615765000 16-18707-000	O 	85921

M2 106

09-24	Models with 8000 to 16000 lb Front Axle and Taperleaf Spring	10-13760-000 1013760000 10-13592-000 471700000440 471700002991 SDA471700002991	O O 	85959
02-24	Day Cab Models with Spring Suspensions	1860766000 18-47350-000 18-60766-000 814903003482 1847350000	O O 	83040

APPLICATION GUIDE

Year	Fitment Notes	OEM#								
			 Fleetline/ Gas SLX	Classic/ Ultra/ ProGuard/ Guardian	Max Control/ LTV Severe Duty/ Load Carrier	Steering Dampers/ Steering Stabilizer/ Cab Shock	 Fleetline/ Gas SLX	Classic/ Ultra/ ProGuard/ Guardian	Max Control/ LTV Severe Duty/ Load Carrier/ HiJackers	Steering Dampers/ Steering Stabilizer/ Cab Shock

FREIGHTLINER

M2 106 (cont)

FREIGHTLINER

02-24	Models with FAS II (40,000 lb) Rear Air Suspension	16-15817-000 1618708000 1615817000 16-18708-000 481700006848 680611 471700002809 SDA471700002809	85724 89443
	Models with Freightliner TufTrac Rear Air Suspension	1615770000 481700125969 16-15770-000	85956
	Models with Hendrickson HMX 400/460 Haulmax with 16.5" Saddle	H60680004 60680-004L 60680-004 60680004 60680004L	83143
	Models with Hendrickson HMX 400/460 Haulmax with 17.5" & 18.5" Saddle	60680-005L 60680005L 60680005 HDR60680-005 HDR60680005 60680-005	83142
02-23	Models with Rear 10000 lb - 15000 lb Low Profile AirLiner	16-18711-000 16-16577-000 1616577000 1618711000 471700002996	85335
	Models with Rear 52" Spring ,10000 lb - 15000 lb	16-16486-000 16-18710-000 1616486000 1618710000 471700002995	83134
	Models with Rear 52" Spring ,18000 lb - 23000 lb	1616442000 1618709000 471700002994 16-16442-000 16-18709-000	83134
	Models with Rear 60" Spring ,18000 lb - 23000 lb	1618707000 16-15765-000 471700002993 1615765000 16-18707-000	85921
	Models with Reyco 79KB Rear Steel Spring Suspension	19495-01 1672501 16725-01 1949501	83126 89430
02-15	Models with Freightliner Low Profile Rear Air Suspension (18,000 to 40,000 lb)	16-14259-000 1614259000 1618706000 680511 471700002992 16-18706-000	85331
02-08	Models with 10000 to 12000 lb. Taper-leaf Spring Suspension	1012390000 10-12390-000	85920
	Models with 6000 to 9000 lb Front axle	10-12388-000 1012388000	85920

MB CHASSIS

	MB Chassis (VIP bus)	16-17760-000 1617760000 471700131778 16-16827-000 1616827000	85331
	MB55 Chassis	16-17759-000 471700000447 1617759000	85919
	MB55 Models w/8000 lb. flat leaf front suspension	16-17684-000 1617684000	85058
	MB55 Shuttle bus w/8000 lb. flat leaf front suspension	1615676000 16-15676-000	85058

APPLICATION GUIDE

Year	Fitment Notes	OEM#								
			Fleetline\ Gas SLX	Classic\ Ultra\ ProGuard\ Guardian	Max Control\ LTV Severe Duty\ Load Carrier	Steering Dampers\ Steering Stabilizer\ Cab Shock	Fleetline\ Gas SLX	Classic\ Ultra\ ProGuard\ Guardian	Max Control\ LTV Severe Duty\ Load Carrier\ HiJackers	Steering Dampers\ Steering Stabilizer\ Cab Shock

FREIGHTLINER

FREIGHTLINER

MC CHASSIS

	MC Chassis with Hendrickson Softtek Front Suspension	1618094000 16-18094-000 471700000466	O O	85959
	MC Chassis with O.E.M. Number	471700002727 1618456000 16-18456-000	O O	85959
	MC-L Chassis with 9,000 lb Suspension	471700002726 1618455000 16-18455-000	O O	85918
96-99	MC Chassis for Class A Motorhomes	P117099	O I	83120

MP 14

	MP 14 Chassis	16-15475-000 1615475000	O O	83164
--	---------------	----------------------------	--------	-------	------	------	------	------	------	------	------	------

MP 19

	MP 19 Chassis	16-15475-000 1615475000	O O	83164
--	---------------	----------------------------	--------	-------	------	------	------	------	------	------	------	------



MT45

98-23	Step Van Models with O.E.M. Number	16-20628-000 471700003011 1619138000 16-22004-000 471700011302 16-19138-000	O O	85058
	Walkin Step Van Models (18 Foot) with O.E.M. Number	1615064000 16-20552-000 16-16542-000 16-15064-000 471700010991 16-15436-000 1620552000 1615436000 1616542000	O I	83154
99-20	MT45 Step Van - w/35" Front Spring	1615473000 1615474000 16-15473-000 16-15474-000	O O	83157
	MT45 Step Van - w/38" Front Spring	16-15475-000 1615475000	O O	83164
98-20	Models with O.E.M. Number	16-15394-000 1615394000	O I	83120

MT55

	MT55 Models w/8000 lb. flat leaf front suspension	1615676000 16-17684-000 1617684000 16-15676-000	O O	85058
	MT55 Step Van with O.E.M. Number	16-16542-000 16-15436-000 1615436000 1616542000	O I	83154
99-23	Models with Freightliner Low Profile Rear Air Suspension	1618706000 16-18706-000	O O	85331
	MT55 Chassis with O.E.M. Number	16-17759-000 1620632000 471700000447 16-20632-000 1617759000	O O	85919
99-20	MT55 Step Van - w/35" Front Spring	1615473000 1615474000 16-15473-000 16-15474-000	O O	83157
	MT55 Step Van - w/38" Front Spring	16-15475-000 1615475000	O O	83164
99-11	Models with O.E.M. Number	1615934000 1615705000 16-16262-000 1616262000 16-15934-000 16-15705-000	O I	83120

APPLICATION GUIDE

Year	Fitment Notes	OEM#								
			Fleetline/ Gas SLX	Classic/ Ultra/ ProGuard/ Guardian	Max Control/ LTV Severe Duty/ Load Carrier	Steering Dampers/ Steering Stabilizer/ Cab Shock	Fleetline/ Gas SLX	Classic/ Ultra/ ProGuard/ Guardian	Max Control/ LTV Severe Duty/ Load Carrier/ HiJackers	Steering Dampers/ Steering Stabilizer/ Cab Shock

FREIGHTLINER VARIOUS

FREIGHTLINER

	Fleetwood Motor Home with O.E.M. Number	GBL 651375 RW24285	O O	83119
	M-Line Walk in Van with O.E.M. Number	P117099 MAE 16949	O I	83120
	Models with 7000 lb Front Suspension	10-13776-000 1013776000	O O	85005
	Models with Neway Air Suspension with shock stamping	90045083	O O	85910
	Oshkosh Motor Home with O.E.M. Number	1398980	O O	83127
	Step Van Models with O.E.M. Number	471700003011 1619138000 16-19138-000	O O	85058

VC CHASSIS

03-12	VC Chassis - ADL200 Suspension w/ 23,000 lb GVW & Higher	141700131809 1616736000 16-16736-000	O O	85029
03-07	MotorHome Chassis with ZF - IFS Front Suspension (23,000 lb GVW & Higher)	1618103000 16-18103-000 481700000493	I T	85900
	VC Chassis - ADL200 Suspension w/ 20K Rear	1616873000 16-16873-000 471700131974	O O	85029
93-07	VC Chassis - Neway AS-120 Front Air Suspension (Up To 22000 lb GVW)	1616737000 16-16737-000	O O	83160



XB CHASSIS

	MotorHome Chassis with Neway AS-120, 10,500 lb Front Air Suspension	141700000377 16-18075-000	O O	83160
	MotorHome Chassis with Neway AS-120, 12,000 lb Front Air Suspension	1618076000 16-16874-000 141700000378 1616874000 16-18076-000 141700131975	O O	83160

XC CHASSIS

	MotorHome Chassis with Neway AS-120, 10,500 lb Front Air Suspension	141700000377 16-18075-000	O O	83160
	MotorHome Chassis with Neway AS-120, 12,000 lb Front Air Suspension	1618076000 16-16874-000 141700000378 1616874000 16-18076-000 141700131975	O O	83160
	MotorHome Chassis with ZF-IFS, 12,000 lb Front Air Suspension	16-17144-000 1617361000 481700000477 481700131919 1617144000 16-17361-000	I I	85900
03-12	MotorHome Chassis with Neway AS-120 Front Air Suspension (23,000 lb GVW & Higher)	16-16874-000 1616874000 1616737000 16-16737-000 141700131810	O O	83160

APPLICATION GUIDE

Year	Fitment Notes	OEM#								
			Fleetline\ Gas SLX	Classic\ Ultra\ ProGuard\ Guardian	Max Control\ LTV Severe Duty\ Load Carrier	Steering Dampers\ Steering Stabilizer\ Cab Shock	Fleetline\ Gas SLX	Classic\ Ultra\ ProGuard\ Guardian	Max Control\ LTV Severe Duty\ Load Carrier\ HiJackers	Steering Dampers\ Steering Stabilizer\ Cab Shock

FREIGHTLINER

FREIGHTLINER

XC CHASSIS (cont)

03-12	XC Chassis - ADL200 Suspension w/ 23,000 lb GVW & Higher	141700131809 1616736000 16-16736-000			85029
03-07	MotorHome Chassis with ZF - IFS Front Suspension (23,000 lb GVW & Higher)	1618103000 16-18103-000 481700000493		85900
	XC Chassis - ADL200 Suspension w/ 20K Rear	1616873000 16-16873-000 471700131974			85029
93-07	MotorHome Chassis with Neway AS-120 Front Air Suspension (Up To 22000 lb GVW)	1616737000 16-16737-000		83160

XCS CHASSIS

01-02	XCS Chassis with Freightliner Rear Air Suspension	16-16093-000 1616093000		83160
00-02	XCS Chassis (22000 lb GVW) w/ O.E.M. Number	1615755000 16-15755-000 1616043000 16-16043-000		85043
		16-15592-000 1615592000			83154

GEORGIE BOY MANUFACTURING

GEORGIE BOY MANUFACTURING





CLASS A MOTORHOMES

	Models with Workhorse UFO Chassis with Hendrickson Softek Front Suspension	66153-002 66153002 F4-BE5-C832-MO F4BE5C832MO		83124
99-09	All Series MotorHomes with Ford F53 Chassis with 16,000 lb GVW to 22,000 lb GVW	ASH-1229 ASH-1228 9U94-18045-AA ASH-1205 AT-620 ASH-1022 1C34-18045-AA ASH-294 9U9Z-18124-A ASH-25822 ASH-25823 1C34-18045-JA AT-766		83209
		9U9Z18125A ASH-1206 ASH137 AT-621 ASH-25824 ASH-1023 ASH25824 ASH-1230 9U9418080AA ASH1230 ASH1023 9U94-18080-AA 9U9Z-18125-A AT621 ASH1206 ASH-137			83122 89406

CLASS C MOTORHOMES

99-09	Maverick Series MotorHomes with Ford E450 Chassis	ASH-1154		G63622	58622 77614
		ASH-1136		G63623	58623 77623

APPLICATION GUIDE

Year	Fitment Notes	OEM#								
			 Fleetline/ Gas SLX	Classic/ Ultra/ ProGuard/ Guardian	Max Control/ LTV Severe Duty/ Load Carrier	Steering Dampers/ Steering Stabilizer/ Cab Shock	 Fleetline/ Gas SLX	Classic/ Ultra/ ProGuard/ Guardian	Max Control/ LTV Severe Duty/ Load Carrier/ HiJackers	Steering Dampers/ Steering Stabilizer/ Cab Shock

GLAVAL BUS CO.

GLAVAL BUS CO.

CONCORDE II - SERIES

15-23	Models with F-650 chassis with 13,500, 15,500 & 19,000 lb Multi-leaf Rear Springs	FC4Z-18125-A FC4418080AB ASH-24660 FC4Z18125A 471700011531 FC44-18080-AB ASH24660	85180
	Models with F-650 chassis with 19.5" or 22.5" Wheels (22,000 lb GVW)	FC4Z-18124-B FC4Z-18124-A ASH-24659 ASH-24658 ASH24659 ASH24658 471700011530 FC4Z18124B FC4Z18124A FC44-18045-BB FC4418045BB	85181
04-15	Models with F-650 chassis with 21,000 lb Rear Air Suspension	3578858C1 3578858C2 4C4Z-18125-DA 4C4Z18125DA	85656
	Models with F-650 chassis with 22,000 lb Multi-leaf Rear Springs	4C4Z-18125-B 501906C92 ASH24661	83317
00-15	Models with F-650 chassis with 10,000 lb Front Suspension	4C4Z18124QA 3584116C1 3584116C2 AA616 AA-616 4C4Z-18124-QA	83175
	Models with F-650 chassis with 12,000 & 13,200 lb Front Springs	4C4Z18124RA 4C4Z-18124-JB 4C4Z18124JB 3584118C2 AA-617 AT812 4C4Z-18124-RA AA617 AT-812	85928

VARIOUS

	Primetime Series Shuttle buses with Ford E350 Chassis	ASH-1154	G63622	58622 77614
		ASH-1136	G63623	58623 77623
	Sport Series Shuttle buses with Ford E350 Chassis	ASH-1154	G63622	58622 77614
		ASH-1136	G63623	58623 77623
	Universal Series Shuttle buses with Ford E350 & E450 Chassis	ASH-1154	G63622	58622 77614
		ASH-1136	G63623	58623 77623

GMC

GMC



3500 & 4000 SERIES

63-66	Truck and School Bus	85005	83221
60-62	3500, 4000, B-4000, L-4000, S-4000 with H-130, H-150 and 13800 Axles	83221

4500 SERIES

72-80	PS4620 P, 4650P Step Van (Walk-in)	22012096 3192892	83221
	PS4620 P, 4650P Step Van (Walk-in) 3/4" Upper bolt	4940606 22012166 4975497 22007701 22002293 3192890 22012095	83126

APPLICATION GUIDE

Year	Fitment Notes	OEM#								
			Fleetline\ Gas SLX	Classic\ Ultra\ ProGuard\ Guardian	Max Control\ LTV Severe Duty\ Load Carrier	Steering Dampers\ Steering Stabilizer\ Cab Shock	Fleetline\ Gas SLX	Classic\ Ultra\ ProGuard\ Guardian	Max Control\ LTV Severe Duty\ Load Carrier\ HiJackers	Steering Dampers\ Steering Stabilizer\ Cab Shock

GMC

GMC

4500 SERIES (cont)

72-80	PS4620 P, 4650P Step Van (Walk-in) 5/8" Upper bolt	22007751	O O	83303
66-72	CE-4500, CS-4500 Conventional Cab with V-8 Gas or In-line 6 Gas Engines	22012096 3192892	O O	83221
	EG-4500, EM-4500, ES-4500 Cab/Cowl with V-6 Gas or Diesel or In-line 6 Gas Engines	3171068 4940614 3192657 4963854 4963853	O O	83216
		3171462 3192890 22012095	O O	83126 89430

5000 SERIES

76-89	C Chassis - Conventional Cab	22012096 22012196	O O	83221
75-80	C Chassis - Conventional Cab	4975510	O O	83221
73-80	C, S Chassis - Conventional Cab	22007750 4975494 4975467	O O	83207
63-68	W-5000, BW-5000, DW-5000	O O	85005
60-62	5000, B-5000, L-5000, S-5000 with 1618 or 16802 Axle	O O	83221





5500 SERIES

73-89	C, S Chassis - Conventional Cab and School Bus	22012166 22012095	O O	83126
66-72	CE-5500, CS-5500 Conventional Cab with V-8 Gas or In-line 6 Gas Engines	22012096 3192892 3192891	O O	83221
	CG-5500, CM-5500, T-5500 Conventional & Tilt Cab with V-6 Gas or Diesel Engines	4940606 3192890 22012095	O O	83126
	EG-5500, EM-5500, ES-5500 Cab/Cowl with 6 Cyl. Engines	3171068 4940614 3192657 4963854 4963853	O O	83216
		3171462 3192890 22012095	O O	83126 89430
63-68	W-5500	O O	85005
60-68	LW-5500	O O	85307

6000 SERIES

79-80	W Chassis - 72" BBC Steel Tilt Cab	22002293	O O	83126
		22007751	O O	83303
73-75	C, S Chassis - Conventional Cab and School Bus - Exc. with 18500, 20800 & 23000 lb. Rear Axle	22007750 4975494 4975467	O O	83207
63-68	DW - 6000	O O	85005
60-68	L - 6000	O O	85307

APPLICATION GUIDE

Year	Fitment Notes	OEM#								
			 Fleetline/ Gas SLX	Classic/ Ultra/ ProGuard/ Guardian	Max Control/ LTV Severe Duty/ Load Carrier	Steering Dampers/ Steering Stabilizer/ Cab Shock	 Fleetline/ Gas SLX	Classic/ Ultra/ ProGuard/ Guardian	Max Control/ LTV Severe Duty/ Load Carrier/ HiJackers	Steering Dampers/ Steering Stabilizer/ Cab Shock

GMC

GMC

6500 SERIES

75-89	C, M Chassis - Conventional Cab with 9000 & 12000 lb. Axle	22007751 22002295 22017531 4975511 22017530	O O	83303
73-80	C, M, S Chassis - Conventional Cab and School Bus - Exc. with 20800 or 23000 lb. Rear Axle	22012169 22012096 3192892	O O	83221
	C, M, S Chassis - Conventional Cab and School Bus with 20800 or 23000 lb. Rear Axle	4940606 22012166 22012095	O O	83126 89430
	C, S, T Chassis - Conventional & Tilt Cab and School Bus	4940606 4975497 22002293 3192890 22012095	O O	83126
75-76	C, M Chassis - Conventional Cab	4975510	O O	83221
73-75	C, M Chassis - Conventional Cab with 9000 & 12000 lb. Axle	4940606 4975497 3192890 22012095	O O O	83126
		4940614 4963854	O O	83216
	C, M, S Chassis - Conventional Cab and School Bus	22007750 4975494 4975467	O O	83207
66-72	CE-6500, CM-6500 Conventional Cab with V-6 Diesel or V-8 Gas Engine	3192892	O O	83221
	CE-6500, ME-6500 Conventional Cab with V-8 Gas Engine - Exc. 11000 lb. Axle	22012096 3192892 3192891	O O	83221
	CE-6500, ME-6500 Conventional Cab with V-8 Gas Engine with 11000 lb. Axle	4940606 3192890 22012095	O O	83126
	CM-6500, TE-6500, TM-6500 Conventional Cab with V-6 Diesel or V-8 Gas Engine	4940606 3192890 22012095	O O	83126
		22012096	O	83221
	EG-6500, DM-6500, ES-6500 Cab/Cowl with V-6 Gas or Diesel or In-line 6 Gas Engines	3171068 3192657 4963853	O O	83216
	3171462 3192890 22012095	O	83126 89430	



B7

93-02	Models with O.E.M. Number	88982682 15588554 22064230 15123676	I	83136
	School Bus Chassis w/15000, 19000, 21000 lb Multileaf Springs	15174902 22064232	I	85071

C - SERIES (C4500, C5500) TOPKICK

90-99	C Chassis - Conventional Cab with 9100 to 17500 lb Rear Axle	22064432	O O	83221
83-89	C Chassis - Conventional Cab with 9100 to 17500 lb. Rear Axle	22064432	O O	83221

APPLICATION GUIDE

Year	Fitment Notes	OEM#								
			Fleetline\ Gas SLX	Classic\ Ultra\ ProGuard\ Guardian	Max Control\ LTV Severe Duty\ Load Carrier	Steering Dampers\ Steering Stabilizer\ Cab Shock	Fleetline\ Gas SLX	Classic\ Ultra\ ProGuard\ Guardian	Max Control\ LTV Severe Duty\ Load Carrier\ HiJackers	Steering Dampers\ Steering Stabilizer\ Cab Shock

GMC

GMC





C4500 TOPKICK

03-09	C Chassis - Conventional Cab with 15000, 19000, 21000 lb Multileaf Springs	15174902 88982686 22064232	85071
	C Chassis - Conventional Cab with 19000, 21000, 23000 lb Taperleaf Springs (EXC Low Profile Vehicle)	22064233	83136
	C Chassis - Conventional Cab with Front Shock with O.E.M. Number	88982682 15588554 15887728 19152843 22064230 15123676	83136
	Models with Link Cabmate Model GMT560	12021043 12011043 1201-1043 1202-1043	O O	83025
	Truck Cabs with Link Cabmate Model GMC104TK	12020054 12010054 1201-0054 1202-0054	O O	83021
90-02	C Chassis - Conventional Cab with 15000, 19000, 21000 lb Multileaf Springs	15174902 88982686 22064232	85071
	C Chassis - Conventional Cab with 19000, 21000, 23000 lb Taperleaf Springs (EXC Low Profile Vehicle)	22064233	83136
	C Chassis - Conventional Cab with Front Shock with O.E.M. Number	88982682 15588554 15887728 19152843 22064230 15123676	83136

C5500 TOPKICK

03-09	C Chassis - Conventional Cab with 15000, 19000, 21000 lb Multileaf Springs	15174902 88982686 22064232	85071
	C Chassis - Conventional Cab with 19000, 21000, 23000 lb Taperleaf Springs (EXC Low Profile Vehicle)	22064233	83136
	C Chassis - Conventional Cab with Front Shock with O.E.M. Number	88982682 15588554 15887728 19152843 22064230 15123676	83136
	Models with Link Cabmate Model GMT560	12021043 12011043 1201-1043 1202-1043	O O	83025
	Truck Cabs with Link Cabmate Model GMC104TK	12020054 12010054 1201-0054 1202-0054	O O	83021
90-02	C Chassis - Conventional Cab with 15000, 19000, 21000 lb Multileaf Springs	15174902 88982686 22064232	85071
	C Chassis - Conventional Cab with 19000, 21000, 23000 lb Taperleaf Springs (EXC Low Profile Vehicle)	22064233	83136

APPLICATION GUIDE

Year	Fitment Notes	OEM#								
			 Fleetline\ Gas SLX	Classic\ Ultra\ ProGuard\ Guardian	Max Control\ LTV Severe Duty\ Load Carrier	Steering Dampers\ Steering Stabilizer\ Cab Shock	 Fleetline\ Gas SLX	Classic\ Ultra\ ProGuard\ Guardian	Max Control\ LTV Severe Duty\ Load Carrier\ HiJackers	Steering Dampers\ Steering Stabilizer\ Cab Shock

GMC

GMC

C5500 TOPKICK (cont)

90-02	C Chassis - Conventional Cab with Front Shock with O.E.M. Number	88982682 15588554 15887728 19152843 22064230 15123676	 	83136
-------	--	--	------	-------	------	------	------	--	------	------	------	------

C6000 TOPKICK

90-96	Truck Cabs with Link Cabmate Model GMC104TK	12020054 12010054 1201-0054 1202-0054	 	83021	
-------	---	--	----------------	------	------	------	-------	--	------	------	------	------

C6500 TOPKICK

03-09	Truck Cabs with Link Cabmate Model GMC104TK	12020054 12010054 1201-0054 1202-0054	 	83021	
97-01	Truck Cabs with Link Cabmate Model GMC104TK	12020054 12010054 1201-0054 1202-0054	 	83021	

C7000 TOPKICK

90-96	Truck Cabs with Link Cabmate Model GMC104TK	12020054 12010054 1201-0054 1202-0054	 	83021	
-------	---	--	----------------	------	------	------	-------	--	------	------	------	------

C7500 TOPKICK

97-09	Truck Cabs with Link Cabmate Model GMC104TK	12020054 12010054 1201-0054 1202-0054	 	83021	
-------	---	--	----------------	------	------	------	-------	--	------	------	------	------

SAVANA 4500

10-20	All		 	61685 G63895	61687 G63897	77638
-------	-----	--	------	------	-----------------	------	------	------	------	-----------------	-------	------



T5500

97-09	FL1 Tilt Cab with 8100 lb Axle	22165188 22165187 22064804 22064805	 	83136
	FL2 Tilt Cab with 5000 to 11000 lb Axle	22166442 22064807	 	83136
	FL3 Tilt Cab with 14575 lb Axle	22165189 22064806	 	83136
90-06	Tilt Cab with 15000, 19000, 21000 lb Multileaf Springs	15174902 22064232	 		85071
92-99	Tilt Cab with 19000, 21000, 23000 lb Taperleaf Springs (EXC Low Profile Veh.)	22064233	 		83136
99	Models with Hendrickson Air Suspension (Stamping number 47902-13)	12474915 15963161	 		83122 89406

T6500

04-09	FL1 Tilt Cab with 8100 lb Axle	22165188 22165187 22064804 22064805	 	83136
	FL2 Tilt Cab with 5000 to 11000 lb Axle	22166442 22064807	 	83136
	FL3 Tilt Cab with 14575 lb Axle	22165189 22064806	 	83136

APPLICATION GUIDE

Year	Fitment Notes	OEM#								
			Fleetline\ Gas SLX	Classic\ Ultra\ ProGuard\ Guardian	Max Control\ LTV Severe Duty\ Load Carrier	Steering Dampers\ Steering Stabilizer\ Cab Shock	Fleetline\ Gas SLX	Classic\ Ultra\ ProGuard\ Guardian	Max Control\ LTV Severe Duty\ Load Carrier\ HiJackers	Steering Dampers\ Steering Stabilizer\ Cab Shock

GMC

GMC



T6500 (cont)

04-06	Tilt Cab with 15000, 19000, 21000 lb Multileaf Springs	15174902 22064232		85071
03	FL1 Tilt Cab with 8100 lb Axle	22165188 22165187 22064804 22064805	83136
	FL2 Tilt Cab with 5000 to 11000 lb Axle	22166442 22064807	83136
	FL3 Tilt Cab with 14575 lb Axle	22165189 22064806	83136
	Tilt Cab with 15000, 19000, 21000 lb Multileaf Springs	15174902 22064232		85071
97-02	FL1 Tilt Cab with 8100 lb Axle	22165188 22165187 22064804 22064805	83136
	FL2 Tilt Cab with 5000 to 11000 lb Axle	22166442 22064807	83136
	FL3 Tilt Cab with 14575 lb Axle	22165189 22064806	83136
	Tilt Cab with 15000, 19000, 21000 lb Multileaf Springs	15174902 22064232		85071
97-99	Tilt Cab with 19000, 21000, 23000 lb Taperleaf Springs (EXC Low Profile Veh.)	22064233		83136
99	Models with Hendrickson Air Suspension (Stamping number 47902-13)	12474915 15963161		83122 89406
92-96	Tilt Cab with 19000, 21000, 23000 lb Taperleaf Springs (EXC Low Profile Veh.)	22064233		83136
90-96	Tilt Cab with 15000, 19000, 21000 lb Multileaf Springs	15174902 22064232		85071

W - SERIES (ISUZU)

	Models with O.E.M. Number	98098127 8972019600 98098125 8970830290 898098-1250 94454987 97253616 97253623 8-97201-960-0 97253621 8-97083-029-0 8980981270 97201960 898098-1270 8980981250	83515
		98098059 898098-0590 898098-0581 98098058 8-97253665-0 898098-0580 8972536650 8980980581 97253665 8980980590 97253651 8980980580		83159

APPLICATION GUIDE

Year	Fitment Notes	OEM#								
			Fleetline\ Gas SLX	Classic\ Ultra\ ProGuard\ Guardian	Max Control\ LTV Severe Duty\ Load Carrier	Steering Dampers\ Steering Stabilizer\ Cab Shock	Fleetline\ Gas SLX	Classic\ Ultra\ ProGuard\ Guardian	Max Control\ LTV Severe Duty\ Load Carrier\ HiJackers	Steering Dampers\ Steering Stabilizer\ Cab Shock

GMC

GMC

W4500 FORWARD

92-10	Models with 11000 lb & 13000 lb Suspension	9516306471 97083029 94454987 98232671 97083027 8972536200 97253620 8-97253-620-0 8944549870 8944549860 9-51630-647-1 8-94454-986-0 8-94454-987-0	 O	83515
-------	--	--	-------	-------	------	------	------	------	------	------	------

W5500 FORWARD

88-10	Models with 11000 lb & 13000 lb Suspension	97253620	 O	83515
-------	--	----------	-------	-------	------	------	------	------	------	------	------

W6500 FORWARD

87-96	Models with 11000 lb & 13000 lb Suspension	1516301681 1-51630-168-1	 O	83515
-------	--	-----------------------------	-------	-------	------	------	------	------	------	------	------

GOSHEN COACH

GOSHEN COACH

VARIOUS

	Impule Series Shuttle buses with Ford E350 & E450 Chassis	ASH1154 ASH-1154	 O	G63622	58622 77614	
		ASH-1136 ASH1136	 O	 O	G63623	58623 77623
	Pacer II Series Shuttle buses with Ford E350 Chassis	ASH1154 ASH-1154	 O	G63622	58622 77614	 O
		ASH-1136 ASH1136	 O	 O	G63623	58623 77623

GRECH MOTORS

GRECH MOTORS

	Shuttle buses with Ford E450 Chassis	ASH-1154	 O	G63622	58622 77614
		ASH-1136	 O	 O	G63623	58623 77623

GULF STREAM

GULF STREAM





ATRIUM

03-06	Models with Freightliner XC Chassis with ZF - IFS Front Suspension and 23,000 lb GVW or Greater	1618103000 16-18103-000 481700000493	 T	85900	
		MotorHomes with Freightliner XC Chassis & AS120 Front Suspension	16-16874-000 1616874000 1616737000 16-16737-000 141700131810	 O	83160	 O
		MotorHomes with Freightliner XC Chassis and ADL200 Suspension w/ 20K Rear	1616873000 16-16873-000 141700131809 1616736000 16-16736-000	 O	 O	85029

BT CRUISER

16-23	MotorHomes with Ford E350 or E450 Chassis	ASH1154 8C2418045DA 8C2Z-18124-D 8C2Z18124D 8C24-18045-DA ASH-1154 AT163G AT-163G	 O	G63622	58622 77614
-------	---	--	-------	------	--------	----------------	------	------	------	------	------

APPLICATION GUIDE

Year	Fitment Notes	OEM#								
			 Fleetline\ Gas SLX	Classic\ Ultra\ ProGuard\ Guardian	Max Control\ LTV Severe Duty\ Load Carrier	Steering Dampers\ Steering Stabilizer\ Cab Shock	 Fleetline\ Gas SLX	Classic\ Ultra\ ProGuard\ Guardian	Max Control\ LTV Severe Duty\ Load Carrier\ HiJackers	Steering Dampers\ Steering Stabilizer\ Cab Shock

GULF STREAM

BT CRUISER (cont)

16-23	MotorHomes with Ford E350 or E450 Chassis	8C24-18080-DB 8C2Z18125D ASH-1136 8C2Z-18125-D AT164G 8C2418080DB ASH1136 AT-164G	 ○															
02-15	MotorHomes with Ford E350 or E450 Chassis	ASH1154 8C2418045DA 8C2Z-18124-D 8C2Z18124D 8C24-18045-DA ASH-1154 AT163G AT-163G	 ○															
		8C24-18080-DB 8C2Z18125D ASH-1136 8C2Z-18125-D AT164G 8C2418080DB ASH1136 AT-164G	 ○															

GULF STREAM





CAVALIER

99-06	MotorHomes with Ford E350 or E450 Chassis	ASH-1154	 ○															
		ASH-1136	 ○															

CONQUEST

16-22	MotorHomes with Ford E350 or E450 Chassis	ASH1154 8C2418045DA 8C2Z-18124-D 8C2Z18124D 8C24-18045-DA ASH-1154 AT163G AT-163G	 ○															
		8C24-18080-DB 8C2Z18125D ASH-1136 8C2Z-18125-D AT164G 8C2418080DB ASH1136 AT-164G	 ○															
12-15	MotorHomes with Ford E350 or E450 Chassis	ASH1154 8C2418045DA 8C2Z-18124-D 8C2Z18124D 8C24-18045-DA ASH-1154 AT163G AT-163G	 ○															
		8C24-18080-DB 8C2Z18125D ASH-1136 8C2Z-18125-D AT164G 8C2418080DB ASH1136 AT-164G	 ○															
02-11	MotorHomes with Ford E350 or E450 Chassis	ASH1154 8C2418045DA 8C2Z-18124-D 8C2Z18124D 8C24-18045-DA ASH-1154 AT163G AT-163G	 ○															
		8C24-18080-DB 8C2Z18125D ASH-1136 8C2Z-18125-D AT164G 8C2418080DB ASH1136 AT-164G	 ○															

APPLICATION GUIDE

Year	Fitment Notes	OEM#								
			 Fleetline\ Gas SLX	Classic\ Ultra\ ProGuard\ Guardian	Max Control\ LTV Severe Duty\ Load Carrier	Steering Dampers\ Steering Stabilizer\ Cab Shock	 Fleetline\ Gas SLX	Classic\ Ultra\ ProGuard\ Guardian	Max Control\ LTV Severe Duty\ Load Carrier\ HiJackers	Steering Dampers\ Steering Stabilizer\ Cab Shock

GULF STREAM

GULF STREAM

CONQUEST (cont)

93-01	MotorHomes with Ford E350 or E450 Chassis	ASH1154 8C2418045DA 8C2Z-18124-D 8C2Z18124D 8C24-18045-DA ASH-1154 AT163G AT-163G	 O	G63622	58622 77614
		8C24-18080-DB 8C2Z18125D ASH-1136 8C2Z-18125-D AT164G 8C2418080DB ASH1136 AT-164G	 O		G63623	58623 77623

CONQUEST SPORT

10-11	MotorHomes with Ford E350 or E450 Chassis	ASH1154 8C2418045DA 8C2Z-18124-D 8C2Z18124D 8C24-18045-DA ASH-1154 AT163G AT-163G	 O	G63622	58622 77614
		8C24-18080-DB 8C2Z18125D ASH-1136 8C2Z-18125-D AT164G 8C2418080DB ASH1136 AT-164G	 O		G63623	58623 77623
01-02	MotorHomes with Ford E350 or E450 Chassis	ASH1154 8C2418045DA 8C2Z-18124-D 8C2Z18124D 8C24-18045-DA ASH-1154 AT163G AT-163G	 O	G63622	58622 77614
		8C24-18080-DB 8C2Z18125D ASH-1136 8C2Z-18125-D AT164G 8C2418080DB ASH1136 AT-164G	 O		G63623	58623 77623



ENDURA

08	MotorHomes with Chevy Kodiak Chassis	88982682 15588554 15887728 19152843 22064230 15123676	 T	83136
04-07	MotorHomes with Chevy Kodiak Chassis	88982682 15588554 15887728 19152843 22064230 15123676	 T	83136

FRIENDSHIP

02-06	Models with Freightliner XC Chassis with ZF - IFS Front Suspension and 23,000 lb GVW or Greater	1618103000 16-18103-000 481700000493	 T	85900
	MotorHomes with Freightliner XC Chassis & AS120 Front Suspension	16-16874-000 1616874000 1616737000 16-16737-000 141700131810	 O	83160

APPLICATION GUIDE

Year	Fitment Notes	OEM#								
			Fleetline\ Gas SLX	Classic\ Ultra\ ProGuard\ Guardian	Max Control\ LTV Severe Duty\ Load Carrier	Steering Dampers\ Steering Stabilizer\ Cab Shock	Fleetline\ Gas SLX	Classic\ Ultra\ ProGuard\ Guardian	Max Control\ LTV Severe Duty\ Load Carrier\ HiJackers	Steering Dampers\ Steering Stabilizer\ Cab Shock

GULF STREAM

FRIENDSHIP (cont)

02-06	MotorHomes with Freightliner XC Chassis and ADL200 Suspension w/ 20K Rear	1616873000 16-16873-000 141700131809 1616736000 16-16736-000	85029
-------	---	--	------	------	------	------	-------	------	------	------

GULF STREAM

INDEPENDENCE

00-11	MotorHomes with Ford E350 or E450 Chassis	ASH1154 8C2418045DA 8C2Z-18124-D 8C2Z18124D 8C24-18045-DA ASH-1154 AT163G AT-163G	G63622	58622 77614
		8C24-18080-DB 8C2Z18125D ASH-1136 8C2Z-18125-D AT164G 8C2418080DB ASH1136 AT-164G	G63623	58623 77623
02	Models with Freightliner XC Chassis with ZF - IFS Front Suspension and 23,000 lb GVW or Greater	1618103000 16-18103-000 481700000493	85900
	MotorHomes with Freightliner XC Chassis and ADL200 Suspension w/ 20K Rear	1616873000 16-16873-000 141700131809 1616736000 16-16736-000	85029
	MotorHomes with Freightliner XC Chassis and AS120 Front Suspension	16-16874-000 1616874000 1616737000 16-16737-000 141700131810	83160



MONTAJ

10-11	MotorHomes with Ford E350 or E450 Chassis	ASH1154 8C2418045DA 8C2Z-18124-D 8C2Z18124D 8C24-18045-DA ASH-1154 AT163G AT-163G	G63622	58622 77614
		8C24-18080-DB 8C2Z18125D ASH-1136 8C2Z-18125-D AT164G 8C2418080DB ASH1136 AT-164G	G63623	58623 77623

SCENIC CRUISER

02-06	Models with Freightliner XC Chassis with ZF - IFS Front Suspension and 23,000 lb GVW or Greater	1618103000 16-18103-000 481700000493	85900
	MotorHomes with Freightliner XC Chassis & AS120 Front Suspension	16-16874-000 1616874000 1616737000 16-16737-000 141700131810	83160
	MotorHomes with Freightliner XC Chassis and ADL200 Suspension w/ 20K Rear	1616873000 16-16873-000 141700131809 1616736000 16-16736-000	85029

APPLICATION GUIDE

Year	Fitment Notes	OEM#								
			Fleetline\ Gas SLX	Classic\ Ultra\ ProGuard\ Guardian	Max Control\ LTV Severe Duty\ Load Carrier	Steering Dampers\ Steering Stabilizer\ Cab Shock	Fleetline\ Gas SLX	Classic\ Ultra\ ProGuard\ Guardian	Max Control\ LTV Severe Duty\ Load Carrier\ HiJackers	Steering Dampers\ Steering Stabilizer\ Cab Shock

GULF STREAM ULTRA

GULF STREAM

00-08	MotorHomes with Ford E350 or E450 Chassis	ASH-1154	 O	G63622	58622 77614	 O
		ASH-1136	 O	 O	G63623	58623 77623

YELLOWSTONE

05-11	MotorHomes with Ford E350 or E450 Chassis	ASH1154 8C2418045DA 8C2Z-18124-D 8C2Z18124D 8C24-18045-DA ASH-1154 AT163G AT-163G	 O	G63622	58622 77614	 O
		8C24-18080-DB 8C2Z18125D ASH-1136 8C2Z-18125-D AT164G 8C2418080DB ASH1136 AT-164G	 O	 O	G63623	58623 77623
02-04	Models with Freightliner XC Chassis with ZF - IFS Front Suspension and 23,000 lb GVW or Greater	1618103000 16-18103-000 481700000493	 T	85900	 O
	MotorHomes with Ford E350 or E450 Chassis	ASH1154 8C2418045DA 8C2Z-18124-D 8C2Z18124D 8C24-18045-DA ASH-1154 AT163G AT-163G	 O	G63622	58622 77614	 O
		8C24-18080-DB 8C2Z18125D ASH-1136 8C2Z-18125-D AT164G 8C2418080DB ASH1136 AT-164G	 O	 O	G63623	58623 77623
	MotorHomes with Freightliner XC Chassis & AS120 Front Suspension	16-16874-000 1616874000 1616737000 16-16737-000 141700131810	 O	83160	 O
MotorHomes with Freightliner XC Chassis and ADL200 Suspension w/ 20K Rear	1616873000 16-16873-000 141700131809 1616736000 16-16736-000	 O	 O	85029

HINO

HINO

145

05-10	Models with O.E.M. Number	485003710A S4850-03710 48500-3710	 O	83126	 O
-------	---------------------------	---	-------	-------	------	------	------	-------	------	------	------



155

16-20	Models with O.E.M. Number	48531-37351 4853137351	 O	 O	83519
13-20	Models with O.E.M. Number	4851137320 48511-80162 48511-37320	 O	83518	 O

165

05-10	Models with O.E.M. Number	485003710A S4850-03710 48500-3710	 O	83126	 O
-------	---------------------------	---	-------	-------	------	------	------	-------	------	------	------

APPLICATION GUIDE

Year	Fitment Notes	OEM#								
			Fleetline\ Gas SLX	Classic\ Ultra\ ProGuard\ Guardian	Max Control\ LTV Severe Duty\ Load Carrier	Steering Dampers\ Steering Stabilizer\ Cab Shock	Fleetline\ Gas SLX	Classic\ Ultra\ ProGuard\ Guardian	Max Control\ LTV Severe Duty\ Load Carrier\ Hijackers	Steering Dampers\ Steering Stabilizer\ Cab Shock

HINO

HINO

185

05-10	Models with O.E.M. Number	485003710A S4850-03710 48500-3710	O	83126
		48500-3720 S4850-03720	O	83140

195

21	Models with O.E.M. Number	4851137320 4851180162 48511-80162 48511-37320	O	83518
		48531-37362 48531-37361 4853137362 4853137361	O	83519
12-20	Models with O.E.M. Number	4851137320 4851180162 48511-80162 48511-37320	O	83518
		48531-37362 48531-37361 4853137362 4853137361	O	83519

238

08-14	Models with Hendrickson Comfort Air (Single Axle - 19K)	48530E0100 48530-E0100 60670-014L 60670014L 60670-031L 60670019L 60670029L 60670-019L 60670031L 60670-029L	O	83166
05-14	Models with O.E.M. Number	485003720 S485003720 48500-3720 S4850-03720	O	83140





258

08-23	Models with Hendrickson Comfort Air (Single Axle - 19K)	48530E0100 48530-E0100 60670-014L 60670014L 48530-E0390 60670-031L 60670019L 60670029L 48530E0390 60670-019L 60670031L 60670-029L	O	83166
15-21	Models with O.E.M. Number	48500E0420 48500E0420	O	83391
06-14	Models with O.E.M. Number	485003720 S485003720 48500-3720 S4850-03720	O	83140

258ALP

08-14	Models with Hendrickson Comfort Air (Single Axle - 19K)	48530E0100 48530-E0100 60670-014L 60670014L 60670-031L 60670019L 60670029L 60670-019L 60670031L 60670-029L	O	83166
-------	--	---	---	------	------	------	------	------	-------	------	------	------

APPLICATION GUIDE

Year	Fitment Notes	OEM#								
			 Fleetline\ Gas SLX	Classic\ Ultra\ ProGuard\ Guardian	Max Control\ LTV Severe Duty\ Load Carrier	Steering Dampers\ Steering Stabilizer\ Cab Shock	 Fleetline\ Gas SLX	Classic\ Ultra\ ProGuard\ Guardian	Max Control\ LTV Severe Duty\ Load Carrier\ HiJackers	Steering Dampers\ Steering Stabilizer\ Cab Shock

HINO

HINO

268

08-23	Models with Hendrickson Comfort Air (Single Axle - 19K)	48530E0100 48530-E0100 60670-014L 60670014L 48530-E0390 60670-031L 60670019L 60670029L 48530E0390 60670-019L 60670031L 60670-029L	83166
15-22	Models with O.E.M. Number	48500-E0420 48500E0420	OO	83391
05-14	Models with O.E.M. Number	485003720 S485003720 48500-3720 S4850-03720	OO	83140

268, 268A SERIES

	Models with Hendrickson Rear Air Suspension (Shock stamping #)	60670012 60670-012	OO	83168
--	--	-----------------------	-------	-------	-------	-------	----	-------	-------	-------

268A

08-14	Models with Hendrickson Comfort Air (Single Axle - 19K)	48530E0100 48530-E0100 60670-014L 60670014L 60670-031L 60670019L 60670029L 60670-019L 60670031L 60670-029L	OO	83166
	Models with O.E.M. Number	485003720 S485003720 48500-3720 S4850-03720	OO	83140

ADDITIONAL APPLICATIONS

	Conventional Hino Models with Hendrickson Comfort Air Suspension	60670020 60670-020	OO	83148
	Conventional Hino Models with Hendrickson Comfort Air Suspension (19,000 lb & 21,000 lb Capacity)	60670013 60670-013	OO	83148

FA, FB SERIES

98	FA1517, FA1817, FB1817	OO	G63419
----	------------------------	-------	-------	-------	-------	-------	----	-------	--------	-------

FA14

89-91	Models with O.E.M. Number	S4850-01950 48500-1950 48500-2750 S4850-02750 66639	OO	G63610
-------	---------------------------	---	----	-------	--------	-------	-------	-------	-------	-------

FA15

92	FA, FB Models Trucks with:	S4850-01950 48500-1950 48500-2750 S4850-02750 66639	OO	G63610
		S4853-02510 S4853-01910 48530-2510 34802 48530-1910	OO	83216

APPLICATION GUIDE

Year	Fitment Notes	OEM#								
			Fleetline\ Gas SLX	Classic\ Ultra\ ProGuard\ Guardian	Max Control\ LTV Severe Duty\ Load Carrier	Steering Dampers\ Steering Stabilizer\ Cab Shock	Fleetline\ Gas SLX	Classic\ Ultra\ ProGuard\ Guardian	Max Control\ LTV Severe Duty\ Load Carrier\ HiJackers	Steering Dampers\ Steering Stabilizer\ Cab Shock

HINO

HINO

FA1415

93-97	(FA15)	48500-1950	 ○	G63610
		48530-1910	 ○	83216
	FA, FB Models Trucks with:	S4850-01950 48500-1950 48500-2750 S4850-02750 66639	 ○	G63610
		S4853-02510 S4853-01910 48530-2510 34802 48530-1910	 ○	83216
		FA1415 (FA15), FB1715 (FB15)	48500-1950	 ○	G63610
		48530-1910	 ○	83216

FA1517

98-04	FA, FB Models Trucks with:	S4850-01950 48500-1950 48500-2750 S4850-02750 66639	 ○	G63610
		S4853-02510 S4853-01910 48530-2510 34802 48530-1910	 ○	83216
98	All	48530-2510	 ○	83216
	FA1517, FA1817, FB1817	48530-2510	 ○	83216

FA1817

98	All	48530-2510	 ○	83216
----	-----	------------	-------	------	------	------	------	------	-------	------	------	------

FB14

89-91	FA, FB Models Trucks with:	S4850-01950 48500-1950 48500-2750 S4850-02750 66639	 ○	G63610
		S4853-02510 S4853-01910 48530-2510 34802 48530-1910	 ○	83216





FB15

92	FA, FB Models Trucks with:	S4850-01950 48500-1950 48500-2750 S4850-02750 66639	 ○	G63610
		S4853-02510 S4853-01910 48530-2510 34802 48530-1910	 ○	83216

FB1715

93-97	FA, FB Models Trucks with:	S4850-01950 48500-1950 48500-2750 S4850-02750 66639	 ○	G63610
		S4853-02510 S4853-01910 48530-2510 34802 48530-1910	 ○	83216
		FA1415 (FA15), FB1715 (FB15)	48500-1950	 ○	G63610
		48530-1910	 ○	83216	

APPLICATION GUIDE

Year	Fitment Notes	OEM#								
			 Fleetline\ Gas SLX	Classic\ Ultra\ ProGuard\ Guardian	Max Control\ LTV Severe Duty\ Load Carrier	Steering Dampers\ Steering Stabilizer\ Cab Shock	 Fleetline\ Gas SLX	Classic\ Ultra\ ProGuard\ Guardian	Max Control\ LTV Severe Duty\ Load Carrier\ HiJackers	Steering Dampers\ Steering Stabilizer\ Cab Shock

HINO

HINO

FB1817

98-04	FA, FB Models Trucks with:	S4850-01950 48500-1950 48500-2750 S4850-02750 66639	 ○	G63610
		S4853-02510 S4853-01910 48530-2510 34802 48530-1910	 ○	83216
	FE Models Trucks with:	S4850-01941 48500-1941	 ○	83141
98	All	48530-2510	 ○	83216
	FA1517, FA1817, FB1817	48530-2510	 ○	83216

FD16

86-87	Models with O.E.M. Number	48530-1880 485301880	 ○	83215
-------	---------------------------	-------------------------	-------	-------	-------	-------	-------	-------	-------	-------	-------

FD17

88-92	Models with O.E.M. Number	48530-1880 485301880	 ○	83215
-------	---------------------------	-------------------------	-------	-------	-------	-------	-------	-------	-------	-------	-------

FD2218

93-97	(FD5H), FE5H, FF5H	48500-1801	 ○	83216
		48530-1880	 ○	83215

FD2218LD

93-97	(FD5H), FE5H, FF5H	48530-1880 485301880	 ○	83215
-------	--------------------	-------------------------	-------	-------	-------	-------	-------	-------	-------	-------	-------

FD2218LP

93-97	Models with O.E.M. Number	48500-1801	 ○	83216
		48530-1880	 ○	83215

FE SERIES

98-04	Models Trucks with O.E.M. Number	485001941 S4850-01941 S485001941 48500-1941	 ○	83141
-------	----------------------------------	--	-------	-------	-------	-------	-------	-------	-------	-------	-------

FE16

86-87	All	48500-1801	 ○	83216
-------	-----	------------	-------	-------	-------	-------	-------	-------	-------	-------	-------

FE2620

98	All	48530-1880 485301880	 ○	83215
----	-----	-------------------------	-------	-------	-------	-------	-------	-------	-------	-------	-------

FF SERIES

98	FF3320	48530-1880 485301880	 ○	83215
----	--------	-------------------------	-------	-------	-------	-------	-------	-------	-------	-------	-------

FF3020

03	FF Models Trucks with O.E.M. Number	485001941 48500-1941	 ○	83141
----	-------------------------------------	-------------------------	-------	-------	-------	-------	-------	-------	-------	-------	-------



GC17

90-91	GC17	48500-1801	 ○	83216
-------	------	------------	-------	-------	-------	-------	-------	-------	-------	-------	-------

GC20

92	GC20	48500-1801	 ○	83216
----	------	------------	-------	-------	-------	-------	-------	-------	-------	-------	-------

APPLICATION GUIDE

Year	Fitment Notes	OEM#								
			Fleetline\ Gas SLX	Classic\ Ultra\ ProGuard\ Guardian	Max Control\ LTV Severe Duty\ Load Carrier	Steering Dampers\ Steering Stabilizer\ Cab Shock	Fleetline\ Gas SLX	Classic\ Ultra\ ProGuard\ Guardian	Max Control\ LTV Severe Duty\ Load Carrier\ HiJackers	Steering Dampers\ Steering Stabilizer\ Cab Shock

HINO

HINO

L6

22-23	Models with Hendrickson Comfort Air (Single Axle - 19K)	48530E0100 48530-E0100 60670-014L 60670014L 48530-E0390 60670-031L 60670019L 60670029L 48530E0390 60670-019L 60670031L 60670-029L	O O	83166
	Models with O.E.M. Number	48500-E0420 48500E0420	O O	83391
21	Models with Hendrickson Comfort Air (Single Axle - 19K)	48530E0100 48530-E0100 60670-014L 60670014L 60670-031L 60670019L 60670029L 60670-019L 60670031L 60670-029L	O O	83166
	Models with O.E.M. Number	48500-E0420 48500E0420	O O	83391



HOLIDAY RAMBLER

HOLIDAY RAMBLER

ADMIRAL

16-24	MotorHomes with Ford F53 Chassis with 16,000 lb GVW to 22,000 lb GVW	ASH-1229 ASH-1228 9U94-18045-AA ASH-1205 AT-620 ASH25823 ASH-1022 ASH1022 1C3418045JA ASH-25822 ASH1205 ASH-25823 ASH1228 ASH1229 AT620 1C34-18045-JA AT766 9U9Z18124A ASH294 1C3418045AA 1C34-18045-AA ASH-294 9U9418045AA 9U9Z-18124-A ASH25822 AT-766	O O	83209	O O
		9U9Z18125A ASH-1206 ASH137 AT-621 ASH-25824 ASH-1023 ASH25824 ASH-1230 9U9418080AA ASH1230 ASH1023 9U94-18080-AA 9U9Z-18125-A AT621 ASH1206 ASH-137			83122 89406

APPLICATION GUIDE

Year	Fitment Notes	OEM#								
			Fleetline\ Gas SLX	Classic\ Ultra\ ProGuard\ Guardian	Max Control\ LTV Severe Duty\ Load Carrier	Steering Dampers\ Steering Stabilizer\ Cab Shock	Fleetline\ Gas SLX	Classic\ Ultra\ ProGuard\ Guardian	Max Control\ LTV Severe Duty\ Load Carrier\ HiJackers	Steering Dampers\ Steering Stabilizer\ Cab Shock



HOLIDAY RAMBLER

HOLIDAY RAMBLER

ADMIRAL (cont)

11-15	MotorHomes with Ford F53 Chassis with 16,000 lb GVW to 22,000 lb GVW	ASH-1229 ASH-1228 9U94-18045-AA ASH-1205 AT-620 ASH25823 ASH-1022 ASH1022 1C3418045JA ASH-25822 ASH1205 ASH-25823 ASH1228 ASH1229 AT620 1C34-18045-JA AT766 9U9Z18124A ASH294 1C3418045AA 1C34-18045-AA ASH-294 9U9418045AA 9U9Z-18124-A ASH25822 AT-766	83209
		OO			83122 89406
07-10	MotorHomes with Ford F53 Chassis with 16,000 lb GVW to 22,000 lb GVW	ASH-1229 ASH-1228 9U94-18045-AA ASH-1205 AT-620 ASH25823 ASH-1022 ASH1022 1C3418045JA ASH-25822 ASH1205 ASH-25823 ASH1228 ASH1229 AT620 1C34-18045-JA AT766 9U9Z18124A ASH294 1C3418045AA 1C34-18045-AA ASH-294 9U9418045AA 9U9Z-18124-A ASH25822 AT-766	83209
		OO			83122 89406

APPLICATION GUIDE

Year	Fitment Notes	OEM#								
			Fleetline\ Gas SLX	Classic\ Ultra\ ProGuard\ Guardian	Max Control\ LTV Severe Duty\ Load Carrier	Steering Dampers\ Steering Stabilizer\ Cab Shock	Fleetline\ Gas SLX	Classic\ Ultra\ ProGuard\ Guardian	Max Control\ LTV Severe Duty\ Load Carrier\ HiJackers	Steering Dampers\ Steering Stabilizer\ Cab Shock





HOLIDAY RAMBLER

HOLIDAY RAMBLER

ADMIRAL (cont)

02-06	MotorHomes with Ford F53 Chassis with 16,000 lb GVW to 22,000 lb GVW	ASH-1229 ASH-1228 9U94-18045-AA ASH-1205 AT-620 ASH25823 ASH-1022 ASH1022 1C3418045JA ASH-25822 ASH1205 ASH-25823 ASH1228 ASH1229 AT620 1C34-18045-JA AT766 9U9Z18124A ASH294 1C3418045AA 1C34-18045-AA ASH-294 9U9418045AA 9U9Z-18124-A ASH25822 AT-766	83209
		O/O	83122 89406
00-01	Models with Workhorse W22 Chassis with 8.1L Gas V8	01809925	85010
	MotorHomes with Ford F53 Chassis with 16,000 lb GVW to 22,000 lb GVW	ASH-1229 ASH-1228 9U94-18045-AA ASH-1205 AT-620 ASH25823 ASH-1022 ASH1022 1C3418045JA ASH-25822 ASH1205 ASH-25823 ASH1228 ASH1229 AT620 1C34-18045-JA AT766 9U9Z18124A ASH294 1C3418045AA 1C34-18045-AA ASH-294 9U9418045AA 9U9Z-18124-A ASH25822 AT-766	83209
		O/O								

APPLICATION GUIDE

Year	Fitment Notes	OEM#								
			 Fleetline\ Gas SLX	Classic\ Ultra\ ProGuard\ Guardian	Max Control\ LTV Severe Duty\ Load Carrier	Steering Dampers\ Steering Stabilizer\ Cab Shock	 Fleetline\ Gas SLX	Classic\ Ultra\ ProGuard\ Guardian	Max Control\ LTV Severe Duty\ Load Carrier\ HiJackers	Steering Dampers\ Steering Stabilizer\ Cab Shock

HOLIDAY RAMBLER

HOLIDAY RAMBLER



ADMIRAL (cont)

00-01	MotorHomes with Ford F53 Chassis with 16,000 lb GVW to 22,000 lb GVW	9U9Z18125A ASH-1206 ASH137 AT-621 ASH-25824 ASH-1023 ASH25824 ASH-1230 9U9418080AA ASH1230 ASH1023 9U94-18080-AA 9U9Z-18125-A AT621 ASH1206 ASH-137	83122 89406
-------	--	--	------	------	------	------	----------------	------	------	------

ADMIRAL SE

02-06	MotorHomes with Ford F53 Chassis with 16,000 lb GVW to 22,000 lb GVW	ASH-1229 ASH-1228 9U94-18045-AA ASH-1205 AT-620 ASH25823 ASH-1022 ASH1022 1C3418045JA ASH-25822 ASH1205 ASH-25823 ASH1228 ASH1229 AT620 1C34-18045-JA AT766 9U9Z18124A ASH294 1C3418045AA 1C34-18045-AA ASH-294 9U9418045AA 9U9Z-18124-A ASH25822 AT-766	83209
		9U9Z18125A ASH-1206 ASH137 AT-621 ASH-25824 ASH-1023 ASH25824 ASH-1230 9U9418080AA ASH1230 ASH1023 9U94-18080-AA 9U9Z-18125-A AT621 ASH1206 ASH-137	83122 89406

APPLICATION GUIDE

Year	Fitment Notes	OEM#								
			Fleetline\ Gas SLX	Classic\ Ultra\ ProGuard\ Guardian	Max Control\ LTV Severe Duty\ Load Carrier	Steering Dampers\ Steering Stabilizer\ Cab Shock	Fleetline\ Gas SLX	Classic\ Ultra\ ProGuard\ Guardian	Max Control\ LTV Severe Duty\ Load Carrier\ HiJackers	Steering Dampers\ Steering Stabilizer\ Cab Shock

HOLIDAY RAMBLER

HOLIDAY RAMBLER





ADMIRAL SVE

07	MotorHomes with Ford F53 Chassis with 16,000 lb GVW to 22,000 lb GVW	ASH-1229 ASH-1228 9U94-18045-AA ASH-1205 AT-620 ASH25823 ASH-1022 ASH1022 1C3418045JA ASH-25822 ASH1205 ASH-25823 ASH1228 ASH1229 AT620 1C34-18045-JA AT766 9U9Z18124A ASH294 1C3418045AA 1C34-18045-AA ASH-294 9U9418045AA 9U9Z-18124-A ASH25822 AT-766	83209
		OIO	83122 89406
		9U9Z18125A ASH-1206 ASH137 AT-621 ASH-25824 ASH-1023 ASH25824 ASH-1230 9U9418080AA ASH1230 ASH1023 9U94-18080-AA 9U9Z-18125-A AT621 ASH1206 ASH-137	OIO

ADMIRAL XE

16-18	MotorHomes with Ford F53 Chassis with 16,000 lb GVW to 22,000 lb GVW	ASH-1229 ASH-1228 9U94-18045-AA ASH-1205 AT-620 ASH25823 ASH-1022 ASH1022 1C3418045JA ASH-25822 ASH1205 ASH-25823 ASH1228 ASH1229 AT620 1C34-18045-JA AT766 9U9Z18124A ASH294 1C3418045AA 1C34-18045-AA ASH-294 9U9418045AA 9U9Z-18124-A ASH25822 AT-766	83209
		OIO	83122 89406
		9U9Z18125A ASH-1206 ASH137 AT-621 ASH-25824 ASH-1023 ASH25824 ASH-1230 9U9418080AA ASH1230 ASH1023 9U94-18080-AA 9U9Z-18125-A AT621 ASH1206 ASH-137	OIO

APPLICATION GUIDE

Year	Fitment Notes	OEM#								
			 Fleetline/ Gas SLX	Classic/ Ultra/ ProGuard/ Guardian	Max Control/ LTV Severe Duty/ Load Carrier	Steering Dampers/ Steering Stabilizer/ Cab Shock	 Fleetline/ Gas SLX	Classic/ Ultra/ ProGuard/ Guardian	Max Control/ LTV Severe Duty/ Load Carrier/ HiJackers	Steering Dampers/ Steering Stabilizer/ Cab Shock

HOLIDAY RAMBLER

HOLIDAY RAMBLER



ALTERA

19	MotorHomes with Ford E450 Chassis	ASH1154 8C2418045DA 8C2Z-18124-D 8C2Z18124D 8C24-18045-DA ASH-1154 AT163G AT-163G	 O		G63622	58622 77614				
		8C24-18080-DB 8C2Z18125D ASH-1136 8C2Z-18125-D AT164G 8C2418080DB ASH1136 AT-164G	 O					G63623	58623 77623	
18	MotorHomes with Ford E450 Chassis	ASH1154 8C2418045DA 8C2Z-18124-D 8C2Z18124D 8C24-18045-DA ASH-1154 AT163G AT-163G	 O		G63622	58622 77614				
		8C24-18080-DB 8C2Z18125D ASH-1136 8C2Z-18125-D AT164G 8C2418080DB ASH1136 AT-164G	 O					G63623	58623 77623	

ATLANTIS

09-10	MotorHomes with Ford E450 Chassis	ASH1154 8C2418045DA 8C2Z-18124-D 8C2Z18124D 8C24-18045-DA ASH-1154 AT163G AT-163G	 O		G63622	58622 77614				
		8C24-18080-DB 8C2Z18125D ASH-1136 8C2Z-18125-D AT164G 8C2418080DB ASH1136 AT-164G	 O					G63623	58623 77623	
08	MotorHomes with Ford E450 Chassis	ASH1154 8C2418045DA 8C2Z-18124-D 8C2Z18124D 8C24-18045-DA ASH-1154 AT163G AT-163G	 O		G63622	58622 77614				
		8C24-18080-DB 8C2Z18125D ASH-1136 8C2Z-18125-D AT164G 8C2418080DB ASH1136 AT-164G	 O					G63623	58623 77623	
07	MotorHomes with Ford E450 Chassis	ASH1154 8C2418045DA 8C2Z-18124-D 8C2Z18124D 8C24-18045-DA ASH-1154 AT163G AT-163G	 O		G63622	58622 77614				
		8C24-18080-DB 8C2Z18125D ASH-1136 8C2Z-18125-D AT164G 8C2418080DB ASH1136 AT-164G	 O					G63623	58623 77623	

APPLICATION GUIDE

Year	Fitment Notes	OEM#								
			Fleetline\ Gas SLX	Classic\ Ultra\ ProGuard\ Guardian	Max Control\ LTV Severe Duty\ Load Carrier	Steering Dampers\ Steering Stabilizer\ Cab Shock	Fleetline\ Gas SLX	Classic\ Ultra\ ProGuard\ Guardian	Max Control\ LTV Severe Duty\ Load Carrier\ HiJackers	Steering Dampers\ Steering Stabilizer\ Cab Shock

HOLIDAY RAMBLER

HOLIDAY RAMBLER





ATLANTIS (cont)

06	MotorHomes with Ford E450 Chassis	ASH1154 8C2418045DA 8C2Z-18124-D 8C2Z18124D 8C24-18045-DA ASH-1154 AT163G AT-163G	 O		G63622	58622 77614				
		8C24-18080-DB 8C2Z18125D ASH-1136 8C2Z-18125-D AT164G 8C2418080DB ASH1136 AT-164G	 O							G63623
02-05	MotorHomes with Ford E450 Chassis	ASH1154 8C2418045DA 8C2Z-18124-D 8C2Z18124D 8C24-18045-DA ASH-1154 AT163G AT-163G	 O		G63622	58622 77614				
		8C24-18080-DB 8C2Z18125D ASH-1136 8C2Z-18125-D AT164G 8C2418080DB ASH1136 AT-164G	 O							G63623
99-01	MotorHomes with Ford E450 Chassis	ASH1154 8C2418045DA 8C2Z-18124-D 8C2Z18124D 8C24-18045-DA ASH-1154 AT163G AT-163G	 O		G63622	58622 77614				
		8C24-18080-DB 8C2Z18125D ASH-1136 8C2Z-18125-D AT164G 8C2418080DB ASH1136 AT-164G	 O							G63623

AUGUSTA

19	MotorHomes with Ford E450 Chassis	ASH1154 8C2418045DA 8C2Z-18124-D 8C2Z18124D 8C24-18045-DA ASH-1154 AT163G AT-163G	 O		G63622	58622 77614				
		8C24-18080-DB 8C2Z18125D ASH-1136 8C2Z-18125-D AT164G 8C2418080DB ASH1136 AT-164G	 O							G63623
15-16	MotorHomes with Ford E450 Chassis	ASH1154 8C2418045DA 8C2Z-18124-D 8C2Z18124D 8C24-18045-DA ASH-1154 AT163G AT-163G	 O		G63622	58622 77614				
		8C24-18080-DB 8C2Z18125D ASH-1136 8C2Z-18125-D AT164G 8C2418080DB ASH1136 AT-164G	 O							G63623

APPLICATION GUIDE

Year	Fitment Notes	OEM#								
			 Fleetline/ Gas SLX	Classic/ Ultra/ ProGuard/ Guardian	Max Control/ LTV Severe Duty/ Load Carrier	Steering Dampers/ Steering Stabilizer/ Cab Shock	 Fleetline/ Gas SLX	Classic/ Ultra/ ProGuard/ Guardian	Max Control/ LTV Severe Duty/ Load Carrier/ HiJackers	Steering Dampers/ Steering Stabilizer/ Cab Shock

HOLIDAY RAMBLER

HOLIDAY RAMBLER



AUGUSTA (cont)

11	MotorHomes with Ford E450 Chassis	ASH1154 8C2418045DA 8C2Z-18124-D 8C2Z18124D 8C24-18045-DA ASH-1154 AT163G AT-163G	 O	G63622	58622 77614	 O
		8C24-18080-DB 8C2Z18125D ASH-1136 8C2Z-18125-D AT164G 8C2418080DB ASH1136 AT-164G	 O	G63623	58623 77623
08-09	MotorHomes with Ford E450 Chassis	ASH1154 8C2418045DA 8C2Z-18124-D 8C2Z18124D 8C24-18045-DA ASH-1154 AT163G AT-163G	 O	G63622	58622 77614	 O
		8C24-18080-DB 8C2Z18125D ASH-1136 8C2Z-18125-D AT164G 8C2418080DB ASH1136 AT-164G	 O	G63623	58623 77623

AUGUSTA B+

12-13	MotorHomes with Ford E450 Chassis	ASH1154 8C2418045DA 8C2Z-18124-D 8C2Z18124D 8C24-18045-DA ASH-1154 AT163G AT-163G	 O	G63622	58622 77614	 O
		8C24-18080-DB 8C2Z18125D ASH-1136 8C2Z-18125-D AT164G 8C2418080DB ASH1136 AT-164G	 O	G63623	58623 77623
10	MotorHomes with Ford E450 Chassis	ASH1154 8C2418045DA 8C2Z-18124-D 8C2Z18124D 8C24-18045-DA ASH-1154 AT163G AT-163G	 O	G63622	58622 77614	 O
		8C24-18080-DB 8C2Z18125D ASH-1136 8C2Z-18125-D AT164G 8C2418080DB ASH1136 AT-164G	 O	G63623	58623 77623
07	MotorHomes with Ford E450 Chassis	ASH1154 8C2418045DA 8C2Z-18124-D 8C2Z18124D 8C24-18045-DA ASH-1154 AT163G AT-163G	 O	G63622	58622 77614	 O
		8C24-18080-DB 8C2Z18125D ASH-1136 8C2Z-18125-D AT164G 8C2418080DB ASH1136 AT-164G	 O	G63623	58623 77623

APPLICATION GUIDE

Year	Fitment Notes	OEM#								
			Fleetline\ Gas SLX	Classic\ Ultra\ ProGuard\ Guardian	Max Control\ LTV Severe Duty\ Load Carrier	Steering Dampers\ Steering Stabilizer\ Cab Shock	Fleetline\ Gas SLX	Classic\ Ultra\ ProGuard\ Guardian	Max Control\ LTV Severe Duty\ Load Carrier\ HiJackers	Steering Dampers\ Steering Stabilizer\ Cab Shock

HOLIDAY RAMBLER

HOLIDAY RAMBLER

AUGUSTA LX

16	MotorHomes with Ford E450 Chassis	ASH1154 8C2418045DA 8C2Z-18124-D 8C2Z18124D 8C24-18045-DA ASH-1154 AT163G AT-163G	 O		G63622	58622 77614				
		8C24-18080-DB 8C2Z18125D ASH-1136 8C2Z-18125-D AT164G 8C2418080DB ASH1136 AT-164G	 O					G63623	58623 77623	

AUGUSTA SPORT

07-10	MotorHomes with Ford E350 Chassis	ASH1154 8C2418045DA 8C2Z-18124-D 8C2Z18124D 8C24-18045-DA ASH-1154 AT163G AT-163G	 O		G63622	58622 77614				
		8C24-18080-DB 8C2Z18125D ASH-1136 8C2Z-18125-D AT164G 8C2418080DB ASH1136 AT-164G	 O					G63623	58623 77623	





AUGUSTA TOURING SEDAN

07-09	MotorHomes with Ford E350 Chassis	ASH1154 8C2418045DA 8C2Z-18124-D 8C2Z18124D 8C24-18045-DA ASH-1154 AT163G AT-163G	 O		G63622	58622 77614				
		8C24-18080-DB 8C2Z18125D ASH-1136 8C2Z-18125-D AT164G 8C2418080DB ASH1136 AT-164G	 O					G63623	58623 77623	

CLASS A MOTORHOMES

98-11	Models with Workhorse W20 , W22, & W24 MotorHome Chassis with O.E.M. Number	24-153249 F4-BE5-B492-HO W0005662 W0006254 24153249 24-186629 F4-BE5-A832-MO F4BE5A832MO F4BE5F324HO F4-BE5-F324-HO 24186629 F4BE5B492HO	 O	85125							
		W0005663 F4-BE5-F325-HO 24153256 24-153256	 T					85124			
04-10	Models with Workhorse W20 , W22, & W24 MotorHome Chassis with O.E.M. Number	W0005663 F4BE5F325HO F4-BE5-F325-HO 24153256 24-153256	 T					85124			
00-03	Models with Roadmaster Chassis RM4C or used on Ambassador	01809924	 O	83144							

APPLICATION GUIDE

Year	Fitment Notes	OEM#								
			 Fleetline\ Gas SLX	Classic\ Ultra\ ProGuard\ Guardian	Max Control\ LTV Severe Duty\ Load Carrier	Steering Dampers\ Steering Stabilizer\ Cab Shock	 Fleetline\ Gas SLX	Classic\ Ultra\ ProGuard\ Guardian	Max Control\ LTV Severe Duty\ Load Carrier\ HiJackers	Steering Dampers\ Steering Stabilizer\ Cab Shock

HOLIDAY RAMBLER

HOLIDAY RAMBLER



CLASS A MOTORHOMES (cont)

00-03	Models with Roadmaster Chassis RM4C or used on Ambassador	01809923										
95-99	MotorHomes with Freightliner XC Chassis (22,000 to 26,000 lb GVW)	OO	83160	OO	85029

ENDEAVOR

16-24	MotorHomes with Ford F53 Chassis with 16,000 lb GVW to 22,000 lb GVW	ASH-1229 ASH-1228 9U94-18045-AA ASH-1205 AT-620 ASH25823 ASH-1022 ASH1022 1C3418045JA ASH-25822 ASH1205 ASH-25823 ASH1228 ASH1229 AT620 1C34-18045-JA AT766 9U9Z18124A ASH294 1C3418045AA 1C34-18045-AA ASH-294 9U9418045AA 9U9Z-18124-A ASH25822 AT-766										
		OO	83209	OO	85029
		OO	OO	83122 89406
15	MotorHomes with Ford F53 Chassis with 16,000 lb GVW to 22,000 lb GVW	ASH-1229 ASH-1228 9U94-18045-AA ASH-1205 AT-620 ASH25823 ASH-1022 ASH1022 1C3418045JA ASH-25822 ASH1205 ASH-25823 ASH1228 ASH1229 AT620 1C34-18045-JA AT766 9U9Z18124A ASH294 1C3418045AA 1C34-18045-AA ASH-294 9U9418045AA 9U9Z-18124-A ASH25822 AT-766										
		OO	83209	OO	85029

APPLICATION GUIDE

Year	Fitment Notes	OEM#								
			Fleetline\ Gas SLX	Classic\ Ultra\ ProGuard\ Guardian	Max Control\ LTV Severe Duty\ Load Carrier	Steering Dampers\ Steering Stabilizer\ Cab Shock	Fleetline\ Gas SLX	Classic\ Ultra\ ProGuard\ Guardian	Max Control\ LTV Severe Duty\ Load Carrier\ HiJackers	Steering Dampers\ Steering Stabilizer\ Cab Shock

HOLIDAY RAMBLER

HOLIDAY RAMBLER





ENDEAVOR (cont)

15	MotorHomes with Ford F53 Chassis with 16,000 lb GVW to 22,000 lb GVW	9U9Z18125A ASH-1206 ASH137 AT-621 ASH-25824 ASH-1023 ASH25824 ASH-1230 9U9418080AA ASH1230 ASH1023 9U94-18080-AA 9U9Z-18125-A AT621 ASH1206 ASH-137	83122 89406
			O/O				O/O			
00-14	MotorHomes with Ford F53 Chassis with 16,000 lb GVW to 22,000 lb GVW	ASH-1229 ASH-1228 9U94-18045-AA ASH-1205 AT-620 ASH25823 ASH-1022 ASH1022 1C3418045JA ASH-25822 ASH1205 ASH-25823 ASH1228 ASH1229 AT620 1C34-18045-JA AT766 9U9Z18124A ASH294 1C3418045AA 1C34-18045-AA ASH-294 9U9418045AA 9U9Z-18124-A ASH25822 AT-766	83209
			O/O				O/O			
		9U9Z18125A ASH-1206 ASH137 AT-621 ASH-25824 ASH-1023 ASH25824 ASH-1230 9U9418080AA ASH1230 ASH1023 9U94-18080-AA 9U9Z-18125-A AT621 ASH1206 ASH-137	83122 89406
			O/O				O/O			
00-03	Models with Workhorse W22 Chassis with 8.1L Gas V8	01809925	85010
			O/O				O/O			

INVICTA

20-24	MotorHomes with Ford F53 Chassis with 24,000 lb GVW to 26,000 lb GVW	ASH1161 ASH25821 ASH-25821 ASH-1161	85006
			O/O				O/O			
20-23	MotorHomes with Ford F53 Chassis with 24,000 lb GVW to 26,000 lb GVW	ASH25820 ASH1162 ASH-25820 ASH-1162	85005 89430
			O/O				O/O			

APPLICATION GUIDE



Year	Fitment Notes	OEM#								
			 Fleetline\ Gas SLX	Classic\ Ultra\ ProGuard\ Guardian	Max Control\ LTV Severe Duty\ Load Carrier	Steering Dampers\ Steering Stabilizer\ Cab Shock	 Fleetline\ Gas SLX	Classic\ Ultra\ ProGuard\ Guardian	Max Control\ LTV Severe Duty\ Load Carrier\ HiJackers	Steering Dampers\ Steering Stabilizer\ Cab Shock

HOLIDAY RAMBLER VACATIONER

HOLIDAY RAMBLER

11-24	MotorHomes with Ford F53 Chassis with 16,000 lb GVW to 22,000 lb GVW	ASH-1229 ASH-1228 9U94-18045-AA ASH-1205 AT-620 ASH25823 ASH-1022 ASH1022 1C3418045JA ASH-25822 ASH1205 ASH-25823 ASH1228 ASH1229 AT620 1C34-18045-JA AT766 9U9Z18124A ASH294 1C3418045AA 1C34-18045-AA ASH-294 9U9418045AA 9U9Z-18124-A ASH25822 AT-766	83209	
		OO	
	MotorHomes with Ford F53 Chassis with 24,000 lb GVW to 26,000 lb GVW	9U9Z18125A ASH-1206 ASH137 AT-621 ASH-25824 ASH-1023 ASH25824 ASH-1230 9U9418080AA ASH1230 ASH1023 9U94-18080-AA 9U9Z-18125-A AT621 ASH1206 ASH-137	OO	83122 89406
OO	85006	
11-23	MotorHomes with Ford F53 Chassis with 24,000 lb GVW to 26,000 lb GVW	ASH25820 ASH1162 ASH-25820 ASH-1162	85005 89430
OO	85005 89430	
10	MotorHomes with Ford F53 Chassis with 16,000 lb GVW to 22,000 lb GVW	ASH-1229 ASH-1228 9U94-18045-AA ASH-1205 AT-620 ASH25823 ASH-1022 ASH1022 1C3418045JA ASH-25822 ASH1205 ASH-25823 ASH1228 ASH1229 AT620 1C34-18045-JA AT766 9U9Z18124A ASH294 1C3418045AA 1C34-18045-AA ASH-294 9U9418045AA 9U9Z-18124-A ASH25822 AT-766	OO	83209

APPLICATION GUIDE

Year	Fitment Notes	OEM#								
			Fleetline\ Gas SLX	Classic\ Ultra\ ProGuard\ Guardian	Max Control\ LTV Severe Duty\ Load Carrier	Steering Dampers\ Steering Stabilizer\ Cab Shock	Fleetline\ Gas SLX	Classic\ Ultra\ ProGuard\ Guardian	Max Control\ LTV Severe Duty\ Load Carrier\ HiJackers	Steering Dampers\ Steering Stabilizer\ Cab Shock





HOLIDAY RAMBLER

HOLIDAY RAMBLER

VACATIONER (cont)

10	MotorHomes with Ford F53 Chassis with 16,000 lb GVW to 22,000 lb GVW	9U9Z18125A ASH-1206 ASH137 AT-621 ASH-25824 ASH-1023 ASH25824 ASH-1230 9U9418080AA ASH1230 ASH1023 9U94-18080-AA 9U9Z-18125-A AT621 ASH1206 ASH-137	83122 89406
			O/O				O/O			
09	MotorHomes with Ford F53 Chassis with 16,000 lb GVW to 22,000 lb GVW	ASH-1229 ASH-1228 9U94-18045-AA ASH-1205 AT-620 ASH25823 ASH-1022 ASH1022 1C3418045JA ASH-25822 ASH1205 ASH-25823 ASH1228 ASH1229 AT620 1C34-18045-JA AT766 9U9Z18124A ASH294 1C3418045AA 1C34-18045-AA ASH-294 9U9418045AA 9U9Z-18124-A ASH25822 AT-766	83209
			O/O				O/O			
		9U9Z18125A ASH-1206 ASH137 AT-621 ASH-25824 ASH-1023 ASH25824 ASH-1230 9U9418080AA ASH1230 ASH1023 9U94-18080-AA 9U9Z-18125-A AT621 ASH1206 ASH-137	83122 89406
			O/O				O/O			
	MotorHomes with Ford F53 Chassis with 24,000 lb GVW to 26,000 lb GVW	ASH1161 ASH25821 ASH-25821 ASH-1161	85006
		ASH25820 ASH1162 ASH-25820 ASH-1162	85005 89430
			O/O				O/O			

APPLICATION GUIDE

Year	Fitment Notes	OEM#								
			 Fleetline\ Gas SLX	Classic\ Ultra\ ProGuard\ Guardian	Max Control\ LTV Severe Duty\ Load Carrier	Steering Dampers\ Steering Stabilizer\ Cab Shock	 Fleetline\ Gas SLX	Classic\ Ultra\ ProGuard\ Guardian	Max Control\ LTV Severe Duty\ Load Carrier\ HiJackers	Steering Dampers\ Steering Stabilizer\ Cab Shock



HOLIDAY RAMBLER

HOLIDAY RAMBLER

VACATIONER (cont)

08	MotorHomes with Ford F53 Chassis with 16,000 lb GVW to 22,000 lb GVW	ASH-1229 ASH-1228 9U94-18045-AA ASH-1205 AT-620 ASH25823 ASH-1022 ASH1022 1C3418045JA ASH-25822 ASH1205 ASH-25823 ASH1228 ASH1229 AT620 1C34-18045-JA AT766 9U9Z18124A ASH294 1C3418045AA 1C34-18045-AA ASH-294 9U9418045AA 9U9Z-18124-A ASH25822 AT-766	83209
		OO			83122 89406
00-07	MotorHomes with Ford F53 Chassis with 16,000 lb GVW to 22,000 lb GVW	ASH-1229 ASH-1228 9U94-18045-AA ASH-1205 AT-620 ASH25823 ASH-1022 ASH1022 1C3418045JA ASH-25822 ASH1205 ASH-25823 ASH1228 ASH1229 AT620 1C34-18045-JA AT766 9U9Z18124A ASH294 1C3418045AA 1C34-18045-AA ASH-294 9U9418045AA 9U9Z-18124-A ASH25822 AT-766	83209
		OO			83122 89406

APPLICATION GUIDE

Year	Fitment Notes	OEM#								
			Fleetline\ Gas SLX	Classic\ Ultra\ ProGuard\ Guardian	Max Control\ LTV Severe Duty\ Load Carrier	Steering Dampers\ Steering Stabilizer\ Cab Shock	Fleetline\ Gas SLX	Classic\ Ultra\ ProGuard\ Guardian	Max Control\ LTV Severe Duty\ Load Carrier\ HiJackers	Steering Dampers\ Steering Stabilizer\ Cab Shock

HOLIDAY RAMBLER

HOLIDAY RAMBLER

VACATIONER (cont)

00-03	Models with Workhorse W22 Chassis with 8.1L Gas V8	01809925	O O	85010				
-------	--	----------	--------	-------	------	------	------	--	--	--	--

VARIOUS

	Models with Mor-Ryde Suspension	U0109007 U0109-007		O O		G63183
	Models with Neway Trailer Air Suspension	90044794		O O		83127

VESTA

17-18	MotorHomes with Ford E450 Chassis	ASH1154 8C2418045DA 8C2Z-18124-D 8C2Z18124D 8C24-18045-DA ASH-1154 AT163G AT-163G	I O	G63622	58622 77614					
		8C24-18080-DB 8C2Z18125D ASH-1136 8C2Z-18125-D AT164G 8C2418080DB ASH1136 AT-164G	O I			G63623	58623 77623

IC CORPORATION

IC CORPORATION

BE SCHOOL BUS

08-15	School Buses with 7,000 lb Front Axles	3605735C1 3605735C2	O O	83169					
	School Buses with O.E.M. Number	3609400C1 3609400C2		I O		83317



CE SCHOOL BUS

10-23	CE Model School Buses (71 Capacity) with 9,000 to 10,000 lb Front Suspension	6127088C1 OE13402S 3578105C2 3578105C1	O O	83163					
	CE Model School Buses with 20,000 lb International IROS Air Suspension	6127713C2 3578858C2 6127713C1		O O		85656
13-18	CE Model School Buses with 6,000 to 8,000 lb Front Axles	3533356C3	O O	83169					
16-17	CE Model School Buses with 20,000 lb Rear Air Suspension	3601600C3		O O		85082
10-13	CE Model School Buses with 22,000 lb Rear Spring Suspension	501906C91 501906C92 OE13424S	O I			83317

RE SCHOOL BUS

03-18	RE Model School Buses (Low Profile)	537524C91		O O		83123 89405
	RE Model School Buses with 12,000 to 14,000 lb Front Axles	2200327C1	I O	85332					
	RE Model School Buses with O.E.M number	3604282C1	I O	85351					
	RE Model School Buses with O.E.M. Number	472412C91	I T	83456					

APPLICATION GUIDE

Year	Fitment Notes	OEM#								
			Fleetline\ Gas SLX	Classic\ Ultra\ ProGuard\ Guardian	Max Control\ LTV Severe Duty\ Load Carrier	Steering Dampers\ Steering Stabilizer\ Cab Shock	Fleetline\ Gas SLX	Classic\ Ultra\ ProGuard\ Guardian	Max Control\ LTV Severe Duty\ Load Carrier\ HiJackers	Steering Dampers\ Steering Stabilizer\ Cab Shock

INTERNATIONAL

INTERNATIONAL

200

74-75	Steering Stabilizer										6802SE ⁸⁴
-------	---------------------	--	--	--	--	--	--	--	--	--	----------------------

1200C

68	Exc. 166" Wheelbase		61500					61500	43048 ⁸		
			81147					81147	49310 ⁷		
			82007					G63405			
			G63405								
	Single System Steering Stabilizer; 1/2 Ton, 3/4 Ton & Travelall										6802SE ⁸⁴

1200D

69-70	Single System Steering Stabilizer; 1/2 Ton, 3/4 Ton & Travelall										6802SE ⁸⁴
-------	---	--	--	--	--	--	--	--	--	--	----------------------

1210

71-73	Single System Steering Stabilizer; 1/2 Ton, 3/4 Ton & Travelall										6802SE ⁸⁴
-------	---	--	--	--	--	--	--	--	--	--	----------------------

1300C

68	Exc. 166" Wheelbase		61500					61500	43048 ⁸		
			81147					81147	49310 ⁷		
			82007					G63405			
			G63405								
	Single System Steering Stabilizer; 1/2 Ton, 3/4 Ton & Travelall										6802SE ⁸⁴

1300D

69-70	Single System Steering Stabilizer; 1/2 Ton, 3/4 Ton & Travelall										6802SE ⁸⁴
-------	---	--	--	--	--	--	--	--	--	--	----------------------

1310

71-73	Single System Steering Stabilizer; 1/2 Ton, 3/4 Ton & Travelall										6802SE ⁸⁴
-------	---	--	--	--	--	--	--	--	--	--	----------------------

4300





02-20	Models with 6,000 to 8,000 lb Front Suspension	3533356C1 3533356C2	83135								
	Models with Hendrickson HAS - 230 or 460 Rear Air Suspension	60675-003 H60675-003 57905001 3514952C1 60675-003L 57905-001 60675003L 60675003 H60675003						85976			
	Models with O.E.M. Number	2509223C92 2509223C91 2509221C91					83054				
02-15	Models with 12,000 lb Front axle	3533357C1 3533357C2 3533357C3	85957								
02-13	Models with 22,000 lb Rear Spring Suspension	501906C91 501906C92 OE13424S						83317			
08-09	Models with 9,000 to 10,000 lb Front Suspension	6127088C1 3578105C2	83163								

7 Pair Packs, Air hose kit included.;

8 Pair Packs.;

84 Replacement damper for vehicles with the Gabriel Aftermarket mounting kit;

APPLICATION GUIDE

Year	Fitment Notes	OEM#								
			 Fleetline\ Gas SLX	Classic\ Ultra\ ProGuard\ Guardian	Max Control\ LTV Severe Duty\ Load Carrier	Steering Dampers\ Steering Stabilizer\ Cab Shock	 Fleetline\ Gas SLX	Classic\ Ultra\ ProGuard\ Guardian	Max Control\ LTV Severe Duty\ Load Carrier\ Hijackers	Steering Dampers\ Steering Stabilizer\ Cab Shock



INTERNATIONAL

INTERNATIONAL







4300 (cont)

08-09	Models with International 40,000 lb Rear Air Suspension	3549099C2				85923 89458
-------	---	-----------	--	------	------	------	------	--	--	----------------	------	------	------

4300LP

02-19	Models with O.E.M. Number	2509223C92 2509223C91 2509221C91		83054		
13	Models with O.E.M. Number	1660846C92		83101

4400

02-20	Models with 6,000 to 8,000 lb Front Suspension	3533356C1 3533356C2		83135
	Models with Hendrickson HAS - 230 or 460 Rear Air Suspension	60675-003 H60675-003 57905001 3514952C1 60675-003L 57905-001 60675003L 60675003 H60675003				85976
	Models with O.E.M. Number	2509223C92 2509223C91 2509221C91		83054		
02-15	Models with 12,000 lb Front axle	3533357C1 3533357C2 3533357C3		85957
02-13	Models with 22,000 lb Rear Spring Suspension	501906C91 501906C92 OE13424S				83317
08-09	Models with 9,000 to 10,000 lb Front Suspension	6127088C1 3578105C2		83163
	Models with International 40,000 lb Rear Air Suspension	3549099C2				85923 89458





4400LP

02-19	Models with O.E.M. Number	2509223C92 2509223C91 2509221C91		83054		
-------	---------------------------	--	---	------	------	------	-------	--	--	------	------	------	------





5000 SERIES

96-16	Paystar - SFA Conventionals with Link Cabmate Model NP50 & NP50-A built after August of 1996	12011044 12021044 1201-1044 1202-1044		83025
94-16	Paystar - SBA Conventionals with Link Cabmate Model NP50 & NP50-A built after August of 1994	12011044 12021044 1201-1044 1202-1044		83025

CV515

24	Models with 11K, 13.5K or 15.5K VARI-RATE Rear Suspension	4208946C1 4206863C1				83398
	Models with Taperleaf Front	4109582C1 4089293C1 4109583C1 4207304C1		83397
19-23	Models with 11K, 13.5K or 15.5K VARI-RATE Rear Suspension	4208946C1 4206863C1				83398
	Models with 4 x 4 Rear	4109458C2				83243

APPLICATION GUIDE

Year	Fitment Notes	OEM#								
			 Fleetline/ Gas SLX	Classic/ Ultra/ ProGuard/ Guardian	Max Control/ LTV Severe Duty/ Load Carrier	Steering Dampers/ Steering Stabilizer/ Cab Shock	 Fleetline/ Gas SLX	Classic/ Ultra/ ProGuard/ Guardian	Max Control/ LTV Severe Duty/ Load Carrier/ HiJackers	Steering Dampers/ Steering Stabilizer/ Cab Shock

INTERNATIONAL

CV515 (cont)

19-23	Models with IROS Rear	4214011C2	OO	85670
	Models with Taperleaf Front	4109582C1 4089293C1 4109583C1 4207304C1	OO	83397	OO

INTERNATIONAL

CXT SERIES

CXT Models with 9,000 to 10,000 lb Front Suspension	3606770C2 3606770C1	OO	83163	OO
---	------------------------	----	-------	------	------	------	----	------	------	------	------

DURASTAR

16-20	Models with 10,500 or 13,500 lb Vari-Rate Rear Spring Suspension	6127087C1 3586902C2 3586902C3	OO	OO	83364
	Models with 11,000 lb to 14,000 lb Front axle	6127714C1	OO	85928	OO
15-20	Models with 6,000 to 8,000 lb Front Suspension	6127688C1 3533356C3	OO	83169	OO
	Models with Hendrickson HAS - 230 or 460 Rear Air Suspension	60675-003 H60675-003 57905001 3514952C1 60675-003L 57905-001 60675003L 60675003 H60675003	OO	OO	85976
	Models with O.E.M. Number	2509223C92 2509223C91 2509221C91	OO	83054	OO
16-19	Models with 20,000 lb International IROS Air Suspension	6127713C1	OO	OO	85656
15-19	Models with 9,000 to 10,000 lb Front Suspension	6127088C1 OE13402S 3578105C2 3578105C1	OO	83163	OO
16-17	Models with Vari-Rate Rear Spring Suspension	6127700C1	OO	OO	83395
15	Models with 12,000 lb Front axle	3533357C1 3533357C2 3533357C3	OO	85957	OO
13	Models with 12,000 lb Front axle	3533357C1 3533357C2 3533357C3	OO	85957	OO
	Models with 22,000 lb Rear Spring Suspension	501906C91 501906C92 OE13424S	OO	OO	83317
	Models with 6,000 to 8,000 lb Front Suspension	6127688C1 3533356C3	OO	83169	OO
	Models with 9,000 to 10,000 lb Front Suspension	6127088C1 OE13402S 3578105C2 3578105C1	OO	83163	OO
	Models with Hendrickson HAS - 230 or 460 Rear Air Suspension	60675-003 H60675-003 57905001 3514952C1 60675-003L 57905-001 60675003L 60675003 H60675003	OO	OO	85976
	Models with O.E.M. Number	2509223C92 2509223C91 2509221C91	OO	83054	OO

APPLICATION GUIDE

Year	Fitment Notes	OEM#								
				Fleetline\ Gas SLX	Classic\ Ultra\ ProGuard\ Guardian	Max Control\ LTV Severe Duty\ Load Carrier	Steering Dampers\ Steering Stabilizer\ Cab Shock		Fleetline\ Gas SLX	Classic\ Ultra\ ProGuard\ Guardian

INTERNATIONAL

INTERNATIONAL

DURASTAR - 1000 SERIES

	1300 Models	56110T8129 66400 56110-T8123 56110-T8129 56110T8123			G63432						
--	-------------	---	--	--	--------	--	--	--	--	--	--

DURASTAR - 4300, 4400 SERIES

	Models with 20,000 lb International IROS Air Suspension	3578858C1 3578858C2			G63432				85656		
	Models with International IROS Air Suspension	3553628C1 3553628C2 3553628C3 3553628C4							85927		
	Models with O.E.M. Number	6127690C1							85923 89458		
16-20	Models with 11,000 lb to 14,000 lb Front axle	6127714C1		85928							
16-19	Models with 20,000 lb International IROS Air Suspension	6127713C1							85656		
13-18	Models with 6,000 to 8,000 lb Front Suspension	6127688C1 3533356C3		83169							
10-15	Models with 12,000 lb Front axle	3533357C1 3533357C2 3533357C3		85957							
10-12	Models with 6,000 to 8,000 lb Front Suspension	3533356C1 3533356C2		83135							
	School Bus models with 6,000 to 8,000 lb Front Suspension	3533356C1 3533356C2		83135							
10-11	Models with 40,000 lb Rear Air Suspension	3549099C2							85923 89458		





EMV607

23	Models with 12,000 lb Parabolic Taper Leaf Springs	6127714C1		85928							
----	--	-----------	--	-------	--	--	--	--	--	--	--

HV607

19-23	Models with 11,000 lb to 14,000 lb Taper-leaf Springs	6127714C1		85928							
	Models with Hendrickson Primaax 230/460 Air Suspension with 9" Ride Height	60657-003 60657003 60657003L 3626571C2 H60657003 60657-003L							85072		
	Models with O.E.M. Number	12019008 1201-9008 2509223C92 2509223C91					83054				
19-22	Models with Hendrickson HMX 400/460 Haulmax with 16.5" Saddle	60680-004L 60680-004 60680004 60680004L							83143		
	Models with Hendrickson HMX 400/460 Haulmax with 17.5" & 18.5" Saddle	60680-005L 60680005L 60680005 HDR60680-005 HDR60680005 60680-005							83142		
19-21	Models with 18,000 to 20,000 lb (Set Forward) Front Axle	3868265C1		85995							
19-20	Models with 16,000 lb to 23,000 lb Parabolic Taperleaf Springs	3576464C2		85957							

APPLICATION GUIDE

Year	Fitment Notes	OEM#								
			 Fleetline\ Gas SLX	Classic\ Ultra\ ProGuard\ Guardian	Max Control\ LTV Severe Duty\ Load Carrier	Steering Dampers\ Steering Stabilizer\ Cab Shock	 Fleetline\ Gas SLX	Classic\ Ultra\ ProGuard\ Guardian	Max Control\ LTV Severe Duty\ Load Carrier\ HiJackers	Steering Dampers\ Steering Stabilizer\ Cab Shock

INTERNATIONAL

M1100 / M1200

68-72	All		O	O	82007	O	O	6802SE ⁸⁴	61500 81147 G63405	43048 ⁸ 49310 ⁷
	Single System Steering Stabilizer; 1/2 & 3/4 Ton with I-Beam Axle		O	O									

INTERNATIONAL

M1400

69	All		O	O	82007	O	O	6802SE ⁸⁴	61500 81147 G63405	43048 ⁸ 49310 ⁷
	Single System Steering Stabilizer; 1/2 & 3/4 Ton with I-Beam Axle		O	O									

MV SERIES

19-22	MV607 Models with 11,000 lb to 14,000 lb Front axle	6127714C1	O	O	85928	O	O	
	19	MV607 Models with 20,000 lb International IROS Air Suspension	6127713C1	O	O	O	O	85656
		MV607 Models with 40,000 lb Rear Air Suspension	3549099C3	O	O	O	O	85923 89458
		MV607 Models with 8,000 lb Front Suspension	3533356C3	O	O	83169	O	O

MV607

20-22	Models with 20,000 lb International IROS Air Suspension	6127713C2	O	O	O	O	85656
	19-22	Models with 9,000 to 10,000 lb Front Suspension	6127088C1	O	O	83163	O	O
	Models with Hendrickson HAS - 230 or 460 Rear Air Suspension	60675-003 H60675-003 3514952C1 60675-003L 60675003L 60675003 H60675003	O	O	O	O	85976

TERRASTAR

12-18	Models with 6,000 to 7,000 lb Front Axle	3989717C1 3991991C1 OE 18513 3902993C1 3902993C3 OE17103	O	O	83135	O	O
	12-17	Models with 10,000 & 13,500 lb Vari- Rate Rear Spring Suspension	3586902C2	O	O	O	O	83364
	Models with 10,500 or 13,500 lb Vari- Rate Rear Spring Suspension	6127087C1 3586902C3	O	O	O	O	83364
14	4 WD Models with Rear Spring Suspension	6127096C1 3945165C1	O	O	O	O	83180

TRAVELALL



75	Single System Steering Stabilizer		O	O	6803SE ⁸⁴								
	Steering Stabilizer		O	O	6802SE ⁸⁴								

7 Pair Packs, Air hose kit included.;

8 Pair Packs.;

84 Replacement damper for vehicles with the Gabriel Aftermarket mounting kit;

APPLICATION GUIDE

Year	Fitment Notes	OEM#								
			Fleetline\ Gas SLX	Classic\ Ultra\ ProGuard\ Guardian	Max Control\ LTV Severe Duty\ Load Carrier	Steering Dampers\ Steering Stabilizer\ Cab Shock	Fleetline\ Gas SLX	Classic\ Ultra\ ProGuard\ Guardian	Max Control\ LTV Severe Duty\ Load Carrier\ HiJackers	Steering Dampers\ Steering Stabilizer\ Cab Shock

ISUZU

ISUZU

ADDITIONAL APPLICATIONS

85	KS22 Models (All)	8-97083-027-0	 ○	83515
		9-51630-666-2 9516306660 9-51630-666-0 9516306662	 ○	85012 89413

ALL MODELS WITH

Models with O.E.M. Number	8-97253-623-0 8972019600 8972536160 8-97253-621-0 8-97253-616-0 898098-1250 8980981270 898098-1270 8972536210 8972536230 8980981250	 ○	83515
---------------------------	---	-------	-------	------	------	------	------	------	------	------	------

FRR

00-03	All	1-51630-219-1 1-51630-219-0 51630219	 ○	83114
99	Models with O.E.M. Number	1-51630-219-1 1-51630-219-0 51630219	 ○	83114
95-98	All	1-51630-219-1 1-51630-219-0 51630219	 ○	83114





FSR

97-02	Models with 15000, 19000, 21000 lb Multileaf Springs	8-22064232-0 8220642320	 	85071
	Models with 19000, 21000, 23000 lb Taperleaf Springs (EXC Low Profile Veh.)	8220642330 8-22064233-0	 	83136
	Models with FL1 Tilt Cab with 8100 lb Axle (Including Low Profile)	8-22064804-0 8-22064805-0 8220648050 8220648040	 	83136
87-96	FSR Models	1-51630-217-1	 ○	83114
		1-51630-167-0 1516301670	 	83613
87-92	FSR Models	1516301600 1-51630-160-0	 ○	83162
		1516301681 51630168 1-51630-168-1	 ○	83515
		1-51630-217-1	 ○	83114
86	Models with O.E.M. Number	1516301600 1-51630-160-0	 ○	83162
		1516301681 51630168 1-51630-168-1	 ○	83515
		1-51630-217-1	 ○	83114

FTR

18-22	Models with Hendrickson HAS suspension	8-97517-966-1 60670-005 60670005L 8975179661 8975179660 60670-005L 60670005 8-97517-966-0	 ○	83137
18-20	FTR Diesel Models with Std Cab	8-98321-912-1 8983219121	 	85071

APPLICATION GUIDE

Year	Fitment Notes	OEM#								
			 Fleetline/ Gas SLX	Classic/ Ultra/ ProGuard/ Guardian	Max Control/ LTV Severe Duty/ Load Carrier	Steering Dampers/ Steering Stabilizer/ Cab Shock	 Fleetline/ Gas SLX	Classic/ Ultra/ ProGuard/ Guardian	Max Control/ LTV Severe Duty/ Load Carrier/ HiJackers	Steering Dampers/ Steering Stabilizer/ Cab Shock

ISUZU

ISUZU



FTR (cont)

00-11	Models with Hendrickson HAS suspension	8-97517-966-1 60670-005 60670005L 8975179661 8975179660 60670-005L 60670005 8-97517-966-0	83137
05-09	Models with O.E.M. Number	98098127 8980981270 8982326720 8-98098-127-0	 O	83515
		98098059 8983162280 8-98098-059-0 8-98098-059-1 8-98316-228-0 8980980590 8980980591	83159
97-09	Models with 19000, 21000, 23000 lb Taperleaf Springs (EXC Low Profile Veh.)	8220642330 8-22064233-0	83136
	Models with O.E.M. Number	88982682 8220648070 8220648060 8-22064-806-0 8-22064-807-0 15123676	 T	83136
90-09	Models with 15000, 19000, 21000 lb Multileaf Springs	15174902 8-22064232-0 8220642320 88982686	85071
90-96	Models with O.E.M. Number	88982682	 T	83136
88-96	Models with O.E.M. Number	1-51630-167-0 1516301670	 T	83613

FVR

	Models with Hendrickson HAS suspension	12474915	83122 89406
00-11	Models with Hendrickson HAS suspension	8-97517-966-1 60670-005 60670005L 8975179661 8975179660 60670-005L 60670005 8-97517-966-0	83137
97-09	Models with 19000, 21000, 23000 lb Taperleaf Springs (EXC Low Profile Veh.)	8220642330 8-22064233-0	83136
	Models with O.E.M. Number	88982682 8220648070 15887728 8220648060 8-22064-806-0 8-22064-807-0 19152843	 T	83136
94-09	Models with 15000, 19000, 21000 lb Multileaf Springs	8-22064232-0 8220642320 88982686	85071
94-96	FVR Short & Middle Chassis	1516301600 1-51630-160-0	 O	83162
	Models with O.E.M. Number	1-51630-167-0 1516301670	 T	83613
90-92	Models with 15000, 19000, 21000 lb Multileaf Springs	8-22064232-0 8220642320 88982686	85071
88-92	FVR Short & Middle Chassis	1516301600 1-51630-160-0	 O	83162
	Models with O.E.M. Number	1-51630-167-0 1516301670	 T	83613

APPLICATION GUIDE

Year	Fitment Notes	OEM#								
			Fleetline\ Gas SLX	Classic\ Ultra\ ProGuard\ Guardian	Max Control\ LTV Severe Duty\ Load Carrier	Steering Dampers\ Steering Stabilizer\ Cab Shock	Fleetline\ Gas SLX	Classic\ Ultra\ ProGuard\ Guardian	Max Control\ LTV Severe Duty\ Load Carrier\ HiJackers	Steering Dampers\ Steering Stabilizer\ Cab Shock





ISUZU

ISUZU

NPR

19-23	Models with O.E.M. Number	8-97253-620-1 98098125 8-98381-012-0 97083029 94454987 98232671 8-98381-010-0 97083027 8-98232671-1 8-98232671-0 97253620 8-94454-647-1 8-97253-620-0 8-98098-125-0 8983810120 8-97083-027-0 8983810100 9-51630-647-1 8-97083-029-0 51630647 94454986 8-94454-986-0 8-94454-987-0 8982326710	83515	
19	Models with O.E.M Number	8-97253-665-0 898098-0581 8-98098-058-0 8-98098-058-1 8-98098-059-0 8-98098-059-1 8-98316227-0 8-98316-228-0	83159
95-18	Models with O.E.M. Number	98098059 8-97253-665-0 898098-0581 98098058 8-97253-651-2 8-97253-664-0 97253664 98316227 97253665 97253651 8-98098-058-0 8-98098-058-1 8-98098-059-0 8-98098-059-1 8-98316227-0 8-98316-228-0	83159
86-18	Models with O.E.M. Number	8-97253-620-1 98098125 8-98381-012-0 97083029 94454987 98232671 8-98381-010-0 97083027 8-98232671-1 8-98232671-0 97253620 8-94454-647-1 8-97253-620-0 8-98098-125-0 8983810120 8-97083-027-0 8983810100 9-51630-647-1 8-97083-029-0 51630647 94454986 8-94454-986-0 8-94454-987-0 8982326710	83515
86-95	All	9-51630-666-2 51630666 9516306660 9-51630-666-0 9516306662	85012 89413

APPLICATION GUIDE

Year	Fitment Notes	OEM#								
			 Fleetline\ Gas SLX	Classic\ Ultra\ ProGuard\ Guardian	Max Control\ LTV Severe Duty\ Load Carrier	Steering Dampers\ Steering Stabilizer\ Cab Shock	 Fleetline\ Gas SLX	Classic\ Ultra\ ProGuard\ Guardian	Max Control\ LTV Severe Duty\ Load Carrier\ HiJackers	Steering Dampers\ Steering Stabilizer\ Cab Shock

ISUZU

ISUZU

NPR (cont)

84-85	Models with O.E.M. Number	8-97253-620-1 98098125 8-98381-012-0 97083029 94454987 98232671 8-98381-010-0 97083027 8-98232671-1 8-98232671-0 97253620 8-94454-647-1 8-97253-620-0 8-98098-125-0 8983810120 8-97083-027-0 8983810100 9-51630-647-1 8-97083-029-0 51630647 94454986 8-94454-986-0 8-94454-987-0 8982326710	83515				
-------	---------------------------	---	-------	------	------	------	------	--	--	--	--



NPR-HD

20-23	Models with 14,000 to 15,000 lb Rear	8983807460 8-98380-746-0					
	Models with 15,000 to 16,000 lb Rear	8983807470 8-98380-747-0					
99-23	Models with O.E.M. Number	8-97253-620-1 98098125 8-98381-012-0 97083029 94454987 98232671 8-98381-010-0 97083027 8-98232671-1 8-98232671-0 97253620 8-94454-647-1 8-97253-620-0 8-98098-125-0 8983810120 8-97083-027-0 8983810100 9-51630-647-1 8-97083-029-0 51630647 94454986 8-94454-986-0 8-94454-987-0 8982326710	83515				
18-19	Models with O.E.M. Number	8-97253-665-0 898098-0581 8-98098-058-0 8-98098-058-1 8-98098-059-0 8-98098-059-1 8-98316227-0 8-98316-228-0					
03-17	Models with O.E.M. Number	98098059 8-97253-665-0 898098-0581 98098058 8-98098-058-0 8-98098-058-1 8-98098-059-0 8-98098-059-1 8-98316227-0 8-98316-228-0 98316227 97253665					

NPR-XD

23	Models with 14,000 to 15,000 lb GVW	8983810100 8-98381-010-0	83515				
		8983807460 8-98380-746-0					
	Models with 15,000 to 16,000 lb GVW	8983810120 8-98381-012-0	83515				

APPLICATION GUIDE

Year	Fitment Notes	OEM#								
			Fleetline\ Gas SLX	Classic\ Ultra\ ProGuard\ Guardian	Max Control\ LTV Severe Duty\ Load Carrier	Steering Dampers\ Steering Stabilizer\ Cab Shock	Fleetline\ Gas SLX	Classic\ Ultra\ ProGuard\ Guardian	Max Control\ LTV Severe Duty\ Load Carrier\ HiJackers	Steering Dampers\ Steering Stabilizer\ Cab Shock

ISUZU

ISUZU

NPR-XD (cont)

23	Models with 15,000 to 16,000 lb GVW	8983807470 8-98380-747-0	○	83159
15-22	Models with 14,000 to 15,000 lb GVW	8983810100 8-98381-010-0	 ○	83515	○	83159
		8983807460 8-98380-746-0										
	Models with 15,000 to 16,000 lb GVW	8983810120 8-98381-012-0	 ○	83515	○	83159
		8983807470 8-98380-747-0										



NQR

20-23	Models with 15,000 to 16,000 lb Rear	8983807470 8-98380-747-0	○	83159
94-23	Models with O.E.M. Number	8-97253-620-1	 ○	83515	○	83159
		98098125										
		8-98381-012-0										
		97083029										
		94454987										
		98232671										
		8-98381-010-0										
		97083027										
		8-98232671-1										
		8-98232671-0										
		97253620										
		8-94454-647-1										
		8-97253-620-0										
		8-98098-125-0										
		8983810120										
		8-97083-027-0										
8983810100												
9-51630-647-1												
8-97083-029-0												
51630647												
94454986												
8-94454-986-0												
8-94454-987-0												
8982326710												
03-19	Models with O.E.M. Number	98098059	○	83159
		8-97253-665-0										
		8-98098-059-0										
		8-98098-059-1										
		8-98343986-0										
8-98316-228-0												
97253665												
98343986												
02	Diesel	8-97253-664-0 97253664	○	83159
95-97	Diesel	8-97253-664-0 97253664	○	83159

NRR

20-23	Models with 15,000 to 16,000 lb Rear	8983807470 8-98380-747-0	○	83159
05-23	Models with O.E.M. Number	8-97253-620-1	 ○	83515	○	83159
		98098125										
		8-98381-012-0										
		97083029										
		94454987										
		98232671										
		8-98381-010-0										
		97083027										
		8-98232671-1										
		8-98232671-0										
		97253620										
		8-94454-647-1										
		8-97253-620-0										
		8-98098-125-0										
		8983810120										
		8-97083-027-0										
		8983810100										
		9-51630-647-1										
		8-97083-029-0										
		51630647										
		94454986										
		8-94454-986-0										
8-94454-987-0												
8982326710												

APPLICATION GUIDE

Year	Fitment Notes	OEM#								
			Fleetline\ Gas SLX	Classic\ Ultra\ ProGuard\ Guardian	Max Control\ LTV Severe Duty\ Load Carrier	Steering Dampers\ Steering Stabilizer\ Cab Shock	Fleetline\ Gas SLX	Classic\ Ultra\ ProGuard\ Guardian	Max Control\ LTV Severe Duty\ Load Carrier\ HiJackers	Steering Dampers\ Steering Stabilizer\ Cab Shock

ISUZU

ISUZU

NRR (cont)

05-19	Models with O.E.M. Number	98098059 8-97253-665-0 8-98098-059-0 8-98098-059-1 8-98343986-0 8-98316-228-0 97253665 98343986	O	83159
88-94	All	1-51630-219-1 1-51630-217-1 1-51630-217-0 51630217	O	83114
	Models with O.E.M. Number	8-97253-620-1 98098125 8-98381-012-0 97083029 94454987 98232671 8-98381-010-0 97083027 8-98232671-1 8-98232671-0 97253620 8-94454-647-1 8-97253-620-0 8-98098-125-0 8983810120 8-97083-027-0 8983810100 9-51630-647-1 8-97083-029-0 51630647 94454986 8-94454-986-0 8-94454-987-0 8982326710	O	83515

REACH

11-15	Models with O.E.M. Number	8983810100 8-98381-010-0	O	83515
		8983807460 8-98380-746-0	O	83159



ITASCA

ITASCA

CLASS A MOTORHOMES

	Models with Workhorse UFO Chassis with Hendrickson Softek Front Suspension	66153-002 66153002 F4-BE5-C832-MO F4BE5C832MO	O	83124
99-15	SunCruiser Series MotorHomes with Ford F53 Chassis with 16,000 lb GVW to 22,000 lb GVW	ASH-1229 ASH-1228 9U94-18045-AA ASH-1205 AT-620 ASH-1022 1C34-18045-AA ASH-294 9U9Z-18124-A ASH-25822 ASH-25823 1C34-18045-JA AT-766	O	83209
		9U9Z18125A ASH-1206 ASH137 AT-621 ASH-25824 ASH-1023 ASH25824 ASH-1230 9U9418080AA ASH1230 ASH1023 9U94-18080-AA 9U9Z-18125-A AT621 ASH1206 ASH-137	O	83122 89406

APPLICATION GUIDE

Year	Fitment Notes	OEM#								
			Fleetline\ Gas SLX	Classic\ Ultra\ ProGuard\ Guardian	Max Control\ LTV Severe Duty\ Load Carrier	Steering Dampers\ Ultra\ Steering Stabilizer\ Cab Shock	Fleetline\ Gas SLX	Classic\ Ultra\ ProGuard\ Guardian	Max Control\ LTV Severe Duty\ Load Carrier\ Hijackers	Steering Dampers\ Ultra\ Steering Stabilizer\ Cab Shock

ITASCA

ITASCA





CLASS A MOTORHOMES (cont)

05-11	SunCruiser Series MotorHomes with W20 , W22, & W24 Workhorse Chassis	F4BE5A832MO F4BE5F324HO 24186629 F4BE5B492HO	O O	85125
04-11	Sunova Models with W20 , W22, & W24 WorkHorse MotorHome Chassis	W0005663 F4BE5F325HO F4-BE5-F325-HO 24153256 24-153256	 	85124
98-11	Sunova Models with W20 , W22, & W24 WorkHorse MotorHome Chassis	24-153249 W0005662 W0006254 24153249 F4-BE5-A832-MO F4BE5A832MO F4BE5F324HO F4-BE5-F324-HO	O O	85125
04-06	Horizon Series MotorHomes with Freightliner XC Chassis	16-16874-000 1616874000 1616737000 16-16737-000 141700131810	O O	83160
		1618103000 16-18103-000 481700000493	 	85900
		1616873000 16-16873-000 141700131809 1616736000 16-16736-000	O O	85029
02-06	Meridian Series MotorHomes with Freightliner XC Chassis	16-16874-000 1616874000 1616737000 16-16737-000 141700131810	O O	83160
		1618103000 16-18103-000 481700000493	 	85900
		1616873000 16-16873-000 141700131809 1616736000 16-16736-000	O O	85029
06	Ellipse Series MotorHomes with Freightliner XC Chassis	16-16874-000 1616874000 1616737000 16-16737-000 141700131810	O O	83160
		1618103000 16-18103-000 481700000493	 	85900
		1616873000 16-16873-000 141700131809 1616736000 16-16736-000	O O	85029
03-04	SunCruiser Series MotorHomes with W20 , W22, & W24 Workhorse Chassis	24-153249 F4-BE5-B492-HO W0005662 W0006254 24-186629 F4-BE5-A832-MO F4BE5A832MO F4BE5F324HO F4-BE5-F324-HO 24186629 F4BE5B492HO	O O	85125	
98-02	SunCruiser Series MotorHomes with W20 , W22, & W24 Workhorse Chassis	F4BE5A832MO F4BE5F324HO 24186629 F4BE5B492HO	O O	85125

CLASS C MOTORHOMES

06-20	Cambria Series Motorhomes with Ford E450 Chassis	8C2Z-18124-D 8C24-18045-DA ASH-1154 AT-163G	 O	G63622	58622 77614
-------	--	--	-------	------	--------	----------------	------	------	------	------	------	------

APPLICATION GUIDE

Year	Fitment Notes	OEM#								
			 Fleetline\ Gas SLX	Classic\ Ultra\ ProGuard\ Guardian	Max Control\ LTV Severe Duty\ Load Carrier	Steering Dampers\ Steering Stabilizer\ Cab Shock	 Fleetline\ Gas SLX	Classic\ Ultra\ ProGuard\ Guardian	Max Control\ LTV Severe Duty\ Load Carrier\ HiJackers	Steering Dampers\ Steering Stabilizer\ Cab Shock

ITASCA

ITASCA

CLASS C MOTORHOMES (cont)

06-20	Cambria Series Motorhomes with Ford E450 Chassis	8C24-18080-DB ASH-1136 8C2Z-18125-D AT-164G	I O	I O	G63623	58623 77623
01-20	Spirit Series Motorhomes with Ford E450 Chassis	8C2Z-18124-D 8C24-18045-DA ASH-1154 AT-163G	I O	G63622	58622 77614	I O
		8C24-18080-DB ASH-1136 8C2Z-18125-D AT-164G	I O	I O	G63623	58623 77623
07-14	Impulse Series Motorhomes with Ford E450 Chassis	8C2Z-18124-D 8C24-18045-DA ASH-1154 AT-163G	I O	G63622	58622 77614	I O
		8C24-18080-DB ASH-1136 8C2Z-18125-D AT-164G	I O	I O	G63623	58623 77623

JAYCO

JAYCO

ALANTE

16-24	MotorHomes with Ford F53 Chassis with 16,000 lb GVW to 22,000 lb GVW	ASH-1229 ASH-1228 9U94-18045-AA ASH-1205 AT-620 ASH25823 ASH-1022 ASH1022 1C3418045JA ASH-25822 ASH1205 ASH-25823 ASH1228 ASH1229 AT620 1C34-18045-JA AT766 9U9Z18124A ASH294 1C3418045AA 1C34-18045-AA ASH-294 9U9418045AA 9U9Z-18124-A ASH25822 AT-766	O O	83209	O O
		9U9Z18125A ASH-1206 ASH137 AT-621 ASH-25824 ASH-1023 ASH25824 ASH-1230 9U9418080AA ASH1230 ASH1023 9U94-18080-AA 9U9Z-18125-A AT621 ASH1206 ASH-137	O O	O O	83122 89406

CLASS A MOTORHOMES

15-20	Alante Series MotorHomes with Ford F53 Chassis with 16,000 lb GVW to 22,000 lb GVW	ASH-1229 ASH-25822 ASH-25823	O O	89414	O O
		ASH-25824 ASH25824	O O	O O	89406
14-20	Precept Series MotorHomes with Ford F53 Chassis with 16,000 lb GVW to 22,000 lb GVW	ASH-1229 ASH-25822 ASH-25823	O O	89414	O O

APPLICATION GUIDE

Year	Fitment Notes	OEM#								
			 Fleetline\ Gas SLX	Classic\ Ultra\ ProGuard\ Guardian	Max Control\ LTV Severe Duty\ Load Carrier	Steering Dampers\ Steering Stabilizer\ Cab Shock	 Fleetline\ Gas SLX	Classic\ Ultra\ ProGuard\ Guardian	Max Control\ LTV Severe Duty\ Load Carrier\ Hijackers	Steering Dampers\ Steering Stabilizer\ Cab Shock

JAYCO

JAYCO

CLASS A MOTORHOMES (cont)

14-20	Precept Series MotorHomes with Ford F53 Chassis with 16,000 lb GVW to 22,000 lb GVW	ASH-25824 ASH25824	 89406
-------	---	-----------------------	------	------	------	------	-----------	------	------	------





ESCAPADE

04-06	MotorHomes with Ford E350 or E450 Chassis	ASH1154 8C2418045DA 8C2Z-18124-D 8C2Z18124D 8C24-18045-DA ASH-1154 AT163G AT-163G	 	G63622	58622 77614
		8C24-18080-DB 8C2Z18125D ASH-1136 8C2Z-18125-D AT164G 8C2418080DB ASH1136 AT-164G	 	G63623	58623 77623
03	MotorHomes with Ford E350 or E450 Chassis	8C2418045DA 8C2Z-18124-D 8C2Z18124D 8C24-18045-DA ASH-1154 AT163G AT-163G	 	G63622	58622 77614
		8C24-18080-DB 8C2Z18125D ASH-1136 8C2Z-18125-D 8C2418080DB ASH1136 AT-164G	 	G63623	58623 77623

GRANITE RIDGE

04-06	MotorHomes with Ford E350 or E450 Chassis	ASH1154 8C2418045DA 8C2Z-18124-D 8C2Z18124D 8C24-18045-DA ASH-1154 AT163G AT-163G	 	G63622	58622 77614
		8C24-18080-DB 8C2Z18125D ASH-1136 8C2Z-18125-D AT164G 8C2418080DB ASH1136 AT-164G	 	G63623	58623 77623
03	MotorHomes with Ford E350 or E450 Chassis	8C2418045DA 8C2Z-18124-D 8C2Z18124D 8C24-18045-DA ASH-1154 AT163G AT-163G	 	G63622	58622 77614
		8C24-18080-DB 8C2Z18125D ASH-1136 8C2Z-18125-D 8C2418080DB ASH1136 AT-164G	 	G63623	58623 77623
02	MotorHomes with Ford E350 or E450 Chassis	ASH1154 8C2418045DA 8C2Z-18124-D 8C2Z18124D 8C24-18045-DA ASH-1154 AT163G AT-163G	 	G63622	58622 77614

APPLICATION GUIDE

Year	Fitment Notes	OEM#								
			 Fleetline/ Gas SLX	Classic/ Ultra/ ProGuard/ Guardian	Max Control/ LTV Severe Duty/ Load Carrier	Steering Dampers/ Steering Stabilizer/ Cab Shock	 Fleetline/ Gas SLX	Classic/ Ultra/ ProGuard/ Guardian	Max Control/ LTV Severe Duty/ Load Carrier/ HiJackers	Steering Dampers/ Steering Stabilizer/ Cab Shock















JAYCO

JAYCO



GRANITE RIDGE (cont)

02	MotorHomes with Ford E350 or E450 Chassis	8C24-18080-DB 8C2Z18125D ASH-1136 8C2Z-18125-D AT164G 8C2418080DB ASH1136 AT-164G		G63623	58623 77623
----	---	--	-------	-------	-------	-------	---	--------	----------------	-------

GREYHAWK

09-24	MotorHomes with Ford E450 Chassis	ASH1154 8C2418045DA 8C2Z-18124-D 8C2Z18124D 8C24-18045-DA ASH-1154 AT163G AT-163G		G63622	58622 77614	
		8C24-18080-DB 8C2Z18125D ASH-1136 8C2Z-18125-D AT164G 8C2418080DB ASH1136 AT-164G		G63623	58623 77623	
08	MotorHomes with Ford E450 Chassis	8C2418045DA 8C2Z-18124-D 8C2Z18124D 8C24-18045-DA ASH-1154 AT163G AT-163G		G63622	58622 77614	
		8C24-18080-DB 8C2Z18125D ASH-1136 8C2Z-18125-D 8C2418080DB ASH1136 AT-164G		G63623	58623 77623	
04-07	MotorHomes with Ford E450 Chassis	ASH1154 8C2418045DA 8C2Z-18124-D 8C2Z18124D 8C24-18045-DA ASH-1154 AT163G AT-163G		G63622	58622 77614	
		8C24-18080-DB 8C2Z18125D ASH-1136 8C2Z-18125-D AT164G 8C2418080DB ASH1136 AT-164G		G63623	58623 77623	
03	MotorHomes with Ford E450 Chassis	8C2418045DA 8C2Z-18124-D 8C2Z18124D 8C24-18045-DA ASH-1154 AT163G AT-163G		G63622	58622 77614	
		8C24-18080-DB 8C2Z18125D ASH-1136 8C2Z-18125-D 8C2418080DB ASH1136 AT-164G		G63623	58623 77623	
02	MotorHomes with Ford E450 Chassis	ASH1154 8C2418045DA 8C2Z-18124-D 8C2Z18124D 8C24-18045-DA ASH-1154 AT163G AT-163G		G63622	58622 77614	

APPLICATION GUIDE

Year	Fitment Notes	OEM#								
			Fleetline\ Gas SLX	Classic\ Ultra\ ProGuard\ Guardian	Max Control\ LTV Severe Duty\ Load Carrier	Steering Dampers\ Steering Stabilizer\ Cab Shock	Fleetline\ Gas SLX	Classic\ Ultra\ ProGuard\ Guardian	Max Control\ LTV Severe Duty\ Load Carrier\ HiJackers	Steering Dampers\ Steering Stabilizer\ Cab Shock

JAYCO

JAYCO

GREYHAWK (cont)

02	MotorHomes with Ford E450 Chassis	8C24-18080-DB 8C2Z18125D ASH-1136 8C2Z-18125-D AT164G 8C2418080DB ASH1136 AT-164G	G63623	58623 77623
----	-----------------------------------	--	-------	-------	-------	-------	-------	--------	----------------	-------





MELBOURNE

09-24	MotorHomes with Ford E350 or E450 Chassis	ASH1154 8C2418045DA 8C2Z-18124-D 8C2Z18124D 8C24-18045-DA ASH-1154 AT163G AT-163G	G63622	58622 77614
		8C24-18080-DB 8C2Z18125D ASH-1136 8C2Z-18125-D AT164G 8C2418080DB ASH1136 AT-164G	G63623	58623 77623
08	MotorHomes with Ford E350 or E450 Chassis	8C2418045DA 8C2Z-18124-D 8C2Z18124D 8C24-18045-DA ASH-1154 AT163G AT-163G	G63622	58622 77614
		8C24-18080-DB 8C2Z18125D ASH-1136 8C2Z-18125-D 8C2418080DB ASH1136 AT-164G	G63623	58623 77623
07	MotorHomes with Ford E350 or E450 Chassis	ASH1154 8C2418045DA 8C2Z-18124-D 8C2Z18124D 8C24-18045-DA ASH-1154 AT163G AT-163G	G63622	58622 77614
		8C24-18080-DB 8C2Z18125D ASH-1136 8C2Z-18125-D AT164G 8C2418080DB ASH1136 AT-164G	G63623	58623 77623

PRECEPT

14-24	MotorHomes with Ford F53 Chassis with 16,000 lb GVW to 22,000 lb GVW	ASH-1229 ASH-1228 9U94-18045-AA ASH-1205 AT-620 ASH25823 ASH-1022 ASH1022 1C3418045JA ASH-25822 ASH1205 ASH-25823 ASH1228 ASH1229 AT620 1C34-18045-JA AT766 9U9Z18124A ASH294 1C3418045AA 1C34-18045-AA ASH-294 9U9418045AA 9U9Z-18124-A ASH25822 AT-766	83209
-------	--	---	-------	-------	-------	-------	-------	-------	-------	-------

APPLICATION GUIDE

Year	Fitment Notes	OEM#								
			 Fleetline\ Gas SLX	Classic\ Ultra\ ProGuard\ Guardian	Max Control\ LTV Severe Duty\ Load Carrier	Steering Dampers\ Steering Stabilizer\ Cab Shock	 Fleetline\ Gas SLX	Classic\ Ultra\ ProGuard\ Guardian	Max Control\ LTV Severe Duty\ Load Carrier\ HiJackers	Steering Dampers\ Steering Stabilizer\ Cab Shock

JAYCO

JAYCO

PRECEPT (cont)

14-24	MotorHomes with Ford F53 Chassis with 16,000 lb GVW to 22,000 lb GVW	9U9Z18125A ASH-1206 ASH137 AT-621 ASH-25824 ASH-1023 ASH25824 ASH-1230 9U9418080AA ASH1230 ASH1023 9U94-18080-AA 9U9Z-18125-A AT621 ASH1206 ASH-137	83122 89406
-------	--	--	------	------	------	------	----------------	------	------	------

REDHAWK

13-24	MotorHomes with Ford E450 Chassis	ASH1154 8C2418045DA 8C2Z-18124-D 8C2Z18124D 8C24-18045-DA ASH-1154 AT163G AT-163G	G63622	58622 77614
		8C24-18080-DB 8C2Z18125D ASH-1136 8C2Z-18125-D AT164G 8C2418080DB ASH1136 AT-164G	 O	G63623	58623 77623

REDHAWK SE

18-24	MotorHomes with Ford E450 Chassis	ASH1154 8C2418045DA 8C2Z-18124-D 8C2Z18124D 8C24-18045-DA ASH-1154 AT163G AT-163G	G63622	58622 77614
		8C24-18080-DB 8C2Z18125D ASH-1136 8C2Z-18125-D AT164G 8C2418080DB ASH1136 AT-164G	 O	G63623	58623 77623

KENWORTH

KENWORTH

K270

13-24	Models with 10,000 lb to 12,000 lb Front Axle	1707378PAC BFRG 072	 T	85182
	Models with Hendrickson HAS - 210L or HAS - 230L Rear Air Suspension	60670008L 60670-008 60670-008L 60670008	 O	83123 89405
	Models with Reyco 102 or 79KB Suspension (Drive Axle)	19495-01 1672501 16725-01 1949501	 O	83126 89430
13-23	Models with Hendrickson HAS - 230 Rear Air Suspension	60670-005 60670005L 60670-005PLUS-2 60670-005L 60670005	 O	83137

K300

93-05	All with Air Glide 100 Suspension with 8 air bags, 4 units required	K374-29 K37432 K374-32 K37429	 I	85310 89423
-------	---	--	-------	------	------	------	------	----------------	------	------

APPLICATION GUIDE

Year	Fitment Notes	OEM#								
			Fleetline\ Gas SLX	Classic\ Ultra\ ProGuard\ Guardian	Max Control\ LTV Severe Duty\ Load Carrier	Steering Dampers\ Steering Stabilizer\ Cab Shock	Fleetline\ Gas SLX	Classic\ Ultra\ ProGuard\ Guardian	Max Control\ LTV Severe Duty\ Load Carrier\ HiJackers	Steering Dampers\ Steering Stabilizer\ Cab Shock

KENWORTH

KENWORTH

K300 (cont)

93-05	All with Air Glide 200 with 40,000 lb Suspension with 8 air bags, 4 units required	665903 70701 665944			85900
	All with Air Glide 200 with 46,000 lb Suspension with 8 air bags, 4 units required	665945 665906			85902
	K300 COE Medium Duty	665565	O	85007
	Models with 12,000 lb Taper Leaf Front Springs (5/8" Top Mounting bolt)	665617 B71-1000 B711000	O	85031
	Models with Hendrickson Rear Air Suspension	4790219 47902-19	O		83123 89405
	Models with Multiple Leaf Springs on Front Axle (3/4" Mounting bolts)	B71-1003 B711003 K374-33 K3743 K37433 K374-3	O	83312
	Models with Reyco 102 or 79KB Suspension (Drive Axle)	19495-01 1672501 16725-01 1949501	O		83126 89430
	Models with Reyco 1209 or 1212 Suspension (Steer Axle)	19495-01 1949501	O	83126
	Models with Taper Leaf Springs on Front Axle (1" Mounting bolts)	B71-1002 B711002 K374-16 K374-27 K374-26 K37416 K37427 K37426	O	85001
Models with Woodhead Shock (Stamping Number ACHB 966)	ACHB966			83136	





T170

08-22	Models with Reyco 79KB Rear Steel Spring Suspension	19495-01 1672501 16725-01	O		83126 89430
08-13	Models with 8,000 lb Taper Leaf Front Springs	665617	O	85031

T270

24	Models with AG210L Rear Air Suspension	C71-1017 C711017 C711011 C71-1011			85069
08-23	Models with AG210L Rear Air Suspension	C71-1017 C711017 C711011 C71-1011			85069 89455
	Models with Hendrickson HMX 400/460 Haulmax with 16.5" Saddle	60680-004L 60680-004 64178-001 60680004 60680004L 64178001	O		83143
15-22	Models with 10,000 lb to 14,600 lb Taperleaf Springs and Set Back Front Axles	B71-6019 B716019	O	85989
	Models with 16,000 lb to 20,000 lb Taperleaf Springs and Set Back Front Axles	B716020 B71-6020	O	85989

APPLICATION GUIDE

Year	Fitment Notes	OEM#								
			 Fleetline/ Gas SLX	Classic/ Ultra/ ProGuard/ Guardian	Max Control/ LTV Severe Duty/ Load Carrier	Steering Dampers/ Steering Stabilizer/ Cab Shock	 Fleetline/ Gas SLX	Classic/ Ultra/ ProGuard/ Guardian	Max Control/ LTV Severe Duty/ Load Carrier/ HiJackers	Steering Dampers/ Steering Stabilizer/ Cab Shock

KENWORTH

KENWORTH

T270 (cont)

08-22	Models with Hendrickson HAS - 210L or HAS - 230L Rear Air Suspension	60670008L 60670-008 60670-008L 60670008	83123 89405
	Models with Hendrickson Primaax 230, 232, 460, 462, 690 and 692 Air Suspension (8-1/2" to 10" Ride Height)	60657-003 60657003 60657003L 60657-003L	85072
	Models with Reyco 102 or 79KB Suspension (Drive Axle)	19495-01 1672501 16725-01 1949501 TK19679	83126 89430
10-14	Models with 10,000 lb to 12,000 lb Front Axle	B71-6005 B716005	85084
	Models with 13,200 lb to 14,600 lb Front Axle	B71-6006 B716006	85084
	Models with 8,000 lb Front Axle	B71-6004 B716004	85084
08-14	Models with Hendrickson HAS - 400 (Standard) Rear Air Suspension	60670-005 60670005L 60670-005L 60670005	83137
08-10	Models with 12,000 lb Front Axle	665617	85031

T280

21-24	Models with Reyco 102 or 79KB Suspension (Drive Axle)	19495-01 1949501	83126 89430
24	Models with 10,000 lb to 12,000 lb Mono-leaf front springs	B71-6019 B716019	85989

T300

	All with Air Glide 100 Suspension with 8 air bags, 4 units required	K374-29 K37432 K374-32 K37429	85310 89423
	All with Air Glide 200 with 40,000 lb Suspension with 8 air bags, 4 units required	665903 70701 665944	85900
	Models with Hendrickson Rear Air Suspension	60670004 4790219	83123 89405
	Models with Multiple Leaf Springs on Front Axle (3/4" Mounting bolts)	B71-1003 B711003 K374-33 K3743 K37433 K374-3	83312
	Models with Reyco 102 or 79KB Suspension (Drive Axle)	19495-01 1672501 16725-01 1949501	83126 89430
	Models with Reyco 1209 or 1212 Suspension (Steer Axle)	19495-01 1949501	83126
	Models with Taper Leaf Springs on Front Axle (1" Mounting bolts)	B71-1002 B711002 K374-16 K374-27 K374-26 K37416 K37427 K37426	85001

APPLICATION GUIDE

Year	Fitment Notes	OEM#								
			 Fleetline\ Gas SLX	Classic\ Ultra\ ProGuard\ Guardian	Max Control\ LTV Severe Duty\ Load Carrier	Steering Dampers\ Steering Stabilizer\ Cab Shock	 Fleetline\ Gas SLX	Classic\ Ultra\ ProGuard\ Guardian	Max Control\ LTV Severe Duty\ Load Carrier\ HiJackers	Steering Dampers\ Steering Stabilizer\ Cab Shock

KENWORTH

KENWORTH

T300 (cont)

	Models with Woodhead Shock (Stamping Number ACHB 966)	ACHB966			83136	
99-08	Models with 12,000 lb Taper Leaf Front Springs (5/8" Top Mounting bolt)	665617 B71-1000 B711000	OO	85031	
	Models with Reyco 102 or 79KB Suspension (Drive Axle)	19495-01 1672501 16725-01 1949501			83126 89430
	Models with Reyco 1209 or 1212 Suspension (Steer Axle)	19495-01 1949501			83126 89430
95-08	All with Air Glide 200 with 46,000 lb Suspension with 8 air bags, 4 units required	665945 665906			85902	
	Models with Hendrickson HAS - 210L or HAS - 230L Rear Air Suspension	60670008L 60670-008 60670-008L 60670008			83123 89405	

T700

11-16	Models with 13,000 lb Front Axle	665858 B71-1001 B711001	OO	85070	
	Models with 86" Sleepers with O.E.M. Number	12021286 1202K286 T71-1003 1202-1286 T711003		83056	
	Models with Air Glide 230 (AG230) Rear Air Suspension	671656 C71-1013 C711013			85985
	Models with Air Glide 380 (AG380) Rear Air Suspension	C71-1016 C711016 C71-1002 C71-6015 C711002 C716015			85067 89451
	Models with Air Glide 400 (AG400) Rear Air Suspension	671962 C71-1014 C711014			85936 89456
	Models with Air Glide 400L (AG400L) Rear Air Suspension	03-08781 C71-1017 0308781 C711017 C711011 C71-1011			85069 89455
	Models with Extended Sleeper Cab	R71-1005 12021064 R711005 1202-1064 1202K064			83024	





KING OF THE ROAD

KING OF THE ROAD

CLASS A MOTORHOMES



04-06	Genesis Series MotorHomes with Freightliner XC Chassis	16-16874-000 1616874000 1616737000 16-16737-000 141700131810	OO	83160	
		1618103000 16-18103-000 481700000493		I	85900
		1616873000 16-16873-000 141700131809 1616736000 16-16736-000			OO		85029

APPLICATION GUIDE

Year	Fitment Notes	OEM#								
			 Fleetline\ Gas SLX	Classic\ Ultra\ ProGuard\ Guardian	Max Control\ LTV Severe Duty\ Load Carrier	Steering Dampers\ Steering Stabilizer\ Cab Shock	 Fleetline\ Gas SLX	Classic\ Ultra\ ProGuard\ Guardian	Max Control\ LTV Severe Duty\ Load Carrier\ HiJackers	Steering Dampers\ Steering Stabilizer\ Cab Shock

KRYSTAL BUS VARIOUS

KRYSTAL BUS

	Krystal E-450 Shuttle bus	ASH1154 ASH-1154		G63622	58622 77614
		ASH-1136 ASH1136		G63623	58623 77623



LEISURE TRAVEL WONDER

LEISURE TRAVEL

19-22	MotorHomes with Ford Transit-350 Chassis			G57816 ⁴⁰	G64177
-------	--	--	---	-------	----------------------	-------	-------	-------	--------	-------	-------

LGE COACHWORKS VARIOUS







LGE COACHWORKS

	All Shuttle buses with Ford E350 and E450 Chassis	ASH-1154		G63622	58622 77614
		ASH-1136		G63623	58623 77623

LION

LION









LION 6

	Electric Truck Models with Hendrickson Comfort Air Suspension (21K Capacity)	60670-018		83166
		60670-030L	
		60670030	
		60670018L	
		60670-030	
		60670030L	

MACK

MACK

MD6

24	Models with 10,000 lb Taperleaf Springs	78530771 471700015341		83127	
		Models with O.E.M. Number	23145372		83066
			23159760		85188
23	Models with 10,000 lb Taperleaf Springs	78530771 471700015341		83127	
		Models with O.E.M. Number	23159760		85188
			23145372		83066
21-22	Models with 10,000 lb Taperleaf Springs	78530771 471700015341		83127	
		Models with O.E.M. Number	23145372		83066
			23159760		85188



MANDALAY COACH

MANDALAY COACH

CLASS A MOTORHOMES

04-06	Mandalay Series MotorHomes with Freightliner XC Chassis	16-16874-000 1616874000 1616737000 16-16737-000 141700131810		83160
		1618103000 16-18103-000 481700000493		85900

APPLICATION GUIDE

Year	Fitment Notes	OEM#								
			Fleetline\ Gas SLX	Classic\ Ultra\ ProGuard\ Guardian	Max Control\ LTV Severe Duty\ Load Carrier	Steering Dampers\ Steering Stabilizer\ Cab Shock	Fleetline\ Gas SLX	Classic\ Ultra\ ProGuard\ Guardian	Max Control\ LTV Severe Duty\ Load Carrier\ HiJackers	Steering Dampers\ Steering Stabilizer\ Cab Shock

MANDALAY COACH

MANDALAY COACH

CLASS A MOTORHOMES (cont)

04-06	Mandalay Series MotorHomes with Freightliner XC Chassis	1616873000 16-16873-000 141700131809 1616736000 16-16736-000			85029
06	Presidio & Valencia Series MotorHomes with Freightliner XC Chassis	16-16874-000 1616874000 1616737000 16-16737-000 141700131810	OO	83160
		1618103000 16-18103-000 48170000493	IT	85900
		141700131809 1616736000 16-16736-000			85029

MARMON HERRINGTON

MARMON HERRINGTON

57 GLIDER

96-97	Conventional Tractors with Link Cabmate Model MARC57-B	12020054 12010054 1201-0054 1202-0054	OO	83021	
90-94	Conventional Tractors with Link Cabmate Model MARC57-B	12020054 12010054 1201-0054 1202-0054	OO	83021	

MITSUBISHI FUSO

MITSUBISHI FUSO

FE

96-04	Model with O.E.M. Number	MC114595		G63405
	Models with O.E.M. Number	MK433638 MA302296	IO	G63610
87-04	Model with O.E.M. Number	MB161497		G63299

FE145

05-11	Models with O.E.M. Number	MK433638 MK302296	IO	G63610
-------	---------------------------	----------------------	----	------	--------	------	------	--	------	------	------	------

FG

98-04	Model with O.E.M. Number	MC714595		G63405
-------	--------------------------	----------	--	------	------	------	------	--	------	--------	------	------

FH

88-04	Models with O.E.M. Number	MC826268	IO	G63610
-------	---------------------------	----------	----	------	--------	------	------	--	------	------	------	------

FK

91-94	FK457 Models with O.E.M. Number	MC814614	IO	85009
88-91	FK455 Models with O.E.M. Number	MC814614	IO	85009



FM

86-88	Model with O.E.M. Number	MC813135	IT	89447
	Models with O.E.M. Number	MC813135	IT	83456

FM330

05-11	Models with O.E.M. Number	MC091950	IO	83162
-------	---------------------------	----------	----	-------	------	------	------	--	------	------	------	------

APPLICATION GUIDE

Year	Fitment Notes	OEM#								
			Fleetline\ Gas SLX	Classic\ Ultra\ ProGuard\ Guardian	Max Control\ LTV Severe Duty\ Load Carrier	Steering Dampers\ Steering Stabilizer\ Cab Shock	Fleetline\ Gas SLX	Classic\ Ultra\ ProGuard\ Guardian	Max Control\ LTV Severe Duty\ Load Carrier\ HiJackers	Steering Dampers\ Steering Stabilizer\ Cab Shock

MONACO COACH

MONACO COACH



CLASS A MOTORHOMES

	Models with Workhorse UFO Chassis with Hendrickson Softek Front Suspension	66153-002 66153002 F4-BE5-C832-MO F4BE5C832MO	83124
98-11	All Models with W20 & W22 Workhorse Motorhome Chassis	24-153249 F4-BE5-B492-HO W0005662 W0006254 24153249 24-186629 F4-BE5-A832-MO F4BE5A832MO F4BE5F324HO F4-BE5-F324-HO 24186629 F4BE5B492HO	85125
04-07	Models with Roadmaster Chassis R4R, used on Cayman	83144
00-03	Models with Roadmaster Chassis RM4C or used on Knight	01809924	83144
	Models with Workhorse W22 Chassis with 8.1L Gas Monarch, LaPalma	01809925	85010

LA PALMA

12-13	MotorHomes with Ford F53 Chassis with 16,000 lb GVW to 22,000 lb GVW	ASH-1229 ASH-1228 9U94-18045-AA ASH-1205 AT-620 ASH25823 ASH-1022 ASH1022 1C3418045JA ASH-25822 ASH1205 ASH-25823 ASH1228 ASH1229 AT620 1C34-18045-JA AT766 9U9Z18124A ASH294 1C3418045AA 1C34-18045-AA ASH-294 9U9418045AA 9U9Z-18124-A ASH25822 AT-766	83209
		9U9Z18125A ASH-1206 ASH137 AT-621 ASH-25824 ASH-1023 ASH25824 ASH-1230 9U9418080AA ASH1230 ASH1023 9U94-18080-AA 9U9Z-18125-A AT621 ASH1206 ASH-137		83122 89406

APPLICATION GUIDE

Year	Fitment Notes	OEM#								
			Fleetline\ Gas SLX	Classic\ Ultra\ ProGuard\ Guardian	Max Control\ LTV Severe Duty\ Load Carrier	Steering Dampers\ Steering Stabilizer\ Cab Shock	Fleetline\ Gas SLX	Classic\ Ultra\ ProGuard\ Guardian	Max Control\ LTV Severe Duty\ Load Carrier\ HiJackers	Steering Dampers\ Steering Stabilizer\ Cab Shock





MONACO COACH

MONACO COACH

LA PALMA (cont)

09	Models with W20 & W22 Workhorse Motorhome Chassis	24-153249 F4-BE5-B492-HO W0005662 W0006254 24153249 24-186629 F4-BE5-A832-MO F4BE5A832MO F4BE5F324HO F4-BE5-F324-HO 24186629 F4BE5B492HO	85125
		O
	MotorHomes with Ford F53 Chassis with 16,000 lb GVW to 22,000 lb GVW	ASH-1229 ASH-1228 9U94-18045-AA ASH-1205 AT-620 ASH25823 ASH-1022 ASH1022 1C3418045JA ASH-25822 ASH1205 ASH-25823 ASH1228 ASH1229 AT620 1C34-18045-JA AT766 9U9Z18124A ASH294 1C3418045AA 1C34-18045-AA ASH-294 9U9418045AA 9U9Z-18124-A ASH25822 AT-766	83209
O	
07-08	MotorHomes with Ford F53 Chassis with 16,000 lb GVW to 22,000 lb GVW	9U9Z18125A ASH-1206 ASH137 AT-621 ASH-25824 ASH-1023 ASH25824 ASH-1230 9U9418080AA ASH1230 ASH1023 9U94-18080-AA 9U9Z-18125-A AT621 ASH1206 ASH-137	83122 89406
O	
04-06	Models with W20 & W22 Workhorse Motorhome Chassis	W0005663 F4-BE5-F325-HO 24-153256	85124
I	

APPLICATION GUIDE

Year	Fitment Notes	OEM#								
			 Fleetline/ Gas SLX	Classic/ Ultra/ ProGuard/ Guardian	Max Control/ LTV Severe Duty/ Load Carrier	Steering Dampers/ Steering Stabilizer/ Cab Shock	 Fleetline/ Gas SLX	Classic/ Ultra/ ProGuard/ Guardian	Max Control/ LTV Severe Duty/ Load Carrier/ HiJackers	Steering Dampers/ Steering Stabilizer/ Cab Shock



MONACO COACH

MONACO COACH

LA PALMA (cont)

02-06	Models with W20 & W22 Workhorse Motorhome Chassis	24-153249 F4-BE5-B492-HO W0005662 W0006254 24153249 24-186629 F4-BE5-A832-MO F4BE5A832MO F4BE5F324HO F4-BE5-F324-HO 24186629 F4BE5B492HO	85125
	MotorHomes with Ford F53 Chassis with 16,000 lb GVW to 22,000 lb GVW	ASH-1229 ASH-1228 9U94-18045-AA ASH-1205 AT-620 ASH25823 ASH-1022 ASH1022 1C3418045JA ASH-25822 ASH1205 ASH-25823 ASH1228 ASH1229 AT620 1C34-18045-JA AT766 9U9Z18124A ASH294 1C3418045AA 1C34-18045-AA ASH-294 9U9418045AA 9U9Z-18124-A ASH25822 AT-766	83209
		9U9Z18125A ASH-1206 ASH137 AT-621 ASH-25824 ASH-1023 ASH25824 ASH-1230 9U9418080AA ASH1230 ASH1023 9U94-18080-AA 9U9Z-18125-A AT621 ASH1206 ASH-137	83122 89406
01	MotorHomes with Ford F53 Chassis with 16,000 lb GVW to 22,000 lb GVW	ASH-1229 ASH-1228 9U94-18045-AA ASH-1205 AT-620 ASH25823 ASH-1022 ASH1022 1C3418045JA ASH-25822 ASH1205 ASH-25823 ASH1228 ASH1229 AT620 1C34-18045-JA AT766 9U9Z18124A ASH294 1C3418045AA 1C34-18045-AA ASH-294 9U9418045AA 9U9Z-18124-A ASH25822 AT-766	83209

APPLICATION GUIDE

Year	Fitment Notes	OEM#								
			Fleetline\ Gas SLX	Classic\ Ultra\ ProGuard\ Guardian	Max Control\ LTV Severe Duty\ Load Carrier	Steering Dampers\ Steering Stabilizer\ Cab Shock	Fleetline\ Gas SLX	Classic\ Ultra\ ProGuard\ Guardian	Max Control\ LTV Severe Duty\ Load Carrier\ Hijackers	Steering Dampers\ Steering Stabilizer\ Cab Shock



MONACO COACH

MONACO COACH

LA PALMA (cont)

00	Models with W20 & W22 Workhorse Motorhome Chassis	24-153249 F4-BE5-B492-HO W0005662 W0006254 24153249 24-186629 F4-BE5-A832-MO F4BE5A832MO F4BE5F324HO F4-BE5-F324-HO 24186629 F4BE5B492HO	O O	85125
	MotorHomes with Ford F53 Chassis with 16,000 lb GVW to 22,000 lb GVW	ASH-1229 ASH-1228 9U94-18045-AA ASH-1205 AT-620 ASH25823 ASH-1022 ASH1022 1C3418045JA ASH-25822 ASH1205 ASH-25823 ASH1228 ASH1229 AT620 1C34-18045-JA AT766 9U9Z18124A ASH294 1C3418045AA 1C34-18045-AA ASH-294 9U9418045AA 9U9Z-18124-A ASH25822 AT-766	O O	83209
		9U9Z18125A ASH-1206 ASH137 AT-621 ASH-25824 ASH-1023 ASH25824 ASH-1230 9U9418080AA ASH1230 ASH1023 9U94-18080-AA 9U9Z-18125-A AT621 ASH1206 ASH-137	O	83122 89406
90-99	MotorHomes with Ford F53 Chassis with 16,000 lb GVW to 22,000 lb GVW	ASH-1229 ASH-1228 9U94-18045-AA ASH-1205 AT-620 ASH-1022 1C34-18045-AA ASH-294 9U9Z-18124-A ASH-25822 ASH-25823 1C34-18045-JA AT-766	O	83209

APPLICATION GUIDE

Year	Fitment Notes	OEM#								
			Fleetline\ Gas SLX	Classic\ Ultra\ ProGuard\ Guardian	Max Control\ LTV Severe Duty\ Load Carrier	Steering Dampers\ Steering Stabilizer\ Cab Shock	Fleetline\ Gas SLX	Classic\ Ultra\ ProGuard\ Guardian	Max Control\ LTV Severe Duty\ Load Carrier\ HiJackers	Steering Dampers\ Steering Stabilizer\ Cab Shock



MONACO COACH

MONACO COACH

MONARCH

06-14	MotorHomes with Ford F53 Chassis with 16,000 lb GVW to 22,000 lb GVW	ASH-1229 ASH-1228 9U94-18045-AA ASH-1205 AT-620 ASH25823 ASH-1022 ASH1022 1C3418045JA ASH-25822 ASH1205 ASH-25823 ASH1228 ASH1229 AT620 1C34-18045-JA AT766 9U9Z18124A ASH294 1C3418045AA 1C34-18045-AA ASH-294 9U9418045AA 9U9Z-18124-A ASH25822 AT-766	83209
		9U9Z18125A ASH-1206 ASH137 AT-621 ASH-25824 ASH-1023 ASH25824 ASH-1230 9U9418080AA ASH1230 ASH1023 9U94-18080-AA 9U9Z-18125-A AT621 ASH1206 ASH-137	83122 89406
06-11	Models with W20 & W22 Workhorse Motorhome Chassis	24-153249 F4-BE5-B492-HO W0005662 W0006254 24153249 24-186629 F4-BE5-A832-MO F4BE5A832MO F4BE5F324HO F4-BE5-F324-HO 24186629 F4BE5B492HO	85125
		W0005663 F4-BE5-F325-HO 24-153256	85124
03-05	MotorHomes with Ford F53 Chassis with 16,000 lb GVW to 22,000 lb GVW	ASH-1229 ASH-1228 9U94-18045-AA ASH-1205 AT-620 ASH25823 ASH-1022 ASH1022 1C3418045JA ASH-25822 ASH1205 ASH-25823 ASH1228 ASH1229 AT620 1C34-18045-JA AT766 9U9Z18124A ASH294 1C3418045AA 1C34-18045-AA ASH-294 9U9418045AA 9U9Z-18124-A ASH25822 AT-766	83209

APPLICATION GUIDE

Year	Fitment Notes	OEM#								
			Fleetline\ Gas SLX	Classic\ Ultra\ ProGuard\ Guardian	Max Control\ LTV Severe Duty\ Load Carrier	Steering Dampers\ Steering Stabilizer\ Cab Shock	Fleetline\ Gas SLX	Classic\ Ultra\ ProGuard\ Guardian	Max Control\ LTV Severe Duty\ Load Carrier\ HiJackers	Steering Dampers\ Steering Stabilizer\ Cab Shock

MONACO COACH

MONACO COACH

MONARCH (cont)

01-02	Models with W20 & W22 Workhorse Motorhome Chassis	24-153249 F4-BE5-B492-HO W0005662 W0006254 24153249 24-186629 F4-BE5-A832-MO F4BE5A832MO F4BE5F324HO F4-BE5-F324-HO 24186629 F4BE5B492HO	OO	85125
	MotorHomes with Ford F53 Chassis with 16,000 lb GVW to 22,000 lb GVW	ASH-1229 ASH-1228 9U94-18045-AA ASH-1205 AT-620 ASH25823 ASH-1022 ASH1022 1C3418045JA ASH-25822 ASH1205 ASH-25823 ASH1228 ASH1229 AT620 1C34-18045-JA AT766 9U9Z18124A ASH294 1C3418045AA 1C34-18045-AA ASH-294 9U9418045AA 9U9Z-18124-A ASH25822 AT-766	OO	83209
		9U9Z18125A ASH-1206 ASH137 AT-621 ASH-25824 ASH-1023 ASH25824 ASH-1230 9U9418080AA ASH1230 ASH1023 9U94-18080-AA 9U9Z-18125-A AT621 ASH1206 ASH-137	OO	83122 89406
90-99	MotorHomes with Ford F53 Chassis with 16,000 lb GVW to 22,000 lb GVW	ASH-1229 ASH-1228 9U94-18045-AA ASH-1205 AT-620 ASH-1022 1C34-18045-AA ASH-294 9U9Z-18124-A ASH-25822 ASH-25823 1C34-18045-JA AT-766	OO	83209

VARIOUS

95-99	MotorHomes with Freightliner XC Chassis (22,000 to 26,000 lb GVW)	OO	83160	OO	85029
-------	---	-------	----	-------	------	------	------	----	-------	------	------	------



NATIONAL RV

NATIONAL RV

CLASS A MOTORHOMES

04-08	Models with Workhorse W20, W22, & W24 MotorHome Chassis with O.E.M. Number	W0005663 F4BE5F325HO F4-BE5-F325-HO 24153256 24-153256	I	I	85124
-------	--	--	---	------	------	------	------	---	-------	------	------	------

APPLICATION GUIDE

Year	Fitment Notes	OEM#								
			Fleetline\ Gas SLX	Classic\ Ultra\ ProGuard\ Guardian	Max Control\ LTV Severe Duty\ Load Carrier	Steering Dampers\ Steering Stabilizer\ Cab Shock	Fleetline\ Gas SLX	Classic\ Ultra\ ProGuard\ Guardian	Max Control\ LTV Severe Duty\ Load Carrier\ HiJackers	Steering Dampers\ Steering Stabilizer\ Cab Shock

NATIONAL RV

NATIONAL RV

CLASS A MOTORHOMES (cont)



01-08	Models with Workhorse W20 , W22 , & W24 MotorHome Chassis with O.E.M. Number	24-153249 F4-BE5-B492-HO W0005662 W0006254 24153249 24-186629 F4-BE5-A832-MO F4BE5A832MO F4BE5F324HO F4-BE5-F324-HO 24186629 F4BE5B492HO	85125
99-08	Models with Ford F53 Chassis with 16,000 lb GVW to 22,000 lb GVW	ASH-1229 ASH-1228 9U94-18045-AA ASH-1205 AT-620 ASH-1022 1C34-18045-AA ASH-294 9U9Z-18124-A ASH-25822 ASH-25823 1C34-18045-JA AT-766	83209
		9U9Z18125A ASH-1206 ASH137 AT-621 ASH-25824 ASH-1023 ASH25824 ASH-1230 9U9418080AA ASH1230 ASH1023 9U94-18080-AA 9U9Z-18125-A AT621 ASH1206 ASH-137	83122 89406
98-00	Models with Workhorse W20 , W22 , & W24 MotorHome Chassis with O.E.M. Number	24-153249 F4-BE5-B492-HO W0005662 W0006254 24-186629 F4-BE5-A832-MO F4BE5A832MO F4BE5F324HO F4-BE5-F324-HO 24186629 F4BE5B492HO	85125

NEWMAR

NEWMAR

	Ventana Series MotorHomes with Neway AS140 w/ 14,000 lb Front Suspension	90045455	85909
13-20	Bay Star, Bay Star Sport & Canyon Star Series MotorHomes with Ford F53 Chassis with 16,000 lb GVW to 22,000 lb GVW	ASH-1229 ASH-25822 ASH-25823	83209	
		ASH-25824 ASH25824	83122 89406	
06	Ventana Series MotorHomes with Freightliner XC Chassis	16-16874-000 1618874000 1616737000 16-16737-000 141700131810	83160	
		1618103000 16-18103-000 48170000493	85900	
		141700131809 1616736000 16-16736-000	85029	
02-05	Kountry Star Series MotorHomes with Freightliner XC Chassis	16-16874-000 1618874000 1616737000 16-16737-000 141700131810	83160	

APPLICATION GUIDE

Year	Fitment Notes	OEM#								
			Fleetline\ Gas SLX	Classic\ Ultra\ ProGuard\ Guardian	Max Control\ LTV Severe Duty\ Load Carrier	Steering Dampers\ Steering Stabilizer\ Cab Shock	Fleetline\ Gas SLX	Classic\ Ultra\ ProGuard\ Guardian	Max Control\ LTV Severe Duty\ Load Carrier\ HiJackers	Steering Dampers\ Steering Stabilizer\ Cab Shock

NEWMAR

NEWMAR

CLASS A MOTORHOMES (cont)

02-05	Kountry Star Series MotorHomes with Freightliner XC Chassis	1618103000 16-18103-000 481700000493	I 	85900	
		141700131809 1616736000 16-16736-000
02-04	Dutch Star & Moundain Aire Series MotorHomes with Freightliner XC Chassis	16-16874-000 1616874000 1616737000 16-16737-000 141700131810	O O	83160	
		1618103000 16-18103-000 481700000493	I 	85900
		141700131809 1616736000 16-16736-000	O O

NEXUS

NEXUS

16-20	Maybach Series MotorHomes with Ford F53 Chassis with 16,000 lb GVW to 22,000 lb GVW	ASH-1229 ASH-25822 ASH-25823	O O	89414
		ASH-25824 ASH25824	O O

CLASS C MOTORHOMES

12-20	Viper Series MotorHomes with Ford E350 & E450 Chassis	ASH-1136	I 	G63623	58623 77623
11-20	Phantom Series MotorHomes with Ford E350 & E450 Chassis	ASH-1136	I 	G63623	58623 77623
11-12	Scenic Traveler Series MotorHomes with Ford E450 Chassis	ASH-1154	I 	G63622	58622 77614
		ASH-1136	I 	G63623	58623 77623





MAYBACH

17-20	MotorHomes with Ford F53 Chassis with 16,000 lb GVW to 22,000 lb GVW	ASH-1229 ASH-1228 9U94-18045-AA 9U9Z18124A ASH25823 ASH-1022 1C3418045AA ASH1022 1C34-18045-AA 1C3418045JA 9U9418045AA 9U9Z-18124-A ASH25822 ASH-25822 ASH-25823 ASH1228 ASH1229 1C34-18045-JA	O O	83209
		ASH1230 9U9Z18125A ASH1023 9U94-18080-AA ASH-25824 9U9Z-18125-A ASH-1023 ASH25824 ASH-1230 9U9418080AA	O O	83122 89406

PHANTOM

11-24	MotorHomes with Ford E350 or E450 Chassis	ASH1154 8C2418045DA 8C2Z-18124-D 8C2Z18124D 8C24-18045-DA ASH-1154 AT163G AT-163G	I 	G63622	58622 77614
-------	---	--	-------	------	--------	----------------	------	------	------	------	------	------

APPLICATION GUIDE

Year	Fitment Notes	OEM#								
			 Fleetline/ Gas SLX	Classic/ Ultra/ ProGuard/ Guardian	Max Control/ LTV Severe Duty/ Load Carrier	Steering Dampers/ Steering Stabilizer/ Cab Shock	 Fleetline/ Gas SLX	Classic/ Ultra/ ProGuard/ Guardian	Max Control/ LTV Severe Duty/ Load Carrier/ HiJackers	Steering Dampers/ Steering Stabilizer/ Cab Shock

NEXUS

NEXUS

PHANTOM (cont)

11-24	MotorHomes with Ford E350 or E450 Chassis	8C24-18080-DB 8C2Z18125D ASH-1136 8C2Z18125C 8C2Z18125B 8C2Z18125A AT164G 8C2418080DB AT-164G 8C2Z-18125-C 8C2Z-18125-B 8C2Z-18125-D 8C2Z-18125-A ASH1136	G63623	58623 77623
-------	---	--	-------	-------	-------	-------	-------	--------	----------------	-------

TRIUMPH

20-24	MotorHomes with Ford E350 or E450 Chassis	ASH1154 8C2418045DA 8C2Z-18124-D 8C2Z18124D 8C24-18045-DA ASH-1154 AT163G AT-163G	G63622	58622 77614
		8C24-18080-DB 8C2Z18125D ASH-1136 8C2Z18125C 8C2Z18125B 8C2Z18125A AT164G 8C2418080DB AT-164G 8C2Z-18125-C 8C2Z-18125-B 8C2Z-18125-D 8C2Z-18125-A ASH1136	G63623	58623 77623

VIPER

11-24	MotorHomes with Ford E350 or E450 Chassis	ASH1154 8C2418045DA 8C2Z-18124-D 8C2Z18124D 8C24-18045-DA ASH-1154 AT163G AT-163G	G63622	58622 77614
		8C24-18080-DB 8C2Z18125D ASH-1136 8C2Z18125C 8C2Z18125B 8C2Z18125A AT164G 8C2418080DB AT-164G 8C2Z-18125-C 8C2Z-18125-B 8C2Z-18125-D 8C2Z-18125-A ASH1136	G63623	58623 77623

PETERBILT

PETERBILT



210

08-15	Models with Reyco 102 or 79KB Suspension (Drive Axle)	19495-01 1672501 16725-01 1949501 TK19679	83126 89430
-------	---	---	-------	-------	-------	-------	-------	----------------	-------	-------

220

13-24	Models with Hendrickson HAS - 210L or HAS - 230L Rear Air Suspension	60670-008PLUS-2 60670008L 60670-008 60670-008L 60670008	83123 89405
	Models with Reyco 102 or 79KB Suspension (Drive Axle)	19495-01 1672501 16725-01 1949501 TK19679	83126 89430

APPLICATION GUIDE

Year	Fitment Notes	OEM#								
			Fleetline\ Gas SLX	Classic\ Ultra\ ProGuard\ Guardian	Max Control\ LTV Severe Duty\ Load Carrier	Steering Dampers\ Steering Stabilizer\ Cab Shock	Fleetline\ Gas SLX	Classic\ Ultra\ ProGuard\ Guardian	Max Control\ LTV Severe Duty\ Load Carrier\ HiJackers	Steering Dampers\ Steering Stabilizer\ Cab Shock

PETERBILT

PETERBILT

220 (cont)

13-23	Models with 12,000 lb Front Axle	1707378PAC BFRG 072		85182
13-22	Models with Reyco 102AR (Standard) Rear Air Suspension	1288701 12887-02 12887-01 1288702		85013 89414
13	Models with 12,000 lb Front Axle	0202738 B71-6016A B71-6016 B716016A 02-02738 B716016		85012
10	Models with 12,000 lb Front Axle	0202738 B71-6016A B71-6016 B716016A 02-02738 B716016		85012
	Models with Hendrickson HAS - 210L or HAS - 230L Rear Air Suspension	60670-008PLUS-2 60670008L 60670-008 60670-008L 60670008		83123 89405
	Models with Reyco 102 or 79KB Suspension (Drive Axle)	19495-01 1672501 16725-01 1949501 TK19679		83126 89430
	Models with Reyco 102AR (Standard) Rear Air Suspension	1288701 12887-02 12887-01 1288702		85013 89414
07	Models with 12,000 lb Front Axle	0202738 B71-6016A B71-6016 B716016A 02-02738 B716016		85012
	Models with Hendrickson HAS - 210L or HAS - 230L Rear Air Suspension	60670-008PLUS-2 60670008L 60670-008 60670-008L 60670008		83123 89405
	Models with Reyco 102 or 79KB Suspension (Drive Axle)	19495-01 1672501 16725-01 1949501 TK19679		83126 89430
	Models with Reyco 102AR (Standard) Rear Air Suspension	1288701 12887-02 12887-01 1288702		85013 89414





325

08-19	Models with 12000 lb Set Back Front Axle	0202738 B71-6016A B71-6016 B716016A 02-02738 B716016		85012
	Models with Reyco 102 or 79KB Suspension (Drive Axle)	19495-01 1949501 TK19679		83126 89430
08-15	Models with 8,000 lb Front Axle	B71-6004 B716004		85084

330

	Models with O.E.M. Number	0203020 B71-6017 02-03020 B716017		85910
16-22	Models with 10,000 lb to 14,600 lb Taperleaf Springs and Set Back Front Axles	B71-6019 B716019		85989

APPLICATION GUIDE

Year	Fitment Notes	OEM#								
			 Fleetline/ Gas SLX	Classic/ Ultra/ ProGuard/ Guardian	Max Control/ LTV Severe Duty/ Load Carrier	Steering Dampers/ Steering Stabilizer/ Cab Shock	 Fleetline/ Gas SLX	Classic/ Ultra/ ProGuard/ Guardian	Max Control/ LTV Severe Duty/ Load Carrier/ HiJackers	Steering Dampers/ Steering Stabilizer/ Cab Shock

PETERBILT

PETERBILT



330 (cont)

07-22	Models with Peterbilt Low Air Leaf Suspension	03-08781 C71-1017 0308781 C711017 C711011 C71-1011	 	85069 89455
	Models with Reyco 79KB Rear Steel Spring Suspension	19495-01 1672501 16725-01 1949501 TK19679	 	83126 89430
14-21	Models with Air Trac Suspension (40,000 lb)	C71-6003 C716003	 	85988
07-21	Models with Air Trac Suspension (46,000 lb)	0307421 C71-6002 03-07421 C716002	 	85311 89424
	Models with Reyco 102AR (Standard) Rear Air Suspension	1288701 12887-02 12887-01 1288702	 	85013 89414
07-16	Models with 12000 lb Set Back Front Axle	0202738 B71-6016A B71-6016 B716016A 02-02738 B716016	85012
03-05	Models with Peterbilt Low Air Leaf Suspension	03-08781 C71-1017 0308781 C711017 C711011 C71-1011	 	85069 89455
95-05	Models with 12000 lb Set Back Front Axle	0202738 B71-6016A B71-6016 B716016A 02-02738 B716016	85012
	Models with Air Trac Suspension (46,000 lb)	0307421 C71-6002 03-07421 C716002	 	85311 89424
	Models with Reyco 102AR (Standard) Rear Air Suspension	1288701 12887-02 12887-01 1288702	 	85013 89414
	Models with Reyco 79KB Rear Steel Spring Suspension	19495-01 1672501 16725-01 1949501 TK19679	 	83126 89430
95-02	Models with Peterbilt 40000 lb Low Air Leaf Suspension	03-07423 0307423	 	85033 89427

536

22-24	Models with 10,000 lb to 14,600 lb Taperleaf Springs and Set Back Front Axles	B71-6019 B716019	85989
	Models with Air Trac Suspension (40,000 lb)	C71-6003 C716003	 	85988
	Models with Peterbilt Low Air Leaf Suspension	C71-1017 C711017	 	85069 89455

APPLICATION GUIDE

Year	Fitment Notes	OEM#								
			Fleetline\ Gas SLX	Classic\ Ultra\ ProGuard\ Guardian	Max Control\ LTV Severe Duty\ Load Carrier	Steering Dampers\ Steering Stabilizer\ Cab Shock	Fleetline\ Gas SLX	Classic\ Ultra\ ProGuard\ Guardian	Max Control\ LTV Severe Duty\ Load Carrier\ HiJackers	Steering Dampers\ Steering Stabilizer\ Cab Shock

PHOENIX

PHOENIX

CRUISER

00-23	MotorHomes with Ford E350 or E450 Chassis	ASH1154 8C2418045DA 8C2Z-18124-D 8C2Z18124D 8C24-18045-DA ASH-1154 AT163G AT-163G	O	G63622	58622 77614	O
		8C24-18080-DB 8C2Z18125D ASH-1136 8C2Z-18125-D AT164G 8C2418080DB ASH1136 AT-164G	O	O	G63623	58623 77623

TRX

20-22	MotorHomes with Ford Transit-350 Chassis		T	G57816 ⁴⁰	O	G64177
-------	--	--	---	------	----------------------	------	------	---	------	--------	------	------



PIERCE MFG. INC.

PIERCE MFG. INC.

VARIOUS

09-24	Models with Freightliner Chassis (M2 106 or 108SD with 8000 to 16000 lb Front Axle and Taperleaf Spring)	10-13760-000 1013760000 10-13592-000 471700000440 471700002991 SDA471700002991	O	85959	O
		1013809000 10-13809-000 471700003920	O	85958	O
03-24	Models with Freightliner M2 112 Chassis (Day Cab Models with Spring Suspensions)	1860767000 18-47349-000 814903003483 18-60767-000 1847349000	O	O	83039
02-24	Models with Freightliner Chassis (M2 106, 108SD or 114SD with Day Cab Models and Spring Suspensions)	1860766000 18-47350-000 18-60766-000 814903003482 1847350000	O	O	83040
19-23	Models with International HV Chassis with 11,000 lb to 14,000 lb Taper-leaf Springs	6127714C1	O	85928	O
	Models with International HV Chassis with Hendrickson HMX 400/460 Haulmax with 16.5" Saddle	60680-004L 60680-004 60680004 60680004L	O	O	83143
	Models with International HV Chassis with Hendrickson HMX 400/460 Haulmax with 17.5" & 18.5" Saddle	60680-005L 60680005L 60680005 HDR60680-005 HDR60680005 60680-005	O	O	83142
	Models with International HV Chassis with Hendrickson Primaax 230/460 Air Suspension with 9" Ride Height	60657-003 60657003 60657003L 3626571C2 H60657003 60657-003L	O	O	85072

APPLICATION GUIDE

Year	Fitment Notes	OEM#								
			Fleetline\ Gas SLX	Classic\ Ultra\ ProGuard\ Guardian	Max Control\ LTV Severe Duty\ Load Carrier	Steering Dampers\ Steering Stabilizer\ Cab Shock	Fleetline\ Gas SLX	Classic\ Ultra\ ProGuard\ Guardian	Max Control\ LTV Severe Duty\ Load Carrier\ HiJackers	Steering Dampers\ Steering Stabilizer\ Cab Shock

PIERCE MFG. INC.

PIERCE MFG. INC.

VARIOUS (cont)

19-23	Models with International HV Chassis with Link Cab Mate Suspension	12019008 1201-9008 2509223C92 2509223C91	OO		83054
17-23	Models with Ford F-450 or F-550 Chassis (4WD and OEM number)	ASH-85927 LC3Z-18125-W ASH-866127 ASH-866139 LC3Z-18125-J HC3Z-18125-EP HC3Z-18125-X ASH-85789	OO		77986
20-22	Models with International MV Chassis with 20,000 lb IROS Air Suspension	6127713C2	OO	85656
19-22	Models with International MV Chassis with 9,000 to 10,000 lb Front Suspension	6127088C1	OO	83163
	Models with International MV Chassis with Hendrickson HAS - 230 Rear Air Suspension	60675-003 H60675-003 3514952C1 60675-003L 60675003L 60675003 H60675003	OO	85976
03-22	Models with Freightliner M2 112 Chassis (Crew Cab Models with O.E.M. Number)	18-41762-000 1841762000 1860764000 814903003528 18-60764-000	OO		83038
19-21	Models with International HV Chassis with 16,000 lb to 23,000 lb Parabolic Taperleaf Springs	3576464C2	OO	85957
	Models with International HV Chassis with 18,000 to 20,000 lb (Set Forward) Front Axle	3868265C1	OO	85995

RAM

RAM

4500

12-18	Models with O.E.M. Number	6811 1105AC001 05168295AB 05168284AC 6811 1104AB-001 6811 1105AC 6811 1105AC-001 6811 1104AB 6811 1104AB001	OO	85649
		05168296AA 6811 1107AA 6811 1107AA-001 6811 1107AA001	OO	85650

5500

12-18	Models with O.E.M. Number	6811 1105AC001 05168295AB 05168284AC 6811 1104AB-001 6811 1105AC 6811 1105AC-001 6811 1104AB 6811 1104AB001	OO	85649
		05168296AA 6811 1107AA 6811 1107AA-001 6811 1107AA001	OO	85650

APPLICATION GUIDE

Year	Fitment Notes	OEM#								
			Fleetline\ Gas SLX	Classic\ Ultra\ ProGuard\ Guardian	Max Control\ LTV Severe Duty\ Load Carrier	Steering Dampers\ Steering Stabilizer\ Cab Shock	Fleetline\ Gas SLX	Classic\ Ultra\ ProGuard\ Guardian	Max Control\ LTV Severe Duty\ Load Carrier\ HiJackers	Steering Dampers\ Steering Stabilizer\ Cab Shock

RENEGADE

RENEGADE

VERACRUZ

19-23	Models with Ford F-550 Chassis (4WD and OEM number)	ASH-85927 LC3Z-18125-W ASH-866127 ASH-866139 LC3Z-18125-J HC3Z-18125-EP HC3Z-18125-X ASH-85789									77986
-------	--	---	------	------	------	------	--	--	--	--	--	--	--	--	-------	------

SHASTA RV

SHASTA RV

ALL MODELS

	MotorHomes with Ford E350 Chassis	ASH1154 8C2418045DA 8C2Z-18124-D 8C2Z18124D 8C24-18045-DA ASH-1154 AT163G AT-163G	G63622	58622 77614											
		8C24-18080-DB 8C2Z18125D ASH-1136 8C2Z-18125-D AT164G 8C2418080DB ASH1136 AT-164G	G63623	58623 77623
	MotorHomes with Ford E450 Chassis	ASH1154 8C2418045DA 8C2Z-18124-D 8C2Z18124D 8C24-18045-DA ASH-1154 AT163G AT-163G	G63622	58622 77614
		8C24-18080-DB 8C2Z18125D ASH-1136 8C2Z-18125-D AT164G 8C2418080DB ASH1136 AT-164G	G63623	58623 77623

SPARTAN MOTORS

SPARTAN MOTORS

ALPINE

97-00	MotorHome Chassis with O.E.M. Number	0377SS5 1300B46 0377-SS5 B46-1725 B461725									85029
-------	--------------------------------------	---	------	------	------	------	--	--	--	--	--	--	--	--	-------	------	------	------

CLASS A MOTORHOMES

00-12	Summit (19000 - 22000 GVW)	B461725	O O 85910										
-------	----------------------------	---------	--------------	------	------	------	--	--	--	--	--	--	--	--	--	--





HIGHLANDER

97-00	With I Beam Front Suspension	B462150 B461731	O O 85909										
		B462151 B461732	O O 85030 89440

K2

97-00	Models with O.E.M. Number	2200201 B462151 B46-2151									85007
		With I Beam Front Suspension	B462150 B461731	O O 85909
	B462151 B461732		O O 85030 89440	
	With Independent Front Granning Suspension	B462385 B462151	O O 85030 89440	

APPLICATION GUIDE

Year	Fitment Notes	OEM#								
			 Fleetline\ Gas SLX	Classic\ Ultra\ ProGuard\ Guardian	Max Control\ LTV Severe Duty\ Load Carrier	Steering Dampers\ Steering Stabilizer\ Cab Shock	 Fleetline\ Gas SLX	Classic\ Ultra\ ProGuard\ Guardian	Max Control\ LTV Severe Duty\ Load Carrier\ HiJackers	Steering Dampers\ Steering Stabilizer\ Cab Shock



SPARTAN MOTORS

SPARTAN MOTORS







K2 (cont)

95-96	Models with I Beam Front Suspension	B462151 B461732		85909		85030 89440
91-95	Models with Tuthill 102 AR Air Suspension	B46-1594 B461594 0346SS5 0346-SS5 B462502			85030 89440

MOTORHOME

91-92	MC 2000 With I Beam Front Suspension	B461593		85909
	Models with Tuthill 102 AR Air Suspension	B46-1594 B461594 0346SS5 0346-SS5 B462502			85013 89414









MOUNTAIN MASTER

97-00	Models with O.E.M. Number	2200201 B462151 B46-2151			85007
	With Independent Front Granning Suspension	B462385 B462151			85030 89440
95-00	With I Beam Front Suspension	B462150 B461731		85909
		B462151 B461732			85030 89440
93-95	MC 2000 With I Beam Front Suspension	B461593		85909
	Models with Tuthill 102 AR Air Suspension	B46-1594 B461594 0346SS5 0346-SS5 B462502			85013 89414



RV MODELS

	RV Models with Primaax Air Suspensions	60665014 60665014L 60665-014 60665-014L			85962
--	--	--	--	------	------	------	------	------	---	-------	------	------	------

VARIOUS

	Buses with Hendrickson Softek Suspension with Drum and Disc Brakes	58913-009L 58913-009 58913009 58913009L 471700000456		85959
	Chassis With Hendrickson HTS 210 Suspension (Type C School Bus Applications)	60665025L 60665-025 60665-025L			85036 89405
	Fire Truck with O.E.M. Number	0272SS5 0272-SS5		85712
	Fire Truck with Ridewell Suspension RD 202 52000	S2607B			85702
	Models with O.E.M. Number	59011		83214
	Models with Reyco 1200 Steer Option)	21310-01 2131001		85307
	Motorhome chassis with Ridewell Front Suspension	AS 4025B		85712
97-00	Summit MotorHome Chassis with O.E.M. Number	0377SS5 1300B46 0377-SS5 B46-1725 B461725			85029
86	Fire Truck with Ridewell Front Suspension	AS 4025B		85712

APPLICATION GUIDE

Year	Fitment Notes	OEM#								
			Fleetline\ Gas SLX	Classic\ Ultra\ ProGuard\ Guardian	Max Control\ LTV Severe Duty\ Load Carrier	Steering Dampers\ Steering Stabilizer\ Cab Shock	Fleetline\ Gas SLX	Classic\ Ultra\ ProGuard\ Guardian	Max Control\ LTV Severe Duty\ Load Carrier\ HiJackers	Steering Dampers\ Steering Stabilizer\ Cab Shock

STARCRAFT BUS CO.

STARCRAFT BUS CO.



ALLSTAR XL & XLT - SERIES

15-23	Models with F-650 chassis with 13,500, 15,500 & 19,000 lb Multi-leaf Rear Springs	FC4Z-18125-A FC4418080AB ASH-24660 FC4Z18125A 471700011531 FC44-18080-AB ASH24660	 O	85180
	Models with F-650 chassis with 19.5" or 22.5" Wheels (22,000 lb GVW)	FC4Z-18124-B FC4Z-18124-A ASH-24659 ASH-24658 ASH24659 ASH24658 471700011530 FC4Z18124B FC4Z18124A FC44-18045-BB FC4418045BB	 O	85181
00-15	Models with F-650 chassis with 10,000 lb Front Suspension	4C4Z18124QA 3584116C1 3584116C2 AA616 AA-616 4C4Z-18124-QA	 O	83175
	Models with F-650 chassis with 12,000 & 13,200 lb Front Springs	4C4Z18124RA 4C4Z-18124-JB 4C4Z18124JB 3584118C2 AA-617 AT812 4C4Z-18124-RA AA617 AT-812	 O	85928
15	Models with F-650 chassis with 21,000 lb Rear Air Suspension	3578858C1 3578858C2 4C4Z-18125-DA 4C4Z18125DA	 O	85656
04-11	Models with F-650 chassis with 22,000 lb Multi-leaf Rear Springs	4C4Z-18125-B 4C4Z18125B 501906C92 ASH24661	 O	83317

E350 & E450 FORD CHASSIS MODELS

Allstar Series Shuttle buses with Ford E350 & E450 Chassis	ASH-1154	 O	G63622	58622 77614
	ASH-1136	 O	G63623	58623 77623
MVP Series Shuttle buses with Ford E450 Chassis	ASH-1154	 O	G63622	58622 77614
	ASH-1136	 O	G63623	58623 77623
Starlite Series Shuttle buses with Ford E350 & E450 Chassis	ASH-1154	 O	G63622	58622 77614
	ASH-1136	 O	G63623	58623 77623
Starquest Series Shuttle buses with Ford E350 & E450 Chassis	ASH-1154	 O	G63622	58622 77614
	ASH-1136	 O	G63623	58623 77623
Ultra Star Series Shuttle buses with Ford E450 Chassis	ASH-1154	 O	G63622	58622 77614
	ASH-1136	 O	G63623	58623 77623

APPLICATION GUIDE

Year	Fitment Notes	OEM#								
			Fleetline\ Gas SLX	Classic\ Ultra\ ProGuard\ Guardian	Max Control\ LTV Severe Duty\ Load Carrier	Steering Dampers\ Steering Stabilizer\ Cab Shock	Fleetline\ Gas SLX	Classic\ Ultra\ ProGuard\ Guardian	Max Control\ LTV Severe Duty\ Load Carrier\ HiJackers	Steering Dampers\ Steering Stabilizer\ Cab Shock

STARCRAFT BUS CO.

STARCRAFT BUS CO.

E350 & E450 FORD CHASSIS MODELS (cont)

Xpress Series Shuttle buses with Ford E350 & E450 Chassis	ASH-1154	I O	G63622	58622 77614
	ASH-1136	I O	G63623	58623 77623

STERLING TRUCK

STERLING TRUCK

ACTERRA

	Models with 11000 to 12000 lb Front axle	6803230300	O O	85006
03-10	All Models with Freightliner TufTrac Rear Air Suspension	1615770000 481700125969 16-15770-000	O O	85956
	Models with 15000 lb Rear Suspension	6803260000	O I	83120
03-10	Models with FAS II (40,000 lb) Rear Air Suspension	16-15817-000 1613957000 1615817000 16-13957-000 680611 680339 XC4518080BA XC45-18080-BA	O O	85724 89443
	Models with Hendrickson Front Airtek	58913003 58913003L 58913-003L 471700131331 58913-003	O O	85932
01-09	Models with 10000 to 12000 lb. Taper-leaf Spring Suspension	1012390000 10-12390-000	O O	85920
	Models with 6000 to 9000 lb Front axle	10-12388-000 1012388000	O O	85920



ACTERRA 5500

01-07	Models with 15000 lb Rear Suspension	6803260000	O I	83120
01-07	Models with FAS II (40,000 lb) Rear Air Suspension	16-15817-000 1613957000 1615817000 16-13957-000 680611 680339 XC4518080BA XC45-18080-BA	O O	85724 89443
	Models with Hendrickson Front Airtek	58913003 58913003L 58913-003L 471700131331 58913-003	O O	85932

ACTERRA 6500

01-07	Models with 15000 lb Rear Suspension	6803260000	O I	83120
01-07	Models with FAS II (40,000 lb) Rear Air Suspension	16-15817-000 1613957000 1615817000 16-13957-000 680611 680339 XC4518080BA XC45-18080-BA	O O	85724 89443
	Models with Hendrickson Front Airtek	58913003 58913003L 58913-003L 471700131331 58913-003	O O	85932

APPLICATION GUIDE

Year	Fitment Notes	OEM#								
			Fleetline\ Gas SLX	Classic\ Ultra\ ProGuard\ Guardian	Max Control\ LTV Severe Duty\ Load Carrier	Steering Dampers\ Steering Stabilizer\ Cab Shock	Fleetline\ Gas SLX	Classic\ Ultra\ ProGuard\ Guardian	Max Control\ LTV Severe Duty\ Load Carrier\ HiJackers	Steering Dampers\ Steering Stabilizer\ Cab Shock

STERLING TRUCK

STERLING TRUCK

BULLET 45

08-10	Models with O.E.M. Number	6811 1105AC001 05168295AB 05168284AC 6811 1104AB-001 6811 1105AC 6811 1105AC-001 6811 1104AB 6811 1104AB001	I O	85649
		05168296AA 6811 1107AA 6811 1107AA-001 6811 1107AA001	85650

BULLET 55

08-10	Models with O.E.M. Number	6811 1105AC001 05168295AB 05168284AC 6811 1104AB-001 6811 1105AC 6811 1105AC-001 6811 1104AB 6811 1104AB001	I O	85649
		05168296AA 6811 1107AA 6811 1107AA-001 6811 1107AA001	85650

THOMAS

THOMAS





TYPE A SCHOOL BUS

00-22	Minotour Type A School bus with Ford E450 Chassis	8C2Z-18124-D 8C24-18045-DA ASH-1154 AT-163G	I O	G63622	58622 77614
92-22	Minotour Type A School bus with Ford E350 Chassis	8C2Z-18124-D 8C24-18045-DA ASH-1154 AT-163G	I O	G63622	58622 77614
00-20	Minotour Type A School bus with Ford E450 Chassis	8C24-18080-DB ASH-1136 8C2Z-18125-D AT-164G	I O	G63623	58623 77623
92-20	Minotour Type A School bus with Ford E350 Chassis	8C24-18080-DB ASH-1136 8C2Z-18125-D AT-164G	I O	G63623	58623 77623

VARIOUS

	Buses with Neway Tandem Air Suspension	61310232	I O	85000 89436
	Buses with O.E.M. Number	1619138000 16-19138-000	O O	85058
	Model MVP	61310101	O O	85736
	Models with Hendrickson Comfort Air Rear Air Suspension	60670-006 60670006L 60670-006L 60670006	I O	83147
	ROC Front, SAF-T-Liner	61300285 GBL651442	I I	83102
	SAF-T-Liner HDX Models with Hendrickson Comfort Air Rear Air Suspension	471700131545 60998003 60998-001 60998-003 60998001	I O	85006
	SAF-T-Liner School Bus MVP-ER & MVP-EF	61300219 70445 61300222 61300223	O O	85014
	School Bus	680010 614974	O O	85304
		680054 00614966 3000614966 300-0614966	O O	85307

APPLICATION GUIDE

Year	Fitment Notes	OEM#								
			 Fleetline\ Gas SLX	Classic\ Ultra\ ProGuard\ Guardian	Max Control\ LTV Severe Duty\ Load Carrier	Steering Dampers\ Steering Stabilizer\ Cab Shock	 Fleetline\ Gas SLX	Classic\ Ultra\ ProGuard\ Guardian	Max Control\ LTV Severe Duty\ Load Carrier\ HiJackers	Steering Dampers\ Steering Stabilizer\ Cab Shock

THOMAS

THOMAS

VARIOUS (cont)

	Type C Conventional Buses (65 capacity) with FAS II Rear Air Suspension	16-15817-000 1618708000 1615817000 16-18708-000 61310434 61310478	O	O	85724 89443
05-22	Models with Freightliner B2 Bus Chassis & 15000 lb Rear Suspension	6803260000	O	O	83120
09-12	Type C School bus chassis with O.E.M. Number	16-18713-000 1618713000 471700003070	O	O	85122
03	Type C Conventional School buses (65 capacity) with O.E.M. Number	680-323-0300 6803230300 GBL665538	O	85006	O

THOR MOTOR COACH

THOR MOTOR COACH



A.C.E

11-24	MotorHomes with Ford F53 Chassis with 16,000 lb GVW to 22,000 lb GVW	ASH-1229 ASH-1228 9U94-18045-AA ASH-1205 AT-620 ASH25823 ASH-1022 ASH1022 1C3418045JA ASH-25822 ASH1205 ASH-25823 ASH1228 ASH1229 AT620 1C34-18045-JA AT766 9U9Z18124A ASH294 1C3418045AA 1C34-18045-AA ASH-294 9U9418045AA 9U9Z-18124-A ASH25822 AT-766	O	83209	O
		9U9Z18125A ASH-1206 ASH137 AT-621 ASH-25824 ASH-1023 ASH25824 ASH-1230 9U9418080AA ASH1230 ASH1023 9U94-18080-AA 9U9Z-18125-A AT621 ASH1206 ASH-137	O	O	83122 89406

AXIS

14-24	MotorHomes with Ford E350 or E450 Chassis	ASH1154 8C2418045DA 8C2Z-18124-D 8C2Z18124D 8C24-18045-DA ASH-1154 AT163G AT-163G	O	G63622	58622 77614	O
		8C24-18080-DB 8C2Z18125D ASH-1136 8C2Z-18125-D AT164G 8C2418080DB ASH1136 AT-164G	O	O	G63623	58623 77623

APPLICATION GUIDE



Year	Fitment Notes	OEM#								
			Fleetline\ Gas SLX	Classic\ Ultra\ ProGuard\ Guardian	Max Control\ LTV Severe Duty\ Load Carrier	Steering Dampers\ Steering Stabilizer\ Cab Shock	Fleetline\ Gas SLX	Classic\ Ultra\ ProGuard\ Guardian	Max Control\ LTV Severe Duty\ Load Carrier\ HiJackers	Steering Dampers\ Steering Stabilizer\ Cab Shock

THOR MOTOR COACH CHALLENGER

THOR MOTOR COACH

09-24	MotorHomes with Ford F53 Chassis with 16,000 lb GVW to 22,000 lb GVW	ASH-1229 ASH-1228 9U94-18045-AA ASH-1205 AT-620 ASH25823 ASH-1022 ASH1022 1C3418045JA ASH-25822 ASH1205 ASH-25823 ASH1228 ASH1229 AT620 1C34-18045-JA AT766 9U9Z18124A ASH294 1C3418045AA 1C34-18045-AA ASH-294 9U9418045AA 9U9Z-18124-A ASH25822 AT-766	83209
		9U9Z18125A ASH-1206 ASH137 AT-621 ASH-25824 ASH-1023 ASH25824 ASH-1230 9U9418080AA ASH1230 ASH1023 9U94-18080-AA 9U9Z-18125-A AT621 ASH1206 ASH-137		83122 89406
05-08	MotorHomes with Ford F53 Chassis with 16,000 lb GVW to 22,000 lb GVW	ASH-1229 ASH-1228 9U94-18045-AA ASH-1205 AT-620 ASH25823 ASH-1022 ASH1022 1C3418045JA ASH-25822 ASH1205 ASH-25823 ASH1228 ASH1229 AT620 1C34-18045-JA AT766 9U9Z18124A ASH294 1C3418045AA 1C34-18045-AA ASH-294 9U9418045AA 9U9Z-18124-A ASH25822 AT-766	83209
		9U9Z18125A ASH-1206 ASH137 AT-621 ASH-25824 ASH-1023 ASH25824 ASH-1230 9U9418080AA ASH1230 ASH1023 9U94-18080-AA 9U9Z-18125-A AT621 ASH1206 ASH-137		83122 89406

APPLICATION GUIDE

Year	Fitment Notes	OEM#								
			Fleetline\ Gas SLX	Classic\ Ultra\ ProGuard\ Guardian	Max Control\ LTV Severe Duty\ Load Carrier	Steering Dampers\ Steering Stabilizer\ Cab Shock	Fleetline\ Gas SLX	Classic\ Ultra\ ProGuard\ Guardian	Max Control\ LTV Severe Duty\ Load Carrier\ HiJackers	Steering Dampers\ Steering Stabilizer\ Cab Shock

THOR MOTOR COACH CHATEAU

THOR MOTOR COACH

11-24	MotorHomes with Ford E350 or E450 Chassis	ASH1154 8C2418045DA 8C2Z-18124-D 8C2Z18124D 8C24-18045-DA ASH-1154 AT163G AT-163G	 O	G63622	58622 77614	 O
		8C24-18080-DB 8C2Z18125D ASH-1136 8C2Z-18125-D AT164G 8C2418080DB ASH1136 AT-164G	 O	G63623	58623 77623	
99-10	MotorHomes with Ford E350 or E450 Chassis	8C24-18080-DB 8C2Z18125D ASH-1136 8C2Z-18125-D AT164G 8C2418080DB ASH1136 AT-164G	 O	 O	G63623



CHATEAU CITATION

13	MotorHomes with Ford E350 or E450 Chassis	8C24-18080-DB 8C2Z18125D ASH-1136 8C2Z-18125-D AT164G 8C2418080DB ASH1136 AT-164G	 O	 O	G63623
11-12	MotorHomes with Ford E350 or E450 Chassis	ASH1154 8C2418045DA 8C2Z-18124-D 8C2Z18124D 8C24-18045-DA ASH-1154 AT163G AT-163G	 O	G63622	58622 77614	 O
		8C24-18080-DB 8C2Z18125D ASH-1136 8C2Z-18125-D AT164G 8C2418080DB ASH1136 AT-164G	 O	G63623	58623 77623	
08-10	MotorHomes with Ford E350 or E450 Chassis	8C24-18080-DB 8C2Z18125D ASH-1136 8C2Z-18125-D AT164G 8C2418080DB ASH1136 AT-164G	 O	 O	G63623

CITATION

12-16	MotorHomes with Ford E350 or E450 Chassis	ASH1154 8C2418045DA 8C2Z-18124-D 8C2Z18124D 8C24-18045-DA ASH-1154 AT163G AT-163G	 O	G63622	58622 77614	 O
		8C24-18080-DB 8C2Z18125D ASH-1136 8C2Z-18125-D AT164G 8C2418080DB ASH1136 AT-164G	 O	G63623	58623 77623	

APPLICATION GUIDE

Year	Fitment Notes	OEM#								
			Fleetline\ Gas SLX	Classic\ Ultra\ ProGuard\ Guardian	Max Control\ LTV Severe Duty\ Load Carrier	Steering Dampers\ Steering Stabilizer\ Cab Shock	Fleetline\ Gas SLX	Classic\ Ultra\ ProGuard\ Guardian	Max Control\ LTV Severe Duty\ Load Carrier\ HiJackers	Steering Dampers\ Steering Stabilizer\ Cab Shock

THOR MOTOR COACH

THOR MOTOR COACH

CITATION (cont)

01-11	MotorHomes with Ford E350 or E450 Chassis	8C24-18080-DB 8C2Z18125D ASH-1136 8C2Z-18125-D AT164G 8C2418080DB ASH1136 AT-164G	 O	G63623
-------	---	--	------	------	------	------	-------	------	--------	------	------





CLASS A MOTORHOMES

06	Astoria Series MotorHomes with Freightliner XC Chassis	16-16874-000 1616874000 1616737000 16-16737-000 141700131810	 O	83160	
		1618103000 16-18103-000 481700000493	 T	85900
		1616873000 16-16873-000 141700131809 1616736000 16-16736-000	 O	85029
	Tuscany Series MotorHomes with Freightliner XC Chassis	16-16874-000 1616874000 1616737000 16-16737-000 141700131810	 O	83160
		1618103000 16-18103-000 481700000493	 T	85900
		1616873000 16-16873-000 141700131809 1616736000 16-16736-000	 O	85029
02-05	Escaper Series MotorHomes with Freightliner XC Chassis	16-16874-000 1616874000 1616737000 16-16737-000 141700131810	 O	83160	
		1618103000 16-18103-000 481700000493	 T	85900	
		1616873000 16-16873-000 141700131809 1616736000 16-16736-000	 O	85029
	UltraSport Series MotorHomes with Freightliner XC Chassis	16-16874-000 1616874000 1616737000 16-16737-000 141700131810	 O	83160
		1618103000 16-18103-000 481700000493	 T	85900
		1616873000 16-16873-000 141700131809 1616736000 16-16736-000	 O	85029

ECHOLON

22-24	MotorHomes with Ford E350 or E450 Chassis	ASH1154 8C2418045DA 8C2Z-18124-D 8C2Z18124D 8C24-18045-DA ASH-1154	 O	G63622	58622 77614
		8C24-18080-DB 8C2Z18125D ASH-1136 8C2Z-18125-D 8C2418080DB ASH1136	 O	G63623	58623 77623

APPLICATION GUIDE

Year	Fitment Notes	OEM#								
			 Fleetline\ Gas SLX	Classic\ Ultra\ ProGuard\ Guardian	Max Control\ LTV Severe Duty\ Load Carrier	Steering Dampers\ Steering Stabilizer\ Cab Shock	 Fleetline\ Gas SLX	Classic\ Ultra\ ProGuard\ Guardian	Max Control\ LTV Severe Duty\ Load Carrier\ HiJackers	Steering Dampers\ Steering Stabilizer\ Cab Shock

THOR MOTOR COACH FOUR WINDS



THOR MOTOR COACH

11-24	MotorHomes with Ford E350 or E450 Chassis	ASH1154 8C2418045DA 8C2Z-18124-D 8C2Z18124D 8C24-18045-DA ASH-1154 AT163G AT-163G	 O	G63622	58622 77614
		8C24-18080-DB 8C2Z18125D ASH-1136 8C2Z-18125-D AT164G 8C2418080DB ASH1136 AT-164G	G63623	58623 77623
01-10	MotorHomes with Ford E350 or E450 Chassis	8C24-18080-DB 8C2Z18125D ASH-1136 8C2Z-18125-D AT164G 8C2418080DB ASH1136 AT-164G	 O	G63623



FREEDOM ELITE

12-23	MotorHomes with Ford E350 or E450 Chassis	ASH1154 8C2418045DA 8C2Z-18124-D 8C2Z18124D 8C24-18045-DA ASH-1154 AT163G AT-163G	 O	G63622	58622 77614
		8C24-18080-DB 8C2Z18125D ASH-1136 8C2Z-18125-D AT164G 8C2418080DB ASH1136 AT-164G	G63623	58623 77623
10-11	MotorHomes with Ford E350 or E450 Chassis	8C24-18080-DB 8C2Z18125D ASH-1136 8C2Z-18125-D AT164G 8C2418080DB ASH1136 AT-164G	 O	G63623

GEMINI

19-22	MotorHomes with Ford Transit-350 Chassis			G57816 ⁴⁰		G64177
-------	--	--	---	------	----------------------	------	------	---	------	--------	------	------

APPLICATION GUIDE

Year	Fitment Notes	OEM#								
			Fleetline\ Gas SLX	Classic\ Ultra\ ProGuard\ Guardian	Max Control\ LTV Severe Duty\ Load Carrier	Steering Dampers\ Steering Stabilizer\ Cab Shock	Fleetline\ Gas SLX	Classic\ Ultra\ ProGuard\ Guardian	Max Control\ LTV Severe Duty\ Load Carrier\ HiJackers	Steering Dampers\ Steering Stabilizer\ Cab Shock



THOR MOTOR COACH

THOR MOTOR COACH

HURRICANE

11-24	MotorHomes with Ford F53 Chassis with 16,000 lb GVW to 22,000 lb GVW	ASH-1229 ASH-1228 9U94-18045-AA ASH-1205 AT-620 ASH25823 ASH-1022 ASH1022 1C3418045JA ASH-25822 ASH1205 ASH-25823 ASH1228 ASH1229 AT620 1C34-18045-JA AT766 9U9Z18124A ASH294 1C3418045AA 1C34-18045-AA ASH-294 9U9418045AA 9U9Z-18124-A ASH25822 AT-766	83209
		9U9Z18125A ASH-1206 ASH137 AT-621 ASH-25824 ASH-1023 ASH25824 ASH-1230 9U9418080AA ASH1230 ASH1023 9U94-18080-AA 9U9Z-18125-A AT621 ASH1206 ASH-137	83122 89406
04-10	MotorHomes with Ford F53 Chassis with 16,000 lb GVW to 22,000 lb GVW	ASH-1229 ASH-1228 9U94-18045-AA ASH-1205 AT-620 ASH25823 ASH-1022 ASH1022 1C3418045JA ASH-25822 ASH1205 ASH-25823 ASH1228 ASH1229 AT620 1C34-18045-JA AT766 9U9Z18124A ASH294 1C3418045AA 1C34-18045-AA ASH-294 9U9418045AA 9U9Z-18124-A ASH25822 AT-766	83209
		9U9Z18125A ASH-1206 ASH137 AT-621 ASH-25824 ASH-1023 ASH25824 ASH-1230 9U9418080AA ASH1230 ASH1023 9U94-18080-AA 9U9Z-18125-A AT621 ASH1206 ASH-137	83122 89406

APPLICATION GUIDE

Year	Fitment Notes	OEM#								
			Fleetline\ Gas SLX	Classic\ Ultra\ ProGuard\ Guardian	Max Control\ LTV Severe Duty\ Load Carrier	Steering Dampers\ Steering Stabilizer\ Cab Shock	Fleetline\ Gas SLX	Classic\ Ultra\ ProGuard\ Guardian	Max Control\ LTV Severe Duty\ Load Carrier\ HiJackers	Steering Dampers\ Steering Stabilizer\ Cab Shock

THOR MOTOR COACH

THOR MOTOR COACH

INDIGO

23-24	MotorHomes with Ford F53 Chassis with 16,000 lb GVW to 22,000 lb GVW	9U94-18045-AA 9U9Z18124A 9U9418045AA 9U9Z-18124-A ASH25822 ASH-25822 ASH25823 ASH-25823	83209
		9U9Z18125A 9U94-18080-AA ASH-25824 9U9Z-18125-A ASH25824 9U9418080AA	83122 89406

LUMINATE

23-24	MotorHomes with Ford F53 Chassis with 16,000 lb GVW to 22,000 lb GVW	9U94-18045-AA 9U9Z18124A 9U9418045AA 9U9Z-18124-A ASH25822 ASH-25822 ASH25823 ASH-25823	83209
		9U9Z18125A 9U94-18080-AA ASH-25824 9U9Z-18125-A ASH25824 9U9418080AA	83122 89406



MAGNITUDE

19-23	Models with Ford F-550 Chassis (4WD and OEM number)	ASH-85927 LC3Z-18125-W ASH-866127 ASH-866139 LC3Z-18125-J HC3Z-18125-EP HC3Z-18125-X ASH-85789	77986
	Models with Ford F-550 Chassis (RWD and OEM number)	ASH-25770 HC3Z-18125-ED HC3Z-18125-EE HC3Z-18125-B ASH-85857 ASH-85856	77987

MIRAMAR

14-24	MotorHomes with Ford F53 Chassis with 16,000 lb GVW to 22,000 lb GVW	ASH-1229 ASH-1228 9U94-18045-AA ASH-1205 AT-620 ASH25823 ASH-1022 ASH1022 1C3418045JA ASH-25822 ASH1205 ASH-25823 ASH1228 ASH1229 AT620 1C34-18045-JA AT766 9U9Z18124A ASH294 1C3418045AA 1C34-18045-AA ASH-294 9U9418045AA 9U9Z-18124-A ASH25822 AT-766	83209
-------	--	---	-------	------	------	------	------	------	------	------

APPLICATION GUIDE

Year	Fitment Notes	OEM#								
			Fleetline\ Gas SLX	Classic\ Ultra\ ProGuard\ Guardian	Max Control\ LTV Severe Duty\ Load Carrier	Steering Dampers\ Steering Stabilizer\ Cab Shock	Fleetline\ Gas SLX	Classic\ Ultra\ ProGuard\ Guardian	Max Control\ LTV Severe Duty\ Load Carrier\ HiJackers	Steering Dampers\ Steering Stabilizer\ Cab Shock

THOR MOTOR COACH

THOR MOTOR COACH

MIRAMAR (cont)

14-24	MotorHomes with Ford F53 Chassis with 16,000 lb GVW to 22,000 lb GVW	9U9Z18125A ASH-1206 ASH137 AT-621 ASH-25824 ASH-1023 ASH25824 ASH-1230 9U9418080AA ASH1230 ASH1023 9U94-18080-AA 9U9Z-18125-A AT621 ASH1206 ASH-137	83122 89406
-------	--	--	------	------	------	------	----------------	------	------	------





OMNI

19-23	Models with Ford F-550 Chassis (4WD and OEM number)	ASH-85927 LC3Z-18125-W ASH-866127 ASH-866139 LC3Z-18125-J HC3Z-18125-EP HC3Z-18125-X ASH-85789	77986
	Models with Ford F-550 Chassis (RWD and OEM number)	ASH-25770 HC3Z-18125-ED HC3Z-18125-EE HC3Z-18125-B ASH-85857 ASH-85856	77987

OUTLAW

11-24	MotorHomes with Ford F53 Chassis with 24,000 lb GVW to 26,000 lb GVW	ASH1161 ASH25821 ASH-25821 ASH-1161	85006
24	MotorHomes with Ford F53 Chassis with 24,000 lb GVW to 26,000 lb GVW	ASH25820 ASH1162 ASH-25820 ASH-1162	89430
11-23	MotorHomes with Ford E350 or E450 Chassis	ASH1154 8C2418045DA 8C2Z-18124-D 8C2Z18124D 8C24-18045-DA ASH-1154 AT163G AT-163G	G63622	58622 77614
		8C24-18080-DB 8C2Z18125D ASH-1136 8C2Z-18125-D AT164G 8C2418080DB ASH1136 AT-164G	G63623	58623 77623
	MotorHomes with Ford F53 Chassis with 16,000 lb GVW to 22,000 lb GVW	ASH-1229 ASH-1228 9U94-18045-AA ASH-1205 AT-620 ASH25823 ASH-1022 ASH1022 1C3418045JA ASH-25822 ASH1205 ASH-25823 ASH1228 ASH1229 AT620 1C34-18045-JA AT766 9U9Z18124A ASH294 1C3418045AA 1C34-18045-AA ASH-294 9U9418045AA 9U9Z-18124-A ASH25822 AT-766	83209

APPLICATION GUIDE

Year	Fitment Notes	OEM#								
			 Fleetline\ Gas SLX	Classic\ Ultra\ ProGuard\ Guardian	Max Control\ LTV Severe Duty\ Load Carrier	Steering Dampers\ Steering Stabilizer\ Cab Shock	 Fleetline\ Gas SLX	Classic\ Ultra\ ProGuard\ Guardian	Max Control\ LTV Severe Duty\ Load Carrier\ HiJackers	Steering Dampers\ Steering Stabilizer\ Cab Shock

THOR MOTOR COACH

THOR MOTOR COACH



OUTLAW (cont)

11-23	MotorHomes with Ford F53 Chassis with 16,000 lb GVW to 22,000 lb GVW	9U9Z18125A ASH-1206 ASH137 AT-621 ASH-25824 ASH-1023 ASH25824 ASH-1230 9U9418080AA ASH1230 ASH1023 9U94-18080-AA 9U9Z-18125-A AT621 ASH1206 ASH-137	83122 89406
	MotorHomes with Ford F53 Chassis with 24,000 lb GVW to 26,000 lb GVW	ASH25820 ASH1162 ASH-25820 ASH-1162	85005 89430
07-10	MotorHomes with Ford F53 Chassis with 16,000 lb GVW to 22,000 lb GVW	ASH-1229 ASH-1228 9U94-18045-AA ASH-1205 AT-620 ASH25823 ASH-1022 ASH1022 1C3418045JA ASH-25822 ASH1205 ASH-25823 ASH1228 ASH1229 AT620 1C34-18045-JA AT766 9U9Z18124A ASH294 1C34-18045AA 1C34-18045-AA ASH-294 9U9418045AA 9U9Z-18124-A ASH25822 AT-766	83209
	MotorHomes with Ford F53 Chassis with 24,000 lb GVW to 26,000 lb GVW	9U9Z18125A ASH-1206 ASH137 AT-621 ASH-25824 ASH-1023 ASH25824 ASH-1230 9U9418080AA ASH1230 ASH1023 9U94-18080-AA 9U9Z-18125-A AT621 ASH1206 ASH-137	83122 89406

QUANTUM

16-24	MotorHomes with Ford E350 or E450 Chassis	ASH1154 8C2418045DA 8C2Z-18124-D 8C2Z18124D 8C24-18045-DA ASH-1154 AT163G AT-163G	G63622	58622 77614
	MotorHomes with Ford E350 or E450 Chassis	8C24-18080-DB 8C2Z18125D ASH-1136 8C2Z-18125-D AT164G 8C2418080DB ASH1136 AT-164G	G63623	58623 77623

APPLICATION GUIDE

Year	Fitment Notes	OEM#								
			Fleetline\ Gas SLX	Classic\ Ultra\ ProGuard\ Guardian	Max Control\ LTV Severe Duty\ Load Carrier	Steering Dampers\ Steering Stabilizer\ Cab Shock	Fleetline\ Gas SLX	Classic\ Ultra\ ProGuard\ Guardian	Max Control\ LTV Severe Duty\ Load Carrier\ HiJackers	Steering Dampers\ Steering Stabilizer\ Cab Shock

THOR MOTOR COACH

THOR MOTOR COACH

RESONATE

23-24	MotorHomes with Ford F53 Chassis with 16,000 lb GVW to 22,000 lb GVW	9U94-18045-AA 9U9Z18124A 9U9418045AA 9U9Z-18124-A ASH25822 ASH-25822 ASH25823 ASH-25823	83209	OIO
		9U9Z18125A 9U94-18080-AA ASH-25824 9U9Z-18125-A ASH25824 9U9418080AA	OIO	83122 89406



VEGAS

14-24	MotorHomes with Ford E350 or E450 Chassis	ASH1154 8C2418045DA 8C2Z-18124-D 8C2Z18124D 8C24-18045-DA ASH-1154 AT163G AT-163G	G63622	58622 77614	OIO
		8C24-18080-DB 8C2Z18125D ASH-1136 8C2Z-18125-D AT164G 8C2418080DB ASH1136 AT-164G	OIO	G63623	58623 77623

WINDSPORT

11-24	MotorHomes with Ford F53 Chassis with 16,000 lb GVW to 22,000 lb GVW	ASH-1229 ASH-1228 9U94-18045-AA ASH-1205 AT-620 ASH25823 ASH-1022 ASH1022 1C3418045JA ASH-25822 ASH1205 ASH-25823 ASH1228 ASH1229 AT620 1C34-18045-JA AT766 9U9Z18124A ASH294 1C3418045AA 1C34-18045-AA ASH-294 9U9418045AA 9U9Z-18124-A ASH25822 AT-766	83209	OIO
		9U9Z18125A ASH-1206 ASH137 AT-621 ASH-25824 ASH-1023 ASH25824 ASH-1230 9U9418080AA ASH1230 ASH1023 9U94-18080-AA 9U9Z-18125-A AT621 ASH1206 ASH-137	OIO	83122 89406

APPLICATION GUIDE

Year	Fitment Notes	OEM#								
			Fleetline\ Gas SLX	Classic\ Ultra\ ProGuard\ Guardian	Max Control\ LTV Severe Duty\ Load Carrier	Steering Dampers\ Steering Stabilizer\ Cab Shock	Fleetline\ Gas SLX	Classic\ Ultra\ ProGuard\ Guardian	Max Control\ LTV Severe Duty\ Load Carrier\ HiJackers	Steering Dampers\ Steering Stabilizer\ Cab Shock

THOR MOTOR COACH

THOR MOTOR COACH

WINDSPORT (cont)

06-10	MotorHomes with Ford F53 Chassis with 16,000 lb GVW to 22,000 lb GVW	ASH-1229 ASH-1228 9U94-18045-AA ASH-1205 AT-620 ASH25823 ASH-1022 ASH1022 1C3418045JA ASH-25822 ASH1205 ASH-25823 ASH1228 ASH1229 AT620 1C34-18045-JA AT766 9U9Z18124A ASH294 1C3418045AA 1C34-18045-AA ASH-294 9U9418045AA 9U9Z-18124-A ASH25822 AT-766	83209				
		O	O	O	O	O	O	O	O	O
		9U9Z18125A ASH-1206 ASH137 AT-621 ASH-25824 ASH-1023 ASH25824 ASH-1230 9U9418080AA ASH1230 ASH1023 9U94-18080-AA 9U9Z-18125-A AT621 ASH1206 ASH-137					
			O	O	O	O	O	O	O	O

TURTLETOP BUS

TURTLETOP BUS

VARIOUS

	Odyssey Series Shuttle buses with Ford E450 Chassis	ASH-1154	I O	G63622	58622 77614			
		ASH-1136	O	O	O	O	O	O	O	O
	Terra Transit Series Shuttle buses with Ford E350 & E450 Chassis	ASH-1154	I O	O	O	O	O	O	O	O
		ASH-1136	O	O	O	O	O	O	O	O
	Vanterra Series Shuttle buses with Ford E350 Chassis	ASH-1154	I O	O	O	O	O	O	O	O
		ASH-1136	O	O	O	O	O	O	O	O

UD

UD



550T

89-91	Models with O.E.M. Number	56110-Z5014 56101Z5014 56110-Z5017 56110Z5017 56101Z5017 56101-Z5014 56110Z5014 56101-Z5017	83162				
		O	O	O	O	O	O	O	O	O

600T

92-94	Models with O.E.M. Number	56110-Z5014 56101Z5014 56110-Z5017 56110Z5017 56101Z5017 56101-Z5014 56110Z5014 56101-Z5017	83162				
		O	O	O	O	O	O	O	O	O

APPLICATION GUIDE

Year	Fitment Notes	OEM#								
			Fleetline\ Gas SLX	Classic\ Ultra\ ProGuard\ Guardian	Max Control\ LTV Severe Duty\ Load Carrier	Steering Dampers\ Steering Stabilizer\ Cab Shock	Fleetline\ Gas SLX	Classic\ Ultra\ ProGuard\ Guardian	Max Control\ LTV Severe Duty\ Load Carrier\ HiJackers	Steering Dampers\ Steering Stabilizer\ Cab Shock

UD

UD

1200

99-04	Models with O.E.M. Number	E61000T825 561000T825	 ○	83515
-------	---------------------------	--------------------------	-------	-------	------	------	------	------	------	------	------

1300

05-07	Models with O.E.M. Number	E61000T825 561000T825	 ○	83515
-------	---------------------------	--------------------------	-------	-------	------	------	------	------	------	------	------

1400

94-10	Models with O.E.M. Number	E61000T825 561000T825	 ○	83515
-------	---------------------------	--------------------------	-------	-------	------	------	------	------	------	------	------

1800

89-94	Models with O.E.M. Number	56101-Z5008 56110-Z5008 56110Z5008 56101Z5008	 ○	83114
-------	---------------------------	--	-------	-------	------	------	------	------	------	------	------

1800CS

99-04	Models with O.E.M. Number	56101-Z5008 56110-Z5008 56110Z5008 56101Z5008	 ○	83114
-------	---------------------------	--	-------	-------	------	------	------	------	------	------	------

2000

89-94	Models with O.E.M. Number	56101-Z5008 56110-Z5008 56110Z5008 56101Z5008	 ○	83114
-------	---------------------------	--	-------	-------	------	------	------	------	------	------	------

2600

89-13	Models with O.E.M. Number	56110-Z5014 56101Z5014 56110-Z5017 56110Z5017 56101Z5017 56101-Z5014 56110Z5014 56101-Z5017	 ○	83162
-------	---------------------------	--	-------	-------	------	------	------	------	------	------	------

UD 18HD SERIES

99-10	Models with 22.5" Tires	56110-30Z02 56101-30Z02	 ○	G63610
-------	-------------------------	----------------------------	-------	------	--------	------	------	------	------	------	------

UD 1300

	UD 1300 Models Steer Axle	56110T8129 66400 56110-T8123 56110-T8129 56110T8123	 ○	G63432
--	---------------------------	---	-------	------	--------	------	------	------	------	------	------

UD 1800 SERIES

11-13	Models with 22.5" Tires	56110-30Z02 56101-30Z02	 ○	G63610
95-98	Models with 22.5" Tires	56110-30Z02 56101-30Z02	 ○	G63610

UD 2000 SERIES

95-13	Models with 22.5" Tires	56110-30Z02 56101-30Z02	 ○	G63610
-------	-------------------------	----------------------------	-------	------	--------	------	------	------	------	------	------

UPS TRUCK

UPS TRUCK

VARIOUS



	Models with O.E.M. Number	P117099	 ○	83120
--	---------------------------	---------	-------	------	------	------	------	-------	------	------	------

WHEELED COACH IND.

WHEELED COACH IND.

	Citimedic models with Ford E350 & E450 Chassis	ASH1154 ASH-1154	 ○	G63622	58622 77614
	Citimedic models with Ford E350 & E450 Chassis	ASH-1136 ASH1136	 ○	G63623	58623 77623

APPLICATION GUIDE

Year	Fitment Notes	OEM#								
			Fleetline\ Gas SLX	Classic\ Ultra\ ProGuard\ Guardian	Max Control\ LTV Severe Duty\ Load Carrier	Steering Dampers\ Steering Stabilizer\ Cab Shock	Fleetline\ Gas SLX	Classic\ Ultra\ ProGuard\ Guardian	Max Control\ LTV Severe Duty\ Load Carrier\ HiJackers	Steering Dampers\ Steering Stabilizer\ Cab Shock

WINNEBAGO

WINNEBAGO

ACCESS

07-13	MotorHomes with Ford E350 or E450 Chassis	ASH1154 8C2418045DA 8C2Z-18124-D 8C2Z18124D 8C24-18045-DA ASH-1154 AT163G AT-163G	 O		G63622	58622 77614								
		8C24-18080-DB 8C2Z18125D ASH-1136 8C2Z-18125-D AT164G 8C2418080DB ASH1136 AT-164G	 O									G63623	58623 77623	

ACCESS PREMIER

14	MotorHomes with Ford E350 or E450 Chassis	ASH1154 8C2418045DA 8C2Z-18124-D 8C2Z18124D 8C24-18045-DA ASH-1154 AT163G AT-163G	 O		G63622	58622 77614								
		8C24-18080-DB 8C2Z18125D ASH-1136 8C2Z-18125-D AT164G 8C2418080DB ASH1136 AT-164G	 O									G63623	58623 77623	

ADVENTURER

19-23	Motorhomes with Ford F-53 Chassis with 16,000 lb GVW to 22,000 lb GVW	9U9Z18125A ASH-1206 ASH137 9U9Z18125B AT-621 ASH-25825 ASH-25824 ASH25825 ASH-1023 ASH25824 ASH-1230 9U9418080AA HU9Z-18125-B ASH1230 ASH1023 9U94-18080-AA 9U9Z-18125-B 9U9Z-18125-A AT621 ASH1206 ASH-137 HU9Z18125B	 O											
		MotorHomes with Ford F53 Chassis with 16,000 lb GVW to 22,000 lb GVW	ASH-1229 ASH-1228 9U94-18045-AA ASH-1205 AT-620 ASH25823 ASH-1022 ASH1022 1C3418045JA ASH-25822 ASH1205 ASH-25823 ASH1228 ASH1229 AT620 1C34-18045-JA AT766 9U9Z18124A ASH294 1C3418045AA 1C34-18045-AA ASH-294 9U9418045AA 9U9Z-18124-A ASH25822 AT-766	 O		83209								

APPLICATION GUIDE

Year	Fitment Notes	OEM#								
			Fleetline\ Gas SLX	Classic\ Ultra\ ProGuard\ Guardian	Max Control\ LTV Severe Duty\ Load Carrier	Steering Dampers\ Steering Stabilizer\ Cab Shock	Fleetline\ Gas SLX	Classic\ Ultra\ ProGuard\ Guardian	Max Control\ LTV Severe Duty\ Load Carrier\ HiJackers	Steering Dampers\ Steering Stabilizer\ Cab Shock





WINNEBAGO

WINNEBAGO

ADVENTURER (cont)

19-23	MotorHomes with Ford F53 Chassis with 24,000 lb GVW to 26,000 lb GVW	ASH1161 ASH25821 ASH-25821 ASH-1161 ASH25820 ASH1162 ASH-25820 ASH-1162	O O	85006	
08-17	MotorHomes with Ford F53 Chassis with 24,000 lb GVW to 26,000 lb GVW	ASH1161 ASH25821 ASH-25821 ASH-1161 ASH25820 ASH1162 ASH-25820 ASH-1162	O O	85006	85005 89430
06-17	Motorhomes with Ford F-53 Chassis with 16,000 lb GVW to 22,000 lb GVW	9U9Z18125A ASH-1206 ASH137 9U9Z18125B AT-621 ASH-25825 ASH-25824 ASH25825 ASH-1023 ASH25824 ASH-1230 9U9418080AA HU9Z-18125-B ASH1230 ASH1023 9U94-18080-AA 9U9Z-18125-B 9U9Z-18125-A AT621 ASH1206 ASH-137 HU9Z18125B	O O	83122 89406
92-17	MotorHomes with Ford F53 Chassis with 16,000 lb GVW to 22,000 lb GVW	ASH-1229 ASH-1228 9U94-18045-AA ASH-1205 AT-620 ASH25823 ASH-1022 ASH1022 1C3418045JA ASH-25822 ASH1205 ASH-25823 ASH1228 ASH1229 AT620 1C34-18045-JA AT766 9U9Z18124A ASH294 1C3418045AA 1C34-18045-AA ASH-294 9U9418045AA 9U9Z-18124-A ASH25822 AT-766	O O	83209
98-11	Models with W20 & W22 Workhorse Motorhome Chassis	24-153249 F4-BE5-B492-HO W0005662 W0006254 24153249 24-186629 F4-BE5-A832-MO F4BE5A832MO F4BE5F324HO F4-BE5-F324-HO 24186629 F4BE5B492HO	O O	85125
04-09	Models with Workhorse W22, & W24 MotorHome Chassis with O.E.M. Number	W0005663 F4-BE5-F325-HO 24-153256	O O	85124

APPLICATION GUIDE

Year	Fitment Notes	OEM#								
			 Fleetline/ Gas SLX	Classic/ Ultra/ ProGuard/ Guardian	Max Control/ LTV Severe Duty/ Load Carrier	Steering Dampers/ Steering Stabilizer/ Cab Shock	 Fleetline/ Gas SLX	Classic/ Ultra/ ProGuard/ Guardian	Max Control/ LTV Severe Duty/ Load Carrier/ HiJackers	Steering Dampers/ Steering Stabilizer/ Cab Shock

WINNEBAGO

WINNEBAGO

ADVENTURER (cont)

99-04	Motorhomes with Ford F-53 Chassis with 16,000 lb GVW to 22,000 lb GVW	9U9Z18125A ASH-1206 ASH137 9U9Z18125B AT-621 ASH-25825 ASH-25824 ASH25825 ASH-1023 ASH25824 ASH-1230 9U9418080AA HU9Z-18125-B ASH1230 ASH1023 9U94-18080-AA 9U9Z-18125-B 9U9Z-18125-A AT621 ASH1206 ASH-137 HU9Z18125B	83122 89406
-------	---	---	-------	-------	-------	-------	----------------	-------	-------	-------



ASPECT

18-20	MotorHomes with Ford E350 or E450 Chassis	ASH1154 8C2418045DA 8C2Z-18124-D 8C2Z18124D 8C24-18045-DA ASH-1154 AT163G AT-163G	G63622	58622 77614
		8C24-18080-DB 8C2Z18125D ASH-1136 8C2Z-18125-D AT164G 8C2418080DB ASH1136 AT-164G	G63623	58623 77623
06-17	MotorHomes with Ford E350 or E450 Chassis	ASH1154 8C2418045DA 8C2Z-18124-D 8C2Z18124D 8C24-18045-DA ASH-1154 AT163G AT-163G	G63622	58622 77614
		8C24-18080-DB 8C2Z18125D ASH-1136 8C2Z-18125-D AT164G 8C2418080DB ASH1136 AT-164G	G63623	58623 77623
05	MotorHomes with Ford E350 or E450 Chassis	8C2418045DA 8C24-18045-DA	G63622	58622 77614

CAMBRIA

18-20	MotorHomes with Ford E350 or E450 Chassis	ASH1154 8C2418045DA 8C2Z-18124-D 8C2Z18124D 8C24-18045-DA ASH-1154 AT163G AT-163G	G63622	58622 77614
		8C24-18080-DB 8C2Z18125D ASH-1136 8C2Z-18125-D AT164G 8C2418080DB ASH1136 AT-164G	G63623	58623 77623

APPLICATION GUIDE

Year	Fitment Notes	OEM#								
			Fleetline\ Gas SLX	Classic\ Ultra\ ProGuard\ Guardian	Max Control\ LTV Severe Duty\ Load Carrier	Steering Dampers\ Steering Stabilizer\ Cab Shock	Fleetline\ Gas SLX	Classic\ Ultra\ ProGuard\ Guardian	Max Control\ LTV Severe Duty\ Load Carrier\ HiJackers	Steering Dampers\ Steering Stabilizer\ Cab Shock

WINNEBAGO

WINNEBAGO

CAMBRIA (cont)

16-17	MotorHomes with Ford E350 or E450 Chassis	ASH1154 8C2418045DA 8C2Z-18124-D 8C2Z18124D 8C24-18045-DA ASH-1154 AT163G AT-163G	 O	G63622	58622 77614	 O
		8C24-18080-DB 8C2Z18125D ASH-1136 8C2Z-18125-D AT164G 8C2418080DB ASH1136 AT-164G	 O	 O	G63623	58623 77623
09-15	MotorHomes with Ford E350 or E450 Chassis	ASH1154 8C2418045DA 8C2Z-18124-D 8C2Z18124D 8C24-18045-DA ASH-1154 AT163G AT-163G	 O	G63622	58622 77614	 O
		8C24-18080-DB 8C2Z18125D ASH-1136 8C2Z-18125-D AT164G 8C2418080DB ASH1136 AT-164G	 O	 O	G63623	58623 77623
05-08	MotorHomes with Ford E350 or E450 Chassis	ASH1154 8C2418045DA 8C2Z-18124-D 8C2Z18124D 8C24-18045-DA ASH-1154 AT163G AT-163G	 O	G63622	58622 77614	 O
		8C24-18080-DB 8C2Z18125D ASH-1136 8C2Z-18125-D AT164G 8C2418080DB ASH1136 AT-164G	 O	 O	G63623	58623 77623



EKKO

21-22	MotorHomes with Ford Transit-350 Chassis		 O	G57816 ⁶⁰	 O	G64177
-------	--	--	-------	------	----------------------	------	------	-------	------	--------	------	------

INTENET

18-20	Motorhome Chassis with 16,000 lb GVW to 18,000 lb GVW	9U9Z18125B 9U9Z-18125-B ASH-25825 ASH25825	 O	 O	83122 89406
	Motorhome Chassis with 20,500 lb GVW to 22,000 lb GVW	9U9Z18125A ASH-1206 ASH137 AT-621 ASH-25824 ASH-1023 ASH25824 ASH-1230 9U9418080AA HU9Z-18125-B ASH1230 ASH1023 9U94-18080-AA 9U9Z-18125-A AT621 ASH1206 ASH-137 HU9Z18125B	 O	 O	83122 89406

APPLICATION GUIDE

Year	Fitment Notes	OEM#								
			Fleetline\ Gas SLX	Classic\ Ultra\ ProGuard\ Guardian	Max Control\ LTV Severe Duty\ Load Carrier	Steering Dampers\ Steering Stabilizer\ Cab Shock	Fleetline\ Gas SLX	Classic\ Ultra\ ProGuard\ Guardian	Max Control\ LTV Severe Duty\ Load Carrier\ HiJackers	Steering Dampers\ Steering Stabilizer\ Cab Shock

WINNEBAGO

WINNEBAGO

INTENET (cont)

18-20	MotorHomes with Ford F53 Chassis with 16,000 lb GVW to 22,000 lb GVW	ASH-1229 ASH-1228 ASH-1205 ASH25823 ASH-1022 ASH294 ASH1022 ASH-294 ASH25822 ASH-25822 ASH1205 ASH-25823 ASH1228 ASH1229	83209
-------	--	---	-------	------	------	------	------	------	------	------



JOURNEY

02-06	MotorHomes with Freightliner XC Chassis and ADL200 Suspension w/ 20K Rear	1616873000 16-16873-000 141700131809 1616736000 16-16736-000	85029
	MotorHomes with Freightliner XC Chassis and AS120 Front Suspension	16-16874-000 1616874000 1616737000 16-16737-000 141700131810	83160

MINNIE

06-20	MotorHomes with Ford E350 or E450 Chassis	ASH1154 8C2418045DA 8C2Z-18124-D 8C2Z18124D 8C24-18045-DA ASH-1154 AT163G AT-163G	G63622	58622 77614
		8C24-18080-DB 8C2Z18125D ASH-1136 8C2Z-18125-D AT164G 8C2418080DB ASH1136 AT-164G	G63623	58623 77623
00-05	MotorHomes with Ford E350 or E450 Chassis	ASH1154 8C2418045DA 8C2Z-18124-D 8C2Z18124D 8C24-18045-DA ASH-1154 AT163G AT-163G	G63622	58622 77614
		8C24-18080-DB 8C2Z18125D ASH-1136 8C2Z-18125-D AT164G 8C2418080DB ASH1136 AT-164G	G63623	58623 77623
99	MotorHomes with Ford E350 or E450 Chassis	ASH1154 8C2418045DA 8C2Z-18124-D 8C2Z18124D 8C24-18045-DA ASH-1154 AT163G AT-163G	G63622	58622 77614
		8C24-18080-DB 8C2Z18125D ASH-1136 8C2Z-18125-D AT164G 8C2418080DB ASH1136 AT-164G	G63623	58623 77623

APPLICATION GUIDE

Year	Fitment Notes	OEM#								
			Fleetline\ Gas SLX	Classic\ Ultra\ ProGuard\ Guardian	Max Control\ LTV Severe Duty\ Load Carrier	Steering Dampers\ Steering Stabilizer\ Cab Shock	Fleetline\ Gas SLX	Classic\ Ultra\ ProGuard\ Guardian	Max Control\ LTV Severe Duty\ Load Carrier\ HiJackers	Steering Dampers\ Steering Stabilizer\ Cab Shock

WINNEBAGO

MINNIE WINNIE





WINNEBAGO

14-24	MotorHomes with Ford E350 or E450 Chassis	ASH1154 8C2418045DA 8C2Z-18124-D 8C2Z18124D 8C24-18045-DA ASH-1154 AT163G AT-163G	 O		G63622	58622 77614				
		8C24-18080-DB 8C2Z18125D ASH-1136 8C2Z-18125-D AT164G 8C2418080DB ASH1136 AT-164G	 O						G63623	58623 77623
00-06	MotorHomes with Ford E350 or E450 Chassis	ASH1154 8C2418045DA 8C2Z-18124-D 8C2Z18124D 8C24-18045-DA ASH-1154 AT163G AT-163G	 O		G63622	58622 77614				
		8C24-18080-DB 8C2Z18125D ASH-1136 8C2Z-18125-D AT164G 8C2418080DB ASH1136 AT-164G	 O						G63623	58623 77623

OUTLOOK

19-21	MotorHomes with Ford E350 or E450 Chassis	ASH1154 8C2418045DA 8C2Z-18124-D 8C2Z18124D 8C24-18045-DA ASH-1154 AT163G AT-163G	 O		G63622	58622 77614				
		8C24-18080-DB 8C2Z18125D ASH-1136 8C2Z-18125-D AT164G 8C2418080DB ASH1136 AT-164G	 O						G63623	58623 77623
11-18	MotorHomes with Ford E350 or E450 Chassis	ASH1154 8C2418045DA 8C2Z-18124-D 8C2Z18124D 8C24-18045-DA ASH-1154 AT163G AT-163G	 O		G63622	58622 77614				
		8C24-18080-DB 8C2Z18125D ASH-1136 8C2Z-18125-D AT164G 8C2418080DB ASH1136 AT-164G	 O						G63623	58623 77623
06-10	MotorHomes with Ford E350 or E450 Chassis	ASH1154 8C2418045DA 8C2Z-18124-D 8C2Z18124D 8C24-18045-DA ASH-1154 AT163G AT-163G	 O		G63622	58622 77614				
		8C24-18080-DB 8C2Z18125D ASH-1136 8C2Z-18125-D AT164G 8C2418080DB ASH1136 AT-164G	 O						G63623	58623 77623

APPLICATION GUIDE

Year	Fitment Notes	OEM#								
			 Fleetline\ Gas SLX	Classic\ Ultra\ ProGuard\ Guardian	Max Control\ LTV Severe Duty\ Load Carrier	Steering Dampers\ Steering Stabilizer\ Cab Shock	 Fleetline\ Gas SLX	Classic\ Ultra\ ProGuard\ Guardian	Max Control\ LTV Severe Duty\ Load Carrier\ HiJackers	Steering Dampers\ Steering Stabilizer\ Cab Shock

WINNEBAGO

WINNEBAGO

SIGHTSEER

11-17	Motorhome Chassis with 16,000 lb GVW to 18,000 lb GVW	9U9Z18125B 9U9Z-18125-B ASH-25825 ASH25825	OO O	83122 89406
	Motorhome Chassis with 20,500 lb GVW to 22,000 lb GVW	9U9Z18125A ASH-1206 ASH137 AT-621 ASH-25824 ASH-1023 ASH25824 ASH-1230 9U9418080AA HU9Z-18125-B ASH1230 ASH1023 9U94-18080-AA 9U9Z-18125-A AT621 ASH1206 ASH-137 HU9Z18125B	OO O	83122 89406
02-17	MotorHomes with Ford F53 Chassis with 16,000 lb GVW to 22,000 lb GVW	ASH-1229 ASH-1228 9U94-18045-AA ASH-1205 AT-620 ASH25823 ASH-1022 ASH1022 1C3418045JA ASH-25822 ASH1205 ASH-25823 ASH1228 ASH1229 AT620 1C34-18045-JA AT766 9U9Z18124A ASH294 1C3418045AA 1C34-18045-AA ASH-294 9U9418045AA 9U9Z-18124-A ASH25822 AT-766	83209	OO
08-09	Motorhome Chassis with 16,000 lb GVW to 18,000 lb GVW	9U9Z18125B 9U9Z-18125-B ASH-25825 ASH25825	OO O	83122 89406
06-09	Motorhome Chassis with 20,500 lb GVW to 22,000 lb GVW	9U9Z18125A ASH-1206 ASH137 AT-621 ASH-25824 ASH-1023 ASH25824 ASH-1230 9U9418080AA HU9Z-18125-B ASH1230 ASH1023 9U94-18080-AA 9U9Z-18125-A AT621 ASH1206 ASH-137 HU9Z18125B	OO O	83122 89406

APPLICATION GUIDE

Year	Fitment Notes	OEM#								
			Fleetline\ Gas SLX	Classic\ Ultra\ ProGuard\ Guardian	Max Control\ LTV Severe Duty\ Load Carrier	Steering Dampers\ Steering Stabilizer\ Cab Shock	Fleetline\ Gas SLX	Classic\ Ultra\ ProGuard\ Guardian	Max Control\ LTV Severe Duty\ Load Carrier\ HiJackers	Steering Dampers\ Steering Stabilizer\ Cab Shock

WINNEBAGO

WINNEBAGO





SIGHTSEER (cont)

02-04	Motorhome Chassis with 20,500 lb GVW to 22,000 lb GVW	9U9Z18125A ASH-1206 ASH137 AT-621 ASH-25824 ASH-1023 ASH25824 ASH-1230 9U9418080AA HU9Z-18125-B ASH1230 ASH1023 9U94-18080-AA 9U9Z-18125-A AT621 ASH1206 ASH-137 HU9Z18125B	O O	83122 89406
-------	---	--	------	------	------	------	--------	----------------	------	------	------

SPIRIT

16-22	MotorHomes with Ford E350 or E450 Chassis	ASH1154 8C2418045DA 8C2Z-18124-D 8C2Z18124D 8C24-18045-DA ASH-1154 AT163G AT-163G	G63622	58622 77614	I O
		8C24-18080-DB 8C2Z18125D ASH-1136 8C2Z-18125-D AT164G 8C2418080DB ASH1136 AT-164G	I O	G63623	58623 77623
08-15	MotorHomes with Ford E350 or E450 Chassis	ASH1154 8C2418045DA 8C2Z-18124-D 8C2Z18124D 8C24-18045-DA ASH-1154 AT163G AT-163G	G63622	58622 77614	I O
		8C24-18080-DB 8C2Z18125D ASH-1136 8C2Z-18125-D AT164G 8C2418080DB ASH1136 AT-164G	I O	G63623	58623 77623
04-07	MotorHomes with Ford E350 or E450 Chassis	ASH1154 8C2418045DA 8C2Z-18124-D 8C2Z18124D 8C24-18045-DA ASH-1154 AT163G AT-163G	G63622	58622 77614	I O
		8C24-18080-DB 8C2Z18125D ASH-1136 8C2Z-18125-D AT164G 8C2418080DB ASH1136 AT-164G	I O	G63623	58623 77623
03	MotorHomes with Ford E350 or E450 Chassis	8C2418045DA 8C2Z-18124-D 8C2Z18124D 8C24-18045-DA ASH-1154 AT163G AT-163G	G63622	58622 77614	I O
		8C24-18080-DB 8C2Z18125D ASH-1136 8C2Z-18125-D 8C2418080DB ASH1136 AT-164G	I O	G63623	58623 77623

APPLICATION GUIDE

Year	Fitment Notes	OEM#								
			 Fleetline\ Gas SLX	Classic\ Ultra\ ProGuard\ Guardian	Max Control\ LTV Severe Duty\ Load Carrier	Steering Dampers\ Steering Stabilizer\ Cab Shock	 Fleetline\ Gas SLX	Classic\ Ultra\ ProGuard\ Guardian	Max Control\ LTV Severe Duty\ Load Carrier\ HiJackers	Steering Dampers\ Steering Stabilizer\ Cab Shock

WINNEBAGO

WINNEBAGO



SPIRIT (cont)

00-02	MotorHomes with Ford E350 or E450 Chassis	ASH-1154 8C2418045DA 8C2Z-18124-D 8C2Z18124D 8C24-18045-DA ASH-1154 AT163G AT-163G	 O	G63622	58622 77614
		8C24-18080-DB 8C2Z18125D ASH-1136 8C2Z-18125-D AT164G 8C2418080DB ASH1136 AT-164G		 O	G63623	58623 77623

SUNOVA

16-17	Motorhome Chassis with 16,000 lb GVW to 18,000 lb GVW	9U9Z18125B 9U9Z-18125-B ASH-25825 ASH25825	 O	 O	83122 89406
	Motorhome Chassis with 20,500 lb GVW to 22,000 lb GVW	9U9Z18125A ASH-1206 ASH137 AT-621 ASH-25824 ASH-1023 ASH25824 ASH-1230 9U9418080AA HU9Z-18125-B ASH1230 ASH1023 9U94-18080-AA 9U9Z-18125-A AT621 ASH1206 ASH-137 HU9Z18125B		 O	83122 89406
	MotorHomes with Ford F53 Chassis with 16,000 lb GVW to 22,000 lb GVW	ASH-1229 ASH-1228 9U94-18045-AA ASH-1205 AT-620 ASH25823 ASH-1022 ASH1022 1C3418045JA ASH-25822 ASH1205 ASH-25823 ASH1228 ASH1229 AT620 1C34-18045-JA AT766 9U9Z18124A ASH294 1C3418045AA 1C34-18045-AA ASH-294 9U9418045AA 9U9Z-18124-A ASH25822 AT-766	 O	83209
06-07	Motorhome Chassis with 20,500 lb GVW to 22,000 lb GVW	9U9Z18125A ASH-1206 ASH137 AT-621 ASH-25824 ASH-1023 ASH25824 ASH-1230 9U9418080AA HU9Z-18125-B ASH1230 ASH1023 9U94-18080-AA 9U9Z-18125-A AT621 ASH1206 ASH-137 HU9Z18125B	 O	 O	83122 89406

APPLICATION GUIDE

Year	Fitment Notes	OEM#								
			Fleetline\ Gas SLX	Classic\ Ultra\ ProGuard\ Guardian	Max Control\ LTV Severe Duty\ Load Carrier	Steering Dampers\ Steering Stabilizer\ Cab Shock	Fleetline\ Gas SLX	Classic\ Ultra\ ProGuard\ Guardian	Max Control\ LTV Severe Duty\ Load Carrier\ HiJackers	Steering Dampers\ Steering Stabilizer\ Cab Shock

WINNEBAGO

WINNEBAGO





SUNOVA (cont)

02-07	MotorHomes with Ford F53 Chassis with 16,000 lb GVW to 22,000 lb GVW	ASH-1229 ASH-1228 9U94-18045-AA ASH-1205 AT-620 ASH25823 ASH-1022 ASH1022 1C3418045JA ASH-25822 ASH1205 ASH-25823 ASH1228 ASH1229 AT620 1C34-18045-JA AT766 9U9Z18124A ASH294 1C3418045AA 1C34-18045-AA ASH-294 9U9418045AA 9U9Z-18124-A ASH25822 AT-766	83209
02-04	Motorhome Chassis with 20,500 lb GVW to 22,000 lb GVW	9U9Z18125A ASH-1206 ASH137 AT-621 ASH-25824 ASH-1023 ASH25824 ASH-1230 9U9418080AA HU9Z-18125-B ASH1230 ASH1023 9U94-18080-AA 9U9Z-18125-A AT621 ASH1206 ASH-137 HU9Z18125B	83122 89406

SUNSTAR

16-23	MotorHomes with Ford F53 Chassis with 24,000 lb GVW to 26,000 lb GVW	ASH1161 ASH25821 ASH-25821 ASH-1161	85006
16-22	Motorhome Chassis with 16,000 lb GVW to 18,000 lb GVW	9U9Z18125B 9U9Z-18125-B ASH-25825 ASH25825	83122 89406
	Motorhome Chassis with 20,500 lb GVW to 22,000 lb GVW	9U9Z18125A ASH-1206 ASH137 AT-621 ASH-25824 ASH-1023 ASH25824 ASH-1230 9U9418080AA HU9Z-18125-B ASH1230 ASH1023 9U94-18080-AA 9U9Z-18125-A AT621 ASH1206 ASH-137 HU9Z18125B	83122 89406

APPLICATION GUIDE

Year	Fitment Notes	OEM#								
			 Fleetline\ Gas SLX	Classic\ Ultra\ ProGuard\ Guardian	Max Control\ LTV Severe Duty\ Load Carrier	Steering Dampers\ Steering Stabilizer\ Cab Shock	 Fleetline\ Gas SLX	Classic\ Ultra\ ProGuard\ Guardian	Max Control\ LTV Severe Duty\ Load Carrier\ HiJackers	Steering Dampers\ Steering Stabilizer\ Cab Shock

WINNEBAGO

WINNEBAGO



SUNSTAR (cont)

16-22	MotorHomes with Ford F53 Chassis with 16,000 lb GVW to 22,000 lb GVW	ASH-1229 ASH-1228 9U94-18045-AA ASH-1205 AT-620 ASH25823 ASH-1022 ASH1022 1C3418045JA ASH-25822 ASH1205 ASH-25823 ASH1228 ASH1229 AT620 1C34-18045-JA AT766 9U9Z18124A ASH294 1C3418045AA 1C34-18045-AA ASH-294 9U9418045AA 9U9Z-18124-A ASH25822 AT-766	83209
	MotorHomes with Ford F53 Chassis with 24,000 lb GVW to 26,000 lb GVW	ASH25820 ASH1162 ASH-25820 ASH-1162	85005 89430
02-04	Motorhome Chassis with 20,500 lb GVW to 22,000 lb GVW	9U9Z18125A ASH-1206 ASH137 AT-621 ASH-25824 ASH-1023 ASH25824 ASH-1230 9U9418080AA HU9Z-18125-B ASH1230 ASH1023 9U94-18080-AA 9U9Z-18125-A AT621 ASH1206 ASH-137 HU9Z18125B	83122 89406
	MotorHomes with Ford F53 Chassis with 16,000 lb GVW to 22,000 lb GVW	ASH-1229 ASH-1228 9U94-18045-AA ASH-1205 AT-620 ASH25823 ASH-1022 ASH1022 1C3418045JA ASH-25822 ASH1205 ASH-25823 ASH1228 ASH1229 AT620 1C34-18045-JA AT766 9U9Z18124A ASH294 1C3418045AA 1C34-18045-AA ASH-294 9U9418045AA 9U9Z-18124-A ASH25822 AT-766	83209

SUNSTAR LX

16-18	Motorhome Chassis with 16,000 lb GVW to 18,000 lb GVW	9U9Z18125B 9U9Z-18125-B ASH-25825 ASH25825	83122 89406
-------	---	---	------	------	------	------	----------------	------	------	------

APPLICATION GUIDE

Year	Fitment Notes	OEM#								
			Fleetline\ Gas SLX	Classic\ Ultra\ ProGuard\ Guardian	Max Control\ LTV Severe Duty\ Load Carrier	Steering Dampers\ Steering Stabilizer\ Cab Shock	Fleetline\ Gas SLX	Classic\ Ultra\ ProGuard\ Guardian	Max Control\ LTV Severe Duty\ Load Carrier\ HiJackers	Steering Dampers\ Steering Stabilizer\ Cab Shock

WINNEBAGO

WINNEBAGO

SUNSTAR LX (cont)

16-18	Motorhome Chassis with 20,500 lb GVW to 22,000 lb GVW	9U9Z18125A ASH-1206 ASH137 AT-621 ASH-25824 ASH-1023 ASH25824 ASH-1230 9U9418080AA HU9Z-18125-B ASH1230 ASH1023 9U94-18080-AA 9U9Z-18125-A AT621 ASH1206 ASH-137 HU9Z18125B	O/O	O/O	83122 89406
	MotorHomes with Ford F53 Chassis with 16,000 lb GVW to 22,000 lb GVW	ASH-1229 ASH-1228 ASH1022 ASH-1205 ASH25822 ASH-25822 ASH1205 ASH25823 ASH-1022 ASH-25823 ASH1228 ASH1229	O/O	83209

TOUR

06	MotorHomes with Freightliner XC Chassis and ADL200 Suspension w/ 20K Rear	1616873000 16-16873-000 141700131809 1616736000 16-16736-000	O/O	O/O	85029
	MotorHomes with Freightliner XC Chassis and AS120 Front Suspension	16-16874-000 1616874000 1616737000 16-16737-000 141700131810	O/O	83160





VECTRA

06	MotorHomes with Freightliner XC Chassis and ADL200 Suspension w/ 20K Rear	1616873000 16-16873-000 141700131809 1616736000 16-16736-000	O/O	O/O	85029
	MotorHomes with Freightliner XC Chassis and AS120 Front Suspension	16-16874-000 1616874000 1616737000 16-16737-000 141700131810	O/O	83160

VISTA

08-23	MotorHomes with Ford F53 Chassis with 24,000 lb GVW to 26,000 lb GVW	ASH1161 ASH25821 ASH-25821 ASH-1161	O/O	85006
11-22	Motorhome Chassis with 16,000 lb GVW to 18,000 lb GVW	9U9Z18125B 9U9Z-18125-B ASH-25825 ASH25825	O/O	O/O	83122 89406

APPLICATION GUIDE

Year	Fitment Notes	OEM#								
			 Fleetline\ Gas SLX	Classic\ Ultra\ ProGuard\ Guardian	Max Control\ LTV Severe Duty\ Load Carrier	Steering Dampers\ Steering Stabilizer\ Cab Shock	 Fleetline\ Gas SLX	Classic\ Ultra\ ProGuard\ Guardian	Max Control\ LTV Severe Duty\ Load Carrier\ HiJackers	Steering Dampers\ Steering Stabilizer\ Cab Shock



WINNEBAGO

WINNEBAGO

VISTA (cont)

11-22	Motorhome Chassis with 20,500 lb GVW to 22,000 lb GVW	9U9Z18125A ASH-1206 ASH137 AT-621 ASH-25824 ASH-1023 ASH25824 ASH-1230 9U9418080AA HU9Z-18125-B ASH1230 ASH1023 9U94-18080-AA 9U9Z-18125-A AT621 ASH1206 ASH-137 HU9Z18125B	OO	83122 89406
08-22	MotorHomes with Ford F53 Chassis with 24,000 lb GVW to 26,000 lb GVW	ASH25820 ASH1162 ASH-25820 ASH-1162	OO	85005 89430
07-22	MotorHomes with Ford F53 Chassis with 16,000 lb GVW to 22,000 lb GVW	ASH-1229 ASH-1228 9U94-18045-AA ASH-1205 AT-620 ASH25823 ASH-1022 ASH1022 1C3418045JA ASH-25822 ASH1205 ASH-25823 ASH1228 ASH1229 AT620 1C34-18045-JA AT766 9U9Z18124A ASH294 1C3418045AA 1C34-18045-AA ASH-294 9U9418045AA 9U9Z-18124-A ASH25822 AT-766	83209	OO
08-09	Motorhome Chassis with 16,000 lb GVW to 18,000 lb GVW	9U9Z18125B 9U9Z-18125-B ASH-25825 ASH25825	OO	83122 89406
07-09	Motorhome Chassis with 20,500 lb GVW to 22,000 lb GVW	9U9Z18125A ASH-1206 ASH137 AT-621 ASH-25824 ASH-1023 ASH25824 ASH-1230 9U9418080AA HU9Z-18125-B ASH1230 ASH1023 9U94-18080-AA 9U9Z-18125-A AT621 ASH1206 ASH-137 HU9Z18125B	OO	83122 89406

APPLICATION GUIDE

Year	Fitment Notes	OEM#								
			Fleetline\ Gas SLX	Classic\ Ultra\ ProGuard\ Guardian	Max Control\ LTV Severe Duty\ Load Carrier	Steering Dampers\ Steering Stabilizer\ Cab Shock	Fleetline\ Gas SLX	Classic\ Ultra\ ProGuard\ Guardian	Max Control\ LTV Severe Duty\ Load Carrier\ HiJackers	Steering Dampers\ Steering Stabilizer\ Cab Shock

WINNEBAGO

WINNEBAGO

VISTA (cont)

02-04	Motorhome Chassis with 20,500 lb GVW to 22,000 lb GVW	9U9Z18125A ASH-1206 ASH137 AT-621 ASH-25824 ASH-1023 ASH25824 ASH-1230 9U9418080AA HU9Z-18125-B ASH1230 ASH1023 9U94-18080-AA 9U9Z-18125-A AT621 ASH1206 ASH-137 HU9Z18125B	O/O	83122 89406
	MotorHomes with Ford F53 Chassis with 16,000 lb GVW to 22,000 lb GVW	ASH-1229 ASH-1228 9U94-18045-AA ASH-1205 AT-620 ASH25823 ASH-1022 ASH1022 1C3418045JA ASH-25822 ASH1205 ASH-25823 ASH1228 ASH1229 AT620 1C34-18045-JA AT766 9U9Z18124A ASH294 1C3418045AA 1C34-18045-AA ASH-294 9U9418045AA 9U9Z-18124-A ASH25822 AT-766	O/O	83209

VISTA LX

16-18	Motorhome Chassis with 16,000 lb GVW to 18,000 lb GVW	9U9Z18125B 9U9Z-18125-B ASH-25825 ASH25825	O/O	83122 89406	
	Motorhome Chassis with 20,500 lb GVW to 22,000 lb GVW	9U9Z18125A ASH-1206 ASH137 AT-621 ASH-25824 ASH-1023 ASH25824 ASH-1230 9U9418080AA HU9Z-18125-B ASH1230 ASH1023 9U94-18080-AA 9U9Z-18125-A AT621 ASH1206 ASH-137 HU9Z18125B	O/O	O/O	83122 89406
	MotorHomes with Ford F53 Chassis with 16,000 lb GVW to 22,000 lb GVW	ASH-1229 ASH-1228 ASH1022 ASH-1205 ASH25822 ASH-25822 ASH1205 ASH25823 ASH-1022 ASH-25823 ASH1228 ASH1229	O/O	83209	

APPLICATION GUIDE

Year	Fitment Notes	OEM#								
			Fleetline\ Gas SLX	Classic\ Ultra\ ProGuard\ Guardian	Max Control\ LTV Severe Duty\ Load Carrier	Steering Dampers\ Steering Stabilizer\ Cab Shock	Fleetline\ Gas SLX	Classic\ Ultra\ ProGuard\ Guardian	Max Control\ LTV Severe Duty\ Load Carrier\ HiJackers	Steering Dampers\ Steering Stabilizer\ Cab Shock

WORKHORSE VARIOUS

WORKHORSE

	Models with O.E.M. Number	W0011635	OO	83221	
		680672		OO	85919
		W0011636		OO	G63366
		659223		OO	G63866
	Models with RSAS Rear Suspension	7805X1012 7805-X-1012		OO	85919
Step Van Models with O.E.M. Number	W0007365		OO	G63866	
UFO Motorhome Chassis with Hendrickson Softek Front Suspension	66153-002 66153002 F4-BE5-C832-MO F4BE5C832MO	OO	83124	
03-11	W20 , W22, & W24 MotorHome Chassis with O.E.M. Number	24-153249 F4-BE5-B492-HO W0005662 W0006254 24153249 24-186629 F4-BE5-A832-MO F4BE5A832MO F4BE5F324HO F4-BE5-F324-HO 24186629 F4BE5B492HO	OO	85125	
02	W20 , W22, & W24 MotorHome Chassis with O.E.M. Number	24153249 F4-BE5-A832-MO F4BE5A832MO F4BE5F324HO F4BE5B492HO	OO	85125	



W20

10-11	W20 , W22, & W24 MotorHome Chassis with O.E.M. Number	24-153249 F4-BE5-B492-HO W0005662 W0006254 24-186629 F4-BE5-A832-MO F4-BE5-F324-HO	OO	85125
04-09	Models with O.E.M. Number	W0005663 F4-BE5-F325-HO 24-153256		I T	85124
01-09	All	24-153249 F4-BE5-B492-HO W0005662 W0006254 24-186629 F4-BE5-A832-MO F4-BE5-F324-HO	OO	85125
98-00	W20 , W22, & W24 MotorHome Chassis with O.E.M. Number	24-153249 F4-BE5-B492-HO W0005662 W0006254 24-186629 F4-BE5-A832-MO F4-BE5-F324-HO	OO	85125

W22

10-14	W20 , W22, & W24 MotorHome Chassis with O.E.M. Number	24-153249 F4-BE5-B492-HO W0005662 W0006254 24-186629 F4-BE5-A832-MO F4-BE5-F324-HO	OO	85125
04-09	Models with O.E.M. Number	W0005663 F4-BE5-F325-HO 24-153256		I T	85124
01-09	All	24-153249 F4-BE5-B492-HO W0005662 W0006254 24-186629 F4-BE5-A832-MO F4-BE5-F324-HO	OO	85125

APPLICATION GUIDE

Year	Fitment Notes	OEM#								
			Fleetline\ Gas SLX	Classic\ Ultra\ ProGuard\ Guardian	Max Control\ LTV Severe Duty\ Load Carrier	Steering Dampers\ Steering Stabilizer\ Cab Shock	Fleetline\ Gas SLX	Classic\ Ultra\ ProGuard\ Guardian	Max Control\ LTV Severe Duty\ Load Carrier\ HiJackers	Steering Dampers\ Steering Stabilizer\ Cab Shock

WORKHORSE

W22 (cont)

98-00	W20 , W22, & W24 MotorHome Chassis with O.E.M. Number	24-153249 F4-BE5-B492-HO W0005662 W0006254 24-186629 F4-BE5-A832-MO F4-BE5-F324-HO	85125
-------	---	--	-------	------	------	------	------	------	------	------	------

W24

10-11	W20 , W22, & W24 MotorHome Chassis with O.E.M. Number	24-153249 F4-BE5-B492-HO W0005662 W0006254 24-186629 F4-BE5-A832-MO F4-BE5-F324-HO	85125
04-09	All	24-153249 F4-BE5-B492-HO W0005662 W0006254 24-186629 F4-BE5-A832-MO F4-BE5-F324-HO	85125
	Models with O.E.M. Number	W0005663 F4-BE5-F325-HO 24-153256	85124
98-03	W20 , W22, & W24 MotorHome Chassis with O.E.M. Number	24-153249 F4-BE5-B492-HO W0005662 W0006254 24-186629 F4-BE5-A832-MO F4-BE5-F324-HO	85125

WORLD TRANS BUS CO.

VARIOUS

	E & G Series Commercial buses on Ford E350 or E450 Chassis	ASH1154 ASH-1154	I O	G63622	58622 77614	
		ASH-1136 ASH1136	I O	I O	G63623	58623 77623

XOS

XOS

ADDITIONAL O.E.M. INTERCHANGES

	Medium Duty Electric Trucks with Hendrickson Softek Suspension (10K Capacity)	58913-009L 58913-009 58913009 58913009L	O O	85959	
	Medium Duty Trucks With Hendrickson HTS Suspension (16K Capacity)	60665025 60665025L 60665-025 60665-025L	O O	O O	85036 89405

Numerical listing

Steering Stabilizer, Front Load Carrier, Rear Load Carrier, HiJackers,
Ultra ReadyMount, LTV Severe Duty

Numerical listing

Shock	POP	Alternative No.	MTG Acc. Supplied
Pos.	Year	Application	

Steering Stabilizer

Shock	POP	Alternative No.	MTG Acc. Supplied
Pos.	Year	Application	
6802SE A 141998			
F	68-73	FORD PICKUP P350 All Single System Steering Stabilizer All models with factory frame bracket. Kit 143168 required to install to linkage.	
F	74-75	INTERNATIONAL 200 All Single System Steering Stabilizer All models with factory frame bracket. Kit 143168 required to install to linkage.	
F	68	1200C All Single System Steering Stabilizer; 1/2 Ton, 3/4 Ton & Travelall All models with factory frame bracket. Kit 143168 required to install to linkage.	
F	69-70	1200D All Single System Steering Stabilizer; 1/2 Ton, 3/4 Ton & Travelall All models with factory frame bracket. Kit 143168 required to install to linkage.	
F	71-73	1210 All Single System Steering Stabilizer; 1/2 Ton, 3/4 Ton & Travelall All models with factory frame bracket. Kit 143168 required to install to linkage.	
F	68	1300C All Single System Steering Stabilizer; 1/2 Ton, 3/4 Ton & Travelall All models with factory frame bracket. Kit 143168 required to install to linkage.	
F	69-70	1300D All Single System Steering Stabilizer; 1/2 Ton, 3/4 Ton & Travelall All models with factory frame bracket. Kit 143168 required to install to linkage.	
F	71-73	1310 All Single System Steering Stabilizer; 1/2 Ton, 3/4 Ton & Travelall All models with factory frame bracket. Kit 143168 required to install to linkage.	
F	68-72	M1100 / M1200 All Single System Steering Stabilizer; 1/2 and 3/4 Ton I-Beam Axle All models with factory frame bracket. Kit 143168 required to install to linkage.	
F	69	M1400 All Single System Steering Stabilizer; 1/2 and 3/4 Ton I-Beam Axle All models with factory frame bracket. Kit 143168 required to install to linkage.	
F	75	TRAVELALL RWD Single System Steering Stabilizer All models with factory frame bracket. Kit 143168 required to install to linkage.	

Shock	POP	Alternative No.	MTG Acc. Supplied
Pos.	Year	Application	
6803SE C 141998			
F	75	INTERNATIONAL TRAVELALL 4WD Single System Steering Stabilizer	

Shock	POP	Alternative No.	MTG Acc. Supplied
Pos.	Year	Application	
6828SE C 142718			
F	00-02	FORD E-450 ECONOLINE SUPER DUTY All Single System Steering Stabilizer	
F	02	E-550 ECONOLINE SUPER DUTY All Single System Steering Stabilizer	
F	03	E-550 SUPER DUTY All Single System Steering Stabilizer	
F	21-24	VAN 1 TON, ECONOLINE / CLUB WAGON / SUPERDUTY All Single System Steering Stabilizer	
F	03-19	VAN 1 TON, ECONOLINE / CLUB WAGON / SUPERDUTY All Single System Steering Stabilizer	

Shock	POP	Alternative No.	MTG Acc. Supplied
Pos.	Year	Application	
6854SE C 142718			
F	99-04	FORD PICKUP, F-450 SUPERDUTY 4 X 4 Single System Steering Stabilizer	
F	99-04	PICKUP, F-550 SUPERDUTY 4 X 4 Single System Steering Stabilizer	

Front Load Carrier

Shock	POP	Alternative No.	MTG Acc. Supplied
Pos.	Year	Application	
34076 A 140780			
F	10-19	FORD VAN 1 TON, ECONOLINE / CLUB WAGON / SUPERDUTY All	

Rear Load Carrier

Shock	POP	Alternative No.	MTG Acc. Supplied
Pos.	Year	Application	
43048 A			
F	68-76	FORD PICKUP P350 All Up through 8000# GVW	

Shock	POP	Alternative No.	MTG Acc. Supplied
Pos.	Year	Application	

Shock	POP	Alternative No.	MTG Acc. Supplied
Pos.	Year	Application	
43048 A (cont)			
F	75-76	PICKUP P400 All Up through 8000# GVW	
F	68	INTERNATIONAL 1200C All Exc. 166" Wheelbase	
R	68	1200C All Exc. 166" Wheelbase	
F	68	1300C All Exc. 166" Wheelbase	
R	68	1300C All Exc. 166" Wheelbase	
R	68-72	M1100 / M1200 All	
R	69	M1400 All	

Shock	POP	Alternative No.	MTG Acc. Supplied
Pos.	Year	Application	
43167 A			
R	97	FORD PICKUP, F-450 SUPERDUTY All	

HiJackers

Shock	POP	Alternative No.	MTG Acc. Supplied
Pos.	Year	Application	
49178 B 140126,141099			
R	21-22	FORD VAN 1 TON, ECONOLINE / CLUB WAGON / SUPERDUTY All	
R	10-19	VAN 1 TON, ECONOLINE / CLUB WAGON / SUPERDUTY All	

Shock	POP	Alternative No.	MTG Acc. Supplied
Pos.	Year	Application	
49310 C 140788,141099			
R	68	INTERNATIONAL 1200C All Exc. 166" Wheelbase	
R	68	1300C All Exc. 166" Wheelbase	
R	68-72	M1100 / M1200 All	
R	69	M1400 All	

Ultra ReadyMount

Shock	POP	Alternative No.	MTG Acc. Supplied
Pos.	Year	Application	
G57816 C			
F	21-22	COACH HOUSE PLATINUM III All MotorHomes with Ford Transit-350 Chassis	
F	19-22	COACHMEN BEYOND All MotorHomes with Ford Transit-350 Chassis	
F	21-22	CROSS TRAIL TRANSIT All MotorHomes with Ford Transit-350 Chassis	
F	17-22	FOREST RIVER FORESTER TS All MotorHomes with Ford Transit-350 Chassis	
F	17-22	SUNSEEKER TS All MotorHomes with Ford Transit-350 Chassis	
F	19-22	LEISURE TRAVEL WONDER All MotorHomes with Ford Transit-350 Chassis	
F	20-22	PHOENIX TRX All MotorHomes with Ford Transit-350 Chassis	
F	19-22	THOR MOTOR COACH GEMINI All MotorHomes with Ford Transit-350 Chassis	
F	21-22	WINNEBAGO EKKO All MotorHomes with Ford Transit-350 Chassis	

LTV Severe Duty

Shock	POP	Alternative No.	MTG Acc. Supplied
Pos.	Year	Application	
58622 C 142617			
F	17-24	BERKSHIRE COACH ULTRA 24	
F	17-24	ULTRA 28	
F	92-24	BLUE BIRD MICROBIRD TYPE A SCHOOL BUS	
F		CHAMPION BUS INC. AMERICAN COACH	
F		CHALLENGER	
F		CRUSADER	
F		LF TRANSPORT	
F	03-24	COACH HOUSE PLATINUM All Motorhomes with Ford E450 Chassis	
F	23-24	PLATINUM IV All Motorhomes with Ford E450 Chassis	
F		COACHMEN CATALINA	
F	24	CONCORD	
F	20-22	CONCORD	
F	04-06	CONCORD	
F	23	CONCORD All MotorHomes with Ford E350 or E450 Chassis	
F	07-19	CONCORD All MotorHomes with Ford E350 or E450 Chassis	
F	04-08	FREEDOM EXPRESS	
F	09	FREEDOM EXPRESS All MotorHomes with Ford E350 or E450 Chassis	
F	03-07	FREELANDER	
F	08-24	FREELANDER All MotorHomes with Ford E350 or E450 Chassis	
F	10	LEPRECHAUN	
F	03-07	LEPRECHAUN	
F	11-23	LEPRECHAUN All MotorHomes with Ford E350 or E450 Chassis	
F	08-09	LEPRECHAUN All MotorHomes with Ford E350 or E450 Chassis	
F	98-03	PATHFINDER	

Shock	POP	Alternative No.	MTG Acc. Supplied
Pos.	Year	Application	

Shock	POP	Alternative No.	MTG Acc. Supplied
Pos.	Year	Application	
58622 C (cont) 142617			
F	99-06	SANTARA	
F		COLLINS BUS CORP. VARIOUS	
F		DIAMOND COACH SHUTTLE BUSES	
F	92-09	DUTCHMEN RV CLASS C MOTORHOMES	
F	15-20	JAMBOREE	
F	92-17	DYNAMAX CORP ISATA 4	
F	18-20	ISATA 4 All MotorHomes with Ford E350 or E450 Chassis	
F		ELDORADO NATIONAL ADVANTAGE	
F		AEROLITE	
F		AEROTECH	
F	17	ENTEGRA COACH ESTEEM	
F	18-24	ESTEEM All MotorHomes with Ford E350 or E450 Chassis	
F	17	ODYSSEY	
F	18-24	ODYSSEY All MotorHomes with Ford E350 or E450 Chassis	
F		FEDERAL COACH VARIOUS	
F	20	FLEETWOOD JAMBOREE	
F	14-16	JAMBOREE	
F	99-07	JAMBOREE	
F	17-19	JAMBOREE All MotorHomes with Ford E350 or E450 Chassis	
F	08-13	JAMBOREE All MotorHomes with Ford E350 or E450 Chassis	
F	19-20	SURGE	
F	18	SURGE All MotorHomes with Ford E350 or E450 Chassis	
F	14-16	TIOGA	
F	99-07	TIOGA	
F	08-13	TIOGA All MotorHomes with Ford E350 or E450 Chassis	
F	00-02	FORD E-450 ECONOLINE SUPER DUTY All	
F	21-24	VAN 1 TON, ECONOLINE / CLUB WAGON / SUPERDUTY All	
F	03-19	VAN 1 TON, ECONOLINE / CLUB WAGON / SUPERDUTY All	
F		FOREST RIVER ALL AMERICAN FORESTER	
F	20	FORESTER	
F	04-19	FORESTER All MotorHomes with Ford E350 or E450 Chassis	
F	15-18	FORESTER GTS All MotorHomes with Ford E350 or E450 Chassis	
F	03-15	LEXINGTON All MotorHomes with Ford E350 or E450 Chassis	
F	21-23	SOLERA All MotorHomes with Ford E350 or E450 Chassis	
F	10-15	SOLERA All MotorHomes with Ford E350 or E450 Chassis	
F	23	SUNSEEKER	
F	99-06	SUNSEEKER	
F	07-22	SUNSEEKER All MotorHomes with Ford E350 or E450 Chassis	
F	19-20	SUNSEEKER GTS	
F	15-18	SUNSEEKER GTS All MotorHomes with Ford E350 or E450 Chassis	
F	99-09	GEORGIE BOY MANUFACTURING CLASS C MOTORHOMES	
F		GLAVAL BUS CO. VARIOUS	
F		GOSHEN COACH VARIOUS	
F		GRECH MOTORS VARIOUS	
F	02-15	GULF STREAM BT CRUISER	
F	16-23	BT CRUISER All MotorHomes with Ford E350 or E450 Chassis	
F	99-06	CAVALIER	
F	12-15	CONQUEST	
F	93-01	CONQUEST	
F	16-22	CONQUEST All MotorHomes with Ford E350 or E450 Chassis	
F	02-11	CONQUEST All MotorHomes with Ford E350 or E450 Chassis	
F	10-11	CONQUEST SPORT All MotorHomes with Ford E350 or E450 Chassis	
F	01-02	CONQUEST SPORT All MotorHomes with Ford E350 or E450 Chassis	
F	00-11	INDEPENDENCE All MotorHomes with Ford E350 or E450 Chassis	
F	10-11	MONTAJ All MotorHomes with Ford E350 or E450 Chassis	
F	00-08	ULTRA	
F	02-04	YELLOWSTONE	
F	05-11	YELLOWSTONE All MotorHomes with Ford E350 or E450 Chassis	
F	19	HOLIDAY RAMBLER ALTERA	
F	18	ALTERA All MotorHomes with Ford E450 Chassis	
F	08	ATLANTIS	
F	06	ATLANTIS	

Numerical listing

Shock	POP	Alternative No.	MTG Acc. Supplied
Pos.	Year	Application	
58622	C (cont)		142617
F	99-01	ATLANTIS	
F	09-10	ATLANTIS All MotorHomes with Ford E450 Chassis	
F	07	ATLANTIS All MotorHomes with Ford E450 Chassis	
F	02-05	ATLANTIS All MotorHomes with Ford E450 Chassis	
F	19	AUGUSTA All MotorHomes with Ford E450 Chassis	
F	15-16	AUGUSTA All MotorHomes with Ford E450 Chassis	
F	11	AUGUSTA All MotorHomes with Ford E450 Chassis	
F	08-09	AUGUSTA All MotorHomes with Ford E450 Chassis	
F	12-13	AUGUSTA B+ All MotorHomes with Ford E450 Chassis	
F	10	AUGUSTA B+ All MotorHomes with Ford E450 Chassis	
F	07	AUGUSTA B+ All MotorHomes with Ford E450 Chassis	
F	16	AUGUSTA LX All MotorHomes with Ford E450 Chassis	
F	07-10	AUGUSTA SPORT All MotorHomes with Ford E350 Chassis	
F	07-09	AUGUSTA TOURING SEDAN All MotorHomes with Ford E350 Chassis	
F	17-18	VESTA All MotorHomes with Ford E450 Chassis	
F	01-20	ITASCA CLASS C MOTORHOMES	
F	03-06	JAYCO ESCAPADE All MotorHomes with Ford E350 or E450 Chassis	
F	02-06	GRANITE RIDGE All MotorHomes with Ford E350 or E450 Chassis	
F	02-24	GREYHAWK All MotorHomes with Ford E450 Chassis	
F	07-24	MELBOURNE All MotorHomes with Ford E350 or E450 Chassis	
F	13-24	REDHAWK All MotorHomes with Ford E450 Chassis	
F	18-24	REDHAWK SE All MotorHomes with Ford E450 Chassis	
F		KRYSTAL BUS VARIOUS	
F		LGE COACHWORKS VARIOUS	
F	11-12	NEXUS CLASS C MOTORHOMES	
F	11-24	PHANTOM All MotorHomes with Ford E350 or E450 Chassis	
F	20-24	TRIUMPH All MotorHomes with Ford E350 or E450 Chassis	
F	11-24	VIPER All MotorHomes with Ford E350 or E450 Chassis	
F	00-23	PHOENIX CRUISER All MotorHomes with Ford E350 or E450 Chassis	
F		SHASTA RV ALL MODELS	
F		STARCRAFT BUS CO. E350 & E450 FORD CHASSIS MODELS	
F	92-22	THOMAS TYPE A SCHOOL BUS	
F	14-24	THOR MOTOR COACH AXIS All MotorHomes with Ford E350 or E450 Chassis	
F	11-24	CHATEAU All MotorHomes with Ford E350 or E450 Chassis	
F	11-12	CHATEAU CITATION All MotorHomes with Ford E350 or E450 Chassis	
F	12-16	CITATION All MotorHomes with Ford E350 or E450 Chassis	
F	22-24	ECHELON All MotorHomes with Ford E350 or E450 Chassis	
F	11-24	FOUR WINDS All MotorHomes with Ford E350 or E450 Chassis	
F	12-23	FREEDOM ELITE All MotorHomes with Ford E350 or E450 Chassis	
F	11-23	OUTLAW All MotorHomes with Ford E350 or E450 Chassis	
F	16-24	QUANTUM All MotorHomes with Ford E350 or E450 Chassis	
F	14-24	VEGAS All MotorHomes with Ford E350 or E450 Chassis	
F		TURTLETOP BUS VARIOUS	
F		WHEELED COACH IND. VARIOUS	
F	07-13	WINNEBAGO ACCESS All MotorHomes with Ford E350 or E450 Chassis	
F	14	ACCESS PREMIER All MotorHomes with Ford E350 or E450 Chassis	
F	18-20	ASPECT	
F	05-17	ASPECT All MotorHomes with Ford E350 or E450 Chassis	
F	18-20	CAMBRIA	

LTV Severe Duty

Shock	POP	Alternative No.	MTG Acc. Supplied
Pos.	Year	Application	
58622	C (cont)		142617
F	09-15	CAMBRIA	
F	16-17	CAMBRIA All MotorHomes with Ford E350 or E450 Chassis	
F	05-08	CAMBRIA All MotorHomes with Ford E350 or E450 Chassis	
F	06-20	MINNIE	
F	99	MINNIE	
F	00-05	MINNIE All MotorHomes with Ford E350 or E450 Chassis	
F	14-24	MINNIE WINNIE All MotorHomes with Ford E350 or E450 Chassis	
F	00-06	MINNIE WINNIE All MotorHomes with Ford E350 or E450 Chassis	
F	11-18	OUTLOOK	
F	19-21	OUTLOOK All MotorHomes with Ford E350 or E450 Chassis	
F	06-10	OUTLOOK All MotorHomes with Ford E350 or E450 Chassis	
F	08-15	SPIRIT	
F	16-22	SPIRIT All MotorHomes with Ford E350 or E450 Chassis	
F	00-07	SPIRIT All MotorHomes with Ford E350 or E450 Chassis	
F		WORLD TRANS BUS CO. VARIOUS	
58623	C		142617
R	17-24	BERKSHIRE COACH ULTRA 24	
R	17-24	ULTRA 28	
R	92-24	BLUE BIRD MICROBIRD TYPE A SCHOOL BUS	
R		CHAMPION BUS INC. AMERICAN COACH	
R		CHALLENGER	
R		CRUSADER	
R		LF TRANSPORT	
R	03-24	COACH HOUSE PLATINUM All Motorhomes with Ford E450 Chassis	
R	23-24	PLATINUM IV All Motorhomes with Ford E450 Chassis	
R		COACHMEN CATALINA	
R	24	CONCORD	
R	20-22	CONCORD	
R	04-06	CONCORD	
R	23	CONCORD All MotorHomes with Ford E350 or E450 Chassis	
R	07-19	CONCORD All MotorHomes with Ford E350 or E450 Chassis	
R	04-08	FREEDOM EXPRESS	
R	09	FREEDOM EXPRESS All MotorHomes with Ford E350 or E450 Chassis	
R	03-07	FREELANDER	
R	08-24	FREELANDER All MotorHomes with Ford E350 or E450 Chassis	
R	10	LEPRECHAUN	
R	03-07	LEPRECHAUN	
R	11-23	LEPRECHAUN All MotorHomes with Ford E350 or E450 Chassis	
R	08-09	LEPRECHAUN All MotorHomes with Ford E350 or E450 Chassis	
R	98-03	PATHFINDER	
R	99-06	SANTARA	
R		COLLINS BUS CORP. VARIOUS	
R		DIAMOND COACH SHUTTLE BUSES	
R	92-09	DUTCHMEN RV CLASS C MOTORHOMES	
R	15-20	JAMBOREE	
R	92-17	DYNAMAX CORP ISATA 4	
R	18-20	ISATA 4 All MotorHomes with Ford E350 or E450 Chassis	
R		ELDORADO NATIONAL	
R		ADVANTAGE	
R		AEROLITE	
R		AEROTECH	
R	17	ENTEGA COACH ESTEEM	
R	18-24	ESTEEM All MotorHomes with Ford E350 or E450 Chassis	
R	17	ODYSSEY	
R	18-24	ODYSSEY All MotorHomes with Ford E350 or E450 Chassis	
R		FEDERAL COACH VARIOUS	
R		FLEETWOOD JAMBOREE	
R	20	JAMBOREE	
R	14-16	JAMBOREE	
R	99-07	JAMBOREE	
R	17-19	JAMBOREE All MotorHomes with Ford E350 or E450 Chassis	
R	08-13	JAMBOREE All MotorHomes with Ford E350 or E450 Chassis	
R	19-20	SURGE	
R	18	SURGE All MotorHomes with Ford E350 or E450 Chassis	
R	14-16	TIOGA	

Numerical listing

Shock	POP	Alternative No.	MTG Acc. Supplied
Pos.	Year	Application	
58623	C (cont)		142617
R	99-07	TIOGA	
R	08-13	TIOGA All MotorHomes with Ford E350 or E450 Chassis	
R	00-02	FORD E-450 ECONOLINE SUPER DUTY All	
R	21-24	VAN 1 TON, ECONOLINE / CLUB WAGON / SUPERDUTY All	
R	03-19	VAN 1 TON, ECONOLINE / CLUB WAGON / SUPERDUTY All	
R		FOREST RIVER ALL AMERICAN	
R	20	FORESTER	
R	04-19	FORESTER All MotorHomes with Ford E350 or E450 Chassis	
R	15-18	FORESTER GTS All MotorHomes with Ford E350 or E450 Chassis	
R	03-15	LEXINGTON All MotorHomes with Ford E350 or E450 Chassis	
R	21-23	SOLERA All MotorHomes with Ford E350 or E450 Chassis	
R	10-15	SOLERA All MotorHomes with Ford E350 or E450 Chassis	
R	23	SUNSEEKER	
R	99-06	SUNSEEKER	
R	07-22	SUNSEEKER All MotorHomes with Ford E350 or E450 Chassis	
R	19-20	SUNSEEKER GTS	
R	15-18	SUNSEEKER GTS All MotorHomes with Ford E350 or E450 Chassis	
R	99-09	GEORGIE BOY MANUFACTURING CLASS C MOTORHOMES	
R		GLAVAL BUS CO. VARIOUS	
R		GOSHEN COACH VARIOUS	
R		GRECH MOTORS VARIOUS	
R	02-15	GULF STREAM BT CRUISER	
R	16-23	BT CRUISER All MotorHomes with Ford E350 or E450 Chassis	
R	99-06	CAVALIER	
R	12-15	CONQUEST	
R	93-01	CONQUEST	
R	16-22	CONQUEST All MotorHomes with Ford E350 or E450 Chassis	
R	02-11	CONQUEST All MotorHomes with Ford E350 or E450 Chassis	
R	10-11	CONQUEST SPORT All MotorHomes with Ford E350 or E450 Chassis	
R	01-02	CONQUEST SPORT All MotorHomes with Ford E350 or E450 Chassis	
R	00-11	INDEPENDENCE All MotorHomes with Ford E350 or E450 Chassis	
R	10-11	MONTAJ All MotorHomes with Ford E350 or E450 Chassis	
R	00-08	ULTRA	
R	02-04	YELLOWSTONE	
R	05-11	YELLOWSTONE All MotorHomes with Ford E350 or E450 Chassis	
R	19	HOLIDAY RAMBLER ALTERA	
R	18	ALTERA All MotorHomes with Ford E450 Chassis	
R	08	ATLANTIS	
R	06	ATLANTIS	
R	99-01	ATLANTIS	
R	09-10	ATLANTIS All MotorHomes with Ford E450 Chassis	
R	07	ATLANTIS All MotorHomes with Ford E450 Chassis	
R	02-05	ATLANTIS All MotorHomes with Ford E450 Chassis	
R	19	AUGUSTA All MotorHomes with Ford E450 Chassis	
R	15-16	AUGUSTA All MotorHomes with Ford E450 Chassis	
R	11	AUGUSTA All MotorHomes with Ford E450 Chassis	
R	08-09	AUGUSTA All MotorHomes with Ford E450 Chassis	
R	12-13	AUGUSTA B+ All MotorHomes with Ford E450 Chassis	
R	10	AUGUSTA B+ All MotorHomes with Ford E450 Chassis	
R	07	AUGUSTA B+ All MotorHomes with Ford E450 Chassis	
R	16	AUGUSTA LX All MotorHomes with Ford E450 Chassis	
R	07-10	AUGUSTA SPORT All MotorHomes with Ford E350 Chassis	
R	07-09	AUGUSTA TOURING SEDAN All MotorHomes with Ford E350 Chassis	
R	17-18	VESTA All MotorHomes with Ford E450 Chassis	
R	01-20	ITASCA CLASS C MOTORHOMES	

Numerical listing

Shock	POP	Alternative No.	MTG Acc. Supplied
Pos.	Year	Application	
58623	C (cont)		142617
R	03-06	JAYCO ESCAPADE All MotorHomes with Ford E350 or E450 Chassis	
R	02-06	GRANITE RIDGE All MotorHomes with Ford E350 or E450 Chassis	
R	02-24	GREYHAWK All MotorHomes with Ford E450 Chassis	
R	07-24	MELBOURNE All MotorHomes with Ford E350 or E450 Chassis	
R	13-24	REDHAWK All MotorHomes with Ford E450 Chassis	
R	18-24	REDHAWK SE All MotorHomes with Ford E450 Chassis	
R		KRYSTAL BUS VARIOUS	
R		LGE COACHWORKS VARIOUS	
R	11-20	NEXUS CLASS C MOTORHOMES	
R	11-24	PHANTOM All MotorHomes with Ford E350 or E450 Chassis	
R	20-24	TRIUMPH All MotorHomes with Ford E350 or E450 Chassis	
R	11-24	VIPER All MotorHomes with Ford E350 or E450 Chassis	
R	00-23	PHOENIX CRUISER All MotorHomes with Ford E350 or E450 Chassis	
R		SHASTA RV ALL MODELS	
R		STARCRAFT BUS CO. E350 & E450 FORD CHASSIS MODELS	
R	92-20	THOMAS TYPE A SCHOOL BUS	
R	14-24	THOR MOTOR COACH AXIS All MotorHomes with Ford E350 or E450 Chassis	
R	11-24	CHATEAU All MotorHomes with Ford E350 or E450 Chassis	
R	11-12	CHATEAU CITATION All MotorHomes with Ford E350 or E450 Chassis	
R	12-16	CITATION All MotorHomes with Ford E350 or E450 Chassis	
R	22-24	ECHELON All MotorHomes with Ford E350 or E450 Chassis	
R	11-24	FOUR WINDS All MotorHomes with Ford E350 or E450 Chassis	
R	12-23	FREEDOM ELITE All MotorHomes with Ford E350 or E450 Chassis	
R	11-23	OUTLAW All MotorHomes with Ford E350 or E450 Chassis	
R	16-24	QUANTUM All MotorHomes with Ford E350 or E450 Chassis	
R	14-24	VEGAS All MotorHomes with Ford E350 or E450 Chassis	
R		TURTLETOP BUS VARIOUS	
R		WHEELED COACH IND. VARIOUS	
R	07-13	WINNEBAGO ACCESS All MotorHomes with Ford E350 or E450 Chassis	
R	14	ACCESS PREMIER All MotorHomes with Ford E350 or E450 Chassis	
R	18-20	ASPECT	
R	06-17	ASPECT All MotorHomes with Ford E350 or E450 Chassis	
R	18-20	CAMBRIA	
R	09-15	CAMBRIA	
R	16-17	CAMBRIA All MotorHomes with Ford E350 or E450 Chassis	
R	05-08	CAMBRIA All MotorHomes with Ford E350 or E450 Chassis	
R	06-20	MINNIE	
R	99	MINNIE	
R	00-05	MINNIE All MotorHomes with Ford E350 or E450 Chassis	
R	14-24	MINNIE WINNIE All MotorHomes with Ford E350 or E450 Chassis	
R	00-06	MINNIE WINNIE All MotorHomes with Ford E350 or E450 Chassis	
R	11-18	OUTLOOK	
R	19-21	OUTLOOK All MotorHomes with Ford E350 or E450 Chassis	
R	06-10	OUTLOOK All MotorHomes with Ford E350 or E450 Chassis	
R	08-15	SPIRIT	
R	16-22	SPIRIT All MotorHomes with Ford E350 or E450 Chassis	
R	00-07	SPIRIT All MotorHomes with Ford E350 or E450 Chassis	
R		WORLD TRANS BUS CO. VARIOUS	
58638	C		
R	09-22	CHEVROLET EXPRESS 4500 All	

LTV Severe Duty, ProGuard, Ultra Truck Shock

Shock	POP	Alternative No.	MTG Acc. Supplied
Pos.	Year	Application	
58809	B		
F	99-04	FORD PICKUP, F-450 SUPERDUTY All	
F	99-04	PICKUP, F-550 SUPERDUTY All	
58944	D		
F	07-12	FORD PICKUP, F-450 SUPERDUTY All	
F	10-12	PICKUP, F-550 SUPERDUTY All	
ProGuard			
61500	A		
F	68-76	FORD PICKUP P350 All Up through 8000# GVW	
F	75-76	PICKUP P400 All Up through 8000# GVW	
F	68	INTERNATIONAL 1200C All Exc. 166" Wheelbase	
R	68	1200C All Exc. 166" Wheelbase	
F	68	1300C All Exc. 166" Wheelbase	
R	68	1300C All Exc. 166" Wheelbase	
R	68-72	M1100 / M1200 All	
R	69	M1400 All	
61554	B		
R	97	FORD PICKUP, F-450 SUPERDUTY All	
61646	D		142617
R	00-02	FORD E-450 ECONOLINE SUPER DUTY All	
R	21-24	VAN 1 TON, ECONOLINE / CLUB WAGON / SUPERDUTY All	
R	03-19	VAN 1 TON, ECONOLINE / CLUB WAGON / SUPERDUTY All	
61655	B		
R	02	FORD E-550 ECONOLINE SUPER DUTY All	
R	03	E-550 SUPER DUTY All	
F	99-04	PICKUP, F-450 SUPERDUTY All	
F	99-04	PICKUP, F-550 SUPERDUTY All	
61685	B		143078
F	09-22	CHEVROLET EXPRESS 4500 All	
F	10-20	GMC SAVANA 4500 All	
61687	C		
R	09-22	CHEVROLET EXPRESS 4500 All	
R	10-20	GMC SAVANA 4500 All	
Ultra Truck Shock			
G63183	C		
R	63-81	CHRYSLER MOTORHOME CHASSIS	
R	74	DODGE M300 All	
F	78-80	RD200 All	
R		HOLIDAY RAMBLER VARIOUS	
G63299	A		140885
R	87-04	MITSUBISHI FUSO FE All Model with O.E.M. Number	
G63366	A		
R		WORKHORSE VARIOUS	
G63405	A		140884
F	68-76	FORD PICKUP P350 All Up through 8000# GVW	
F	75-76	PICKUP P400 All Up through 8000# GVW	
F	68	INTERNATIONAL 1200C All Exc. 166" Wheelbase	
R	68	1200C All Exc. 166" Wheelbase	
F	68	1300C All Exc. 166" Wheelbase	
R	68	1300C All Exc. 166" Wheelbase	
R	68-72	M1100 / M1200 All	
R	69	M1400 All	
R	96-04	MITSUBISHI FUSO FE All Model with O.E.M. Number	
R	98-04	FG All Model with O.E.M. Number	
G63409	C		
R	97	FORD PICKUP, F-450 SUPERDUTY All	
G63419	C		
R	98	HINO FA, FB SERIES	
G63432	B		141349,140169
F		INTERNATIONAL DURASTAR - 1000 SERIES	
F		UD UD 1300	

Numerical listing

Shock	POP	Alternative No.	MTG Acc. Supplied
Pos.	Year	Application	
G63461	B		
R	99-07	FORD PICKUP, F-450 SUPERDUTY All Models with single or dual rear wheels with 165" or 201" wheel base	
R	99-07	PICKUP, F-550 SUPERDUTY All Models with single or dual rear wheels with 165" or 201" wheel base	
G63605	C		140169
F	74	DODGE M300 All	
F	74	M350 All	
G63610	B		142389
F	89-91	HINO FA14 All Models with O.E.M. Number	
F	92	FA15 All FA, FB Models Trucks with:	
F	93-97	FA1415 All (FA15)	
F	93-97	FA1415 All FA, FB Models Trucks with:	
F	93-97	FA1415 All FA1415 (FA15), FB1715 (FB15)	
F	98-04	FA1517 All FA, FB Models Trucks with:	
F	89-91	FB14 All FA, FB Models Trucks with:	
F	92	FB15 All FA, FB Models Trucks with:	
F	93-97	FB1715 All FA, FB Models Trucks with:	
F	93-97	FB1715 All FA1415 (FA15), FB1715 (FB15)	
F	98-04	FB1817 All FA, FB Models Trucks with:	
F	05-11	MITSUBISHI FUSO FE145 All Models with O.E.M. Number	
F	96-04	FE All Models with O.E.M. Number	
F	88-04	FH All Models with O.E.M. Number	
F	99-10	UD UD 18HD SERIES	
F	11-13	UD 1800 SERIES	
F	95-98	UD 1800 SERIES	
F	95-13	UD 2000 SERIES	
G63622	N		142617
F	17-24	BERKSHIRE COACH ULTRA 24	
F	17-24	ULTRA 28	
F	92-24	BLUE BIRD MICROBIRD TYPE A SCHOOL BUS	
F		CHAMPION BUS INC. AMERICAN COACH	
F		CHALLENGER	
F		CRUSADER	
F		LF TRANSPORT	
F	03-24	COACH HOUSE PLATINUM All Motorhomes with Ford E450 Chassis	
F	23-24	PLATINUM IV All Motorhomes with Ford E450 Chassis	
F		COACHMEN CATALINA	
F	24	CONCORD	
F	20-22	CONCORD	
F	04-06	CONCORD	
F	23	CONCORD All MotorHomes with Ford E350 or E450 Chassis	
F	07-19	CONCORD All MotorHomes with Ford E350 or E450 Chassis	
F	04-08	FREEDOM EXPRESS	
F	09	FREEDOM EXPRESS All MotorHomes with Ford E350 or E450 Chassis	
F	03-07	FREELANDER	
F	08-24	FREELANDER All MotorHomes with Ford E350 or E450 Chassis	
F	10	LEPRECHAUN	
F	03-07	LEPRECHAUN	
F	11-23	LEPRECHAUN All MotorHomes with Ford E350 or E450 Chassis	
F	08-09	LEPRECHAUN All MotorHomes with Ford E350 or E450 Chassis	
F	98-03	PATHFINDER	
F	99-06	SANTARA	
F		COLLINS BUS CORP. VARIOUS	
F		DIAMOND COACH SHUTTLE BUSES	
F	92-09	DUTCHMEN RV CLASS C MOTORHOMES	
F	15-20	JAMBOREE	
F	92-17	DYNAMAX CORP ISATA 4	
F	18-20	ISATA 4 All MotorHomes with Ford E350 or E450 Chassis	
F		ELDORADO NATIONAL	
F		ADVANTAGE	
F		AEROLITE	
F		AEROTECH	
F	17	ENTEGRA COACH ESTEEM	

Numerical listing

Shock	POP	Alternative No.	MTG Acc. Supplied
Pos.	Year	Application	
G63622	N	(cont)	142617
F	18-24	ESTEEM	All MotorHomes with Ford E350 or E450 Chassis
F	17	ODYSSEY	
F	18-24	ODYSSEY	All MotorHomes with Ford E350 or E450 Chassis
F	20	FLEETWOOD	JAMBOREE
F	14-16	JAMBOREE	
F	99-07	JAMBOREE	
F	17-19	JAMBOREE	All MotorHomes with Ford E350 or E450 Chassis
F	08-13	JAMBOREE	All MotorHomes with Ford E350 or E450 Chassis
F	19-20	SURGE	
F	18	SURGE	All MotorHomes with Ford E350 or E450 Chassis
F	14-16	TIOGA	
F	99-07	TIOGA	
F	08-13	TIOGA	All MotorHomes with Ford E350 or E450 Chassis
F	00-02	FORD	E-450 ECONOLINE SUPER DUTY All
F	21-22	VAN 1 TON, ECONOLINE / CLUB WAGON / SUPERDUTY	All
F	03-19	VAN 1 TON, ECONOLINE / CLUB WAGON / SUPERDUTY	All
F	20	FOREST RIVER	ALL AMERICAN FORESTER
F	04-19	FORESTER	All MotorHomes with Ford E350 or E450 Chassis
F	15-18	FORESTER GTS	All MotorHomes with Ford E350 or E450 Chassis
F	03-15	LEXINGTON	All MotorHomes with Ford E350 or E450 Chassis
F	21-23	SOLERA	All MotorHomes with Ford E350 or E450 Chassis
F	10-15	SOLERA	All MotorHomes with Ford E350 or E450 Chassis
F	23	SUNSEEKER	
F	99-06	SUNSEEKER	
F	07-22	SUNSEEKER	All MotorHomes with Ford E350 or E450 Chassis
F	19-20	SUNSEEKER GTS	
F	15-18	SUNSEEKER GTS	All MotorHomes with Ford E350 or E450 Chassis
F	99-09	GEORGIE BOY MANUFACTURING	CLASS C MOTORHOMES GLAVAL BUS CO. VARIOUS
F	02-15	GOSHEN COACH	VARIOUS GRECH MOTORS VARIOUS
F	16-23	GULF STREAM	BT CRUISER All MotorHomes with Ford E350 or E450 Chassis
F	99-06	CAVALIER	
F	12-15	CONQUEST	
F	93-01	CONQUEST	
F	16-22	CONQUEST	All MotorHomes with Ford E350 or E450 Chassis
F	02-11	CONQUEST	All MotorHomes with Ford E350 or E450 Chassis
F	10-11	CONQUEST SPORT	All MotorHomes with Ford E350 or E450 Chassis
F	01-02	CONQUEST SPORT	All MotorHomes with Ford E350 or E450 Chassis
F	00-11	INDEPENDENCE	All MotorHomes with Ford E350 or E450 Chassis
F	10-11	MONTAJ	All MotorHomes with Ford E350 or E450 Chassis
F	00-08	ULTRA	
F	02-04	YELLOWSTONE	
F	05-11	YELLOWSTONE	All MotorHomes with Ford E350 or E450 Chassis
F	19	HOLIDAY RAMBLER	ALTERA All MotorHomes with Ford E450 Chassis
F	18	ALTERA	
F	08	ATLANTIS	
F	06	ATLANTIS	
F	99-01	ATLANTIS	
F	09-10	ATLANTIS	All MotorHomes with Ford E450 Chassis
F	07	ATLANTIS	All MotorHomes with Ford E450 Chassis
F	02-05	ATLANTIS	All MotorHomes with Ford E450 Chassis
F	19	AUGUSTA	All MotorHomes with Ford E450 Chassis
F	15-16	AUGUSTA	All MotorHomes with Ford E450 Chassis
F	11	AUGUSTA	All MotorHomes with Ford E450 Chassis
F	08-09	AUGUSTA	All MotorHomes with Ford E450 Chassis

Ultra Truck Shock

Shock	POP	Alternative No.	MTG Acc. Supplied
Pos.	Year	Application	
G63622	N	(cont)	142617
F	12-13	AUGUSTA B+	All MotorHomes with Ford E450 Chassis
F	10	AUGUSTA B+	All MotorHomes with Ford E450 Chassis
F	07	AUGUSTA B+	All MotorHomes with Ford E450 Chassis
F	16	AUGUSTA LX	All MotorHomes with Ford E450 Chassis
F	07-10	AUGUSTA SPORT	All MotorHomes with Ford E350 Chassis
F	07-09	AUGUSTA TOURING SEDAN	All MotorHomes with Ford E350 Chassis
F	17-18	VESTA	All MotorHomes with Ford E450 Chassis
F	01-20	ITASCA	CLASS C MOTORHOMES
F	03-06	JAYCO	ESCAPADE All MotorHomes with Ford E350 or E450 Chassis
F	02-06	GRANITE RIDGE	All MotorHomes with Ford E350 or E450 Chassis
F	02-24	GREYHAWK	All MotorHomes with Ford E450 Chassis
F	07-24	MELBOURNE	All MotorHomes with Ford E350 or E450 Chassis
F	13-24	REDHAWK	All MotorHomes with Ford E450 Chassis
F	18-24	REDHAWK SE	All MotorHomes with Ford E450 Chassis
F	11-12	NEXUS	CLASS C MOTORHOMES
F	11-24	PHANTOM	All MotorHomes with Ford E350 or E450 Chassis
F	20-24	TRIUMPH	All MotorHomes with Ford E350 or E450 Chassis
F	11-24	VIPER	All MotorHomes with Ford E350 or E450 Chassis
F	00-23	PHOENIX	CRUISER All MotorHomes with Ford E350 or E450 Chassis
F	14-24	THOR MOTOR COACH	AXIS All MotorHomes with Ford E350 or E450 Chassis
F	11-24	CHATEAU	All MotorHomes with Ford E350 or E450 Chassis
F	11-12	CHATEAU CITATION	All MotorHomes with Ford E350 or E450 Chassis
F	12-16	CITATION	All MotorHomes with Ford E350 or E450 Chassis
F	22-24	ECHELON	All MotorHomes with Ford E350 or E450 Chassis
F	11-24	FOUR WINDS	All MotorHomes with Ford E350 or E450 Chassis
F	12-23	FREEDOM ELITE	All MotorHomes with Ford E350 or E450 Chassis
F	11-23	OUTLAW	All MotorHomes with Ford E350 or E450 Chassis
F	16-24	QUANTUM	All MotorHomes with Ford E350 or E450 Chassis
F	14-24	VEGAS	All MotorHomes with Ford E350 or E450 Chassis
F	07-13	TURTLETOP BUS	VARIOUS WHEELED COACH IND. VARIOUS
F	14	ACCESS PREMIER	All MotorHomes with Ford E350 or E450 Chassis
F	18-20	ASPECT	
F	05-17	ASPECT	All MotorHomes with Ford E350 or E450 Chassis
F	18-20	CAMBRIA	
F	09-15	CAMBRIA	
F	16-17	CAMBRIA	All MotorHomes with Ford E350 or E450 Chassis
F	05-08	CAMBRIA	All MotorHomes with Ford E350 or E450 Chassis
F	06-20	MINNIE	
F	99	MINNIE	
F	00-05	MINNIE	All MotorHomes with Ford E350 or E450 Chassis
F	14-24	MINNIE WINNIE	All MotorHomes with Ford E350 or E450 Chassis
F	00-06	MINNIE WINNIE	All MotorHomes with Ford E350 or E450 Chassis
F	11-18	OUTLOOK	

Numerical listing

Shock	POP	Alternative No.	MTG Acc. Supplied
Pos.	Year	Application	
G63622	N	(cont)	142617
F	19-21	OUTLOOK	All MotorHomes with Ford E350 or E450 Chassis
F	06-10	OUTLOOK	All MotorHomes with Ford E350 or E450 Chassis
F	08-15	SPIRIT	
F	16-22	SPIRIT	All MotorHomes with Ford E350 or E450 Chassis
F	00-07	SPIRIT	All MotorHomes with Ford E350 or E450 Chassis
F		WORLD TRANS BUS CO.	VARIOUS
G63623	N		142617
R	17-24	BERKSHIRE COACH	ULTRA 24
R	17-24	ULTRA 28	
R	92-24	BLUE BIRD	MICROBIRD TYPE A SCHOOL BUS
R		CHAMPION BUS INC.	AMERICAN COACH
R		CHALLENGER	
R		CRUSADER	
R		LF TRANSPORT	
R	03-24	COACH HOUSE	PLATINUM All MotorHomes with Ford E450 Chassis
R	23-24	PLATINUM IV	All MotorHomes with Ford E450 Chassis
R	24	CONCORD	
R	20-22	CONCORD	
R	04-06	CONCORD	
R	23	CONCORD	All MotorHomes with Ford E350 or E450 Chassis
R	07-19	CONCORD	All MotorHomes with Ford E350 or E450 Chassis
R	04-08	FREEDOM EXPRESS	
R	09	FREEDOM EXPRESS	All MotorHomes with Ford E350 or E450 Chassis
R	03-07	FREELANDER	
R	08-24	FREELANDER	All MotorHomes with Ford E350 or E450 Chassis
R	10	LEPRECHAUN	
R	03-07	LEPRECHAUN	
R	11-23	LEPRECHAUN	All MotorHomes with Ford E350 or E450 Chassis
R	08-09	LEPRECHAUN	All MotorHomes with Ford E350 or E450 Chassis
R	98-03	PATHFINDER	
R	99-06	SANTARA	
R		COLLINS BUS CORP.	VARIOUS DIAMOND COACH SHUTTLE BUSES
R	92-09	DUTCHMEN RV	CLASS C MOTORHOMES
R	15-20	JAMBOREE	
R	92-17	DYNAMAX CORP	ISATA 4
R	18-20	ISATA 4	All MotorHomes with Ford E350 or E450 Chassis
R		ELDORADO NATIONAL	ADVANTAGE AEROLITE AEROTECH
R	17	ENTEGRA COACH	ESTEEM
R	18-24	ESTEEM	All MotorHomes with Ford E350 or E450 Chassis
R	17	ODYSSEY	
R	18-24	ODYSSEY	All MotorHomes with Ford E350 or E450 Chassis
R		FEDERAL COACH	VARIOUS FLEETWOOD JAMBOREE
R	14-16	JAMBOREE	
R	99-07	JAMBOREE	
R	17-19	JAMBOREE	All MotorHomes with Ford E350 or E450 Chassis
R	08-13	JAMBOREE	All MotorHomes with Ford E350 or E450 Chassis
R	19-20	SURGE	
R	18	SURGE	All MotorHomes with Ford E350 or E450 Chassis
R	14-16	TIOGA	
R	99-07	TIOGA	
R	08-13	TIOGA	All MotorHomes with Ford E350 or E450 Chassis
R	00-02	FORD	E-450 ECONOLINE SUPER DUTY All
R	21-22	VAN 1 TON, ECONOLINE / CLUB WAGON / SUPERDUTY	All
R	03-19	VAN 1 TON, ECONOLINE / CLUB WAGON / SUPERDUTY	All
R	20	FOREST RIVER	ALL AMERICAN FORESTER
R	04-19	FORESTER	All MotorHomes with Ford E350 or E450 Chassis

Numerical listing

Ultra Truck Shock, Steering Dampers, Max Control

Numerical listing

Shock	POP	Alternative No.	MTG Acc. Supplied
Pos.	Year	Application	
G63623	N (cont)		142617
R	15-18	FORESTER GTS All MotorHomes with Ford E350 or E450 Chassis	
R	03-15	LEXINGTON All MotorHomes with Ford E350 or E450 Chassis	
R	21-23	SOLERA All MotorHomes with Ford E350 or E450 Chassis	
R	10-15	SOLERA All MotorHomes with Ford E350 or E450 Chassis	
R	23	SUNSEEKER	
R	99-06	SUNSEEKER	
R	07-22	SUNSEEKER All MotorHomes with Ford E350 or E450 Chassis	
R	19-20	SUNSEEKER GTS	
R	15-18	SUNSEEKER GTS All MotorHomes with Ford E350 or E450 Chassis	
R	99-09	GEORGIE BOY MANUFACTURING CLASS C MOTORHOMES	
R		GLAVAL BUS CO. VARIOUS	
R		GOSHEN COACH VARIOUS	
R		GRECH MOTORS VARIOUS	
R	02-15	GULF STREAM BT CRUISER	
R	16-23	BT CRUISER All MotorHomes with Ford E350 or E450 Chassis	
R	99-06	CAVALIER	
R	12-15	CONQUEST	
R	93-01	CONQUEST	
R	16-22	CONQUEST All MotorHomes with Ford E350 or E450 Chassis	
R	02-11	CONQUEST All MotorHomes with Ford E350 or E450 Chassis	
R	10-11	CONQUEST SPORT All MotorHomes with Ford E350 or E450 Chassis	
R	01-02	CONQUEST SPORT All MotorHomes with Ford E350 or E450 Chassis	
R	00-11	INDEPENDENCE All MotorHomes with Ford E350 or E450 Chassis	
R	10-11	MONTAJ All MotorHomes with Ford E350 or E450 Chassis	
R	00-08	ULTRA	
R	02-04	YELLOWSTONE	
R	05-11	YELLOWSTONE All MotorHomes with Ford E350 or E450 Chassis	
R	19	HOLIDAY RAMBLER ALTERA	
R	18	ALTERA All MotorHomes with Ford E450 Chassis	
R	08	ATLANTIS	
R	06	ATLANTIS	
R	99-01	ATLANTIS	
R	09-10	ATLANTIS All MotorHomes with Ford E450 Chassis	
R	07	ATLANTIS All MotorHomes with Ford E450 Chassis	
R	02-05	ATLANTIS All MotorHomes with Ford E450 Chassis	
R	19	AUGUSTA All MotorHomes with Ford E450 Chassis	
R	15-16	AUGUSTA All MotorHomes with Ford E450 Chassis	
R	11	AUGUSTA All MotorHomes with Ford E450 Chassis	
R	08-09	AUGUSTA All MotorHomes with Ford E450 Chassis	
R	12-13	AUGUSTA B+ All MotorHomes with Ford E450 Chassis	
R	10	AUGUSTA B+ All MotorHomes with Ford E450 Chassis	
R	07	AUGUSTA B+ All MotorHomes with Ford E450 Chassis	
R	16	AUGUSTA LX All MotorHomes with Ford E450 Chassis	
R	07-10	AUGUSTA SPORT All MotorHomes with Ford E350 Chassis	
R	07-09	AUGUSTA TOURING SEDAN All MotorHomes with Ford E350 Chassis	
R	17-18	VESTA All MotorHomes with Ford E450 Chassis	
R	01-20	ITASCA CLASS C MOTORHOMES	
R	03-06	JAYCO ESCAPADE All MotorHomes with Ford E350 or E450 Chassis	
R	02-06	GRANITE RIDGE All MotorHomes with Ford E350 or E450 Chassis	
R	02-24	GREYHAWK All MotorHomes with Ford E450 Chassis	
R	07-24	MELBOURNE All MotorHomes with Ford E350 or E450 Chassis	
R	13-24	REDHAWK All MotorHomes with Ford E450 Chassis	
R	18-24	REDHAWK SE All MotorHomes with Ford E450 Chassis	
R		KRYSTAL BUS VARIOUS	

Shock	POP	Alternative No.	MTG Acc. Supplied
Pos.	Year	Application	
G63623	N (cont)		142617
R		LGE COACHWORKS VARIOUS	
R	11-20	NEXUS CLASS C MOTORHOMES	
R	11-24	PHANTOM All MotorHomes with Ford E350 or E450 Chassis	
R	20-24	TRIUMPH All MotorHomes with Ford E350 or E450 Chassis	
R	11-24	VIPER All MotorHomes with Ford E350 or E450 Chassis	
R	00-23	PHOENIX CRUISER All MotorHomes with Ford E350 or E450 Chassis	
R		SHASTA RV ALL MODELS	
R		STARCRAFT BUS CO. E350 & E450 FORD CHASSIS MODELS	
R	92-20	THOMAS TYPE A SCHOOL BUS	
R	14-24	THOR MOTOR COACH AXIS All MotorHomes with Ford E350 or E450 Chassis	
R	99-10	CHATEAU	
R	11-24	CHATEAU All MotorHomes with Ford E350 or E450 Chassis	
R	13	CHATEAU CITATION	
R	08-10	CHATEAU CITATION	
R	11-12	CHATEAU CITATION All MotorHomes with Ford E350 or E450 Chassis	
R	01-11	CITATION	
R	12-16	CITATION All MotorHomes with Ford E350 or E450 Chassis	
R	22-24	ECHOLON All MotorHomes with Ford E350 or E450 Chassis	
R	01-10	FOUR WINDS	
R	11-24	FOUR WINDS All MotorHomes with Ford E350 or E450 Chassis	
R	10-11	FREEDOM ELITE	
R	12-23	FREEDOM ELITE All MotorHomes with Ford E350 or E450 Chassis	
R	11-23	OUTLAW All MotorHomes with Ford E350 or E450 Chassis	
R	16-24	QUANTUM All MotorHomes with Ford E350 or E450 Chassis	
R	14-24	VEGAS All MotorHomes with Ford E350 or E450 Chassis	
R		TURTLETOP BUS VARIOUS	
R		WHEELED COACH IND. VARIOUS	
R	07-13	WINNEBAGO ACCESS All MotorHomes with Ford E350 or E450 Chassis	
R	14	ACCESS PREMIER All MotorHomes with Ford E350 or E450 Chassis	
R	18-20	ASPECT	
R	06-17	ASPECT All MotorHomes with Ford E350 or E450 Chassis	
R	18-20	CAMBRIA	
R	09-15	CAMBRIA	
R	16-17	CAMBRIA All MotorHomes with Ford E350 or E450 Chassis	
R	05-08	CAMBRIA All MotorHomes with Ford E350 or E450 Chassis	
R	06-20	MINNIE	
R	99	MINNIE	
R	00-05	MINNIE All MotorHomes with Ford E350 or E450 Chassis	
R	14-24	MINNIE WINNIE All MotorHomes with Ford E350 or E450 Chassis	
R	00-06	MINNIE WINNIE All MotorHomes with Ford E350 or E450 Chassis	
R	11-18	OUTLOOK	
R	19-21	OUTLOOK All MotorHomes with Ford E350 or E450 Chassis	
R	06-10	OUTLOOK All MotorHomes with Ford E350 or E450 Chassis	
R	08-15	SPIRIT	
R	16-22	SPIRIT All MotorHomes with Ford E350 or E450 Chassis	
R	00-07	SPIRIT All MotorHomes with Ford E350 or E450 Chassis	
R		WORLD TRANS BUS CO. VARIOUS	
G63692	D		
F	97	FORD PICKUP, F-450 SUPERDUTY All	
G63809	A		
F	99-04	FORD PICKUP, F-450 SUPERDUTY All	
F	99-04	PICKUP, F-550 SUPERDUTY All	
G63866	A		
R		WORKHORSE VARIOUS	
G63895	A		143276
F	09-22	CHEVROLET EXPRESS 4500 All	

Shock	POP	Alternative No.	MTG Acc. Supplied
Pos.	Year	Application	
G63895	A (cont)		143276
F	10-20	GMC SAVANA 4500 All	
G63897	A		
R	09-22	CHEVROLET EXPRESS 4500 All	
R	10-20	GMC SAVANA 4500 All	
G63969	D		143146
F	05-08	FORD PICKUP, F-450 SUPERDUTY All	
F	05-07	PICKUP, F-550 SUPERDUTY All	
G64177	C		
R	21-22	COACH HOUSE PLATINUM III All MotorHomes with Ford Transit-350 Chassis	
R	19-22	COACHMEN BEYOND All MotorHomes with Ford Transit-350 Chassis	
R	21-22	CROSS TRAIL TRANSIT All MotorHomes with Ford Transit-350 Chassis	
R	17-22	FOREST RIVER FORESTER TS All MotorHomes with Ford Transit-350 Chassis	
R	17-22	SUNSEEKER TS All MotorHomes with Ford Transit-350 Chassis	
R	19-22	LEISURE TRAVEL WONDER All MotorHomes with Ford Transit-350 Chassis	
R	20-22	PHOENIX TRX All MotorHomes with Ford Transit-350 Chassis	
R	19-22	THOR MOTOR COACH GEMINI All MotorHomes with Ford Transit-350 Chassis	
R	21-22	WINNEBAGO EKKO All MotorHomes with Ford Transit-350 Chassis	
Steering Dampers			
14072	B		
F	08-22	FORD PICKUP, F-450 SUPERDUTY 4 X 4	
F	08-22	PICKUP, F-550 SUPERDUTY 4 X 4	
Max Control			
77461	C		
R	99-04	FORD PICKUP, F-450 SUPERDUTY All	
R	99-04	PICKUP, F-550 SUPERDUTY All	
77614	B		140780
F	17-24	BERKSHIRE COACH ULTRA 24	
F	17-24	ULTRA 28	
F	92-24	BLUE BIRD MICROBIRD TYPE A SCHOOL BUS	
F		CHAMPION BUS INC. AMERICAN COACH	
F		CHALLENGER	
F		CRUSADER	
F		LF TRANSPORT	
F	03-24	COACH HOUSE PLATINUM All Motorhomes with Ford E450 Chassis	
F	23-24	PLATINUM IV All Motorhomes with Ford E450 Chassis	
F		COACHMEN CATALINA	
F	24	CONCORD	
F	20-22	CONCORD	
F	04-06	CONCORD	
F	23	CONCORD All MotorHomes with Ford E350 or E450 Chassis	
F	07-19	CONCORD All MotorHomes with Ford E350 or E450 Chassis	
F	04-08	FREEDOM EXPRESS	
F	09	FREEDOM EXPRESS All MotorHomes with Ford E350 or E450 Chassis	
F	03-07	FREELANDER	
F	08-24	FREELANDER All MotorHomes with Ford E350 or E450 Chassis	
F	10	LEPRECHAUN	
F	03-07	LEPRECHAUN	
F	11-23	LEPRECHAUN All MotorHomes with Ford E350 or E450 Chassis	
F	08-09	LEPRECHAUN All MotorHomes with Ford E350 or E450 Chassis	
F	98-03	PATHFINDER	
F	99-06	SANTARA	
F		COLLINS BUS CORP. VARIOUS DIAMOND COACH SHUTTLE BUSES	
F	92-09	DUTCHMEN RV CLASS C MOTORHOMES	
F	15-20	JAMBOREE	
F	92-17	DYNAMAX CORP ISATA 4	

Numerical listing

Shock	POP	Alternative No.	MTG Acc. Supplied
Pos.	Year	Application	
77614		B (cont)	140780
F	18-20	ISATA 4 All MotorHomes with Ford E350 or E450 Chassis	
F		ELDORADO NATIONAL ADVANTAGE	
F		AEROLITE	
F		AEROTECH	
F	17	ENTEGRA COACH ESTEEM	
F	18-24	ESTEEM All MotorHomes with Ford E350 or E450 Chassis	
F	17	ODYSSEY	
F	18-24	ODYSSEY All MotorHomes with Ford E350 or E450 Chassis	
F		FEDERAL COACH VARIOUS	
F	20	FLEETWOOD JAMBOREE	
F	14-16	JAMBOREE	
F	99-07	JAMBOREE	
F	17-19	JAMBOREE All MotorHomes with Ford E350 or E450 Chassis	
F	08-13	JAMBOREE All MotorHomes with Ford E350 or E450 Chassis	
F	19-20	SURGE	
F	18	SURGE All MotorHomes with Ford E350 or E450 Chassis	
F	14-16	TIOGA	
F	99-07	TIOGA	
F	08-13	TIOGA All MotorHomes with Ford E350 or E450 Chassis	
F	00-02	FORD E-450 ECONOLINE SUPER DUTY All	
F	21-24	VAN 1 TON, ECONOLINE / CLUB WAGON / SUPERDUTY All	
F	03-19	VAN 1 TON, ECONOLINE / CLUB WAGON / SUPERDUTY All	
F		FOREST RIVER ALL AMERICAN FORESTER	
F	04-19	FORESTER All MotorHomes with Ford E350 or E450 Chassis	
F	15-18	FORESTER GTS All MotorHomes with Ford E350 or E450 Chassis	
F	03-15	LEXINGTON All MotorHomes with Ford E350 or E450 Chassis	
F	21-23	SOLERA All MotorHomes with Ford E350 or E450 Chassis	
F	10-15	SOLERA All MotorHomes with Ford E350 or E450 Chassis	
F	23	SUNSEEKER	
F	99-06	SUNSEEKER	
F	07-22	SUNSEEKER All MotorHomes with Ford E350 or E450 Chassis	
F	19-20	SUNSEEKER GTS	
F	15-18	SUNSEEKER GTS All MotorHomes with Ford E350 or E450 Chassis	
F	99-09	GEORGIE BOY MANUFACTURING CLASS C MOTORHOMES	
F		GLAVAL BUS CO. VARIOUS	
F		GOSHEN COACH VARIOUS	
F		GRECH MOTORS VARIOUS	
F	02-15	GULF STREAM BT CRUISER	
F	16-23	BT CRUISER All MotorHomes with Ford E350 or E450 Chassis	
F	99-06	CAVALIER	
F	12-15	CONQUEST	
F	93-01	CONQUEST	
F	16-22	CONQUEST All MotorHomes with Ford E350 or E450 Chassis	
F	02-11	CONQUEST All MotorHomes with Ford E350 or E450 Chassis	
F	10-11	CONQUEST SPORT All MotorHomes with Ford E350 or E450 Chassis	
F	01-02	CONQUEST SPORT All MotorHomes with Ford E350 or E450 Chassis	
F	00-11	INDEPENDENCE All MotorHomes with Ford E350 or E450 Chassis	
F	10-11	MONTAJ All MotorHomes with Ford E350 or E450 Chassis	
F	00-08	ULTRA	
F	02-04	YELLOWSTONE	
F	05-11	YELLOWSTONE All MotorHomes with Ford E350 or E450 Chassis	
F	19	HOLIDAY RAMBLER ALTERA	
F	18	ALTERA All MotorHomes with Ford E450 Chassis	
F	08	ATLANTIS	
F	06	ATLANTIS	
F	99-01	ATLANTIS	
F	09-10	ATLANTIS All MotorHomes with Ford E450 Chassis	
F	07	ATLANTIS All MotorHomes with Ford E450 Chassis	
F	02-05	ATLANTIS All MotorHomes with Ford E450 Chassis	

Max Control

Shock	POP	Alternative No.	MTG Acc. Supplied
Pos.	Year	Application	
77614		B (cont)	140780
F	19	AUGUSTA All MotorHomes with Ford E450 Chassis	
F	15-16	AUGUSTA All MotorHomes with Ford E450 Chassis	
F	11	AUGUSTA All MotorHomes with Ford E450 Chassis	
F	08-09	AUGUSTA All MotorHomes with Ford E450 Chassis	
F	12-13	AUGUSTA B+ All MotorHomes with Ford E450 Chassis	
F	10	AUGUSTA B+ All MotorHomes with Ford E450 Chassis	
F	07	AUGUSTA B+ All MotorHomes with Ford E450 Chassis	
F	16	AUGUSTA LX All MotorHomes with Ford E450 Chassis	
F	07-10	AUGUSTA SPORT All MotorHomes with Ford E350 Chassis	
F	07-09	AUGUSTA TOURING SEDAN All MotorHomes with Ford E350 Chassis	
F	17-18	VESTA All MotorHomes with Ford E450 Chassis	
F	01-20	ITASCA CLASS C MOTORHOMES	
F	03-06	JAYCO ESCAPADE All MotorHomes with Ford E350 or E450 Chassis	
F	02-06	GRANITE RIDGE All MotorHomes with Ford E350 or E450 Chassis	
F	02-24	GREYHAWK All MotorHomes with Ford E450 Chassis	
F	07-24	MELBOURNE All MotorHomes with Ford E350 or E450 Chassis	
F	13-24	REDHAWK All MotorHomes with Ford E450 Chassis	
F	18-24	REDHAWK SE All MotorHomes with Ford E450 Chassis	
F		KRYSTAL BUS VARIOUS	
F	11-12	LGE COACHWORKS VARIOUS	
F	11-12	NEXUS CLASS C MOTORHOMES	
F	11-24	PHANTOM All MotorHomes with Ford E350 or E450 Chassis	
F	20-24	TRIUMPH All MotorHomes with Ford E350 or E450 Chassis	
F	11-24	VIPER All MotorHomes with Ford E350 or E450 Chassis	
F	00-23	PHOENIX CRUISER All MotorHomes with Ford E350 or E450 Chassis	
F		SHASTA RV ALL MODELS	
F		STARCRRAFT BUS CO. E350 & E450 FORD CHASSIS MODELS	
F	92-22	THOMAS TYPE A SCHOOL BUS	
F	14-24	THOR MOTOR COACH AXIS All MotorHomes with Ford E350 or E450 Chassis	
F	11-24	CHATEAU All MotorHomes with Ford E350 or E450 Chassis	
F	11-12	CHATEAU CITATION All MotorHomes with Ford E350 or E450 Chassis	
F	12-16	CITATION All MotorHomes with Ford E350 or E450 Chassis	
F	22-24	ECHELON All MotorHomes with Ford E350 or E450 Chassis	
F	11-24	FOUR WINDS All MotorHomes with Ford E350 or E450 Chassis	
F	12-23	FREEDOM ELITE All MotorHomes with Ford E350 or E450 Chassis	
F	11-23	OUTLAW All MotorHomes with Ford E350 or E450 Chassis	
F	16-24	QUANTUM All MotorHomes with Ford E350 or E450 Chassis	
F	14-24	VEGAS All MotorHomes with Ford E350 or E450 Chassis	
F		TURTLETOP BUS VARIOUS	
F		WHEELED COACH IND. VARIOUS	
F	07-13	WINNEBAGO ACCESS All MotorHomes with Ford E350 or E450 Chassis	
F	14	ACCESS PREMIER All MotorHomes with Ford E350 or E450 Chassis	
F	18-20	ASPECT	
F	05-17	ASPECT All MotorHomes with Ford E350 or E450 Chassis	
F	18-20	CAMBRIA	
F	09-15	CAMBRIA	
F	16-17	CAMBRIA All MotorHomes with Ford E350 or E450 Chassis	
F	05-08	CAMBRIA All MotorHomes with Ford E350 or E450 Chassis	
F	06-20	MINNIE	
F	99	MINNIE	

Numerical listing

Shock	POP	Alternative No.	MTG Acc. Supplied
Pos.	Year	Application	
77614		B (cont)	140780
F	00-05	MINNIE All MotorHomes with Ford E350 or E450 Chassis	
F	14-24	MINNIE WINNIE All MotorHomes with Ford E350 or E450 Chassis	
F	00-06	MINNIE WINNIE All MotorHomes with Ford E350 or E450 Chassis	
F	11-18	OUTLOOK	
F	19-21	OUTLOOK All MotorHomes with Ford E350 or E450 Chassis	
F	06-10	OUTLOOK All MotorHomes with Ford E350 or E450 Chassis	
F	08-15	SPIRIT	
F	16-22	SPIRIT All MotorHomes with Ford E350 or E450 Chassis	
F	00-07	SPIRIT All MotorHomes with Ford E350 or E450 Chassis	
F		WORLD TRANS BUS CO. VARIOUS	
77623		C	142731
R	17-24	BERKSHIRE COACH ULTRA 24	
R	17-24	ULTRA 28	
R	92-24	BLUE BIRD MICROBIRD TYPE A SCHOOL BUS	
R		CHAMPION BUS INC. AMERICAN COACH	
R		CHALLENGER	
R		CRUSADER	
R		LF TRANSPORT	
R	03-24	COACH HOUSE PLATINUM All Motorhomes with Ford E450 Chassis	
R	23-24	PLATINUM IV All Motorhomes with Ford E450 Chassis	
R		COACHMEN CATALINA	
R	24	CONCORD	
R	20-22	CONCORD	
R	04-06	CONCORD	
R	23	CONCORD All MotorHomes with Ford E350 or E450 Chassis	
R	07-19	CONCORD All MotorHomes with Ford E350 or E450 Chassis	
R	04-08	FREEDOM EXPRESS	
R	09	FREEDOM EXPRESS All MotorHomes with Ford E350 or E450 Chassis	
R	03-07	FREELANDER	
R	08-24	FREELANDER All MotorHomes with Ford E350 or E450 Chassis	
R	10	LEPRECHAUN	
R	03-07	LEPRECHAUN	
R	11-23	LEPRECHAUN All MotorHomes with Ford E350 or E450 Chassis	
R	08-09	LEPRECHAUN All MotorHomes with Ford E350 or E450 Chassis	
R	98-03	PATHFINDER	
R	99-06	SANTARA	
R		COLLINS BUS CORP. VARIOUS DIAMOND COACH SHUTTLE BUSES	
R	92-09	DUTCHMEN RV CLASS C MOTORHOMES	
R	15-20	JAMBOREE	
R	92-17	DYNAMAX CORP ISATA 4	
R	18-20	ISATA 4 All MotorHomes with Ford E350 or E450 Chassis	
R		ELDORADO NATIONAL ADVANTAGE	
R		AEROLITE	
R		AEROTECH	
R	17	ENTEGRA COACH ESTEEM	
R	18-24	ESTEEM All MotorHomes with Ford E350 or E450 Chassis	
R	17	ODYSSEY	
R	18-24	ODYSSEY All MotorHomes with Ford E350 or E450 Chassis	
R		FEDERAL COACH VARIOUS	
R		FLEETWOOD JAMBOREE	
R	14-16	JAMBOREE	
R	99-07	JAMBOREE	
R	17-19	JAMBOREE All MotorHomes with Ford E350 or E450 Chassis	
R	08-13	JAMBOREE All MotorHomes with Ford E350 or E450 Chassis	
R	19-20	SURGE	
R	18	SURGE All MotorHomes with Ford E350 or E450 Chassis	
R	14-16	TIOGA	
R	99-07	TIOGA	
R	08-13	TIOGA All MotorHomes with Ford E350 or E450 Chassis	
R	00-02	FORD E-450 ECONOLINE SUPER DUTY All	
R	00-02	E-450 ECONOLINE SUPER DUTY All Exc. Cutaway Chassis	

Numerical listing

Max Control, Guardian Shock, Classic Shock Absorbers

Numerical listing

Shock	POP	Alternative No.	MTG Acc. Supplied
Pos.	Year	Application	
77623	C (cont)		142731
R	21-24	VAN 1 TON, ECONOLINE / CLUB WAGON / SUPERDUTY All	
R	03-19	VAN 1 TON, ECONOLINE / CLUB WAGON / SUPERDUTY All Exc. Cutaway Chassis	
R		FOREST RIVER ALL AMERICAN FORESTER	
R	20	FORESTER	
R	04-19	FORESTER All MotorHomes with Ford E350 or E450 Chassis	
R	15-18	FORESTER GTS All MotorHomes with Ford E350 or E450 Chassis	
R	03-15	LEXINGTON All MotorHomes with Ford E350 or E450 Chassis	
R	21-23	SOLERA All MotorHomes with Ford E350 or E450 Chassis	
R	10-15	SOLERA All MotorHomes with Ford E350 or E450 Chassis	
R	23	SUNSEEKER	
R	99-06	SUNSEEKER	
R	07-22	SUNSEEKER All MotorHomes with Ford E350 or E450 Chassis	
R	19-20	SUNSEEKER GTS	
R	15-18	SUNSEEKER GTS All MotorHomes with Ford E350 or E450 Chassis	
R	99-09	GEORGIE BOY MANUFACTURING CLASS C MOTORHOMES GLAVAL BUS CO. VARIOUS GOSHEN COACH VARIOUS GRECH MOTORS VARIOUS GULF STREAM BT CRUISER	
R	02-15	BT CRUISER All MotorHomes with Ford E350 or E450 Chassis	
R	16-23	CAVALIER	
R	99-06	CONQUEST	
R	12-15	CONQUEST	
R	93-01	CONQUEST All MotorHomes with Ford E350 or E450 Chassis	
R	16-22	CONQUEST All MotorHomes with Ford E350 or E450 Chassis	
R	02-11	CONQUEST All MotorHomes with Ford E350 or E450 Chassis	
R	10-11	CONQUEST SPORT All MotorHomes with Ford E350 or E450 Chassis	
R	01-02	CONQUEST SPORT All MotorHomes with Ford E350 or E450 Chassis	
R	00-11	INDEPENDENCE All MotorHomes with Ford E350 or E450 Chassis	
R	10-11	MONTAJ All MotorHomes with Ford E350 or E450 Chassis	
R	00-08	ULTRA	
R	02-04	YELLOWSTONE	
R	05-11	YELLOWSTONE All MotorHomes with Ford E350 or E450 Chassis	
R	19	HOLIDAY RAMBLER ALTERA	
R	18	ALTERA All MotorHomes with Ford E450 Chassis	
R	08	ATLANTIS	
R	06	ATLANTIS	
R	99-01	ATLANTIS	
R	09-10	ATLANTIS All MotorHomes with Ford E450 Chassis	
R	07	ATLANTIS All MotorHomes with Ford E450 Chassis	
R	02-05	ATLANTIS All MotorHomes with Ford E450 Chassis	
R	19	AUGUSTA All MotorHomes with Ford E450 Chassis	
R	15-16	AUGUSTA All MotorHomes with Ford E450 Chassis	
R	11	AUGUSTA All MotorHomes with Ford E450 Chassis	
R	08-09	AUGUSTA All MotorHomes with Ford E450 Chassis	
R	12-13	AUGUSTA B+ All MotorHomes with Ford E450 Chassis	
R	10	AUGUSTA B+ All MotorHomes with Ford E450 Chassis	
R	07	AUGUSTA B+ All MotorHomes with Ford E450 Chassis	
R	16	AUGUSTA LX All MotorHomes with Ford E450 Chassis	
R	07-10	AUGUSTA SPORT All MotorHomes with Ford E350 Chassis	
R	07-09	AUGUSTA TOURING SEDAN All MotorHomes with Ford E350 Chassis	
R	17-18	VESTA All MotorHomes with Ford E450 Chassis	
R	01-20	ITASCA CLASS C MOTORHOMES	
R	03-06	JAYCO ESCAPADE All MotorHomes with Ford E350 or E450 Chassis	
R	02-06	GRANITE RIDGE All MotorHomes with Ford E350 or E450 Chassis	

Shock	POP	Alternative No.	MTG Acc. Supplied
Pos.	Year	Application	
77623	C (cont)		142731
R	02-24	GREYHAWK All MotorHomes with Ford E450 Chassis	
R	07-24	MELBOURNE All MotorHomes with Ford E350 or E450 Chassis	
R	13-24	REDHAWK All MotorHomes with Ford E450 Chassis	
R	18-24	REDHAWK SE All MotorHomes with Ford E450 Chassis	
R		KRYSTAL BUS VARIOUS LGE COACHWORKS VARIOUS NEXUS CLASS C MOTORHOMES PHANTOM All MotorHomes with Ford E350 or E450 Chassis	
R	11-20	PHANTOM	
R	11-24	TRIUMPH All MotorHomes with Ford E350 or E450 Chassis	
R	20-24	TRIUMPH All MotorHomes with Ford E350 or E450 Chassis	
R	11-24	VIPER All MotorHomes with Ford E350 or E450 Chassis	
R	00-23	PHOENIX CRUISER All MotorHomes with Ford E350 or E450 Chassis	
R		SHASTA RV ALL MODELS STARCRAFT BUS CO. E350 & E450 FORD CHASSIS MODELS THOMAS TYPE A SCHOOL BUS THOR MOTOR COACH AXIS All MotorHomes with Ford E350 or E450 Chassis	
R	92-20	THOR MOTOR COACH AXIS	
R	14-24	CHATEAU All MotorHomes with Ford E350 or E450 Chassis	
R	11-24	CHATEAU CITATION All MotorHomes with Ford E350 or E450 Chassis	
R	11-12	CITATION All MotorHomes with Ford E350 or E450 Chassis	
R	12-16	CITATION All MotorHomes with Ford E350 or E450 Chassis	
R	22-24	ECHELON All MotorHomes with Ford E350 or E450 Chassis	
R	11-24	FOUR WINDS All MotorHomes with Ford E350 or E450 Chassis	
R	12-23	FREEDOM ELITE All MotorHomes with Ford E350 or E450 Chassis	
R	11-23	OUTLAW All MotorHomes with Ford E350 or E450 Chassis	
R	16-24	QUANTUM All MotorHomes with Ford E350 or E450 Chassis	
R	14-24	VEGAS All MotorHomes with Ford E350 or E450 Chassis	
R		TURTLETOP BUS VARIOUS WHEELED COACH IND. VARIOUS WINNEBAGO ACCESS All MotorHomes with Ford E350 or E450 Chassis	
R	07-13	WINNEBAGO ACCESS	
R	14	ACCESS PREMIER All MotorHomes with Ford E350 or E450 Chassis	
R	18-20	ASPECT	
R	06-17	ASPECT All MotorHomes with Ford E350 or E450 Chassis	
R	18-20	CAMBRIA	
R	09-15	CAMBRIA	
R	16-17	CAMBRIA All MotorHomes with Ford E350 or E450 Chassis	
R	05-08	CAMBRIA All MotorHomes with Ford E350 or E450 Chassis	
R	06-20	MINNIE	
R	99	MINNIE	
R	00-05	MINNIE All MotorHomes with Ford E350 or E450 Chassis	
R	14-24	MINNIE WINNIE All MotorHomes with Ford E350 or E450 Chassis	
R	00-06	MINNIE WINNIE All MotorHomes with Ford E350 or E450 Chassis	
R	11-18	OUTLOOK	
R	19-21	OUTLOOK All MotorHomes with Ford E350 or E450 Chassis	
R	06-10	OUTLOOK All MotorHomes with Ford E350 or E450 Chassis	
R	08-15	SPIRIT	
R	16-22	SPIRIT All MotorHomes with Ford E350 or E450 Chassis	
R	00-07	SPIRIT All MotorHomes with Ford E350 or E450 Chassis	
R		WORLD TRANS BUS CO. VARIOUS	
77638	C		
R	09-22	CHEVROLET EXPRESS 4500 All	
R	10-20	GMC SAVANA 4500 All	
77809	B		
F	99-04	FORD PICKUP, F-450 SUPERDUTY All	
F	99-04	PICKUP, F-550 SUPERDUTY All	

Shock	POP	Alternative No.	MTG Acc. Supplied
Pos.	Year	Application	
77967	C		143146
F	13-23	FORD PICKUP, F-450 SUPERDUTY All	
F	05-08	PICKUP, F-450 SUPERDUTY All	
F	13-23	PICKUP, F-550 SUPERDUTY All	
F	05-07	PICKUP, F-550 SUPERDUTY All	
77968	D		
R	13-16	FORD PICKUP, F-450 SUPERDUTY 4 X 2	
R	05-07	PICKUP, F-450 SUPERDUTY 4 X 2	
R	13-16	PICKUP, F-550 SUPERDUTY 4 X 2	
R	05-07	PICKUP, F-550 SUPERDUTY 4 X 2	
77969	D		
R	13-16	FORD PICKUP, F-450 SUPERDUTY 4 X 4	
R	05-07	PICKUP, F-450 SUPERDUTY 4 X 4	
R	13-16	PICKUP, F-550 SUPERDUTY 4 X 4	
R	05-07	PICKUP, F-550 SUPERDUTY 4 X 4	
77986	N		
R	17-23	FORD PICKUP, F-450 SUPERDUTY All Models with 4WD and OEM number	
R	17-23	PICKUP, F-550 SUPERDUTY All Models with 4WD and OEM number	
R	17-23	PIERCE MFG. INC. VARIOUS RENEGADE VERACRUZ All Models with Ford F-550 Chassis (4WD and OEM number)	
R	19-23	THOR MOTOR COACH MAGNITUDE All Models with Ford F-550 Chassis (4WD and OEM number)	
R	19-23	OMNI All Models with Ford F-550 Chassis (4WD and OEM number)	
77987	N		
R	17-23	FORD PICKUP, F-450 SUPERDUTY All Models with RWD and OEM number	
R	17-23	PICKUP, F-550 SUPERDUTY All Models with RWD and OEM number	
R	19-23	THOR MOTOR COACH MAGNITUDE All Models with Ford F-550 Chassis (RWD and OEM number)	
R	19-23	OMNI All Models with Ford F-550 Chassis (RWD and OEM number)	
Guardian Shock			
81147	A		
F	68-75	FORD PICKUP P350 All Up through 8000# GVW	
F	75-76	PICKUP P400 All Up through 8000# GVW	
F	68	INTERNATIONAL 1200C All Exc. 166" Wheelbase	
R	68	1200C All Exc. 166" Wheelbase	
F	68	1300C All Exc. 166" Wheelbase	
R	68	1300C All Exc. 166" Wheelbase	
R	68-72	M1100 / M1200 All	
R	69	M1400 All	
81342	C		
R	78-80	DODGE RD200 All	
81744	A		140780
F	21-24	FORD VAN 1 TON, ECONOLINE / CLUB WAGON / SUPERDUTY All	
F	10-19	VAN 1 TON, ECONOLINE / CLUB WAGON / SUPERDUTY All	
81825	C		
F	78-80	DODGE RD200 All	
81828	C		142617
R	21-24	FORD VAN 1 TON, ECONOLINE / CLUB WAGON / SUPERDUTY All	
R	10-19	VAN 1 TON, ECONOLINE / CLUB WAGON / SUPERDUTY All	
Classic Shock Absorbers			
82007	B		140349
F	68	INTERNATIONAL 1200C All Exc. 166" Wheelbase	
F	68	1300C All Exc. 166" Wheelbase	
F	68-72	M1100 / M1200 All	
F	69	M1400 All	
82065	C		140478
R	74	DODGE M300 All	
R	74	M350 All	

Numerical listing

Shock	POP	Alternative No.	MTG Acc. Supplied
Pos.	Year	Application	
83000 Series			
83101	C		
R	02-13	FORD F-650 All Models with Vari-Rate Rear Suspension	
R	02-13	F-750 All Models with Vari-Rate Rear Suspension	
F	13	INTERNATIONAL 4300LP All Models with O.E.M. Number	
83102	D		145089-000 (2)
F		THOMAS VARIOUS	
83107	D		145080 (2)
F	94-97	FORD F-700 All w/ Multileaf Spring and w/ 10000, 12000 or 13200 lb Axle	
F	94	F-800 All w/ Multileaf Spring and w/ 10000, 12000 or 13200 lb Axle	
83112	C		145128 (1)
R	21-23	DENNIS EAGLE PROVIEW All Models with Hendrickson HN-460 Rear Suspension	
R	17	PROVIEW All Models with Hendrickson HN-460 Rear Suspension	
83114	D		140780 (1)
F	99	ISUZU FRR	
F	00-03	FRR All	
F	95-98	FRR All	
F	86	FSR	
F	87-96	FSR All FSR Models	
F	88-94	NRR All	
F	89-94	UD 1800 All Models with O.E.M. Number	
F	99-04	1800CS All Models with O.E.M. Number	
F	89-94	2000 All Models with O.E.M. Number	
83119	D		
F		FREIGHTLINER VARIOUS	
83120	D		145089-000(1)/145143(1)
R	05-22	FREIGHTLINER B2 All Models with 15,000 lb Rear Suspension	
R	97-08	BUS CHASSIS	
R	95-05	FL50 All Models with 15,000 lb Rear Suspension	
R	91-05	FL60 All w/ 15000 lb Rear Suspension	
R	96-99	MC CHASSIS	
R	98-20	MT45 All Models with O.E.M. Number	
R	99-11	MT55 All Models with O.E.M. Number	
R		VARIOUS	
R	03-10	STERLING TRUCK ACTERRA All Models with 15000 lb Rear Suspension	
R	01-07	ACTERRA 5500 All Models with 15000 lb Rear Suspension	
R	01-07	ACTERRA 6500 All Models with 15000 lb Rear Suspension	
R	05-22	THOMAS VARIOUS	
R		UPS TRUCK VARIOUS	
83122	C		
R	97-09	CHEVROLET C6500 KODIAK All Models with Hendrickson Air Suspension (Stamping number 47902-13)	
R	97-09	C7500 KODIAK All Models with Hendrickson Air Suspension (Stamping number 47902-13)	
R	99	T6500 All Models with Hendrickson Air Suspension (Stamping number 47902-13)	
R	09	COACHMEN AURORA	
R	08	AURORA All MotorHomes with Ford F53 Chassis with 16,000 lb GVW to 22,000 lb GVW	
R	04-06	AURORA All MotorHomes with Ford F53 Chassis with 16,000 lb GVW to 22,000 lb GVW	
R	21-24	ENCORE All MotorHomes with Ford F53 Chassis with 16,000 lb GVW to 22,000 lb GVW	
R	11-16	ENCOUNTER All MotorHomes with Ford F53 Chassis with 16,000 lb GVW to 22,000 lb GVW	
R	99-07	MIRADA	

83000 Series

Shock	POP	Alternative No.	MTG Acc. Supplied
Pos.	Year	Application	
83122	C (cont)		
R	08-24	MIRADA All MotorHomes with Ford F53 Chassis with 16,000 lb GVW to 22,000 lb GVW	
R	04-12	PURSUIT	
R	13-24	PURSUIT All MotorHomes with Ford F53 Chassis with 16,000 lb GVW to 22,000 lb GVW	
R	00-14	DAMON CHALLENGER All MotorHomes with Ford F53 Chassis with 16,000 lb GVW to 22,000 lb GVW	
R	12-13	DAYBREAK	
R	99	DAYBREAK	
R	00-11	DAYBREAK All MotorHomes with Ford F53 Chassis with 16,000 lb GVW to 22,000 lb GVW	
R	99	INTRUDER	
R	00-07	INTRUDER All MotorHomes with Ford F53 Chassis with 16,000 lb GVW to 22,000 lb GVW	
R	12-14	OUTLAW	
R	07-11	OUTLAW All MotorHomes with Ford F53 Chassis with 16,000 lb GVW to 22,000 lb GVW	
R	19-24	ENTEGRA COACH EMBLEM All MotorHomes with Ford F53 Chassis with 16,000 lb GVW to 22,000 lb GVW	
R	19-24	VISION All MotorHomes with Ford F53 Chassis with 16,000 lb GVW to 22,000 lb GVW	
R	19-20	FLEETWOOD AXON	
R	18	AXON All MotorHomes with Ford F53 Chassis with 16,000 lb GVW to 22,000 lb GVW	
R	00-24	BOUNDER All MotorHomes with Ford F53 Chassis with 16,000 lb GVW to 22,000 lb GVW	
R	15-24	FLAIR All MotorHomes with Ford F53 Chassis with 16,000 lb GVW to 22,000 lb GVW	
R	00-07	FLAIR All MotorHomes with Ford F53 Chassis with 16,000 lb GVW to 22,000 lb GVW	
R	23-24	FLEX All MotorHomes with Ford F53 Chassis with 16,000 lb GVW to 22,000 lb GVW	
R	20-24	FORTIS All MotorHomes with Ford F53 Chassis with 16,000 lb GVW to 22,000 lb GVW	
R	00-23	SOUTHWIND All MotorHomes with Ford F53 Chassis with 16,000 lb GVW to 22,000 lb GVW	
R	11-18	STORM All MotorHomes with Ford F53 Chassis with 16,000 lb GVW to 22,000 lb GVW	
R	01-07	STORM All MotorHomes with Ford F53 Chassis with 16,000 lb GVW to 22,000 lb GVW	
R	06-23	FORD F-53	
R	99-04	F-53	
R	08-23	F-53 MOTORHOME CHASSIS All Motorhome Chassis with 16,000 lb GVW to 18,000 lb GVW	
R	06-23	F-53 MOTORHOME CHASSIS All Motorhome Chassis with 20,500 lb GVW to 22,000 lb GVW	
R	99-04	F-53 MOTORHOME CHASSIS All Motorhome Chassis with 20,500 lb GVW to 22,000 lb GVW	
R	13-23	FOREST RIVER FR3 All MotorHomes with Ford F53 Chassis with 16,000 lb GVW to 22,000 lb GVW	
R	08-17	GEORGETOWN All MotorHomes with Ford F53 Chassis with 16,000 lb GVW to 22,000 lb GVW	
R	16-23	GEORGETOWN GT3 All MotorHomes with Ford F53 Chassis with 16,000 lb GVW to 22,000 lb GVW	
R	17-23	GEORGETOWN GT5 All MotorHomes with Ford F53 Chassis with 16,000 lb GVW to 22,000 lb GVW	
R	20-23	GEORGETOWN GT7 All MotorHomes with Ford F53 Chassis with 16,000 lb GVW to 22,000 lb GVW	
R	99-09	GEORGIE BOY MANUFACTURING CLASS A MOTORHOMES	
R	99	GMC T5500	

Numerical listing

Shock	POP	Alternative No.	MTG Acc. Supplied
Pos.	Year	Application	
83122	C (cont)		
R	99	T6500 All Models with Hendrickson Air Suspension (Stamping number 47902-13)	
R	11-15	HOLIDAY RAMBLER ADMIRAL	
R	02-06	ADMIRAL	
R	16-24	ADMIRAL All MotorHomes with Ford F53 Chassis with 16,000 lb GVW to 22,000 lb GVW	
R	07-10	ADMIRAL All MotorHomes with Ford F53 Chassis with 16,000 lb GVW to 22,000 lb GVW	
R	00-01	ADMIRAL All MotorHomes with Ford F53 Chassis with 16,000 lb GVW to 22,000 lb GVW	
R	02-06	ADMIRAL SE All MotorHomes with Ford F53 Chassis with 16,000 lb GVW to 22,000 lb GVW	
R	07	ADMIRAL SVE All MotorHomes with Ford F53 Chassis with 16,000 lb GVW to 22,000 lb GVW	
R	16-18	ADMIRAL XE All MotorHomes with Ford F53 Chassis with 16,000 lb GVW to 22,000 lb GVW	
R	15	ENDEAVOR	
R	16-24	ENDEAVOR All MotorHomes with Ford F53 Chassis with 16,000 lb GVW to 22,000 lb GVW	
R	00-14	ENDEAVOR All MotorHomes with Ford F53 Chassis with 16,000 lb GVW to 22,000 lb GVW	
R	10	VACATIONER	
R	08	VACATIONER	
R	11-24	VACATIONER All MotorHomes with Ford F53 Chassis with 16,000 lb GVW to 22,000 lb GVW	
R	09	VACATIONER All MotorHomes with Ford F53 Chassis with 16,000 lb GVW to 22,000 lb GVW	
R	00-07	VACATIONER All MotorHomes with Ford F53 Chassis with 16,000 lb GVW to 22,000 lb GVW	
R		ISUZU FVR	
R	99-15	ITASCA CLASS A MOTORHOMES	
R	16-24	JAYCO ALANTE All MotorHomes with Ford F53 Chassis with 16,000 lb GVW to 22,000 lb GVW	
R	14-24	PRECEPT All MotorHomes with Ford F53 Chassis with 16,000 lb GVW to 22,000 lb GVW	
R	12-13	MONACO COACH LA PALMA All MotorHomes with Ford F53 Chassis with 16,000 lb GVW to 22,000 lb GVW	
R	09	LA PALMA All MotorHomes with Ford F53 Chassis with 16,000 lb GVW to 22,000 lb GVW	
R	02-06	LA PALMA All MotorHomes with Ford F53 Chassis with 16,000 lb GVW to 22,000 lb GVW	
R	00	LA PALMA All MotorHomes with Ford F53 Chassis with 16,000 lb GVW to 22,000 lb GVW	
R	06-14	MONARCH All MotorHomes with Ford F53 Chassis with 16,000 lb GVW to 22,000 lb GVW	
R	01-02	MONARCH All MotorHomes with Ford F53 Chassis with 16,000 lb GVW to 22,000 lb GVW	
R	99-08	NATIONAL RV CLASS A MOTORHOMES	
R	13-20	NEWMAR CLASS A MOTORHOMES	
R	17-20	NEXUS MAYBACH All MotorHomes with Ford F53 Chassis with 16,000 lb GVW to 22,000 lb GVW	
R	11-24	THOR MOTOR COACH A.C.E All MotorHomes with Ford F53 Chassis with 16,000 lb GVW to 22,000 lb GVW	
R	05-08	CHALLENGER	
R	09-24	CHALLENGER All MotorHomes with Ford F53 Chassis with 16,000 lb GVW to 22,000 lb GVW	
R	04-10	HURRICANE	
R	11-24	HURRICANE All MotorHomes with Ford F53 Chassis with 16,000 lb GVW to 22,000 lb GVW	
R	23-24	INDIGO All MotorHomes with Ford F53 Chassis with 16,000 lb GVW to 22,000 lb GVW	
R	23-24	LUMINATE All MotorHomes with Ford F53 Chassis with 16,000 lb GVW to 22,000 lb GVW	

Numerical listing

Shock	POP	Alternative No.	MTG Acc. Supplied
Pos.	Year	Application	
83122 C (cont)			
R	14-24	MIRAMAR	All MotorHomes with Ford F53 Chassis with 16,000 lb GVW to 22,000 lb GVW
R	07-10	OUTLAW	
R	11-23	OUTLAW	All MotorHomes with Ford F53 Chassis with 16,000 lb GVW to 22,000 lb GVW
R	23-24	RESONATE	All MotorHomes with Ford F53 Chassis with 16,000 lb GVW to 22,000 lb GVW
R	06-10	WINDSPORT	
R	11-24	WINDSPORT	All MotorHomes with Ford F53 Chassis with 16,000 lb GVW to 22,000 lb GVW
R	19-23	WINNEBAGO ADVENTURER	All Motorhomes with Ford F-53 Chassis with 16,000 lb GVW to 22,000 lb GVW
R	06-17	ADVENTURER	All Motorhomes with Ford F-53 Chassis with 16,000 lb GVW to 22,000 lb GVW
R	99-04	ADVENTURER	All Motorhomes with Ford F-53 Chassis with 16,000 lb GVW to 22,000 lb GVW
R	18-20	INTENET	All Motorhome Chassis with 16,000 lb GVW to 18,000 lb GVW
R	18-20	INTENET	All Motorhome Chassis with 20,500 lb GVW to 22,000 lb GVW
R	11-17	SIGHTSEER	All Motorhome Chassis with 16,000 lb GVW to 18,000 lb GVW
R	11-17	SIGHTSEER	All Motorhome Chassis with 20,500 lb GVW to 22,000 lb GVW
R	08-09	SIGHTSEER	All Motorhome Chassis with 16,000 lb GVW to 18,000 lb GVW
R	06-09	SIGHTSEER	All Motorhome Chassis with 20,500 lb GVW to 22,000 lb GVW
R	02-04	SIGHTSEER	All Motorhome Chassis with 20,500 lb GVW to 22,000 lb GVW
R	16-17	SUNOVA	All Motorhome Chassis with 16,000 lb GVW to 18,000 lb GVW
R	16-17	SUNOVA	All Motorhome Chassis with 20,500 lb GVW to 22,000 lb GVW
R	06-07	SUNOVA	All Motorhome Chassis with 20,500 lb GVW to 22,000 lb GVW
R	02-04	SUNOVA	All Motorhome Chassis with 20,500 lb GVW to 22,000 lb GVW
R	16-22	SUNSTAR	All Motorhome Chassis with 16,000 lb GVW to 18,000 lb GVW
R	16-22	SUNSTAR	All Motorhome Chassis with 20,500 lb GVW to 22,000 lb GVW
R	02-04	SUNSTAR	All Motorhome Chassis with 20,500 lb GVW to 22,000 lb GVW
R	16-18	SUNSTAR LX	All Motorhome Chassis with 16,000 lb GVW to 18,000 lb GVW
R	16-18	SUNSTAR LX	All Motorhome Chassis with 20,500 lb GVW to 22,000 lb GVW
R	11-22	VISTA	All Motorhome Chassis with 16,000 lb GVW to 18,000 lb GVW
R	11-22	VISTA	All Motorhome Chassis with 20,500 lb GVW to 22,000 lb GVW
R	08-09	VISTA	All Motorhome Chassis with 16,000 lb GVW to 18,000 lb GVW
R	07-09	VISTA	All Motorhome Chassis with 20,500 lb GVW to 22,000 lb GVW
R	02-04	VISTA	All Motorhome Chassis with 20,500 lb GVW to 22,000 lb GVW
R	16-18	VISTA LX	All Motorhome Chassis with 16,000 lb GVW to 18,000 lb GVW
R	16-18	VISTA LX	All Motorhome Chassis with 20,500 lb GVW to 22,000 lb GVW
83123 C			
R	00-03	FORD F-650	All Models with Hendrickson HAS - 190 Rear Air Suspension

83000 Series

Shock	POP	Alternative No.	MTG Acc. Supplied
Pos.	Year	Application	
83123 C (cont)			
R	00-03	F-750	All Models with Hendrickson HAS - 190 Rear Air Suspension
R	03-18	IC CORPORATION RE SCHOOL BUS	All RE Model School Buses (Low Profile)
R	13-24	KENWORTH K270	All Models with Hendrickson HAS - 210L or HAS - 230L Rear Air Suspension
R	93-05	K300	All Models with Hendrickson Rear Air Suspension
R	08-22	T270	All Models with Hendrickson HAS - 210L or HAS - 230L Rear Air Suspension
R		T300	
R	95-08	T300	All Models with Hendrickson HAS - 210L or HAS - 230L Rear Air Suspension
R	13-24	PETERBILT 220	All Models with Hendrickson HAS - 210L or HAS - 230L Rear Air Suspension
R	10	220	All Models with Hendrickson HAS - 210L or HAS - 230L Rear Air Suspension
R	07	220	All Models with Hendrickson HAS - 210L or HAS - 230L Rear Air Suspension
83124 C			
F		COACHMEN CLASS A MOTORHOMES	
R	00	COUNTRY COACH AFFINITY	All MotorHomes with Neway IFS
R	00	CONCEPT	All MotorHomes with Neway IFS
R	00-04	MAGNA	All MotorHomes with Neway IFS
R	05-10	MAGNA 630	All MotorHomes with Neway IFS
F		FOREST RIVER CLASS A MOTORHOMES	
F		GEORGIE BOY MANUFACTURING CLASS A MOTORHOMES	
F		ITASCA CLASS A MOTORHOMES	
F		MONACO COACH CLASS A MOTORHOMES	
F		WORKHORSE VARIOUS	
83125 C			
F	94	FORD B-700	All Models with 14600 lb Multileaf Spring
F	88-97	F-53 MOTORHOME CHASSIS	All F53 Motorhome Chassis (Over 30 feet)
F	94	F-700	All Models with 14600 lb Multileaf Spring
F	94	F-800	All Models with 14600 lb Multileaf Spring
83126 C			
F	69-70	CHEVROLET 4, 40, 4000 & 4500 SERIES	
R	71-72	5, 50, 5000 & 5500 SERIES	
R	69-70	5, 50, 5000 & 5500 SERIES	
R	71-89	6, 60, 6000 & 6500 SERIES	
R	73-80	6, 60, 6000 & 6500 SERIES	
F	68-69	6, 60, 6000 & 6500 SERIES	
R	02-23	FREIGHTLINER M2 106	All Models with Reyco 79KB Rear Steel Spring Suspension
F	72-80	GMC 4500 SERIES	
R	66-72	4500 SERIES	
F	66-89	5500 SERIES	
R	66-72	5500 SERIES	
F	79-80	6000 SERIES	
F	66-80	6500 SERIES	
R	66-80	6500 SERIES	
F	05-10	HINO 145	All Models with O.E.M. Number
F	05-10	165	All Models with O.E.M. Number
F	05-10	185	All Models with O.E.M. Number
R	13-24	KENWORTH K270	All Models with Reyco 102 or 79KB Suspension (Drive Axle)
R	93-05	K300	All Models with Reyco 102 or 79KB Suspension (Drive Axle)
F	93-05	K300	All Models with Reyco 1209 or 1212 Suspension (Steer Axle)
R	08-22	T170	All Models with Reyco 79KB Rear Steel Spring Suspension
R	08-22	T270	All Models with Reyco 102 or 79KB Suspension (Drive Axle)
R	21-24	T280	All Models with Reyco 102 or 79KB Suspension (Drive Axle)
F		T300	

Numerical listing

Shock	POP	Alternative No.	MTG Acc. Supplied
Pos.	Year	Application	
83126 C (cont)			
R		T300	
R	99-08	T300	All Models with Reyco 102 or 79KB Suspension (Drive Axle)
R	99-08	T300	All Models with Reyco 1209 or 1212 Suspension (Steer Axle)
R	08-15	PETERBILT 210	All Models with Reyco 102 or 79KB Suspension (Drive Axle)
R	13-24	220	All Models with Reyco 102 or 79KB Suspension (Drive Axle)
R	10	220	All Models with Reyco 102 or 79KB Suspension (Drive Axle)
R	07	220	All Models with Reyco 102 or 79KB Suspension (Drive Axle)
R	08-19	325	All Models with Reyco 102 or 79KB Suspension (Drive Axle)
R	07-22	330	All Models with Reyco 79KB Rear Steel Spring Suspension
R	95-05	330	All Models with Reyco 79KB Rear Steel Spring Suspension
83127 C			
F		FREIGHTLINER VARIOUS	
R		HOLIDAY RAMBLER VARIOUS	
F	23	MACK MD6	
F	24	MD6	All Models with 10,000 lb Taperleaf Springs
F	21-22	MD6	All Models with 10,000 lb Taperleaf Springs
83131 D			
F	00-02	FORD F-650	All Models with 8500 or 9000 lb Front Axle
F	00-02	F-750	All Models with 8500 or 9000 lb Front Axle
83134 D 145054 (1)			
R	05-21	FREIGHTLINER M2	All Models with Rear 52" Spring ,10000 lb - 15000 lb
R	05-21	M2	All Models with Rear 52" Spring ,18000 lb - 23000 lb
R	02-10	M2 100	All Models with Rear 52" Spring ,10000 lb - 15000 lb
R	02-10	M2 100	All Models with Rear 52" Spring ,18000 lb - 23000 lb
R	02-23	M2 106	All Models with Rear 52" Spring ,10000 lb - 15000 lb
R	02-23	M2 106	All Models with Rear 52" Spring ,18000 lb - 23000 lb
83135 C			
F	19-22	CHEVROLET SILVERADO 4500 HD	All Models with 7,000 to 8,000 lb Front Axle
F	19-22	SILVERADO 5500 HD	All Models with 7,000 to 8,000 lb Front Axle
F	19-22	SILVERADO 6500 HD	All Models with 7,000 to 8,000 lb Front Axle
F	14	FORD F-650	
F	15	F-650	All Models with 8,500 lb Front Suspension
F	00-13	F-650	All Models with 8,500 lb Front Suspension
F	15	F-750	All Models with 8,500 lb Front Suspension
F	00-13	F-750	All Models with 8,500 lb Front Suspension
F	02-20	INTERNATIONAL 4300	All Models with 6,000 to 8,000 lb Front Suspension
F	02-20	4400	All Models with 6,000 to 8,000 lb Front Suspension
F	10-12	DURASTAR - 4300, 4400 SERIES	
F	12-18	TERRASTAR	All Models with 6,000 to 7,000 lb Front Axle
83136 C 145054 (2)			
F		CHAMPION BUS INC. VARIOUS	
F		CHEVROLET B - SERIES - SCHOOL BUS	
F	90-96	C60 KODIAK	All Conventional Cab w/ Front Shock with O.E.M. Number
R	90-96	C60 KODIAK	All Conventional Cab w/19000, 21000, 23000 lb Taperleaf Springs (EXC Low Profile Vehicle)
F	90-96	C70 KODIAK	All Conventional Cab w/ Front Shock with O.E.M. Number
R	90-96	C70 KODIAK	All Conventional Cab w/19000, 21000, 23000 lb Taperleaf Springs (EXC Low Profile Vehicle)
F	90-02	C4500 KODIAK	
R	90-02	C4500 KODIAK	
F	03-09	C4500 KODIAK	All C Chassis - Conventional Cab

Numerical listing

Shock	POP	Alternative No.	MTG Acc. Supplied
Pos.	Year	Application	
83136	C (cont)	145054 (2)	
R	03-09	C4500 KODIAK All C Chassis - Conventional Cab w/19000, 21000, 23000 lb Taperleaf Springs (EXC Low Profile Vehicle)	
F	92-02	C5500 KODIAK	
R	92-02	C5500 KODIAK	
F	03-09	C5500 KODIAK All C Chassis - Conventional Cab	
R	03-09	C5500 KODIAK All C Chassis - Conventional Cab w/19000, 21000, 23000 lb Taperleaf Springs (EXC Low Profile Vehicle)	
F	90-91	C5500 KODIAK All C Chassis - Conventional Cab	
R	90-91	C5500 KODIAK All C Chassis - Conventional Cab w/19000, 21000, 23000 lb Taperleaf Springs (EXC Low Profile Vehicle)	
F	97-09	C6500 KODIAK All Conventional Cab w/ Front Shock with O.E.M. Number	
R	97-09	C6500 KODIAK All Conventional Cab w/19000, 21000, 23000 lb Taperleaf Springs (EXC Low Profile Vehicle)	
F	97-09	C7500 KODIAK All Conventional Cab w/ Front Shock with O.E.M. Number	
R	97-09	C7500 KODIAK All Conventional Cab w/19000, 21000, 23000 lb Taperleaf Springs (EXC Low Profile Vehicle)	
F		C - SERIES (C6500, C7500, C8500) KODIAK	
R	92-96	P60 All Motorhome Chassis	
R	92-96	P6000 All Motorhome Chassis	
F	97-09	T5500	
R	92-99	T5500	
F	03	T6500	
R	92-96	T6500	
F	04-09	T6500 All FL1 Tilt Cab with 8100 lb Axle	
F	04-09	T6500 All FL2 Tilt Cab with 5000 to 11000 lb Axle	
F	04-09	T6500 All FL3 Tilt Cab with 14575 lb Axle	
F	97-02	T6500 All FL1 Tilt Cab with 8100 lb Axle	
F	97-02	T6500 All FL2 Tilt Cab with 5000 to 11000 lb Axle	
F	97-02	T6500 All FL3 Tilt Cab with 14575 lb Axle	
R	97-99	T6500 All Tilt Cab w/19000, 21000, 23000 lb Taperleaf Springs (EXC Low Profile Veh.)	
F	93-02	GMC B7 All Models with O.E.M. Number	
F	90-02	C4500 TOPKICK	
R	90-02	C4500 TOPKICK	
R	03-09	C4500 TOPKICK All C Chassis - Conventional Cab with 19000, 21000, 23000 lb Taperleaf Springs (EXC Low Profile Vehicle)	
F	03-09	C4500 TOPKICK All C Chassis - Conventional Cab with Front Shock with O.E.M. Number	
F	90-02	C5500 TOPKICK	
R	90-02	C5500 TOPKICK	
R	03-09	C5500 TOPKICK All C Chassis - Conventional Cab with 19000, 21000, 23000 lb Taperleaf Springs (EXC Low Profile Vehicle)	
F	03-09	C5500 TOPKICK All C Chassis - Conventional Cab with Front Shock with O.E.M. Number	
F	97-09	T5500	
R	92-99	T5500	
F	03	T6500	
R	92-96	T6500	
F	04-09	T6500 All FL1 Tilt Cab with 8100 lb Axle	
F	04-09	T6500 All FL2 Tilt Cab with 5000 to 11000 lb Axle	
F	04-09	T6500 All FL3 Tilt Cab with 14575 lb Axle	
F	97-02	T6500 All FL1 Tilt Cab with 8100 lb Axle	
F	97-02	T6500 All FL2 Tilt Cab with 5000 to 11000 lb Axle	
F	97-02	T6500 All FL3 Tilt Cab with 14575 lb Axle	
R	97-99	T6500 All Tilt Cab with 19000, 21000, 23000 lb Taperleaf Springs (EXC Low Profile Veh.)	

83000 Series

Shock	POP	Alternative No.	MTG Acc. Supplied
Pos.	Year	Application	
83136	C (cont)	145054 (2)	
F	04-07	GULF STREAM ENDURA	
F	08	ENDURA All MotorHomes with Chevy Kodiak Chassis	
R	97-02	ISUZU FSR All Models with 19000, 21000, 23000 lb Taperleaf Springs (EXC Low Profile Veh.)	
F	97-02	FSR All Models with FL1 Tilt Cab with 8100 lb Axle (Including Low Profile)	
R	97-09	FTR All Models with 19000, 21000, 23000 lb Taperleaf Springs (EXC Low Profile Veh.)	
F	90-09	FTR All Models with O.E.M. Number	
R	97-09	FVR All Models with 19000, 21000, 23000 lb Taperleaf Springs (EXC Low Profile Veh.)	
F	97-09	FVR All Models with O.E.M. Number	
R	93-05	KENWORTH K300 All Models with Woodhead Shock (Stamping Number ACHB 966)	
R		T300	
83137	C		
R	97-09	CHEVROLET C6500 KODIAK All Models with Hendrickson Air Suspension with O.E.M. Number	
R	97-09	C7500 KODIAK All Models with Hendrickson Air Suspension with O.E.M. Number	
R	03-09	C8500 All Models with Hendrickson Air Suspension with O.E.M. Number	
R	18-22	ISUZU FTR All Models with Hendrickson HAS suspension	
R	00-11	FTR All Models with Hendrickson HAS suspension	
R	00-11	FVR All Models with Hendrickson HAS suspension	
R	13-23	KENWORTH K270 All Models with Hendrickson HAS - 230 Rear Air Suspension	
R	08-14	T270 All Models with Hendrickson HAS - 400 (Standard) Rear Air Suspension	
83140	C	415010-802(2)/145148(2)	
R	00-03	FORD F-650 All Models with 23,000 lb Multi-leaf Rear Springs	
R	00-03	F-750 All Models with 23,000 lb Multi-leaf Rear Springs	
F	05-10	HINO 185 All Models with O.E.M. Number	
F	05-14	238 All Models with O.E.M. Number	
F	06-14	258 All Models with O.E.M. Number	
F	05-14	268 All Models with O.E.M. Number	
F	08-14	268A All Models with O.E.M. Number	
83141	D	415010-802(2)/145148(2)	
F	98-04	HINO FB1817 All FE Models Trucks with:	
F	98-04	FE SERIES	
F	03	FF3020	
83142	C	145128 (1)	
R	05-21	FREIGHTLINER M2 All Models with Hendrickson HMX 400/460 Haulmax with 17.5" & 18.5" Saddle	
R	02-10	M2 100 All Models with Hendrickson HMX 400/460 Haulmax with 17.5" & 18.5" Saddle	
R	02-24	M2 106 All Models with Hendrickson HMX 400/460 Haulmax with 17.5" & 18.5" Saddle	
R	19-22	INTERNATIONAL HV607 All Models with Hendrickson HMX 400/460 Haulmax with 17.5" & 18.5" Saddle	
R	19-23	PIERCE MFG. INC. VARIOUS	
83143	C	145128 (1)	
R	05-21	FREIGHTLINER M2 All Models with Hendrickson HMX 400/460 Haulmax with 16.5" Saddle	
R	02-10	M2 100 All Models with Hendrickson HMX 400/460 Haulmax with 16.5" Saddle	
R	02-24	M2 106 All Models with Hendrickson HMX 400/460 Haulmax with 16.5" Saddle	
R	19-22	INTERNATIONAL HV607 All Models with Hendrickson HMX 400/460 Haulmax with 16.5" Saddle	

Numerical listing

Shock	POP	Alternative No.	MTG Acc. Supplied
Pos.	Year	Application	
83143	C (cont)	145128 (1)	
R	08-23	KENWORTH T270 All Models with Hendrickson HMX 400/460 Haulmax with 16.5" Saddle	
R	19-23	PIERCE MFG. INC. VARIOUS	
83144	D		
F	00-03	HOLIDAY RAMBLER CLASS A MOTORHOMES	
F	00-07	MONACO COACH CLASS A MOTORHOMES	
83147	B		
R		THOMAS VARIOUS	
83148	D		
R	20	FORD F-650	
R	21-24	F-650 All Models with Hendrickson Rear Air Suspension	
R	15-19	F-650 All Models with Hendrickson Rear Air Suspension	
R	21-24	F-750 All Models with Hendrickson Rear Air Suspension	
R	15-19	F-750 All Models with Hendrickson Rear Air Suspension	
R		HINO ADDITIONAL APPLICATIONS	
83154	C	145089-000 (1)	
R	98-23	FREIGHTLINER MT45 All Walkin Step Van Models (18 Foot) with O.E.M. Number	
R		MT55	
R	00-02	XCS CHASSIS	
83157	D		
F	99-20	FREIGHTLINER MT45 All MT45 Step Van - w/35" Front Spring	
F	99-20	MT55 All MT55 Step Van - w/35" Front Spring	
83159	D	TR0027 (4)	
R	16-23	CHEVROLET LCF 3500 All	
R	18	LCF 3500HD	
R	16-17	LCF 3500HD All	
R	19-22	SILVERADO 4500 HD All Diesel Low Cab Forward models with 14,000 to 15,000 lb Rear	
R	19-22	SILVERADO 4500 HD All Diesel Low Cab Forward models with 15,000 to 16,000 lb Rear	
R	19-22	SILVERADO 5500 HD All Diesel Low Cab Forward models with 14,000 to 15,000 lb Rear	
R	19-22	SILVERADO 5500 HD All Diesel Low Cab Forward models with 15,000 to 16,000 lb Rear	
R		GMC W - SERIES (ISUZU)	
R	05-09	ISUZU FTR All Models with O.E.M. Number	
R	19	NPR	
R	95-18	NPR All Models with O.E.M. Number	
R	20-23	NPR-HD All Models with 14,000 to 15,000 lb Rear	
R	20-23	NPR-HD All Models with 15,000 to 16,000 lb Rear	
R	03-19	NPR-HD All Models with O.E.M. Number	
R	23	NPR-XD	
R	15-22	NPR-XD All Models with 14,000 to 15,000 lb GVW	
R	15-22	NPR-XD All Models with 15,000 to 16,000 lb Rear	
R	20-23	NQR All Models with 15,000 to 16,000 lb Rear	
R	03-19	NQR All Models with O.E.M. Number	
R	02	NQR All Diesel	
R	95-97	NQR All Diesel	
R	20-23	NRR All Models with 15,000 to 16,000 lb Rear	
R	05-19	NRR All Models with O.E.M. Number	
R	11-15	REACH All Models with O.E.M. Number	
83160	D		
F	06	COACHMEN CROSS COUNTRY	
F	03-05	CROSS COUNTRY ELITE	
F	03-05	CROSS COUNTRY SE	
F	02-06	FLEETWOOD BOUNDER All MotorHomes with Freightliner XC Chassis and AS120 Front Suspension	

Numerical listing

Shock	POP	Alternative No.	MTG Acc. Supplied
Pos.	Year	Application	
83160	D	(cont)	
F	02-06	DISCOVERY All MotorHomes with Freightliner XC Chassis and AS120 Front Suspension	
F	02-06	EXCURSION All MotorHomes with Freightliner XC Chassis and AS120 Front Suspension	
F	02-06	EXPEDITION All MotorHomes with Freightliner XC Chassis and AS120 Front Suspension	
F	04-06	PROVIDENCE All MotorHomes with Freightliner XC Chassis and AS120 Front Suspension	
F	02-04	FOREST RIVER REFLECTION	
F	02-06	TSUNAMI	
F	93-07	FREIGHTLINER VC CHASSIS	
F		XB CHASSIS	
F		XC CHASSIS	
F	93-12	XC CHASSIS	
F	01-02	XCS CHASSIS	
F	03-06	GULF STREAM ATRIUM	
F	02-06	FRIENDSHIP	
F	02	INDEPENDENCE All MotorHomes with Freightliner XC Chassis and AS120 Front Suspension	
F	02-06	SCENIC CRUISER	
F	02-04	YELLOWSTONE	
F	95-99	HOLIDAY RAMBLER CLASS A MOTORHOMES	
F	02-06	ITASCA CLASS A MOTORHOMES	
F	04-06	KING OF THE ROAD CLASS A MOTORHOMES	
F	04-06	MANDALAY COACH CLASS A MOTORHOMES	
F	95-99	MONACO COACH VARIOUS	
F	02-06	NEWMAR CLASS A MOTORHOMES	
F	02-06	THOR MOTOR COACH CLASS A MOTORHOMES	
F	02-06	WINNEBAGO JOURNEY All MotorHomes with Freightliner XC Chassis and AS120 Front Suspension	
F	06	TOUR All MotorHomes with Freightliner XC Chassis and AS120 Front Suspension	
F	06	VECTRA All MotorHomes with Freightliner XC Chassis and AS120 Front Suspension	
83162	D	140780(1)/145116 & 406422 & 415010-802(1)	
F	86	ISUZU FSR	
F	87-92	FSR All FSR Models	
F	94-96	FVR All FVR Short & Middle Chassis	
F	88-92	FVR All FVR Short & Middle Chassis	
F	05-11	MITSUBISHI FUSO FM330 All Models with O.E.M. Number	
F	89-91	UD 550T All Models with O.E.M. Number	
F	92-94	600T All Models with O.E.M. Number	
F	89-13	2600 All Models with O.E.M. Number	
83163	C		
F	10-23	IC CORPORATION CE SCHOOL BUS All CE Model School Buses (71 Capacity) with 9,000 to 10,000 lb Front Suspension	
F	08-09	INTERNATIONAL 4300 All Models with 9,000 to 10,000 lb Front Suspension	
F	08-09	4400 All Models with 9,000 to 10,000 lb Front Suspension	
F		CXT SERIES	
F	15-19	DURASTAR All Models with 9,000 to 10,000 lb Front Suspension	
F	13	DURASTAR All Models with 9,000 to 10,000 lb Front Suspension	
F	19-22	MV607 All Models with 9,000 to 10,000 lb Front Suspension	
F	19-22	PIERCE MFG. INC. VARIOUS	
83164	D		
F		FREIGHTLINER MP 14 MP 19	
F	99-20	MT45 All MT45 Step Van - w/38" Front Spring	
F	99-20	MT55 All MT55 Step Van - w/38" Front Spring	

83000 Series

Shock	POP	Alternative No.	MTG Acc. Supplied
Pos.	Year	Application	
83166	C		
R	08-14	HINO 238 All Models with Hendrickson Comfort Air (Single Axle - 19K)	
R	08-23	258 All Models with Hendrickson Comfort Air (Single Axle - 19K)	
R	08-14	258ALP All Models with Hendrickson Comfort Air (Single Axle - 19K)	
R	08-23	268 All Models with Hendrickson Comfort Air (Single Axle - 19K)	
R	08-14	268A All Models with Hendrickson Comfort Air (Single Axle - 19K)	
R	22-23	L6	
R	21	L6 All Models with Hendrickson Comfort Air (Single Axle - 19K)	
R		LION LION 6	
83168	D		
R	21-24	FORD F-650 All Models with Hendrickson Rear Air Suspension	
R	15-19	F-650 All Models with Hendrickson Rear Air Suspension	
R	21-24	F-750 All Models with Hendrickson Rear Air Suspension	
R	15-19	F-750 All Models with Hendrickson Rear Air Suspension	
R		HINO 268, 268A SERIES	
83169	D		
F	08-15	IC CORPORATION BE SCHOOL BUS All School Buses with 7,000 lb Front Axles	
F	13-18	CE SCHOOL BUS All CE Model School Buses with 6,000 to 8,000 lb Front Axles	
F	15-20	INTERNATIONAL DURASTAR All Models with 6,000 to 8,000 lb Front Suspension	
F	13	DURASTAR All Models with 6,000 to 8,000 lb Front Suspension	
F	13-18	DURASTAR - 4300, 4400 SERIES	
F	19	MV SERIES	
83175	D		
F	14	FORD F-650	
F	15	F-650 All Models with 10,000 lb Front Suspension	
F	00-13	F-650 All Models with 10,000 lb Front Suspension	
F	15	F-750 All Models with 10,000 lb Front Suspension	
F	00-13	F-750 All Models with 10,000 lb Front Suspension	
F	00-15	GLAVAL BUS CO. CONCORDE II - SERIES	
F	00-15	STARCRAFT BUS CO. ALLSTAR XL & XLT - SERIES	
83180	W		
R	14	INTERNATIONAL TERRASTAR All 4 WD Models with Rear Spring Suspension	
83207	C		
F	73-80	CHEVROLET 5, 50, 5000 & 5500 SERIES	
F	73-75	6, 60, 6000 & 6500 SERIES	
F	73-80	GMC 5000 SERIES	
F	73-75	6000 SERIES	
F	73-75	6500 SERIES	
83209	C		
F	09	COACHMEN AURORA	
F	07	AURORA	
F	08	AURORA All MotorHomes with Ford F53 Chassis with 16,000 lb GVW to 22,000 lb GVW	
F	04-06	AURORA All MotorHomes with Ford F53 Chassis with 16,000 lb GVW to 22,000 lb GVW	
F	21-24	ENCORE All MotorHomes with Ford F53 Chassis with 16,000 lb GVW to 22,000 lb GVW	
F	11-16	ENCOUNTER All MotorHomes with Ford F53 Chassis with 16,000 lb GVW to 22,000 lb GVW	
F	99-07	MIRADA	
F	08-24	MIRADA All MotorHomes with Ford F53 Chassis with 16,000 lb GVW to 22,000 lb GVW	
F	04-12	PURSUIT	
F	13-24	PURSUIT All MotorHomes with Ford F53 Chassis with 16,000 lb GVW to 22,000 lb GVW	

Numerical listing

Shock	POP	Alternative No.	MTG Acc. Supplied
Pos.	Year	Application	
83209	C	(cont)	
F	00-14	DAMON CHALLENGER All MotorHomes with Ford F53 Chassis with 16,000 lb GVW to 22,000 lb GVW	
F	12-13	DAYBREAK	
F	99	DAYBREAK	
F	00-11	DAYBREAK All MotorHomes with Ford F53 Chassis with 16,000 lb GVW to 22,000 lb GVW	
F	99	INTRUDER	
F	00-07	INTRUDER All MotorHomes with Ford F53 Chassis with 16,000 lb GVW to 22,000 lb GVW	
F	12-14	OUTLAW	
F	07-11	OUTLAW All MotorHomes with Ford F53 Chassis with 16,000 lb GVW to 22,000 lb GVW	
F	19-24	ENTEGRA COACH EMBLEM All MotorHomes with Ford F53 Chassis with 16,000 lb GVW to 22,000 lb GVW	
F	19-24	VISION All MotorHomes with Ford F53 Chassis with 16,000 lb GVW to 22,000 lb GVW	
F	19-20	FLEETWOOD AXON	
F	18	AXON All MotorHomes with Ford F53 Chassis with 16,000 lb GVW to 22,000 lb GVW	
F	00-24	BOUNDER All MotorHomes with Ford F53 Chassis with 16,000 lb GVW to 22,000 lb GVW	
F	15-24	FLAIR All MotorHomes with Ford F53 Chassis with 16,000 lb GVW to 22,000 lb GVW	
F	00-07	FLAIR All MotorHomes with Ford F53 Chassis with 16,000 lb GVW to 22,000 lb GVW	
F	23-24	FLEX All MotorHomes with Ford F53 Chassis with 16,000 lb GVW to 22,000 lb GVW	
F	20-24	FORTIS All MotorHomes with Ford F53 Chassis with 16,000 lb GVW to 22,000 lb GVW	
F	00-23	SOUTHWIND All MotorHomes with Ford F53 Chassis with 16,000 lb GVW to 22,000 lb GVW	
F	11-18	STORM All MotorHomes with Ford F53 Chassis with 16,000 lb GVW to 22,000 lb GVW	
F	01-07	STORM All MotorHomes with Ford F53 Chassis with 16,000 lb GVW to 22,000 lb GVW	
F	06-23	FORD F-53	
F	99-04	F-53	
F	88-97	F-53	
F	05	F-53 MOTORHOME CHASSIS	
F	98	F-53 MOTORHOME CHASSIS	
F	06-23	F-53 MOTORHOME CHASSIS All F53 Chassis with 16,000 lb GVW to 22,000 lb GVW	
F	99-04	F-53 MOTORHOME CHASSIS All F53 Chassis with 16,000 lb GVW to 22,000 lb GVW	
F	88-97	F-53 MOTORHOME CHASSIS All F53 Chassis with 16,000 lb GVW to 22,000 lb GVW	
F	13-23	FOREST RIVER FR3 All MotorHomes with Ford F53 Chassis with 16,000 lb GVW to 22,000 lb GVW	
F	08-17	GEORGETOWN All MotorHomes with Ford F53 Chassis with 16,000 lb GVW to 22,000 lb GVW	
F	16-23	GEORGETOWN GT3 All MotorHomes with Ford F53 Chassis with 16,000 lb GVW to 22,000 lb GVW	
F	17-23	GEORGETOWN GT5 All MotorHomes with Ford F53 Chassis with 16,000 lb GVW to 22,000 lb GVW	
F	20-23	GEORGETOWN GT7 All MotorHomes with Ford F53 Chassis with 16,000 lb GVW to 22,000 lb GVW	
F	99-09	GEORGIE BOY MANUFACTURING CLASS A MOTORHOMES	
F	11-15	HOLIDAY RAMBLER ADMIRAL	
F	02-06	ADMIRAL	
F	16-24	ADMIRAL All MotorHomes with Ford F53 Chassis with 16,000 lb GVW to 22,000 lb GVW	

Numerical listing

Shock	POP	Alternative No.	MTG Acc. Supplied
Pos.	Year	Application	
83209	C (cont)		
F	07-10	ADMIRAL	All MotorHomes with Ford F53 Chassis with 16,000 lb GVW to 22,000 lb GVW
F	00-01	ADMIRAL	All MotorHomes with Ford F53 Chassis with 16,000 lb GVW to 22,000 lb GVW
F	02-06	ADMIRAL SE	All MotorHomes with Ford F53 Chassis with 16,000 lb GVW to 22,000 lb GVW
F	07	ADMIRAL SVE	All MotorHomes with Ford F53 Chassis with 16,000 lb GVW to 22,000 lb GVW
F	16-18	ADMIRAL XE	All MotorHomes with Ford F53 Chassis with 16,000 lb GVW to 22,000 lb GVW
F	15	ENDEAVOR	
F	16-24	ENDEAVOR	All MotorHomes with Ford F53 Chassis with 16,000 lb GVW to 22,000 lb GVW
F	00-14	ENDEAVOR	All MotorHomes with Ford F53 Chassis with 16,000 lb GVW to 22,000 lb GVW
F	10	VACATIONER	
F	08	VACATIONER	
F	11-24	VACATIONER	All MotorHomes with Ford F53 Chassis with 16,000 lb GVW to 22,000 lb GVW
F	09	VACATIONER	All MotorHomes with Ford F53 Chassis with 16,000 lb GVW to 22,000 lb GVW
F	00-07	VACATIONER	All MotorHomes with Ford F53 Chassis with 16,000 lb GVW to 22,000 lb GVW
F	99-15	ITASCA CLASS A	MOTORHOMES
F	16-24	JAYCO ALANTE	All MotorHomes with Ford F53 Chassis with 16,000 lb GVW to 22,000 lb GVW
F	14-24	PRECEPT	All MotorHomes with Ford F53 Chassis with 16,000 lb GVW to 22,000 lb GVW
F	07-08	MONACO COACH	LA PALMA
F	01	LA PALMA	
F	90-99	LA PALMA	
F	12-13	LA PALMA	All MotorHomes with Ford F53 Chassis with 16,000 lb GVW to 22,000 lb GVW
F	09	LA PALMA	All MotorHomes with Ford F53 Chassis with 16,000 lb GVW to 22,000 lb GVW
F	02-06	LA PALMA	All MotorHomes with Ford F53 Chassis with 16,000 lb GVW to 22,000 lb GVW
F	00	LA PALMA	All MotorHomes with Ford F53 Chassis with 16,000 lb GVW to 22,000 lb GVW
F	03-05	MONARCH	
F	90-99	MONARCH	
F	06-14	MONARCH	All MotorHomes with Ford F53 Chassis with 16,000 lb GVW to 22,000 lb GVW
F	01-02	MONARCH	All MotorHomes with Ford F53 Chassis with 16,000 lb GVW to 22,000 lb GVW
F	99-08	NATIONAL RV CLASS A	MOTORHOMES
F	13-20	NEWMAR CLASS A	MOTORHOMES
F	17-20	NEXUS MAYBACH	All MotorHomes with Ford F53 Chassis with 16,000 lb GVW to 22,000 lb GVW
F	11-24	THOR MOTOR COACH A.C.E	All MotorHomes with Ford F53 Chassis with 16,000 lb GVW to 22,000 lb GVW
F	05-08	CHALLENGER	
F	09-24	CHALLENGER	All MotorHomes with Ford F53 Chassis with 16,000 lb GVW to 22,000 lb GVW
F	04-10	HURRICANE	
F	11-24	HURRICANE	All MotorHomes with Ford F53 Chassis with 16,000 lb GVW to 22,000 lb GVW
F	23-24	INDIGO	All MotorHomes with Ford F53 Chassis with 16,000 lb GVW to 22,000 lb GVW
F	23-24	LUMINATE	All MotorHomes with Ford F53 Chassis with 16,000 lb GVW to 22,000 lb GVW
F	14-24	MIRAMAR	All MotorHomes with Ford F53 Chassis with 16,000 lb GVW to 22,000 lb GVW
F	07-10	OUTLAW	

83000 Series

Shock	POP	Alternative No.	MTG Acc. Supplied
Pos.	Year	Application	
83209	C (cont)		
F	11-23	OUTLAW	All MotorHomes with Ford F53 Chassis with 16,000 lb GVW to 22,000 lb GVW
F	23-24	RESONATE	All MotorHomes with Ford F53 Chassis with 16,000 lb GVW to 22,000 lb GVW
F	06-10	WINDSPORT	
F	11-24	WINDSPORT	All MotorHomes with Ford F53 Chassis with 16,000 lb GVW to 22,000 lb GVW
F	19-23	WINNEBAGO ADVENTURER	All MotorHomes with Ford F53 Chassis with 16,000 lb GVW to 22,000 lb GVW
F	92-17	ADVENTURER	All MotorHomes with Ford F53 Chassis with 16,000 lb GVW to 22,000 lb GVW
F	18-20	INTENET	All MotorHomes with Ford F53 Chassis with 16,000 lb GVW to 22,000 lb GVW
F	02-17	SIGHTSEER	All MotorHomes with Ford F53 Chassis with 16,000 lb GVW to 22,000 lb GVW
F	16-17	SUNOVA	All MotorHomes with Ford F53 Chassis with 16,000 lb GVW to 22,000 lb GVW
F	02-07	SUNOVA	All MotorHomes with Ford F53 Chassis with 16,000 lb GVW to 22,000 lb GVW
F	16-22	SUNSTAR	All MotorHomes with Ford F53 Chassis with 16,000 lb GVW to 22,000 lb GVW
F	02-04	SUNSTAR	All MotorHomes with Ford F53 Chassis with 16,000 lb GVW to 22,000 lb GVW
F	16-18	SUNSTAR LX	All MotorHomes with Ford F53 Chassis with 16,000 lb GVW to 22,000 lb GVW
F	07-22	VISTA	All MotorHomes with Ford F53 Chassis with 16,000 lb GVW to 22,000 lb GVW
F	02-04	VISTA	All MotorHomes with Ford F53 Chassis with 16,000 lb GVW to 22,000 lb GVW
F	16-18	VISTA LX	All MotorHomes with Ford F53 Chassis with 16,000 lb GVW to 22,000 lb GVW
83214	D	401754 (4)	
F	SPARTAN MOTORS VARIOUS		
83215	D	401754 (4)	
R	86-94	FORD F-600	All Models with O.E.M. Number
R	80-90	F-600	All Models with 17000 & 18000 lb Rear Axle
R	86-98	F-700	All Models with O.E.M. Number
R	80-90	F-700	All Models with 17000 & 18000 lb Rear Axle
R	86-97	F-800	All Models with O.E.M. Number
R	80-90	F-800	All Models with 17000 & 18000 lb Rear Axle
R	86-87	HINO FD16	All Models with O.E.M. Number
R	88-92	FD17	All Models with O.E.M. Number
R	93-97	FD2218	All (FD5H), FE5H, FF5H
R	93-97	FD2218LD	
R	93-97	FD2218LP	All Models with O.E.M. Number
R	98	FE2620	All
R	98	FF SERIES	
83216	D	140149 (1)	
F	66-72	GMC 4500 SERIES	
F	66-72	5500 SERIES	
F	66-75	6500 SERIES	
R	92	HINO FA15	All FA, FB Models Trucks with:
R	93-97	FA1415	All (FA15)
R	93-97	FA1415	All FA, FB Models Trucks with:
R	93-97	FA1415	All FA1415 (FA15), FB1715 (FB15)
R	98-04	FA1517	All FA, FB Models Trucks with:
R	98	FA1517	All
R	98	FA1517	All FA1517, FA1817, FB1817
R	98	FA1817	
R	89-91	FB14	All FA, FB Models Trucks with:

Numerical listing

Shock	POP	Alternative No.	MTG Acc. Supplied
Pos.	Year	Application	
83216	D (cont)	140149 (1)	
R	92	FB15	All FA, FB Models Trucks with:
R	93-97	FB1715	All FA, FB Models Trucks with:
R	93-97	FB1715	All FA1415 (FA15), FB1715 (FB15)
R	98-04	FB1817	All FA, FB Models Trucks with:
R	98	FB1817	All
R	98	FB1817	All FA1517, FA1817, FB1817
F	93-97	FD2218	All (FD5H), FE5H, FF5H
F	93-97	FD2218LP	All Models with O.E.M. Number
F	86-87	FE16	All
F	90-91	GC17	All GC17
F	92	GC20	All GC20
83221	D	401754 (4)	
F	67-72	CHEVROLET 4, 40, 4000 & 4500 SERIES	
R	67-68	4, 40, 4000 & 4500 SERIES	
R	76-89	5, 50, 5000 & 5500 SERIES	
F	75-80	5, 50, 5000 & 5500 SERIES	
F	68-72	5, 50, 5000 & 5500 SERIES	
R	63-69	5, 50, 5000 & 5500 SERIES	
R	76-89	6, 60, 6000 & 6500 SERIES	
F	68-80	6, 60, 6000 & 6500 SERIES	
R	67-68	6, 60, 6000 & 6500 SERIES	
R	83-99	C4500 KODIAK	
R	92-99	C5500 KODIAK	
R	83-89	C5500 KODIAK	
R	90-91	C5500 KODIAK	All C Chassis - Conventional Cab with 9100 to 17500 lb Rear Axle
R	83-96	C6500 KODIAK	
R	97-99	C6500 KODIAK	All Conventional Cab with 9100 to 17500 lb Rear Axle
R	97-99	C7500 KODIAK	All Conventional Cab with 9100 to 17500 lb Rear Axle
R	60-66	GMC 3500 & 4000 SERIES	
R	72-80	4500 SERIES	
F	66-72	4500 SERIES	
F	76-89	5000 SERIES	
F	75-80	5000 SERIES	
R	60-62	5000 SERIES	
F	66-72	5500 SERIES	
R	66-80	6500 SERIES	
F	75-76	6500 SERIES	
F	66-72	6500 SERIES	
R	83-99	C - SERIES (C4500, C5500)	TOPKICK WORKHORSE VARIOUS
83225	D	401754 (4)	
R	70-90	FORD F-600	All Models with 13000 & 15000 lb Rear Axle
R	70-90	F-700	All Models with 13000 & 15000 lb Rear Axle
R	80-90	F-800	All Models with 13000 & 15000 lb Rear Axle
R	80-85	LN600	All Models with 11000, 13000, 15000, 17000 lb Axles
83243	N	140149 (1)	
R	19-21	CHEVROLET SILVERADO 4500 HD	All Models with 4 x 4 Rear
R	19-22	SILVERADO 5500 HD	All Models with 4 x 4 Rear
R	19-22	SILVERADO 6500 HD	All Models with 4 x 4 Rear
R	19-23	INTERNATIONAL CV515	All Models with 4 x 4 Rear
83303	D	140702 (1)	
F	73-89	CHEVROLET 6, 60, 6000 & 6500 SERIES	
F	72-80	GMC 4500 SERIES	
F	79-80	6000 SERIES	
F	75-89	6500 SERIES	
83308	D	140149 (1)	
F	80-86	FORD C600	All Models with 3100 lb Spring and 7000 lb Axle
F	80-86	C700	All Models with 3100 lb Spring and 7000 lb Axle
F	80-86	C7000	All Models with 3100 lb Spring and 7000 lb Axle
F	80-85	LN600	All Models with 3000, 3300 lb Springs and 5000, 5500, 6000, 7000 lb Axles
83309	D	140149 (1)	
F	80-94	FORD B-600	All B - Series - Bus Cowl Chassis

Numerical listing

Shock	POP	Alternative No.	MTG Acc. Supplied
Pos.	Year	Application	
83309	D	(cont)	140149 (1)
F	80-94	B-700 All B - Series - Bus Cowl Chassis	
F	83-87	B-7000 All B - Series - Bus Cowl Chassis	
F	80-94	F-600 All Exc. 9000 lb Axle with H.D. Suspension & 12000 lb Axle	
F	90	F-600 All Models with Multileaf Spring	
F	80-94	F-700 All Exc. 9000 lb Axle with H.D. Suspension & 12000 lb Axle	
F	90	F-700 All Models with Multileaf Spring	
F	80-94	F-800 All Exc. 9000 lb Axle with H.D. Suspension & 12000 lb Axle	
F	90	F-800 All Models with Multileaf Spring	
F	80-87	F-7000 All Exc. 9000 lb Axle with H.D. Suspension & 12000 lb Axle	
83312	D		140149 (1)
F	80-86	FORD C600 All Models with 4040, 5040 lb Springs and 7000, 9000, 12000 lb Axles	
F	80-86	C700 All Models with 4040, 5040 lb Springs and 7000, 9000, 12000 lb Axles	
F	80-86	C7000 All Models with 4040, 5040 lb Springs and 7000, 9000, 12000 lb Axles	
F	80-85	LN600 All Models with 4400 lb Spring and 7000, 9000 lb Axles	
F	93-05	KENWORTH K300 All Models with Multiple Leaf Springs on Front Axle (3/4" Mounting bolts)	
F		T300	
83314	D		140149 (1)
F	83-89	FORD F-600 All Models with 9000 lb Axle with H.D. Suspension & 12000 lb Axle	
F	94-98	F-700 All Models with Taperleaf Springs and with 6000, 7000, 8500, 9000 lb Axle	
F	83-89	F-700 All Models with 9000 lb Axle with H.D. Suspension & 12000 lb Axle	
F	94-98	F-800 All Models with Taperleaf Springs and with 6000, 7000, 8500, 9000 lb Axle	
F	83-89	F-800 All Models with 9000 lb Axle with H.D. Suspension & 12000 lb Axle	
F	83-87	F-7000 All Models with 9000 lb Axle with H.D. Suspension & 12000 lb Axle	
83317	D		141083 (1)
R	14	FORD F-650	
R	15	F-650 All Models with 22,000 lb Multi-leaf Rear Springs	
R	04-13	F-650 All Models with 22,000 lb Multi-leaf Rear Springs	
R	15	F-750 All Models with 22,000 lb Multi-leaf Rear Springs	
R	04-13	F-750 All Models with 22,000 lb Multi-leaf Rear Springs	
R	04-15	GLAVAL BUS CO. CONCORDE II - SERIES	
R	08-15	IC CORPORATION BE SCHOOL BUS All School Buses with O.E.M. Number	
R	10-13	CE SCHOOL BUS All CE Model School Buses with 22,000 lb Rear Spring Suspension	
R	02-13	INTERNATIONAL 4300 All Models with 22,000 lb Rear Spring Suspension	
R	02-13	4400 All Models with 22,000 lb Rear Spring Suspension	
R	13	DURASTAR All Models with 22,000 lb Rear Spring Suspension	
R	04-11	STARCRAFT BUS CO. ALLSTAR XL & XLT - SERIES	
83364	D		
R	16-20	INTERNATIONAL DURASTAR All Models with 10,500 or 13,500 lb Vari-Rate Rear Spring Suspension	
R	12-17	TERRASTAR All Models with 10,000 & 13,500 lb Vari-Rate Rear Spring Suspension	
R	12-17	TERRASTAR All Models with 10,500 or 13,500 lb Vari-Rate Rear Spring Suspension	

83000 Series, 85000 Series

Shock	POP	Alternative No.	MTG Acc. Supplied
Pos.	Year	Application	
83391	D		145177 (2)
F	15-21	HINO 258 All Models with O.E.M. Number	
F	15-22	268 All Models with O.E.M. Number	
F	22-23	L6	
F	21	L6 All Models with O.E.M. Number	
83395	D		145054 (1)
R	16-17	INTERNATIONAL DURASTAR All Models with Vari-Rate Rear Spring Suspension	
83397	N		
F	19-22	CHEVROLET SILVERADO 4500 HD All Models with Taperleaf Front	
F	19-23	SILVERADO 5500 HD All Models with Taperleaf Front	
F	19-23	SILVERADO 6500 HD All Models with Taperleaf Front	
F	24	INTERNATIONAL CV515	
F	19-23	CV515 All Models with Taperleaf Front	
83398	N		
R	19-22	CHEVROLET SILVERADO 4500 HD All Models with 11K, 13.5K or 15.5K VARI-RATE Rear Suspension	
R	19-23	SILVERADO 5500 HD All Models with 11K, 13.5K or 15.5K VARI-RATE Rear Suspension	
R	19-23	SILVERADO 6500 HD All Models with 11K, 13.5K or 15.5K VARI-RATE Rear Suspension	
R	24	INTERNATIONAL CV515	
R	19-23	CV515 All Models with 11K, 13.5K or 15.5K VARI-RATE Rear Suspension	
83456	C		142998 (2)
F	03-18	IC CORPORATION RE SCHOOL BUS All RE Model School Buses with O.E.M. Number	
F	86-88	MITSUBISHI FUSO FM All Models with O.E.M. Number	
83515	D		140885 (1)
F	16-23	CHEVROLET LCF 3500 All	
F	18	LCF 3500HD	
F	16-17	LCF 3500HD All	
F	19-22	SILVERADO 4500 HD All Diesel Low Cab Forward models with 14,500 lb GVWR	
F	19-22	SILVERADO 4500 HD All Diesel Low Cab Forward models with 16,000 lb to 19,500 lb GVWR	
F	19-22	SILVERADO 5500 HD All Diesel Low Cab Forward models with 14,500 lb GVWR	
F	19-22	SILVERADO 5500 HD All Diesel Low Cab Forward models with 16,000 lb to 19,500 lb GVWR	
F	87-10	W4500 TILTMMASTER All Models with 11000 lb & 13000 lb Suspension	
F	88-10	W5500 TILTMMASTER All Models with 11000 lb & 13000 lb Suspension	
F	87-96	W6500 TILTMMASTER All Models with 11000 lb & 13000 lb Suspension	
F	92-10	GMC W4500 FORWARD All Models with 11000 lb & 13000 lb Suspension	
F	88-10	W5500 FORWARD All Models with 11000 lb & 13000 lb Suspension	
F	87-96	W6500 FORWARD All Models with 11000 lb & 13000 lb Suspension	
F		W - SERIES (ISUZU)	
F	85	ISUZU ADDITIONAL APPLICATIONS ALL MODELS WITH	
F		FSR	
F	86	FSR	
F	87-92	FSR All FSR Models	
F	05-09	FTR All Models with O.E.M. Number	
F	19-23	NPR	
F	84-85	NPR	
F	86-18	NPR All Models with O.E.M. Number	
F	99-23	NPR-HD All Models with O.E.M. Number	
F	23	NPR-XD	
F	15-22	NPR-XD All Models with 14,000 to 15,000 lb GVW	
F	15-22	NPR-XD All Models with 15,000 to 16,000 lb GVW	

Numerical listing

Shock	POP	Alternative No.	MTG Acc. Supplied
Pos.	Year	Application	
83515	D	(cont)	140885 (1)
F	94-23	NQR All Models with O.E.M. Number	
F	05-23	NRR All Models with O.E.M. Number	
F	88-94	NRR All Models with O.E.M. Number	
F	11-15	REACH All Models with O.E.M. Number	
F	99-04	UD 1200 All Models with O.E.M. Number	
F	05-07	1300 All Models with O.E.M. Number	
F	94-10	1400 All Models with O.E.M. Number	
83518	D		141041 (1)/TR0027 (2)
F	13-20	HINO 155 All Models with O.E.M. Number	
F	21	195	
F	12-20	195 All Models with O.E.M. Number	
83519	D		401011 (4)
R	16-20	HINO 155 All Models with O.E.M. Number	
R	21	195	
R	12-20	195 All Models with O.E.M. Number	
83613	D		141083 (2)
R	87-96	ISUZU FSR All FSR Models	
R	88-96	FTR All Models with O.E.M. Number	
R	94-96	FVR All Models with O.E.M. Number	
R	88-92	FVR All Models with O.E.M. Number	
85000 Series			
85000	A		
R		THOMAS VARIOUS	
85001	B		401754 (4)
R	94-97	FORD F-800 All Models with 21000 Taperleaf Springs	
F	93-05	KENWORTH K300 All Models with Taper Leaf Springs on Front Axle (1" Mounting bolts)	
F		T300	
85005	C		
F	60-68	CHEVROLET 4, 40, 4000 & 4500 SERIES	
F	63-69	5, 50, 5000 & 5500 SERIES	
R	19-23	ENTEGRA COACH EMBLEM All MotorHomes with Ford F53 Chassis with 24,000 lb GVW to 26,000 lb GVW	
R	20-23	VISION XL All MotorHomes with Ford F53 Chassis with 24,000 lb GVW to 26,000 lb GVW	
R	08-23	FLEETWOOD BOUNDER All MotorHomes with Ford F53 Chassis with 24,000 lb GVW to 26,000 lb GVW	
R	20-23	FORTIS All MotorHomes with Ford F53 Chassis with 24,000 lb GVW to 26,000 lb GVW	
R	08-23	SOUTHWIND All MotorHomes with Ford F53 Chassis with 24,000 lb GVW to 26,000 lb GVW	
R	08-23	FORD F-53	
R	08-23	F-53 MOTORHOME CHASSIS All MotorHomes with Ford F53 Chassis with 24,000 lb GVW to 26,000 lb GVW	
R	20-23	FOREST RIVER GEORGETOWN GT7 All MotorHomes with Ford F53 Chassis with 24,000 lb GVW to 26,000 lb GVW	
F		FREIGHTLINER BUS CHASSIS VARIOUS	
F	63-66	GMC 3500 & 4000 SERIES	
F	63-68	5000 SERIES	
F	63-68	5500 SERIES	
F	63-68	6000 SERIES	
R	20-23	HOLIDAY RAMBLER INVICTA All MotorHomes with Ford F53 Chassis with 24,000 lb GVW to 26,000 lb GVW	
R	11-23	VACATIONER All MotorHomes with Ford F53 Chassis with 24,000 lb GVW to 26,000 lb GVW	
R	09	VACATIONER All MotorHomes with Ford F53 Chassis with 24,000 lb GVW to 26,000 lb GVW	

Numerical listing

Shock	POP	Alternative No.	MTG Acc. Supplied
Pos.	Year	Application	
85005 C (cont)			
R	11-23	THOR MOTOR COACH OUTLAW All MotorHomes with Ford F53 Chassis with 24,000 lb GVW to 26,000 lb GVW	
R	19-23	WINNEBAGO ADVENTURER All MotorHomes with Ford F53 Chassis with 24,000 lb GVW to 26,000 lb GVW	
R	08-17	ADVENTURER All MotorHomes with Ford F53 Chassis with 24,000 lb GVW to 26,000 lb GVW	
R	16-22	SUNSTAR All MotorHomes with Ford F53 Chassis with 24,000 lb GVW to 26,000 lb GVW	
R	08-22	VISTA All MotorHomes with Ford F53 Chassis with 24,000 lb GVW to 26,000 lb GVW	
85006 B			
F	19-24	ENTEGRA COACH EMBLEM All MotorHomes with Ford F53 Chassis with 24,000 lb GVW to 26,000 lb GVW	
F	20-24	VISION XL All MotorHomes with Ford F53 Chassis with 24,000 lb GVW to 26,000 lb GVW	
F	08-24	FLEETWOOD BOUNDER All MotorHomes with Ford F53 Chassis with 24,000 lb GVW to 26,000 lb GVW	
F	20-24	FORTIS All MotorHomes with Ford F53 Chassis with 24,000 lb GVW to 26,000 lb GVW	
F	08-23	SOUTHWIND All MotorHomes with Ford F53 Chassis with 24,000 lb GVW to 26,000 lb GVW	
F	08-23	FORD F-53	
F	24	F-53 MOTORHOME CHASSIS	
F	08-23	F-53 MOTORHOME CHASSIS All MotorHomes with Ford F53 Chassis with 24,000 lb GVW to 26,000 lb GVW	
F	24	F-59 COMMERCIAL STRIPPED CHASSIS	
F	11-23	F-59 COMMERCIAL STRIPPED CHASSIS All MotorHomes with Ford F59 Commercial Chassis with 24,000 lb GVW to 26,000 lb GVW	
F	20-23	FOREST RIVER GEORGETOWN GT7 All MotorHomes with Ford F53 Chassis with 24,000 lb GVW to 26,000 lb GVW	
F	FREIGHTLINER BUS CHASSIS		
F	97-08	BUS CHASSIS	
F	05-07	FC70	
F	99-04	FC70 All Models with 10,000 to 18,000 lb Suspension	
F	95-05	FL50 All Models with 10,000 to 18,000 lb Suspension	
F	91-05	FL60 All Models with 10,000 to 18,000 lb Suspension	
F	20-24	HOLIDAY RAMBLER INVICTA All MotorHomes with Ford F53 Chassis with 24,000 lb GVW to 26,000 lb GVW	
F	11-24	VACATIONER All MotorHomes with Ford F53 Chassis with 24,000 lb GVW to 26,000 lb GVW	
F	09	VACATIONER All MotorHomes with Ford F53 Chassis with 24,000 lb GVW to 26,000 lb GVW	
F	STERLING TRUCK ACTERRA THOMAS VARIOUS		
F	03	VARIOUS	
F	11-24	THOR MOTOR COACH OUTLAW All MotorHomes with Ford F53 Chassis with 24,000 lb GVW to 26,000 lb GVW	
F	19-23	WINNEBAGO ADVENTURER All MotorHomes with Ford F53 Chassis with 24,000 lb GVW to 26,000 lb GVW	
F	08-17	ADVENTURER All MotorHomes with Ford F53 Chassis with 24,000 lb GVW to 26,000 lb GVW	
F	16-23	SUNSTAR All MotorHomes with Ford F53 Chassis with 24,000 lb GVW to 26,000 lb GVW	
F	08-23	VISTA All MotorHomes with Ford F53 Chassis with 24,000 lb GVW to 26,000 lb GVW	

85000 Series

Shock	POP	Alternative No.	MTG Acc. Supplied
Pos.	Year	Application	
85007 D 401754 (4)			
F	93-05	KENWORTH K300 All K300 COE Medium Duty	
R	97-00	SPARTAN MOTORS K2 All Models with O.E.M. Number	
R	97-00	MOUNTAIN MASTER All Models with O.E.M. Number	
85009 D 145054 (1)			
F	91-94	MITSUBISHI FUSO FK All FK457 Models with O.E.M. Number	
F	88-91	FK All FK455 Models with O.E.M. Number	
85010 D			
R	11-20	FORD F-53	
R	11-20	F-53 MOTORHOME CHASSIS All F53 Stripped Chassis With BT Delivery Van Pack, 16,000 LB. GVW	
R	11-21	F-59 COMMERCIAL STRIPPED CHASSIS All F59 Commercial Chassis with 16,000 lb or 19,500 GVW	
R	88-97	F-59 COMMERCIAL STRIPPED CHASSIS All F59 Commercial Chassis with 16,000 lb or 19,500 GVW	
F	00-01	HOLIDAY RAMBLER ADMIRAL All Models with Workhorse W22 Chassis with 8.1L Gas V8	
F	00-03	ENDEAVOR All Models with Workhorse W22 Chassis with 8.1L Gas V8	
F	00-03	VACATIONER All Models with Workhorse W22 Chassis with 8.1L Gas V8	
F	00-03	MONACO COACH CLASS A MOTORHOMES	
85012 B 145080 (2)			
R	85	ISUZU ADDITIONAL APPLICATIONS	
R	86-95	NPR All	
F	13	PETERBILT 220 All Models with 12,000 lb Front Axle	
F	10	220 All Models with 12,000 lb Front Axle	
F	07	220 All Models with 12,000 lb Front Axle	
F	08-19	325 All Models with 12000 lb Set Back Front Axle	
F	07-16	330 All Models with 12000 lb Set Back Front Axle	
F	95-05	330 All Models with 12000 lb Set Back Front Axle	
85013 C			
F	11-20	FORD F-53	
F	11-20	F-53 MOTORHOME CHASSIS All F53 Stripped Chassis Commercial Stripped Chassis, 19,500 lb to 22,000 lb GVW	
F	11-21	F-59 COMMERCIAL STRIPPED CHASSIS All F59 Commercial Chassis with 16,000 lb to 22,000 GVW	
F	88-97	F-59 COMMERCIAL STRIPPED CHASSIS All F59 Commercial Chassis with 16,000 lb to 22,000 GVW	
R	13-22	PETERBILT 220 All Models with Reyco 102AR (Standard) Rear Air Suspension	
R	10	220 All Models with Reyco 102AR (Standard) Rear Air Suspension	
R	07	220 All Models with Reyco 102AR (Standard) Rear Air Suspension	
R	07-21	330 All Models with Reyco 102AR (Standard) Rear Air Suspension	
R	95-05	330 All Models with Reyco 102AR (Standard) Rear Air Suspension	
R	91-92	SPARTAN MOTORS MOTORHOME All Models with Tuthill 102 AR Air Suspension	
R	93-95	MOUNTAIN MASTER All Models with Tuthill 102 AR Air Suspension	
85014 C			
F	THOMAS VARIOUS		
85029 B			
R	06	COACHMEN CROSS COUNTRY	
R	03-05	CROSS COUNTRY ELITE	
R	03-05	CROSS COUNTRY SE	
F	00-10	COUNTRY COACH AFFINITY All MotorHomes with Neway IFS	

Numerical listing

Shock	POP	Alternative No.	MTG Acc. Supplied
Pos.	Year	Application	
85029 B (cont)			
F	00	CONCEPT All MotorHomes with Neway IFS	
F	00-04	MAGNA All MotorHomes with Neway IFS	
F	05-10	MAGNA 630 All MotorHomes with Neway IFS	
R	02-06	FLEETWOOD BOUNDER All MotorHomes with Freightliner XC Chassis and ADL200 Suspension w/ 20K Rear	
R	02-06	DISCOVERY All MotorHomes with Freightliner XC Chassis and ADL200 Suspension w/ 20K Rear	
R	02-06	EXCURSION All MotorHomes with Freightliner XC Chassis and ADL200 Suspension w/ 20K Rear	
R	04-06	PROVIDENCE All MotorHomes with Freightliner XC Chassis and ADL200 Suspension w/ 20K Rear	
R	02-04	FOREST RIVER REFLECTION	
R	02-06	TSUNAMI	
R	03-12	FREIGHTLINER VC CHASSIS	
R	03-12	XC CHASSIS	
R	03-06	GULF STREAM ATRIUM	
R	02-06	FRIENDSHIP	
R	02	INDEPENDENCE All MotorHomes with Freightliner XC Chassis and ADL200 Suspension w/ 20K Rear	
R	02-06	SCENIC CRUISER	
R	02-04	YELLOWSTONE	
R	95-03	HOLIDAY RAMBLER CLASS A MOTORHOMES	
R	02-06	ITASCA CLASS A MOTORHOMES	
R	04-06	KING OF THE ROAD CLASS A MOTORHOMES	
R	04-06	MANDALAY COACH CLASS A MOTORHOMES	
R	95-99	MONACO COACH VARIOUS	
R	02-06	NEWMAR CLASS A MOTORHOMES	
R	97-00	SPARTAN MOTORS ALPINE All MotorHome Chassis with O.E.M. Number	
R	97-00	VARIOUS	
R	02-06	THOR MOTOR COACH CLASS A MOTORHOMES	
R	02-06	WINNEBAGO JOURNEY All MotorHomes with Freightliner XC Chassis and ADL200 Suspension w/ 20K Rear	
R	06	TOUR All MotorHomes with Freightliner XC Chassis and ADL200 Suspension w/ 20K Rear	
R	06	VECTRA All MotorHomes with Freightliner XC Chassis and ADL200 Suspension w/ 20K Rear	
85030 C			
R	97-00	SPARTAN MOTORS HIGHLANDER All With I Beam Front Suspension	
R	91-96	K2	
R	97-00	K2 All With I Beam Front Suspension	
R	97-00	K2 All With Independent Front Granning Suspension	
R	97-00	MOUNTAIN MASTER All With Independent Front Granning Suspension	
R	95-00	MOUNTAIN MASTER All With I Beam Front Suspension	
85031 D 145147(1)/TR0027(2)			
F	93-05	KENWORTH K300 All Models with 12,000 lb Taper Leaf Front Springs (5/8" Top Mounting bolt)	
F	08-13	T170 All Models with 8,000 lb Taper Leaf Front Springs	
F	08-10	T270 All Models with 12,000 lb Front Axle	
F	99-08	T300 All Models with 12,000 lb Taper Leaf Front Springs (5/8" Top Mounting bolt)	
85033 B 145099 (1)			
R	95-02	PETERBILT 330 All Models with Peterbilt 40000 lb Low Air Leaf Suspension	
85036 C			
R	SPARTAN MOTORS VARIOUS XOS ADDITIONAL O.E.M. INTERCHANGES		
85043 D			
F	FREIGHTLINER BUS CHASSIS		

Numerical listing

Shock	POP	Alternative No.	MTG Acc. Supplied
Pos.	Year	Application	
85043	D (cont)		
F	05-07	FC70	
F	99-04	FC70	All Models with 6000 to 9000 lb Front axle
F	95-05	FL50	All Models with 6000 to 9000 lb Front axle
F	91-05	FL60	All Models with 6000 to 9000 lb Front axle
F	00-02	XCS CHASSIS	
85054	D		145080 (2)
F	96-97	FORD CF7000	All Models with 16000 lb. Multileaf Spring
85058	C		
F		FREIGHTLINER MB CHASSIS	
F	98-23	MT45	All Step Van Models with O.E.M. Number
F		MT55	
F		VARIOUS	
F		THOMAS VARIOUS	
85063	D		145080 (2)
F	94-97	FORD F-700	All Models with 52" or 54" Taperleaf Springs and with 10000 or 12000 lb Axle
F	94-97	F-800	All Models with 52" or 54" Taperleaf Springs and with 10000 or 12000 lb Axle
85067	A		
R	11-16	KENWORTH T700	All Models with Air Glide 380 (AG380) Rear Air Suspension
85069	A		145089-000 (2)
R	24	KENWORTH T270	
R	08-23	T270	All Models with AG210L Rear Air Suspension
R	11-16	T700	All Models with Air Glide 400L (AG400L) Rear Air Suspension
R	07-22	PETERBILT 330	All Models with Peterbilt Low Air Leaf Suspension
R	03-05	330	All Models with Peterbilt Low Air Leaf Suspension
R	22-24	536	All Models with Peterbilt Low Air Leaf Suspension
85070	A		401754 (2)
F	11-16	KENWORTH T700	All Models with 13,000 lb Front Axle
85071	D		145054 (2)
R	90-07	CHEVROLET B6	
R	93-02	B7	All With 15000, 19000, 21000 lb Multileaf Springs
R	90-96	C60 KODIAK	All Conventional Cab w/15000, 19000, 21000 lb Multileaf Springs
R	90-96	C70 KODIAK	All Conventional Cab w/15000, 19000, 21000 lb Multileaf Springs
R	90-02	C4500 KODIAK	
R	03-09	C4500 KODIAK	All C Chassis - Conventional Cab With 15000, 19000, 21000 lb Multileaf Springs
R	92-02	C5500 KODIAK	
R	03-09	C5500 KODIAK	All C Chassis - Conventional Cab With 15000, 19000, 21000 lb Multileaf Springs
R	90-91	C5500 KODIAK	All C Chassis - Conventional Cab With 15000, 19000, 21000 lb Multileaf Springs
R	97-09	C6500 KODIAK	All Conventional Cab w/15000, 19000, 21000 lb Multileaf Springs
R	97-09	C7500 KODIAK	All Conventional Cab w/15000, 19000, 21000 lb Multileaf Springs
R	90-06	T5500	
R	03	T6500	
R	90-96	T6500	
R	04-06	T6500	All Tilt Cab w/15000, 19000, 21000 lb Multileaf Springs
R	97-02	T6500	All Tilt Cab w/15000, 19000, 21000 lb Multileaf Springs
R	93-02	GMC B7	All School Bus Chassis w/15000, 19000, 21000 lb Multileaf Springs
R	90-02	C4500 TOPKICK	
R	03-09	C4500 TOPKICK	All C Chassis - Conventional Cab with 15000, 19000, 21000 lb Multileaf Springs
R	90-02	C5500 TOPKICK	

85000 Series

Shock	POP	Alternative No.	MTG Acc. Supplied
Pos.	Year	Application	
85071	D (cont)		145054 (2)
R	03-09	C5500 TOPKICK	All C Chassis - Conventional Cab with 15000, 19000, 21000 lb Multileaf Springs
R	90-06	T5500	
R	03	T6500	
R	90-96	T6500	
R	04-06	T6500	All Tilt Cab with 15000, 19000, 21000 lb Multileaf Springs
R	97-02	T6500	All Tilt Cab with 15000, 19000, 21000 lb Multileaf Springs
R	97-02	ISUZU FSR	All Models with 15000, 19000, 21000 lb Multileaf Springs
F	18-20	FTR	All FTR Diesel Models with Std Cab
R	90-09	FTR	All Models with 15000, 19000, 21000 lb Multileaf Springs
R	94-09	FVR	All Models with 15000, 19000, 21000 lb Multileaf Springs
R	90-92	FVR	All Models with 15000, 19000, 21000 lb Multileaf Springs
85072	B		
R	19-23	INTERNATIONAL HV607	All Models with Hendrickson Primaax 230/460 Air Suspension with 9" Ride Height
R	08-22	KENWORTH T270	All Models with Hendrickson Primaax 230, 232, 460, 462, 690 and 692 Air Suspension (8-1/2" to 10" Ride Height)
R	19-23	PIERCE MFG. INC.	VARIOUS
85082	D		
R	16-17	IC CORPORATION CE SCHOOL BUS	All CE Model School Buses with 20,000 lb Rear Air Suspension
85084	C		
F	10-14	KENWORTH T270	All Models with 10,000 lb to 12,000 lb Front Axle
F	10-14	T270	All Models with 13,200 lb to 14,600 lb Front Axle
F	10-14	T270	All Models with 8,000 lb Front Axle
F	08-15	PETERBILT 325	All Models with 8,000 lb Front Axle
85122	W		145089-000 (1)
R	09-12	FREIGHTLINER BUS CHASSIS	
R	09-12	THOMAS VARIOUS	
85124	D		145054 (2)
R	04-11	DAMON CLASS A MOTORHOMES	
R	04-11	FLEETWOOD CLASS A MOTORHOMES	
R	04-11	HOLIDAY RAMBLER CLASS A MOTORHOMES	
R	04-11	ITASCA CLASS A MOTORHOMES	
R	09	MONACO COACH LA PALMA	All Models with W20 & W22 Workhorse Motorhome Chassis
R	04-06	LA PALMA	All Models with W20 & W22 Workhorse Motorhome Chassis
R	06-11	MONARCH	All Models with W20 & W22 Workhorse Motorhome Chassis
R	04-08	NATIONAL RV CLASS A MOTORHOMES	
R	04-09	WINNEBAGO ADVENTURER	All Models with Workhorse W22, & W24 MotorHome Chassis with O.E.M. Number
R	04-09	WORKHORSE W20	All Models with O.E.M. Number
R	04-09	W22	All Models with O.E.M. Number
R	04-09	W24	All Models with O.E.M. Number
85125	D		
F	98-11	DAMON CLASS A MOTORHOMES	
F	98-11	HOLIDAY RAMBLER CLASS A MOTORHOMES	
F	98-11	ITASCA CLASS A MOTORHOMES	
F	98-11	MONACO COACH CLASS A MOTORHOMES	
F	09	LA PALMA	All Models with W20 & W22 Workhorse Motorhome Chassis
F	02-06	LA PALMA	All Models with W20 & W22 Workhorse Motorhome Chassis
F	00	LA PALMA	All Models with W20 & W22 Workhorse Motorhome Chassis
F	06-11	MONARCH	All Models with W20 & W22 Workhorse Motorhome Chassis
F	01-02	MONARCH	All Models with W20 & W22 Workhorse Motorhome Chassis

Numerical listing

Shock	POP	Alternative No.	MTG Acc. Supplied
Pos.	Year	Application	
85125	D (cont)		
F	98-08	NATIONAL RV CLASS A	MOTORHOMES
F	98-11	WINNEBAGO ADVENTURER	All Models with W20 & W22 Workhorse Motorhome Chassis
F	02-11	WORKHORSE VARIOUS	
F	10-11	W20	
F	98-00	W20	
F	01-09	W20	All
F	10-14	W22	
F	98-00	W22	
F	01-09	W22	All
F	10-11	W24	
F	98-03	W24	
F	04-09	W24	All
85180	W		
R	21-24	FORD F-650	All Models with 13,500, 15,500 & 19,000 lb Multi-leaf Rear Springs
R	15-19	F-650	All Models with 13,500, 15,500 & 19,000 lb Multi-leaf Rear Springs
R	21-24	F-750	All Models with 13,500, 15,500 & 19,000 lb Multi-leaf Rear Springs
R	15-19	F-750	All Models with 13,500, 15,500 & 19,000 lb Multi-leaf Rear Springs
R	15-23	GLAVAL BUS CO. CONCORDE II - SERIES	
R	15-23	STARCRAFT BUS CO. ALLSTAR XL & XLT - SERIES	
85181	D		
F	21-24	FORD F-650	All Models with 19.5" or 22.5" Wheels (22,000 lb GVW)
F	15-19	F-650	All Models with 19.5" or 22.5" Wheels (22,000 lb GVW)
F	21-24	F-750	All Models with 19.5" or 22.5" Wheels (22,000 lb GVW)
F	15-19	F-750	All Models with 19.5" or 22.5" Wheels (22,000 lb GVW)
F	15-23	GLAVAL BUS CO. CONCORDE II - SERIES	
F	15-23	STARCRAFT BUS CO. ALLSTAR XL & XLT - SERIES	
85182	D		145089-200 (2)
F	13-24	KENWORTH K270	All Models with 10,000 lb to 12,000 lb Front Axle
F	13-23	PETERBILT 220	All Models with 12,000 lb Front Axle
85188	D		
R	23	MACK MD6	
R	24	MD6	All Models with O.E.M. Number
R	21-22	MD6	All Models with O.E.M. Number
85301	D		401754 (4)
F	86-97	FORD CF7000	All Models with 12000 lb or 13000 lb Axle
85302	D		401754 (4)
R	86-97	FORD CF7000	All Models with 12000 lb or 13000 lb Axle
85304	D		401754 (4)
R	73-78	CHEVROLET 6, 60, 6000 & 6500 SERIES	
F		THOMAS VARIOUS	
85307	D		401754 (4)
F	60-68	GMC 5500 SERIES	
F	60-68	6000 SERIES	
F		SPARTAN MOTORS VARIOUS	
R		THOMAS VARIOUS	
85310	B		141108 (1)
R	93-05	KENWORTH K300	All All with Air Glide 100 Suspension with 8 air bags, 4 units required T300
85311	A		141247 (1)
R	07-21	PETERBILT 330	All Models with Air Trac Suspension (46,000 lb)
R	95-05	330	All Models with Air Trac Suspension (46,000 lb)
85314	D		401754 (4)
R	94	FORD B-700	All Models with 15000, 17500, 19000 lb Taperleaf Springs

Numerical listing

Shock	POP	Alternative No.	MTG Acc. Supplied
Pos.	Year	Application	
85314	D	(cont)	401754 (4)
R	94-98	F-700 All Models with 15000, 17500, 19000 lb Taperleaf Springs	
R	94-98	F-800 All Models with 15000, 17500, 19000 lb Taperleaf Springs	
85329	D		401754 (4)
F		EMERGENCY ONE VARIOUS	
85331	C		
R	05-15	FREIGHTLINER M2 All Models with Freightliner Low Profile Rear Air Suspension (18,000 to 40,000 lb)	
R	02-10	M2 100 All Models with Freightliner Low Profile Rear Air Suspension (18,000 to 40,000 lb)	
R	02-15	M2 106 All Models with Freightliner Low Profile Rear Air Suspension (18,000 to 40,000 lb)	
R		MB CHASSIS	
R	99-23	MT55 All Models with Freightliner Low Profile Rear Air Suspension	
85332	D		145128 (1)
F	03-18	IC CORPORATION RE SCHOOL BUS All RE Model School Buses with 12,000 to 14,000 lb Front Axles	
85335	D		
R	05-21	FREIGHTLINER M2 All Models with Rear 10000 lb - 15000 lb Low Profile AirLiner	
R	02-10	M2 100 All Models with Rear 10000 lb - 15000 lb Low Profile AirLiner	
R	02-23	M2 106 All Models with Rear 10000 lb - 15000 lb Low Profile AirLiner	
85351	W		145090 (1)
F	03-18	IC CORPORATION RE SCHOOL BUS All RE Model School Buses with O.E.M number	
85376	D		401754 (4)
F	92-97	FORD CF7000 All Models with 9000 lb Axle	
85649	D		143146 (1)
F	12-18	RAM 4500 All Models with O.E.M. Number	
F	12-18	5500 All Models with O.E.M. Number	
F	08-10	STERLING TRUCK BULLET 45 All Models with O.E.M. Number	
F	08-10	BULLET 55 All Models with O.E.M. Number	
85650	D		
R	12-18	RAM 4500 All Models with O.E.M. Number	
R	12-18	5500 All Models with O.E.M. Number	
R	08-10	STERLING TRUCK BULLET 45 All Models with O.E.M. Number	
R	08-10	BULLET 55 All Models with O.E.M. Number	
85656	C		
R	14	FORD F-650	
R	15	F-650 All Models with 21,000 lb Rear Air Suspension	
R	04-13	F-650 All Models with 21,000 lb Rear Air Suspension	
R	15	F-750 All Models with 21,000 lb Rear Air Suspension	
R	04-13	F-750 All Models with 21,000 lb Rear Air Suspension	
R	04-15	GLAVAL BUS CO. CONCORDE II - SERIES	
R	10-23	IC CORPORATION CE SCHOOL BUS All CE Model School Buses with 20,000 lb International IROS Air Suspension	
R	16-19	INTERNATIONAL DURASTAR All Models with 20,000 lb International IROS Air Suspension	
R		DURASTAR - 4300, 4400 SERIES	
R	16-19	DURASTAR - 4300, 4400 SERIES	
R	20-22	MV607 All Models with 20,000 lb International IROS Air Suspension	
R	19	MV SERIES	
R	20-22	PIERCE MFG. INC. VARIOUS	
R	15	STARCRRAFT BUS CO. ALLSTAR XL & XLT - SERIES	

85000 Series

Shock	POP	Alternative No.	MTG Acc. Supplied
Pos.	Year	Application	
85670	N		
R	19-22	CHEVROLET SILVERADO 4500 HD All Models with IROS Rear	
R	19-22	SILVERADO 5500 HD All Models with IROS Rear	
R	19-22	SILVERADO 6500 HD All Models with IROS Rear	
R	19-23	INTERNATIONAL CV515 All Models with IROS Rear	
85702	D		401754 (4)
R		SPARTAN MOTORS VARIOUS	
85712	C		401754 (4)
F	00-10	COUNTRY COACH AFFINITY All MotorHomes with Ridewell Suspension	
F	00	CONCEPT All MotorHomes with Ridewell Suspension	
F	00-04	MAGNA All MotorHomes with Ridewell Suspension	
F	05-10	MAGNA 630 All MotorHomes with Ridewell Suspension	
F		SPARTAN MOTORS VARIOUS	
F	86	VARIOUS	
85716	D		145093 (1)
R	90-94	FORD F-600 LPO All Models with O.E.M. Number	
R	90-94	F-700 LPO All Models with O.E.M. Number	
85723	D		145075 (1)
F	00-10	COUNTRY COACH AFFINITY All MotorHomes with Gillig Chassis w/ Neway I-beam front	
F	00-04	ALLURE All MotorHomes with Gillig Chassis w/ Neway I-beam front	
F	00	CONCEPT All MotorHomes with Gillig Chassis w/ Neway I-beam front	
F	00-04	INTRIGUE All MotorHomes with Gillig Chassis w/ Neway I-beam front	
F	00-04	MAGNA All MotorHomes with Gillig Chassis w/ Neway I-beam front	
F	05-10	MAGNA 630 All MotorHomes with Gillig Chassis w/ Neway I-beam front	
85724	A		
R	13-22	DYNAMAX CORP DX3 All Models with Airliner 21,000 lb Rear Air Suspension	
R	05-07	DYNAQUEST All Models with Airliner 18,000 lb Rear Air Suspension	
R	09-14	DYNAQUEST ST All Models with Airliner 18,000 lb Rear Air Suspension	
R	09-22	DYNAQUEST XL All Models with FAS II (40,000 lb) Rear Air Suspension	
R	21-22	EUROPA All Models with Airliner 21,000 lb Rear Air Suspension	
R	22	FORCE HD All Models with Airliner 21,000 lb Rear Air Suspension	
R	15-18	FORCE HD All Models with Airliner 21,000 lb Rear Air Suspension	
R	02-04	GRAND SPORT All Models 23,000 lb Airliner Rear Air Suspension	
R	09-14	GRAND SPORT GT All Models with Freightliner Airliner Rear Air Suspension	
R	07-13	GRAND SPORT GT TOY HAULER All Models 21K or 23K Airliner Rear Air Suspension	
R	03-07	GRAND SPORT M2 All Models with Airliner 21,000 lb Rear Air Suspension	
R	07-14	GRAND SPORT ULTRA All Models 23,000 lb Airliner Rear Air Suspension	
R	02-19	FEDERAL COACH VARIOUS	
R	05-23	FREIGHTLINER B2 All Models with FAS II (40,000 lb) Rear Air Suspension	
R	05-07	FC70	
R	95-05	FL50 All Models with FAS II (40,000 lb) Rear Air Suspension	
R	91-05	FL60 All Models with FAS II (40,000 lb) Rear Air Suspension	
R	05-21	M2 All Models with FAS II (40,000 lb) Rear Air Suspension	
R	02-10	M2 100 All Models with FAS II (40,000 lb) Rear Air Suspension	
R	02-24	M2 106 All Models with FAS II (40,000 lb) Rear Air Suspension	

Numerical listing

Shock	POP	Alternative No.	MTG Acc. Supplied
Pos.	Year	Application	
85724	A	(cont)	
R	03-10	STERLING TRUCK ACTERRA All Models with FAS II (40,000 lb) Rear Air Suspension	
R	01-07	ACTERRA 5500 All Models with FAS II (40,000 lb) Rear Air Suspension	
R	01-07	ACTERRA 6500 All Models with FAS II (40,000 lb) Rear Air Suspension	
R		THOMAS VARIOUS	
85734	D		401754 (4)
R	00-10	COUNTRY COACH AFFINITY All MotorHomes with Ridewell Rear Suspension	
R	00	CONCEPT All MotorHomes with Ridewell Rear Suspension	
R	00-04	MAGNA All MotorHomes with Ridewell Rear Suspension	
R	05-10	MAGNA 630 All MotorHomes with Ridewell Rear Suspension	
85736	D		401754 (4)
F		THOMAS VARIOUS	
85900	B		145054 (2)
F	06	COACHMEN CROSS COUNTRY	
F	03-05	CROSS COUNTRY ELITE	
F	03-05	CROSS COUNTRY SE	
F	02-06	FLEETWOOD BOUNDER All Models with Freightliner XC Chassis with ZF - IFS Front Suspension and 23,000 lb GVW or Greater	
F	02-06	DISCOVERY All Models with Freightliner XC Chassis with ZF - IFS Front Suspension and 23,000 lb GVW or Greater	
F	03-06	EXCURSION All Models with Freightliner XC Chassis with ZF - IFS Front Suspension and 23,000 lb GVW or Greater	
F	02-06	EXPEDITION All Models with Freightliner XC Chassis with ZF - IFS Front Suspension and 23,000 lb GVW or Greater	
F	04-06	PROVIDENCE All Models with Freightliner XC Chassis with ZF - IFS Front Suspension and 23,000 lb GVW or Greater	
F	02-04	FOREST RIVER REFLECTION	
F	02-06	TSUNAMI	
F	03-07	FREIGHTLINER VC CHASSIS	
F		XC CHASSIS	
F	03-07	XC CHASSIS	
F	03-06	GULF STREAM ATRIUM	
F	02-06	FRIENDSHIP	
F	02	INDEPENDENCE All Models with Freightliner XC Chassis with ZF - IFS Front Suspension and 23,000 lb GVW or Greater	
F	02-06	SCENIC CRUISER	
F	02-04	YELLOWSTONE	
F	02-06	ITASCA CLASS A MOTORHOMES	
R	93-05	KENWORTH K300 All All with Air Glide 200 with 40,000 lb Suspension with 8 air bags, 4 units required T300	
R		KING OF THE ROAD CLASS A MOTORHOMES	
F	04-06	MANDALAY COACH CLASS A MOTORHOMES	
F	02-06	NEWMAR CLASS A MOTORHOMES	
F	02-06	THOR MOTOR COACH CLASS A MOTORHOMES	
85902	D		145054 (2)
R	93-05	KENWORTH K300 All All with Air Glide 200 with 46,000 lb Suspension with 8 air bags, 4 units required	
R	95-08	T300 All All with Air Glide 200 with 46,000 lb Suspension with 8 air bags, 4 units required	
85909	C		
R		NEWMAR CLASS A MOTORHOMES	
F	97-00	SPARTAN MOTORS HIGHLANDER All With I Beam Front Suspension	
F	95-96	K2	
F	97-00	K2 All With I Beam Front Suspension	
F	91-92	MOTORHOME All MC 2000 With I Beam Front Suspension	

Numerical listing

Shock	POP	Alternative No.	MTG Acc. Supplied
Pos.	Year	Application	
85909		C (cont)	
F	95-00	MOUNTAIN MASTER All With I Beam Front Suspension	
F	93-95	MOUNTAIN MASTER All MC 2000 With I Beam Front Suspension	
85910		D	
R		FREIGHTLINER VARIOUS	
F		PETERBILT 330	
F	00-12	SPARTAN MOTORS CLASS A MOTORHOMES	
85918		A	
F	02-04	DYNAMAX CORP GRAND SPORT All Models with 12000 lb Taperleaf Front Suspension	
F	07-08	GRAND SPORT GT TOY HAULER All 410TH & 450TH Models with 12000 lb Taperleaf Front Suspension	
F	07-08	GRAND SPORT ULTRA All Models with 14,000 lb Taperleaf Front Suspension	
F	05-23	FREIGHTLINER B2 All Models with 12000 lb Taperleaf Front Suspension MC CHASSIS	
85919		B	
R		FREIGHTLINER MB CHASSIS	
F	99-23	MT55 All MT55 Chassis with O.E.M. Number	
R		WORKHORSE VARIOUS	
85920		C	
F	05-07	DYNAMAX CORP DYNAQUEST All Models with 10000 to 12000 lb. Taper-leaf Spring Suspension	
F	07-08	GRAND SPORT GT TOY HAULER All 390TH Models with 12000 lb Taperleaf Front Suspension	
F	03-07	GRAND SPORT M2 All Models with 10000 to 12000 lb. Taper-leaf Spring Suspension	
F	02-08	FEDERAL COACH VARIOUS	
F	02-08	FREIGHTLINER M2 106 All Models with 10000 to 12000 lb. Taper-leaf Spring Suspension	
F	02-08	M2 106 All Models with 6000 to 9000 lb Front axle	
F	01-09	STERLING TRUCK ACTERRA	
85921		D 145054 (1)	
R	05-21	FREIGHTLINER M2 All Models with Rear 60" Spring ,18000 lb - 23000 lb	
R	02-10	M2 100 All Models with Rear 60" Spring ,18000 lb - 23000 lb	
R	02-23	M2 106 All Models with Rear 60" Spring ,18000 lb - 23000 lb	
85923		C	
R	08-09	INTERNATIONAL 4300 All Models with International 40,000 lb Rear Air Suspension	
R	08-09	4400 All Models with International 40,000 lb Rear Air Suspension	
R		DURASTAR - 4300, 4400 SERIES	
R	10-11	DURASTAR - 4300, 4400 SERIES	
R	19	MV SERIES	
85927		D	
R	14	FORD F-650	
R	15	F-650 All Models with International Air Suspension (4x2)	
R	04-13	F-650 All Models with International Air Suspension (4x2)	
R	15	F-750 All Models with International Air Suspension (4x2)	
R	04-13	F-750 All Models with International Air Suspension (4x2)	
R		INTERNATIONAL DURASTAR - 4300, 4400 SERIES	
85928		C	
F	14	FORD F-650	
F	15	F-650 All Models with 12,000 & 13,200 lb Front Springs	
F	00-13	F-650 All Models with 12,000 & 13,200 lb Front Springs	
F	15	F-750 All Models with 12,000 & 13,200 lb Front Springs	
F	00-13	F-750 All Models with 12,000 & 13,200 lb Front Springs	
F	00-15	GLAVAL BUS CO. CONCORDE II - SERIES	

85000 Series, 89000 Series

Shock	POP	Alternative No.	MTG Acc. Supplied
Pos.	Year	Application	
85928		C (cont)	
F	16-20	INTERNATIONAL DURASTAR All Models with 11,000 lb to 14,000 lb Front axle	
F	16-20	DURASTAR - 4300, 4400 SERIES	
F	23	EMV607	
F	19-23	HV607 All Models with 11,000 lb to 14,000 lb Taper-leaf Springs	
F	19-22	MV SERIES	
F	19-23	PIERCE MFG. INC. VARIOUS	
F	00-15	STARCRAFT BUS CO. ALLSTAR XL & XLT - SERIES	
85932		C	
F	03-10	STERLING TRUCK ACTERRA All Models with Hendrickson Front Airtek	
F	01-07	ACTERRA 5500 All Models with Hendrickson Front Airtek	
F	01-07	ACTERRA 6500 All Models with Hendrickson Front Airtek	
85936		B 145089-200 (1)	
R	11-16	KENWORTH T700 All Models with Air Glide 400 (AG400) Rear Air Suspension	
85956		C	
R	05-21	FREIGHTLINER M2 All Models with Freightliner TufTrac Rear Air Suspension	
R	02-10	M2 100 All Models with Freightliner TufTrac Rear Air Suspension	
R	02-24	M2 106 All Models with Freightliner TufTrac Rear Air Suspension	
R	03-10	STERLING TRUCK ACTERRA All All Models with Freightliner TufTrac Rear Air Suspension	
85957		C	
F	02-15	INTERNATIONAL 4300 All Models with 12,000 lb Front axle	
F	02-15	4400 All Models with 12,000 lb Front axle	
F	15	DURASTAR All Models with 12,000 lb Front axle	
F	13	DURASTAR All Models with 12,000 lb Front axle	
F	10-15	DURASTAR - 4300, 4400 SERIES	
F	19-20	HV607 All Models with 16,000 lb to 23,000 lb Parabolic Taperleaf Springs	
F	19-21	PIERCE MFG. INC. VARIOUS	
85958		A	
F	09-22	DYNAMAX CORP DYNAQUEST XL All Models with 12000 lb to 20000 Front Axle	
F	09-14	GRAND SPORT GT All Models with 14,600 lb Taperleaf Front Suspension	
F	09-13	GRAND SPORT GT TOY HAULER All 410TH & 450TH Models with 12000 lb Taperleaf Front Suspension	
F	09-14	GRAND SPORT ULTRA All Models with 14,000 lb Taperleaf Front Suspension	
F	09-24	PIERCE MFG. INC. VARIOUS	
85959		B	
F	13-22	DYNAMAX CORP DX3 All Models with 8000 to 16000 lb Front Axle and Taperleaf Spring	
F	09-14	DYNAQUEST ST All Models with 8000 to 16000 lb Front Axle and Taperleaf Spring	
F	21-22	EUROPA All Models with 8000 to 16000 lb Front Axle and Taperleaf Spring	
F	19-21	FORCE HD	
F	22	FORCE HD All Models with 8000 to 16000 lb Front Axle and Taperleaf Spring	
F	15-18	FORCE HD All Models with 8000 to 16000 lb Front Axle and Taperleaf Spring	
F	09-13	GRAND SPORT GT TOY HAULER All 390TH Models with 12000 lb Taperleaf Front Suspension	
F	09-19	FEDERAL COACH VARIOUS	
F		FREIGHTLINER M2	
F	09-24	M2 106 All Models with 8000 to 16000 lb Front Axle and Taperleaf Spring	
F		MC CHASSIS	
R		MC CHASSIS	

Numerical listing

Shock	POP	Alternative No.	MTG Acc. Supplied
Pos.	Year	Application	
85959		B (cont)	
F	09-24	PIERCE MFG. INC. VARIOUS	
F		SPARTAN MOTORS VARIOUS	
F		XOS ADDITIONAL O.E.M. INTERCHANGES	
85962		D	
R		SPARTAN MOTORS RV MODELS	
85976		C	
R	14	FORD F-650	
R	15	F-650 All Models with Hendrickson HAS - 230 Rear Air Suspension	
R	04-13	F-650 All Models with Hendrickson HAS - 230 Rear Air Suspension	
R	15	F-750 All Models with Hendrickson HAS - 230 Rear Air Suspension	
R	04-13	F-750 All Models with Hendrickson HAS - 230 Rear Air Suspension	
R	02-20	INTERNATIONAL 4300 All Models with Hendrickson HAS - 230 or 460 Rear Air Suspension	
R	02-20	4400 All Models with Hendrickson HAS - 230 or 460 Rear Air Suspension	
R	15-20	DURASTAR All Models with Hendrickson HAS - 230 or 460 Rear Air Suspension	
R	13	DURASTAR All Models with Hendrickson HAS - 230 or 460 Rear Air Suspension	
R	19-22	MV607 All Models with Hendrickson HAS - 230 or 460 Rear Air Suspension	
R	19-22	PIERCE MFG. INC. VARIOUS	
85978		C	
R	21-24	FORD F-650 All Models with Hendrickson HAS - 400/460 Rear Air Suspension	
R	15-19	F-650 All Models with Hendrickson HAS - 400/460 Rear Air Suspension	
R	21-24	F-750 All Models with Hendrickson HAS - 400/460 Rear Air Suspension	
R	15-19	F-750 All Models with Hendrickson HAS - 400/460 Rear Air Suspension	
85985		D 145089-200 (1)	
R	11-16	KENWORTH T700 All Models with Air Glide 230 (AG230) Rear Air Suspension	
85988		D 145099 (1)	
R	14-21	PETERBILT 330 All Models with Air Trac Suspension (40,000 lb)	
R	22-24	536 All Models with Air Trac Suspension (40,000 lb)	
85989		B	
F	15-22	KENWORTH T270 All Models with 10,000 lb to 14,600 lb Taperleaf Springs and Set Back Front Axles	
F	15-22	T270 All Models with 16,000 lb to 20,000 lb Taperleaf Springs and Set Back Front Axles	
F	24	T280 All Models with 10,000 lb to 12,000 lb Mono-leaf front springs	
F	16-22	PETERBILT 330 All Models with 10,000 lb to 14,600 lb Taperleaf Springs and Set Back Front Axles	
F	22-24	536 All Models with 10,000 lb to 14,600 lb Taperleaf Springs and Set Back Front Axles	
85995		D	
F	19-21	INTERNATIONAL HV607 All Models with 18,000 to 20,000 lb (Set Forward) Front Axle	
F	19-21	PIERCE MFG. INC. VARIOUS	
89000 Series			
89405		D	
R	00-03	FORD F-650 All Models with Hendrickson HAS - 190 Rear Air Suspension	
R	00-03	F-750 All Models with Hendrickson HAS - 190 Rear Air Suspension	
R	03-18	IC CORPORATION RE SCHOOL BUS All RE Model School Buses (Low Profile)	
R	13-24	KENWORTH K270 All Models with Hendrickson HAS - 210L or HAS - 230L Rear Air Suspension	
R	93-05	K300 All Models with Hendrickson Rear Air Suspension	

Numerical listing

Shock	POP	Alternative No.	MTG Acc. Supplied
Pos.	Year	Application	
89405	D (cont)		
R	08-22	T270	All Models with Hendrickson HAS - 210L or HAS - 230L Rear Air Suspension
R		T300	
R	95-08	T300	All Models with Hendrickson HAS - 210L or HAS - 230L Rear Air Suspension
R	13-24	PETERBILT 220	All Models with Hendrickson HAS - 210L or HAS - 230L Rear Air Suspension
R	10	220	All Models with Hendrickson HAS - 210L or HAS - 230L Rear Air Suspension
R	07	220	All Models with Hendrickson HAS - 210L or HAS - 230L Rear Air Suspension
R		SPARTAN MOTORS VARIOUS XOS ADDITIONAL O.E.M. INTERCHANGES	
89406	D		
R	97-09	CHEVROLET C6500 KODIAK	All Models with Hendrickson Air Suspension (Stamping number 47902-13)
R	97-09	C7500 KODIAK	All Models with Hendrickson Air Suspension (Stamping number 47902-13)
R	99	T6500	All Models with Hendrickson Air Suspension (Stamping number 47902-13)
R	09	COACHMEN AURORA	
R	07	AURORA	
R	08	AURORA	All MotorHomes with Ford F53 Chassis with 16,000 lb GVW to 22,000 lb GVW
R	04-06	AURORA	All MotorHomes with Ford F53 Chassis with 16,000 lb GVW to 22,000 lb GVW
R	21-24	ENCORE	All MotorHomes with Ford F53 Chassis with 16,000 lb GVW to 22,000 lb GVW
R	11-16	ENCOUNTER	All MotorHomes with Ford F53 Chassis with 16,000 lb GVW to 22,000 lb GVW
R	99-07	MIRADA	
R	08-24	MIRADA	All MotorHomes with Ford F53 Chassis with 16,000 lb GVW to 22,000 lb GVW
R	04-12	PURSUIT	
R	13-24	PURSUIT	All MotorHomes with Ford F53 Chassis with 16,000 lb GVW to 22,000 lb GVW
R	00-14	DAMON CHALLENGER	All MotorHomes with Ford F53 Chassis with 16,000 lb GVW to 22,000 lb GVW
R	12-13	DAYBREAK	
R	99	DAYBREAK	
R	00-11	DAYBREAK	All MotorHomes with Ford F53 Chassis with 16,000 lb GVW to 22,000 lb GVW
R	99	INTRUDER	
R	00-07	INTRUDER	All MotorHomes with Ford F53 Chassis with 16,000 lb GVW to 22,000 lb GVW
R	12-14	OUTLAW	
R	07-11	OUTLAW	All MotorHomes with Ford F53 Chassis with 16,000 lb GVW to 22,000 lb GVW
R	19-24	ENTEGR COACH EMBLEM	All MotorHomes with Ford F53 Chassis with 16,000 lb GVW to 22,000 lb GVW
R	19-24	VISION	All MotorHomes with Ford F53 Chassis with 16,000 lb GVW to 22,000 lb GVW
R	19-20	FLEETWOOD AXON	
R	18	AXON	All MotorHomes with Ford F53 Chassis with 16,000 lb GVW to 22,000 lb GVW
R	00-24	BOUNDER	All MotorHomes with Ford F53 Chassis with 16,000 lb GVW to 22,000 lb GVW
R	15-24	FLAIR	All MotorHomes with Ford F53 Chassis with 16,000 lb GVW to 22,000 lb GVW
R	00-07	FLAIR	All MotorHomes with Ford F53 Chassis with 16,000 lb GVW to 22,000 lb GVW
R	23-24	FLEX	All MotorHomes with Ford F53 Chassis with 16,000 lb GVW to 22,000 lb GVW

89000 Series

Shock	POP	Alternative No.	MTG Acc. Supplied
Pos.	Year	Application	
89406	D (cont)		
R	20-24	FORTIS	All MotorHomes with Ford F53 Chassis with 16,000 lb GVW to 22,000 lb GVW
R	00-23	SOUTHWIND	All MotorHomes with Ford F53 Chassis with 16,000 lb GVW to 22,000 lb GVW
R	11-18	STORM	All MotorHomes with Ford F53 Chassis with 16,000 lb GVW to 22,000 lb GVW
R	01-07	STORM	All MotorHomes with Ford F53 Chassis with 16,000 lb GVW to 22,000 lb GVW
R	06-23	FORD F-53	
R	99-04	F-53	
R	08-23	F-53 MOTORHOME CHASSIS	All Motorhome Chassis with 16,000 lb GVW to 18,000 lb GVW
R	06-23	F-53 MOTORHOME CHASSIS	All Motorhome Chassis with 20,500 lb GVW to 22,000 lb GVW
R	99-04	F-53 MOTORHOME CHASSIS	All Motorhome Chassis with 20,500 lb GVW to 22,000 lb GVW
R	13-23	FOREST RIVER FR3	All MotorHomes with Ford F53 Chassis with 16,000 lb GVW to 22,000 lb GVW
R	08-17	GEORGETOWN	All MotorHomes with Ford F53 Chassis with 16,000 lb GVW to 22,000 lb GVW
R	16-23	GEORGETOWN GT3	All MotorHomes with Ford F53 Chassis with 16,000 lb GVW to 22,000 lb GVW
R	17-23	GEORGETOWN GT5	All MotorHomes with Ford F53 Chassis with 16,000 lb GVW to 22,000 lb GVW
R	20-23	GEORGETOWN GT7	All MotorHomes with Ford F53 Chassis with 16,000 lb GVW to 22,000 lb GVW
R	99-09	GEORGIE BOY MANUFACTURING CLASS A MOTORHOMES	
R	99	GMC T5500	
R	99	T6500	All Models with Hendrickson Air Suspension (Stamping number 47902-13)
R	11-15	HOLIDAY RAMBLER ADMIRAL	
R	02-06	ADMIRAL	
R	16-24	ADMIRAL	All MotorHomes with Ford F53 Chassis with 16,000 lb GVW to 22,000 lb GVW
R	07-10	ADMIRAL	All MotorHomes with Ford F53 Chassis with 16,000 lb GVW to 22,000 lb GVW
R	00-01	ADMIRAL	All MotorHomes with Ford F53 Chassis with 16,000 lb GVW to 22,000 lb GVW
R	02-06	ADMIRAL SE	All MotorHomes with Ford F53 Chassis with 16,000 lb GVW to 22,000 lb GVW
R	07	ADMIRAL SVE	All MotorHomes with Ford F53 Chassis with 16,000 lb GVW to 22,000 lb GVW
R	16-18	ADMIRAL XE	All MotorHomes with Ford F53 Chassis with 16,000 lb GVW to 22,000 lb GVW
R	15	ENDEAVOR	
R	16-24	ENDEAVOR	All MotorHomes with Ford F53 Chassis with 16,000 lb GVW to 22,000 lb GVW
R	00-14	ENDEAVOR	All MotorHomes with Ford F53 Chassis with 16,000 lb GVW to 22,000 lb GVW
R	10	VACATIONER	
R	08	VACATIONER	
R	11-24	VACATIONER	All MotorHomes with Ford F53 Chassis with 16,000 lb GVW to 22,000 lb GVW
R	09	VACATIONER	All MotorHomes with Ford F53 Chassis with 16,000 lb GVW to 22,000 lb GVW
R	00-07	VACATIONER	All MotorHomes with Ford F53 Chassis with 16,000 lb GVW to 22,000 lb GVW
R	99-15	ISUZU FVR	
R	16-24	ITASCA CLASS A MOTORHOMES	
R	16-24	JAYCO ALANTE	All MotorHomes with Ford F53 Chassis with 16,000 lb GVW to 22,000 lb GVW
R	14-20	CLASS A MOTORHOMES	

Numerical listing

Shock	POP	Alternative No.	MTG Acc. Supplied
Pos.	Year	Application	
89406	D (cont)		
R	14-24	PRECEPT	All MotorHomes with Ford F53 Chassis with 16,000 lb GVW to 22,000 lb GVW
R	12-13	MONACO COACH LA PALMA	All MotorHomes with Ford F53 Chassis with 16,000 lb GVW to 22,000 lb GVW
R	09	LA PALMA	All MotorHomes with Ford F53 Chassis with 16,000 lb GVW to 22,000 lb GVW
R	02-06	LA PALMA	All MotorHomes with Ford F53 Chassis with 16,000 lb GVW to 22,000 lb GVW
R	00	LA PALMA	All MotorHomes with Ford F53 Chassis with 16,000 lb GVW to 22,000 lb GVW
R	06-14	MONARCH	All MotorHomes with Ford F53 Chassis with 16,000 lb GVW to 22,000 lb GVW
R	01-02	MONARCH	All MotorHomes with Ford F53 Chassis with 16,000 lb GVW to 22,000 lb GVW
R	99-08	NATIONAL RV CLASS A MOTORHOMES	
R	13-20	NEWMAR CLASS A MOTORHOMES	
R	16-20	NEXUS CLASS A MOTORHOMES	
R	17-20	MAYBACH	All MotorHomes with Ford F53 Chassis with 16,000 lb GVW to 22,000 lb GVW
R	11-24	THOR MOTOR COACH A.C.E	All MotorHomes with Ford F53 Chassis with 16,000 lb GVW to 22,000 lb GVW
R	05-08	CHALLENGER	
R	09-24	CHALLENGER	All MotorHomes with Ford F53 Chassis with 16,000 lb GVW to 22,000 lb GVW
R	04-10	HURRICANE	
R	11-24	HURRICANE	All MotorHomes with Ford F53 Chassis with 16,000 lb GVW to 22,000 lb GVW
R	23-24	INDIGO	All MotorHomes with Ford F53 Chassis with 16,000 lb GVW to 22,000 lb GVW
R	23-24	LUMINATE	All MotorHomes with Ford F53 Chassis with 16,000 lb GVW to 22,000 lb GVW
R	14-24	MIRAMAR	All MotorHomes with Ford F53 Chassis with 16,000 lb GVW to 22,000 lb GVW
R	07-10	OUTLAW	
R	11-23	OUTLAW	All MotorHomes with Ford F53 Chassis with 16,000 lb GVW to 22,000 lb GVW
R	23-24	RESONATE	All MotorHomes with Ford F53 Chassis with 16,000 lb GVW to 22,000 lb GVW
R	06-10	WINDSPORT	
R	11-24	WINDSPORT	All MotorHomes with Ford F53 Chassis with 16,000 lb GVW to 22,000 lb GVW
R	19-23	WINNEBAGO ADVENTURER	All Motorhomes with Ford F-53 Chassis with 16,000 lb GVW to 22,000 lb GVW
R	06-17	ADVENTURER	All Motorhomes with Ford F-53 Chassis with 16,000 lb GVW to 22,000 lb GVW
R	99-04	ADVENTURER	All MotorHomes with Ford F-53 Chassis with 16,000 lb GVW to 22,000 lb GVW
R	18-20	INTENET	All Motorhome Chassis with 16,000 lb GVW to 18,000 lb GVW
R	18-20	INTENET	All Motorhome Chassis with 20,500 lb GVW to 22,000 lb GVW
R	11-17	SIGHTSEER	All Motorhome Chassis with 16,000 lb GVW to 18,000 lb GVW
R	11-17	SIGHTSEER	All Motorhome Chassis with 20,500 lb GVW to 22,000 lb GVW
R	08-09	SIGHTSEER	All Motorhome Chassis with 16,000 lb GVW to 18,000 lb GVW
R	06-09	SIGHTSEER	All Motorhome Chassis with 20,500 lb GVW to 22,000 lb GVW
R	02-04	SIGHTSEER	All Motorhome Chassis with 20,500 lb GVW to 22,000 lb GVW

Numerical listing

Shock	POP	Alternative No.	MTG Acc. Supplied
Pos.	Year	Application	
89406	D	(cont)	
R	16-17	SUNOVA All Motorhome Chassis with 16,000 lb GVW to 18,000 lb GVW	
R	16-17	SUNOVA All Motorhome Chassis with 20,500 lb GVW to 22,000 lb GVW	
R	06-07	SUNOVA All Motorhome Chassis with 20,500 lb GVW to 22,000 lb GVW	
R	02-04	SUNOVA All Motorhome Chassis with 20,500 lb GVW to 22,000 lb GVW	
R	16-22	SUNSTAR All Motorhome Chassis with 16,000 lb GVW to 18,000 lb GVW	
R	16-22	SUNSTAR All Motorhome Chassis with 20,500 lb GVW to 22,000 lb GVW	
R	02-04	SUNSTAR All Motorhome Chassis with 20,500 lb GVW to 22,000 lb GVW	
R	16-18	SUNSTAR LX All Motorhome Chassis with 16,000 lb GVW to 18,000 lb GVW	
R	16-18	SUNSTAR LX All Motorhome Chassis with 20,500 lb GVW to 22,000 lb GVW	
R	11-22	VISTA All Motorhome Chassis with 16,000 lb GVW to 18,000 lb GVW	
R	11-22	VISTA All Motorhome Chassis with 20,500 lb GVW to 22,000 lb GVW	
R	08-09	VISTA All Motorhome Chassis with 16,000 lb GVW to 18,000 lb GVW	
R	07-09	VISTA All Motorhome Chassis with 20,500 lb GVW to 22,000 lb GVW	
R	02-04	VISTA All Motorhome Chassis with 20,500 lb GVW to 22,000 lb GVW	
R	16-18	VISTA LX All Motorhome Chassis with 16,000 lb GVW to 18,000 lb GVW	
R	16-18	VISTA LX All Motorhome Chassis with 20,500 lb GVW to 22,000 lb GVW	
89407	D		
F	73-80	CHEVROLET 5, 50, 5000 & 5500 SERIES	
F	73-75	6, 60, 6000 & 6500 SERIES	
F		COACHMEN CLASS A MOTORHOMES	
R	00	COUNTRY COACH AFFINITY All MotorHomes with Neway IFS	
R	00	CONCEPT All MotorHomes with Neway IFS	
R	00-04	MAGNA All MotorHomes with Neway IFS	
R	05-10	MAGNA 630 All MotorHomes with Neway IFS	
F		FOREST RIVER CLASS A MOTORHOMES	
F		GEORGIE BOY MANUFACTURING CLASS A MOTORHOMES	
F	73-80	GMC 5000 SERIES	
F	73-75	6000 SERIES	
F	73-75	6500 SERIES	
F		ITASCA CLASS A MOTORHOMES	
F		MONACO COACH CLASS A MOTORHOMES	
F		WORKHORSE VARIOUS	
89409	D	140149 (1)	
F	80-86	FORD C600 All Models with 4040, 5040 lb Springs and 7000, 9000, 12000 lb Axles	
F	80-86	C700 All Models with 4040, 5040 lb Springs and 7000, 9000, 12000 lb Axles	
F	80-86	C7000 All Models with 4040, 5040 lb Springs and 7000, 9000, 12000 lb Axles	
F	80-85	LN600 All Models with 4400 lb Spring and 7000, 9000 lb Axles	
F	93-05	KENWORTH K300 All Models with Multiple Leaf Springs on Front Axle (3/4" Mounting bolts)	
F		T300	
89410	C	401754 (4)	
R	94-97	FORD F-800 All Models with 21000 Taperleaf Springs	
F	93-05	KENWORTH K300 All Models with Taper Leaf Springs on Front Axle (1" Mounting bolts)	
F		T300	

89000 Series

Shock	POP	Alternative No.	MTG Acc. Supplied
Pos.	Year	Application	
89413	D	145080 (2)	
R	85	ISUZU ADDITIONAL APPLICATIONS	
R	86-95	NPR All	
F	13	PETERBILT 220 All Models with 12,000 lb Front Axle	
F	10	220 All Models with 12,000 lb Front Axle	
F	07	220 All Models with 12,000 lb Front Axle	
F	08-19	325 All Models with 12000 lb Set Back Front Axle	
F	07-16	330 All Models with 12000 lb Set Back Front Axle	
F	95-05	330 All Models with 12000 lb Set Back Front Axle	
89414	D		
F	09	COACHMEN AURORA	
F	07	AURORA	
F	08	AURORA All MotorHomes with Ford F53 Chassis with 16,000 lb GVW to 22,000 lb GVW	
F	04-06	AURORA All MotorHomes with Ford F53 Chassis with 16,000 lb GVW to 22,000 lb GVW	
F	21-24	ENCORE All MotorHomes with Ford F53 Chassis with 16,000 lb GVW to 22,000 lb GVW	
F	11-16	ENCOUNTER All MotorHomes with Ford F53 Chassis with 16,000 lb GVW to 22,000 lb GVW	
F	99-07	MIRADA	
F	08-24	MIRADA All MotorHomes with Ford F53 Chassis with 16,000 lb GVW to 22,000 lb GVW	
F	04-12	PURSUIT	
F	13-24	PURSUIT All MotorHomes with Ford F53 Chassis with 16,000 lb GVW to 22,000 lb GVW	
F	00-14	DAMON CHALLENGER All MotorHomes with Ford F53 Chassis with 16,000 lb GVW to 22,000 lb GVW	
F	12-13	DAYBREAK	
F	99	DAYBREAK	
F	00-11	DAYBREAK All MotorHomes with Ford F53 Chassis with 16,000 lb GVW to 22,000 lb GVW	
F	99	INTRUDER	
F	00-07	INTRUDER All MotorHomes with Ford F53 Chassis with 16,000 lb GVW to 22,000 lb GVW	
F	12-14	OUTLAW	
F	07-11	OUTLAW All MotorHomes with Ford F53 Chassis with 16,000 lb GVW to 22,000 lb GVW	
F	19-24	ENTEGR COACH EMBLEM All MotorHomes with Ford F53 Chassis with 16,000 lb GVW to 22,000 lb GVW	
F	19-24	VISION All MotorHomes with Ford F53 Chassis with 16,000 lb GVW to 22,000 lb GVW	
F	19-20	FLEETWOOD AXON	
F	18	AXON All MotorHomes with Ford F53 Chassis with 16,000 lb GVW to 22,000 lb GVW	
F	00-24	BOUNDER All MotorHomes with Ford F53 Chassis with 16,000 lb GVW to 22,000 lb GVW	
F	15-24	FLAIR All MotorHomes with Ford F53 Chassis with 16,000 lb GVW to 22,000 lb GVW	
F	00-07	FLAIR All MotorHomes with Ford F53 Chassis with 16,000 lb GVW to 22,000 lb GVW	
F	23-24	FLEX All MotorHomes with Ford F53 Chassis with 16,000 lb GVW to 22,000 lb GVW	
F	20-24	FORTIS All MotorHomes with Ford F53 Chassis with 16,000 lb GVW to 22,000 lb GVW	
F	00-23	SOUTHWIND All MotorHomes with Ford F53 Chassis with 16,000 lb GVW to 22,000 lb GVW	
F	11-18	STORM All MotorHomes with Ford F53 Chassis with 16,000 lb GVW to 22,000 lb GVW	
F	01-07	STORM All MotorHomes with Ford F53 Chassis with 16,000 lb GVW to 22,000 lb GVW	
F	06-23	FORD F-53	
F	99-04	F-53	
F	88-97	F-53	

Numerical listing

Shock	POP	Alternative No.	MTG Acc. Supplied
Pos.	Year	Application	
89414	D	(cont)	
F	05	F-53 MOTORHOME CHASSIS	
F	98	F-53 MOTORHOME CHASSIS	
F	06-23	F-53 MOTORHOME CHASSIS All F53 Chassis with 16,000 lb GVW to 22,000 lb GVW	
F	11-20	F-53 MOTORHOME CHASSIS All F53 Stripped Chassis Commercial Stripped Chassis, 19,500 lb to 22,000 lb GVW	
F	99-04	F-53 MOTORHOME CHASSIS All F53 Chassis with 16,000 lb GVW to 22,000 lb GVW	
F	88-97	F-53 MOTORHOME CHASSIS All F53 Chassis with 16,000 lb GVW to 22,000 lb GVW	
F	11-21	F-59 COMMERCIAL STRIPPED CHASSIS All F59 Commercial Chassis with 16,000 lb to 22,000 GVW	
F	88-97	F-59 COMMERCIAL STRIPPED CHASSIS All F59 Commercial Chassis with 16,000 lb to 22,000 GVW	
F	13-23	FOREST RIVER FR3 All MotorHomes with Ford F53 Chassis with 16,000 lb GVW to 22,000 lb GVW	
F	08-17	GEORGETOWN All MotorHomes with Ford F53 Chassis with 16,000 lb GVW to 22,000 lb GVW	
F	16-23	GEORGETOWN GT3 All MotorHomes with Ford F53 Chassis with 16,000 lb GVW to 22,000 lb GVW	
F	17-23	GEORGETOWN GT5 All MotorHomes with Ford F53 Chassis with 16,000 lb GVW to 22,000 lb GVW	
F	20-23	GEORGETOWN GT7 All MotorHomes with Ford F53 Chassis with 16,000 lb GVW to 22,000 lb GVW	
F	99-09	GEORGIE BOY MANUFACTURING CLASS A MOTORHOMES	
F	11-15	HOLIDAY RAMBLER ADMIRAL	
F	02-06	ADMIRAL	
F	16-24	ADMIRAL All MotorHomes with Ford F53 Chassis with 16,000 lb GVW to 22,000 lb GVW	
F	07-10	ADMIRAL All MotorHomes with Ford F53 Chassis with 16,000 lb GVW to 22,000 lb GVW	
F	00-01	ADMIRAL All MotorHomes with Ford F53 Chassis with 16,000 lb GVW to 22,000 lb GVW	
F	02-06	ADMIRAL SE All MotorHomes with Ford F53 Chassis with 16,000 lb GVW to 22,000 lb GVW	
F	07	ADMIRAL SVE All MotorHomes with Ford F53 Chassis with 16,000 lb GVW to 22,000 lb GVW	
F	16-18	ADMIRAL XE All MotorHomes with Ford F53 Chassis with 16,000 lb GVW to 22,000 lb GVW	
F	15	ENDEAVOR	
F	16-24	ENDEAVOR All MotorHomes with Ford F53 Chassis with 16,000 lb GVW to 22,000 lb GVW	
F	00-14	ENDEAVOR All MotorHomes with Ford F53 Chassis with 16,000 lb GVW to 22,000 lb GVW	
F	10	VACATIONER	
F	08	VACATIONER	
F	11-24	VACATIONER All MotorHomes with Ford F53 Chassis with 16,000 lb GVW to 22,000 lb GVW	
F	09	VACATIONER All MotorHomes with Ford F53 Chassis with 16,000 lb GVW to 22,000 lb GVW	
F	00-07	VACATIONER All MotorHomes with Ford F53 Chassis with 16,000 lb GVW to 22,000 lb GVW	
F	99-15	ITASCA CLASS A MOTORHOMES	
F	16-24	JAYCO ALANTE All MotorHomes with Ford F53 Chassis with 16,000 lb GVW to 22,000 lb GVW	
F	14-20	CLASS A MOTORHOMES	
F	14-24	PRECEPT All MotorHomes with Ford F53 Chassis with 16,000 lb GVW to 22,000 lb GVW	
F	07-08	MONACO COACH LA PALMA	
F	01	LA PALMA	
F	90-99	LA PALMA	

Numerical listing

Shock	POP	Alternative No.	MTG Acc. Supplied
Pos.	Year	Application	
89414	D	(cont)	
F	12-13	LA PALMA	All MotorHomes with Ford F53 Chassis with 16,000 lb GVW to 22,000 lb GVW
F	09	LA PALMA	All MotorHomes with Ford F53 Chassis with 16,000 lb GVW to 22,000 lb GVW
F	02-06	LA PALMA	All MotorHomes with Ford F53 Chassis with 16,000 lb GVW to 22,000 lb GVW
F	00	LA PALMA	All MotorHomes with Ford F53 Chassis with 16,000 lb GVW to 22,000 lb GVW
F	03-05	MONARCH	
F	90-99	MONARCH	
F	06-14	MONARCH	All MotorHomes with Ford F53 Chassis with 16,000 lb GVW to 22,000 lb GVW
F	01-02	MONARCH	All MotorHomes with Ford F53 Chassis with 16,000 lb GVW to 22,000 lb GVW
F	99-08	NATIONAL RV CLASS A	
F	13-20	NEWMAR CLASS A	
F	16-20	NEXUS CLASS A	MOTORHOMES
F	17-20	MAYBACH	All MotorHomes with Ford F53 Chassis with 16,000 lb GVW to 22,000 lb GVW
R	13-22	PETERBILT 220	All Models with Reyco 102AR (Standard) Rear Air Suspension
R	10	220	All Models with Reyco 102AR (Standard) Rear Air Suspension
R	07	220	All Models with Reyco 102AR (Standard) Rear Air Suspension
R	07-21	330	All Models with Reyco 102AR (Standard) Rear Air Suspension
R	95-05	330	All Models with Reyco 102AR (Standard) Rear Air Suspension
R	91-92	SPARTAN MOTORS	
R		MOTORHOME	All Models with Tuthill 102 AR Air Suspension
R	93-95	MOUNTAIN MASTER	All Models with Tuthill 102 AR Air Suspension
F	11-24	THOR MOTOR COACH A.C.E	All MotorHomes with Ford F53 Chassis with 16,000 lb GVW to 22,000 lb GVW
F	05-08	CHALLENGER	
F	09-24	CHALLENGER	All MotorHomes with Ford F53 Chassis with 16,000 lb GVW to 22,000 lb GVW
F	04-10	HURRICANE	
F	11-24	HURRICANE	All MotorHomes with Ford F53 Chassis with 16,000 lb GVW to 22,000 lb GVW
F	23-24	INDIGO	All MotorHomes with Ford F53 Chassis with 16,000 lb GVW to 22,000 lb GVW
F	23-24	LUMINATE	All MotorHomes with Ford F53 Chassis with 16,000 lb GVW to 22,000 lb GVW
F	14-24	MIRAMAR	All MotorHomes with Ford F53 Chassis with 16,000 lb GVW to 22,000 lb GVW
F	07-10	OUTLAW	
F	11-23	OUTLAW	All MotorHomes with Ford F53 Chassis with 16,000 lb GVW to 22,000 lb GVW
F	23-24	RESONATE	All MotorHomes with Ford F53 Chassis with 16,000 lb GVW to 22,000 lb GVW
F	06-10	WINDSPORT	
F	11-24	WINDSPORT	All MotorHomes with Ford F53 Chassis with 16,000 lb GVW to 22,000 lb GVW
F	19-23	WINNEBAGO ADVENTURER	All MotorHomes with Ford F53 Chassis with 16,000 lb GVW to 22,000 lb GVW
F	92-17	ADVENTURER	All MotorHomes with Ford F53 Chassis with 16,000 lb GVW to 22,000 lb GVW
F	18-20	INTENET	All MotorHomes with Ford F53 Chassis with 16,000 lb GVW to 22,000 lb GVW
F	02-17	SIGHTSEER	All MotorHomes with Ford F53 Chassis with 16,000 lb GVW to 22,000 lb GVW
F	16-17	SUNOVA	All MotorHomes with Ford F53 Chassis with 16,000 lb GVW to 22,000 lb GVW

89000 Series

Shock	POP	Alternative No.	MTG Acc. Supplied
Pos.	Year	Application	
89414	D	(cont)	
F	02-07	SUNOVA	All MotorHomes with Ford F53 Chassis with 16,000 lb GVW to 22,000 lb GVW
F	16-22	SUNSTAR	All MotorHomes with Ford F53 Chassis with 16,000 lb GVW to 22,000 lb GVW
F	02-04	SUNSTAR	All MotorHomes with Ford F53 Chassis with 16,000 lb GVW to 22,000 lb GVW
F	16-18	SUNSTAR LX	All MotorHomes with Ford F53 Chassis with 16,000 lb GVW to 22,000 lb GVW
F	07-22	VISTA	All MotorHomes with Ford F53 Chassis with 16,000 lb GVW to 22,000 lb GVW
F	02-04	VISTA	All MotorHomes with Ford F53 Chassis with 16,000 lb GVW to 22,000 lb GVW
F	16-18	VISTA LX	All MotorHomes with Ford F53 Chassis with 16,000 lb GVW to 22,000 lb GVW
89420	D	401754 (4)	
R	86-97	FORD CF7000	All Models with 12000 lb or 13000 lb Axle
89423	D	141108 (1)	
R	93-05	KENWORTH K300	All All with Air Glide 100 Suspension with 8 air bags, 4 units required T300
89424	C	141247 (1)	
R	07-21	PETERBILT 330	All Models with Air Trac Suspension (46,000 lb)
R	95-05	330	All Models with Air Trac Suspension (46,000 lb)
89425	D	401754 (4)	
R	94	FORD B-700	All Models with with 15000, 17500, 19000 lb Taperleaf Springs
R	94-98	F-700	All Models with with 15000, 17500, 19000 lb Taperleaf Springs
R	94-98	F-800	All Models with with 15000, 17500, 19000 lb Taperleaf Springs
89427	C	145099 (1)	
R	95-02	PETERBILT 330	All Models with Peterbilt 40000 lb Low Air Leaf Suspension
89430	C		
F	60-70	CHEVROLET 4, 40, 4000 & 4500	SERIES
R	71-72	5, 50, 5000 & 5500	SERIES
F	63-70	5, 50, 5000 & 5500	SERIES
R	71-89	6, 60, 6000 & 6500	SERIES
F	73-80	6, 60, 6000 & 6500	SERIES
F	68-69	6, 60, 6000 & 6500	SERIES
R	19-23	ENTEGRA COACH EMBLEM	All MotorHomes with Ford F53 Chassis with 24,000 lb GVW to 26,000 lb GVW
R	20-23	VISION XL	All MotorHomes with Ford F53 Chassis with 24,000 lb GVW to 26,000 lb GVW
R	08-23	FLEETWOOD BOUNDER	All MotorHomes with Ford F53 Chassis with 24,000 lb GVW to 26,000 lb GVW
R	20-23	FORTIS	All MotorHomes with Ford F53 Chassis with 24,000 lb GVW to 26,000 lb GVW
R	08-23	SOUTHWIND	All MotorHomes with Ford F53 Chassis with 24,000 lb GVW to 26,000 lb GVW
R	08-23	FORD F-53	
R	08-23	F-53	MOTORHOME CHASSIS All MotorHomes with Ford F53 Chassis with 24,000 lb GVW to 26,000 lb GVW
R	20-23	FOREST RIVER GEORGETOWN	GT7 All MotorHomes with Ford F53 Chassis with 24,000 lb GVW to 26,000 lb GVW
F		FREIGHTLINER BUS CHASSIS	
R	02-23	M2 106	All Models with Reyco 79KB Rear Steel Spring Suspension
F		VARIOUS	
F	63-66	GMC 3500 & 4000	SERIES
F	72-80	4500	SERIES
R	66-72	4500	SERIES
F	63-68	5000	SERIES
F	63-89	5500	SERIES

Numerical listing

Shock	POP	Alternative No.	MTG Acc. Supplied
Pos.	Year	Application	
89430	C	(cont)	
R	66-72	5500	SERIES
F	79-80	6000	SERIES
F	63-68	6000	SERIES
F	66-80	6500	SERIES
R	66-80	6500	SERIES
F	05-10	HINO 145	All Models with O.E.M. Number
F	05-10	145	All Models with O.E.M. Number
F	05-10	185	All Models with O.E.M. Number
R	20-23	HOLIDAY RAMBLER INVICTA	All MotorHomes with Ford F53 Chassis with 24,000 lb GVW to 26,000 lb GVW
R	11-23	VACATIONER	All MotorHomes with Ford F53 Chassis with 24,000 lb GVW to 26,000 lb GVW
R	09	VACATIONER	All MotorHomes with Ford F53 Chassis with 24,000 lb GVW to 26,000 lb GVW
R	13-24	KENWORTH K270	All Models with Reyco 102 or 79KB Suspension (Drive Axle)
R	93-05	K300	All Models with Reyco 102 or 79KB Suspension (Drive Axle)
F	93-05	K300	All Models with Reyco 1209 or 1212 Suspension (Steer Axle)
R	08-22	T170	All Models with Reyco 79KB Rear Steel Spring Suspension
R	08-22	T270	All Models with Reyco 102 or 79KB Suspension (Drive Axle)
R	21-24	T280	All Models with Reyco 102 or 79KB Suspension (Drive Axle)
F		T300	
R	99-08	T300	All Models with Reyco 102 or 79KB Suspension (Drive Axle)
R	99-08	T300	All Models with Reyco 1209 or 1212 Suspension (Steer Axle)
R	08-15	PETERBILT 210	All Models with Reyco 102 or 79KB Suspension (Drive Axle)
R	13-24	220	All Models with Reyco 102 or 79KB Suspension (Drive Axle)
R	10	220	All Models with Reyco 102 or 79KB Suspension (Drive Axle)
R	07	220	All Models with Reyco 102 or 79KB Suspension (Drive Axle)
R	08-19	325	All Models with Reyco 102 or 79KB Suspension (Drive Axle)
R	07-22	330	All Models with Reyco 79KB Rear Steel Spring Suspension
R	95-05	330	All Models with Reyco 79KB Rear Steel Spring Suspension
R	11-24	THOR MOTOR COACH OUTLAW	All MotorHomes with Ford F53 Chassis with 24,000 lb GVW to 26,000 lb GVW
R	19-23	WINNEBAGO ADVENTURER	All MotorHomes with Ford F53 Chassis with 24,000 lb GVW to 26,000 lb GVW
R	08-17	ADVENTURER	All MotorHomes with Ford F53 Chassis with 24,000 lb GVW to 26,000 lb GVW
R	16-22	SUNSTAR	All MotorHomes with Ford F53 Chassis with 24,000 lb GVW to 26,000 lb GVW
R	08-22	VISTA	All MotorHomes with Ford F53 Chassis with 24,000 lb GVW to 26,000 lb GVW
89431	D		
F		FREIGHTLINER MB CHASSIS	
F	98-23	MT45	All Step Van Models with O.E.M. Number
F		MT55	
F		VARIOUS	
F		THOMAS VARIOUS	
89436	C		
R		THOMAS VARIOUS	
89440	D		
R	97-00	SPARTAN MOTORS HIGHLANDER	All With I Beam Front Suspension
R	91-96	K2	
R	97-00	K2	All With I Beam Front Suspension
R	97-00	K2	All With Independent Front Granning Suspension
R	97-00	MOUNTAIN MASTER	All With Independent Front Granning Suspension

Numerical listing

Shock	POP	Alternative No.	MTG Acc. Supplied
Pos.	Year	Application	
89440	D (cont)		
R	95-00	MOUNTAIN MASTER	All With I Beam Front Suspension
89443	C		
R	13-22	DYNAMAX CORP DX3	All Models with Airliner 21,000 lb Rear Air Suspension
R	05-07	DYNAQUEST	All Models with Airliner 18,000 lb Rear Air Suspension
R	09-14	DYNAQUEST ST	All Models with Airliner 18,000 lb Rear Air Suspension
R	09-22	DYNAQUEST XL	All Models with FAS II (40,000 lb) Rear Air Suspension
R	21-22	EUROPA	All Models with Airliner 21,000 lb Rear Air Suspension
R	22	FORCE HD	All Models with Airliner 21,000 lb Rear Air Suspension
R	15-18	FORCE HD	All Models with Airliner 21,000 lb Rear Air Suspension
R	02-04	GRAND SPORT	All Models 23,000 lb Airliner Rear Air Suspension
R	09-14	GRAND SPORT GT	All Models with Freightliner Airliner Rear Air Suspension
R	07-13	GRAND SPORT GT TOY HAULER	All Models 21K or 23K Airliner Rear Air Suspension
R	03-07	GRAND SPORT M2	All Models with Airliner 21,000 lb Rear Air Suspension
R	07-14	GRAND SPORT ULTRA	All Models 23,000 lb Airliner Rear Air Suspension
R	02-19	FEDERAL COACH VARIOUS	
R	05-23	FREIGHTLINER B2	All Models with FAS II (40,000 lb) Rear Air Suspension
R	05-07	FC70	
R	95-05	FL50	All Models with FAS II (40,000 lb) Rear Air Suspension
R	91-05	FL60	All Models with FAS II (40,000 lb) Rear Air Suspension
R	05-21	M2	All Models with FAS II (40,000 lb) Rear Air Suspension
R	02-10	M2 100	All Models with FAS II (40,000 lb) Rear Air Suspension
R	02-24	M2 106	All Models with FAS II (40,000 lb) Rear Air Suspension
R	03-10	STERLING TRUCK ACTERRA	All Models with FAS II (40,000 lb) Rear Air Suspension
R	01-07	ACTERRA 5500	All Models with FAS II (40,000 lb) Rear Air Suspension
R	01-07	ACTERRA 6500	All Models with FAS II (40,000 lb) Rear Air Suspension
R		THOMAS VARIOUS	
89447	D		141108 (1)
F	03-18	IC CORPORATION RE SCHOOL BUS	All RE Model School Buses with O.E.M. Number
F	86-88	MITSUBISHI FUSO FM	All Model with O.E.M. Number
89449	D		
F	02-04	DYNAMAX CORP GRAND SPORT	All Models with 12000 lb Taperleaf Front Suspension
F	07-08	GRAND SPORT GT TOY HAULER	All 410TH & 450TH Models with 12000 lb Taperleaf Front Suspension
F	07-08	GRAND SPORT ULTRA	All Models with 14,000 lb Taperleaf Front Suspension
F	05-23	FREIGHTLINER B2	All Models with 12000 lb Taperleaf Front Suspension
F		MC CHASSIS	
89451	C		
R	11-16	KENWORTH T700	All Models with Air Glide 380 (AG380) Rear Air Suspension
89453	D		
F	03-10	STERLING TRUCK ACTERRA	All Models with Hendrickson Front Airtek
F	01-07	ACTERRA 5500	All Models with Hendrickson Front Airtek

89000 Series, Cab Shock

Shock	POP	Alternative No.	MTG Acc. Supplied
Pos.	Year	Application	
89453	D (cont)		
F	01-07	ACTERRA 6500	All Models with Hendrickson Front Airtek
89455	B		141108 (1)
R	08-23	KENWORTH T270	All Models with AG210L Rear Air Suspension
R	11-16	T700	All Models with Air Glide 400L (AG400L) Rear Air Suspension
R	07-22	PETERBILT 330	All Models with Peterbilt Low Air Leaf Suspension
R	03-05	330	All Models with Peterbilt Low Air Leaf Suspension
R	22-24	536	All Models with Peterbilt Low Air Leaf Suspension
89456	D		145089-200 (1)
R	11-16	KENWORTH T700	All Models with Air Glide 400 (AG400) Rear Air Suspension
89458	D		
R	08-09	INTERNATIONAL 4300	All Models with International 40,000 lb Rear Air Suspension
R	08-09	4400	All Models with International 40,000 lb Rear Air Suspension
R	10-11	DURASTAR - 4300, 4400 SERIES	
R	19	MV SERIES	
89459	D		401754 (2)
F	11-16	KENWORTH T700	All Models with 13,000 lb Front Axle
89460	D		
F	10-14	KENWORTH T270	All Models with 10,000 lb to 12,000 lb Front Axle
F	10-14	T270	All Models with 13,200 lb to 14,600 lb Front Axle
F	10-14	T270	All Models with 8,000 lb Front Axle
F	08-15	PETERBILT 325	All Models with 8,000 lb Front Axle
89503	D		
F	05-07	DYNAMAX CORP DYNAQUEST	All Models with 10000 to 12000 lb. Taper-leaf Spring Suspension
F	07-08	GRAND SPORT GT TOY HAULER	All 390TH Models with 12000 lb Taperleaf Front Suspension
F	03-07	GRAND SPORT M2	All Models with 10000 to 12000 lb. Taper-leaf Spring Suspension
F	02-08	FEDERAL COACH VARIOUS	
F	02-08	FREIGHTLINER M2 106	All Models with 10000 to 12000 lb. Taper-leaf Spring Suspension
F	02-08	M2 106	All Models with 6000 to 9000 lb Front axle
F	01-09	STERLING TRUCK ACTERRA	
Cab Shock			
83006	D		
	95-05	FREIGHTLINER FL50	All Day Cab Suspensions with O.E.M. Number
	96-05	FL60	All Day Cab Suspensions with O.E.M. Number
83021	C		
	90-96	CHEVROLET C60 KODIAK	All Truck Cabs with Link Cabmate Model GMC104TK
	90-96	C70 KODIAK	All Truck Cabs with Link Cabmate Model GMC104TK
	03-09	C4500 KODIAK	All Truck Cabs with Link Cabmate Model GMC104TK
	03-09	C5500 KODIAK	All Truck Cabs with Link Cabmate Model GMC104TK
	90-91	C5500 KODIAK	All Truck Cabs with Link Cabmate Model GMC104TK
	97-09	C6500 KODIAK	All Truck Cabs with Link Cabmate Model GMC104TK
	97-09	C7500 KODIAK	All Truck Cabs with Link Cabmate Model GMC104TK
	91-05	FREIGHTLINER FL60	All Trucks with Link Cabmate Models FRT153BC-A , FRT106BC or FRT106HD-A
	03-09	GMC C4500 TOPKICK	All Truck Cabs with Link Cabmate Model GMC104TK
	03-09	C5500 TOPKICK	All Truck Cabs with Link Cabmate Model GMC104TK

Numerical listing

Shock	POP	Alternative No.	MTG Acc. Supplied
Pos.	Year	Application	
83021	C (cont)		
	90-96	C6000 TOPKICK	All Truck Cabs with Link Cabmate Model GMC104TK
	03-09	C6500 TOPKICK	All Truck Cabs with Link Cabmate Model GMC104TK
	97-01	C6500 TOPKICK	All Truck Cabs with Link Cabmate Model GMC104TK
	90-96	C7000 TOPKICK	All Truck Cabs with Link Cabmate Model GMC104TK
	97-09	C7500 TOPKICK	All Truck Cabs with Link Cabmate Model GMC104TK
	96-97	MARMON HERRINGTON 57 GLIDER	All Conventional Tractors with Link Cabmate Model MARC57-B
	90-94	57 GLIDER	All Conventional Tractors with Link Cabmate Model MARC57-B
83024	D		
	11-16	KENWORTH T700	All Models with Extended Sleeper Cab
83025	C		
	03-09	GMC C4500 TOPKICK	All Models with Link Cabmate Model GMT560
	03-09	C5500 TOPKICK	All Models with Link Cabmate Model GMT560
	94-16	INTERNATIONAL 5000 SERIES	
83038	A		
	03-22	PIERCE MFG. INC. VARIOUS	
83039	D		
	03-24	PIERCE MFG. INC. VARIOUS	
83040	D		
	02-24	FREIGHTLINER M2 106	All Day Cab Models with Spring Suspensions
	02-24	PIERCE MFG. INC. VARIOUS	
83054	D		
	02-20	INTERNATIONAL 4300	All Models with O.E.M. Number
	02-19	4300LP	All Models with O.E.M. Number
	02-20	4400	All Models with O.E.M. Number
	02-19	4400LP	All Models with O.E.M. Number
	15-20	DURASTAR	All Models with O.E.M. Number
	13	DURASTAR	All Models with O.E.M. Number
	19-23	HV607	All Models with O.E.M. Number
	19-23	PIERCE MFG. INC. VARIOUS	
83056	D		
	11-16	KENWORTH T700	All Models with 86" Sleepers with O.E.M. Number
83066	C		
	23	MACK MD6	
	24	MD6	All Models with O.E.M. Number
	21-22	MD6	All Models with O.E.M. Number

COMPETITIVE & O.E.M. INTERCHANGE LIST
Lista de Intercambios contra Competidores y Equipo Original.
Liste dinterchange de produits comptitifs & dquipement original (OEM)

ACDelco

ACdelco	Gabriel	Upgrade	ACdelco	Gabriel	Upgrade	ACdelco	Gabriel	Upgrade	ACdelco	Gabriel	Upgrade
504-505	49107		508-56	G63605		520-150	81242		520-433	81925	
504-517	49155		508-57	83123	89405	520-152	81270		520-53	61555	
504-520	49162		508-59	G63183		520-157	81394		520-61	61565	
504-534	49212		508-68	83209	89414	520-16	61516		520-85	61600	
504-539	49218		508-68	85006		520-164	81510		525-16	58403	
504-550	49231		508-71	83314		520-165	81082		525-21	58412	
504-554	49235		508-72	G63386		520-17	61517		525-33	58488	
507-2	85302	89420	508-86	83136		520-178	81490		525-34	58489	
507-6	85314	89425	508-87	85071		520-183	81496		525-36	58609	
507-7	85301		508-90	83136		520-184	81484		525-42	58638	
507-8	85301		509-606	14017		520-19	61519		525-44	58662	
508-13	85012	89413	509-612	6802SE		520-214	81667		525-6	58357	
508-14	83216		509-613	6803SE		520-215	81668		525-66	58817	
508-14	85012	89413	509-626	6853SE		520-22	61522		540-5008	77403	
508-15	83216		519-15	43111		520-227	81713		540-5010	77375	
508-16	83308		519-2	43048		520-224	61524		540-5018	77412	
508-17	83312	89409	519-22	43163		520-25	61525		540-5018	77783	
508-18	83309		519-29	43180		520-261	82003		540-5032	77488	
508-19	83314		519-30	43181		520-292	82034		540-5033	77488	
508-23	83225		519-31	34036		520-293	82035		540-5033	77489	
508-24	83215		519-36	34073		520-300	82047		540-5040	77609	
508-26	85030	89440	520-1	61500		520-331	82086		540-5043	77638	
508-29	85030	89440	520-115	61641		520-40	61542		540-5046	77662	
508-30	85005	89430	520-116	61642		520-401	61687		540-5062	77783	
508-35	G63306		520-135	61663		520-403	61683		540-5069	77817	
508-39	G63347		520-138	81039		520-408	61685		550-13	85005	89430
508-47	G63350		520-142	81096		520-41	61543		550-73	85005	89430
508-48	G63409		520-145	81113		520-42	61544		550-77	83221	
508-50	G63299		520-146	81164		520-428	81873				
508-52	G63405		520-147	81147		520-429	81920				

ACF Brill Bus

Acf brill bus	Gabriel	Upgrade	Acf brill bus	Gabriel	Upgrade	Acf brill bus	Gabriel	Upgrade	Acf brill bus	Gabriel	Upgrade
661732	83215		661733	83225							

Advance AutoParts

Advance autoparts	Gabriel	Upgrade	Advance autoparts	Gabriel	Upgrade	Advance autoparts	Gabriel	Upgrade	Advance autoparts	Gabriel	Upgrade
34504	81925		59036	81744		59512	61632		59574	61519	
34732	81821		59041	81039		59512	81091		59574	82147	
34761	81828		59042	81113		59517	61646		59577	61547	
37187	82035		59044	81164		59519	61687		59578	81510	
55818	82155		59045	81496		59519	61687		59578	81510	
58581	61544		59048	81914		59520	61565		59582	61542	
58599	61656		59049	81913		59523	61599		59583	61543	
59003	81147		59061	81920		59525	61634		59586	61614	
59004	81825		59086	81713		59528	61635		59588	61530	
59006	81394		59090	81726		59542	61525		59589	61641	
59007	81242		59305	61555		59544	61524		59592	61642	
59011	81484		59306	61500		59547	81096		59592	81873	
59017	81676		59309	61591		59549	61517		59592	81921	
59017	82007		59501	81912		59554	61521		59596	61680	
59028	81668		59502	81892		59560	82034		59597	61654	
59029	81667		59503	61613		59561	61522		59598	61655	
59031	81490		59504	61612		59562	61518		59614	61663	
59032	81710		59505	61520		59567	61554				
59034	81082		59505	61546		59571	82003				
						59574	61516				

Important Note: Competitive Interchanges are to be used for stocking purposes only. Where multiple crosses are identified, please reference the applications section of this catalog. / **Remarque importante:** Les interchanges concurrentiels ne s'utilisent qu'aux fins de stocks. Dans le cas de rferences multiples, consulter la section des applications du catalogue. / **Nota importante:** Dans le cas de rferences multiples, consulter la section des applications du catalogue. / **Nota importante:** Se pueden usar intercambios competitivos para propósitos de almacenamiento solamente. Cuando se identifican intercambios múltiples, consulte la sección de aplicaciones de este catálogo.

COMPETITIVE & O.E.M. INTERCHANGE LIST
Lista de Intercambios contra Competidores y Equipo Original.
Liste dinterchange de produits comptitifs & dquipement original (OEM)

Advance Mixer

Advance mixer	Gabriel	Upgrade	Advance mixer	Gabriel	Upgrade	Advance mixer	Gabriel	Upgrade	Advance mixer	Gabriel	Upgrade
14626 ADV	83209	89414									

Allco Trailer

Allco trailer	Gabriel	Upgrade	Allco trailer	Gabriel	Upgrade	Allco trailer	Gabriel	Upgrade	Allco trailer	Gabriel	Upgrade
727602	83122	89406									

Alliance

Alliance	Gabriel	Upgrade	Alliance	Gabriel	Upgrade	Alliance	Gabriel	Upgrade	Alliance	Gabriel	Upgrade
ABP N32 G900001	85724	89443	ABP N32 G900049	85957		ABP N32 O900003	85918	89449	ABP N32 O900050	83135	
ABP N32 G900003	85918	89449	ABP N32 G900050	83135		ABP N32 O900005	85001	89410	ABP N32 O900051	83317	
ABP N32 G900005	85001	89410	ABP N32 G900051	83317		ABP N32 O900006	83456	89447	ABP N32 O900054	85005	89430
ABP N32 G900006	83456	89447	ABP N32 G900054	85005	89430	ABP N32 O900007	83125		ABP N32 O900056	83126	89430
ABP N32 G900007	83125		ABP N32 G900056	83126	89430	ABP N32 O900009	85006		ABP N32 O900058	85936	89456
ABP N32 G900009	85006		ABP N32 G900058	85936	89456	ABP N32 O900010	85013	89414	ABP N32 O900061	85072	
ABP N32 G900010	85013	89414	ABP N32 G900061	85072		ABP N32 O900018	83021		ABP N32 O900072	85656	
ABP N32 G900018	83021		ABP N32 G900072	85656		ABP N32 O900020	85067	89451	ABP N32 O900073	85058	89431
ABP N32 G900020	85067	89451	ABP N32 G900073	85058	89431	ABP N32 O900021	85070	89459	ABP N32 O900075	85919	
ABP N32 G900021	85070	89459	ABP N32 G900075	85919		ABP N32 O900027	85331		ABP N32 O900076	85012	89413
ABP N32 G900027	85331		ABP N32 G900076	85012	89413	ABP N32 O900030	83127		ABP N32 O900081	85920	89503
ABP N32 G900030	83127		ABP N32 G900081	85920	89503	ABP N32 O900031	85311	89424	ABP N32 O900083	85029	
ABP N32 G900031	85311	89424	ABP N32 G900083	85029		ABP N32 O900034	85310	89423	ABP N32 O900084	85959	
ABP N32 G900034	85310	89423	ABP N32 G900087	85030	89440	ABP N32 O900038	85069	89455	ABP N32 O900087	85030	89440
ABP N32 G900038	85069	89455	ABP N32 G900089	85932	89453	ABP N32 O900039	85033	89427	ABP N32 O900089	85932	89453
ABP N32 G900039	85033	89427	ABP N32 G900094	85084	89460	ABP N32 O900047	85900		ABP N32 O900092	83163	
ABP N32 G900047	85900		ABP N32 O900001	85724	89443	ABP N32 O900049	85957		ABP N32 O900093	83137	

AM General

Am general	Gabriel	Upgrade	Am general	Gabriel	Upgrade	Am general	Gabriel	Upgrade	Am general	Gabriel	Upgrade
5979484	85302	89420									

Aralmex

Aralmex	Gabriel	Upgrade	Aralmex	Gabriel	Upgrade	Aralmex	Gabriel	Upgrade	Aralmex	Gabriel	Upgrade
3AMG001	G63355		3AMG007	G63357		3AMG021	G63409		3AMG033	G63614	
3AMG004	G63306		3AMG009	G63406		3AMG026	G63455		3AMG035	G63607	

Arvin Meritor

Arvin meritor	Gabriel	Upgrade	Arvin meritor	Gabriel	Upgrade	Arvin meritor	Gabriel	Upgrade	Arvin meritor	Gabriel	Upgrade
085009	85009		727616	83216		728606	85302	89420	728624	85012	89413
654958	83164		727625	83225		728614	85310	89423	728625	85013	89414
665044	83209	89414	727635	83308		728615	85311	89424	728628	85314	89425
671091	85069	89455	727636	83309		728617	85005	89430	728631	85029	
671092	85012	89413	727639	83312	89409	728618	85006		728632	85030	89440
680464	85005	89430	727641	83314		728619	85007				
727609	83209	89414	727671	83613		728621	85009				
727615	83215		728601	85001	89410	728622	85010				

AutoAnything

Autoanything	Gabriel	Upgrade	Autoanything	Gabriel	Upgrade	Autoanything	Gabriel	Upgrade	Autoanything	Gabriel	Upgrade
AA61500	61500		AA61546	61546		AA61641	61641		AA77489	77489	
AA61516	61516		AA61547	61547		AA61642	61642		AA77609	77609	
AA61517	61517		AA61554	61554		AA61646	61646		AA77638	77638	
AA61518	61518		AA61565	61565		AA61654	61654		AA77662	77662	
AA61519	61519		AA61591	61591		AA61655	61655		AA77715	77715	
AA61520	61520		AA61599	61599		AA61656	61656		AA77716	77716	
AA61521	61521		AA61600	61600		AA61663	61663		AA77783	77783	
AA61522	61522		AA61611	61611		AA61680	61680		AA77817	77817	
AA61523	61523		AA61612	61612		AA61682	61682		AA77948	77948	
AA61524	61524		AA61613	61613		AA61687	61687		AA77950	77950	
AA61525	61525		AA61614	61614		AA61714	61714		AA81825	81825	
AA61530	61530		AA61634	61634		AA61716	61716		AA81928	81928	
AA61542	61542		AA61635	61635		AA77412	77412		AA82007	82007	
AA61543	61543		AA61638	61638		AA77488	77488		AA82012	82012	

Important Note: Competitive Interchanges are to be used for stocking purposes only. Where multiple crosses are identified, please reference the applications section of this catalog. / **Remarque importante:** Les interchanges concurrentiels ne s'utilisent qu'aux fins de stocks. Dans le cas de rferences multiples, consulter la section des applications du catalogue. / **Nota importante:** Dans le cas de rferences multiples, consulter la section des applications du catalogue. / **Nota importante:** Se pueden usar intercambios competitivos para propósitos de almacenamiento solamente. Cuando se identifican intercambios múltiples, consulte la sección de aplicaciones de este catálogo.

COMPETITIVE & O.E.M. INTERCHANGE LIST
Lista de Intercambios contra Competidores y Equipo Original.
Liste dinterchange de produits comptitifs & dquipement original (OEM)

AutoAnything... cont'd

Autoanything	Gabriel	Upgrade	Autoanything	Gabriel	Upgrade	Autoanything	Gabriel	Upgrade	Autoanything	Gabriel	Upgrade
AA82065	82065		AAG63375	G63375		AAG63609	G63609		AAG63810	G63810	
AA82086	82086		AAG63377	G63377		AAG63610	G63610		AAG63817	G63817	
AA82147	82147		AAG63386	G63386		AAG63614	G63614		AAG63837	G63837	
AA82155	82155		AAG63387	G63387		AAG63622	G63622		AAG63886	G63886	
AAG51856	G51856		AAG63403	G63403		AAG63623	G63623		AAG63888	G63888	
AAG56778	G56778		AAG63405	G63405		AAG63638	G63638		AA63893	G63893	
AAG57147	G57147		AAG63406	G63406		AAG63661	G63661		AAG63895	G63895	
AAG63183	G63183		AAG63409	G63409		AAG63662	G63662		AAG63897	G63897	
AAG63299	G63299		AAG63410	G63410		AAG63671	G63671		AAG63918	G63918	
AAG63306	G63306		AAG63411	G63411		AAG63673	G63673		AAG63969	G63969	
AAG63347	G63347		AAG63413	G63413		AAG63674	G63674		AAG63971	G63971	
AAG63349	G63349		AAG63414	G63414		AAG63675	G63675		AA64009	G64009	
AAG63350	G63350		AAG63455	G63455		AAG63714	G63714		AA64010	G64010	
AAG63353	G63353		AAG63456	G63456		AAG63715	G63715		AA64011	G64011	
AAG63355	G63355		AAG63461	G63461		AAG63716	G63716		AA64013	G64013	
AAG63357	G63357		AAG63488	G63488		AAG63778	G63778		AA64043	G64043	
AAG63359	G63359		AAG63489	G63489		AAG63783	G63783		AA64044	G64044	
AAG63360	G63360		AAG63605	G63605		AAG63808	G63808				
AAG63366	G63366		AAG63607	G63607		AAG63809	G63809				

Autocar LLC.

Autocar llc.	Gabriel	Upgrade	Autocar llc.	Gabriel	Upgrade	Autocar llc.	Gabriel	Upgrade	Autocar llc.	Gabriel	Upgrade
03-1106460	85005	89430	60657-003L	85072		60675003	85976		60680005L	83142	
031106460	85005	89430	60657003	85072		60675003L	85976		660186	83216	
1011839	83216		60657003L	85072		60680-004	83143		800781	85314	89425
28CFG-910	83216		60670-005	83137		60680-004L	83143		849246	83216	
28CFG-910Z	83216		60670-005L	83137		60680-005	83142		A3591004-001	85072	
28CFG910	83216		60670005	83137		60680-005L	83142		A3591004001	85072	
28CFG910Z	83216		60670005L	83137		60680004	83143				
28R010	83216		60675-003	85976		60680004L	83143				
60657-003	85072		60675-003L	85976		60680005	83142				

Autopart International

Autopart international	Gabriel	Upgrade	Autopart international	Gabriel	Upgrade	Autopart international	Gabriel	Upgrade	Autopart international	Gabriel	Upgrade
2701-204605	81921		2701-80658	81744		2701-80901	81710		2725-539606	58662	
2701-204663	81919		2701-80875	81490		2701-80903	81091		2725-539620	58817	
2701-233579	6828SE		2701-80876	81039		2701-80958	81873		2725-539627	58609	
2701-233580	6854SE		2701-80882	81484		2701-80959	81912		2725-539630	58714	
2701-233597	6847SE		2701-80890	81914		2701-80962	81828		2725-539634	58809	
2701-248154	81913		2701-80893	81164		2701-80963	81928		2725-539635	58807	
2701-80645	81713		2701-80899	81096		2701-82488	81892		2725-539650	58623	
2701-80655	81667		2701-80900	81496		2701-82573	81920		2725-539651	58622	
2701-80656	81668		2701-80901	81082		2701-82574	81925		2725-546476	58488	
2701-80657	81726		2701-80901	81510		2701-82587	81394				

AutoZone

Autozone	Gabriel	Upgrade	Autozone	Gabriel	Upgrade	Autozone	Gabriel	Upgrade	Autozone	Gabriel	Upgrade
344426	81676		TS33-31452B	61656		TS34-31371B	81912		TS34-32162B	61654	
61655	61655		TS33-32351B	81113		TS34-31382B	81892		TS34-32172B	61614	
TS32-30102B	81147		TS33-32542B	81490		TS34-31391B	81744		TS34-32252B	81496	
TS32-30261B	81394		TS33-32542B	81710		TS34-31422B	81925		TS34-32261B	81919	
TS32-34032B	82065		TS33-32573B	82007		TS34-31432B	81667		TS34-32321B	81096	
TS32-34092B	82155		TS33-32641B	81821		TS34-31532B	81913		TS34-32423B	81242	
TS32-34341B	82035		TS33-32813B	81484		TS34-31672B	81082		TS34-32632B	81825	
TS32-34352B	82086		TS33-33032B	82003		TS34-31691B	81668		TS34-32671B	81834	
TS33-30892B	81873		TS33-34381B	82047		TS34-32072B	81713		TS34-34511B	82012	
TS33-30892B	81928		TS34-31021B	81726		TS34-32102B	81164				
TS33-30971B	81914		TS34-31231B	82034		TS34-32111B	81039				
TS33-31181B	82147		TS34-31342B	81921		TS34-32141B	61546				
TS33-31402B	81828		TS34-31361B	81920		TS34-32152B	81510				

Important Note: Competitive Interchanges are to be used for stocking purposes only. Where multiple crosses are identified, please reference the applications section of this catalog. / **Remarque importante:** Les interchanges concurrentiels ne s'utilisent qu'aux fins de stocks. Dans le cas de rfrences multiples, consulter la section des applications du catalogue. / **Nota importante:** Dans le cas de rfrences multiples, consultar la section des aplicaciones du catalogue. / **Nota importante:** Se pueden usar intercambios competitivos para propósitos de almacenamiento solamente. Cuando se identifican intercambios múltiples, consulte la sección de aplicaciones de este catálogo.

COMPETITIVE & O.E.M. INTERCHANGE LIST
Lista de Intercambios contra Competidores y Equipo Original.
Liste dinterchange de produits comptitifs & dquipement original (OEM)

AutoZone... cont'd

Batco

Batco	Gabriel	Upgrade	Batco	Gabriel	Upgrade	Batco	Gabriel	Upgrade	Batco	Gabriel	Upgrade
1083209	83209	89414	1083310	83221		1085005	85005	89430	1085301	85301	
1083225	83225		1083317	83317		1085007	85007		1085311	85311	89424

Bering Truck Corp.

Bering truck corp.	Gabriel	Upgrade	Bering truck corp.	Gabriel	Upgrade	Bering truck corp.	Gabriel	Upgrade	Bering truck corp.	Gabriel	Upgrade
47902-24	83137		4790224	83137							

Berkshire Coach

Berkshire coach	Gabriel	Upgrade	Berkshire coach	Gabriel	Upgrade	Berkshire coach	Gabriel	Upgrade	Berkshire coach	Gabriel	Upgrade
8C24-18045-DA	G63622		8C2418080DB	G63623		8C2Z18124D	G63622		ASH-1154	G63622	
8C24-18080-DB	G63623		8C2Z-18124-D	G63622		8C2Z18125D	G63623		ASH1136	G63623	
8C2418045DA	G63622		8C2Z-18125-D	G63623		ASH-1136	G63623		ASH1154	G63622	

Bilstein

Bilstein	Gabriel	Upgrade	Bilstein	Gabriel	Upgrade	Bilstein	Gabriel	Upgrade	Bilstein	Gabriel	Upgrade
14-186629	85125		24-186414	85029		B46-2151	85007		F4-BE5-F324-H0	85125	
24-015943	85013	89414	B46-1594	85013	89414	F4-B46-1594-H0	85013	89414	F4-BE5-F325-H0	85124	
24-017329	85030	89440	B46-1594	85030	89440	F4-B46-1725-H2	85029				
24-153249	85125		B46-1725	85029		F4-B46-1732-H1	85030	89440			
24-153256	85124		B46-1732	85030	89440	F4-BE5-B492-H0	85125				

Blue Bird

Blue bird	Gabriel	Upgrade	Blue bird	Gabriel	Upgrade	Blue bird	Gabriel	Upgrade	Blue bird	Gabriel	Upgrade
00085991	85006		3001316546	85006		59057001	83137		8C24-18080-DB	G63623	
00119797	85959		3001317767	85029		59483-000	85919		8C2418045DA	G63622	
0014985	83137		471700000428	85006		59483000	85919		8C2418080DB	G63623	
0015222	85919		471700000456	85959		60665-005	85919		8C2Z-18124-D	G63622	
0020326	85976		471700131545	85006		60665-005L	85919		8C2Z-18125-D	G63623	
0040015	85919		481700131438	85919		60665003	83137		8C2Z18124D	G63622	
0055008	85959		58913-007	85959		60665005	85919		8C2Z18125D	G63623	
0055017	85959		58913-007L	85959		60665005L	85919		90044915	83127	
0085990	85959		58913-008	85959		60998-001	85006		90045083	85910	
01722214	85030	89440	58913-008L	85959		60998-002	85919		AMS65109	85058	89431
060665-003	83137		58913-009	85959		60998-002L	85919		AMS65110	85005	89430
1316546	85006		58913-009L	85959		60998-003	85006		AMS65119	85029	
1317767	85029		58913-011	85959		60998001	85006		ASH-1136	G63623	
1658533	85010		58913-011L	85959		60998002	85919		ASH-1154	G63622	
1667831	85029		58913007	85959		60998002L	85919		ASH1136	G63623	
1668722	85030	89440	58913007L	85959		60998003	85006		ASH1154	G63622	
1668730	85013	89414	58913008	85959		65992-003	85959		AT-163G	G63622	
1707405	85005	89430	58913008L	85959		65992003	85959		AT-164G	G63623	
1722222	85013	89414	58913009	85959		671933	85919		AT163G	G63622	
1746163	85006		58913009L	85959		70397	85006		AT164G	G63623	
2021459	85012	89413	58913011	85959		7805-M-1001	85919				
300-1316546	85006		58913011L	85959		7805M1001	85919				
300-1317767	85029		59057-001	83137		8C24-18045-DA	G63622				

BOGE

Boge	Gabriel	Upgrade	Boge	Gabriel	Upgrade	Boge	Gabriel	Upgrade	Boge	Gabriel	Upgrade
2001	81394		35084	81342		35257	58609		83-503-8	61524	
2002	81147		35085	61632		35257	77609		83-503-9	61525	
32002	81270		35085	81825		35257	81496		83-503-9	81039	
32276	81713		35087	82065		83-205-7	81821		83-505-3	61520	
33001	6802SE		35091	58489		83-227-6	77375		83-505-3	61546	
33002	6847SE		35091	61544		83-228-0	81147		83-505-3	77414	
33005	6804SE		35091	77489		83-263-5	81676		83-505-3	77455	
34-508-0	77614		35091	81668		83-501-6	61521		83-505-3	81394	
35039	61525		35115	58623		83-501-6	82012		83-505-3	81490	
35039	81039		35115	81242		83-502-0	61500		83-505-3	81744	

Important Note: Competitive Interchanges are to be used for stocking purposes only. Where multiple crosses are identified, please reference the applications section of this catalog. / **Remarque importante:** Les interchanges concurrentiels ne s'utilisent qu'aux fins de stocks. Dans le cas de rferences multiples, consulter la section des applications du catalogue. / **Nota importante:** Dans le cas de rferences multiples, consulter la section des applications du catalogue. / **Nota importante:** Se pueden usar intercambios competitivos para propósitos de almacenamiento solamente. Cuando se identifican intercambios múltiples, consulte la sección de aplicaciones de este catálogo.

COMPETITIVE & O.E.M. INTERCHANGE LIST
Lista de Intercambios contra Competidores y Equipo Original.
Liste dinterchange de produits comptitifs & dquipement original (OEM)

BOGE... cont'd

Boge	Gabriel	Upgrade	Boge	Gabriel	Upgrade	Boge	Gabriel	Upgrade	Boge	Gabriel	Upgrade
83-505-4	61518		83-510-0	61642		83-518-4	81912		83-524-9	61710	
83-505-4	61530		83-510-0	81873		83-518-5	61614		930003	77675	
83-505-4	61547		83-510-1	61634		83-518-7	61612		930004	77949	
83-505-4	61554		83-510-1	61635		83-518-7	61638		930004	77950	
83-505-4	61654		83-510-1	81919		83-518-7	81892		930012	77661	
83-505-4	61713		83-510-7	58622		83-518-7	81913		930013	61716	
83-505-4	77461		83-510-7	58807		83-519-0	61680		930022	77715	
83-505-4	81082		83-510-7	61591		83-519-0	77809		930022	77808	
83-505-4	81510		83-510-7	77614		83-519-0	77837		930024	58809	
83-505-4	81710		83-510-7	77807		83-519-0	77951		930026	77810	
83-509-0	58359		83-510-7	81744		83-520-6	58817		930033	77948	
83-509-0	61523		83-511-5	61646		83-520-6	61641		930034	58488	
83-509-0	81096		83-511-5	77623		83-520-6	61663		930034	77488	
83-509-0	81834		83-511-5	81828		83-520-6	77783		930037	77638	
83-509-1	58489		83-512-0	58357		83-520-6	81920		930041	77976	
83-509-1	61544		83-512-0	61517		83-520-6	81925		930049	58944	
83-509-1	61555		83-512-1	58638		83-521-1	61710		930049	77673	
83-509-1	77489		83-512-1	61516		83-521-6	61600		930049	77674	
83-509-1	81668		83-512-1	61519		83-523-1	61613		930049	77967	
83-509-2	61543		83-512-1	61522		83-523-1	81914		930051	77968	
83-509-2	81667		83-512-1	81484		83-523-7	61655		930051	77969	
83-509-3	61565		83-518-3	77607		83-523-8	58810		930052	77817	
83-509-7	58638		83-518-4	58714		83-523-8	61656		930146	61714	
83-509-7	61687		83-518-4	58808		83-524-1	58662				
83-509-7	81164		83-518-4	61611		83-524-1	61600				
83-509-9	61599		83-518-4	77714		83-524-8	81928				

Boystun Equipment Manufacturing

Boystun equipment manufacturing	Gabriel	Upgrade	Boystun equipment manufacturing	Gabriel	Upgrade	Boystun equipment manufacturing	Gabriel	Upgrade	Boystun equipment manufacturing	Gabriel	Upgrade
1253069B000	85005	89430									

Brockway School Bus

Brockway school bus	Gabriel	Upgrade	Brockway school bus	Gabriel	Upgrade	Brockway school bus	Gabriel	Upgrade	Brockway school bus	Gabriel	Upgrade
14QK-282P1	83216		14QK282P1	83216		152412	83215				
14QK-282P3	83216		14QK282P3	83216							

Built Rite

Built rite	Gabriel	Upgrade	Built rite	Gabriel	Upgrade	Built rite	Gabriel	Upgrade	Built rite	Gabriel	Upgrade
318-06-100	85006		31806100	85006							

Bull Dog

Bull dog	Gabriel	Upgrade	Bull dog	Gabriel	Upgrade	Bull dog	Gabriel	Upgrade	Bull dog	Gabriel	Upgrade
HD1114-0258	83169		HD1214-0559	83309		HD1214-0607	83154		HD1215-003	85033	89427
HD1116-0033	85311	89424	HD1214-0560	83141		HD1214-0609	85310	89423	HD1215-0031	85069	89455
HD1116-0044	85302	89420	HD1214-0561	85071		HD1214-0611	83134		HD1215-0033	85311	89424
HD1116-0059	85332		HD1214-0562	83312	89409	HD1214-0612	85033	89427	HD1215-0034	85067	89451
HD1213-0651	83021		HD1214-0563	83215		HD1214-0640	83216		HD1215-0036	85001	89410
HD1213-0705	85006		HD1214-0564	83312	89409	HD1214-0641	83216		HD1215-0041	85923	89458
HD1214-0497	83054		HD1214-0566	83123	89405	HD1214-0642	83135		HD1215-0043	85013	89414
HD1214-0526	83613		HD1214-0567	83215		HD1214-0657	83164		HD1215-0045	85013	89414
HD1214-0530	83123	89405	HD1214-0568	83225		HD1214-0658	83308		HD1215-0048	85084	89460
HD1214-0532	83125		HD1214-0568	85007		HD1214-0660	83107		HD1215-0048	85989	
HD1214-0534	83127		HD1214-0571	83159		HD1215-0018	85724	89443	HD1215-0054	85909	
HD1214-0539	83126	89430	HD1214-0572	83163		HD1215-0020	85070	89459	HD1215-0055	85656	
HD1214-0540	83515		HD1214-0573	83025		HD1215-0022	85928		HD1215-0056	85012	89413
HD1214-0545	83456	89447	HD1214-0579	83221		HD1215-0022	85957		HD1215-0059	83123	89405
HD1214-0550	83314		HD1214-0580	83209	89414	HD1215-0023	85031		HD1215-0060	85959	
HD1214-0551	83126	89430	HD1214-0593	83120		HD1215-0024	85918	89449			
HD1214-0556	83136		HD1214-0595	83308		HD1215-0024	85920	89503			
HD1214-0557	83101		HD1214-0602	83120		HD1215-0025	85918	89449			
HD1214-0558	83169		HD1214-0605	85012	89413	HD1215-0026	85331				

Important Note: Competitive Interchanges are to be used for stocking purposes only. Where multiple crosses are identified, please reference the applications section of this catalog. / **Remarque importante:** Les interchanges concurrentiels ne s'utilisent qu'aux fins de stocks. Dans le cas de rferences multiples, consulter la section des applications du catalogue. / **Nota importante:** En el caso de rferencias multiples, consultar la seccion de aplicaciones del catalogo. / **Nota importante:** Se pueden usar intercambios competitivos para propósitos de almacenamiento solamente. Cuando se identifican intercambios múltiples, consulte la sección de aplicaciones de este catálogo.

COMPETITIVE & O.E.M. INTERCHANGE LIST

Lista de Intercambios contra Competidores y Equipo Original.

Liste d'interchange de produits compétitifs & d'équipement original (OEM)

Bull Dog... cont'd

Bull dog	Gabriel	Upgrade	Bull dog	Gabriel	Upgrade	Bull dog	Gabriel	Upgrade	Bull dog	Gabriel	Upgrade
HD1215-0061	85012	89413	HD1215-0083	85978		HD1215-0107	85001	89410	HD1215-0128	85054	
HD1215-0062	85910		HD1215-0084	83135		HD1215-0108	85030	89440	HD1215-0132	83143	
HD1215-0063	83317		HD1215-0085	83163		HD1215-0110	83122	89406	HD1215-0133	83122	89406
HD1215-0066	85029		HD1215-0086	85310	89423	HD1215-0111	85043		HD1215-0147	85927	
HD1215-0069	85072		HD1215-0086	85936	89456	HD1215-0114	85058	89431	HD1215-0148	85181	
HD1215-0071	85005	89430	HD1215-0088	85006		HD1215-0115	85058	89431	HD1215-0150	85029	
HD1215-0073	85976		HD1215-0093	83209	89414	HD1215-0116	85058	89431	HD1215-0151	85010	
HD1215-0076	85069	89455	HD1215-0094	83142		HD1215-0117	85910		HD1215-0154	85995	
HD1215-0077	85900		HD1215-0095	83175		HD1215-0118	83160		HD1215-0156	83136	
HD1215-0079	85919		HD1215-0096	85029		HD1215-0123	83131		HD1215-0157	85030	89440
HD1215-0081	83136		HD1215-0103	85932	89453	HD1215-0126	85376		HD1215-0160	85125	
HD1215-0082	85311	89424	HD1215-0104	85956		HD1215-0127	85082				

CargoMaxx

Cargomaxx	Gabriel	Upgrade	Cargomaxx	Gabriel	Upgrade	Cargomaxx	Gabriel	Upgrade	Cargomaxx	Gabriel	Upgrade
441 - 83021	83021		441 - 83221	83221		441 - 850295451	85029		441 - 853115444	85311	89424
441 - 83025	83025		441 - 83309	83309		441 - 85030	85030	89440	441 - 85724	85724	89443
441 - 83122	83122	89406	441 - 833126668	83312	89409	441 - 85031	85031		441 - 85900	85900	
441 - 83123	83123	89405	441 - 833126811	83312	89409	441 - 85033	85033	89427	441 - 85909	85909	
441 - 83125	83125		441 - 83317	83317		441 - 850585109	85058	89431	441 - 85910	85910	
441 - 831266833	83126	89430	441 - 83456	83456	89447	441 - 850585478	85058	89431	441 - 859185140	85918	89449
441 - 831266897	83126	89430	441 - 83515	83515		441 - 85067	85067	89451	441 - 859185148	85918	89449
441 - 831266969	83126	89430	441 - 83613	83613		441 - 850695468	85069	89455	441 - 85919	85919	
441 - 83127	83127		441 - 85001	85001	89410	441 - 850695528	85069	89455	441 - 85926	85656	
441 - 83136	83136		441 - 85005	85005	89430	441 - 85070	85070	89459	441 - 85932	85932	89453
441 - 83142	83142		441 - 850065482	85006		441 - 85072	85072		441 - 85936	85936	89456
441 - 83143	83143		441 - 850065505	85006		441 - 85084	85084	89460	441 - 85956	85956	
441 - 83156	83169		441 - 85012	85012	89413	441 - 85302	85302	89420	441 - 85957	85957	
441 - 831635143	83163		441 - 850125113	85012	89413	441 - 85310	85310	89423	441 - 85959	85959	
441 - 831636422	83163		441 - 850135401	85013	89414	441 - 853104409	85310	89423	441 - 85976	85976	
441 - 83209	83209	89414	441 - 850135420	85013	89414	441 - 853114417	85311	89424	441 - 85978	85978	
441 - 83215	83215		441 - 85029	85029		441 - 853115402	85311	89424			

Cascade Trailer

Cascade trailer	Gabriel	Upgrade	Cascade trailer	Gabriel	Upgrade	Cascade trailer	Gabriel	Upgrade	Cascade trailer	Gabriel	Upgrade
120-1	83125		1201	83125							

Caterpillar

Caterpillar	Gabriel	Upgrade	Caterpillar	Gabriel	Upgrade	Caterpillar	Gabriel	Upgrade	Caterpillar	Gabriel	Upgrade
60657-003	85072		60670-005L	83137		60680-005	83142		60680005L	83142	
60657-003L	85072		60670005	83137		60680-005L	83142		H60680004	83143	
60657003	85072		60670005L	83137		60680004	83143		HDR60680-005	83142	
60657003L	85072		60680-004	83143		60680004L	83143		HDR60680005	83142	
60670-005	83137		60680-004L	83143		60680005	83142				

Chalmers Suspension

Chalmers suspension	Gabriel	Upgrade	Chalmers suspension	Gabriel	Upgrade	Chalmers suspension	Gabriel	Upgrade	Chalmers suspension	Gabriel	Upgrade
21335	G63355		800781	85314	89425	K880248	85314	89425			

Champion Bus Inc.

Champion bus inc.	Gabriel	Upgrade	Champion bus inc.	Gabriel	Upgrade	Champion bus inc.	Gabriel	Upgrade	Champion bus inc.	Gabriel	Upgrade
22064230	83136		8C2Z-18124-D	G63622		ASH-1154	G63622		AT163G	G63622	
8C24-18045-DA	G63622		8C2Z-18125-D	G63623		ASH1136	G63623		AT164G	G63623	
8C24-18080-DB	G63623		8C2Z18124D	G63622		ASH1154	G63622				
8C2418045DA	G63622		8C2Z18125D	G63623		AT-163G	G63622				
8C2418080DB	G63623		ASH-1136	G63623		AT-164G	G63623				

Chance Coach

Chance coach	Gabriel	Upgrade	Chance coach	Gabriel	Upgrade	Chance coach	Gabriel	Upgrade	Chance coach	Gabriel	Upgrade
2021459	85012	89413									

Important Note: Competitive Interchanges are to be used for stocking purposes only. Where multiple crosses are identified, please reference the applications section of this catalog. / **Remarque importante:** Les interchanges concurrentiels ne s'utilisent qu'aux fins de stocks. Dans le cas de références multiples, consulter la section des applications du catalogue. / **Nota importante:** Dans le cas de referencias multiples, consultar la sección de aplicaciones del catálogo. / **Nota importante:** Se pueden usar intercambios competitivos para propósitos de almacenamiento solamente. Cuando se identifican intercambios múltiples, consulte la sección de aplicaciones de este catálogo.

COMPETITIVE & O.E.M. INTERCHANGE LIST
Lista de Intercambios contra Competidores y Equipo Original.
Liste dinterchange de produits comptitifs & dquipement original (OEM)

Clark Equipment

Clark equipment	Gabriel	Upgrade	Clark equipment	Gabriel	Upgrade	Clark equipment	Gabriel	Upgrade	Clark equipment	Gabriel	Upgrade
680042	85301										

CNH Global NV.

Cnh global nv.	Gabriel	Upgrade	Cnh global nv.	Gabriel	Upgrade	Cnh global nv.	Gabriel	Upgrade	Cnh global nv.	Gabriel	Upgrade
87268250	83021										

Coach House

Coach house	Gabriel	Upgrade	Coach house	Gabriel	Upgrade	Coach house	Gabriel	Upgrade	Coach house	Gabriel	Upgrade
8C24-18045-DA	G63622		8C2Z-18124-D	G63622		ASH-1136	G63623		AT-163G	G63622	
8C24-18080-DB	G63623		8C2Z-18125-D	G63623		ASH-1154	G63622		AT-164G	G63623	
8C2418045DA	G63622		8C2Z18124D	G63622		ASH1136	G63623		AT163G	G63622	
8C2418080DB	G63623		8C2Z18125D	G63623		ASH1154	G63622		AT164G	G63623	

Coachmen

Coachmen	Gabriel	Upgrade	Coachmen	Gabriel	Upgrade	Coachmen	Gabriel	Upgrade	Coachmen	Gabriel	Upgrade
141700131809	85029		8C24-18045-DA	G63622		ASH-1154	G63622		ASH1230	83122	89406
141700131810	83160		8C24-18080-DB	G63623		ASH-1205	83209	89414	ASH137	83122	89406
16-16736-000	85029		8C2418045DA	G63622		ASH-1206	83122	89406	ASH25822	83209	89414
16-16737-000	83160		8C2418080DB	G63623		ASH-1228	83209	89414	ASH25823	83209	89414
16-16873-000	85029		8C2Z-18124-D	G63622		ASH-1229	83209	89414	ASH25824	83122	89406
16-16874-000	83160		8C2Z-18125-D	G63623		ASH-1230	83122	89406	ASH294	83209	89414
16-18103-000	85900		8C2Z18124D	G63622		ASH-137	83122	89406	AT-163G	G63622	
1616736000	85029		8C2Z18125D	G63623		ASH-25822	83209	89414	AT-164G	G63623	
1616737000	83160		9U94-18045-AA	83209	89414	ASH-25823	83209	89414	AT-620	83209	89414
1616873000	85029		9U94-18080-AA	83122	89406	ASH-25824	83122	89406	AT-621	83122	89406
1616874000	83160		9U9418045AA	83209	89414	ASH-294	83209	89414	AT-766	83209	89414
1618103000	85900		9U9418080AA	83122	89406	ASH1022	83209	89414	AT163G	G63622	
1C34-18045-AA	83209	89414	9U9Z-18124-A	83209	89414	ASH1023	83122	89406	AT164G	G63623	
1C34-18045-JA	83209	89414	9U9Z-18125-A	83122	89406	ASH1136	G63623		AT620	83209	89414
1C3418045AA	83209	89414	9U9Z18124A	83209	89414	ASH1154	G63622		AT621	83122	89406
1C3418045JA	83209	89414	9U9Z18125A	83122	89406	ASH1205	83209	89414	AT766	83209	89414
481700000493	85900		ASH-1022	83209	89414	ASH1206	83122	89406	F4-BE5-C832-MO	83124	89407
66153-002	83124	89407	ASH-1023	83122	89406	ASH1228	83209	89414	F4BE5C832MO	83124	89407
66153002	83124	89407	ASH-1136	G63623		ASH1229	83209	89414			

Cofap

Cofap	Gabriel	Upgrade	Cofap	Gabriel	Upgrade	Cofap	Gabriel	Upgrade	Cofap	Gabriel	Upgrade
45054	85301		45117	85918	89449	L-12703	85071				
45058	85301		ATG-085	G63607		L-12713	83136				

Collins Bus Corp.

Collins bus corp.	Gabriel	Upgrade	Collins bus corp.	Gabriel	Upgrade	Collins bus corp.	Gabriel	Upgrade	Collins bus corp.	Gabriel	Upgrade
ASH-1136	G63623		ASH-1154	G63622		ASH1136	G63623		ASH1154	G63622	

Country Coach

Country coach	Gabriel	Upgrade	Country coach	Gabriel	Upgrade	Country coach	Gabriel	Upgrade	Country coach	Gabriel	Upgrade
10-13634-000	85918	89449	471700002809	85724	89443	8C2Z-18125-D	G63623		AT-163G	G63622	
10-13760-000	85959		471700002991	85959		8C2Z18124D	G63622		AT-164G	G63623	
1013634000	85918	89449	8C24-18045-DA	G63622		8C2Z18125D	G63623		AT163G	G63622	
1013760000	85959		8C24-18080-DB	G63623		ASH-1136	G63623		AT164G	G63623	
16-18708-000	85724	89443	8C2418045DA	G63622		ASH-1154	G63622		SDA471700002991	85959	
1618708000	85724	89443	8C2418080DB	G63623		ASH1136	G63623				
471700000449	85918	89449	8C2Z-18124-D	G63622		ASH1154	G63622				

Crane Carrier

Crane carrier	Gabriel	Upgrade	Crane carrier	Gabriel	Upgrade	Crane carrier	Gabriel	Upgrade	Crane carrier	Gabriel	Upgrade
227A-14	85716		277A13	85302	89420	60680004	83143		64178001	83143	
227A14	85716		60680-004	83143		60680004L	83143				
277A-13	85302	89420	60680-004L	83143		64178-001	83143				

Cush Corporation

Cush corporation	Gabriel	Upgrade	Cush corporation	Gabriel	Upgrade	Cush corporation	Gabriel	Upgrade	Cush corporation	Gabriel	Upgrade
C0228	85005	89430									

Important Note: Competitive Interchanges are to be used for stocking purposes only. Where multiple crosses are identified, please reference the applications section of this catalog. / **Remarque importante:** Les interchanges concurrentiels ne s'utilisent qu'aux fins de stocks. Dans le cas de rfrences multiples, consulter la section des applications du catalogue. / **Nota importante:** Dans le cas de rfrences multiples, consultar la section des aplicaciones du catalogue. / **Nota importante:** Se pueden usar intercambios competitivos para propósitos de almacenamiento solamente. Cuando se identifican intercambios múltiples, consulte la sección de aplicaciones de este catálogo.

COMPETITIVE & O.E.M. INTERCHANGE LIST
Lista de Intercambios contra Competidores y Equipo Original.
Liste dinterchange de produits compititifs & dquipement original (OEM)

CV CATALOG

Cv catalog	Gabriel	Upgrade	Cv catalog	Gabriel	Upgrade	Cv catalog	Gabriel	Upgrade	Cv catalog	Gabriel	Upgrade
83006	83006		83163	83163		85009	85009		85335	85335	
83021	83021		83164	83164		85010	85010		85351	85351	
83024	83024		83166	83166		85012	85012	89413	85376	85376	
83025	83025		83168	83168		85013	85013	89414	85649	85649	
83040	83040		83169	83169		85029	85029		85650	85650	
83054	83054		83175	83175		85030	85030	89440	85656	85656	
83056	83056		83180	83180		85031	85031		85670	85670	
83066	83066		83209	83209	89414	85033	85033	89427	85716	85716	
83101	83101		83215	83215		85043	85043		85724	85724	89443
83107	83107		83216	83216		85054	85054		85900	85900	
83114	83114		83221	83221		85058	85058	89431	85902	85902	
83120	83120		83225	83225		85063	85063		85909	85909	
83122	83122	89406	83243	83243		85067	85067	89451	85910	85910	
83123	83123	89405	83308	83308		85069	85069	89455	85918	85918	89449
83125	83125		83309	83309		85070	85070	89459	85919	85919	
83126	83126	89430	83312	83312	89409	85071	85071		85920	85920	89503
83127	83127		83314	83314		85072	85072		85921	85921	
83131	83131		83317	83317		85082	85082		85923	85923	89458
83134	83134		83364	83364		85084	85084	89460	85927	85927	
83135	83135		83391	83391		85124	85124		85928	85928	
83136	83136		83395	83395		85125	85125		85932	85932	89453
83137	83137		83397	83397		85180	85180		85936	85936	89456
83140	83140		83398	83398		85181	85181		85956	85956	
83141	83141		83456	83456	89447	85182	85182		85957	85957	
83142	83142		83515	83515		85188	85188		85959	85959	
83143	83143		83518	83518		85301	85301		85976	85976	
83148	83148		83519	83519		85302	85302	89420	85978	85978	
83154	83154		83613	83613		85310	85310	89423	85985	85985	
83157	83157		85001	85001	89410	85311	85311	89424	85988	85988	
83159	83159		85005	85005	89430	85314	85314	89425	85989	85989	
83160	83160		85006	85006		85331	85331		85995	85995	
83162	83162		85007	85007		85332	85332				

Damon Motor Coach

Damon motor coach	Gabriel	Upgrade	Damon motor coach	Gabriel	Upgrade	Damon motor coach	Gabriel	Upgrade	Damon motor coach	Gabriel	Upgrade
1C34-18045-AA	83209	89414	9U9Z-18125-A	83122	89406	ASH1022	83209	89414	AT620	83209	89414
1C34-18045-JA	83209	89414	9U9Z18124A	83209	89414	ASH1023	83122	89406	AT621	83122	89406
1C3418045AA	83209	89414	9U9Z18125A	83122	89406	ASH1205	83209	89414	AT766	83209	89414
1C3418045JA	83209	89414	ASH-1022	83209	89414	ASH1206	83122	89406	F4-BE5-A832-MO	85125	
24-153249	85125		ASH-1023	83122	89406	ASH1228	83209	89414	F4-BE5-B492-HO	85125	
24-153256	85124		ASH-1205	83209	89414	ASH1229	83209	89414	F4-BE5-F324-HO	85125	
24-186629	85125		ASH-1206	83122	89406	ASH1230	83122	89406	F4-BE5-F325-HO	85124	
24153249	85125		ASH-1228	83209	89414	ASH137	83122	89406	F4BE5A832MO	85125	
24153256	85124		ASH-1229	83209	89414	ASH25822	83209	89414	F4BE5B492HO	85125	
24186629	85125		ASH-1230	83122	89406	ASH25823	83209	89414	F4BE5F324HO	85125	
9U94-18045-AA	83209	89414	ASH-137	83122	89406	ASH25824	83122	89406	F4BE5F325HO	85124	
9U94-18080-AA	83122	89406	ASH-25822	83209	89414	ASH294	83209	89414	W0005662	85125	
9U9418045AA	83209	89414	ASH-25823	83209	89414	AT-620	83209	89414	W0005663	85124	
9U9418080AA	83122	89406	ASH-25824	83122	89406	AT-621	83122	89406	W0006254	85125	
9U9Z-18124-A	83209	89414	ASH-294	83209	89414	AT-766	83209	89414			

Dexter Axle

Dexter axle	Gabriel	Upgrade	Dexter axle	Gabriel	Upgrade	Dexter axle	Gabriel	Upgrade	Dexter axle	Gabriel	Upgrade
18165-01	85006		1816501	85006							

Diamond Coach

Diamond coach	Gabriel	Upgrade	Diamond coach	Gabriel	Upgrade	Diamond coach	Gabriel	Upgrade	Diamond coach	Gabriel	Upgrade
8C24-18045-DA	G63622		8C2418045DA	G63622		8C2Z-18124-D	G63622		8C2Z18124D	G63622	
8C24-18080-DB	G63623		8C2418080DB	G63623		8C2Z-18125-D	G63623		8C2Z18125D	G63623	

Important Note: Competitive Interchanges are to be used for stocking purposes only. Where multiple crosses are identified, please reference the applications section of this catalog. / **Remarque importante:** Les interchanges concurrentiels ne s'utilisent qu'aux fins de stocks. Dans le cas de rferences multiples, consulter la section des applications du catalogue. / **Nota importante:** Dans le cas de rferences multiples, consulter la section des applications du catalogue. / **Nota importante:** Se pueden usar intercambios competitivos para propósitos de almacenamiento solamente. Cuando se identifican intercambios múltiples, consulte la sección de aplicaciones de este catálogo.

COMPETITIVE & O.E.M. INTERCHANGE LIST

Lista de Intercambios contra Competidores y Equipo Original.

Liste d'interchange de produits compititifs & d'equipement original (OEM)

Diamond Coach... cont'd

Diamond coach	Gabriel	Upgrade	Diamond coach	Gabriel	Upgrade	Diamond coach	Gabriel	Upgrade	Diamond coach	Gabriel	Upgrade
ASH-1136	G63623		ASH1136	G63623		AT-163G	G63622		AT163G	G63622	
ASH-1154	G63622		ASH1154	G63622		AT-164G	G63623		AT164G	G63623	

DriveTech

Drivetech	Gabriel	Upgrade	Drivetech	Gabriel	Upgrade	Drivetech	Gabriel	Upgrade	Drivetech	Gabriel	Upgrade
D344049	81490		D344085	81484		D344367	81912		D344375	81913	
D344077	81082		D344087	81484		D344368	81914		D344376	81919	
D344077	81510		D344266	81726		D344371	81828		D344380	81920	
D344077	81710		D344267	81821		D344372	81928		D344383	81925	
D344081	81713		D344365	81873		D344374	81892		D344386	81921	

Dura Suspension

Dura suspension	Gabriel	Upgrade	Dura suspension	Gabriel	Upgrade	Dura suspension	Gabriel	Upgrade	Dura suspension	Gabriel	Upgrade
665267	85029		A-2212	85029		A2212	85029				

Dutchmen RV

Dutchmen rv	Gabriel	Upgrade	Dutchmen rv	Gabriel	Upgrade	Dutchmen rv	Gabriel	Upgrade	Dutchmen rv	Gabriel	Upgrade
8C24-18045-DA	G63622		8C2Z-18124-D	G63622		ASH-1136	G63623		AT-163G	G63622	
8C24-18080-DB	G63623		8C2Z-18125-D	G63623		ASH-1154	G63622		AT-164G	G63623	
8C2418045DA	G63622		8C2Z18124D	G63622		ASH1136	G63623		AT163G	G63622	
8C2418080DB	G63623		8C2Z18125D	G63623		ASH1154	G63622		AT164G	G63623	

Dynamax Corp.

Dynamax corp.	Gabriel	Upgrade	Dynamax corp.	Gabriel	Upgrade	Dynamax corp.	Gabriel	Upgrade	Dynamax corp.	Gabriel	Upgrade
10-12390-000	85920	89503	1013634000	85918	89449	471700131155	85918	89449	ASH-1136	G63623	
10-13021-000	85918	89449	1013684000	85918	89449	481700006848	85724	89443	ASH-1154	G63622	
10-13063-000	85918	89449	1013760000	85959		680611	85724	89443	ASH1136	G63623	
10-13211-000	85918	89449	16-15817-000	85724	89443	8C24-18045-DA	G63622		ASH1154	G63622	
10-13634-000	85918	89449	16-18708-000	85724	89443	8C24-18080-DB	G63623		AT-163G	G63622	
10-13684-000	85918	89449	1615817000	85724	89443	8C2418045DA	G63622		AT-164G	G63623	
10-13760-000	85959		1618708000	85724	89443	8C2418080DB	G63623		AT163G	G63622	
1012390000	85920	89503	471700000449	85918	89449	8C2Z-18124-D	G63622		AT164G	G63623	
1013021000	85918	89449	471700002808	85724	89443	8C2Z-18125-D	G63623		SDA471700002809	85724	89443
1013063000	85918	89449	471700002809	85724	89443	8C2Z18124D	G63622		SDA471700002991	85959	
1013211000	85918	89449	471700002991	85959		8C2Z18125D	G63623				

Eagle Motor Coach

Eagle motor coach	Gabriel	Upgrade	Eagle motor coach	Gabriel	Upgrade	Eagle motor coach	Gabriel	Upgrade	Eagle motor coach	Gabriel	Upgrade
154-0100-514	85314	89425	1540100514	85314	89425						

East Manufacturing Corp.

East manufacturing corp.	Gabriel	Upgrade	East manufacturing corp.	Gabriel	Upgrade	East manufacturing corp.	Gabriel	Upgrade	East manufacturing corp.	Gabriel	Upgrade
517-05001-23	85005	89430	517-05009-14	83125		5170500123	85005	89430	5170500914	83125	
517-05006-20	85030	89440	517-05806-20	85029		5170500620	85030	89440	5170580620	85029	

Eldorado National

Eldorado national	Gabriel	Upgrade	Eldorado national	Gabriel	Upgrade	Eldorado national	Gabriel	Upgrade	Eldorado national	Gabriel	Upgrade
8C24-18045-DA	G63622		8C2Z-18124-D	G63622		ASH-1136	G63623		AT-163G	G63622	
8C24-18080-DB	G63623		8C2Z-18125-D	G63623		ASH-1154	G63622		AT-164G	G63623	
8C2418045DA	G63622		8C2Z18124D	G63622		ASH1136	G63623		AT163G	G63622	
8C2418080DB	G63623		8C2Z18125D	G63623		ASH1154	G63622		AT164G	G63623	

Emergency One

Emergency one	Gabriel	Upgrade	Emergency one	Gabriel	Upgrade	Emergency one	Gabriel	Upgrade	Emergency one	Gabriel	Upgrade
90-2572	85329										

Entegra Coach

Entegra coach	Gabriel	Upgrade	Entegra coach	Gabriel	Upgrade	Entegra coach	Gabriel	Upgrade	Entegra coach	Gabriel	Upgrade
1C34-18045-AA	83209	89414	8C2Z-18124-D	G63622		9U9Z-18124-A	83209	89414	ASH-1161	85006	
1C34-18045-JA	83209	89414	8C2Z-18125-D	G63623		9U9Z-18125-A	83122	89406	ASH-1162	85005	89430
1C3418045AA	83209	89414	8C2Z18124D	G63622		9U9Z18124A	83209	89414	ASH-1205	83209	89414
1C3418045JA	83209	89414	8C2Z18125D	G63623		9U9Z18125A	83122	89406	ASH-1206	83122	89406
8C24-18045-DA	G63622		9U94-18045-AA	83209	89414	ASH-1022	83209	89414			
8C24-18080-DB	G63623		9U94-18080-AA	83122	89406	ASH-1023	83122	89406			
8C2418045DA	G63622		9U9418045AA	83209	89414	ASH-1136	G63623				
8C2418080DB	G63623		9U9418080AA	83122	89406	ASH-1154	G63622				

Important Note: Competitive Interchanges are to be used for stocking purposes only. Where multiple crosses are identified, please reference the applications section of this catalog. / **Remarque importante:** Les interchanges concurrentiels ne s'utilisent qu'aux fins de stocks. Dans le cas de rfrences multiples, consulter la section des applications du catalogue. / **Nota importante:** Dans le cas de rfrences multiples, consulter la section des applications du catalogue. / **Nota importante:** Se pueden usar intercambios competitivos para propósitos de almacenamiento solamente. Cuando se identifican intercambios múltiples, consulte la sección de aplicaciones de este catálogo.

COMPETITIVE & O.E.M. INTERCHANGE LIST
Lista de Intercambios contra Competidores y Equipo Original.
Liste d'interchange de produits comptitifs & d'equipement original (OEM)

Entegra Coach... cont'd

Entegra coach	Gabriel	Upgrade	Entegra coach	Gabriel	Upgrade	Entegra coach	Gabriel	Upgrade	Entegra coach	Gabriel	Upgrade
ASH-1228	83209	89414	ASH1022	83209	89414	ASH1230	83122	89406	AT-620	83209	89414
ASH-1229	83209	89414	ASH1023	83122	89406	ASH137	83122	89406	AT-621	83122	89406
ASH-1230	83122	89406	ASH1136	G63623		ASH25820	85005	89430	AT-766	83209	89414
ASH-137	83122	89406	ASH1154	G63622		ASH25821	85006		AT163G		G63622
ASH-25820	85005	89430	ASH1161	85006		ASH25822	83209	89414	AT164G		G63623
ASH-25821	85006		ASH1162	85005	89430	ASH25823	83209	89414	AT620	83209	89414
ASH-25822	83209	89414	ASH1205	83209	89414	ASH25824	83122	89406	AT621	83122	89406
ASH-25823	83209	89414	ASH1206	83122	89406	ASH294	83209	89414	AT766	83209	89414
ASH-25824	83122	89406	ASH1228	83209	89414	AT-163G		G63622			
ASH-294	83209	89414	ASH1229	83209	89414	AT-164G		G63623			

Euclid

Euclid	Gabriel	Upgrade	Euclid	Gabriel	Upgrade	Euclid	Gabriel	Upgrade	Euclid	Gabriel	Upgrade
E14045	83143		E83221	83221		E85001	85001	89410	E85029	85029	
E14046	83142		E83225	83225		E85005	85005	89430	E85030	85030	89440
E83205	83209	89414	E83308	83308		E85006	85006		E85302	85302	89420
E83209	83209	89414	E83309	83309		E85007	85007		E85310	85310	89423
E83215	83215		E83310	83221		E85010	85010		E85311	85311	89424
E83216	83216		E83312	83312	89409	E85012	85012	89413	E85314	85314	89425
E83218	83122	89406	E83314	83314		E85013	85013	89414			

FCS

Fcs	Gabriel	Upgrade	Fcs	Gabriel	Upgrade	Fcs	Gabriel	Upgrade	Fcs	Gabriel	Upgrade
341511	81668		342529	81921		F347200	85072		F347276	85923	89458
341512	81713		342549	81676		F347203	83127		F347277	83148	
341514	81490		342549	82007		F347206	85029		F347280	85010	
341520	82155		342565	81873		F347212	83125		F347293	83024	
341568	81744		342567	81496		F347215	85067	89451	F347296	83006	
341575	81713		342780	81484		F347219	85006		F347300	85989	
341576	81744		342781	81113		F347222	83021		F347302	85656	
341577	81744		342838	81676		F347224	85919		F347304	83163	
341578	81912		343308	81270		F347226	85012	89413	F347306	85909	
341579	81914		DT347071	77412		F347232	85959		F347309	83122	89406
341582	81828		F343368	85069	89455	F347233	85070	89459	F347310	85031	
341584	81892		F343372	83136		F347235	85978		F347313	83140	
341585	81913		F343373	83456	89447	F347236	83137		F347314	85301	
341597	81920		F343375	85310	89423	F347238	85331		F347314	85302	89420
341598	81925		F343376	85900		F347239	85976		F347315	83126	89430
341599	81920		F343378	85902		F347241	85928		F347317	83166	
341639	81928		F343382	83613		F347242	85957		F347319	83221	
341641	81919		F344342	85936	89456	F347243	83209	89414	F347319	85071	
341645	81096		F344353	83142		F347244	85043		F347321	85007	
342462	81726		F344355	83143		F347247	83135		F347323	83101	
342466	81667		F344356	83154		F347248	83123	89405	F347325	83312	89409
342467	81039		F346598	85033	89427	F347249	85084	89460	F347333	83215	
342467	81496		F346599	85311	89424	F347253	83025		F347337	83309	
342480	81147		F346632	83317		F347260	85724	89443	F347342	83169	
342486	81147		F346633	85988		F347261	85918	89449	F347347	83519	
342496	81821		F346634	83515		F347263	85001	89410	F347348	83391	
342501	81082		F346635	83518		F347268	85920	89503	F347353	83364	
342501	81510		F346636	83395		F347269	85013	89414	F347356	85650	
342501	81710		F346637	85649		F347270	85005	89430			
342512	81710		F347193	85030	89440	F347272	85932	89453			
342527	81873		F347198	85058	89431	F347274	85956				

Federal Coach

Federal coach	Gabriel	Upgrade	Federal coach	Gabriel	Upgrade	Federal coach	Gabriel	Upgrade	Federal coach	Gabriel	Upgrade
10-12388-000	85920	89503	1012388000	85920	89503	16-18708-000	85724	89443			
10-12390-000	85920	89503	1012390000	85920	89503	1618708000	85724	89443			
10-13760-000	85959		1013760000	85959							

Important Note: Competitive Interchanges are to be used for stocking purposes only. Where multiple crosses are identified, please reference the applications section of this catalog. / **Remarque importante:** Les interchanges concurrentiels ne s'utilisent qu'aux fins de stocks. Dans le cas de rferences multiples, consulter la section des applications du catalogue. / **Nota importante:** Dans le cas de rferences multiples, consulter la section des applications du catalogue. / **Nota importante:** Se pueden usar intercambios competitivos para propósitos de almacenamiento solamente. Cuando se identifican intercambios múltiples, consulte la sección de aplicaciones de este catálogo.

COMPETITIVE & O.E.M. INTERCHANGE LIST

Lista de Intercambios contra Competidores y Equipo Original.

Liste d'interchange de produits compititifs & d'equpement original (OEM)

Federal Coach... cont'd

Federal coach	Gabriel	Upgrade	Federal coach	Gabriel	Upgrade	Federal coach	Gabriel	Upgrade	Federal coach	Gabriel	Upgrade
471700002809	85724	89443	ASH-1136	G63623		ASH1136	G63623		SDA471700002991	85959	
471700002991	85959		ASH-1154	G63622		ASH1154	G63622				

Fleetrite

Fleetrite	Gabriel	Upgrade	Fleetrite	Gabriel	Upgrade	Fleetrite	Gabriel	Upgrade	Fleetrite	Gabriel	Upgrade
AMS600102	85005	89430	AMS650118	83215		AMS65109	85058	89431	AMS660190	83107	
AMS600106	83312	89409	AMS650119	85029		AMS65144	85957		AMS660191	83216	
AMS600107	83309		AMS650120	85010		AMS660102	85005	89430	AMS660192	85001	89410
AMS600108	83209	89414	AMS650122	85063		AMS660106	83312	89409	AMS660196	G63610	
AMS600112	83456	89447	AMS650123	85054		AMS660107	83309		AMS660201	83308	
AMS600113	83215		AMS650128	85031		AMS660108	83209	89414	AMS660213	85009	
AMS600114	83125		AMS650139	85918	89449	AMS660112	83456	89447	AMS660216	83123	89405
AMS600116	83216		AMS650400	85033	89427	AMS660113	83215		AMS660218	83137	
AMS600117	83308		AMS650401	85013	89414	AMS660114	85006		AMS660219	83215	
AMS600119	83314		AMS650402	85311	89424	AMS660116	83216		AMS660232	83114	
AMS600120	G63605		AMS650404	85310	89423	AMS660117	83308		AMS660236	83025	
AMS600123	G63183		AMS650412	83122	89406	AMS660118	85012	89413	AMS660238	83101	
AMS600125	83123	89405	AMS650420	85013	89414	AMS660119	83314		AMS660244	83125	
AMS600129	83317		AMS650426	85054		AMS660120	G63605		AMS700103	85302	89420
AMS600132	83215		AMS650429	85030	89440	AMS660123	G63183		AMS700105	85314	89425
AMS600134	83221		AMS650431	85909		AMS660125	83123	89405	AMS700106	85301	
AMS600142	83209	89414	AMS650432	85910		AMS660129	83317		AMS700116	83136	
AMS600147	83216		AMS650433	85910		AMS660132	83215		AMS700120	85332	
AMS600150	85009		AMS650434	85012	89413	AMS660134	83221		AMS700121	83136	
AMS600157	83221		AMS650436	85900		AMS660142	83209	89414	AMS700402	85310	89423
AMS600163	83101		AMS650444	85311	89424	AMS660147	83216		AMS700404	85311	89424
AMS600164	83613		AMS650451	85029		AMS660157	85030	89440	AMS700410	85314	89425
AMS600172	85005	89430	AMS650453	85043		AMS660160	83114		AMS700423	85724	89443
AMS600173	85043		AMS650455	85716		AMS660161	G63610		AMS85768	83209	89414
AMS600174	83125		AMS650456	85376		AMS660164	83613		AMS85802	83216	
AMS600175	83120		AMS650459	85043		AMS660172	83126	89430	AMS85803	G63306	
AMS650102	85001	89410	AMS650464	85716		AMS660173	85043		AMS85821	G63406	
AMS650108	85030	89440	AMS650468	85069	89455	AMS660174	83125		AMS85853	G63183	
AMS650109	85058	89431	AMS650471	85302	89420	AMS660175	83120		AMS85900	G63386	
AMS650110	85005	89430	AMS650478	85030	89440	AMS660179	83162		AMS85901	G63387	
AMS650111	85006		AMS650479	83122	89406	AMS660183	85012	89413	AMS85904	G63299	
AMS650113	85012	89413	AMS650481	83123	89405	AMS660187	85071		AMS85905	G63405	
AMS650114	85006		AMS650482	85006		AMS660189	83136		AMS85960	G63366	

Fleetwood

Fleetwood	Gabriel	Upgrade	Fleetwood	Gabriel	Upgrade	Fleetwood	Gabriel	Upgrade	Fleetwood	Gabriel	Upgrade
141700131809	85029		481700000493	85900		ASH-1023	83122	89406	ASH1023	83122	89406
141700131810	83160		8C24-18045-DA	G63622		ASH-1136	G63623		ASH1136	G63623	
16-16736-000	85029		8C24-18080-DB	G63623		ASH-1154	G63622		ASH1154	G63622	
16-16737-000	83160		8C2418045DA	G63622		ASH-1161	85006		ASH1161	85006	
16-16873-000	85029		8C2418080DB	G63623		ASH-1162	85005	89430	ASH1162	85005	89430
16-16874-000	83160		8C2Z-18124-D	G63622		ASH-1205	83209	89414	ASH1205	83209	89414
16-18103-000	85900		8C2Z-18125-D	G63623		ASH-1206	83122	89406	ASH1206	83122	89406
1616736000	85029		8C2Z18124D	G63622		ASH-1228	83209	89414	ASH1228	83209	89414
1616737000	83160		8C2Z18125D	G63623		ASH-1229	83209	89414	ASH1229	83209	89414
1616873000	85029		9U94-18045-AA	83209	89414	ASH-1230	83122	89406	ASH1230	83122	89406
1616874000	83160		9U94-18080-AA	83122	89406	ASH-137	83122	89406	ASH137	83122	89406
1618103000	85900		9U9418045AA	83209	89414	ASH-25820	85005	89430	ASH25820	85005	89430
1C34-18045-AA	83209	89414	9U9418080AA	83122	89406	ASH-25821	85006		ASH25821	85006	
1C34-18045-JA	83209	89414	9U9Z-18124-A	83209	89414	ASH-25822	83209	89414	ASH25822	83209	89414
1C3418045AA	83209	89414	9U9Z-18125-A	83122	89406	ASH-25823	83209	89414			
1C3418045JA	83209	89414	9U9Z18124A	83209	89414	ASH-25824	83122	89406			
24-153256	85124		9U9Z18125A	83122	89406	ASH-294	83209	89414			
24153256	85124		ASH-1022	83209	89414	ASH1022	83209	89414			

Important Note: Competitive Interchanges are to be used for stocking purposes only. Where multiple crosses are identified, please reference the applications section of this catalog. / **Remarque importante:** Les interchanges concurrentiels ne s'utilisent qu'aux fins de stocks. Dans le cas de rfrences multiples, consulter la section des applications du catalogue. / **Nota importante:** En el caso de rfrences multiples, consultar la seccion de aplicaciones del catalogo. / **Nota importante:** Se pueden usar intercambios competitivos para propósitos de almacenamiento solamente. Cuando se identifican intercambios mltiples, consulte la seccion de aplicaciones de este catalogo.

COMPETITIVE & O.E.M. INTERCHANGE LIST
Lista de Intercambios contra Competidores y Equipo Original.
Liste dinterchange de produits comptitifs & dquipement original (OEM)

Fleetwood... cont'd

Fleetwood	Gabriel	Upgrade	Fleetwood	Gabriel	Upgrade	Fleetwood	Gabriel	Upgrade	Fleetwood	Gabriel	Upgrade
ASH25823	83209	89414	AT-164G	G63623		AT163G	G63622		AT766	83209	89414
ASH25824	83122	89406	AT-620	83209	89414	AT164G	G63623		F4-BE5-F325-HO	85124	
ASH294	83209	89414	AT-621	83122	89406	AT620	83209	89414	F4BE5F325HO	85124	
AT-163G	G63622		AT-766	83209	89414	AT621	83122	89406	W0005663	85124	

FLXIBLE Bus

Flxible bus	Gabriel	Upgrade	Flxible bus	Gabriel	Upgrade	Flxible bus	Gabriel	Upgrade	Flxible bus	Gabriel	Upgrade
680029	85301		97-9999-02636	85716		97999902636	85716				
97-9999-02633	85311	89424	97999902633	85311	89424						

Ford

Ford	Gabriel	Upgrade	Ford	Gabriel	Upgrade	Ford	Gabriel	Upgrade	Ford	Gabriel	Upgrade
1201-1043	83025		3U2Z18124YAA	G63809		4C4Z-18124-JB	85928		5U2Z-18V125-BDA	G63623	
1201-1044	83025		3U2Z18125CA	G63607		4C4Z-18124-KA	85976		5U2Z-18V125-BGA	G63778	
12011043	83025		3U2Z18125RA	G63623		4C4Z-18124-LA	85976		5U2Z-18V125-BS	G63607	
12011044	83025		47 1700 007 203	85013	89414	4C4Z-18124-M	85656		5U2Z-18V125-G	G63837	
1202-0042	83025		471700007117	85010		4C4Z-18124-P	83135		5U2Z-18V125-H	G63406	
1202-1043	83025		471700009775	85010		4C4Z-18124-PA	83175		5U2Z-3V651-C	6828SE	
1202-1044	83025		471700011530	85181		4C4Z-18124-RA	85928		5U2Z18V124AA	G63714	
12020042	83025		471700011531	85180		4C4Z-18125-AB	83101		5U2Z18V124AHA	G63622	
12021043	83025		47902-13	83122	89406	4C4Z-18125-B	83317		5U2Z18V124BA	G63716	
12021044	83025		47902-28	85013	89414	4C4Z-18125-CA	85976		5U2Z18V124CAA	G63809	
1C34-18045-AA	83209	89414	47902-8	83122	89406	4C4Z-18125-DA	85656		5U2Z18V124DB	G63455	
1C34-18045-JA	83209	89414	4790213	83122	89406	4C4Z18124AB	83163		5U2Z18V124GA	G63809	
1C3418045AA	83209	89414	4790228	85013	89414	4C4Z18124BB	83135		5U2Z18V125AE	G63808	
1C3418045JA	83209	89414	479028	83122	89406	4C4Z18124CB	85957		5U2Z18V125AF	G63810	
1C44-18080-AA	83123	89405	4C4O-18045-AA	83163		4C4Z18124DC	85927		5U2Z18V125BDA	G63623	
1C4418080AA	83123	89405	4C4O-18045-BB	83135		4C4Z18124EA	85656		5U2Z18V125BGA	G63778	
2C44-18045-BA	83175		4C4O-18045-CA	85957		4C4Z18124GB	83175		5U2Z18V125BS	G63607	
2C4418045BA	83175		4C4O-18045-DB	85927		4C4Z18124HB	83135		5U2Z18V125G	G63837	
2C4Z-18124-BA	83175		4C4O-18045-EA	85656		4C4Z18124JB	85928		5U2Z18V125H	G63406	
2C4Z18124BA	83175		4C4O-18045-GA	83175		4C4Z18124KA	85976		60670-008	83123	89405
2C7Z-18125-AA	G63837		4C4O-18045-HA	83135		4C4Z18124LA	85976		60670-008L	83123	89405
2C7Z-18125-CA	G63607		4C4O-18045-JA	85928		4C4Z18124M	85656		60670-011	83148	
2C7Z18125AA	G63837		4C4O-18045-KA	85976		4C4Z18124P	83135		60670-012	83168	
2C7Z18125CA	G63607		4C4O-18045-LA	85976		4C4Z18124QA	83175		60670008	83123	89405
3553628C1	85927		4C4O-18045-MA	85656		4C4Z18124RA	85928		60670008L	83123	89405
3553628C2	85927		4C4O-18080-AA	83101		4C4Z18125AB	83101		60670011	83148	
3578858C1	85656		4C4O-18080-BA	83317		4C4Z18125B	83317		60670012	83168	
3578858C2	85656		4C4O18045AA	83163		4C4Z18125CA	85976		60675-003	85976	
3584116C1	83175		4C4O18045BB	83135		4C4Z18125DA	85656		60675-003L	85976	
3584116C2	83175		4C4O18045CA	85957		501906C91	83317		60675-014	85978	
3584117C2	83135		4C4O18045DB	85927		501906C92	83317		60675003	85976	
3584118C2	85928		4C4O18045EA	85656		57365-111	85006		60675003L	85976	
3U2Z-18124-BAA	G63809		4C4O18045GA	83175		57365111	85006		60675014	85978	
3U2Z-18124-BV	G63614		4C4O18045HA	83135		5C3Z-18124-JA	G63969		680029	85301	
3U2Z-18124-BW	G63614		4C4O18045JA	85928		5C3Z-18125-CF	77969		6E7O-18B038-AA	83364	
3U2Z-18124-FAA	G63809		4C4O18045KA	85976		5C3Z-18125-DA	77968		6E7O18B038AA	83364	
3U2Z-18124-JAA	G63614		4C4O18045LA	85976		5C3Z18124JA	G63969		6E7Z-18124-AB	83364	
3U2Z-18124-MAA	83131		4C4O18045MA	85656		5C3Z18125CF	77969		6E7Z18124AB	83364	
3U2Z-18124-YAA	G63809		4C4O18080AA	83101		5C3Z18125DA	77968		6ETZ-18125-A	83364	
3U2Z-18125-CA	G63607		4C4O18080BA	83317		5U2Z-18V124-AA	G63714		6ETZ18125A	83364	
3U2Z-18125-RA	G63623		4C4Z-18124-AB	83163		5U2Z-18V124-AHA	G63622		6U2Z-18V125-B	G63607	
3U2Z18124BAA	G63809		4C4Z-18124-BB	83135		5U2Z-18V124-BA	G63716		6U2Z18V125A	G63837	
3U2Z18124BV	G63614		4C4Z-18124-CB	85957		5U2Z-18V124-CAA	G63809		6U2Z18V125B	G63607	
3U2Z18124BW	G63614		4C4Z-18124-DC	85927		5U2Z-18V124-DB	G63455				
3U2Z18124FAA	G63809		4C4Z-18124-EA	85656		5U2Z-18V124-GA	G63809				
3U2Z18124JAA	G63614		4C4Z-18124-GB	83175		5U2Z-18V125-AE	G63808				
3U2Z18124MAA	83131		4C4Z-18124-HB	83135		5U2Z-18V125-AF	G63810				

Important Note: Competitive Interchanges are to be used for stocking purposes only. Where multiple crosses are identified, please reference the applications section of this catalog. / **Remarque importante:** Les interchanges concurrentiels ne s'utilisent qu'aux fins de stocks. Dans le cas de rferences multiples, consulter la section des applications du catalogue. / **Nota importante:** Dans le cas de rferences multiples, consulter la section des applications du catalogue. / **Nota importante:** Se pueden usar intercambios competitivos para propósitos de almacenamiento solamente. Cuando se identifican intercambios múltiples, consulte la sección de aplicaciones de este catálogo.

COMPETITIVE & O.E.M. INTERCHANGE LIST
Lista de Intercambios contra Competidores y Equipo Original.
Liste dinterchange de produits comptitifs & dquipement original (OEM)

Ford... cont'd

Ford	Gabriel	Upgrade	Ford	Gabriel	Upgrade	Ford	Gabriel	Upgrade	Ford	Gabriel	Upgrade
70127	85006		ASH-1206	83122	89406	ASH23488	G63461		B8QZ18124A	83312	89409
70128	85006		ASH-12251	85013	89414	ASH24446	83215		BC3Z-18124-AC	77967	
7C34-18045-HB	G63969		ASH-12261	85010		ASH2447	83140		BC3Z-18125-AP	77969	
7C34-18080-DCB	77968		ASH-1228	83209	89414	ASH24473	85013	89414	BC3Z-18125-AQ	77969	
7C3418045HB	G63969		ASH-1229	83209	89414	ASH24474	85010		BC3Z-18125-F	61682	
7C3418080DCB	77968		ASH-1230	83122	89406	ASH24522	85013	89414	BU2Z-18V124-E	83107	
87HU-18045-AA	85301		ASH-137	83122	89406	ASH24589	85010		BU2Z18V124E	83107	
87HU18045AA	85301		ASH-23486	G63461		ASH24634	85013	89414	BU9Z-18124-A	85013	89414
8C24-18045-DA	G63622		ASH-23488	G63461		ASH24658	85181		BU9Z-18125-A	85010	
8C24-18080-DB	G63623		ASH-24446	83215		ASH24659	85181		BU9Z18124A	85013	89414
8C2418045DA	G63622		ASH-2447	83140		ASH24660	85180		BU9Z18125A	85010	
8C2418045DA	G63625		ASH-24473	85013	89414	ASH24661	83317		C0TT-18045-D	83216	
8C2418080DB	G63623		ASH-24474	85010		ASH24662	83168		C0TT18045D	83216	
8C2Z-18124-D	G63622		ASH-24522	85013	89414	ASH24663	83148		C0TZ-18124-A	83216	
8C2Z-18125-A	G63623		ASH-24523	85010		ASH247	G63461		C0TZ18124A	83216	
8C2Z-18125-B	G63623		ASH-24589	85010		ASH25820	85005	89430	C1TT-18045-C	83312	89409
8C2Z-18125-C	G63623		ASH-24634	85013	89414	ASH25821	85006		C1TT-18045-D	G63406	
8C2Z-18125-D	G63623		ASH-24658	85181		ASH25822	83209	89414	C1TT-18045-E	83314	
8C2Z18124D	G63622		ASH-24659	85181		ASH25823	83209	89414	C1TT-18045-G	83216	
8C2Z18125A	G63623		ASH-24660	85180		ASH25824	83122	89406	C1TT18045C	83312	89409
8C2Z18125B	G63623		ASH-24661	83317		ASH25838	85978		C1TT18045D	G63406	
8C2Z18125C	G63623		ASH-24662	83168		ASH294	83209	89414	C1TT18045E	83314	
8C2Z18125D	G63623		ASH-24663	83148		ASH397	83131		C1TT18045G	83216	
8C3Z-3E651-E	14072		ASH-247	G63461		ASH722	85976		C1TZ-18045-C	83312	89409
90045132	85909		ASH-25770	77987		AT-163G	G63622		C1TZ-18124-B	83216	
9U94-18045-AA	83209	89414	ASH-25820	85005	89430	AT-164G	G63623		C1TZ-18124-C	83312	89409
9U94-18080-AA	83122	89406	ASH-25821	85006		AT-610	G63461		C1TZ-18124-D	83309	
9U9418045AA	83209	89414	ASH-25822	83209	89414	AT-611	G63461		C1TZ-18124-E	83312	89409
9U9418080AA	83122	89406	ASH-25823	83209	89414	AT-620	83209	89414	C1TZ-18124-F	83312	89409
9U9Z-18124-A	83209	89414	ASH-25824	83122	89406	AT-621	83122	89406	C1TZ-18124-N	83314	
9U9Z-18125-A	83122	89406	ASH-25838	85978		AT-696	83140		C1TZ-18124-P	83312	89409
9U9Z-18125-B	83122	89406	ASH-294	83209	89414	AT-766	83209	89414	C1TZ18045C	83312	89409
9U9Z18124A	83209	89414	ASH-397	83131		AT-811	83135		C1TZ18124B	83216	
9U9Z18124B	83209	89414	ASH-722	85976		AT-812	85928		C1TZ18124C	83312	89409
9U9Z18125A	83122	89406	ASH-85789	77986		AT163G	G63622		C1TZ18124D	83309	
9U9Z18125B	83122	89406	ASH-85856	77987		AT163G	G63623		C1TZ18124E	83312	89409
AA-494	83131		ASH-85857	77987		AT164G	G63623		C1TZ18124F	83312	89409
AA-615	83135		ASH-85927	77986		AT610	G63461		C1TZ18124N	83314	
AA-616	83175		ASH-866127	77986		AT611	G63461		C1TZ18124P	83312	89409
AA-617	85928		ASH-866139	77986		AT620	83209	89414	C2TA-18045-A	83216	
AA-619	85927		ASH1022	83209	89414	AT621	83122	89406	C2TA-18045-B	83308	
AA-620	83101		ASH1023	83122	89406	AT696	83140		C2TA18045A	83216	
AA494	83131		ASH1105	85976		AT766	83209	89414	C2TA18045B	83308	
AA615	83135		ASH1136	G63623		AT811	83135		C2TZ-18124-A	83308	
AA616	83175		ASH1154	G63622		AT812	85928		C2TZ18124A	83308	
AA617	85928		ASH1161	85006		AX-267A	83309		C3TA-18045-A	83216	
AA619	85927		ASH1162	85005	89430	AX-310	83215		C3TA18045A	83216	
AA620	83101		ASH1205	83209	89414	AX267A	83309		C3TZ-18124-A	83308	
ASH-1022	83209	89414	ASH1206	83122	89406	AX310	83215		C3TZ18124A	83308	
ASH-1023	83122	89406	ASH12251	85013	89414	B7T-18124-C	83225		C4HZ-18124-A	83312	89409
ASH-1105	85976		ASH12261	85010		B7T18124C	83225		C4HZ-18124-B	83309	
ASH-1136	G63623		ASH1228	83209	89414	B7TZ-18124-B	83216		C4HZ-18124-C	83314	
ASH-1154	G63622		ASH1229	83209	89414	B7TZ-18124-C	83216		C4HZ-18124-D	83312	89409
ASH-1161	85006		ASH1230	83122	89406	B7TZ18124B	83216		C4HZ-18124-E	83309	
ASH-1162	85005	89430	ASH137	83122	89406	B7TZ18124C	83216		C4HZ-18124-F	83308	
ASH-1205	83209	89414	ASH23486	G63461		B8QZ-18124-A	83312	89409	C4HZ18124A	83312	89409

Important Note: Competitive Interchanges are to be used for stocking purposes only. Where multiple crosses are identified, please reference the applications section of this catalog./ **Remarque importante:** Les interchanges concurrentiels ne s'utilisent qu'aux fins de stocks. Dans le cas de rfrences multiples, consulter la section des applications du catalogue./ **Nota importante:** Dans le cas de rfrences multiples, consultar la section des aplicaciones du catalogue./ **Nota importante:** Se pueden usar intercambios competitivos para propósitos de almacenamiento solamente. Cuando se identifican intercambios múltiples, consulte la sección de aplicaciones de este catálogo.

COMPETITIVE & O.E.M. INTERCHANGE LIST
Lista de Intercambios contra Competidores y Equipo Original.
Liste dinterchange de produits comptitifs & dquipement original (OEM)

Ford... cont'd

Ford	Gabriel	Upgrade	Ford	Gabriel	Upgrade	Ford	Gabriel	Upgrade	Ford	Gabriel	Upgrade
C4HZ18124B	83309		CU9Z-18125-A	85010		D2HZ-18125-A	83209	89414	D7HT-18045-JA	83308	
C4HZ18124C	83314		CU9Z18124A	85013	89414	D2HZ-18125-B	83209	89414	D7HT-18045-NA	85301	
C4HZ18124D	83312	89409	CU9Z18125A	85010		D2HZ18080A	83209	89414	D7HT-18080-BA	83225	
C4HZ18124E	83309		D0HA-18045-D	83309		D2HZ18125A	83209	89414	D7HT-18080-DA	83215	
C4HZ18124F	83308		D0HA-18045-E	83312	89409	D2HZ18125B	83209	89414	D7HT-18124-BA	83312	89409
C4PF-18045-H	83216		D0HA18045D	83309		D2KF-18045-AA	83312	89409	D7HT-18124-CA	83314	
C4PF18045H	83216		D0HA18045E	83312	89409	D2KF-18124-AA	83312	89409	D7HT-18124-DA	83309	
C4TZ-18124-AA	83308		D0HZ-18124-A	83309		D2KF18045AA	83312	89409	D7HT-18124-EA	83312	89409
C4TZ-18124-AB	83308		D0HZ-18124-B	83312	89409	D2KF18124AA	83312	89409	D7HT-18124-FA	83312	89409
C4TZ-18124-B	83308		D0HZ-18124-C	83314		D2TF-18045-AA	83312	89409	D7HT-18124-GA	83308	
C4TZ18124AA	83308		D0HZ18124A	83309		D2TF-18045-FA	83312	89409	D7HT-18124-JA	83308	
C4TZ18124AB	83308		D0HZ18124B	83312	89409	D2TF-18045-GA	83308		D7HT-18124-KA	85301	
C4TZ18124B	83308		D0HZ18124C	83314		D2TF-18080-HA	83225		D7HT-18125-DA	83215	
C5TZ-18124-A	83308		D1TF-18045-LA	83312	89409	D2TF-18124-F	83309		D7HT-18125-FA	83123	89405
C5TZ18124A	83308		D1TF18045LA	83312	89409	D2TF18045AA	83312	89409	D7HT18045BA	83312	89409
C6PF-18077-A	G63306		D1TZ-18124-D	83308		D2TF18045FA	83312	89409	D7HT18045CA	83314	
C6PF-18077-DD	83216		D1TZ-18124-E	83216		D2TF18045GA	83308		D7HT18045DA	83309	
C6PF-18077-DL	83312	89409	D1TZ-18124-F	83312	89409	D2TF18080HA	83225		D7HT18045EA	83312	89409
C6PF-18077-DN	83314		D1TZ18124D	83308		D2TF18124F	83309		D7HT18045GA	83308	
C6PF-18077-F	83225		D1TZ18124E	83216		D2TZ-18124-A	83308		D7HT18045JA	83308	
C6PF18077A	G63306		D1TZ18124F	83312	89409	D2TZ-18124-E	83312	89409	D7HT18045NA	85301	
C6PF18077DD	83216		D2EF-18045-AA	83312	89409	D2TZ-18124-F	83309		D7HT18080BA	83225	
C6PF18077DL	83312	89409	D2EF-18124-AA	83312	89409	D2TZ-18124-G	83314		D7HT18080DA	83215	
C6PF18077DN	83314		D2EF18045AA	83312	89409	D2TZ-18124-H	83308		D7HT18124BA	83312	89409
C6PF18077F	83225		D2EF18124AA	83312	89409	D2TZ-18124-J	83312	89409	D7HT18124CA	83314	
C6TA-18045-U	85301		D2HA-18045-EB	85301		D2TZ18124A	83308		D7HT18124DA	83309	
C6TA-18045-V	85301		D2HA-18045-F1A	85301		D2TZ18124E	83312	89409	D7HT18124EA	83312	89409
C6TA-18045-Y	85301		D2HA-18045-F1B	85301		D2TZ18124F	83309		D7HT18124FA	83312	89409
C6TA-18045-Z	85301		D2HA-18045-F2A	85301		D2TZ18124G	83314		D7HT18124GA	83308	
C6TA18045U	85301		D2HA-18045-F2B	85301		D2TZ18124H	83308		D7HT18124JA	83308	
C6TA18045V	85301		D2HA18045EB	85301		D2TZ18124J	83312	89409	D7HT18124KA	85301	
C6TA18045Y	85301		D2HA18045F1A	85301		D4HA-18080-A	83209	89414	D7HT18125DA	83215	
C6TA18045Z	85301		D2HA18045F1B	85301		D4HA-18080-AA	83209	89414	D7HT18125FA	83123	89405
C6TZ-18124-D	85301		D2HA18045F2A	85301		D4HA18080A	83209	89414	D7HZ-18125-A	83215	
C6TZ-18124-E	85301		D2HA18045F2B	85301		D4HA18080AA	83209	89414	D7HZ18125A	83215	
C6TZ-18124-H	85301		D2HF-18045-A	83314		D4TF-18045-AA	83312	89409	D7KF-18045-EA	83312	89409
C6TZ-18124-J	85301		D2HF-18045-AA	83314		D4TF18045AA	83312	89409	D7KF18045EA	83312	89409
C6TZ18124D	85301		D2HF-18045-BA	83309		D4TZ-18124-J	83308		D7TA-18124-GA	83314	
C6TZ18124E	85301		D2HF-18045-CA	83308		D4TZ18124J	83308		D7TA18124GA	83314	
C6TZ18124H	85301		D2HF-18045-DA	83312	89409	D5TZ-18124-B	83308		D8HZ-18124-A	85301	
C6TZ18124J	85301		D2HF-18124-AA	83314		D5TZ-18124-C	83312	89409	D8HZ-18125-A	83209	89414
C7HZ-18124-A	83312	89409	D2HF18045A	83314		D5TZ18124B	83308		D8HZ-18125-B	83123	89405
C7HZ18124A	83312	89409	D2HF18045AA	83314		D5TZ18124C	83312	89409	D8HZ18124A	85301	
C7PF-18077-A	83225		D2HF18045BA	83309		D7HA-18080-AA	83123	89405	D8HZ18125A	83209	89414
C7PF18077A	83225		D2HF18045CA	83308		D7HA18080AA	83123	89405	D8HZ18125B	83123	89405
C7TA-18045-R	83216		D2HF18045DA	83312	89409	D7HF-18045-FA	83312	89409	DU94-18045-CB	85013	89414
C7TA-18045-Z	85301		D2HF18124AA	83314		D7HF-18080-AA	83215		DU94-18080-CA	85010	
C7TA18045R	83216		D2HT-18045-CA	83314		D7HF-18125-AA	83215		DU94-18080-CB	85010	
C7TA18045Z	85301		D2HT-18045-EA	83312	89409	D7HF18045FA	83312	89409	DU9418080CA	85010	
C8HA-18045-A	83312	89409	D2HT-18045-GA	83308		D7HF18080AA	83215		DU9418080CB	85010	
C8HA18045A	83312	89409	D2HT-18080-HA	83225		D7HF18125AA	83215		DU9Z-18124-A	85013	89414
C8PF-18045-CM	83216		D2HT18045CA	83314		D7HT-18045-BA	83312	89409	DU9Z-18124-B	85013	89414
C8PF18045CM	83216		D2HT18045EA	83312	89409	D7HT-18045-CA	83314		DU9Z-18125-A	85010	
C8TA-18045-AA	G63386		D2HT18045GA	83308		D7HT-18045-DA	83309		DU9Z-18125-B	85010	
C8TA18045AA	G63386		D2HT18080HA	83225		D7HT-18045-EA	83312	89409	DU9Z18124A	85013	89414
CU9Z-18124-A	85013	89414	D2HZ-18080-A	83209	89414	D7HT-18045-GA	83308		DU9Z18124B	85013	89414

Important Note: Competitive Interchanges are to be used for stocking purposes only. Where multiple crosses are identified, please reference the applications section of this catalog. / **Remarque importante:** Les interchanges concurrentiels ne s'utilisent qu'aux fins de stocks. Dans le cas de rferences multiples, consulter la section des applications du catalogue. / **Nota importante:** Dans le cas de rferences multiples, consulter la section des applications du catalogue. / **Nota importante:** Se pueden usar intercambios competitivos para propósitos de almacenamiento solamente. Cuando se identifican intercambios múltiples, consulte la sección de aplicaciones de este catálogo.

COMPETITIVE & O.E.M. INTERCHANGE LIST
Lista de Intercambios contra Competidores y Equipo Original.
Liste dinterchange de produits comptitifs & dquipement original (OEM)

Ford... cont'd

Ford	Gabriel	Upgrade	Ford	Gabriel	Upgrade	Ford	Gabriel	Upgrade	Ford	Gabriel	Upgrade
DU9Z18125A	85010		F0HT-18080-AA	83122	89406	F2HZ18124A	85376		F5UZ-18124-A	G63622	
DU9Z18125B	85010		F0HT18045AA	85006		F2HZ18124B	85301		F5UZ-18124-B	G63622	
E0HT-18045-AA	83309		F0HT18045CA	85006		F2HZ18124C	85006		F5UZ-18125-A	G63623	
E0HT-18045-AB	83309		F0HT18080AA	83122	89406	F2HZ18124CA	85006		F5UZ18124A	G63622	
E0HT18045AA	83309		F0HZ-18124-A	85006		F4HT-18045-AB	83314		F5UZ18124B	G63622	
E0HT18045AB	83309		F0HZ-18124-B	85006		F4HT-18045-AC	83314		F5UZ18125A	G63623	
E0HZ-18124-A	83309		F0HZ-18125-A	83122	89406	F4HT-18045-CB	83107		F6HT-18045-AA	85054	
E0HZ18124A	83309		F0HZ18124A	85006		F4HT-18045-DA	85063		F6HT-18045-AC	85054	
E1TA-18045-AA	83309		F0HZ18124B	85006		F4HT-18045-EA	83125		F6HT-18045-GB	85030	89440
E1TA18045AA	83309		F0HZ18125A	83122	89406	F4HT-18080-AA	85314	89425	F6HT-18045-GC	85030	89440
E1TD-18045-AA	83309		F1HT-18045-AA	83309		F4HT-18080-AB	85314	89425	F6HT-18045-HB	85054	
E1TD18045AA	83309		F1HT-18045-CA	83308		F4HT-18080-BA	85001	89410	F6HT-18045-HC	85054	
E5HT-18045-AA	85301		F1HT-18045-CB	83216		F4HT18045AB	83314		F6HT-18045-LA	85376	
E5HT-18045-DA	85301		F1HT-18045-DA	83312	89409	F4HT18045AC	83314		F6HT-18045-MA	85006	
E5HT-18045-EA	85301		F1HT-18045-DB	83308		F4HT18045CB	83107		F6HT-18080-CA	85314	89425
E5HT18045AA	85301		F1HT-18045-GA	85006		F4HT18045DA	85063		F6HT-18080-FC	85013	89414
E5HT18045DA	85301		F1HT-18045-GB	85006		F4HT18045EA	83125		F6HT18045AA	85054	
E5HT18045EA	85301		F1HT-18045-HB	85006		F4HT18080AA	85314	89425	F6HT18045AC	85054	
E6HT-18080-AA	83215		F1HT-18045-KB	85006		F4HT18080AB	85314	89425	F6HT18045GB	85030	89440
E6HT18080AA	83215		F1HT-18045-LB	85006		F4HT18080BA	85001	89410	F6HT18045GC	85030	89440
E6HZ-18124-A	85301		F1HT18045AA	83309		F4TA-18045-TA	G63455		F6HT18045HB	85054	
E6HZ-18124-D	85301		F1HT18045CA	83308		F4TA-18080-PA	G63461		F6HT18045HC	85054	
E6HZ-18125-D	83215		F1HT18045CB	83216		F4TA18045TA	G63455		F6HT18045LA	85376	
E6HZ18124A	85301		F1HT18045DA	83312	89409	F4TA18080PA	G63461		F6HT18045MA	85006	
E6HZ18124D	85301		F1HT18045DB	83308		F4TZ-18124-D	G63414		F6HT18080CA	85314	89425
E6HZ18125D	83215		F1HT18045GA	85006		F4TZ-18124-K	G63455		F6HT18080FC	85013	89414
E7HZ-18124-A	85301		F1HT18045GB	85006		F4TZ-18125-E	G63461		F6HZ-18080-FC	85013	89414
E7HZ18124A	85301		F1HT18045HB	85006		F4TZ-18125-L	G63406		F6HZ-18124-A	85054	
E7XZ-18124-A	G63386		F1HT18045KB	85006		F4TZ18124D	G63414		F6HZ-18124-B	83308	
E7XZ-18125-A	G63350		F1HT18045LB	85006		F4TZ18124K	G63455		F6HZ-18124-G	85054	
E7XZ-18125-B	G63387		F1HZ-18124-A	83309		F4TZ18125E	G63461		F6HZ-18124-H	85054	
E7XZ-18125-C	G63409		F1HZ-18124-AA	83309		F4TZ18125L	G63406		F6HZ-18124-MA	85006	
E7XZ-18125-D	G63406		F1HZ-18124-B	83308		F5HZ-18124-A	83314		F6HZ-18125-A	85314	89425
E7XZ-18125-E	G63406		F1HZ-18124-D	85006		F5HZ-18124-AA	83314		F6HZ-18125-D	85013	89414
E7XZ-18125-J	G63299		F1HZ-18124-E	85006		F5HZ-18124-B	83107		F6HZ18080FC	85013	89414
E7XZ18124A	G63386		F1HZ-18124-F	85006		F5HZ-18124-C	85063		F6HZ18124A	85054	
E7XZ18125A	G63350		F1HZ-18124-G	85006		F5HZ-18124-D	83125		F6HZ18124B	83308	
E7XZ18125B	G63387		F1HZ-18124-J	83308		F5HZ-18124-DA	83125		F6HZ18124G	85054	
E7XZ18125C	G63409		F1HZ18124A	83309		F5HZ-18125-A	85314	89425	F6HZ18124H	85054	
E7XZ18125D	G63406		F1HZ18124AA	83309		F5HZ-18125-AA	85314	89425	F6HZ18124MA	85006	
E7XZ18125E	G63406		F1HZ18124B	83308		F5HZ-18125-B	85001	89410	F6HZ18125A	85314	89425
E7XZ18125J	G63299		F1HZ18124D	85006		F5HZ-18125-BA	85001	89410	F6HZ18125D	85013	89414
E9HS-18045-AA	83309		F1HZ18124E	85006		F5HZ-18125-DA	85314	89425	F77A-18080-BA	G63607	
E9HS-18080-AA	85716		F1HZ18124F	85006		F5HZ18124A	83314		F77A18080BA	G63607	
E9HS18045AA	83309		F1HZ18124G	85006		F5HZ18124AA	83314		F7TA-18080-BA	G63607	
E9HS18080AA	85716		F1HZ18124J	83308		F5HZ18124B	83107		F7TA18080BA	G63607	
E9HZ-18124-A	83309		F2HT-18045-BA	85376		F5HZ18124C	85063		F81A-18080-DCA	G63461	
E9HZ-18125-A	85716		F2HT-18045-CA	85376		F5HZ18124D	83125		F81A-18080-ZC	83140	
E9HZ-18125-AA	85716		F2HT-18045-DA	85006		F5HZ18124DA	83125		F81A18080DCA	G63461	
E9HZ18124A	83309		F2HT18045BA	85376		F5HZ18125A	85314	89425	F81A18080ZC	83140	
E9HZ18125A	85716		F2HT18045CA	85376		F5HZ18125AA	85314	89425	F81D-18045-CD	83209	89414
E9HZ18125AA	85716		F2HT18045DA	85006		F5HZ18125B	85001	89410	F81D-18080-CD	83122	89406
F0HS-18045-AA	85006		F2HZ-18124-A	85376		F5HZ18125BA	85001	89410	F81D18045CD	83209	89414
F0HS18045AA	85006		F2HZ-18124-B	85301		F5HZ18125DA	85314	89425	F81D18080CD	83122	89406
F0HT-18045-AA	85006		F2HZ-18124-C	85006		F5TZ-18125-BC	G63607		F81Z-18124-AL	G63622	
F0HT-18045-CA	85006		F2HZ-18124-CA	85006		F5TZ18125BC	G63607		F81Z-18124-BK	G63809	

Important Note: Competitive Interchanges are to be used for stocking purposes only. Where multiple crosses are identified, please reference the applications section of this catalog./ **Remarque importante:** Les interchanges concurrentiels ne s'utilisent qu'aux fins de stocks. Dans le cas de rfrences multiples, consulter la section des applications du catalogue./ **Nota importante:** Dans le cas de rfrences multiples, consulter la section des applications du catalogue./ **Nota importante:** Se pueden usar intercambios competitivos para propósitos de almacenamiento solamente. Cuando se identifican intercambios múltiples, consulte la sección de aplicaciones de este catálogo.

COMPETITIVE & O.E.M. INTERCHANGE LIST

Lista de Intercambios contra Competidores y Equipo Original.

Liste d'interchange de produits compétitifs & d'équipement original (OEM)

Ford... cont'd

Ford	Gabriel	Upgrade	Ford	Gabriel	Upgrade	Ford	Gabriel	Upgrade	Ford	Gabriel	Upgrade
F81Z-18124-CA	83209	89414	FC4Z-18124-A	85181		HC3Z-18125-ED	77987		TACAA18045A	83216	
F81Z-18124-PA	85928		FC4Z-18124-B	85181		HC3Z-18125-EE	77987		TANNA-18045-A	83312	89409
F81Z-18125-DC	G63461		FC4Z-18124-HB	83135		HC3Z-18125-EP	77986		TANNA18045A	83312	89409
F81Z-18125-FA	83122	89406	FC4Z-18125-A	85180		HC3Z-18125-X	77986		TQSH-18045-A	83309	
F81Z-18125-ZA	83140		FC4Z-18125-C	83168		HU9418045AA	83209	89414	TQSH18045A	83309	
F81Z18124AL	G63622		FC4Z-18125-D	83148		HU9418045BA	83209	89414	XC35-18045-AB	83131	
F81Z18124BK	G63809		FC4Z-18125-E	85978		HU9Z-18124-A	85006		XC35-18045-AD	83131	
F81Z18124CA	83209	89414	FC4Z18124A	85181		HU9Z-18125-B	83122	89406	XC35-18045-JA	83131	
F81Z18124PA	85928		FC4Z18124B	85181		HU9Z18124A	85006		XC3518045AB	83131	
F81Z18125DC	G63461		FC4Z18124HB	83135		HU9Z18124B	83209	89414	XC3518045AD	83131	
F81Z18125FA	83122	89406	FC4Z18125A	85180		HU9Z18124C	83209	89414	XC3518045JA	83131	
F81Z18125ZA	83140		FC4Z18125C	83168		HU9Z18125B	83122	89406	XC3Z-18124-JA	83131	
FC44-18045-BB	85181		FC4Z18125D	83148		KC3Z-3E651-C	14072		XC3Z18124JA	83131	
FC44-18080-AB	85180		FC4Z18125E	85978		LC3Z-18125-J	77986		XC45-18045-AA	83216	
FC4418045BB	85181		HC3Z-18124-J	77967		LC3Z-18125-W	77986		XC4518045AA	83216	
FC4418080AB	85180		HC3Z-18125-B	77987		TACAA-18045-A	83216				

Forest River

Forest river	Gabriel	Upgrade	Forest river	Gabriel	Upgrade	Forest river	Gabriel	Upgrade	Forest river	Gabriel	Upgrade
141700131809	85029		8C2418045DA	G63622		ASH-1206	83122	89406	ASH1230	83122	89406
141700131810	83160		8C2418080DB	G63623		ASH-1228	83209	89414	ASH137	83122	89406
16-16736-000	85029		8C2Z-18124-D	G63622		ASH-1229	83209	89414	ASH25820	85005	89430
16-16737-000	83160		8C2Z-18125-D	G63623		ASH-1230	83122	89406	ASH25821	85006	
16-16873-000	85029		8C2Z18124D	G63622		ASH-137	83122	89406	ASH25822	83209	89414
16-16874-000	83160		8C2Z18125D	G63623		ASH-25820	85005	89430	ASH25823	83209	89414
16-18103-000	85900		9U94-18045-AA	83209	89414	ASH-25821	85006		ASH25824	83122	89406
1616736000	85029		9U94-18080-AA	83122	89406	ASH-25822	83209	89414	ASH294	83209	89414
1616737000	83160		9U9418045AA	83209	89414	ASH-25823	83209	89414	AT-163G	G63622	
1616873000	85029		9U9418080AA	83122	89406	ASH-25824	83122	89406	AT-164G	G63623	
1616874000	83160		9U9Z-18124-A	83209	89414	ASH-294	83209	89414	AT-620	83209	89414
1618103000	85900		9U9Z-18125-A	83122	89406	ASH1022	83209	89414	AT-621	83122	89406
1C34-18045-AA	83209	89414	9U9Z18124A	83209	89414	ASH1023	83122	89406	AT-766	83209	89414
1C34-18045-JA	83209	89414	9U9Z18125A	83122	89406	ASH1136	G63623		AT163G	G63622	
1C3418045AA	83209	89414	ASH-1022	83209	89414	ASH1154	G63622		AT164G	G63623	
1C3418045JA	83209	89414	ASH-1023	83122	89406	ASH1161	85006		AT620	83209	89414
481700000493	85900		ASH-1136	G63623		ASH1162	85005	89430	AT621	83122	89406
66153-002	83124	89407	ASH-1154	G63622		ASH1205	83209	89414	AT766	83209	89414
66153002	83124	89407	ASH-1161	85006		ASH1206	83122	89406	F4-BE5-C832-MO	83124	89407
8C24-18045-DA	G63622		ASH-1162	85005	89430	ASH1228	83209	89414	F4BE5C832MO	83124	89407
8C24-18080-DB	G63623		ASH-1205	83209	89414	ASH1229	83209	89414			

Freightliner

Freightliner	Gabriel	Upgrade	Freightliner	Gabriel	Upgrade	Freightliner	Gabriel	Upgrade	Freightliner	Gabriel	Upgrade
10-12388-000	85920	89503	1012388000	85920	89503	1201-0054	83021		12021043	83025	
10-12390-000	85920	89503	1012390000	85920	89503	1201-1043	83025		12021044	83025	
10-12396-000	85918	89449	1012396000	85918	89449	1201-1044	83025		1398980	83127	
10-12703-000	85918	89449	1012703000	85918	89449	12010054	83021		141700000377	83160	
10-13021-000	85918	89449	1013021000	85918	89449	12011043	83025		141700000378	83160	
10-13051-001	85005	89430	1013051001	85005	89430	12011044	83025		141700131809	85029	
10-13063-000	85918	89449	1013063000	85918	89449	1202-0042	83025		141700131810	83160	
10-13205-000	85918	89449	1013205000	85918	89449	1202-0043	83025		141700131975	83160	
10-13211-000	85918	89449	1013211000	85918	89449	1202-0044	83025		16-11133-000	85007	
10-13592-000	85959		1013592000	85959		1202-0054	83021		16-12117-000	85007	
10-13634-000	85918	89449	1013634000	85918	89449	1202-1043	83025		16-13957-000	85724	89443
10-13684-000	85918	89449	1013684000	85918	89449	1202-1044	83025		16-14259-000	85331	
10-13759-000	85006		1013759000	85006		12020042	83025				
10-13760-000	85959		1013760000	85959		12020043	83025				
10-13776-000	85005	89430	1013776000	85005	89430	12020044	83025				
10-13859-000	85005	89430	1013859000	85005	89430	12020054	83021				

Important Note: Competitive Interchanges are to be used for stocking purposes only. Where multiple crosses are identified, please reference the applications section of this catalog. / **Remarque importante:** Les interchanges concurrentiels ne s'utilisent qu'aux fins de stocks. Dans le cas de références multiples, consulter la section des applications du catalogue. / **Nota importante:** Dans le cas de referencias multiples, consultar la sección de aplicaciones del catálogo. / **Nota importante:** Se pueden usar intercambios competitivos para propósitos de almacenamiento solamente. Cuando se identifican intercambios múltiples, consulte la sección de aplicaciones de este catálogo.

COMPETITIVE & O.E.M. INTERCHANGE LIST
Lista de Intercambios contra Competidores y Equipo Original.
Liste dinterchange de produits comptitifs & dquipement original (OEM)

Freightliner... cont'd

Freightliner	Gabriel	Upgrade	Freightliner	Gabriel	Upgrade	Freightliner	Gabriel	Upgrade	Freightliner	Gabriel	Upgrade
16-14577-000	85043		16-18711-000	85335		1618076000	83160		471700010991	83154	
16-14667-000	85005	89430	16-18713-000	85122		1618094000	85959		471700011302	85058	89431
16-14668-000	83127		16-19138-000	85058	89431	1618103000	85900		471700131155	85918	89449
16-14669-000	G63403		16-20552-000	83154		1618455000	85918	89449	471700131331	85932	89453
16-14794-000	83154		16-20628-000	85058	89431	1618456000	85959		471700131646	85918	89449
16-15064-000	83154		16-20632-000	85919		1618705000	85007		471700131775	85006	
16-15394-000	83120		16-20716-000	85724	89443	1618706000	85331		471700131778	85331	
16-15436-000	83154		16-22004-000	85058	89431	1618707000	85921		471700131974	85029	
16-15473-000	83157		1611133000	85007		1618708000	85724	89443	47902-13	83122	89406
16-15474-000	83157		1612117000	85007		1618709000	83134		4790213	83122	89406
16-15475-000	83164		1613957000	85724	89443	1618710000	83134		481700000477	85900	
16-15591-000	85043		1614259000	85331		1618711000	85335		481700000493	85900	
16-15592-000	83154		1614577000	85043		1618713000	85122		481700006848	85724	89443
16-15676-000	85058	89431	1614667000	85005	89430	1619138000	85058	89431	481700125969	85956	
16-15705-000	83120		1614668000	83127		1620552000	83154		481700131919	85900	
16-15755-000	85043		1614669000	G63403		1620632000	85919		535228	85302	89420
16-15765-000	85921		1614794000	83154		1620716000	85724	89443	58913-003	85932	89453
16-15770-000	85956		1615064000	83154		16725-01	83126	89430	58913-003L	85932	89453
16-15805-000	83120		1615394000	83120		1672501	83126	89430	58913-012	85932	89453
16-15817-000	85724	89443	1615436000	83154		18-30378	83006		58913-012L	85932	89453
16-15934-000	83120		1615473000	83157		18-30378-000	83006		58913003	85932	89453
16-16043-000	85043		1615474000	83157		18-32999-001	83006		58913003L	85932	89453
16-16082-000	85043		1615475000	83164		18-47350-000	83040		58913012	85932	89453
16-16083-000	85331		1615591000	85043		18-60295-000	83006		58913012L	85932	89453
16-16093-000	83160		1615592000	83154		18-60766-000	83040		60680-004	83143	
16-16262-000	83120		1615676000	85058	89431	1830378	83006		60680-004L	83143	
16-16442-000	83134		1615705000	83120		1830378000	83006		60680-005	83142	
16-16486-000	83134		1615755000	85043		1832999001	83006		60680-005L	83142	
16-16542-000	83154		1615765000	85921		1847350000	83040		60680004	83143	
16-16577-000	85335		1615770000	85956		1860295000	83006		60680004L	83143	
16-16736-000	85029		1615805000	83120		1860766000	83040		60680005	83142	
16-16737-000	83160		1615817000	85724	89443	19495-01	83126	89430	60680005L	83142	
16-16765-000	85006		1615934000	83120		1949501	83126	89430	61300224	85918	89449
16-16826-000	85043		1616043000	85043		3638112	G63183		61300240	85918	89449
16-16827-000	85331		1616082000	85043		4036892	G63605		650224	83225	
16-16836-000	83154		1616083000	85331		471700000440	85959		654654	85043	
16-16873-000	85029		1616093000	83160		471700000447	85919		654831	83006	
16-16874-000	83160		1616262000	83120		471700000449	85918	89449	654918	83118	
16-17144-000	85900		1616442000	83134		471700000466	85959		654953	85058	89431
16-17211-000	85909		1616486000	83134		471700000470	85918	89449	659060	85920	89503
16-17361-000	85900		1616542000	83154		471700002726	85918	89449	659062	83134	
16-17684-000	85058	89431	1616577000	85335		471700002727	85959		659063	83134	
16-17759-000	85919		1616736000	85029		471700002808	85724	89443	659079	83040	
16-17760-000	85331		1616737000	83160		471700002809	85724	89443	659227	85058	89431
16-18075-000	83160		1616765000	85006		471700002990	85007		659288	83006	
16-18076-000	83160		1616826000	85043		471700002991	85959		659300	85005	89430
16-18094-000	85959		1616827000	85331		471700002992	85331		665236	85007	
16-18103-000	85900		1616836000	83154		471700002993	85921		665409	85009	
16-18455-000	85918	89449	1616873000	85029		471700002994	83134		671908	85918	89449
16-18456-000	85959		1616874000	83160		471700002995	83134		671945	85920	89503
16-18705-000	85007		1617144000	85900		471700002996	85335		671946	85921	
16-18706-000	85331		1617211000	85909		471700003009	85006		680009	85302	89420
16-18707-000	85921		1617361000	85900		471700003011	85058	89431	680017	85302	89420
16-18708-000	85724	89443	1617684000	85058	89431	471700003070	85122		6803230200	85043	
16-18709-000	83134		1617759000	85919		471700005079	85005	89430	6803230300	85006	
16-18710-000	83134		1617760000	85331		471700006269	85932	89453	6803260000	83120	

Important Note: Competitive Interchanges are to be used for stocking purposes only. Where multiple crosses are identified, please reference the applications section of this catalog. / **Remarque importante:** Les interchanges concurrentiels ne s'utilisent qu'aux fins de stocks. Dans le cas de références multiples, consulter la section des applications du catalogue. / **Nota importante:** Dans le cas de referencias multiples, consultar la sección de aplicaciones del catálogo. / **Nota importante:** Se pueden usar intercambios competitivos para propósitos de almacenamiento solamente. Cuando se identifican intercambios múltiples, consulte la sección de aplicaciones de este catálogo.

COMPETITIVE & O.E.M. INTERCHANGE LIST
Lista de Intercambios contra Competidores y Equipo Original.
Liste dinterchange de produits comptitifs & dquipement original (OEM)

Freightliner... cont'd

Freightliner	Gabriel	Upgrade	Freightliner	Gabriel	Upgrade	Freightliner	Gabriel	Upgrade	Freightliner	Gabriel	Upgrade
680339	85724	89443	814903003482	83040		GBL654732	83120		MAE 16949	83120	
680511	85331		90045083	85910		GBL654733	83120		MAE 16950	83118	
680611	85724	89443	GBL 651375	83119		GBL654734	83120		MAE16950	83118	
680651	85335		GBL654725	83120		GBL654735	83120		P117099	83120	
680782	85302	89420	GBL654726	83120		GBL665538	85006		P117146	83118	
681-323-0900	85009		GBL654727	83120		H60680004	83143		RW24285	83119	
681-323-1100	85301		GBL654728	83120		HDR60680-004	83143		SDA471700000440	85959	
6813230900	85009		GBL654729	83120		HDR60680-005	83142		SDA471700002809	85724	89443
6813231100	85301		GBL654730	83120		HDR60680004	83143		SDA471700002991	85959	
70042	85302	89420	GBL654731	83120		HDR60680005	83142				

Fruehauf

Fruehauf	Gabriel	Upgrade	Fruehauf	Gabriel	Upgrade	Fruehauf	Gabriel	Upgrade	Fruehauf	Gabriel	Upgrade
5116-117	83122	89406	UCE-9399-1	83122	89406	UEY 1124-001	85030	89440			
5116117	83122	89406	UCE93991	83122	89406	UEY 1124001	85030	89440			

FWD Truck

Fwd truck	Gabriel	Upgrade	Fwd truck	Gabriel	Upgrade	Fwd truck	Gabriel	Upgrade	Fwd truck	Gabriel	Upgrade
450739	85302	89420									

GasSLX

Gasslx	Gabriel	Upgrade	Gasslx	Gabriel	Upgrade	Gasslx	Gabriel	Upgrade	Gasslx	Gabriel	Upgrade
89405	83123		89414	85013		89436	83128		89451	85067	
89405	85036		89420	85302		89436	83203		89453	85932	
89406	83122		89423	85310		89436	83389		89455	85069	
89407	83124		89424	85311		89436	85000		89456	85936	
89407	83207		89425	85314		89436	85323		89458	85923	
89407	85906		89427	85033		89440	85030		89458	85931	
89409	83312		89430	83126		89443	85724		89459	85070	
89410	85001		89430	85005		89447	83456		89460	85084	
89413	85012		89430	85916		89447	85705		89503	85920	
89414	83209		89431	85058		89449	85918				

General Motors

General motors	Gabriel	Upgrade	General motors	Gabriel	Upgrade	General motors	Gabriel	Upgrade	General motors	Gabriel	Upgrade
1-51630-168-1	83515		1516302191	83114		19241355	61685		22012169	83221	
1-51630-217-0	83114		15174898	83136		19257310	G63895		22012196	83221	
1-51630-217-1	83114		15174902	85071		19295552	81873		22064013	61524	
1-51630-219-1	83114		15588554	83136		19295553	81920		22064013	G63349	
1201-0054	83021		15740554	83137		19295557	81925		22064019	61524	
1201-1043	83025		15887728	83136		19368462	49235		22064019	G63349	
12010054	83021		15935605	43181		19402811	83397		22064226	61524	
12011043	83025		15935605	61600		19403619	83397		22064226	G63349	
1202-0054	83021		15935611	58412		19403620	83397		22064230	83136	
1202-1043	83025		15935611	61642		19404855	83135		22064232	85071	
12020054	83021		15935611	77412		19407869	83397		22064233	83136	
12021043	83025		15935621	43181		19407870	83398		22064417	61544	
12474719	61544		15935625	58412		19407871	83397		22064417	G63489	
12474719	G63489		15935625	61642		19407873	83398		22064432	83221	
12474721	43180		15935625	77412		19408176	85670		22064635	58609	
12474721	49231		15935629	61600		20956377	61687		22064635	61542	
12474721	58638		15963161	83122	89406	20956377	G63897		22064635	77609	
12474721	61565		19152843	83136		20956379	61687		22064635	G63609	
12474721	77638		19167562	81039		20956379	G63897		22064684	58609	
12474721	G63638		19167562	G63355		20956380	61687		22064684	61542	
12474915	83122	89406	19168179	61641		20956380	G63897		22064684	77609	
12474917	83137		19168179	G63783		22002293	83126	89430	22064684	G63609	
15123676	83136		19172175	6850SE		22007701	83126	89430			
1516301681	83515		19172178	6853SE		22012095	83126	89430			
1516302170	83114		19203641	61687		22012096	83221				
1516302171	83114		19235148	61683		22012166	83126	89430			

Important Note: Competitive Interchanges are to be used for stocking purposes only. Where multiple crosses are identified, please reference the applications section of this catalog. / **Remarque importante:** Les interchanges concurrentiels ne s'utilisent qu'aux fins de stocks. Dans le cas de rferences multiples, consulter la section des applications du catalogue. / **Nota importante:** Dans le cas de rferences multiples, consulter la section des applications du catalogue. / **Nota importante:** Se pueden usar intercambios competitivos para propósitos de almacenamiento solamente. Cuando se identifican intercambios múltiples, consulte la sección de aplicaciones de este catálogo.

COMPETITIVE & O.E.M. INTERCHANGE LIST
Lista de Intercambios contra Competidores y Equipo Original.
Liste dinterchange de produits comptitifs & dquipement original (OEM)

General Motors... cont'd

General motors	Gabriel	Upgrade	General motors	Gabriel	Upgrade	General motors	Gabriel	Upgrade	General motors	Gabriel	Upgrade
22064804	83136		4975510	83221		88946138	82035		88966866	61663	
22064805	83136		4975549	83216		88946145	82047		88982682	83136	
22064806	83136		4984526	83216		88946176	82086		88982684	83136	
22064807	83136		4993599	6804SE		88946214	82155		88982686	85071	
22064829	61543		508-86	83136		88946547	14017		88983818	49235	
22064829	G63488		50886	83136		88946553	34036		88986629	61555	
22064830	58609		5171068	83216		88946558	34073		88986629	81713	
22064830	61542		5513489	83216		88946561	43048		88986629	G63375	
22064830	61544		5531027	85301		88946574	43111		89038591	61642	
22064830	77609		5533699	85302	89420	88946581	43163		89038595	61641	
22064830	G63489		5544060	85302	89420	88946588	43180		89038595	G63783	
22064830	G63609		5544112	83216		88946589	43181		89038597	58412	
22065218	G63347		5544581	85302	89420	88946592	49107		89038597	77412	
22065251	85030	89440	5544812	83308		88946604	49155		89038652	58817	
22165187	83136		5552114	83216		88946607	49162		89038652	61663	
22165188	83136		5552209	83215		88946621	49212		89038652	77817	
22165189	83136		5552453	85301		88946627	49218		89038652	G63817	
22166442	83136		5552454	85302	89420	88946638	49231		89038654	43181	
25871225	49235		5554184	85302	89420	88946642	49235		89038654	61600	
25871229	49235		5554814	85302	89420	88946670	6802SE		8940575930	83114	
25948611	43181		684280	83209	89414	88946671	6803SE		8944549860	83515	
25984611	61600		8-51630-666-0	85012	89413	88946672	6804SE		8944549870	83515	
25984613	58412		8-94057-593-0	83114		88959113	58357		8970830290	83515	
25984613	61642		8-94454-986-0	83515		88959123	58403		8972019600	83515	
25984613	77412		8-94454-987-0	83515		88959128	58412		8972536200	83515	
3171068	83216		8-97083-029-0	83515		88959140	58488		8972536640	83159	
3171462	83126	89430	8-97201-960-0	83515		88959141	58489		8972536650	83159	
3192657	83216		8-97253-620-0	83515		88959143	58609		898098-0580	83159	
3192890	83126	89430	8-97253664-0	83159		88959149	58638		898098-0581	83159	
3192891	83221		8-97253665-0	83159		88959151	58662		898098-0590	83159	
3192892	83221		8-98380-746-0	83159		88959156	58714		898098-1250	83515	
35901-0001	83209	89414	8-98380-747-0	83159		88959173	58817		898098-1270	83515	
35901-0003	85301		8-98381-010-0	83515		88962985	77403		8980980580	83159	
35901-0017	83314		8-98381-012-0	83515		88962987	77375		8980980581	83159	
359010001	83209	89414	84303234	G63895		88962995	77412		8980980590	83159	
359010003	85301		88945846	61500		88962995	77783		8980981250	83515	
359010017	83314		88945861	61516		88963009	77488		8980981270	83515	
3989717C1	83135		88945867	61522		88963010	77488		8983807460	83159	
4089293C1	83397		88945983	81039		88963010	77489		8983807470	83159	
4109458C2	83243		88945987	81096		88963017	77609		8983810100	83515	
4109582C1	83397		88945990	81113		88963020	77638		8983810120	83515	
4109583C1	83397		88945991	81164		88963023	77662		9-51630-647-1	83515	
4206863C1	83398		88945992	81147		88963039	77783		9-51630-666-0	85012	89413
4207304C1	83397		88945995	81242		88963046	77817		9-51630-666-2	85012	89413
4208946C1	83398		88945997	81270		88966771	61517		94033786	83114	
4214011C2	85670		88946002	81394		88966773	61519		94051090	83114	
4940600	83209	89414	88946009	81510		88966777	61524		94057593	83114	
4940601	83216		88946010	81082		88966778	61525		94454987	83515	
4940606	83126	89430	88946023	81490		88966792	61542		9516306471	83515	
4940614	83216		88946028	81496		88966793	61543		9516306660	85012	89413
4940640	83216		88946029	81484		88966794	61544		9516306662	85012	89413
4940654	83216		88946059	81667		88966801	61555		97083027	83515	
4940662	83126	89430	88946060	81668		88966809	61600		97083029	83515	
4963853	83216		88946072	81713		88966810	61565		97201960	83515	
4963854	83216		88946106	82003		88966850	61641		97253616	83515	
4975497	83126	89430	88946137	82034		88966851	61642		97253620	83515	

Important Note: Competitive Interchanges are to be used for stocking purposes only. Where multiple crosses are identified, please reference the applications section of this catalog. / **Remarque importante:** Les interchanges concurrentiels ne s'utilisent qu'aux fins de stocks. Dans le cas de rfrences multiples, consulter la section des applications du catalogue. / **Nota importante:** Dans le cas de rfrences multiples, consulter la section des applications du catalogue. / **Nota importante:** Se pueden usar intercambios competitivos para propósitos de almacenamiento solamente. Cuando se identifican intercambios múltiples, consulte la sección de aplicaciones de este catálogo.

COMPETITIVE & O.E.M. INTERCHANGE LIST

Lista de Intercambios contra Competidores y Equipo Original.

Liste d'interchange de produits complititifs & d'equipement original (OEM)

General Motors... cont'd

General motors	Gabriel	Upgrade	General motors	Gabriel	Upgrade	General motors	Gabriel	Upgrade	General motors	Gabriel	Upgrade
97253621	83515		97253665	83159		98098127	83515		98381010	83515	
97253623	83515		98098058	83159		98232671	83515		98381012	83515	
97253651	83159		98098059	83159		98380746	83159		SG23086	61522	
97253664	83159		98098125	83515		98380747	83159				

General Trailer Co.

General trailer co.	Gabriel	Upgrade	General trailer co.	Gabriel	Upgrade	General trailer co.	Gabriel	Upgrade	General trailer co.	Gabriel	Upgrade
120-1	83125		1201	83125		12608	83125				

Georgie Boy Manufacturing

Georgie boy manufacturing	Gabriel	Upgrade	Georgie boy manufacturing	Gabriel	Upgrade	Georgie boy manufacturing	Gabriel	Upgrade	Georgie boy manufacturing	Gabriel	Upgrade
1C34-18045-AA	83209	89414	9U9Z18125A	83122	89406	ASH-1230	83122	89406	ASH137	83122	89406
1C34-18045-JA	83209	89414	ASH-1022	83209	89414	ASH-137	83122	89406	ASH25824	83122	89406
66153-002	83124	89407	ASH-1023	83122	89406	ASH-25822	83209	89414	AT-620	83209	89414
66153002	83124	89407	ASH-1136	G63623		ASH-25823	83209	89414	AT-621	83122	89406
9U94-18045-AA	83209	89414	ASH-1154	G63622		ASH-25824	83122	89406	AT-766	83209	89414
9U94-18080-AA	83122	89406	ASH-1205	83209	89414	ASH-294	83209	89414	AT621	83122	89406
9U9418080AA	83122	89406	ASH-1206	83122	89406	ASH1023	83122	89406	F4-BE5-C832-MO	83124	89407
9U9Z-18124-A	83209	89414	ASH-1228	83209	89414	ASH1206	83122	89406	F4BE5C832MO	83124	89407
9U9Z-18125-A	83122	89406	ASH-1229	83209	89414	ASH1230	83122	89406			

Gillig Bros.

Gillig bros.	Gabriel	Upgrade	Gillig bros.	Gabriel	Upgrade	Gillig bros.	Gabriel	Upgrade	Gillig bros.	Gabriel	Upgrade
57131	83216		82-01878	83122	89406	8221542000	85716				
680009	85302	89420	82-21542-000	85716		90044046	83123	89405			
70034	85302	89420	8201878	83122	89406	90044683	83122	89406			

Glaval Bus Co.

Glaval bus co.	Gabriel	Upgrade	Glaval bus co.	Gabriel	Upgrade	Glaval bus co.	Gabriel	Upgrade	Glaval bus co.	Gabriel	Upgrade
3578858C1	85656		4C4Z-18125-DA	85656		ASH-1154	G63622		FC44-18080-AB	85180	
3578858C2	85656		4C4Z18124JB	85928		ASH-24658	85181		FC4418045BB	85181	
3584116C1	83175		4C4Z18124QA	83175		ASH-24659	85181		FC4418080AB	85180	
3584116C2	83175		4C4Z18124RA	85928		ASH-24660	85180		FC4Z-18124-A	85181	
3584118C2	85928		4C4Z18125DA	85656		ASH24658	85181		FC4Z-18124-B	85181	
471700011530	85181		501906C92	83317		ASH24659	85181		FC4Z-18125-A	85180	
471700011531	85180		AA-616	83175		ASH24660	85180		FC4Z18124A	85181	
4C4Z-18124-JB	85928		AA-617	85928		ASH24661	83317		FC4Z18124B	85181	
4C4Z-18124-QA	83175		AA616	83175		AT-812	85928		FC4Z18125A	85180	
4C4Z-18124-RA	85928		AA617	85928		AT812	85928				
4C4Z-18125-B	83317		ASH-1136	G63623		FC44-18045-BB	85181				

GM Long Catalog

Gm long catalog	Gabriel	Upgrade	Gm long catalog	Gabriel	Upgrade	Gm long catalog	Gabriel	Upgrade	Gm long catalog	Gabriel	Upgrade
19172175	6850SE		19467938	81873		88945479	G63817		88946176	82086	
19172178	6853SE		19471225	G57801		88945846	61500		88946214	82155	
19203641	61687		19471226	G57800		88945867	61522		88946547	14017	
19235171	G63893		22064698	G63375		88945983	81039		88946553	34036	
19235173	G63897		88945298	G63349		88945987	81096		88946558	34073	
19236058	G63895		88945301	G63355		88945991	81164		88946561	43048	
19241355	61685		88945302	G63357		88945995	81242		88946581	43163	
19295553	81920		88945319	G63366		88945997	81270		88946588	43180	
19295557	81925		88945343	G63375		88946002	81394		88946604	49155	
19366116	G64121		88945357	G63488		88946009	81510		88946621	49212	
19366152	77976		88945358	G63489		88946010	81082		88946627	49218	
19390196	77403		88945369	G63403		88946023	81490		88946638	49231	
19467932	G63662		88945370	G63411		88946028	81496		88946642	49235	
19467933	G63675		88945371	G63394		88946029	81484		88946670	6802SE	
19467934	43181		88945391	G63609		88946059	81667		88946672	6804SE	
19467935	77412		88945406	G63638		88946072	81713		88959113	58357	
19467936	61600		88945412	G63671		88946106	82003		88959128	58412	
19467937	61642		88945466	G63783		88946145	82047		88959140	58488	

Important Note: Competitive Interchanges are to be used for stocking purposes only. Where multiple crosses are identified, please reference the applications section of this catalog. / **Remarque importante:** Les interchanges concurrentiels ne s'utilisent qu'aux fins de stocks. Dans le cas de rferences multiples, consulter la section des applications du catalogue. / **Nota importante:** Dans le cas de rferences multiples, consulter la section des applications du catalogue. / **Nota importante:** Se pueden usar intercambios competitivos para propósitos de almacenamiento solamente. Cuando se identifican intercambios múltiples, consulte la sección de aplicaciones de este catálogo.

COMPETITIVE & O.E.M. INTERCHANGE LIST
Lista de Intercambios contra Competidores y Equipo Original.
Liste dinterchange de produits compititifs & dquipement original (OEM)

GM Long Catalog... cont'd

Gm long catalog	Gabriel	Upgrade	Gm long catalog	Gabriel	Upgrade	Gm long catalog	Gabriel	Upgrade	Gm long catalog	Gabriel	Upgrade
88959141	58489		88962620	61591		88965977	61546		88966778	61525	
88959143	58609		88962987	77375		88965978	61518		88966793	61543	
88959149	58638		88963017	77609		88965985	G63810		88966794	61544	
88959151	58662		88963020	77638		88965986	G63809		88966801	61555	
88959170	58810		88963046	77817		88965992	G63714		88966810	61565	
88959173	58817		88965919	58809		88965995	G63674		88966850	61641	
88962583	61523		88965962	61632		88965996	G63673		88966866	61663	
88962585	G63414		88965964	61611		88966002	G63455				
88962619	G63461		88965966	61599		88966777	61524				

Gold

Gold	Gabriel	Upgrade	Gold	Gabriel	Upgrade	Gold	Gabriel	Upgrade	Gold	Gabriel	Upgrade
5000738	85071		5000831	83024		8160119	85902		9160761	G63461	
5000741	83136		5000839	83131		8160120	85069	89455	9160820	83312	89409
5000742	83308		5000840	83162		8160195	85013	89414	9160933	83209	89414
5000743	83107		5000849	85054		8160195	85043		9160972	83025	
5000745	83314		5000852	85376		8160523	83021		9160980	83135	
5000745	85013	89414	5000853	83101		8160909	83123	89405	9170007	85918	89449
5000747	83101		5000855	83154		8160935	83140		9180126	85012	89413
5000748	83135		5000856	85978		8180050	85001	89410	9180130	85005	89430
5000759	83142		5000861	83025		8180139	85936	89456	9180131	85001	89410
5000762	83160		5000862	83140		8180172	85919		9180134	85921	
5000764	85957		5000865	85910		9150063	83216		9180143	85918	89449
5000765	83216		5000869	83216		9160091	85006		9180145	85067	89451
5000776	85005	89430	5000871	83164		9160092	85043		9180146	85033	89427
5000777	83143		5000872	85082		9160093	83317		9180147	83136	
5000778	83054		8150240	83125		9160096	85001	89410	9180149	85900	
5000781	85656		8150371	83127		9160097	85001	89410	9180151	85070	89459
5000783	83025		8150372	83137		9160121	85067	89451	9180184	83163	
5000785	83216		8160091	85006		9160190	85070	89459	9180187	85084	89460
5000790	83180		8160098	83456	89447	9160268	85058	89431	9180188	85069	89455
5000792	83134		8160101	85001	89410	9160488	83456	89447	9180190	85072	
5000813	83221		8160102	83215		9160493	83136		9180193	85030	89440
5000816	85956		8160103	83312	89409	9160498	83136		9180196	83122	89406
5000818	83120		8160114	85918	89449	9160513	85029		9180199	85301	
5000825	83225		8160115	85031		9160536	85005	89430	9190007	85724	89443
5000826	85029		8160116	85012	89413	9160545	83154				
5000830	83175		8160118	85900		9160697	G63622				

Goshen Coach

Goshen coach	Gabriel	Upgrade	Goshen coach	Gabriel	Upgrade	Goshen coach	Gabriel	Upgrade	Goshen coach	Gabriel	Upgrade
ASH-1136	G63623		ASH-1154	G63622		ASH1136	G63623		ASH1154	G63622	

Great Dane Trailer

Great dane trailer	Gabriel	Upgrade	Great dane trailer	Gabriel	Upgrade	Great dane trailer	Gabriel	Upgrade	Great dane trailer	Gabriel	Upgrade
18164-01	83122	89406	18165-01	85006		MER202447	85919		REY1816501	85006	
1816401	83122	89406	1816501	85006		REY18165-01	85006				

Grech Motors

Grech motors	Gabriel	Upgrade	Grech motors	Gabriel	Upgrade	Grech motors	Gabriel	Upgrade	Grech motors	Gabriel	Upgrade
ASH-1136	G63623		ASH-1154	G63622							

GROB

Grob	Gabriel	Upgrade	Grob	Gabriel	Upgrade	Grob	Gabriel	Upgrade	Grob	Gabriel	Upgrade
2709049	81496		G5099	61523		G5187	61613		G5232	81744	
3009024	77948		G5100	61600		G5206	61641		G5238	61638	
6709037	81147		G5115	61646		G5213	61655				

Grupo A

Grupo a	Gabriel	Upgrade	Grupo a	Gabriel	Upgrade	Grupo a	Gabriel	Upgrade	Grupo a	Gabriel	Upgrade
15500	6802SE		15502	6804SE		39155	49155		43003	61524	
15501	6804SE		164023	43140		39218	49231		43003	81164	

Important Note: Competitive Interchanges are to be used for stocking purposes only. Where multiple crosses are identified, please reference the applications section of this catalog./ **Remarque importante:** Les interchanges concurrentiels ne s'utilisent qu'aux fins de stocks. Dans le cas de rfrences multiples, consulter la section des applications du catalogue./ **Nota importante:** Dans le cas de rfrences multiples, consulter la section des applications du catalogue./ **Nota importante:** Se pueden usar intercambios competitivos para propósitos de almacenamiento solamente. Cuando se identifican intercambios múltiples, consulte la sección de aplicaciones de este catálogo.

COMPETITIVE & O.E.M. INTERCHANGE LIST
Lista de Intercambios contra Competidores y Equipo Original.
Liste dinterchange de produits comptitifs & dquipement original (OEM)

Grupo A... cont'd

Grupo a	Gabriel	Upgrade	Grupo a	Gabriel	Upgrade	Grupo a	Gabriel	Upgrade	Grupo a	Gabriel	Upgrade
43025	61519		53051	61520		69013	61641		69523	61544	
43025	81484		53051	81490		69013	81920		69538	61683	
43026	81676		53052	61530		69014	61600		69546	61591	
43046	61500		53052	81510		69014	81873		69548	61520	
43046	81147		53069	81710		69024	61500		69548	81490	
43059	61500		53070	61520		69025	81147		69548	81744	
43059	81147		53070	81490		69309	61520		69549	61591	
43069	81710		53070	81913		69309	81490		69550	61518	
43070	61520		53071	61519		69309	81744		69550	81242	
43070	81490		53071	81484		69310	81490		69554	61554	
43119	61600		53072	81925		69310	81744		69563	61634	
43120	61641		53276	81873		69321	61500		69587	61710	
43121	81920		53337	61544		69321	81147		69592	61714	
43122	61600		53337	81668		69326	61500		69593	61654	
43122	81873		53338	82003		69326	81147		69594	61713	
43124	61500		53341	61521		69330	81710		69601	61554	
43124	81147		53341	81394		69346	81091		69622	61642	
43125	61520		53400	61523		69355	61523		69623	61635	
43125	81490		53400	81096		69355	81096		69653	58488	
43132	61554		53401	81091		69355	81834		69663	61555	
43132	81710		58003	61524		69357	81091		69664	61565	
43133	61554		58003	81164		69361	61614		69666	61655	
43133	81710		58035	58488		69369	81147		69692	61663	
43236	61524		58035	61543		69381	61500		USA69013	61641	
43236	81164		58035	81667		69381	81147		USA69013	81920	
43381	61521		58054	61530		69382	81342		USA69014	61600	
43381	81394		58054	81510		69383	61632		USA69014	81873	
43511	81091		58069	61547		69383	81825		USA69522	61544	
43512	81091		58069	81082		69395	61520		USA69538	61683	
43731	61614		58070	61520		69395	81490		USA69555	61611	
43731	81821		58070	81490		69396	61547		USA69587	61710	
53020	61521		58178	61500		69396	81082		USA69592	61714	
53020	81394		58178	81147		69501	61543		USA69594	61713	
53020	81744		58337	58489		69503	61544		USA69601	61554	
53025	61521		58337	61544		69506	61523		USA69664	61565	
53025	81394		58337	81668		69509	61554		USA69666	61655	
53029	61544		58341	61521		69510	61520		USA69692	61663	
53029	81668		58341	81394		69519	61599		USA69699	61500	
53036	81091		69011	61600		69520	61544				
53037	61565		69012	61641		69521	61543				

Gulf Stream Coach

Gulf stream coach	Gabriel	Upgrade	Gulf stream coach	Gabriel	Upgrade	Gulf stream coach	Gabriel	Upgrade	Gulf stream coach	Gabriel	Upgrade
141700131809	85029		16-18103-000	85900		88982682	83136		ASH-1136	G63623	
141700131810	83160		1616736000	85029		8C24-18045-DA	G63622		ASH-1154	G63622	
15123676	83136		1616737000	83160		8C24-18080-DB	G63623		ASH1136	G63623	
15588554	83136		1616873000	85029		8C2418045DA	G63622		ASH1154	G63622	
15887728	83136		1616874000	83160		8C2418080DB	G63623		AT-163G	G63622	
16-16736-000	85029		1618103000	85900		8C2Z-18124-D	G63622		AT-164G	G63623	
16-16737-000	83160		19152843	83136		8C2Z-18125-D	G63623		AT163G	G63622	
16-16873-000	85029		22064230	83136		8C2Z18124D	G63622		AT164G	G63623	
16-16874-000	83160		481700000493	85900		8C2Z18125D	G63623				

Hendrickson Trailer Suspension Systems

Hendrickson trailer suspension systems	Gabriel	Upgrade	Hendrickson trailer suspension systems	Gabriel	Upgrade	Hendrickson trailer suspension systems	Gabriel	Upgrade	Hendrickson trailer suspension systems	Gabriel	Upgrade
57905-2	85006		665190	85006		665406	85010				
579052	85006		665246	85043		665532	85013	89414			
60675-004	85006		665267	85029		665533	85005	89430			
60675004	85006		665405	85030	89440	665764	85029				

Important Note: Competitive Interchanges are to be used for stocking purposes only. Where multiple crosses are identified, please reference the applications section of this catalog. / **Remarque importante:** Les interchanges concurrentiels ne s'utilisent qu'aux fins de stocks. Dans le cas de références multiples, consulter la section des applications du catalogue. / **Nota importante:** Dans le cas de referencias multiples, consultar la sección de aplicaciones del catálogo. / **Nota importante:** Se pueden usar intercambios competitivos para propósitos de almacenamiento solamente. Cuando se identifican intercambios múltiples, consulte la sección de aplicaciones de este catálogo.

COMPETITIVE & O.E.M. INTERCHANGE LIST
Lista de Intercambios contra Competidores y Equipo Original.
Liste dinterchange de produits comptitifs & dquipement original (OEM)

Hendrickson Trailer Suspension Systems... cont'd

Hendrickson trailer suspension systems	Gabriel	Upgrade	Hendrickson trailer suspension systems	Gabriel	Upgrade	Hendrickson trailer suspension systems	Gabriel	Upgrade	Hendrickson trailer suspension systems	Gabriel	Upgrade
A-10348	85043		A20886	85030	89440	B23315	85029		S-4089	83209	89414
A-20886	85030	89440	A20887	85005	89430	B25174	85029		S10348	85043	
A-20887	85005	89430	A2212	85029		NS500699	85005	89430	S20886	85030	89440
A-2212	85029		A2213	85010		S-10348	85043		S20887	85005	89430
A-2213	85010		A2218	85030	89440	S-20886	85030	89440	S2212	85029	
A-2218	85030	89440	A2230	85005	89430	S-20887	85005	89430	S2213	85010	
A-2230	85005	89430	A2232	85005	89430	S-2212	85029		S2218	85030	89440
A-2232	85005	89430	A2240	85013	89414	S-2213	85010		S2230	85005	89430
A-2240	85013	89414	A22401	85043		S-2218	85030	89440	S2232	85005	89430
A-2240-1	85043		A2471	85006		S-2230	85005	89430	S2240	85013	89414
A-2471	85006		A4084	85005	89430	S-2232	85005	89430	S23315	85029	
A-4084	85005	89430	A4089	83209	89414	S-2240	85013	89414	S2471	85006	
A-4089	83209	89414	A6156	85301		S-23315	85029		S4084	85005	89430
A-6156	85301		B-23315	85029		S-2471	85006		S4089	83209	89414
A10348	85043		B-25174	85029		S-4084	85005	89430			

Hendrickson Truck Suspension Systems

Hendrickson truck suspension systems	Gabriel	Upgrade	Hendrickson truck suspension systems	Gabriel	Upgrade	Hendrickson truck suspension systems	Gabriel	Upgrade	Hendrickson truck suspension systems	Gabriel	Upgrade
12738	83225		58913-008	85959		60665-009	85043		60675-003	85976	
471700000456	85959		58913-008L	85959		60665-020	85919		60675-003L	85976	
471700006269	85932	89453	58913-009	85959		60665003	83137		60675-006	85909	
471700131545	85006		58913-009L	85959		60665005	85919		60675-006L	85909	
47902-13	83122	89406	58913-011	85959		60665005L	85919		60675-007	83122	89406
47902-15	83137		58913-011L	85959		60665008	85978		60675-009	85978	
47902-18	85030	89440	58913-012	85932	89453	60665009	85043		60675-013	83123	89405
47902-19	83123	89405	58913-012L	85932	89453	60665020	85919		60675-014	85978	
47902-21	85976		58913003	85932	89453	60670-001	83123	89405	60675001	85978	
47902-24	83137		58913003L	85932	89453	60670-004	83123	89405	60675001L	85978	
47902-25	83125		58913007	85959		60670-005	83137		60675003	85976	
47902-27	83123	89405	58913007L	85959		60670-008	83123	89405	60675003L	85976	
47902-28	85013	89414	58913008	85959		60670-008L	83123	89405	60675006	85909	
47902-3	85005	89430	58913008L	85959		60670-009	85013	89414	60675006L	85909	
47902-8	83122	89406	58913009	85959		60670-011	83148		60675007	83122	89406
47902-9	83123	89405	58913009L	85959		60670-012	83168		60675009	85978	
4790213	83122	89406	58913011	85959		60670-013	83148		60675013	83123	89405
4790215	83137		58913011L	85959		60670-014	83166		60675014	85978	
4790218	85030	89440	58913012	85932	89453	60670-017	83148		606758Q	85976	
4790219	83123	89405	58913012L	85932	89453	60670-018	83166		60680-004	83143	
4790221	85976		59048-001	83148		60670-019	83166		60680-004L	83143	
4790224	83137		59048001	83148		60670-020	83148		60680-005	83142	
4790225	83125		59057-001	83137		60670-12	83168		60680-005L	83142	
4790227	83123	89405	59057001	83137		60670001	83123	89405	60680004	83143	
4790228	85013	89414	59483-000	85919		60670004	83123	89405	60680004L	83143	
479023	85005	89430	59483000	85919		60670005	83137		60680005	83142	
479028	83122	89406	59851-1	85976		60670008	83123	89405	60680005L	83142	
479029	83123	89405	598511	85976		60670008L	83123	89405	60998-001	85006	
57324-2	85976		60657-003	85072		60670009	85013	89414	60998-002	85919	
57324-6	85043		60657-003L	85072		60670011	83148		60998-002L	85919	
573242	85976		60657-004	85072		60670012	83168		60998-003	85006	
573246	85043		60657-007	85072		60670013	83148		60998001	85006	
57905-1	85976		60657003	85072		60670014	83166		60998002	85919	
579051	85976		60657003L	85072		60670017	83148		60998002L	85919	
58623-1	85978		60657004	85072		60670018	83166		60998003	85006	
586231	85978		60657007	85072		60670019	83166		654894	83123	89405
58913-003	85932	89453	60665-003	83137		60670020	83148				
58913-003L	85932	89453	60665-005	85919		6067012	83168				
58913-007	85959		60665-005L	85919		60675-001	85978				
58913-007L	85959		60665-008	85978		60675-001L	85978				

Important Note: Competitive Interchanges are to be used for stocking purposes only. Where multiple crosses are identified, please reference the applications section of this catalog. / **Remarque importante:** Les interchanges concurrentiels ne s'utilisent qu'aux fins de stocks. Dans le cas de rfrences multiples, consulter la section des applications du catalogue. / **Nota importante:** Dans le cas de rfrences multiples, consultar la seccion de aplicaciones del catalogo. / **Nota importante:** Se pueden usar intercambios competitivos para propósitos de almacenamiento solamente. Cuando se identifican intercambios múltiples, consulte la sección de aplicaciones de este catálogo.

COMPETITIVE & O.E.M. INTERCHANGE LIST
Lista de Intercambios contra Competidores y Equipo Original.
Liste dinterchange de produits comptitifs & dquipement original (OEM)

Hendrickson Truck Suspension Systems... cont'd

Hendrickson truck suspension systems	Gabriel	Upgrade	Hendrickson truck suspension systems	Gabriel	Upgrade	Hendrickson truck suspension systems	Gabriel	Upgrade	Hendrickson truck suspension systems	Gabriel	Upgrade
654895	83137		659202	83148		671009	85919		98583005	83168	
654898	83123	89405	659292	83148		671105	85072		98583006	83148	
654899	85013	89414	65992-003	85959		671603	85919		98583032	85072	
659000	83148		65992003	85959		671704	85043		AE76164-4	83225	
659004	83123	89405	665816	85072		98583-005	83168		AE761644	83225	
659048	83143		665892	85072		98583-006	83148		BE76164-4	83225	
659049	83142		671007	83137		98583-032	85072		BE761644	83225	

Hino

Hino	Gabriel	Upgrade	Hino	Gabriel	Upgrade	Hino	Gabriel	Upgrade	Hino	Gabriel	Upgrade
34802	83216		48530-1460	83215		4853137350	83519		60670014L	83166	
48500-1800	83216		48530-1770	83215		4853137351	83519		60670018	83166	
48500-1801	83216		48530-1880	83215		4853137361	83519		60670018L	83166	
48500-1940	83141		48530-1910	83216		4853137362	83519		60670019	83166	
48500-1941	83141		48530-2510	83216		60670-012	83168		60670019L	83166	
48500-1950	G63610		48530-E0100	83166		60670-013	83148		60670020	83148	
48500-2750	G63610		48530-E0250	83137		60670-014	83166		60670029L	83166	
48500-3710	83126	89430	48530-E0290	83166		60670-014L	83166		60670030	83166	
48500-3720	83140		48530-E0390	83166		60670-018	83166		60670030L	83166	
48500-E0420	83391		485301460	83215		60670-018L	83166		60670031L	83166	
485001800	83216		485301770	83215		60670-019	83166		66639	G63610	
485001940	83141		485301880	83215		60670-019L	83166		S4850-01941	83141	
485001941	83141		48530E0100	83166		60670-020	83148		S4850-01950	G63610	
485003710A	83126	89430	48530E0250	83137		60670-029L	83166		S4850-02750	G63610	
485003720	83140		48530E0290	83166		60670-030	83166		S4850-03710	83126	89430
48500E0420	83391		48530E0390	83166		60670-030L	83166		S4850-03720	83140	
48511-37320	83518		48531-37350	83519		60670-031L	83166		S485001941	83141	
48511-80162	83518		48531-37351	83519		60670012	83168		S485003720	83140	
4851137320	83518		48531-37361	83519		60670013	83148		S4853-01910	83216	
4851180162	83518		48531-37362	83519		60670014	83166		S4853-02510	83216	

Holiday Rambler

Holiday ramblar	Gabriel	Upgrade	Holiday ramblar	Gabriel	Upgrade	Holiday ramblar	Gabriel	Upgrade	Holiday ramblar	Gabriel	Upgrade
01809923	85029		9U94-18080-AA	83122	89406	ASH-25824	83122	89406	AT-621	83122	89406
01809924	83144		9U9418045AA	83209	89414	ASH-294	83209	89414	AT-766	83209	89414
01809925	85010		9U9418080AA	83122	89406	ASH1022	83209	89414	AT163G	G63622	
1C34-18045-AA	83209	89414	9U9Z-18124-A	83209	89414	ASH1023	83122	89406	AT164G	G63623	
1C34-18045-JA	83209	89414	9U9Z-18125-A	83122	89406	ASH1136	G63623		AT620	83209	89414
1C3418045AA	83209	89414	9U9Z18124A	83209	89414	ASH1154	G63622		AT621	83122	89406
1C3418045JA	83209	89414	9U9Z18125A	83122	89406	ASH1161	85006		AT766	83209	89414
24-153249	85125		ASH-1022	83209	89414	ASH1162	85005	89430	F4-BE5-A832-MO	85125	
24-153256	85124		ASH-1023	83122	89406	ASH1205	83209	89414	F4-BE5-B492-HO	85125	
24-186629	85125		ASH-1136	G63623		ASH1206	83122	89406	F4-BE5-F324-HO	85125	
24153249	85125		ASH-1154	G63622		ASH1228	83209	89414	F4-BE5-F325-HO	85124	
24153256	85124		ASH-1161	85006		ASH1229	83209	89414	F4BE5A832MO	85125	
24186629	85125		ASH-1162	85005	89430	ASH1230	83122	89406	F4BE5B492HO	85125	
8C24-18045-DA	G63622		ASH-1205	83209	89414	ASH137	83122	89406	F4BE5F324HO	85125	
8C24-18080-DB	G63623		ASH-1206	83122	89406	ASH25820	85005	89430	F4BE5F325HO	85124	
8C2418045DA	G63622		ASH-1228	83209	89414	ASH25821	85006		U0109-007	G63183	
8C2418080DB	G63623		ASH-1229	83209	89414	ASH25822	83209	89414	U0109007	G63183	
8C2Z-18124-D	G63622		ASH-1230	83122	89406	ASH25823	83209	89414	W0005662	85125	
8C2Z-18125-D	G63623		ASH-137	83122	89406	ASH25824	83122	89406	W0005663	85124	
8C2Z18124D	G63622		ASH-25820	85005	89430	ASH294	83209	89414	W0006254	85125	
8C2Z18125D	G63623		ASH-25821	85006		AT-163G	G63622				
90044794	83127		ASH-25822	83209	89414	AT-164G	G63623				
9U94-18045-AA	83209	89414	ASH-25823	83209	89414	AT-620	83209	89414			

Important Note: Competitive Interchanges are to be used for stocking purposes only. Where multiple crosses are identified, please reference the applications section of this catalog. / **Remarque importante:** Les interchanges concurrentiels ne s'utilisent qu'aux fins de stocks. Dans le cas de rferences multiples, consulter la section des applications du catalogue. / **Nota importante:** Dans le cas de rferences multiples, consulter la section des applications du catalogue. / **Nota importante:** Se pueden usar intercambios competitivos para propósitos de almacenamiento solamente. Cuando se identifican intercambios múltiples, consulte la sección de aplicaciones de este catálogo.

COMPETITIVE & O.E.M. INTERCHANGE LIST
Lista de Intercambios contra Competidores y Equipo Original.
Liste dinterchange de produits compititifs & dquipement original (OEM)

Holland-Binkley

Holland-binkley	Gabriel	Upgrade	Holland-binkley	Gabriel	Upgrade	Holland-binkley	Gabriel	Upgrade	Holland-binkley	Gabriel	Upgrade
6898	83125										

IC Corporation

lc corporation	Gabriel	Upgrade	lc corporation	Gabriel	Upgrade	lc corporation	Gabriel	Upgrade	lc corporation	Gabriel	Upgrade
1660846C92	83101		3601600C3	85082		3902993C1	83135		537524C91	83123	89405
2200327C1	85332		3604282C1	85351		3902993C2	83135		6127088C1	83163	
3533356C3	83169		3605735C1	83169		3902993C3	83135		6127713C1	85656	
3578105C1	83163		3605735C2	83169		472412C91	83456	89447	6127713C2	85656	
3578105C2	83163		3609400C1	83317		501906C91	83317		OE13402S	83163	
3578858C2	85656		3609400C2	83317		501906C92	83317		OE13424S	83317	

International

International	Gabriel	Upgrade	International	Gabriel	Upgrade	International	Gabriel	Upgrade	International	Gabriel	Upgrade
1201-1043	83025		2508326C1	83021		3578858C2	85656		4072186C1	85928	
1201-1044	83025		2508327C1	83025		3584116C1	83175		4089293C1	83397	
1201-1049	83025		2509221C91	83054		3584116C2	83175		4109458C2	83243	
1201-9007	83054		2509223C91	83054		3584117C1	83135		4109582C1	83397	
1201-9008	83054		2509223C92	83054		3584117C2	83135		4109583C1	83397	
1201-9009	83054		288920C91	83225		3584118C1	85928		4164146C1	83169	
12011043	83025		288921C91	83225		3584118C2	85928		4164149C1	85923	89458
12011044	83025		288921R92	83225		3586902C2	83364		4164155C1	85058	89431
12011049	83025		294334C91	83216		3586902C3	83364		4205983C1	83397	
12019007	83054		3000070C91	83456	89447	3588209C1	85957		4206863C1	83398	
12019008	83054		3000098C1	83317		3588209C2	85957		4207304C1	83397	
12019009	83054		306444C91	85012	89413	3596107C1	85927		4208946C1	83398	
1202-0042	83025		3085640C92	83216		3596107C2	85927		4211080C1	85957	
1202-0043	83025		308646C91	85012	89413	3596107C3	85927		4213760C1	83163	
1202-0044	83025		308648C91	83225		3596107C4	85927		4214011C2	85670	
1202-0054	83021		308649C91	83216		3601600C1	85082		452566C91	83225	
1202-1043	83025		308650C91	83216		3601600C2	85082		453527C91	85311	89424
1202-1044	83025		308650C92	83216		3601600C3	85082		453528C91	85311	89424
12020042	83025		308668C91	85012	89413	3604282C1	85351		453556C91	85012	89413
12020043	83025		308668C92	85012	89413	360444C91	85012	89413	453561C91	83225	
12020044	83025		308669C91	85012	89413	3606770C1	83163		453562C91	83225	
12020054	83021		320444C91	85012	89413	3606770C2	83163		453564C91	85012	89413
12021043	83025		329316C92	85012	89413	3609400C1	83317		453565C91	83225	
12021044	83025		3514952C1	85976		3609400C2	83317		453566C91	83225	
1660846C91	83101		3533356C1	83135		3626571C1	85072		453567C91	83216	
1660846C92	83101		3533356C2	83135		3626571C2	85072		453568C91	83225	
1664149C1	85029		3533356C3	83169		3688614C1	85923	89458	453569C91	83225	
1667520C1	85058	89431	3533357C1	85957		3688616C1	85923	89458	453570C91	83216	
1677707C1	85030	89440	3533357C2	85957		3806341C3	85995		453571C91	83216	
2015557C1	85030	89440	3533357C3	85957		3806341C4	85995		453572C91	83309	
2029200C91	83126	89430	3544768C1	85656		3810581C3	85995		453575C91	83308	
2029200C91	85030	89440	3544768C2	85656		3810581C4	85995		462753C91	83216	
204994R91	83225		3549099C1	85923	89458	383379C91	83308		467371C91	83225	
206620R91	83216		3549099C2	85923	89458	384435C91	83216		467372C91	83225	
206621R91	83216		3549099C3	85923	89458	3868265C1	85995		467983C91	85012	89413
206621R92	83216		3549100C1	85656		3885832C1	83135		467984C91	83216	
210533R91	83225		3553628C1	85927		3885832C2	83135		467985C91	85012	89413
210534R92	83225		3553628C2	85927		3892458C1	85656		471201C91	85012	89413
210535R91	83225		3553628C3	85927		3892458C2	85656		471203C91	83308	
210536R91	83225		3553628C4	85927		3902993C1	83135		472411C91	83456	89447
210537R91	83225		3560705C2	83054		3902993C3	83135		472412C91	83456	89447
210538R91	83225		3576464C1	85957		3914952C1	85976		474002C91	83308	
210918R91	83215		3576464C2	85957		3945165C1	83180				
2200327C1	85332		3578105C1	83163		3989717C1	83135				
2503529C1	83025		3578105C2	83163		3991991C1	83135				
2507948C1	83054		3578858C1	85656		4070336C1	85058	89431			

Important Note: Competitive Interchanges are to be used for stocking purposes only. Where multiple crosses are identified, please reference the applications section of this catalog. / **Remarque importante:** Les interchanges concurrentiels ne s'utilisent qu'aux fins de stocks. Dans le cas de références multiples, consulter la section des applications du catalogue. / **Nota importante:** Dans le cas de referencias multiples, consultar la sección des aplicaciones du catalogue. / **Nota importante:** Se pueden usar intercambios competitivos para propósitos de almacenamiento solamente. Cuando se identifican intercambios múltiples, consulte la sección de aplicaciones de este catálogo.

COMPETITIVE & O.E.M. INTERCHANGE LIST
Lista de Intercambios contra Competidores y Equipo Original.
Liste dinterchange de produits comptitifs & dquipement original (OEM)

International... cont'd

International	Gabriel	Upgrade	International	Gabriel	Upgrade	International	Gabriel	Upgrade	International	Gabriel	Upgrade
47902-24	83137		56110T8129	G63432		6127088C1	83163		AMS600102	85005	89430
4790224	83137		57905-001	85976		6127096C1	83180		AMS600172	83126	89430
4C4Z-18124-N	85957		57905001	85976		6127688C1	83169		AMS600172	85005	89430
4C4Z-18125-DA	85656		586724C91	83456	89447	6127690C1	85923	89458	AMS600172	85030	89440
4C4Z18124N	85957		60657-003	85072		6127700C1	83395		AMS650102	85001	89410
4C4Z18125DA	85656		60657-003L	85072		6127704C1	85670		AMS650400	85033	89427
501506C91	83317		60657003	85072		6127713C1	85656		AMS650402	85311	89424
501906C91	83317		60657003L	85072		6127713C2	85656		AMS650404	85310	89423
501906C92	83317		60675-003	85976		6127714C1	85928		AMS650420	85013	89414
507202C1	85030	89440	60675-003L	85976		66400	G63432		H60657-003	85072	
537524C91	83123	89405	60675003	85976		6ETZ-18125-A	83364		H60657003	85072	
537525C91	83123	89405	60675003L	85976		6ETZ18125A	83364		H60675-003	85976	
540395C91	83613		60680-004	83143		790335C91	83209	89414	H60675003	85976	
540395C92	83613		60680-004L	83143		873619C92	83314		H60680004	83143	
56101 Z1030	85311	89424	60680-005	83142		873619C93	83314		HDR60680-005	83142	
56101 Z2000	85311	89424	60680-005L	83142		873622C91	83308		OE18513	83135	
56101 Z5008	83114		60680004	83143		874695R91	85012	89413	OE13402S	83163	
56101 Z5011	G63610		60680004L	83143		874695R92	85012	89413	OE13424S	83317	
56110-T8123	G63432		60680005	83142		874696R91	85012	89413	OE17103	83135	
56110-T8129	G63432		60680005L	83142		90044025	83209	89414			
56110T8123	G63432		6127087C1	83364		90044626	83126	89430			

Isuzu

Isuzu	Gabriel	Upgrade	Isuzu	Gabriel	Upgrade	Isuzu	Gabriel	Upgrade	Isuzu	Gabriel	Upgrade
1-51630-160-0	83162		8-22064804-0	83136		8-98380-746-0	83159		8982326711	83515	
1-51630-167-0	83613		8-22064805-0	83136		8-98380-747-0	83159		8982326720	83515	
1-51630-168-1	83515		8-94454-647-1	83515		8-98381-010-0	83515		8982326721	83515	
1-51630-217-0	83114		8-94454-986-0	83515		8-98381-012-0	83515		8983162280	83159	
1-51630-217-1	83114		8-94454-987-0	83515		8220642320	85071		8983219121	85071	
1-51630-219-0	83114		8-97083-027-0	83515		8220642330	83136		8983807460	83159	
1-51630-219-1	83114		8-97083-029-0	83515		8220648040	83136		8983807470	83159	
12474915	83122	89406	8-97253-616-0	83515		8220648050	83136		8983810100	83515	
15123676	83136		8-97253-620-0	83515		8220648060	83136		8983810120	83515	
1516301600	83162		8-97253-620-1	83515		8220648070	83136		9-51630-647-1	83515	
1516301670	83613		8-97253-621-0	83515		88982682	83136		9-51630-666-0	85012	89413
1516301681	83515		8-97253-623-0	83515		88982686	85071		9-51630-666-2	85012	89413
15174902	85071		8-97253-651-2	83159		8944549870	83515		94454986	83515	
15887728	83136		8-97253-664-0	83159		8970830270	83515		94454987	83515	
19152843	83136		8-97253-665-0	83159		8970830290	83515		9516306660	85012	89413
51630168	83515		8-97517-966-0	83137		8972019600	83515		9516306662	85012	89413
51630217	83114		8-97517-966-1	83137		8972536160	83515		97083027	83515	
51630219	83114		8-98098-058-0	83159		8972536200	83515		97083029	83515	
51630647	83515		8-98098-058-1	83159		8972536201	83515		97253620	83515	
51630666	85012	89413	8-98098-059-0	83159		8972536210	83515		97253651	83159	
60670-005	83137		8-98098-059-1	83159		8972536230	83515		97253664	83159	
60670-005L	83137		8-98098-125-0	83515		8975179660	83137		97253665	83159	
60670005	83137		8-98098-127-0	83515		8975179661	83137		98098058	83159	
60670005L	83137		8-98232671-0	83515		898098-0581	83159		98098059	83159	
8-22064-233-0	83136		8-98232671-1	83515		898098-1250	83515		98098125	83515	
8-22064-804-0	83136		8-98232672-0	83515		898098-1270	83515		98098127	83515	
8-22064-805-0	83136		8-98232672-1	83515		8980980590	83159		98232671	83515	
8-22064-806-0	83136		8-98316-228-0	83159		8980980591	83159		98232672	83515	
8-22064-807-0	83136		8-98316227-0	83159		8980981250	83515		98316227	83159	
8-22064232-0	85071		8-98321-912-1	85071		8980981270	83515		98343986	83159	
8-22064233-0	83136		8-98343986-0	83159		8982326710	83515				

Important Note: Competitive Interchanges are to be used for stocking purposes only. Where multiple crosses are identified, please reference the applications section of this catalog. / **Remarque importante:** Les interchanges concurrentiels ne s'utilisent qu'aux fins de stocks. Dans le cas de rferences multiples, consulter la section des applications du catalogue. / **Nota importante:** Dans le cas de rferences multiples, consulter la section des applications du catalogue. / **Nota importante:** Se pueden usar intercambios competitivos para propósitos de almacenamiento solamente. Cuando se identifican intercambios múltiples, consulte la sección de aplicaciones de este catálogo.

COMPETITIVE & O.E.M. INTERCHANGE LIST
Lista de Intercambios contra Competidores y Equipo Original.
Liste dinterchange de produits comptitifs & dquipement original (OEM)

Itasca

Itasca	Gabriel	Upgrade	Itasca	Gabriel	Upgrade	Itasca	Gabriel	Upgrade	Itasca	Gabriel	Upgrade
141700131809	85029		24153256	85124		ASH-1154	G63622		AT-620	83209	89414
141700131810	83160		24186629	85125		ASH-1205	83209	89414	AT-621	83122	89406
16-16736-000	85029		481700000493	85900		ASH-1206	83122	89406	AT-766	83209	89414
16-16737-000	83160		66153-002	83124	89407	ASH-1228	83209	89414	AT621	83122	89406
16-16873-000	85029		66153002	83124	89407	ASH-1229	83209	89414	F4-BE5-A832-MO	85125	
16-16874-000	83160		8C24-18045-DA	G63622		ASH-1230	83122	89406	F4-BE5-B492-HO	85125	
16-18103-000	85900		8C24-18080-DB	G63623		ASH-137	83122	89406	F4-BE5-C832-MO	83124	89407
1616736000	85029		8C2Z-18124-D	G63622		ASH-25822	83209	89414	F4-BE5-F324-HO	85125	
1616737000	83160		8C2Z-18125-D	G63623		ASH-25823	83209	89414	F4-BE5-F325-HO	85124	
1616873000	85029		9U94-18045-AA	83209	89414	ASH-25824	83122	89406	F4BE5A832MO	85125	
1616874000	83160		9U94-18080-AA	83122	89406	ASH-294	83209	89414	F4BE5B492HO	85125	
1618103000	85900		9U9418080AA	83122	89406	ASH1023	83122	89406	F4BE5C832MO	83124	89407
1C34-18045-AA	83209	89414	9U9Z-18124-A	83209	89414	ASH1206	83122	89406	F4BE5F324HO	85125	
1C34-18045-JA	83209	89414	9U9Z-18125-A	83122	89406	ASH1230	83122	89406	F4BE5F325HO	85124	
24-153249	85125		9U9Z18125A	83122	89406	ASH137	83122	89406	W0005662	85125	
24-153256	85124		ASH-1022	83209	89414	ASH25824	83122	89406	W0005663	85124	
24-186629	85125		ASH-1023	83122	89406	AT-163G	G63622		W0006254	85125	
24153249	85125		ASH-1136	G63623		AT-164G	G63623				

Jayco RV Inc.

Jayco rv inc.	Gabriel	Upgrade	Jayco rv inc.	Gabriel	Upgrade	Jayco rv inc.	Gabriel	Upgrade	Jayco rv inc.	Gabriel	Upgrade
ASH-1136	G63623		ASH-1229	83209	89414	ASH-25823	83209	89414	ASH25824	83122	89406
ASH-1154	G63622		ASH-25822	83209	89414	ASH-25824	83122	89406			

John Deere

John deere	Gabriel	Upgrade	John deere	Gabriel	Upgrade	John deere	Gabriel	Upgrade	John deere	Gabriel	Upgrade
3638112	G63183		4036892	G63605							

Kenworth

Kenworth	Gabriel	Upgrade	Kenworth	Gabriel	Upgrade	Kenworth	Gabriel	Upgrade	Kenworth	Gabriel	Upgrade
02-02736-2	85302	89420	03-07423PLUS-2	85033	89427	1202K064	83024		60670005L	83137	
02-02736PLUS	85302	89420	03-08781	85069	89455	1202K286	83056		60670005PLUS	83137	
02-02736PLUS-2	85302	89420	03-08781-2	85069	89455	16725-01	83126	89430	60670008	83123	89405
02-02738-2	85012	89413	0306084PLUS	85033	89427	1672501	83126	89430	60670008L	83123	89405
02-02738PLUS	85012	89413	0306084PLUS2	85033	89427	1707378PAC	85182		60670008PLUS	83123	89405
02-02738PLUS-2	85012	89413	0307421PLUS	85311	89424	19495-01	83126	89430	60670008PLUS2	83123	89405
02-02739-2	85013	89414	03074232	85033	89427	1949501	83126	89430	60680-004	83143	
02-02739PLUS	85013	89414	0307423PLUS	85033	89427	2027382	85012	89413	60680-004L	83143	
02-02741-2	85012	89413	0307423PLUS2	85033	89427	47902-13PLUS	83122	89406	60680-005	83142	
02-04010-2	85012	89413	0308781	85069	89455	47902-19	83123	89405	60680-005L	83142	
02-0739PLUS-2	85013	89414	03087812	85069	89455	47902-24	83137		60680004	83143	
02027362	85302	89420	1201-1043	83025		4790213PLUS	83122	89406	60680004L	83143	
0202736PLUS	85302	89420	1201-1044	83025		4790219	83123	89405	60680005	83142	
0202736PLUS2	85302	89420	12011043	83025		4790224	83137		60680005L	83142	
0202738PLUS	85012	89413	12011044	83025		60657-003	85072		64178-001	83143	
0202738PLUS2	85012	89413	1202-0042	83025		60657-003L	85072		64178001	83143	
02027392	85013	89414	1202-0043	83025		60657003	85072		665092	83312	89409
0202739PLUS	85013	89414	1202-0044	83025		60657003L	85072		665118	83312	89409
02027412	85012	89413	1202-0054	83021		60670-004	83123	89405	665453	85001	89410
02040102	85012	89413	1202-1043	83025		60670-005	83137		665565	85007	
020739PLUS2	85013	89414	1202-1064	83024		60670-005L	83137		665565PLUS	85007	
03-06084PLUS	85033	89427	1202-1286	83056		60670-005PLUS	83137		665565PLUS-2	85007	
03-06084PLUS-2	85031		12020042	83025		60670-005PLUS-2	83137		665565PLUS2	85007	
03-06084PLUS-2	85033	89427	12020043	83025		60670-008	83123	89405	665617	85031	
03-07421PLUS	85311	89424	12020044	83025		60670-008L	83123	89405	665617-2	85031	
03-07423-2	85031		12020054	83021		60670-008PLUS	83123	89405	6656172	85031	
03-07423-2	85033	89427	12021043	83025		60670-008PLUS-2	83123	89405	665632	85013	89414
03-07423PLUS	85033	89427	12021064	83024		60670004	83123	89405	665633	85033	89427
03-07423PLUS-2	85031		12021286	83056		60670005	83137		665670	85001	89410

Important Note: Competitive Interchanges are to be used for stocking purposes only. Where multiple crosses are identified, please reference the applications section of this catalog. / **Remarque importante:** Les interchanges concurrentiels ne s'utilisent qu'aux fins de stocks. Dans le cas de rferences multiples, consulter la section des applications du catalogue. / **Nota importante:** Dans le cas de rferences multiples, consultar la section des aplicaciones du catalogue. / **Nota importante:** Se pueden usar intercambios competitivos para propósitos de almacenamiento solamente. Cuando se identifican intercambios múltiples, consulte la sección de aplicaciones de este catálogo.

COMPETITIVE & O.E.M. INTERCHANGE LIST
Lista de Intercambios contra Competidores y Equipo Original.
Liste dinterchange de produits comptitifs & dquipement original (OEM)

Kenworth... cont'd

Kenworth	Gabriel	Upgrade	Kenworth	Gabriel	Upgrade	Kenworth	Gabriel	Upgrade	Kenworth	Gabriel	Upgrade
665680	83312	89409	ACHB966	83136		C71-1011PLUS-2	85069	89455	K374-32-2	85310	89423
665738-2	85910		B71-1000	85031		C71-1011SPL	85069	89455	K374-33	83312	89409
665783	83123	89405	B71-1001	85070	89459	C71-1013	85985		K374-33-2	83312	89409
665784	83122	89406	B71-1002	85001	89410	C71-1014	85936	89456	K374-33PLUS	83312	89409
665785	83137		B71-1003	83312	89409	C71-1016	85067	89451	K374-33PLUS-2	83312	89409
665828	85067	89451	B71-6000	85959		C71-1017	85069	89455	K374-4	85314	89425
665844	85069	89455	B71-6000-2	85959		C71-6000-2	85067	89451	K374-5	83312	89409
665858	85070	89459	B71-6002	85012	89413	C71-6003	85988		K374-7	85310	89423
665858-2	85070	89459	B71-6002-2	85012	89413	C71-6005	85069	89455	K374-9	85310	89423
6658582	85070	89459	B71-6003	85029		C71-6015	85067	89451	K374-C31	83312	89409
665903	85900		B71-6003-2	85029		C711002	85067	89451	K374-C7	85310	89423
665906	85902		B71-6004	85084	89460	C7110022	85067	89451	K37410	83215	
665918	85900		B71-6005	85084	89460	C711002PLUS	85067	89451	K374102	83215	
665930	85001	89410	B71-6006	85084	89460	C711002PLUS2	85067	89451	K37411	85001	89410
665931	83312	89409	B71-6008	83312	89409	C711011	85069	89455	K37414	83312	89409
665932	85012	89413	B71-6013	85012	89413	C711011PLUS	85069	89455	K37416	85001	89410
665944	85900		B71-6015	85012	89413	C711011PLUS2	85069	89455	K37426	85001	89410
665944-2	85900		B71-6016	85012	89413	C711011SPL	85069	89455	K374262	85001	89410
665945	85902		B71-6017	85910		C711013	85985		K37426PLUS	85001	89410
665945-2	85902		B71-6018	85012	89413	C711014	85936	89456	K37426PLUS2	85001	89410
665950	85902		B71-6019	85989		C711016	85067	89451	K37427	85001	89410
671052	85070	89459	B71-6020	85989		C711017	85069	89455	K374272	85001	89410
671052-2	85070	89459	B711000	85031		C7160002	85067	89451	K37428	85314	89425
6710522	85070	89459	B711001	85070	89459	C716003	85988		K374282	85314	89425
671654	85936	89456	B711002	85001	89410	C716005	85069	89455	K37428PLUS	85314	89425
671656	85985		B711003	83312	89409	C716015	85067	89451	K37429	85310	89423
671794	85067	89451	B716000	85959		K374-10	83215		K374292	85310	89423
671962	85936	89456	B716002	85012	89413	K374-10-2	83215		K37429PLUS	85310	89423
671962PLUS	85936	89456	B716003	85029		K374-11	85001	89410	K37429PLUS2	85310	89423
671962SPL	85936	89456	B716004	85084	89460	K374-14	83312	89409	K3743	83312	89409
675122	85001	89410	B716005	85084	89460	K374-16	85001	89410	K37431	83312	89409
680239	85310	89423	B716006	85084	89460	K374-26	85001	89410	K37432	85310	89423
680240	85302	89420	B716008	83312	89409	K374-26-2	85001	89410	K374322	85310	89423
680241	85311	89424	B716013	85012	89413	K374-26PLUS	85001	89410	K37433	83312	89409
680253	85314	89425	B716015	85012	89413	K374-26PLUS-2	85001	89410	K37433PLUS	83312	89409
680279	83209	89414	B716016	85012	89413	K374-27	85001	89410	K3744	85314	89425
680303	85007		B716017	85910		K374-27-2	85001	89410	K3745	83312	89409
680435	85033	89427	B716018	85012	89413	K374-28	85314	89425	K3747	85310	89423
680475	85314	89425	B716019	85989		K374-28-2	85314	89425	K3749	85310	89423
680476	85310	89423	B716020	85989		K374-28PLUS	85314	89425	K374C31	83312	89409
680486	85310	89423	BFRG 072	85182		K374-29	85310	89423	K374C7	85310	89423
680586	85311	89424	C71-1002	85067	89451	K374-29-2	85310	89423	R71-1005	83024	
70701	85900		C71-1002-2	85067	89451	K374-29PLUS	85310	89423	R711005	83024	
70701PLUS	85900		C71-1002PLUS	85067	89451	K374-29PLUS-2	85310	89423	T71-1003	83056	
70701PLUS-2	85900		C71-1002PLUS-2	85067	89451	K374-3	83312	89409	T711003	83056	
90044025PLUS	83209	89414	C71-1011	85069	89455	K374-3-1	83312	89409	TK19679	83126	89430
90045132	85909		C71-1011PLUS	85069	89455	K374-32	85310	89423			

King Of The Road

King of the road	Gabriel	Upgrade	King of the road	Gabriel	Upgrade	King of the road	Gabriel	Upgrade	King of the road	Gabriel	Upgrade
141700131809	85029		16-16873-000	85029		1616737000	83160		481700000493	85900	
141700131810	83160		16-16874-000	83160		1616873000	85029				
16-16736-000	85029		16-18103-000	85900		1616874000	83160				
16-16737-000	83160		1616736000	85029		1618103000	85900				

Koni

Koni	Gabriel	Upgrade	Koni	Gabriel	Upgrade	Koni	Gabriel	Upgrade	Koni	Gabriel	Upgrade
30-1366	G63610		82-1952	G63347		82-1954	G63355		82-1970	G63350	

Important Note: Competitive Interchanges are to be used for stocking purposes only. Where multiple crosses are identified, please reference the applications section of this catalog. / **Remarque importante:** Les interchanges concurrentiels ne s'utilisent qu'aux fins de stocks. Dans le cas de références multiples, consulter la section des applications du catalogue. / **Nota importante:** Dans le cas de referencias multiples, consultar la sección de aplicaciones del catálogo. / **Nota importante:** Se pueden usar intercambios competitivos para propósitos de almacenamiento solamente. Cuando se identifican intercambios múltiples, consulte la sección de aplicaciones de este catálogo.

COMPETITIVE & O.E.M. INTERCHANGE LIST
Lista de Intercambios contra Competidores y Equipo Original.
Liste dinterchange de produits comptitifs & dquipement original (OEM)

Koni... cont'd

Koni	Gabriel	Upgrade	Koni	Gabriel	Upgrade	Koni	Gabriel	Upgrade	Koni	Gabriel	Upgrade
82-2158	G63357		88-1558	85013	89414	8805-1018	83209	89414	90-1898	83215	
82-2246	G63299		88-1561	85012	89413	8805-1019	83122	89406	90-1922	85900	
8240-1029	G63386		88-1641	85029		8805-1020	83160		90-1974	85311	89424
88-1417	83312	89409	88-1641SP3	85029		8805-1022	85724	89443	90-2209-SP2	85001	89410
88-1419	83136		88-1646	83613		8805-1023	83136		90-2257	85716	
88-1422	85030	89440	88-1647	83317		8805-1042	G63622		90-2477	85900	
88-1457-SP1	83209	89414	88-1704	85030	89440	8805-1043	G63623		90-2478	85902	
88-1458-SP1	83122	89406	88-5162	83209	89414	8850-1002	G63622		90-2563	85006	
88-1458-SP2	83122	89406	88-5163	83122	89406	90-1577-SP1	85310	89423	99B-3254	85029	
88-1468	83209	89414	8805-1001	85125		90-1811	85301				
88-1499	85001	89410	8805-1002	85124		90-1896	85302	89420			

Krystal Bus

Krystal bus	Gabriel	Upgrade	Krystal bus	Gabriel	Upgrade	Krystal bus	Gabriel	Upgrade	Krystal bus	Gabriel	Upgrade
ASH-1136	G63623		ASH-1154	G63622		ASH1136	G63623		ASH1154	G63622	

KYB

Kyb	Gabriel	Upgrade	Kyb	Gabriel	Upgrade	Kyb	Gabriel	Upgrade	Kyb	Gabriel	Upgrade
340084	83515		345614	83309		554236	77614		KG5401	G63299	
341614	85001	89410	345615	83314		554238	77614		KG5406	G63386	
341615	83215		345616	83125		554239	77607		KG54100	77638	
341617	85005	89430	345618	83126	89430	554240	77808		KG54101	77638	
341618	85918	89449	345620	83456	89447	554241	77808		KG54102	77661	
341619	83136		349004	58944		554246	77783		KG54103	77674	
341620	85033	89427	349119	83159		554247	77817		KG54103	77948	
341621	85311	89424	349127	83159		554249	77412		KG54103	77980	
341627	85006		441133	83515		554260	77414		KG54104	77662	
341628	85724	89443	441600	85310	89423	554270	77412		KG5420	G63366	
341633	83215		441602	85724	89443	554274	77614		KG5421	G63387	
343149	82155		444058	83159		554312	77375		KG5422	G63183	
343219	81270		444203	83515		554319	77817		KG54306	77675	
3440029	77967		444209	83114		554322	77949		KG54311	77714	
344049	G63414		444269	83159		554324	77638		KG54313	77716	
344067	G63347		444328	83159		554344	77638		KG54314	77715	
344068	G63355		445016	83515		554347	77951		KG54315	77673	
344077	G63406		445054	83613		554347	77967		KG54320	77455	
344085	G63306		445064	83162		554348	77638		KG54321	77403	
344264	G63387		445067	85009		554359	77949		KG54322	77403	
344267	G63455		446075	83215		554360	77950		KG54326	77783	
344268	G63614		5540000	77951		554362	77968		KG54329	77607	
344272	G63386		5540022	77976		554362	77969		KG54330	77809	
344304	G63375		554153	77489		554369	77807		KG54330	G63809	
344364	77980		554154	77638		554370	77623		KG54331	77837	
344366	G63366		554161	77375		554380	83159		KG54331	G63837	
344367	G63714		554163	77609		554383	83159		KG54332	77808	
344368	G63716		554166	77716		554388	77952		KG54333	77810	
344370	G63622		554168	77461		5550006	77976		KG54333	G63810	
344371	G63623		554177	77614		555038	77614		KG54339	77783	
344374	G63778		554186	77716		555039	77623		KG54340	77817	
344426	G63299		554187	77715		555055	77976		KG54341	77662	
345025	83515		554199	77950		555056	77952		KG54342	77412	
345061	77949		554206	77638		565033	77638		KG5440	77414	
345080	G63622		554207	77661		565060	77375		KG5440	G63350	
345601	83613		554208	77661		565062	77609		KG5458	77375	
345605	85012	89413	554209	77662		565068	77412		KG5478	77489	
345606	83136		554216	77662		565090	77809				
345609	83515		554223	77662		565091	77809				
345611	83120		554228	77661		565101	77783				
345613	85005	89430	554233	77783		KG5196	77950				

Important Note: Competitive Interchanges are to be used for stocking purposes only. Where multiple crosses are identified, please reference the applications section of this catalog. / **Remarque importante:** Les interchanges concurrentiels ne s'utilisent qu'aux fins de stocks. Dans le cas de rferences multiples, consulter la section des applications du catalogue. / **Nota importante:** Dans le cas de rferences multiples, consulter la section des applications du catalogue. / **Nota importante:** Se pueden usar intercambios competitivos para propósitos de almacenamiento solamente. Cuando se identifican intercambios múltiples, consulte la sección de aplicaciones de este catálogo.

COMPETITIVE & O.E.M. INTERCHANGE LIST
Lista de Intercambios contra Competidores y Equipo Original.
Liste dinterchange de produits comptitifs & dquipement original (OEM)

KYB... cont'd

Kyb	Gabriel	Upgrade	Kyb	Gabriel	Upgrade	Kyb	Gabriel	Upgrade	Kyb	Gabriel	Upgrade
KG5479	77488		KG5498	G63623		KG6010	83308		KG6416	83123	89405
KG5480	77609		KG5534	G63610		KG6199	85012	89413	SS10202	14072	
KG5482	77412		KG5572	77375		KG6201	83456	89447	SS10309	6854SE	
KG5488	G63403		KG5786	77949		KG6403	G63605		SS10318	6853SE	
KG5489	77614		KG6002A	85030	89440	KG6406	G63183		SS10322	6856SE	
KG5489	G63614		KG6003	83309		KG6412	G63625		SS10323	6847SE	
KG5493	77461		KG6005	83216		KG6413	77614		SS10325	14017	
KG5497	77807		KG6006	85012	89413	KG6413	G63622		SS10325	6804SE	
KG5497	G63622		KG6007	85007		KG6414	77623		SS15345	6802SE	
KG5498	77623		KG6008A	83122	89406	KG6415	85013	89414	SS15489	6855SE	

Les Schwab

Les schwab	Gabriel	Upgrade	Les schwab	Gabriel	Upgrade	Les schwab	Gabriel	Upgrade	Les schwab	Gabriel	Upgrade
14017	14017		58809	58809		6828SE	6828SE		77810	77810	
14072	14072		58810	58810		6847SE	6847SE		77817	77817	
34036	34036		58817	58817		6850SE	6850SE		77837	77837	
34052	34052		58944	58944		6853SE	6853SE		77948	77948	
34058	34058		61516	61516		6854SE	6854SE		77949	77949	
34073	34073		61517	61517		6855SE	6855SE		77950	77950	
34076	34076		61518	61518		6856SE	6856SE		77951	77951	
43048	43048		61519	61519		6861SE	6861SE		77952	77952	
43058	43058		61521	61521		70034	85302	89420	77967	77967	
43085	43085		61523	61523		71500	61500		77968	77968	
43099	43099		61524	61524		71520	61520		77969	77969	
43111	43111		61525	61525		71522	61522		77976	77976	
43140	43140		61530	61530		71542	61542		77980	77980	
43163	43163		61543	61543		71565	61565		81039	81039	
43167	43167		61544	61544		71600	61600		81082	81082	
43180	43180		61546	61546		71611	61611		81091	81091	
43181	43181		61547	61547		71613	61613		81096	81096	
49107	49107		61554	61554		71638	61638		81113	81113	
49127	49127		61555	61555		71641	61641		81147	81147	
49149	49149		61591	61591		77375	77375		81164	81164	
49155	49155		61599	61599		77403	77403		81242	81242	
49162	49162		61612	61612		77412	77412		81270	81270	
49173	49173		61614	61614		77414	77414		81342	81342	
49178	49178		61632	61632		77455	77455		81394	81394	
49212	49212		61634	61634		77461	77461		81484	81484	
49218	49218		61635	61635		77488	77488		81490	81490	
49231	49231		61642	61642		77489	77489		81496	81496	
49235	49235		61646	61646		77607	77607		81510	81510	
49237	49237		61654	61654		77609	77609		81667	81667	
49310	49310		61655	61655		77614	77614		81668	81668	
58357	58357		61656	61656		77623	77623		81676	81676	
58359	58359		61663	61663		77638	77638		81710	81710	
58403	58403		61680	61680		77661	77661		81713	81713	
58412	58412		61682	61682		77662	77662		81726	81726	
58488	58488		61683	61683		77673	77673		81744	81744	
58489	58489		61685	61685		77674	77674		81821	81821	
58609	58609		61687	61687		77675	77675		81825	81825	
58622	58622		61710	61710		77714	77714		81828	81828	
58623	58623		61713	61713		77715	77715		81834	81834	
58638	58638		61714	61714		77716	77716		81873	81873	
58662	58662		61716	61716		77783	77783		81892	81892	
58714	58714		6802SE	6802SE		77807	77807		81912	81912	
58807	58807		6803SE	6803SE		77808	77808		81913	81913	
58808	58808		6804SE	6804SE		77809	77809		81914	81914	

Important Note: Competitive Interchanges are to be used for stocking purposes only. Where multiple crosses are identified, please reference the applications section of this catalog. / **Remarque importante:** Les interchanges concurrentiels ne s'utilisent qu'aux fins de stocks. Dans le cas de références multiples, consulter la section des applications du catalogue. / **Nota importante:** Dans le cas de références multiples, consulter la section des applications du catalogue. / **Nota importante:** Se pueden usar intercambios competitivos para propósitos de almacenamiento solamente. Cuando se identifican intercambios múltiples, consulte la sección de aplicaciones de este catálogo.

COMPETITIVE & O.E.M. INTERCHANGE LIST
Lista de Intercambios contra Competidores y Equipo Original.
Liste dinterchange de produits comptitifs & dquipement original (OEM)

Les Schwab... cont'd

Les schwab	Gabriel	Upgrade	Les schwab	Gabriel	Upgrade	Les schwab	Gabriel	Upgrade	Les schwab	Gabriel	Upgrade
81919	81919		G60408	G63347		G60617	G63674		G63609	G63609	
81920	81920		G60410	G63349		G60618	G63675		G63625	G63625	
81921	81921		G60414	G63355		G60657	G63714		G63638	G63638	
81925	81925		G60415	G63357		G60658	G63715		G63661	G63661	
81928	81928		G60417	G63359		G60659	G63716		G63671	G63671	
82003	82003		G60423	G63386		G61524	G63783		G63692	G63692	
82007	82007		G60424	G63387		G61550	G63809		G63778	G63778	
82012	82012		G60428	G63183		G61551	G63810		G63808	G63808	
82034	82034		G60433	G63410		G61558	G63817		G63837	G63837	
82035	82035		G60435	G63409		G61886	G63886		G63893	G63893	
82047	82047		G60438	G63414		G61888	G63888		G63895	G63895	
82065	82065		G60439	G63413		G62011	G64011		G63897	G63897	
82086	82086		G60476	G63375		G62013	G64013		G63918	G63918	
82147	82147		G60480	G63455		G63299	G63299		G63969	G63969	
82155	82155		G60484	G63461		G63306	G63306		G63971	G63971	
G51856	G51856		G60497	G63488		G63350	G63350		G64009	G64009	
G56778	G56778		G60498	G63489		G63353	G63353		G64010	G64010	
G57147	G57147		G60511	G63403		G63360	G63360		G64043	G64043	
G57800	G57800		G60561	G63607		G63366	G63366		G64044	G64044	
G57801	G57801		G60571	G63614		G63394	G63394		G64089	G64089	
G57816	G57816		G60582	G63622		G63406	G63406		G64121	G64121	
G60031	G63405		G60583	G63623		G63411	G63411		G64148	G64148	
G60042	G63377		G60606	G63662		G63456	G63456		G64164	G64164	
G60164	G63610		G60616	G63673		G63605	G63605		G64177	G64177	

Leyland Truck

Leyland truck	Gabriel	Upgrade	Leyland truck	Gabriel	Upgrade	Leyland truck	Gabriel	Upgrade	Leyland truck	Gabriel	Upgrade
1456033	85311	89424									

LGE Coachworks

Lge coachworks	Gabriel	Upgrade	Lge coachworks	Gabriel	Upgrade	Lge coachworks	Gabriel	Upgrade	Lge coachworks	Gabriel	Upgrade
ASH-1136	G63623		ASH-1154	G63622							

Link Manufacturing LTD.

Link manufacturing ltd.	Gabriel	Upgrade	Link manufacturing ltd.	Gabriel	Upgrade	Link manufacturing ltd.	Gabriel	Upgrade	Link manufacturing ltd.	Gabriel	Upgrade
1201-1043	83025		12019009	83054		12020042	83025		1210-0528	85043	
1201-1044	83025		1202-0042	83025		12020043	83025		12100528	85043	
1201-1049	83025		1202-0043	83025		12020044	83025		654669	83021	
1201-9007	83054		1202-0044	83025		12020052	83021		654799	83025	
1201-9008	83054		1202-0052	83021		12020054	83021		654811	83024	
1201-9009	83054		1202-0054	83021		12021042	83025		654833	83021	
12011043	83025		1202-1042	83025		12021043	83025		654867	83025	
12011044	83025		1202-1043	83025		12021044	83025		671093	85043	
12011049	83025		1202-1044	83025		12021064	83024		R71-1005	83024	
12019007	83054		1202-1064	83024		12021286	83056		R711005	83024	
12019008	83054		1202-1286	83056		1202K286	83056				

Lion Bus

Lion bus	Gabriel	Upgrade	Lion bus	Gabriel	Upgrade	Lion bus	Gabriel	Upgrade	Lion bus	Gabriel	Upgrade
58913-009	85959		58913009L	85959		60670-030	83166		60670018L	83166	
58913-009L	85959		60670-018	83166		60670-030L	83166		60670030	83166	
58913009	85959		60670-018L	83166		60670018	83166		60670030L	83166	

Lodal Inc.

Lodal inc.	Gabriel	Upgrade	Lodal inc.	Gabriel	Upgrade	Lodal inc.	Gabriel	Upgrade	Lodal inc.	Gabriel	Upgrade
9960257	83122	89406									

Mack

Mack	Gabriel	Upgrade	Mack	Gabriel	Upgrade	Mack	Gabriel	Upgrade	Mack	Gabriel	Upgrade
14QK-140P1	83225		14QK-2100P1	83221		14QK-2105	83209	89414			
14QK-142AP1	83215		14QK-2100P2	83209	89414	14QK-2107	83209	89414			
14QK-142P1	83215		14QK-2100P5	83221		14QK-2107	83215				
14QK-2100	83221		14QK-2100P7	83221		14QK-2107P1	83215				

Important Note: Competitive Interchanges are to be used for stocking purposes only. Where multiple crosses are identified, please reference the applications section of this catalog. / **Remarque importante:** Les interchanges concurrentiels ne s'utilisent qu'aux fins de stocks. Dans le cas de rferences multiples, consulter la section des applications du catalogue. / **Nota importante:** Dans le cas de rferences multiples, consulter la section des aplicaciones du catalogue. / **Nota importante:** Se pueden usar intercambios competitivos para propósitos de almacenamiento solamente. Cuando se identifican intercambios múltiples, consulte la sección de aplicaciones de este catálogo.

COMPETITIVE & O.E.M. INTERCHANGE LIST
Lista de Intercambios contra Competidores y Equipo Original.
Liste dinterchange de produits comptitifs & dquipement original (OEM)

Mack... cont'd

Mack	Gabriel	Upgrade	Mack	Gabriel	Upgrade	Mack	Gabriel	Upgrade	Mack	Gabriel	Upgrade
14QK-2107P2	83215		14QK-5142	83142		14QK392BM3	85005	89430	471700015341	83127	
14QK-2107P3	83215		14QK140P1	83225		14QK392M	85005	89430	47902-25	83125	
14QK-2113	85001	89410	14QK142AP1	83215		14QK393AM	83123	89405	47902-9	83123	89405
14QK-2113P3	85001	89410	14QK142P1	83215		14QK393M	85010		4790225	83125	
14QK-2113P4	85007		14QK2100	83221		14QK396	85005	89430	479029	83123	89405
14QK-2113P5	85001	89410	14QK2100P1	83221		14QK396M	85005	89430	4940654	83216	
14QK-2113P6	85007		14QK2100P2	83209	89414	14QK410M	83125		5533699	85302	89420
14QK-2133M	85001	89410	14QK2100P5	83221		14QK410M2	83137		5554184	85302	89420
14QK-2133M2	85001	89410	14QK2100P7	83221		14QK410M3	83125		5966-90044025	83209	89414
14QK-282P1	83216		14QK2105	83209	89414	14QK414M2	85909		596690044025	83209	89414
14QK-282P3	83216		14QK2107	83209	89414	14QK423M	85978		60657-007	85072	
14QK-288-P1	85007		14QK2107	83215		14QK493M	83101		60657007	85072	
14QK-3116M	83101		14QK2107P1	83215		14QK5142	83142		60675-001	85978	
14QK-366P4	83209	89414	14QK2107P2	83215		20782199	85072		60675-001L	85978	
14QK-372M	83221		14QK2107P3	83215		21010744	83101		60675001	85978	
14QK-372M2	83209	89414	14QK2113	85001	89410	21155033	83101		60675001L	85978	
14QK-372M3	83122	89406	14QK2113P3	85001	89410	21345868	83066		60680-004	83143	
14QK-373	83215		14QK2113P4	85007		21345869	83066		60680-004L	83143	
14QK-375M	83123	89405	14QK2113P5	85001	89410	21436094	85927		60680-005	83142	
14QK-377M	83215		14QK2113P6	85007		21490486	83066		60680-005L	83142	
14QK-378	83215		14QK2133M	85001	89410	23145372	83066		60680004	83143	
14QK-378M	83215		14QK2133M2	85001	89410	23159760	85188		60680004L	83143	
14QK-392AM	85005	89430	14QK282P1	83216		23159762	85188		60680005	83142	
14QK-392AM2	85005	89430	14QK282P3	83216		23359394	83101		60680005L	83142	
14QK-392AM3	85005	89430	14QK288P1	85007		23818296	85978		650102	85001	89410
14QK-392BM	85005	89430	14QK3116M	83101		24145343	85005	89430	650400MT	85033	89427
14QK-392BM3	85005	89430	14QK366P4	83209	89414	25621571	83215		650402	85311	89424
14QK-392M	85005	89430	14QK372M	83221		25621955	85001	89410	650402MT	85311	89424
14QK-393AM	83123	89405	14QK372M2	83209	89414	25622466	85001	89410	650404	85310	89423
14QK-393M	85010		14QK372M3	83122	89406	25623321	83215		650404MT	85310	89423
14QK-396	85005	89430	14QK373	83215		25624351	85909		651012	83221	
14QK-396M	85005	89430	14QK375M	83123	89405	25625091	83215		651151	83209	89414
14QK-410M	83125		14QK377M	83215		25625187	83209	89414	70042	85302	89420
14QK-410M2	83137		14QK378	83215		25625234	83125		78530771	83127	
14QK-410M3	83125		14QK378M	83215		25625254	83125		8083872	85978	
14QK-414M2	85909		14QK392AM	85005	89430	25625743	85005	89430	H60680004	83143	
14QK-423M	85978		14QK392AM2	85005	89430	25626196	83142		H60680005	83142	
14QK-429M2	85072		14QK392AM3	85005	89430	25632145	85001	89410			
14QK-493M	83101		14QK392BM	85005	89430	25632561	83209	89414			

Maeco

Maeco	Gabriel	Upgrade	Maeco	Gabriel	Upgrade	Maeco	Gabriel	Upgrade	Maeco	Gabriel	Upgrade
12608	83125		16773	85005	89430	70034	85302	89420	70331	85314	89425
12788	83216		16774	83215		70042	85302	89420	70332	83314	
16385	83215		16776	83122	89406	70123	85716		70397	85006	
1668722	85030	89440	16777	85006		70127	85006		70651	85013	89414
16720	83107		16779	83126	89430	70128	85006		70652	85030	89440
16767	85013	89414	16780	83123	89405	70162	85716		70663	85013	89414
16769	83221		16781	85006		70163	85302	89420	70691	85007	
16770	83209	89414	16787	85030	89440	70164	85716		70721	83125	
16771	83126	89430	16949	83120		70312	85001	89410			
16772	83122	89406	6025	83122	89406	70315	85063				

Mandalay Coach

Mandalay coach	Gabriel	Upgrade	Mandalay coach	Gabriel	Upgrade	Mandalay coach	Gabriel	Upgrade	Mandalay coach	Gabriel	Upgrade
141700131809	85029		16-16737-000	83160		16-18103-000	85900		1616873000	85029	
141700131810	83160		16-16873-000	85029		1616736000	85029		1616874000	83160	
16-16736-000	85029		16-16874-000	83160		1616737000	83160		1618103000	85900	

Important Note: Competitive Interchanges are to be used for stocking purposes only. Where multiple crosses are identified, please reference the applications section of this catalog. / **Remarque importante:** Les interchanges concurrentiels ne s'utilisent qu'aux fins de stocks. Dans le cas de références multiples, consulter la section des applications du catalogue. / **Nota importante:** Dans le cas de referencias multiples, consultar la sección de aplicaciones del catálogo. / **Nota importante:** Se pueden usar intercambios competitivos para propósitos de almacenamiento solamente. Cuando se identifican intercambios múltiples, consulte la sección de aplicaciones de este catálogo.

COMPETITIVE & O.E.M. INTERCHANGE LIST
Lista de Intercambios contra Competidores y Equipo Original.
Liste dinterchange de produits comptitifs & dquipement original (OEM)

Mandalay Coach... cont'd

Mandalay coach	Gabriel	Upgrade	Mandalay coach	Gabriel	Upgrade	Mandalay coach	Gabriel	Upgrade	Mandalay coach	Gabriel	Upgrade
48170000493	85900										

Marmon

Marmon	Gabriel	Upgrade	Marmon	Gabriel	Upgrade	Marmon	Gabriel	Upgrade	Marmon	Gabriel	Upgrade
1-7001	83216		17001	83216		51-163-7	83123	89405	665147	83216	
1202-0054	83021		37-1-1	83122	89406	511637	83123	89405			
12020054	83021		3711	83122	89406	576451	83122	89406			

Mc Neilus Truck & Man.

Mc neilus truck & man.	Gabriel	Upgrade	Mc neilus truck & man.	Gabriel	Upgrade	Mc neilus truck & man.	Gabriel	Upgrade	Mc neilus truck & man.	Gabriel	Upgrade
1139069 MTM	83209	89414	1396513 MTM	85959		3HR582 MTM	85013	89414	6HS773 MTM	83122	89406
1333575 MTM	85072		1398980 MTM	83127		4HA569 MTM	85932	89453	7HS237 MTM	83122	89406
1340975 MTM	83142		1410046 MTM	85919		6HA961 MTM	83123	89405	8KK524 MTM	83168	
1340976 MTM	85919		1411765 MTM	83148		6HB390 MTM	83137		9HB362 MTM	85976	
1340979 MTM	83143		1429317 MTM	85919		6HD720 MTM	85909				

Meritor

Meritor	Gabriel	Upgrade	Meritor	Gabriel	Upgrade	Meritor	Gabriel	Upgrade	Meritor	Gabriel	Upgrade
202447	85919		M83135	83135		M85030	85030	89440	M85724	85724	89443
671907	85919		M83136	83136		M85033	85033	89427	M85900	85900	
A-3280-M-9711	85919		M83209	83209	89414	M85043	85043		M85902	85902	
A-7805L-1000	85919		M83215	83215		M85058	85058	89431	M85909	85909	
A3280M9711	85919		M83456	83456	89447	M85067	85067	89451	M85918	85918	89449
A7805L1000	85919		M85001	85001	89410	M85069	85069	89455	M85919	85919	
M83021	83021		M85005	85005	89430	M85070	85070	89459	M85920	85920	89503
M83025	83025		M85006	85006		M85072	85072		M85923	85923	89458
M83122	83122	89406	M85007	85007		M85301	85301		M85936	85936	89456
M83123	83123	89405	M85012	85012	89413	M85310	85310	89423			
M83125	83125		M85013	85013	89414	M85311	85311	89424			
M83127	83127		M85029	85029		M85331	85331				

Mitsubishi Fuso

Mitsubishi fuso	Gabriel	Upgrade	Mitsubishi fuso	Gabriel	Upgrade	Mitsubishi fuso	Gabriel	Upgrade	Mitsubishi fuso	Gabriel	Upgrade
MB161497	G63299		MC114595	G63405		MC814614	85009		MK433638	G63610	
MC091947	83162		MC714595	G63405		MC826268	G63610				
MC091950	83162		MC813135	83456	89447	MK302296	G63610				

Mohawk

Mohawk	Gabriel	Upgrade	Mohawk	Gabriel	Upgrade	Mohawk	Gabriel	Upgrade	Mohawk	Gabriel	Upgrade
4968853	83216		MM-6957	83225		MM6957	83225				

Monaco

Monaco	Gabriel	Upgrade	Monaco	Gabriel	Upgrade	Monaco	Gabriel	Upgrade	Monaco	Gabriel	Upgrade
01809924	83144		9U9418080AA	83122	89406	ASH1022	83209	89414	AT766	83209	89414
01809925	85010		9U9Z-18124-A	83209	89414	ASH1023	83122	89406	F4-BE5-A832-MO	85125	
1C34-18045-AA	83209	89414	9U9Z-18125-A	83122	89406	ASH1205	83209	89414	F4-BE5-B492-HO	85125	
1C34-18045-JA	83209	89414	9U9Z18124A	83209	89414	ASH1206	83122	89406	F4-BE5-C832-MO	83124	89407
1C3418045AA	83209	89414	9U9Z18125A	83122	89406	ASH1228	83209	89414	F4-BE5-F324-HO	85125	
1C3418045JA	83209	89414	ASH-1022	83209	89414	ASH1229	83209	89414	F4-BE5-F325-HO	85124	
24-153249	85125		ASH-1023	83122	89406	ASH1230	83122	89406	F4BE5A832MO	85125	
24-153256	85124		ASH-1205	83209	89414	ASH137	83122	89406	F4BE5B492HO	85125	
24-186629	85125		ASH-1206	83122	89406	ASH25822	83209	89414	F4BE5C832MO	83124	89407
24153249	85125		ASH-1228	83209	89414	ASH25823	83209	89414	F4BE5F324HO	85125	
24153256	85124		ASH-1229	83209	89414	ASH25824	83122	89406	F4BE5F325HO	85124	
24186629	85125		ASH-1230	83122	89406	ASH294	83209	89414	W0005662	85125	
66153-002	83124	89407	ASH-137	83122	89406	AT-620	83209	89414	W0005663	85124	
66153002	83124	89407	ASH-25822	83209	89414	AT-621	83122	89406	W0006254	85125	
9U94-18045-AA	83209	89414	ASH-25823	83209	89414	AT-766	83209	89414			
9U94-18080-AA	83122	89406	ASH-25824	83122	89406	AT620	83209	89414			
9U9418045AA	83209	89414	ASH-294	83209	89414	AT621	83122	89406			

Important Note: Competitive Interchanges are to be used for stocking purposes only. Where multiple crosses are identified, please reference the applications section of this catalog./ **Remarque importante:** Les interchanges concurrentiels ne s'utilisent qu'aux fins de stocks. Dans le cas de rferences multiples, consulter la section des applications du catalogue./ **Nota importante:** Dans le cas de rferences multiples, consulter la section des applications du catalogue./ **Nota importante:** Se pueden usar intercambios competitivos para propósitos de almacenamiento solamente. Cuando se identifican intercambios múltiples, consulte la sección de aplicaciones de este catálogo.

COMPETITIVE & O.E.M. INTERCHANGE LIST
Lista de Intercambios contra Competidores y Equipo Original.
Liste d'interchange de produits compétitifs & d'équipement original (OEM)

Monroe											
Monroe	Gabriel	Upgrade	Monroe	Gabriel	Upgrade	Monroe	Gabriel	Upgrade	Monroe	Gabriel	Upgrade
16385	83215		32268	81828		32365	61642		34657	61613	
250302	81912		32277	61599		32365	81921		34657	G63716	
250303	81892		32277	81928		32366	61635		34657MM	61613	
250322	61614		32278	61600		32366	81919		34658	61612	
31000	61500		32278	81873		32371	61523		34671	61614	
31000	81147		32279	61634		32371	81096		34672	61614	
31069	81270		32279	81919		32372	61547		34673	61638	
31094	82012		32280	61520		32372	81082		34673	81892	
31131	61632		32280	61613		32373	61542		34674	81913	
31131	81825		32280	81490		32373	81726		34675	61641	
32066	61555		32281	82147		32375	81342		34675MM	61641	
32066	81713		32285	61521		32376	81834		34676	58662	
32075	61521		32288	61614		32377	82007		34676	61600	
32075	81394		32288	81821		32381	61520		34676MM	61600	
32080	61518		32293	61500		32381	61546		34678	61642	
32080	81242		32301	82003		32385	81091		34678	81873	
32127	61523		32302	61611		32386	81510		34684	58807	
32127	81096		32302	81912		32400	77949		34684	G63622	
32127	81834		32303	61638		32401	61710		34685	58808	
32128	81091		32303	81892		32401	61716		34685	61654	
32164	61519		32303R	81892		32402	61714		34685	77808	
32164	81484		32304	61613		33033	61525		34685	G63808	
32207	81676		32304	81914		33033	81039		34686	58809	
32207	82007		32305	61612		33049	82034		34686	61655	
32224	61544		32305	81913		33049	82155		34686	G63809	
32224	81668		32317	81713		33049	G63610		34687	58810	
32225	61543		32322	61614		33074	61516		34687	61656	
32225	81667		32323	61614		33074	81113		34687	61682	
32226	61520		32324	61638		33076	58357		34687	G63810	
32226	77414		32324	81892		33076	61517		34689	61641	
32226	81490		32325	61612		33084	61524		34689	61663	
32227	61520		32325	81913		33084	81164		34690	61642	
32227	81490		32326	61641		33086	61522		34690	81921	
32228	61554		32326	81920		33086	81496		34694	61642	
32228	81710		32327	61600		33127	81713		34729	61520	
32231	61547		32327	81873		34504	58817		34729	61546	
32231	81082		32327R	81873		34504	61663		34729	G63414	
32231	81710		32329	81921		34517	G63837		34729MM	61520	
32235	81744		32332	61614		34518	G63809		34730	61520	
32239	61530		32340	61663		34519	G63837		34730	G63386	
32239	81510		32340	81920		34521	61710		34730MM	61520	
32243	61520		32341	61642		34521	61716		34731	61547	
32243	81490		32341	81921		34522	61714		34731	61554	
32254	61542		32345	61642		34523	77967		34732	61614	
32254	81726		32345	81921		34523	G63969		34732	G63455	
32259	81744		32350	61663		34524	77968		34736	61525	
32262	81270		32350	81925		34524	77969		34741	61544	
32263	81726		32357	58808		34525	61680		34750	58359	
32264	58638		32357	61654		34526	61682		34750	61523	
32264	61565		32358	58809		34530	61685		34751	G63607	
32265	61687		32358	61655		34655	58714		34756	61543	
32266	61565		32359	58810		34655	61611		34760	58622	
32266R	61543		32359	61656		34655	G63714		34760	61591	
32267	61591		32360	81082		34656	61638		34760	G63622	
32267	81744		32362	61685		34656	G63778		34761	58623	
32268	61646		32362	81668		34656MM	61638		34761	61646	

Important Note: Competitive Interchanges are to be used for stocking purposes only. Where multiple crosses are identified, please reference the applications section of this catalog. / **Remarque importante:** Les interchanges concurrentiels ne s'utilisent qu'aux fins de stocks. Dans le cas de références multiples, consulter la section des applications du catalogue. / **Nota importante:** Dans le cas de références multiples, consulter la section des applications du catalogue. / **Nota importante:** Se pueden usar intercambios competitivos para propósitos de almacenamiento solamente. Cuando se identifican intercambios múltiples, consulte la sección de aplicaciones de este catálogo.

COMPETITIVE & O.E.M. INTERCHANGE LIST
Lista de Intercambios contra Competidores y Equipo Original.
Liste dinterchange de produits comptitifs & dquipement original (OEM)

Monroe... cont'd

Monroe	Gabriel	Upgrade	Monroe	Gabriel	Upgrade	Monroe	Gabriel	Upgrade	Monroe	Gabriel	Upgrade
34761	G63623		34927	61554		37320	61500		58601	43167	
34763	58638		34927	G63409		37320	81147		58606	43180	
34763	61565		34928	61546		37803	G63306		58610	43181	
34763	61687		34929	58403		550051	43140		58612	43180	
34763MM	61565		34929	G63403		550061	58412		58615	43181	
34768	83209	89414	34930	61530		551001	83125		58618	43167	
34770	61713		34944	61516		551002	83122	89406	58636	43181	
34771	81342		34958	61519		555004	G63299		58637	43181	
34776	61599		34960	G63366		555010	77623		58654	43181	
34777	58662		34963	61547		555012	G63183		5969	61555	
34777	61600		34963	G63406		555019	85069	89455	5969	81713	
34777MM	61600		34964	61530		555031	77614		65102	85001	89410
34778	61634		34972	G63610		555031	G63622		65108	85030	89440
34781	61642		34972MM	G63610		555032	G63623		65109	85058	89431
34782	61635		34983	58489		555033	G63386		65110	85005	89430
34782	77674		34983	61544		555034	G63387		65110MM	85005	89430
34793	61520		34985	58488		555035	G63357		65111	85006	
34793MM	61520		34985	61543		555036	77403		65113	85012	89413
34794	61523		37011	G63414		555038	77403		65118	85001	89410
34796	61591		37015	G63614		557001	83209	89414	65119	85029	
34797	61547		37015ST	G63614		557001	85013	89414	65120	85010	
34797	G63406		37024	G63610		557002	83125		65122	85063	
34798	58609		37035	77607		557005	83136		65123	85054	
34798	61542		37035	G63607		557006	83136		65128	85031	
34798	77609		37038	G63461		557007	83122	89406	65139	85918	89449
34799	61542		37040	G63347		557007	85010		65140	85918	89449
34802	83216		37041	77662		557008	85029		65142	83131	
34802MM	83216		37045	G63183		557009	85007		65143	83163	
34803	61500		37049	G63355		557011	83160		65144	85928	
34803	G63306		37052	G63406		557012	85029		65148	85918	89449
34803MM	61500		37053	G63386		557013	83127		65153	85921	
34807	61638		37055	G63455		557014	83126	89430	65155	83175	
34817	61525		37063	61555		557015	83209	89414	65156	85005	89430
34817	G63355		37063	77375		557017	85029		65159	85070	89459
34821	61547		37063	81713		557018	83127		65159MM	85070	89459
34821	G63406		37086	77638		557020	83123	89405	65161	83136	
34824	61524		37089	G63350		557026	83127		65162	85959	
34831	61523		37090	G63357		557028	85010		65164	85649	
34839	58357		37128	58622		557031	85010		65167	58944	
34839	61517		37131	G63714		557033	85900		65167	G63969	
34853	61632		37132	G63778		557038	85125		65168	77968	
34900	61521		37133	77716		557039	85959		65175	85084	89460
34900	G63386		37133	G63716		5818	82155		65176	85084	89460
34901	G63387		37144	61614		58241	34036		65177	85012	89413
34904	G63299		37149ST	G63783		58253	34058		65179	85995	
34905	61500		37150	58662		5826	81270		65181	85650	
34905	G63405		37150	61600		58263	34073		65183	85181	
34905MM	61500		37150	77662		58273	34073		65184	85180	
34906	61521		37150	81873		58510	43140		65185	85180	
34910	61516		37152ST	G63675		58518	43099		65400	85033	89427
34910	61522		37181	58817		58567	43048		65400MM	85033	89427
34910	81496		37181	61663		58568	43140		65401	85013	89414
34911	61518		37181	81925		58578	43111		65402	85311	89424
34911	G63350		37187	82035		58592	43058		65404	85310	89423
34920	58412		37207	58412		58595	43085		65412	83122	89406
34920	61642		37243	G63610		58600	43163		65413	83136	

Important Note: Competitive Interchanges are to be used for stocking purposes only. Where multiple crosses are identified, please reference the applications section of this catalog./ **Remarque importante:** Les interchanges concurrentiels ne s'utilisent qu'aux fins de stocks. Dans le cas de rfrences multiples, consulter la section des applications du catalogue./ **Nota importante:** Dans le cas de rfrences multiples, consulter la section des applications du catalogue./ **Nota importante:** Se pueden usar intercambios competitivos para propósitos de almacenamiento solamente. Cuando se identifican intercambios múltiples, consulte la sección de aplicaciones de este catálogo.

COMPETITIVE & O.E.M. INTERCHANGE LIST
Lista de Intercambios contra Competidores y Equipo Original.
Liste d'interchange de produits comptitifs & d'equipement original (OEM)

Monroe... cont'd

Monroe	Gabriel	Upgrade	Monroe	Gabriel	Upgrade	Monroe	Gabriel	Upgrade	Monroe	Gabriel	Upgrade
65420	85013	89414	66162	83025		66672	83209	89414	6863	83314	
65426	85054		66181	83025		66677	83114		6878	83221	
65429	85030	89440	66200	83066		66680	83317		6891	83215	
65431	85909		66204	83024		66681	83025		6894	83209	89414
65432	85910		66209	83040		66683	83101		6897	83126	89430
65433	85910		66402	83157		66684	85007		6898	83125	
65434	85012	89413	66403	83154		66692	83120		6900	G63386	
65436	85900		66405	83154		66697	83164		6901	G63387	
65439	85716		66406	85920	89503	66701	83215		6901MM	G63387	
65444	85311	89424	66407	83134		66707	83215		6911	G63350	
65451	85029		66412	83169		66710	83209	89414	6916	83123	89405
65453	85043		66418	85918	89449	66714	83216		6923	83456	89447
65454	85030	89440	66422	83163		66714MM	83216		6927	G63409	
65455	85716		66423	85001	89410	66717	83515		6956	83101	
65456	85376		66424	85310	89423	66717	85716		6957	83225	
65457	85909		66425	85920	89503	66717MM	83515		6960	G63366	
65459	85043		66428	85033	89427	66721	83391		6969	83126	89430
65464	85716		66429	85311	89424	66722	83518		6994	83122	89406
65467	85054		66430	83309		66811	83312	89409	70166	85301	
65468	85069	89455	66433	85918	89449	66828	83159		70312	85001	89410
65471	85302	89420	66434	85069	89455	66833	83126	89430	70331	85314	89425
65478	85058	89431	66436	85067	89451	66841	83216		70332	83314	
65479	83122	89406	66445	83135		66841MM	83216		74003	85314	89425
65482	85006		66447	83180		66858	G63183		74028	85302	89420
65483	85978		66448	85058	89431	66860	83308		74069	85301	
65484	85976		66454	83166		66860MM	83308		74070	85716	
65487	85927		66455	83166		66861	83309		74080	85332	
65488	85656		6658	85009		66861MM	83309		74409	85310	89423
65489	85331		66601	83114		66863	83314		74417	85311	89424
65490	85724	89443	66602	G63610		66871	G63605		74425	85724	89443
65495	85067	89451	66604	83101		66878	83221		74429	85919	
65503	85919		66605	83613		66883	83314		74433	85331	
65504	85072		66613	83123	89405	66884	83125		74454	85314	89425
65506	83168		66614	83125		66891	83215		74454MM	85314	89425
65507	83143		66615	83120		66894	83137		74473	85716	
65508	83142		66618	83159		66897	83126	89430	74480	85351	
65515	83125		66620	83162		66898	83125		911038	77461	
65516	85013	89414	66624	83141		66923	83456	89447	911044	58488	
65522	85082		66625	83162		66924	83317		911044	61543	
65524	85936	89456	66626	85071		66924MM	83317		911044	81667	
65526	85956		66628	83136		66956	83101		911050	58489	
65528	85069	89455	66629	83107		66957	83225		911050	61544	
65530	85932	89453	66630	83216		66969	83126	89430	911050	81668	
65540	85959		66631	83140		6701	83215		911055	77455	
65547	85650		66632	83006		6707	83215		911102	77661	
65552	85188		66633	83127		6710	83209	89414	911104	77673	
6604	83101		66636	83127		6714	83216		911131	77714	
6605	83613		66638	83123	89405	6811	83312	89409	911140	77403	
66104	83021		66639	G63610		6811MM	83312	89409	911144	61614	
66120	85006		66646	83308		6817	G63355		911149	61641	
66124	83040		66653	83515		6833	83126	89430	911149	81920	
6613	83123	89405	66658	85009		6839	G63357		911150	58662	
6614	83125		66661	83123	89405	6841	83216		911150	61600	
6615	83120		66664	83215		6860	83308		911150	81873	
66160	83054		66668	83312	89409	6860MM	83308		911152	58412	
66161	83054		66671	83123	89405	6861	83309		911152	61642	

Important Note: Competitive Interchanges are to be used for stocking purposes only. Where multiple crosses are identified, please reference the applications section of this catalog. / **Remarque importante:** Les interchanges concurrentiels ne s'utilisent qu'aux fins de stocks. Dans le cas de références multiples, consulter la section des applications du catalogue. / **Nota importante:** Dans le cas de referencias multiples, consultar la sección de aplicaciones del catálogo. / **Nota importante:** Se pueden usar intercambios competitivos para propósitos de almacenamiento solamente. Cuando se identifican intercambios múltiples, consulte la sección de aplicaciones de este catálogo.

COMPETITIVE & O.E.M. INTERCHANGE LIST
Lista de Intercambios contra Competidores y Equipo Original.
Liste dinterchange de produits comptitifs & dquipement original (OEM)

Monroe... cont'd

Monroe	Gabriel	Upgrade	Monroe	Gabriel	Upgrade	Monroe	Gabriel	Upgrade	Monroe	Gabriel	Upgrade
911152	81921		911265	61713		MA764	49218		SC2915	6802SE	
911152MM	G63675		911266	77951		MA777	49178		SC2928	6804SE	
911163	61641		911502	77412		MA779	49231		SC2953	6804SE	
911163	81920		911503	77783		MA817	49212		SC2955	6828SE	
911173	77807		911504	77662		MA828	49235		SC2961	6850SE	
911176	77837		911507	77817		MA829	49237		SC2961	6854SE	
911192	77675		911511	77609		MA834	49235		SC2961	6855SE	
911193	61635		911512	77488		MONRS55042	77951		SC2963	6803SE	
911195	58809		911513	77489		MONRS55274	77412		SC2963	6853SE	
911195	61655		911521	77715		MONRS55288	77817		SC2964	6847SE	
911195	77809		911533	77976		MONSC2955	6828SE		SC2965	6856SE	
911196	77810		911534	77980		SA1930	6802SE		SC2967	14072	
911221	77949		MA726	49173		SC2911	6804SE		SC2975	6828SE	
911222	77950		MA730	49127		SC2912	6802SE				
911223	77948		MA733	49149		SC2913	14017				
911256	61683		MA743	49155		SC2913	6804SE				

MOOG

Moog	Gabriel	Upgrade	Moog	Gabriel	Upgrade	Moog	Gabriel	Upgrade	Moog	Gabriel	Upgrade
SSD122	6861SE		SSD131	6856SE							

Mor-Ryde Suspension

Mor-ryde suspension	Gabriel	Upgrade	Mor-ryde suspension	Gabriel	Upgrade	Mor-ryde suspension	Gabriel	Upgrade	Mor-ryde suspension	Gabriel	Upgrade
U0109-007	G63183		U0109007	G63183							

Motor Coach Industries

Motor coach industries	Gabriel	Upgrade	Motor coach industries	Gabriel	Upgrade	Motor coach industries	Gabriel	Upgrade	Motor coach industries	Gabriel	Upgrade
T14-1048	85302	89420	T141048	85302	89420						

Motorcraft

Motorcraft	Gabriel	Upgrade	Motorcraft	Gabriel	Upgrade	Motorcraft	Gabriel	Upgrade	Motorcraft	Gabriel	Upgrade
AA-483	G63837		ASH-121	G63607		ASH-387	G63809		AT-568	G63622	
AA-484	G63837		ASH-122	G63614		ASH-39	85001	89410	AT-579	G63809	
AA-485	G63837		ASH-1228	83209	89414	ASH-391	G63809		AT-610	G63461	
AA-486	G63607		ASH-1230	83122	89406	ASH-394	G63614		AT-611	G63461	
AA-494	83131		ASH-132	G63614		ASH-397	83131		AT-620	83209	89414
AA-500	G63809		ASH-137	83122	89406	ASH-398	85928		AT-621	83122	89406
AA-501	G63809		ASH-23454	G63614		ASH-407	G63809		AT-696	83140	
AA-502	G63614		ASH-23458	G63614		ASH-408	G63809		AT-710	G63809	
AA-503	G63614		ASH-24401	G63809		ASH-684	G63623		AT-713	G63614	
AA-504	G63614		ASH-24402	85928		ASH-69	83175		AT-715	G63614	
AA-615	83135		ASH-24433	G63837		ASH-706	G63614		AT-716	G63809	
AA-616	83175		ASH-24434	G63607		ASH-707	G63614		AT-766	83209	89414
AA-617	85928		ASH-24438	6828SE		ASHV-1015	G63622		AT-811	83135	
AS-413	G63414		ASH-24492	83175		ASHV-1025	G63623		AX-135A	G63406	
AS-433	G63406		ASH-24659	85181		ASHV-1028	G63778		AX-267A	83309	
AS-485G	G63622		ASH-24660	85180		ASHV-1047	G63607		AX-269A	83308	
ASH-1022	83209	89414	ASH-25	83309		ASHV-1051	G63837		AX-269A	83312	89409
ASH-1023	83122	89406	ASH-25822	83209	89414	ASHV-14	G63837		AX-282A	85010	
ASH-1129	14072		ASH-25823	83209	89414	ASHV-3	G63714		AX-310	83215	
ASH-1130	G63622		ASH-25824	83122	89406	ASHV-4	G63716		AX-332	85928	
ASH-1131	G63622		ASH-26	85006		ASHV-6	G63809		AX-79A	83221	
ASH-1132	G63622		ASH-29	83314		ASHV-865	G63808		AX-79A	85030	89440
ASH-1135	G63623		ASH-294	83209	89414	ASHV-866	G63810		AX-97A	83122	89406
ASH-1136	G63623		ASH-32	83125		ASHV-867	G63455		AX-97A	85005	89430
ASH-1154	G63622		ASH-322	77969		ASHV-868	G63406		CAH-003	83215	
ASH-1155	G63623		ASH-324	77968		ASHV-871	G63809		CAH-025	85007	
ASH-119	G63809		ASH-335	G63969		ASHV-879	G63455				
ASH-120	G63837		ASH-36	85716		AT-163G	G63622				
ASH-1205	83209	89414	ASH-362	G63607		AT-164G	G63623				
ASH-1206	83122	89406	ASH-38	85314	89425	AT-507G	G63607				

Important Note: Competitive Interchanges are to be used for stocking purposes only. Where multiple crosses are identified, please reference the applications section of this catalog. / **Remarque importante:** Les interchanges concurrentiels ne s'utilisent qu'aux fins de stocks. Dans le cas de rferences multiples, consulter la section des applications du catalogue. / **Nota importante:** Dans le cas de rferences multiples, consulter la section des applications du catalogue. / **Nota importante:** Se pueden usar intercambios competitivos para propósitos de almacenamiento solamente. Cuando se identifican intercambios múltiples, consulte la sección de aplicaciones de este catálogo.

COMPETITIVE & O.E.M. INTERCHANGE LIST
Lista de Intercambios contra Competidores y Equipo Original.
Liste dinterchange de produits comptitifs & dquipement original (OEM)

Motorcraft... cont'd

Motorcraft	Gabriel	Upgrade	Motorcraft	Gabriel	Upgrade	Motorcraft	Gabriel	Upgrade	Motorcraft	Gabriel	Upgrade
CAH-028	85302	89420	CAT-817	G63355		CAX-707	83215		CAX-894	85005	89430
CAH-069	85301		CAT-839	G63357		CAX-707	85001	89410	CAX-894	85013	89414
CAHL-409	85310	89423	CAT-853	G63183		CAX-710	83209	89414	CAX-898	83125	
CAHL-417	85311	89424	CAT-900	G63386		CAX-811	83312	89409	CAX-898	85006	
CAT-729	G63414		CAT-901	G63387		CAX-828	85012	89413	CAX-916	83123	89405
CAT-730	G63386		CAT-904	G63299		CAX-833	85005	89430	CAX-923	83456	89447
CAT-731	G63409		CAT-905	G63405		CAX-841	83216		CAX-924	83317	
CAT-732	G63455		CAT-911	G63350		CAX-860	83308		CAX-957	83225	
CAT-745	G63614		CAT-912	G63625		CAX-861	83309		CAX-969	83221	
CAT-751	G63607		CAT-927	G63409		CAX-863	83314		CAX-969	85030	89440
CAT-760	G63622		CAT-929	G63403		CAX-878	83221		CLT-109	G63614	
CAT-761	G63623		CAT-930	G63461		CAX-891	83215		CLT-124	G63610	
CAT-768	83209	89414	CAT-944	G63347		CAX-891	85314	89425			
CAT-793	G63414		CAT-960	G63366		CAX-893	85043				
CAT-803	G63306		CAT-972	G63610		CAX-894	83209	89414			

NAPA

Napa	Gabriel	Upgrade	Napa	Gabriel	Upgrade	Napa	Gabriel	Upgrade	Napa	Gabriel	Upgrade
LS57147	G57147		SH81091	81091		SH81713	81713		SH81925	81925	
LS57800	G57800		SH81096	81096		SH81726	81726		SH81928	81928	
LS57801	G57801		SH81113	81113		SH81744	81744		SH82003	82003	
SH61546	61546		SH81147	81147		SH81821	81821		SH82007	82007	
SH61614	61614		SH81164	81164		SH81825	81825		SH82012	82012	
SH61654	61654		SH81242	81242		SH81828	81828		SH82034	82034	
SH61655	61655		SH81394	81394		SH81834	81834		SH82035	82035	
SH61656	61656		SH81484	81484		SH81873	81873		SH82047	82047	
SH63614	G63614		SH81490	81490		SH81892	81892		SH82065	82065	
SH63692	G63692		SH81496	81496		SH81912	81912		SH82086	82086	
SH63809	G63809		SH81510	81510		SH81913	81913		SH82147	82147	
SH63837	G63837		SH81667	81667		SH81914	81914		SH82155	82155	
SH64043	G64043		SH81668	81668		SH81919	81919				
SH81039	81039		SH81676	81676		SH81920	81920				
SH81082	81082		SH81710	81710		SH81921	81921				

National RV Inc.

National rv inc.	Gabriel	Upgrade	National rv inc.	Gabriel	Upgrade	National rv inc.	Gabriel	Upgrade	National rv inc.	Gabriel	Upgrade
1C34-18045-AA	83209	89414	9U9Z-18125-A	83122	89406	ASH-25824	83122	89406	F4-BE5-B492-HO	85125	
1C34-18045-JA	83209	89414	9U9Z18125A	83122	89406	ASH-294	83209	89414	F4-BE5-F324-HO	85125	
24-153249	85125		ASH-1022	83209	89414	ASH1023	83122	89406	F4-BE5-F325-HO	85124	
24-153256	85124		ASH-1023	83122	89406	ASH1206	83122	89406	F4BE5A832MO	85125	
24-186629	85125		ASH-1205	83209	89414	ASH1230	83122	89406	F4BE5B492HO	85125	
24153249	85125		ASH-1206	83122	89406	ASH137	83122	89406	F4BE5F324HO	85125	
24153256	85124		ASH-1228	83209	89414	ASH25824	83122	89406	F4BE5F325HO	85124	
24186629	85125		ASH-1229	83209	89414	AT-620	83209	89414	W0005662	85125	
9U94-18045-AA	83209	89414	ASH-1230	83122	89406	AT-621	83122	89406	W0005663	85124	
9U94-18080-AA	83122	89406	ASH-137	83122	89406	AT-766	83209	89414	W0006254	85125	
9U9418080AA	83122	89406	ASH-25822	83209	89414	AT621	83122	89406			
9U9Z-18124-A	83209	89414	ASH-25823	83209	89414	F4-BE5-A832-MO	85125				

Neoplan Bus

Neoplan bus	Gabriel	Upgrade	Neoplan bus	Gabriel	Upgrade	Neoplan bus	Gabriel	Upgrade	Neoplan bus	Gabriel	Upgrade
24-1700-106-149	83216		241700106149	83216		BN1002002	85009				
24-1700-999-362	85009		241700999362	85009		BT1002011	83216				

New Flyer

New flyer	Gabriel	Upgrade	New flyer	Gabriel	Upgrade	New flyer	Gabriel	Upgrade	New flyer	Gabriel	Upgrade
68027440Y	85716		68050440X	85716							

Newmar Corp.

Newmar corp.	Gabriel	Upgrade	Newmar corp.	Gabriel	Upgrade	Newmar corp.	Gabriel	Upgrade	Newmar corp.	Gabriel	Upgrade
141700131809	85029		141700131810	83160		16-16736-000	85029		16-16737-000	83160	

Important Note: Competitive Interchanges are to be used for stocking purposes only. Where multiple crosses are identified, please reference the applications section of this catalog. / **Remarque importante:** Les interchanges concurrentiels ne s'utilisent qu'aux fins de stocks. Dans le cas de rferences multiples, consulter la section des applications du catalogue. / **Nota importante:** Dans le cas de rferences multiples, consulter la section des applications du catalogue. / **Nota importante:** Se pueden usar intercambios competitivos para propósitos de almacenamiento solamente. Cuando se identifican intercambios múltiples, consulte la sección de aplicaciones de este catálogo.

COMPETITIVE & O.E.M. INTERCHANGE LIST
Lista de Intercambios contra Competidores y Equipo Original.
Liste dinterchange de produits comptitifs & dquipement original (OEM)

Newmar Corp.... cont'd

Newmar corp.	Gabriel	Upgrade	Newmar corp.	Gabriel	Upgrade	Newmar corp.	Gabriel	Upgrade	Newmar corp.	Gabriel	Upgrade
16-16874-000	83160		1616874000	83160		ASH-1229	83209	89414	ASH25824	83122	89406
16-18103-000	85900		1618103000	85900		ASH-25822	83209	89414			
1616736000	85029		48170000493	85900		ASH-25823	83209	89414			
1616737000	83160		90045455	85909		ASH-25824	83122	89406			

Nexus RV

Nexus rv	Gabriel	Upgrade	Nexus rv	Gabriel	Upgrade	Nexus rv	Gabriel	Upgrade	Nexus rv	Gabriel	Upgrade
ASH-1136	G63623		ASH-1229	83209	89414	ASH-25823	83209	89414	ASH1154	G63622	
ASH-1154	G63622		ASH-25822	83209	89414	ASH-25824	83122	89406	ASH25824	83122	89406

Nissan

Nissan	Gabriel	Upgrade	Nissan	Gabriel	Upgrade	Nissan	Gabriel	Upgrade	Nissan	Gabriel	Upgrade
56101-30Z02	G63610		56101Z5008	83114		56110-Z5008	83114		56110Z5014	83162	
56101-Z5008	83114		56101Z5014	83162		56110-Z5014	83162		56110Z5017	83162	
56101-Z5014	83162		56101Z5017	83162		56110-Z5017	83162				
56101-Z5017	83162		56110-30Z02	G63610		56110Z5008	83114				

O'Reilly

O'reilly	Gabriel	Upgrade	O'reilly	Gabriel	Upgrade	O'reilly	Gabriel	Upgrade	O'reilly	Gabriel	Upgrade
20418	81726		32080	61518		32286	82034		32359	61656	
20433	81928		32126	82155		32288	81821		32362	61685	
20704	81242		32164	61519		32294	61547		32366	61635	
20711	81113		32164	81484		32301	82003		32376	81834	
20713	81164		32207	82007		32302	81912		32385	81091	
20718	81039		32224	61544		32303	81892		32386	61546	
20719	81496		32225	61543		32304	61613		32386	81510	
20722	81676		322268	61646		32304	81914		32401	61710	
20744	81668		32227	61520		32305	61612		32402	61714	
20745	81667		32228	61554		32305	81913		32402	61716	
20747	81490		32231	81082		32322	61614		33033	61525	
20748	81710		32259	61591		32325	61530		33074	61516	
20751	81147		32263	61542		32326	61641		33076	61517	
20766	81744		32265	61687		32326	81920		33084	61524	
20801	81713		32266	61565		32326	81921		33086	61522	
23073	81394		32268	81828		32329	61642		34831	81096	
31094	61500		32277	61599		32350	61663		37187	82035	
31131	61632		32279	61634		32350	81925		40040	81873	
32066	61555		32279	81919		32357	61654				
32075	61521		32281	82147		32358	61655				

Orion Bus Industries

Orion bus industries	Gabriel	Upgrade	Orion bus industries	Gabriel	Upgrade	Orion bus industries	Gabriel	Upgrade	Orion bus industries	Gabriel	Upgrade
050134501-4	85716		0502315014	85716		050231507	85716		97999902636	85716	
0501345014	85716		050231502-4	85716		680274	85716		OB020764	85716	
050230501	85716		0502315024	85716		680504	85716				
050231501-4	85716		050231505	85716		97-9999-02636	85716				

Oshkosh Motors

Oshkosh motors	Gabriel	Upgrade	Oshkosh motors	Gabriel	Upgrade	Oshkosh motors	Gabriel	Upgrade	Oshkosh motors	Gabriel	Upgrade
060670-018	83166		26228-A	83122	89406	40-6967	85030	89440	60670-018	83166	
1202-0054	83021		26228A	83122	89406	400242	83312	89409	60670018	83166	
12020054	83021		3638112	G63183		4036892	G63605		651444	83221	
1398980	83127		40-0242	83312	89409	405348	85058	89431	665060	83122	89406
1573280	83221		40-5348	85058	89431	406967	85030	89440	P117099	83120	

Ottawa Truck

Ottawa truck	Gabriel	Upgrade	Ottawa truck	Gabriel	Upgrade	Ottawa truck	Gabriel	Upgrade	Ottawa truck	Gabriel	Upgrade
90013787	85310	89423									

PACCAR

Paccar	Gabriel	Upgrade	Paccar	Gabriel	Upgrade	Paccar	Gabriel	Upgrade	Paccar	Gabriel	Upgrade
665633	85033	89427									

Important Note: Competitive Interchanges are to be used for stocking purposes only. Where multiple crosses are identified, please reference the applications section of this catalog./ **Remarque importante:** Les interchanges concurrentiels ne s'utilisent qu'aux fins de stocks. Dans le cas de rferences multiples, consulter la section des applications du catalogue./ **Nota importante:** Dans le cas de rferences multiples, consulter la section des applications du catalogue./ **Nota importante:** Se pueden usar intercambios competitivos para propósitos de almacenamiento solamente. Cuando se identifican intercambios múltiples, consulte la sección de aplicaciones de este catálogo.

COMPETITIVE & O.E.M. INTERCHANGE LIST

Lista de Intercambios contra Competidores y Equipo Original.

Liste d'interchange de produits complitifs & d'equiment original (OEM)

Pacific Truck & Trailer

Pacific truck & trailer	Gabriel	Upgrade	Pacific truck & trailer	Gabriel	Upgrade	Pacific truck & trailer	Gabriel	Upgrade	Pacific truck & trailer	Gabriel	Upgrade
507202C1	85030	89440									

Page Suspension

Page suspension	Gabriel	Upgrade	Page suspension	Gabriel	Upgrade	Page suspension	Gabriel	Upgrade	Page suspension	Gabriel	Upgrade
665267	85029		A-2212	85029		A2212	85029				

PAI Corp.

Pai corp.	Gabriel	Upgrade	Pai corp.	Gabriel	Upgrade	Pai corp.	Gabriel	Upgrade	Pai corp.	Gabriel	Upgrade
HSA-5080	83221		HSA-5095	83215		HSA5080	83221		HSA5095	83215	

Peerless Trailer

Peerless trailer	Gabriel	Upgrade	Peerless trailer	Gabriel	Upgrade	Peerless trailer	Gabriel	Upgrade	Peerless trailer	Gabriel	Upgrade
120-1	83125		1201	83125		72-61	83125		7261	83125	

Peterbilt

Peterbilt	Gabriel	Upgrade	Peterbilt	Gabriel	Upgrade	Peterbilt	Gabriel	Upgrade	Peterbilt	Gabriel	Upgrade
02-00376	85302	89420	02040102	85012	89413	12020054	83021		665660	85033	89427
02-00495	85302	89420	020739PLUS2	85013	89414	12021044	83025		665662	85012	89413
02-01759	83312	89409	03-04629	85311	89424	12887-01	85013	89414	665738	85910	
02-01890	85012	89413	03-05106	85033	89427	12887-02	85013	89414	665738-2	85910	
02-02061	85013	89414	03-05384	85033	89427	1288701	85013	89414	665752	85067	89451
02-02225	85012	89413	03-06084	85033	89427	1288702	85013	89414	665762	85012	89413
02-02736	85302	89420	03-06084PLUS	85033	89427	16725-01	83126	89430	665783	83123	89405
02-02736-2	85302	89420	03-06084PLUS-2	85033	89427	1672501	83126	89430	665784	83122	89406
02-02736PLUS	85302	89420	03-07281	85311	89424	1707378PAC	85182		665785	83137	
02-02736PLUS-2	85302	89420	03-07421	85311	89424	19495-01	83126	89430	665826	85069	89455
02-02738	85012	89413	03-07421PLUS	85311	89424	1949501	83126	89430	665844	85069	89455
02-02738-2	85012	89413	03-07421PLUS-2	85311	89424	23-12262	85012	89413	665858	85070	89459
02-02738PLUS	85012	89413	03-07421SPL	85311	89424	2312262	85012	89413	665858-2	85070	89459
02-02738PLUS-2	85012	89413	03-07423	85033	89427	47902-13PLUS	83122	89406	6658582	85070	89459
02-02739	85013	89414	03-07423-2	85033	89427	47902-13PLUS-2	83122	89406	665876	85959	
02-02739-2	85013	89414	03-07423PLUS	85033	89427	4790213PLUS	83122	89406	665918	85900	
02-02739PLUS	85013	89414	03-07423PLUS-2	85033	89427	60670-005PLUS	83137		665930	85001	89410
02-02741	85012	89413	03-07424	85311	89424	60670-005PLUS-2	83137		665931	83312	89409
02-02741-2	85012	89413	03-07424PLUS	85311	89424	60670-008	83123	89405	665932	85012	89413
02-03020	85910		03-08781	85069	89455	60670-008L	83123	89405	665945	85902	
02-04010	85012	89413	03-08781-2	85069	89455	60670-008PLUS	83123	89405	665945-2	85902	
02-04010-2	85012	89413	0304629	85311	89424	60670-008PLUS-2	83123	89405	665950	85902	
02-0739PLUS-2	85013	89414	0305106	85033	89427	60670005PLUS	83137		671052	85070	89459
0200376	85302	89420	0305384	85033	89427	60670008	83123	89405	671052-2	85070	89459
0200495	85302	89420	0306084	85033	89427	60670008L	83123	89405	6710522	85070	89459
0201759	83312	89409	0306084PLUS	85033	89427	60670008PLUS	83123	89405	671091	85069	89455
0201890	85012	89413	0306084PLUS2	85033	89427	60680-004	83143		671092	85012	89413
0202061	85013	89414	0307281	85311	89424	60680-004L	83143		671654	85936	89456
0202225	85012	89413	0307421	85311	89424	60680-005	83142		671794	85067	89451
0202736	85302	89420	0307421PLUS	85311	89424	60680-005L	83142		671962PLUS	85936	89456
02027362	85302	89420	0307421PLUS2	85311	89424	60680004	83143		671962SPL	85936	89456
0202736PLUS	85302	89420	0307421SPL	85311	89424	60680004L	83143		680026	85302	89420
0202736PLUS2	85302	89420	0307423	85033	89427	60680005	83142		680239	85310	89423
0202738	85012	89413	03074232	85033	89427	60680005L	83142		680240	85302	89420
02027382	85012	89413	0307423PLUS	85033	89427	665565PLUS	85007		680241	85311	89424
0202738PLUS	85012	89413	0307423PLUS2	85033	89427	665565PLUS-2	85007		680253	85314	89425
0202738PLUS2	85012	89413	0307424	85311	89424	665565PLUS2	85007		680279	83209	89414
0202739	85013	89414	0307424PLUS	85311	89424	665617	85031		680303	85007	
02027392	85013	89414	0308781	85069	89455	665617-2	85031		680348	85012	89413
0202739PLUS	85013	89414	03087812	85069	89455	6656172	85031		680435	85033	89427
0202741	85012	89413	1201-0054	83021		665632	85013	89414	680457	85302	89420
02027412	85012	89413	12010054	83021		665633	85033	89427	680459	85311	89424
0203020	85910		1202-0054	83021		665656	85012	89413	680586	85311	89424
0204010	85012	89413	1202-1044	83025		665657	85013	89414	70701PLUS	85900	

Important Note: Competitive Interchanges are to be used for stocking purposes only. Where multiple crosses are identified, please reference the applications section of this catalog. / **Remarque importante:** Les interchanges concurrentiels ne s'utilisent qu'aux fins de stocks. Dans le cas de rferences multiples, consulter la section des applications du catalogue. / **Nota importante:** Dans le cas de rferences multiples, consulter la section des applications du catalogue. / **Nota importante:** Se pueden usar intercambios competitivos para propósitos de almacenamiento solamente. Cuando se identifican intercambios múltiples, consulte la sección de aplicaciones de este catálogo.

COMPETITIVE & O.E.M. INTERCHANGE LIST

Lista de Intercambios contra Competidores y Equipo Original.

Liste dinterchange de produits comptitifs & dquipement original (OEM)

Peterbilt... cont'd

Peterbilt	Gabriel	Upgrade	Peterbilt	Gabriel	Upgrade	Peterbilt	Gabriel	Upgrade	Peterbilt	Gabriel	Upgrade
85013A0C	85013	89414	B71-6020	85989		C71-1011	85069	89455	C716000	85067	89451
85013ac0	85013	89414	B711000	85031		C71-1011PLUS	85069	89455	C7160002	85067	89451
90044025PLUS	83209	89414	B711001	85070	89459	C71-1011PLUS-2	85069	89455	C716002	85311	89424
90045132	85909		B711002	85001	89410	C71-1011SPL	85069	89455	C716003	85988	
ACHB966	83136		B711003	83312	89409	C71-1013	85985		C716005	85069	89455
B71-1000	85031		B716000	85959		C71-1014	85936	89456	C716015	85067	89451
B71-1001	85070	89459	B716002	85012	89413	C71-1016	85067	89451	K374-10-2	83215	
B71-1002	85001	89410	B7160022	85012	89413	C71-1017	85069	89455	K374-26PLUS	85001	89410
B71-1003	83312	89409	B716003	85029		C71-6000	85067	89451	K374-26PLUS-2	85001	89410
B71-6000	85959		B716004	85084	89460	C71-6000-2	85067	89451	K374-27-2	85001	89410
B71-6000-2	85959		B716005	85084	89460	C71-6002	85311	89424	K374-28PLUS	85314	89425
B71-6002	85012	89413	B716006	85084	89460	C71-6003	85988		K374-29PLUS	85310	89423
B71-6002-2	85012	89413	B716008	83312	89409	C71-6005	85069	89455	K374-33-2	83312	89409
B71-6003	85029		B716013	85012	89413	C71-6015	85067	89451	K374-33PLUS	83312	89409
B71-6003-2	85029		B716015	85012	89413	C711002	85067	89451	K374-33PLUS-2	83312	89409
B71-6004	85084	89460	B716016	85012	89413	C7110022	85067	89451	K374102	83215	
B71-6005	85084	89460	B716016A	85012	89413	C711002PLUS	85067	89451	K37426PLUS	85001	89410
B71-6006	85084	89460	B716017	85910		C711002PLUS2	85067	89451	K37426PLUS2	85001	89410
B71-6008	83312	89409	B716018	85012	89413	C711011	85069	89455	K374272	85001	89410
B71-6013	85012	89413	B716019	85989		C711011PLUS	85069	89455	K37428PLUS	85314	89425
B71-6015	85012	89413	B716020	85989		C711011PLUS2	85069	89455	K37429PLUS	85310	89423
B71-6016	85012	89413	BFRG 072	85182		C711011SPL	85069	89455	K37433PLUS	83312	89409
B71-6016A	85012	89413	C71-1002	85067	89451	C711013	85985		R71-1005	83024	
B71-6017	85910		C71-1002-2	85067	89451	C711014	85936	89456	R711005	83024	
B71-6018	85012	89413	C71-1002PLUS	85067	89451	C711016	85067	89451	TK19679	83126	89430
B71-6019	85989		C71-1002PLUS-2	85067	89451	C711017	85069	89455			

Phoenix Cruiser RV

Phoenix cruiser rv	Gabriel	Upgrade	Phoenix cruiser rv	Gabriel	Upgrade	Phoenix cruiser rv	Gabriel	Upgrade	Phoenix cruiser rv	Gabriel	Upgrade
ASH-1136	G63623		ASH-1154	G63622							

Pierce Manufacturing Inc.

Pierce manufacturing inc.	Gabriel	Upgrade	Pierce manufacturing inc.	Gabriel	Upgrade	Pierce manufacturing inc.	Gabriel	Upgrade	Pierce manufacturing inc.	Gabriel	Upgrade
10-13592-000	85959		2509223C91	83054		60657003	85072		814903003528	83038	
10-13760-000	85959		2509223C92	83054		60657003L	85072		9HE302	85919	
10-13809-000	85958		3514952C1	85976		60675-003	85976		ASH-85789	77986	
1013760000	85959		3576464C2	85957		60675-003L	85976		ASH-85927	77986	
1013809000	85958		3626571C2	85072		60675003	85976		ASH-866127	77986	
1201-9008	83054		3868265C1	85995		60675003L	85976		ASH-866139	77986	
12019008	83054		40-0242	83312	89409	60680-004	83143		H60657003	85072	
18-41762-000	83038		40-3089	83312	89409	60680-004L	83143		H60675-003	85976	
18-47349-000	83039		40-3135	85030	89440	60680-005	83142		H60675003	85976	
18-47350-000	83040		40-5348	85058	89431	60680-005L	83142		HC3Z-18125-EP	77986	
18-60764-000	83038		40-6967	85030	89440	60680004	83143		HC3Z-18125-X	77986	
18-60766-000	83040		400242	83312	89409	60680004L	83143		HDR60680-005	83142	
18-60767-000	83039		405348	85058	89431	60680005	83142		HDR60680005	83142	
1841762000	83038		406967	85030	89440	60680005L	83142		LC3Z-18125-J	77986	
1847349000	83039		471700000440	85959		6127088C1	83163		LC3Z-18125-W	77986	
1847350000	83040		471700002991	85959		6127713C2	85656		SDA471700002991	85959	
1860764000	83038		471700003920	85958		6127714C1	85928				
1860766000	83040		60657-003	85072		814903003482	83040				
1860767000	83039		60657-003L	85072		814903003483	83039				

ProPar

ProPar	Gabriel	Upgrade	ProPar	Gabriel	Upgrade	ProPar	Gabriel	Upgrade	ProPar	Gabriel	Upgrade
PROSH83122	83122	89406	PROSH85006	85006		PROSH85070	85070	89459	PROSH85923	85923	89458
PROSH83125	83125		PROSH85012	85012	89413	PROSH85310	85310	89423	PROSH85932	85932	89453
PROSH83127	83127		PROSH85030	85030	89440	PROSH85311	85311	89424	PROSH85936	85936	89456
PROSH85005	85005	89430	PROSH85069	85069	89455	PROSH85919	85919				

Important Note: Competitive Interchanges are to be used for stocking purposes only. Where multiple crosses are identified, please reference the applications section of this catalog. / **Remarque importante:** Les interchanges concurrentiels ne s'utilisent qu'aux fins de stocks. Dans le cas de références multiples, consulter la section des applications du catalogue. / **Nota importante:** Dans le cas de referencias multiples, consultar la sección de aplicaciones del catálogo. / **Nota importante:** Se pueden usar intercambios competitivos para propósitos de almacenamiento solamente. Cuando se identifican intercambios múltiples, consulte la sección de aplicaciones de este catálogo.

COMPETITIVE & O.E.M. INTERCHANGE LIST
Lista de Intercambios contra Competidores y Equipo Original.
Liste dinterchange de produits comptitifs & dquipement original (OEM)

ProPar... cont'd

			PRT (ADD)								
Prt (add)	Gabriel	Upgrade	Prt (add)	Gabriel	Upgrade	Prt (add)	Gabriel	Upgrade	Prt (add)	Gabriel	Upgrade
170198	81744		173697	61642		193577	61565		925078	83308	
170207	81510		173697	81921		193577	61687		925079	83309	
170996	81270		173698	61642		193581	61591		925080	83312	89409
171384	81096		173698	81921		193581	81744		925081	83314	
173228	61500		173704	61614		193582	61646		925082	83317	
173504	61544		173708	61500		193582	81828		925083	83364	
173504	61555		173708	81147		193698	81921		925084	83391	
173504	61685		173735	61565		193819	61663		925085	83395	
173504	81668		173735	61687		194267	61642		925088	83518	
173504	81713		173736	61522		194267	81921		925089	83519	
173505	61543		173736	81496		194432	81667		925090	83613	
173505	61565		173738	81091		583052	6850SE		925094	85001	89410
173505	81667		173739	81164		583053	6847SE		925096	85005	89430
173510	61542		173769	61634		583059	6847SE		925097	85006	
173510	61555		173769	81919		583060	6853SE		925098	85007	
173510	81713		173802	61710		584027	6856SE		925099	85009	
173510	81726		173802	61716		925006	83021		925100	85012	89413
173575	61655		173815	61612		925008	83024		925101	85013	89414
173581	61591		173815	81913		925009	83025		925106	85029	
173581	81744		173825	61714		925016	83040		925107	85030	89440
173582	61646		173826	61641		925027	83054		925108	85031	
173582	81828		173826	61663		925028	83056		925109	85033	89427
173584	61542		173826	81920		925034	83101		925111	85043	
173584	61555		173826	81925		925036	83107		925114	85054	
173584	81726		173832	61565		925039	83114		925116	85058	89431
173585	61611		173839	61683		925040	83120		925120	85063	
173585	81912		173841	61685		925041	83122	89406	925123	85067	89451
173586	61600		173859	61680		925042	83123	89405	925124	85069	89455
173586	81873		173860	61685		925044	83125		925125	85070	89459
173616	81496		173863	61654		925045	83126	89430	925126	85071	
173617	61546		173894	61687		925046	83131		925127	85072	
173621	61635		173895	81676		925047	83134		925130	85082	
173621	61714		173903	61655		925048	83135		925131	85084	89460
173622	61599		173933	61713		925049	83136		925142	85124	
173622	81928		174088	81484		925050	83137		925143	85125	
173623	61638		174244	61523		925051	83140		925145	85180	
173623	81892		174244	81096		925052	83141		925146	85181	
173624	61613		174303	61523		925053	83142		925148	85301	
173624	81914		174303	81096		925054	83143		925149	85302	89420
173625	61641		174315	81710		925057	83154		925154	85310	89423
173625	81920		174441	61642		925059	83159		925155	85311	89424
173626	61654		174441	81921		925060	83160		925156	85314	89425
173627	61656		174575	61638		925061	83162		925162	85331	
173627	61682		174575	81892		925063	83166		925163	85335	
173680	81091		174576	61612		925064	83169		925166	85376	
173681	81484		174576	81913		925065	83175		925173	85716	
173687	81744		175075	81039		925066	G63622		925175	85724	89443
173690	61591		175357	61642		925067	G63623		925178	85900	
173690	81744		175357	81921		925068	83180		925180	85909	
173696	61641		175441	61710		925070	83209	89414	925181	85918	89449
173696	61663		175448	61682		925071	83215		925182	85919	
173696	81920		175449	61713		925072	83216		925183	85920	89503
173696	81921		175450	81744		925074	83221		925184	85656	
173696	81925		193575	61655		925075	83225		925185	85927	

Important Note: Competitive Interchanges are to be used for stocking purposes only. Where multiple crosses are identified, please reference the applications section of this catalog. / **Remarque importante:** Les interchanges concurrentiels ne s'utilisent qu'aux fins de stocks. Dans le cas de références multiples, consulter la section des applications du catalogue. / **Nota importante:** Dans le cas de références multiples, consulter la section des applications du catalogue. / **Nota importante:** Se pueden usar intercambios competitivos para propósitos de almacenamiento solamente. Cuando se identifican intercambios múltiples, consulte la sección de aplicaciones de este catálogo.

COMPETITIVE & O.E.M. INTERCHANGE LIST
Lista de Intercambios contra Competidores y Equipo Original.
Liste d'interchange de produits compititifs & d'equpement original (OEM)

PRT (ADD)... cont'd

Prt (add)	Gabriel	Upgrade	Prt (add)	Gabriel	Upgrade	Prt (add)	Gabriel	Upgrade	Prt (add)	Gabriel	Upgrade
925186	85928		925216	85936	89456	925255	83148		925397	81744	
925187	85932	89453	925219	85957		925259	83164		925525	61682	
925188	85956		925224	85985		925260	83168		925531	61685	
925190	85959		925226	85988		925269	83456	89447	925567	61713	
925193	85976		925227	85989		925273	85010		925579	81920	
925210	85902		925229	85995		925292	85332		930288	81676	
925211	85921		925235	83006		925302	85351		930848	14072	
925212	85923	89458	925250	83127		925337	85910		932803	61655	

Rameriz Trailer

Rameriz trailer	Gabriel	Upgrade	Rameriz trailer	Gabriel	Upgrade	Rameriz trailer	Gabriel	Upgrade	Rameriz trailer	Gabriel	Upgrade
18165-01	85006		1816501	85006							

Rancho

Rancho	Gabriel	Upgrade	Rancho	Gabriel	Upgrade	Rancho	Gabriel	Upgrade	Rancho	Gabriel	Upgrade
RS5410	6854SE		RS7044	77948		RS7254	77952		RS7295	77817	
RS5413	6856SE		RS7044	77980		RS7267	77809		RS97488	6855SE	
RS7042	77951		RS7150	77609		RS7269	77950		RS999120	58357	
RS7044	77674		RS7190	77488		RS7272	77807				

Renegade RV

Renegade rv	Gabriel	Upgrade	Renegade rv	Gabriel	Upgrade	Renegade rv	Gabriel	Upgrade	Renegade rv	Gabriel	Upgrade
10-13760-000	85959		16-18708-000	85724	89443	471700002991	85959		SDA471700002991	85959	
1013760000	85959		1618708000	85724	89443	SDA471700002809	85724	89443			

Reyco Suspension

Reyco suspension	Gabriel	Upgrade	Reyco suspension	Gabriel	Upgrade	Reyco suspension	Gabriel	Upgrade	Reyco suspension	Gabriel	Upgrade
12887-01	85013	89414	17146-01	83209	89414	18164-01	83122	89406	20125-01	85030	89440
12887-02	85013	89414	1714601	83209	89414	1816401	83122	89406	2012501	85030	89440
1288701	85013	89414	17358-01	83126	89430	18165-01	85006		20129-01	85007	
1288702	85013	89414	1735801	83126	89430	1816501	85006		2012901	85007	
16725-01	83126	89430	17403-01	83122	89406	19495-01	83126	89430	21497-01	85005	89430
1672501	83126	89430	1740301	83122	89406	1949501	83126	89430	2149701	85005	89430
16824-01	85006		17408-01	85005	89430	19623-01	83123	89405	22062-01	85007	
1682401	85006		1740801	85005	89430	1962301	83123	89405	2206201	85007	
17142-01	85001	89410	17794-01	83215		19824-01	85006				
1714201	85001	89410	1779401	83215		1982401	85006				

Ridewell Corp.

Ridewell corp.	Gabriel	Upgrade	Ridewell corp.	Gabriel	Upgrade	Ridewell corp.	Gabriel	Upgrade	Ridewell corp.	Gabriel	Upgrade
1250546B000	85006		1267395B000	85302	89420	665198	85005	89430	AS3069B	85005	89430
1253069B000	85005	89430	1275943B	85005	89430	665267	85029		AS546B	85006	
1254190B000	85302	89420	57645	85005	89430	AS30698	85005	89430	AS575B	85005	89430

Road Titan

Road titan	Gabriel	Upgrade	Road titan	Gabriel	Upgrade	Road titan	Gabriel	Upgrade	Road titan	Gabriel	Upgrade
RT85001	85001	89410	RT85069	85069	89455	RT85311	85311	89424	RT85918	85918	89449
RT85067	85067	89451	RT85070	85070	89459	RT85724	85724	89443			

Roadmaster (Monaco)

Roadmaster (monaco)	Gabriel	Upgrade	Roadmaster (monaco)	Gabriel	Upgrade	Roadmaster (monaco)	Gabriel	Upgrade	Roadmaster (monaco)	Gabriel	Upgrade
90045132	85909		90045188	85910							

Sabo

Sabo	Gabriel	Upgrade	Sabo	Gabriel	Upgrade	Sabo	Gabriel	Upgrade	Sabo	Gabriel	Upgrade
8901024	85314	89425	8901029	85724	89443	8901033	85918	89449			
8901027	85310	89423	8901031	85900		8901156	G63299				

Sachs

Sachs	Gabriel	Upgrade	Sachs	Gabriel	Upgrade	Sachs	Gabriel	Upgrade	Sachs	Gabriel	Upgrade
141700000378	83160		290465	83125		311635	85030	89440	315394	85921	
141700131809	85029		311229	85918	89449	312724	85311	89424	315395	85724	89443
141700131810	83160		311230	85956		315390	85918	89449			
141700131975	83160		311632	85909		315391	85956				
290146	85012	89413	311633	85900		315392	85007				
290460	85005	89430	311634	85001	89410	315393	85331				

Important Note: Competitive Interchanges are to be used for stocking purposes only. Where multiple crosses are identified, please reference the applications section of this catalog. / **Remarque importante:** Les interchanges concurrentiels ne s'utilisent qu'aux fins de stocks. Dans le cas de rferences multiples, consulter la section des applications du catalogue. / **Nota importante:** En el caso de rferencias mltiples, consultar la seccion de aplicaciones del catalogo. / **Nota importante:** Se pueden usar intercambios competitivos para propósitos de almacenamiento solamente. Cuando se identifican intercambios mltiples, consulte la seccion de aplicaciones de este catalogo.

COMPETITIVE & O.E.M. INTERCHANGE LIST
Lista de Intercambios contra Competidores y Equipo Original.
Liste d'interchange de produits comptitifs & d'equipement original (OEM)

Sachs... cont'd

Sachs	Gabriel	Upgrade	Sachs	Gabriel	Upgrade	Sachs	Gabriel	Upgrade	Sachs	Gabriel	Upgrade
315396	85335		315618	83160		317776	83209	89414	471700000440	85959	
315397	83120		315619	83160		317930	83025		471700000447	85919	
315398	85058	89431	315623	85918	89449	317932	83101		471700000449	85918	89449
315399	85005	89430	315624	85959		317934	83123	89405	471700000459	85030	89440
315400	85006		315654	85070	89459	317935	83142		471700000466	85959	
315401	85331		315656	83040		317936	85030	89440	471700000470	85918	89449
315402	85900		315661	85932	89453	317937	83148		471700002726	85918	89449
315403	85919		315840	83126	89430	317938	85012	89413	471700002727	85959	
315404	85900		316 39	83215		317939	83314		471700002809	85724	89443
315406	85918	89449	316302	83163		317941	85302	89420	471700002990	85007	
315413	85932	89453	316303	83136		317945	83515		471700002991	85959	
315414	85959		316310	85311	89424	317953	85301		471700002992	85331	
315417	85923	89458	316312	83136		317956	83025		471700002993	85921	
315418	83456	89447	316316	85936	89456	317957	83225		471700002994	83134	
315423	83127		316320	85030	89440	317957	85007		471700002995	83134	
315424	85067	89451	316321	83317		317958	83308		471700002996	85335	
315426	85007		316478	85331		317960	85054		471700003009	85006	
315432	83209	89414	316485	85959		317962	85311	89424	471700003011	85058	89431
315432	85013	89414	316488	85919		317964	85029		471700005079	85005	89430
315540	83613		316490	85010		317965	83163		471700006269	85932	89453
315542	83122	89406	316491	85013	89414	317966	G63183		471700011530	85181	
315542	85005	89430	316493	85010		410010	83317		471700011531	85180	
315546	85005	89430	316815	85030	89440	410021	83125		471700014318	85188	
315548	85070	89459	316816	85012	89413	410022	85006		471700131155	85918	89449
315549	85033	89427	316820	85012	89413	410024	85302	89420	471700131331	85932	89453
315550	85311	89424	316822	85978		410025	83215		471700131545	85006	
315551	85310	89423	316823	85072		410026	85918	89449	471700131646	85918	89449
315553	85900		316824	85069	89455	410032	85001	89410	471700131775	85006	
315554	83125		316825	83021		410035	85001	89410	471700131778	85331	
315556	83215		316831	85043		410040	85909		471700131974	85029	
315593	85029		316832	83120		410042	85310	89423	481700000477	85900	
315594	85029		316834	85058	89431	410043	85957		481700000493	85900	
315597	85959		316837	83312	89409	410044	85031		481700125969	85956	
315600	85918	89449	316838	83309		410046	83136		481700131438	85919	
315601	85959		316839	83215		410047	85071		481700131919	85900	
315603	83134		316840	83126	89430	410057	83137		481700999386	85376	
315611	85006		316840	85030	89440	410057	85013	89414	510002	85302	89420
315612	85006		317529	83154		410058	83122	89406	510018	85724	89443
315613	85030	89440	317534	85084	89460	410068	85030	89440	814903003482	83040	
315613	85909		317534	85989		410068	85054				
315614	83125		317773	85656		471700000428	85006				
315617	85918	89449	317774	83122	89406	471700000436	85030	89440			

SAF Holland

Saf holland	Gabriel	Upgrade	Saf holland	Gabriel	Upgrade	Saf holland	Gabriel	Upgrade	Saf holland	Gabriel	Upgrade
471700000436	85030	89440	90044679	83122	89406	90045188	85910		AR-2598	83123	89405
471700000459	85030	89440	90044680	83125		90045277	85030	89440	AR1008	85006	
57643	85013	89414	90044682	83209	89414	90045455	85909		AR134C	85005	89430
6025	83122	89406	90044683	83122	89406	90045504	85030	89440	AR1404	85301	
665514	83127		90044687	83125		90045532	85030	89440	AR1425	85301	
90044001	85005	89430	90044688	83122	89406	90045665	85029		AR1654	83209	89414
90044012	85006		90044794	83127		90045813	85030	89440	AR2598	83123	89405
90044025	83209	89414	90044915	83127		AR-1008	85006		XB-SPN-053-36	83125	
90044046	83123	89405	90045083	85910		AR-134-C	85005	89430	XBSPN05336	83125	
90044625	83125		90045110	83137		AR-1404	85301				
90044626	83126	89430	90045132	85909		AR-1425	85301				
90044642	83127		90045138	85910		AR-1654	83209	89414			

Important Note: Competitive Interchanges are to be used for stocking purposes only. Where multiple crosses are identified, please reference the applications section of this catalog. / **Remarque importante:** Les interchanges concurrentiels ne s'utilisent qu'aux fins de stocks. Dans le cas de rferences multiples, consulter la section des applications du catalogue. / **Nota importante:** Dans le cas de rferences multiples, consulter la section des applications du catalogue. / **Nota importante:** Se pueden usar intercambios competitivos para propósitos de almacenamiento solamente. Cuando se identifican intercambios múltiples, consulte la sección de aplicaciones de este catálogo.

COMPETITIVE & O.E.M. INTERCHANGE LIST
Lista de Intercambios contra Competidores y Equipo Original.
Liste dinterchange de produits comptitifs & dquipement original (OEM)

Safari Motor Coach

Safari motor coach	Gabriel	Upgrade	Safari motor coach	Gabriel	Upgrade	Safari motor coach	Gabriel	Upgrade	Safari motor coach	Gabriel	Upgrade
B462092	83126	89430	B462092	85910		B462093	85058	89431			

SenSen

SenSen	Gabriel	Upgrade	SenSen	Gabriel	Upgrade	SenSen	Gabriel	Upgrade	SenSen	Gabriel	Upgrade
1213-0188	61516		1214-0141	61642		1214-0184	81490		1214-0199	81925	
1213-0188	61525		1214-0141	81873		1214-0185	61599		1214-0210	61654	
1213-0188	81039		1214-0142	81873		1214-0185	81928		1214-0211	61656	
1213-0188	81113		1214-0145	61542		1214-0186	61634		1214-0212	61565	
1213-0189	61524		1214-0145	81726		1214-0186	61635		1214-0213	61687	
1213-0189	81164		1214-0150	81873		1214-0186	81919		1214-0240	81510	
1213-0273	81147		1214-0151	81921		1214-0189	61611		1214-0240	81710	
1213-0332	81744		1214-0174	61714		1214-0189	81912		1214-0252	61680	
1214-0125	61710		1214-0176	61685		1214-0190	61638		1214-0253	61682	
1214-0125	61716		1214-0176	81668		1214-0190	81892		1214-0253	61713	
1214-0129	81726		1214-0177	61591		1214-0191	61613		1214-0273	81147	
1214-0130	61547		1214-0178	61646		1214-0191	61614		1214-0395	61517	
1214-0130	81082		1214-0178	81828		1214-0191	81914		1214-0396	61522	
1214-0132	81667		1214-0179	61544		1214-0192	61612		1214-0396	81496	
1214-0137	81821		1214-0179	61555		1214-0192	81913		1214-0408	81484	
1214-0138	61543		1214-0179	81668		1214-0193	61641		1214-0420	61530	
1214-0138	81667		1214-0182	81713		1214-0193	81920		1214-0433	61554	
1214-0141	61600		1214-0184	61546		1214-0199	61663		3214-0185	81744	

Shasta RV

Shasta rv	Gabriel	Upgrade	Shasta rv	Gabriel	Upgrade	Shasta rv	Gabriel	Upgrade	Shasta rv	Gabriel	Upgrade
8C24-18045-DA	G63622		8C2Z-18124-D	G63622		ASH-1136	G63623		AT-163G	G63622	
8C24-18080-DB	G63623		8C2Z-18125-D	G63623		ASH-1154	G63622		AT-164G	G63623	
8C2418045DA	G63622		8C2Z18124D	G63622		ASH1136	G63623		AT163G	G63622	
8C2418080DB	G63623		8C2Z18125D	G63623		ASH1154	G63622		AT164G	G63623	

Spartan Motors

Spartan motors	Gabriel	Upgrade	Spartan motors	Gabriel	Upgrade	Spartan motors	Gabriel	Upgrade	Spartan motors	Gabriel	Upgrade
0272-SS5	85712		2200201	85007		60665014	85962		B461725	85029	
0272SS5	85712		471700000456	85959		60665014L	85962		B461725	85910	
0346-SS5	85013	89414	58913-009	85959		60665025L	85036	89405	B461731	85909	
0346-SS5	85030	89440	58913-009L	85959		AS 4025B	85712		B461732	85030	89440
0346SS5	85013	89414	58913009	85959		B46-1594	85013	89414	B462150	85909	
0346SS5	85030	89440	58913009L	85959		B46-1594	85030	89440	B462151	85007	
0377-SS5	85029		59011	83214		B46-1725	85029		B462151	85030	89440
0377SS5	85029		60665-014	85962		B46-2151	85007		B462385	85030	89440
1300B46	85029		60665-014L	85962		B461593	85909		B462502	85013	89414
21310-01	85307		60665-025	85036	89405	B461594	85013	89414	B462502	85030	89440
2131001	85307		60665-025L	85036	89405	B461594	85030	89440	S2607B	85702	

Starcraft Bus Co.

Starcraft bus co.	Gabriel	Upgrade	Starcraft bus co.	Gabriel	Upgrade	Starcraft bus co.	Gabriel	Upgrade	Starcraft bus co.	Gabriel	Upgrade
3578858C1	85656		4C4Z-18125-DA	85656		ASH-1136	G63623		FC44-18045-BB	85181	
3578858C2	85656		4C4Z18124JB	85928		ASH-1154	G63622		FC44-18080-AB	85180	
3584116C1	83175		4C4Z18124QA	83175		ASH-24658	85181		FC4418045BB	85181	
3584116C2	83175		4C4Z18124RA	85928		ASH-24659	85181		FC4418080AB	85180	
3584118C2	85928		4C4Z18125B	83317		ASH-24660	85180		FC4Z-18124-A	85181	
471700011530	85181		4C4Z18125DA	85656		ASH24658	85181		FC4Z-18124-B	85181	
471700011531	85180		501906C92	83317		ASH24659	85181		FC4Z-18125-A	85180	
4C4Z-18124-JB	85928		AA-616	83175		ASH24660	85180		FC4Z18124A	85181	
4C4Z-18124-QA	83175		AA-617	85928		ASH24661	83317		FC4Z18124B	85181	
4C4Z-18124-RA	85928		AA616	83175		AT-812	85928		FC4Z18125A	85180	
4C4Z-18125-B	83317		AA617	85928		AT812	85928				

Stellantis

Stellantis	Gabriel	Upgrade	Stellantis	Gabriel	Upgrade	Stellantis	Gabriel	Upgrade	Stellantis	Gabriel	Upgrade
05168284AC	85649		05168296AA	85650							
05168295AB	85649		2516009	G63183							

Important Note: Competitive Interchanges are to be used for stocking purposes only. Where multiple crosses are identified, please reference the applications section of this catalog. / **Remarque importante:** Les interchanges concurrentiels ne s'utilisent qu'aux fins de stocks. Dans le cas de rfrences multiples, consulter la section des applications du catalogue. / **Nota importante:** Dans le cas de rfrences multiples, consulter la section des applications du catalogue. / **Nota importante:** Se pueden usar intercambios competitivos para propósitos de almacenamiento solamente. Cuando se identifican intercambios múltiples, consulte la sección de aplicaciones de este catálogo.

COMPETITIVE & O.E.M. INTERCHANGE LIST
Lista de Intercambios contra Competidores y Equipo Original.
Liste dinterchange de produits comptitifs & dquipement original (OEM)

Stellantis... cont'd

Stellantis	Gabriel	Upgrade	Stellantis	Gabriel	Upgrade	Stellantis	Gabriel	Upgrade	Stellantis	Gabriel	Upgrade
2960707	G63183		4036892	G63605		6811 1104AB001	85649		6811 1107AA001	85650	
2961043	G63183		4443 482	81825		6811 1105AC	85649		G0060043	81834	
3633643	G63183		4897 443AD	81928		6811 1105AC-001	85649		MB242146	81147	
3633744	G63183		4897 472AD	81919		6811 1105AC001	85649		MB515371	81147	
3638112	G63183		6811 1104AB	85649		6811 1107AA	85650		SG23086	81496	
3638631	G63605		6811 1104AB-001	85649		6811 1107AA-001	85650		SG23127	81096	

Sterling Truck

Sterling truck	Gabriel	Upgrade	Sterling truck	Gabriel	Upgrade	Sterling truck	Gabriel	Upgrade	Sterling truck	Gabriel	Upgrade
05168284AC	85649		6811 1104AB-001	85649		E9HZ18124A	83309		F6HT-18045-GB	85030	89440
05168295AB	85649		6811 1104AB001	85649		F0HZ-18124-B	85006		F6HT-18045-GC	85030	89440
05168296AA	85650		6811 1105AC	85649		F0HZ18124B	85006		F6HT-18045-HB	85054	
10-12388-000	85920	89503	6811 1105AC-001	85649		F1HZ-18124-A	83309		F6HT-18045-HC	85054	
10-12390-000	85920	89503	6811 1105AC001	85649		F1HZ-18124-B	83308		F6HT-18045-LA	85376	
10-13205-000	85918	89449	6811 1107AA	85650		F1HZ-18124-D	85006		F6HT-18080-CA	85314	89425
1012388000	85920	89503	6811 1107AA-001	85650		F1HZ-18124-E	85006		F6HT-18080-FC	85013	89414
1012390000	85920	89503	6811 1107AA001	85650		F1HZ-18124-J	83308		F6HT18045AA	85054	
1013205000	85918	89449	6E7Z-18125-A	83364		F1HZ18124A	83309		F6HT18045AC	85054	
1202-1043	83025		6E7Z18125A	83364		F1HZ18124B	83308		F6HT18045GB	85030	89440
12021043	83025		AT-560	G63809		F1HZ18124D	85006		F6HT18045GC	85030	89440
16-13957-000	85724	89443	AT560	G63809		F1HZ18124E	85006		F6HT18045HB	85054	
16-15770-000	85956		AX-267A	83309		F1HZ18124J	83308		F6HT18045HC	85054	
16-15817-000	85724	89443	AX-310	83215		F2HZ-18124-A	85376		F6HT18045LA	85376	
1613957000	85724	89443	AX267A	83309		F2HZ-18124-B	85301		F6HT18080CA	85314	89425
1615770000	85956		AX310	83215		F2HZ18124A	85376		F6HT18080FC	85013	89414
1615817000	85724	89443	C4HZ-18124-E	83309		F2HZ18124B	85301		F6HZ-18124-A	85054	
471700131331	85932	89453	C4HZ18124E	83309		F4HT-18080-AB	85314	89425	F6HZ-18124-B	83308	
471700131646	85918	89449	C4TZ-18124-AB	83308		F4HT-18080-BA	85001	89410	F6HZ-18124-G	85054	
47902-28	85013	89414	C4TZ18124AB	83308		F4HT18080AB	85314	89425	F6HZ-18124-H	85054	
4790228	85013	89414	D8HZ-18124-A	85301		F4HT18080BA	85001	89410	F6HZ-18125-D	85013	89414
481700125969	85956		D8HZ18124A	85301		F5HZ-18124-A	83314		F6HZ18124A	85054	
4C4Z-18124-N	85957		E6HZ-18124-A	85301		F5HZ-18124-B	83107		F6HZ18124B	83308	
4C4Z-18125-DA	85656		E6HZ-18124-D	85301		F5HZ-18124-C	85063		F6HZ18124G	85054	
4C4Z18124N	85957		E6HZ-18125-D	83215		F5HZ-18124-D	83125		F6HZ18124H	85054	
4C4Z18125DA	85656		E6HZ18124A	85301		F5HZ-18125-A	85314	89425	F6HZ18125D	85013	89414
58913-003	85932	89453	E6HZ18124D	85301		F5HZ-18125-B	85001	89410	F81A-18045-AGB	G63809	
58913-003L	85932	89453	E6HZ18125D	83215		F5HZ18124A	83314		F81A18045AGB	G63809	
58913003	85932	89453	E7HZ-18124-A	85301		F5HZ18124B	83107		XC45-18045-AA	83216	
58913003L	85932	89453	E7HZ18124A	85301		F5HZ18124C	85063		XC45-18080-BA	85724	89443
6803230300	85006		E7XZ-18124-A	G63386		F5HZ18124D	83125		XC4518045AA	83216	
6803260000	83120		E7XZ-18125-B	G63387		F5HZ18125A	85314	89425	XC4518080BA	85724	89443
680339	85724	89443	E7XZ18124A	G63386		F5HZ18125B	85001	89410			
680611	85724	89443	E7XZ18125B	G63387		F6HT-18045-AA	85054				
6811 1104AB	85649		E9HZ-18124-A	83309		F6HT-18045-AC	85054				

Stoughton Trailers Inc.

Stoughton trailers inc.	Gabriel	Upgrade	Stoughton trailers inc.	Gabriel	Upgrade	Stoughton trailers inc.	Gabriel	Upgrade	Stoughton trailers inc.	Gabriel	Upgrade
RT18165-01	85006		RT1816501	85006							

SYD

Syd	Gabriel	Upgrade	Syd	Gabriel	Upgrade	Syd	Gabriel	Upgrade	Syd	Gabriel	Upgrade
7000020	81147		7000050	61500		7000166	61641		7000248	61646	
7000040	77968		7000056	81082		7000166	81920		7000250	81726	
7000044	81490		7000058	81668		7000167	81873		7000397	6847SE	
7000045	81713		7000059	81667		7000167	81921		7000406	6853SE	
7000048	81928		7000164	61663		7000218	6804SE				
7000049	61600		7000164	81925		7000219	6828SE				

Important Note: Competitive Interchanges are to be used for stocking purposes only. Where multiple crosses are identified, please reference the applications section of this catalog. / **Remarque importante:** Les interchanges concurrentiels ne s'utilisent qu'aux fins de stocks. Dans le cas de rferences multiples, consulter la section des applications du catalogue. / **Nota importante:** Dans le cas de rferences multiples, consulter la section des applications du catalogue. / **Nota importante:** Se pueden usar intercambios competitivos para propósitos de almacenamiento solamente. Cuando se identifican intercambios múltiples, consulte la sección de aplicaciones de este catálogo.

COMPETITIVE & O.E.M. INTERCHANGE LIST

Lista de Intercambios contra Competidores y Equipo Original.

Liste d'interchange de produits compititifs & d'equipement original (OEM)

The Binkley Company

The binkley company	Gabriel	Upgrade	The binkley company	Gabriel	Upgrade	The binkley company	Gabriel	Upgrade	The binkley company	Gabriel	Upgrade
16965	85006		6898	83125							

Thomas

Thomas	Gabriel	Upgrade	Thomas	Gabriel	Upgrade	Thomas	Gabriel	Upgrade	Thomas	Gabriel	Upgrade
00614966	85307		3000614966	85307		61300223	85014		6803260000	83120	
10-13211-000	85918	89449	471700003070	85122		61300224	85918	89449	70445	85014	
10-13634-000	85918	89449	471700131545	85006		61300240	85918	89449	8C24-18045-DA	G63622	
1013211000	85918	89449	60670-006	83147		61300285	83102		8C24-18080-DB	G63623	
1013634000	85918	89449	60670-006L	83147		61310101	85736		8C2Z-18124-D	G63622	
16-15817-000	85724	89443	60670006	83147		61310232	85000	89436	8C2Z-18125-D	G63623	
16-18708-000	85724	89443	60670006L	83147		61310434	85724	89443	90045504	85030	89440
16-18713-000	85122		60998-001	85006		61310478	85724	89443	ASH-1136	G63623	
16-19138-000	85058	89431	60998-003	85006		614974	85304		ASH-1154	G63622	
1615817000	85724	89443	60998001	85006		680-323-0300	85006		AT-163G	G63622	
1618708000	85724	89443	60998003	85006		680-326-0000	83120		AT-164G	G63623	
1618713000	85122		61300112	83613		680010	85304		GBL651442	83102	
1619138000	85058	89431	61300219	85014		680054	85307		GBL654725	83120	
300-0614966	85307		61300222	85014		6803230300	85006		GBL665538	85006	

Thor Motor Coach

Thor motor coach	Gabriel	Upgrade	Thor motor coach	Gabriel	Upgrade	Thor motor coach	Gabriel	Upgrade	Thor motor coach	Gabriel	Upgrade
141700131809	85029		8C2418080DB	G63623		ASH-1206	83122	89406	ASH1229	83209	89414
141700131810	83160		8C2Z-18124-D	G63622		ASH-1228	83209	89414	ASH1230	83122	89406
16-16736-000	85029		8C2Z-18125-D	G63623		ASH-1229	83209	89414	ASH137	83122	89406
16-16737-000	83160		8C2Z18124D	G63622		ASH-1230	83122	89406	ASH25820	85005	89430
16-16873-000	85029		8C2Z18125D	G63623		ASH-137	83122	89406	ASH25821	85006	
16-16874-000	83160		9U94-18045-AA	83209	89414	ASH-25820	85005	89430	ASH25822	83209	89414
16-18103-000	85900		9U94-18080-AA	83122	89406	ASH-25821	85006		ASH25823	83209	89414
1616736000	85029		9U9418045AA	83209	89414	ASH-25822	83209	89414	ASH25824	83122	89406
1616737000	83160		9U9418080AA	83122	89406	ASH-25823	83209	89414	ASH294	83209	89414
1616873000	85029		9U9Z-18124-A	83209	89414	ASH-25824	83122	89406	AT-163G	G63622	
1616874000	83160		9U9Z-18125-A	83122	89406	ASH-294	83209	89414	AT-164G	G63623	
1618103000	85900		9U9Z18124A	83209	89414	ASH1022	83209	89414	AT-620	83209	89414
1C34-18045-AA	83209	89414	9U9Z18125A	83122	89406	ASH1023	83122	89406	AT-621	83122	89406
1C34-18045-JA	83209	89414	ASH-1022	83209	89414	ASH1136	G63623		AT-766	83209	89414
1C3418045AA	83209	89414	ASH-1023	83122	89406	ASH1154	G63622		AT163G	G63622	
1C3418045JA	83209	89414	ASH-1136	G63623		ASH1161	85006		AT164G	G63623	
481700000493	85900		ASH-1154	G63622		ASH1162	85005	89430	AT620	83209	89414
8C24-18045-DA	G63622		ASH-1161	85006		ASH1205	83209	89414	AT621	83122	89406
8C24-18080-DB	G63623		ASH-1162	85005	89430	ASH1206	83122	89406	AT766	83209	89414
8C2418045DA	G63622		ASH-1205	83209	89414	ASH1228	83209	89414			

Tiffin Motorhomes Inc.

Tiffin motorhomes inc.	Gabriel	Upgrade	Tiffin motorhomes inc.	Gabriel	Upgrade	Tiffin motorhomes inc.	Gabriel	Upgrade	Tiffin motorhomes inc.	Gabriel	Upgrade
58913-009	85959		58913-009L	85959		58913009	85959		58913009L	85959	

Trailmobile Canada Corp.

Trailmobile canada corp.	Gabriel	Upgrade	Trailmobile canada corp.	Gabriel	Upgrade	Trailmobile canada corp.	Gabriel	Upgrade	Trailmobile canada corp.	Gabriel	Upgrade
43-4-236	85029		43-8-015	85006		436158	85013	89414	90044625	83125	
43-4-241	85006		43-8-022	83225		438002	83209	89414	90044642	83127	
43-6-137	85006		43-8-031	85029		438014	85013	89414	A-2212	85029	
43-6-158	85013	89414	434236	85029		438015	85006		A2212	85029	
43-8-002	83209	89414	434241	85006		438022	83225				
43-8-014	85013	89414	436137	85006		438031	85029				

TRP

Trp	Gabriel	Upgrade	Trp	Gabriel	Upgrade	Trp	Gabriel	Upgrade	Trp	Gabriel	Upgrade
HS 83125	83125		HS 85029	85029		HS 85070	85070	89459	HS 85918	85918	89449
HS 85001	85001	89410	HS 85033	85033	89427	HS 85310	85310	89423			
HS 85005	85005	89430	HS 85058	85058	89431	HS 85311	85311	89424			
HS 85006	85006		HS 85067	85067	89451	HS 85724	85724	89443			
HS 85012	85012	89413	HS 85069	85069	89455	HS 85900	85900				

Important Note: Competitive Interchanges are to be used for stocking purposes only. Where multiple crosses are identified, please reference the applications section of this catalog. / **Remarque importante:** Les interchanges concurrentiels ne s'utilisent qu'aux fins de stocks. Dans le cas de rfrences multiples, consulter la section des applications du catalogue. / **Nota importante:** Dans le cas de rfrences multiples, consulter la section des aplicaciones du catalogue. / **Nota importante:** Se pueden usar intercambios competitivos para propósitos de almacenamiento solamente. Cuando se identifican intercambios múltiples, consulte la sección de aplicaciones de este catálogo.

COMPETITIVE & O.E.M. INTERCHANGE LIST
Lista de Intercambios contra Competidores y Equipo Original.
Liste dinterchange de produits comptitifs & dquipement original (OEM)

TRP... cont'd

Trp	Gabriel	Upgrade	Trp	Gabriel	Upgrade	Trp	Gabriel	Upgrade	Trp	Gabriel	Upgrade
HS 85919	85919		HS 85920	85920	89503	HS 85936	85936	89456			

Truckmaster

Truckmaster	Gabriel	Upgrade	Truckmaster	Gabriel	Upgrade	Truckmaster	Gabriel	Upgrade	Truckmaster	Gabriel	Upgrade
665632	85013	89414	665930	85001	89410	680239	85310	89423	680348	85012	89413
665633	85033	89427	665931	83312	89409	680240	85302	89420	680385	85311	89424
665783	83123	89405	665932	85012	89413	680241	85311	89424	680435	85033	89427
665784	83122	89406	665950	85902		680243	85001	89410	680586	85311	89424
665785	83137		671052	85070	89459	680253	85314	89425	680601	85012	89413
665844	85069	89455	671654	85936	89456	680279	83209	89414			
665918	85900		671794	85067	89451	680303	85007				

TRW

Trw	Gabriel	Upgrade	Trw	Gabriel	Upgrade	Trw	Gabriel	Upgrade	Trw	Gabriel	Upgrade
JGT4106S	81270		JGT5038S	81914		JGT5076S	81113		JGT5094S	81912	
JGT5008S	81892		JGT5040S	81713		JGT5078S	81873		JGT5574S	82155	
JGT5020S	81928		JGT5060S	81668		JGT5088S	81490		JOT5254S	77674	
JGT5034S	81082		JGT5064S	81667		JGT5090S	81920				

Turtletop Bus

Turtletop bus	Gabriel	Upgrade	Turtletop bus	Gabriel	Upgrade	Turtletop bus	Gabriel	Upgrade	Turtletop bus	Gabriel	Upgrade
ASH-1136	G63623		ASH-1154	G63622							

Tuthill Technologies

Tuthill technologies	Gabriel	Upgrade	Tuthill technologies	Gabriel	Upgrade	Tuthill technologies	Gabriel	Upgrade	Tuthill technologies	Gabriel	Upgrade
12887-01	85013	89414	1714201	85001	89410	17794-01	83215		1962301	83123	89405
12887-02	85013	89414	17146-01	83209	89414	1779401	83215		19824-01	85006	
1288701	85013	89414	1714601	83209	89414	18164-01	83122	89406	1982401	85006	
1288702	85013	89414	17358-01	83126	89430	1816401	83122	89406	20125-01	85030	89440
16725-01	83126	89430	1735801	83126	89430	18165-01	85006		2012501	85030	89440
1672501	83126	89430	17403-01	83122	89406	1816501	85006		20129-01	85007	
16824-01	85006		1740301	83122	89406	19495-01	83126	89430	2012901	85007	
1682401	85006		17408-01	85005	89430	1949501	83126	89430	21497-01	85005	89430
17142-01	85001	89410	1740801	85005	89430	19623-01	83123	89405	2149701	85005	89430

UD

Ud	Gabriel	Upgrade	Ud	Gabriel	Upgrade	Ud	Gabriel	Upgrade	Ud	Gabriel	Upgrade
561000T825	83515		56101Z5014	83162		56110-Z5014	83162		56110Z5017	83162	
56101-30Z02	G63610		56101Z5017	83162		56110-Z5017	83162		66400	G63432	
56101-Z5008	83114		56110-30Z02	G63610		56110T8123	G63432		E61000T825	83515	
56101-Z5014	83162		56110-T8123	G63432		56110T8129	G63432				
56101-Z5017	83162		56110-T8129	G63432		56110Z5008	83114				
56101Z5008	83114		56110-Z5008	83114		56110Z5014	83162				

Unity

Unity	Gabriel	Upgrade	Unity	Gabriel	Upgrade	Unity	Gabriel	Upgrade	Unity	Gabriel	Upgrade
14-510900	49231		256200	61716							

UPS Truck

Ups truck	Gabriel	Upgrade	Ups truck	Gabriel	Upgrade	Ups truck	Gabriel	Upgrade	Ups truck	Gabriel	Upgrade
P117099	83120		P117146	83118							

Volvo

Volvo	Gabriel	Upgrade	Volvo	Gabriel	Upgrade	Volvo	Gabriel	Upgrade	Volvo	Gabriel	Upgrade
03-1106460	85005	89430	1091364	83312	89409	23159763	85188		3199948	85311	89424
031106460	85005	89430	1091370	85006		23567823	85072		3199949	85310	89423
1091347	83125		1091372	85301		25624730	85005	89430	3199957	83122	89406
1091348	83122	89406	1091373	85302	89420	3199938	85030	89440	3199962	85314	89425
1091351	83209	89414	1091379	85310	89423	3199939	85058	89431	3199967	85302	89420
1091353	83215		1093180	85030	89440	3199940	85005	89430	3199980	85310	89423
1091354	83216		14QK-429M2	85072		3199941	85006		3199984	85314	89425
1091358	83456	89447	1593843	83215		3199943	85012	89413			
1091359	83123	89405	20707753	85030	89440	3199944	85006				
1091362	83309		20782199	85072		3199946	85033	89427			
1091363	83221		23159761	85188		3199947	85013	89414			

Important Note: Competitive Interchanges are to be used for stocking purposes only. Where multiple crosses are identified, please reference the applications section of this catalog. / **Remarque importante:** Les interchanges concurrentiels ne s'utilisent qu'aux fins de stocks. Dans le cas de rferences multiples, consulter la section des applications du catalogue. / **Nota importante:** Dans le cas de rferences multiples, consulter la section des applications du catalogue. / **Nota importante:** Se pueden usar intercambios competitivos para propósitos de almacenamiento solamente. Cuando se identifican intercambios múltiples, consulte la sección de aplicaciones de este catálogo.

COMPETITIVE & O.E.M. INTERCHANGE LIST
Lista de Intercambios contra Competidores y Equipo Original.
Liste dinterchange de produits comptitifs & dquipement original (OEM)

Volvo... cont'd

Volvo	Gabriel	Upgrade	Volvo	Gabriel	Upgrade	Volvo	Gabriel	Upgrade	Volvo	Gabriel	Upgrade
3199988	85311	89424	3919915	83127		60675-001	85978		90045132	85909	
35901-0001	83209	89414	3919916	83126	89430	60675-001L	85978		ASH-24446	83215	
35901-0003	85301		3919917	83125		60675001	85978		ASH24446	83215	
35901-0011	83123	89405	3919919	G63625		60675001L	85978		AX-310	83215	
35901-0017	83314		3919921	83123	89405	60680-004	83143		AX310	83215	
35901-3413	85006		3919924	83456	89447	60680-004L	83143		D7HT-18080-AA	83215	
359010001	83209	89414	3919925	83317		60680-005	83142		D7HT-18080-DA	83215	
359010003	85301		3919926	G63403		60680-005L	83142		D7HT18080AA	83215	
359010011	83123	89405	3919927	83101		60680004	83143		D7HT18080DA	83215	
359010017	83314		3919928	83225		60680004L	83143		EOHT-18080-AA	83215	
359013413	85006		3919931	83126	89430	60680005	83142		EOHT18080AA	83215	
37301-0001	85013	89414	3919933	85001	89410	60680005L	83142		RC SA3125	83125	
37301-0018	85005	89430	3919938	85030	89440	662211401	83215		RC SA3127	83127	
373010001	85013	89414	3919939	85058	89431	668302	83216		RC SA3136	83136	
373010018	85005	89430	3919940	85005	89430	6790756	83215		RC SA3148	83148	
3915947	85001	89410	3919941	85006		70042	85302	89420	RC SA3216	83216	
3915948	85311	89424	3919943	85012	89413	8083872	85978		RC SA5001	85001	89410
3916352	85013	89414	3919946	85033	89427	83176199	83123	89405	RC SA5005	85005	89430
3919055	85007		3919947	85013	89414	83176201	83125		RC SA5067	85067	89451
3919057	83225		3919948	85311	89424	83176202	83126	89430	RC SA5070	85070	89459
3919526	83314		3919949	85310	89423	83176203	83127		RC SA5310	85310	89423
3919561	85314	89425	3919951	83309		83176205	83136		RC SA5724	85724	89443
3919567	83613		3919957	83122	89406	83176206	83148		RC SA5900	85900	
3919573	83123	89405	3919961	85302	89420	83176208	83209	89414	RC SA5918	85918	89449
3919574	85006		3919967	85302	89420	83176209	83215		SA3123	83123	89405
3919575	83120		3919973	85956		83176210	83216		SA3125	83125	
3919582	83215		3919976	85033	89427	83176212	85001	89410	SA3126	83126	89430
3919585	83209	89414	3919977	85033	89427	83176214	85005	89430	SA3127	83127	
3919588	83216		3919988	85311	89424	83176217	85033	89427	SA3136	83136	
3919591	83515		3919994	85310	89423	83176226	85067	89451	SA3148	83148	
3919598	83312	89409	3946217	83125		83176227	85069	89455	SA5001	85001	89410
3919900	85012	89413	3946239	85724	89443	83176228	85070	89459	SA5005	85005	89430
3919902	83126	89430	3972662	85976		83176230	85310	89423	SA5033	85033	89427
3919903	83216		471700014318	85188		83176231	85311	89424	SA5067	85067	89451
3919904	G63183		47902-24	83137		83176235	85724	89443	SA5069	85069	89455
3919906	83308		4790224	83137		83176236	85900		SA5070	85070	89459
3919907	83309		4940640	83216		83176238	85918	89449	SA5310	85310	89423
3919909	G63605		4975549	83216		85104186	85006		SA5311	85311	89424
3919910	83221		5513989	83216		85106580	85918	89449	SA5724	85724	89443
3919912	83215		60657-007	85072		85107238	85976		SA5900	85900	
3919914	83209	89414	60657007	85072		85137234	83125		SA5918	85918	89449

Volvo RoadChoice

Volvo roadchoice	Gabriel	Upgrade	Volvo roadchoice	Gabriel	Upgrade	Volvo roadchoice	Gabriel	Upgrade	Volvo roadchoice	Gabriel	Upgrade
SA3066	83066		SA3148	83148		SA5012	85012	89413	SA5311	85311	89424
SA3123	83123	89405	SA3209	83209	89414	SA5033	85033	89427	SA5724	85724	89443
SA3125	83125		SA3215	83215		SA5067	85067	89451	SA5900	85900	
SA3126	83126	89430	SA3216	83216		SA5069	85069	89455	SA5918	85918	89449
SA3127	83127		SA5001	85001	89410	SA5070	85070	89459			
SA3136	83136		SA5005	85005	89430	SA5310	85310	89423			

Wabash National

Wabash national	Gabriel	Upgrade	Wabash national	Gabriel	Upgrade	Wabash national	Gabriel	Upgrade	Wabash national	Gabriel	Upgrade
202447	85919		FLL85030071	85030	89440	NEW900-44-642	83127		NEW90044626	83126	89430
203447	85919		NEW900-44-625	83125		NEW900-44-794	83127		NEW90044642	83127	
FLL85030-071	85030	89440	NEW900-44-626	83126	89430	NEW90044625	83125		NEW90044794	83127	

Important Note: Competitive Interchanges are to be used for stocking purposes only. Where multiple crosses are identified, please reference the applications section of this catalog. / **Remarque importante:** Les interchanges concurrentiels ne s'utilisent qu'aux fins de stocks. Dans le cas de rferences multiples, consulter la section des applications du catalogue. / **Nota importante:** Dans le cas de rferences multiples, consulter la section des applications du catalogue. / **Nota importante:** Se pueden usar intercambios competitivos para propósitos de almacenamiento solamente. Cuando se identifican intercambios múltiples, consulte la sección de aplicaciones de este catálogo.

COMPETITIVE & O.E.M. INTERCHANGE LIST

Lista de Intercambios contra Competidores y Equipo Original.

Liste dinterchange de produits comptitifs & dquipement original (OEM)

Watson & Chalin Mfg. Inc.

Watson & chalin mfg. inc.	Gabriel	Upgrade	Watson & chalin mfg. inc.	Gabriel	Upgrade	Watson & chalin mfg. inc.	Gabriel	Upgrade	Watson & chalin mfg. inc.	Gabriel	Upgrade
10634	G63357		11724	83123	89405	17218	85029		665727	85005	89430
11604	83125		12128	85005	89430	17474	85009				

Western Star

Western star	Gabriel	Upgrade	Western star	Gabriel	Upgrade	Western star	Gabriel	Upgrade	Western star	Gabriel	Upgrade
10-13684-000	85918	89449	35066-4413	83122	89406	481700006848	85724	89443	60657003	85072	
1011839	83216		350664413	83122	89406	481700125969	85956		60657003L	85072	
1013684000	85918	89449	35901-0001	83209	89414	57905-1	85976		60680-004	83143	
16-15770-000	85956		35901-3413	85006		57905-2	85006		60680-004L	83143	
16-15817-000	85724	89443	359010001	83209	89414	579051	85976		60680-005	83142	
16-18706-000	85331		359013413	85006		579052	85006		60680-005L	83142	
16-18708-000	85724	89443	471700000470	85918	89449	58913-003	85932	89453	60680004	83143	
1615770000	85956		471700002809	85724	89443	58913-003L	85932	89453	60680004L	83143	
1615817000	85724	89443	471700006269	85932	89453	58913-012	85932	89453	60680005	83142	
1618706000	85331		471700131331	85932	89453	58913-012L	85932	89453	60680005L	83142	
1618708000	85724	89443	47902-13	83122	89406	58913003	85932	89453	680611	85724	89443
16725-01	83126	89430	47902-24	83137		58913003L	85932	89453	90044025	83209	89414
1672501	83126	89430	47902-8	83122	89406	58913012	85932	89453	SDA471700002809	85724	89443
19495-01	83126	89430	4790213	83122	89406	58913012L	85932	89453	SDA481700125969	85956	
1949501	83126	89430	4790224	83137		60657-003	85072				
28R010	83216		479028	83122	89406	60657-003L	85072				

Wheeled Coach Ind.

Wheeled coach ind.	Gabriel	Upgrade	Wheeled coach ind.	Gabriel	Upgrade	Wheeled coach ind.	Gabriel	Upgrade	Wheeled coach ind.	Gabriel	Upgrade
ASH-1136	G63623		ASH-1154	G63622		ASH1136	G63623		ASH1154	G63622	

Winnebago

Winnebago	Gabriel	Upgrade	Winnebago	Gabriel	Upgrade	Winnebago	Gabriel	Upgrade	Winnebago	Gabriel	Upgrade
141700131809	85029		8C2418045DA	G63622		ASH-1229	83209	89414	ASH25824	83122	89406
141700131810	83160		8C2418080DB	G63623		ASH-1230	83122	89406	ASH294	83209	89414
16-16736-000	85029		8C2Z-18124-D	G63622		ASH-137	83122	89406	AT-163G	G63622	
16-16737-000	83160		8C2Z-18125-D	G63623		ASH-25820	85005	89430	AT-164G	G63623	
16-16873-000	85029		8C2Z18124D	G63622		ASH-25821	85006		AT-620	83209	89414
16-16874-000	83160		8C2Z18125D	G63623		ASH-25822	83209	89414	AT-621	83122	89406
16-18103-000	85900		9U94-18045-AA	83209	89414	ASH-25823	83209	89414	AT-766	83209	89414
1616736000	85029		9U94-18080-AA	83122	89406	ASH-25824	83122	89406	AT163G	G63622	
1616737000	83160		9U9418045AA	83209	89414	ASH-294	83209	89414	AT164G	G63623	
1616873000	85029		9U9418080AA	83122	89406	ASH1022	83209	89414	AT620	83209	89414
1616874000	83160		9U9Z-18124-A	83209	89414	ASH1023	83122	89406	AT621	83122	89406
1618103000	85900		9U9Z-18125-A	83122	89406	ASH1136	G63623		AT766	83209	89414
1C34-18045-AA	83209	89414	9U9Z-18125-B	83122	89406	ASH1154	G63622		F4-BE5-A832-MO	85125	
1C34-18045-JA	83209	89414	9U9Z18124A	83209	89414	ASH1161	85006		F4-BE5-B492-HO	85125	
1C3418045AA	83209	89414	9U9Z18125A	83122	89406	ASH1162	85005	89430	F4-BE5-F324-HO	85125	
1C3418045JA	83209	89414	9U9Z18125B	83122	89406	ASH1205	83209	89414	F4-BE5-F325-HO	85124	
24-153249	85125		ASH-1022	83209	89414	ASH1206	83122	89406	F4BE5A832MO	85125	
24-153256	85124		ASH-1023	83122	89406	ASH1228	83209	89414	F4BE5B492HO	85125	
24-186629	85125		ASH-1136	G63623		ASH1229	83209	89414	F4BE5F324HO	85125	
24153249	85125		ASH-1154	G63622		ASH1230	83122	89406	F4BE5F325HO	85124	
24153256	85124		ASH-1161	85006		ASH137	83122	89406	HU9Z-18125-B	83122	89406
24186629	85125		ASH-1162	85005	89430	ASH25820	85005	89430	HU9Z18125B	83122	89406
481700000493	85900		ASH-1205	83209	89414	ASH25821	85006		W0005662	85125	
8C24-18045-DA	G63622		ASH-1206	83122	89406	ASH25822	83209	89414	W0005663	85124	
8C24-18080-DB	G63623		ASH-1228	83209	89414	ASH25823	83209	89414	W0006254	85125	

Workhorse

Workhorse	Gabriel	Upgrade	Workhorse	Gabriel	Upgrade	Workhorse	Gabriel	Upgrade	Workhorse	Gabriel	Upgrade
24-153249	85125		24186629	85125		7805-X-1012	85919		F4-BE5-F324-HO	85125	
24-153256	85124		659223	G63866		7805X1012	85919				
24-186629	85125		66153-002	83124	89407	F4-BE5-A832-MO	85125				
24153249	85125		66153002	83124	89407	F4-BE5-B492-HO	85125				
24153256	85124		680672	85919		F4-BE5-C832-MO	83124	89407			

Important Note: Competitive Interchanges are to be used for stocking purposes only. Where multiple crosses are identified, please reference the applications section of this catalog. / **Remarque importante:** Les interchanges concurrentiels ne s'utilisent qu'aux fins de stocks. Dans le cas de références multiples, consulter la section des applications du catalogue. / **Nota importante:** Dans le cas de referencias multiples, consultar la sección de aplicaciones del catálogo. / **Nota importante:** Se pueden usar intercambios competitivos para propósitos de almacenamiento solamente. Cuando se identifican intercambios múltiples, consulte la sección de aplicaciones de este catálogo.

COMPETITIVE & O.E.M. INTERCHANGE LIST
Lista de Intercambios contra Competidores y Equipo Original.
Liste d'interchange de produits compétitifs & d'équipement original (OEM)

Workhorse... cont'd

Workhorse	Gabriel	Upgrade	Workhorse	Gabriel	Upgrade	Workhorse	Gabriel	Upgrade	Workhorse	Gabriel	Upgrade
F4-BE5-F325-HO	85124		F4BE5C832MO	83124	89407	W0005662	85125		W0007365	G63866	
F4BE5A832MO	85125		F4BE5F324HO	85125		W0005663	85124		W0011635	83221	
F4BE5B492HO	85125		F4BE5F325HO	85124		W0006254	85125		W0011636	G63366	

World Trans Bus Co.

World trans bus co.	Gabriel	Upgrade	World trans bus co.	Gabriel	Upgrade	World trans bus co.	Gabriel	Upgrade	World trans bus co.	Gabriel	Upgrade
ASH-1136	G63623		ASH-1154	G63622		ASH1136	G63623		ASH1154	G63622	

XOS Truck Company

Xos truck company	Gabriel	Upgrade	Xos truck company	Gabriel	Upgrade	Xos truck company	Gabriel	Upgrade	Xos truck company	Gabriel	Upgrade
58913-009	85959		58913009	85959		60665-025	85036	89405	60665025	85036	89405
58913-009L	85959		58913009L	85959		60665-025L	85036	89405	60665025L	85036	89405

Important Note: Competitive Interchanges are to be used for stocking purposes only. Where multiple crosses are identified, please reference the applications section of this catalog. / **Remarque importante:** Les interchanges concurrentiels ne s'utilisent qu'aux fins de stocks. Dans le cas de références multiples, consulter la section des applications du catalogue. / **Nota importante:** Dans le cas de références multiples, consulter la section des applications du catalogue. / **Nota importante:** Se pueden usar intercambios competitivos para propósitos de almacenamiento solamente. Cuando se identifican intercambios múltiples, consulte la sección de aplicaciones de este catálogo.

EXPLANATION OF SPECIFICATIONS

Part Number:	The catalog number for the individual shock absorber.
Extended Length*:	The length of the shock absorber when it is fully extended. See "How to Measure" instructions.
Collapsed Length*:	The length of the shock absorber when it is fully collapsed. See "How to Measure" instructions.
Stroke:	This is the approximate length of the stroke of the individual shock absorber being described.
Mounting Codes:	Indicates the type of mounting ends for the upper and lower end of each shock absorber. They are listed as follows: Top mounts ("TM") Eye ring and bushing with sleeve mounts ("ES") Stud type mounts ("S" & "DS") Eye ring and bushing with bar pin mounts ("BP") Special mounting codes ("SP") Eye ring and bushing mounts ("EB") Clevis mounts ("CL") Pinch socket mounts ("LP") U joint mounts ("LU")

CONVERSION CHART

Fraction (Inches)	Decimal (Inches)	Metric (MM)	Fraction (Inches)	Decimal (Inches)	Metric (MM)
1/64	0.016	0.397	33/64	0.516	13.097
1/32	0.031	0.794	17/32	0.531	13.494
3/64	0.047	1.191	35/64	0.547	13.891
1/16	0.063	1.588	9/16	0.563	14.288
5/64	0.078	1.984	37/64	0.578	14.684
3/32	0.094	2.381	19/32	0.594	15.081
7/64	0.109	2.778	39/64	0.609	15.478
1/8	0.125	3.175	5/8	0.625	15.875
9/64	0.141	3.572	41/64	0.641	16.272
5/32	0.156	3.969	21/32	0.656	16.669
11/64	0.172	4.366	43/64	0.672	17.066
3/16	0.188	4.763	11/16	0.688	17.463
13/64	0.203	5.159	45/64	0.703	17.859
7/32	0.219	5.556	23/32	0.719	18.256
15/64	0.234	5.953	47/64	0.734	18.653
1/4	0.250	6.350	3/4	0.750	19.050
17/64	0.266	6.747	49/64	0.766	19.447
9/32	0.281	7.144	25/32	0.781	19.844
19/64	0.297	7.541	51/64	0.797	20.241
5/16	0.313	7.938	13/16	0.813	20.638
21/64	0.328	8.334	53/64	0.828	21.034
11/32	0.344	8.731	27/32	0.844	21.431
23/64	0.359	9.128	55/64	0.859	21.828
3/8	0.375	9.525	7/8	0.875	22.225
25/64	0.391	9.922	57/64	0.891	22.622
13/32	0.406	10.319	29/32	0.906	23.019
27/64	0.422	10.716	59/64	0.922	23.416
7/16	0.438	11.113	15/16	0.938	23.813
29/64	0.453	11.509	61/64	0.953	24.209
15/32	0.469	11.906	31/32	0.969	24.606
31/64	0.484	12.303	63/64	0.984	25.003
1/2	0.500	12.700	1	1.000	25.400

METRIC CONVERSION CHART

MILLIMETERS	INCHES	MILLIMETERS	INCHES	MILLIMETERS	INCHES
1	0.03937	10	0.39370	19	0.74803
2	0.07874	11	0.43307	20	0.78740
3	0.11811	12	0.47244	21	0.82677
4	0.15748	13	0.51181	22	0.86614
5	0.19685	14	0.55118	23	0.90551
6	0.23622	15	0.59055	24	0.94488
7	0.27559	16	0.62992	25	0.98425
8	0.31496	17	0.66929		
9	0.35433	18	0.70866		

HOW TO MEASURE EXTENDED & COLLAPSED LENGTHS OF SHOCK ABSORBERS

Instructions

1. Using the proper measuring points as shown above find the nearest replacement shock absorber from the listing increments of extended length.
2. Identify the proper mounting form the mounting codes and match these requirements by carefully measuring the mounting dimensions (top and bottom) of the shock absorber to be replaced.
3. Carefully take note of the following requirements:
 - a. **Mounting Accessories** - Contents and descriptions of parts are shown in this manual.
 - b. **Dust tubes** - This requirement should be noted in comparison with the shock absorber to be replaced. Shock absorber environment in its application makes this requirement necessary for piston rod protection and extended shock absorber life.
 - c. **Recoil Cutoff and Compression Bumper** - Carefully note these specifications- deviation of length requirements should not exceed $\pm\frac{1}{2}$ ". These shock absorber designs are footnoted for easy identification.
 - d. **Limited Environment Application** - Most conventional shock absorbers are offered in "straight" construction to fit limited environment applications. These shock absorber designs are footnoted.

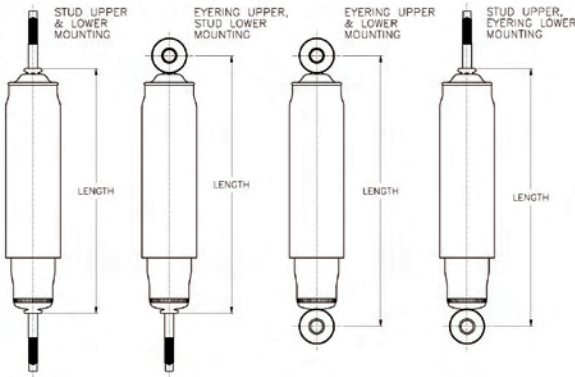

SHOCK ABSORBER DIAMETERS

Shown below are measuring points for diameters by type of shock absorber. Refer to the chart below which lists diameters for the various bore sizes available for each type.

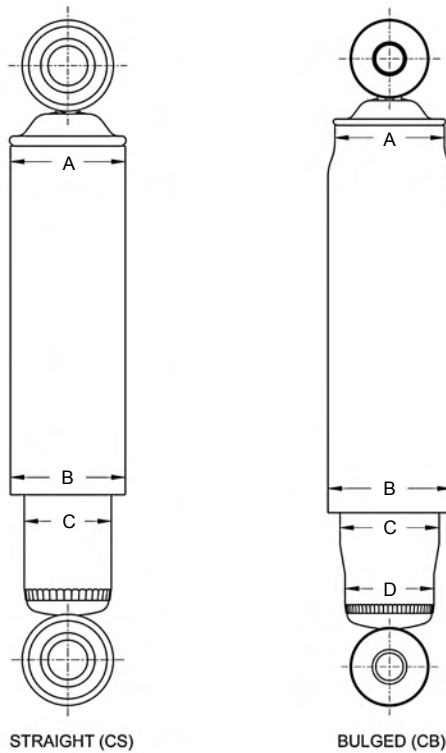

BORE SIZE	SHOCK ABSORBERS	TYPE (Shown Above)	Diameters			
			A	B	C	D
1 3/16"	Classic, Guardian, Ultra Pass. Car	CS	2.06	2.00	1.63	NA
1 3/16"	Classic, Guardian, Ultra Pass. Car	CB	2.06	2.19	1.81	1.63
1 3/8"	Ultra Truck	CS	NA	2.37	2.00	NA
1 3/8"	Ultra Truck	CB	2.37	2.50	2.19	2.00

EXTERNAL DIMENSIONS

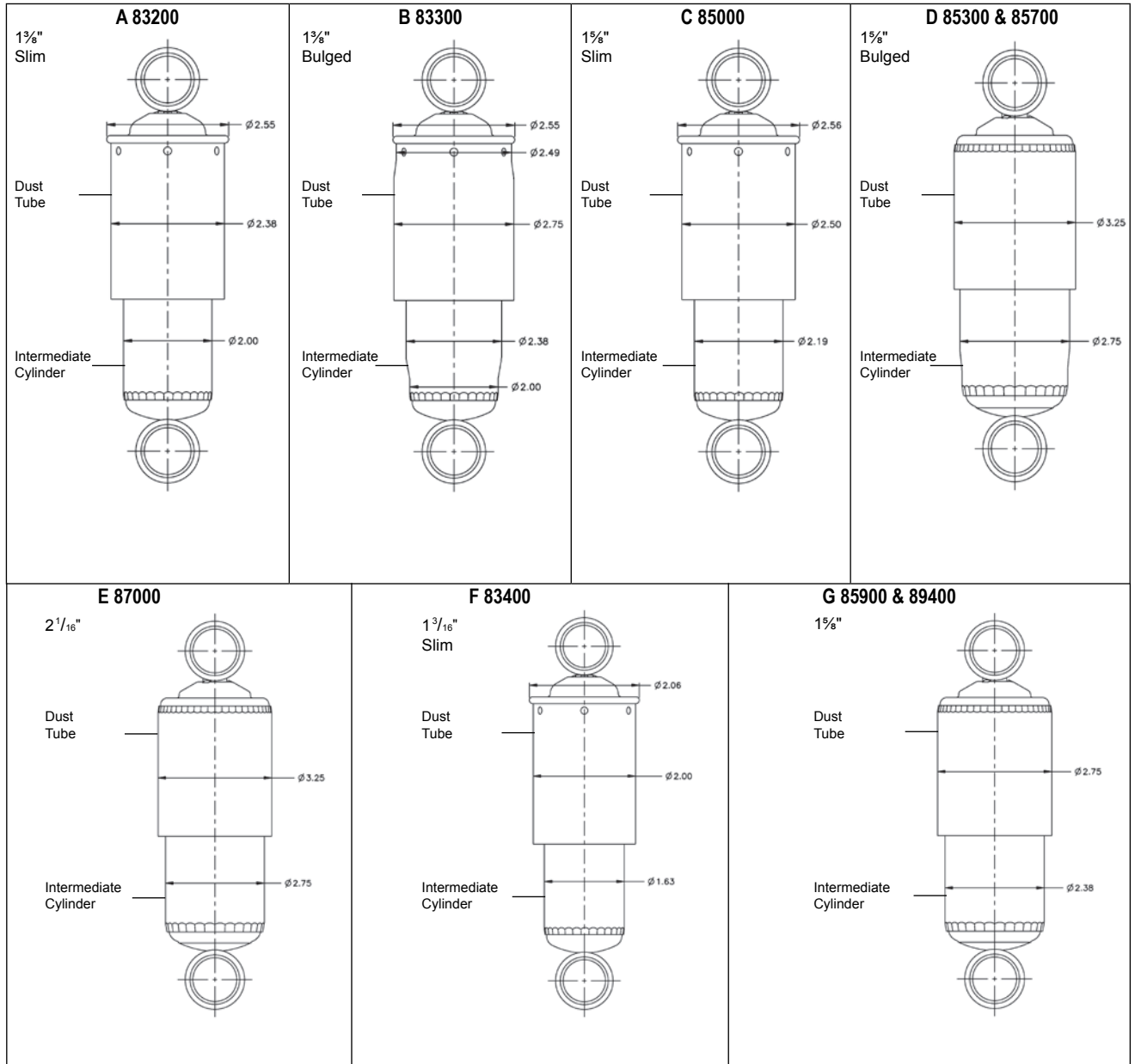

MOUNTING CODE "EB" EYE RING AND BUSHING

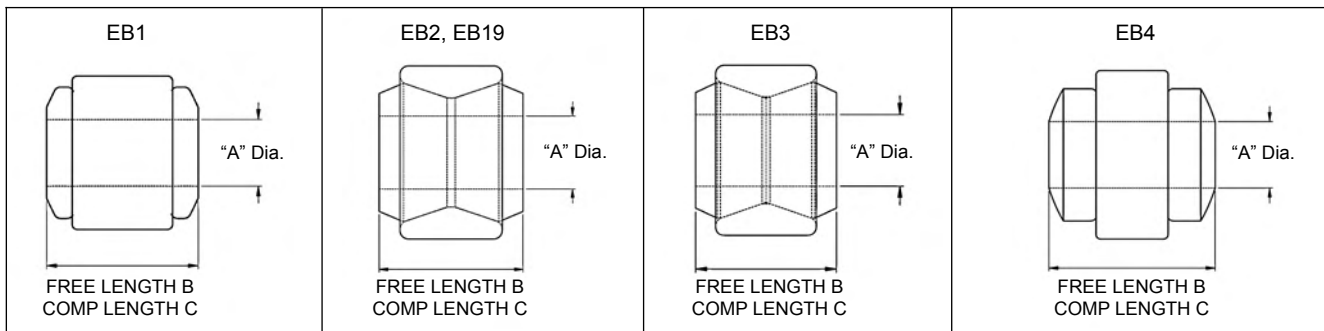

MOUNTING CODE	A DIAMETER	B FREE LENGTH	C COMP. LENGTH	VEHICLE MOUNTING PIN DIAMETER
EB1	5/8	1.44	1.31	5/8
EB2	3/4	1.75	1.50	3/4
EB3	1.00	1.91	1.75	1.00
EB4	11/16	1.72	1.55	11/16
EB18	19MM	1.65	-	19MM
EB19	20MM	1.75	1.25	20MM

"DS" & "S" STUD MOUNTS

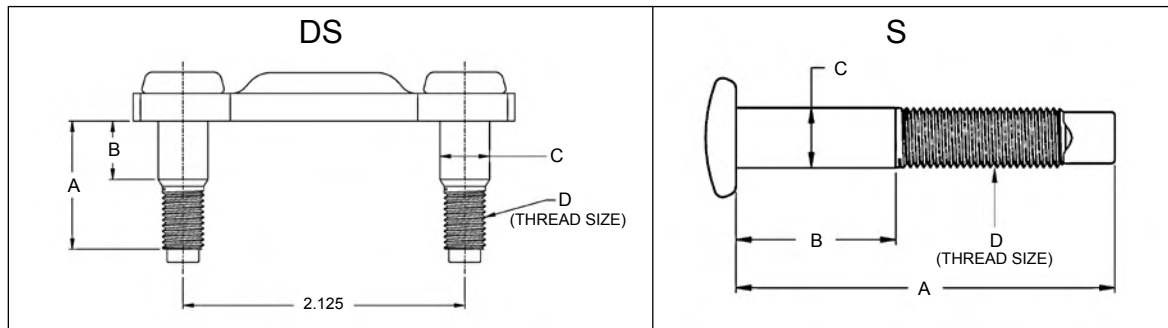

MOUNTING CODE	DIMENSION						
	A		B		C		D
	(inches)	(mm)	(inches)	(mm)	(inches)	(mm)	(thread)
DS1	1.27		.66		0.38		5/16-24
S1	2.37	60.20	1.00	25.40	0.38	9.53	3/8-24
S11	3.00	76.20	1.12	28.45	0.38	9.53	3/8-24
S12	2.37	60.20	1.15	29.21	0.44	11.11	3/8-24
S16	2.95	74.93	1.45	36.83	0.63	16.00	M16x1.5
S21	3.28	83.31	1.75	44.45	0.63	15.88	5/8-18
S29	2.99	75.95	1.87	47.50	0.38	9.53	3/8-24
S36	2.49	63.25	1.33	33.78	0.44	11.11	3/8-24
S38	2.75	69.85	1.70	43.18	0.55	14.00	M12x1.25
S40	2.52	64.01	1.33	33.78	0.44	11.11	3/8-24
S42	3.50	88.90	2.00	50.80	0.63	15.88	5/8-18
S43	2.75	69.85	1.25	31.75	0.63	15.88	5/8-18
S47	2.20	55.88	1.31	33.27	0.39	10.00	M10x1.25
S61	3.11	78.99	1.45	36.83	0.55	14.00	M12x1.25
S62	3.24	82.30	1.70	43.18	0.56	14.29	M12x1.25
S68	2.95	74.93	1.45	36.83	0.63	15.88	M16x1.5
S92	1.42	36.07	0.63	16.00	0.41	10.41	M12x1.25

MOUNTING CODE "BP" EYE RING AND BUSHING WITH BAR PIN

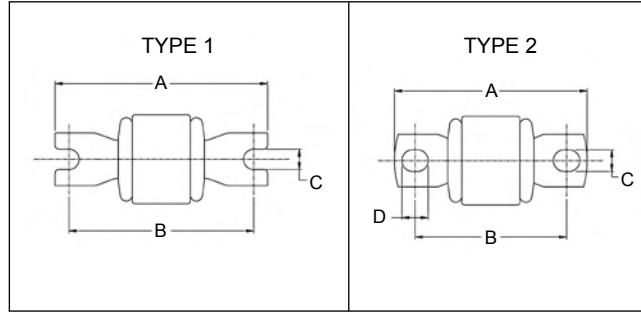

MOUNTING CODE	TYPE	DIMENSION									
		A		B		C		D		E	
		(inches)	(mm)	(inches)	(mm)	(inches)	(mm)	(inches)	(mm)	(inches)	(mm)
BP4	1	3.19	81.03	2.38	60.45	0.33	8.38	--	--	--	--
BP6	1	4.25	107.95	3.62	91.95	0.33	8.38	--	--	--	--
BP7	2	3.13	79.50	2.50	63.50	0.35	8.89	0.42	10.67	--	--
BP8	2	3.50	88.90	2.87	72.90	0.35	8.89	0.42	10.67	--	--
BP9	1	3.38	85.85	2.6	66.04	0.35	8.89	0.42	10.67	--	--
BP11	1	2.96	75.18	2.52	64.01	0.33	8.38	--	--	--	--
BP13	1	3.45	87.63	3.00	76.20	0.33	8.38	--	--	--	--
BP14	2	3.43	87.12	2.87	72.90	0.45	11.43	--	--	--	--
BP27	2	4.00	101.60	2.95	74.93	0.52	13.21	0.50	12.70	--	--
BP38	2	3.22	81.79	1.54	39.12	0.40	10.16	0.40	10.16	--	--

MOUNTING CODE "ES" EYE RING AND BUSHING WITH STEEL SLEEVE

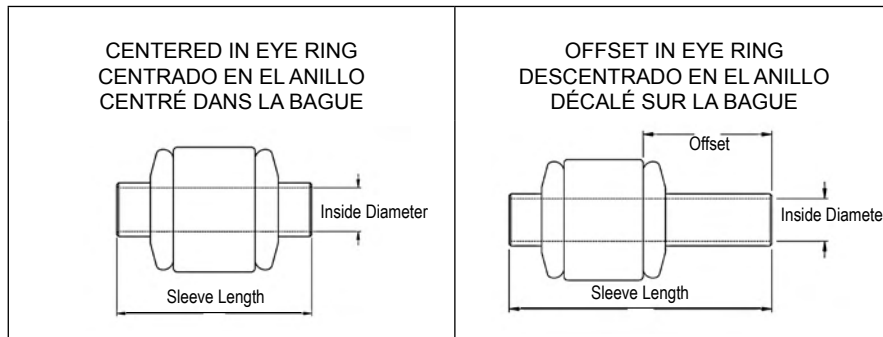

MOUNTING CODE	DIMENSION			
	Inside Diameter		Sleeve Length	
	(inches)	(mm)	(inches)	(mm)
ES3	0.39	10.00	1.56	39.62
ES7	0.56	14.29	1.25	31.75
ES10	0.44	11.11	1.38	35.05
ES13	0.56	14.29	1.89	48.01
ES19	0.47	12.00	1.88	47.75
ES24	0.50	12.70	1.38	35.05
ES25	0.50	12.70	1.50	38.10
ES26	0.50	12.70	1.56	39.62
ES27	0.50	12.70	1.62	41.15
ES31*	0.50	12.70	2.25	57.15
ES34	0.56	14.29	1.66	42.16
ES35	0.63	15.88	1.38	35.05
ES36	0.75	19.05	1.75	44.45
ES38	0.44	11.17	2.18	55.37
ES41	0.47	12.00	3.48	88.39
ES45	0.51	13.00	1.68	42.67
ES48	0.55	13.97	1.42	36.07

MOUNTING CODE	DIMENSION			
	Inside Diameter		Sleeve Length	
	(inches)	(mm)	(inches)	(mm)
ES48	0.55	13.97	1.66	42.16
ES56	0.55	14.00	1.58	40.13
ES60	0.55	14.00	1.26	32.00
ES64	0.63	16.00	1.25	31.75
ES65	0.47	12.00	1.38	35.05
ES77	0.79	20.07	1.48	37.59
ES83	0.47	12.00	1.48	37.59
ES87	0.48	12.30	1.65	41.91
ES90	0.63	15.88	2.00	50.80
ES120	0.75	19.05	2.76	70.10
ES126	0.50	12.70	2.44	61.98
ES128	0.50	12.70	1.66	42.16
ES136	0.63	15.88	1.75	44.45
ES141	0.47	12.00	1.61	40.89
ES149	0.50	12.70	2.36	59.94
ES150	0.75	19.05	2.24	56.90
ES153	0.55	14.00	1.55	39.37

* 1" / 25.4mm Offset

** 1.03" / 26.2 mm Offset

MOUNTING CODE "ES" EYE RING AND BUSHING WITH STEEL SLEEVE (CONTINUED)

MOUNTING CODE	DIMENSION			
	Inside Diameter		Sleeve Length	
	(inches)	(mm)	(inches)	(mm)
ES158	0.75	19.05	3.80	96.52
ES159**	0.75	19.05	3.21	81.53
ES160	1.00	25.40	2.01	51.05
ES161	0.63	16.00	3.95	100.33
ES162	0.63	16.00	2.60	66.04
ES163	0.44	11.11	2.50	63.50
ES164	0.50	12.70	2.26	57.40
ES165	0.50	12.70	1.75	44.45
ES171	0.50	12.70	1.88	47.75
ES172	0.50	12.70	2.72	69.09
ES174	0.63	15.88	3.25	82.55
ES175	0.63	16.00	1.96	49.78
ES176	0.63	16.00	3.72	94.49

MOUNTING CODE	DIMENSION			
	Inside Diameter		Sleeve Length	
	(inches)	(mm)	(inches)	(mm)
ES177	0.63	16.00	3.55	90.17
ES178	0.75	19.05	1.96	49.78
ES179	0.79	20.00	1.75	44.45
ES183	0.79	20.00	3.80	96.52
ES184	0.79	20.00	1.75	44.45
ES185	0.47	12.00	2.44	61.98
ES190	0.87	22.00	1.75	44.45
ES194	0.88	22.23	2.28	57.91
ES204	0.57	14.50	1.68	42.67
ES210	0.73	18.50	1.87	47.50
ES216	0.57	14.50	3.15	80.00

MOUNTING CODE "CL" CLEVIS

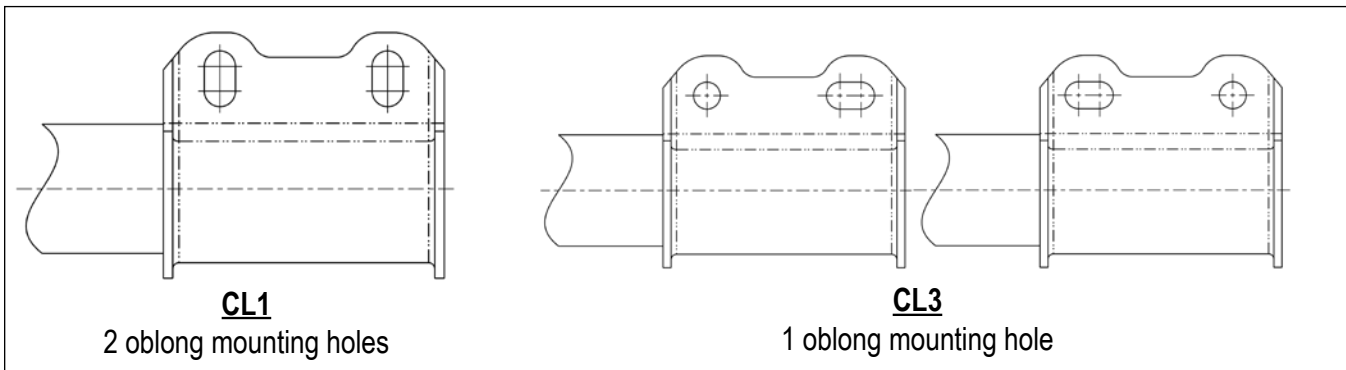

MOUNTING CODE "LP" PINCH SOCKET

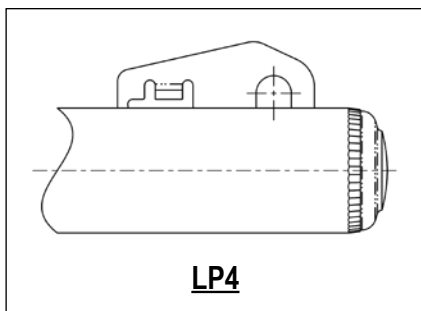

MOUNTING CODE "LU" U JOINT

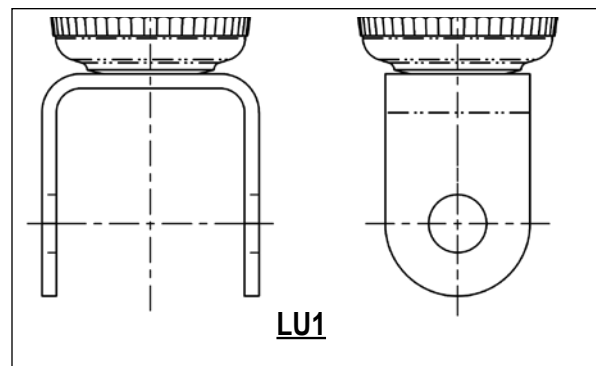

MOUNTING CODE "TM" TOP MOUNT

T M # # #

1st & 2nd digit - "Top Mount"

3rd digit - Part type/shape from the five categories listed below

4th digit - Number of studs / bolts (the amount of mounting points to the vehicle (see example below)

5th digit - Design of the mounting point - Stud (S) Bolt (B) Clip (C) (see example below)

TOP MOUNT DESIGN SHAPES



EXAMPLES

The fourth digit will note how many mounting points to the vehicle body exist.
The final digits indicate the type of mounting point **Stud (S) Bolt (B) Clip(C)**
(a combination is used for multiple mounting points)

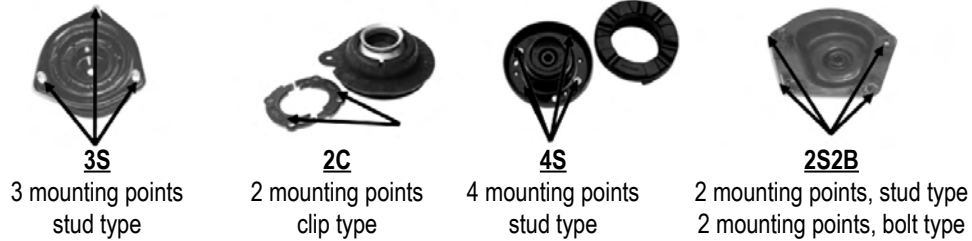

TOP MOUNT CODE	TOP MOUNT DESIGN	MOUNTING TYPE
TMR4S	Rectangle	4 Stud
TMT3S	Triangle	3 Stud
TMU2B	Unique	2 bolt
TMU2B1S	Unique	2 Bolt, 1 Stud

SPECIFICATIONS BY END MOUNT
ESPECIFICACIONES POR TIPO DE MONTAJE
SPÉCIFICATIONS PAR FIXATION DES EXTRÉMITÉS

Gabriel	Mounting		Bore	External Diameter Illustration	Lengths			Dust Tube	Recoil Cutoff	Controls*	
	Upper	Lower			Extended	Collapsed	Stroke			Rebound	Compression
82012	BP6	ES25			16.04	10.53	5.51				
43180	BP8	ES34			23.55	14.19	9.36				
G63837	BP8	ES41	1-3/8"		28.23	17.95	10.28				
81667	BP14	ES34			26.95	16.19	10.76				
77488	BP14	ES34			26.77	16.26	10.51				
61543	BP14	ES34			26.76	16.23	10.53				
58488	BP14	ES34			26.69	16.02	10.63				
G63488	BP14	ES34			26.61	16.33	10.28				
49218	BP14	ES34			26.34	16.36	9.98				
43163	BP14	ES34			25.05	15.69	9.36				
G63638	BP14	ES34			24.33	14.8	9.53				
77638	BP14	ES34			24.31	14.78	9.53				
49231	BP14	ES34			24.27	14.79	9.48				
61565	BP14	ES34			24.26	14.73	9.53				
58638	BP14	ES34			23.87	14.49	9.38				
61687	BP14	ES34			23.87	14.68	9.19				
G63897	BP14	ES34			23.87	14.68	9.19				
77607	BP14	ES83			25.39	15.18	10.21				
77837	BP14	ES83			28.73	16.92	11.81				
G63607	BP14	ES185	1-3/8"		25.58	15.3	10.28				
G63692	EB1	EB1			27.58	16.3	11.28				
6804SE	EB1	EB1			24.08	14.67	9.41				
G63419	EB1	EB1			24.08	14.55	9.53				
14017	EB1	EB1			24.04	14.43	9.61				
6855SE	EB1	EB1			23.83	14.3	9.53				
82060	EB1	EB1			23.23	13.87	9.36				
6854SE	EB1	EB1			23.03	14.27	8.76				
81318	EB1	EB1			22.73	13.87	8.86				
6828SE	EB1	EB1			21.23	12.87	8.36				
43048	EB1	EB1			20.45	12.62	7.83				
49310	EB1	EB1			20.35	12.75	7.60				
61500	EB1	EB1			20.23	12.37	7.86				
81147	EB1	EB1			20.23	12.37	7.86				
82047	EB1	EB1			20.23	12.37	7.86				
G63907	EB1	EB1			20.23	12.37	7.86				
G63405	EB1	EB1			20.01	12.48	7.53				
77907	EB1	EB1			19.87	12.23	7.64				

* Damping force, in pounds, to either extend or collapse the shock absorber at an average operating velocity. Fuerza de amortiguación en libras para extender o comprimir el amortiguador a una velocidad de operación promedio. La puissance d'amortissement en poids de l'amortisseur, soit comprimé, doit détendu, à une vitesse de fonctionnement moyenne.

SPECIFICATIONS BY END MOUNT
ESPECIFICACIONES POR TIPO DE MONTAJE
SPÉCIFICATIONS PAR FIXATION DES EXTRÉMITÉS

Gabriel	Mounting		Bore	External Diameter Illustration	Lengths			Dust Tube	Recoil Cutoff	Controls*	
	Upper	Lower			Extended	Collapsed	Stroke			Rebound	Compression
82007	EB1	EB1			18.23	11.37	6.86				
G63299	EB1	EB1	1-3/8"		18.08	11.55	6.53				
81676	EB1	EB1			17.73	11.12	6.61				
G63625	EB1	ES24			22.56	13.78	8.78				
6853SE	EB1	ES24			19.33	12.05	7.28				
G63394	EB1	ES24			16.01	10.48	5.53				
61525	EB1	ES24			15.01	9.95	5.06				
G63355	EB1	ES24			14.98	9.95	5.03				
81039	EB1	ES24			14.73	9.62	5.11				
34036	EB1	ES24			14.16	9.53	4.63				
82147	EB1	ES25			23.23	13.87	9.36				
81484	EB1	ES25			20.23	12.37	7.86				
G63377	EB1	ES25			20.08	12.55	7.53				
61519	EB1	ES25			19.98	12.45	7.53				
43058	EB1	ES25			19.95	12.37	7.58				
49127	EB1	ES25			19.87	12.63	7.24				
G63349	EB1	ES34			23.33	14.3	9.03				
49155	EB1	ES34			23.27	14.29	8.98				
61524	EB1	ES34			23.26	14.23	9.03				
81164	EB1	ES34			23.23	13.87	9.36				
43111	EB1	ES34			22.9	13.82	9.08				
61682	EB1	ES38			31.36	18.67	12.69				
G63888	EB1	ES38			31.36	18.67	12.69				
77952	EB1	ES38			29.68	17.43	12.25				
77986	EB1	ES48			31.01	18.65	12.36				
77987	EB1	ES48			27.24	16.38	10.86				
G64268	EB1	ES56			31.34	18.70	12.64				
G64269	EB1	ES56			26.93	16.04	10.89				
6847SE	EB1	ES65			23	13.83	9.17				
77810	EB1	ES83			31.53	18.5	13.03				
G63808	EB1	ES83			28.86	17.08	11.78				
77808	EB1	ES83			28.73	16.92	11.81				
61713	EB1	ES83			26.94	16	10.94				
G64010	EB1	ES83			26.94	16	10.94				
G63675	EB1	ES83			26.86	16.08	10.78				
81510	EB1	ES83			25.73	15.12	10.61				
G63461	EB1	ES83			25.51	15.23	10.28				

* Damping force, in pounds, to either extend or collapse the shock absorber at an average operating velocity. Fuerza de amortiguación en libras para extender o comprimir el amortiguador a una velocidad de operación promedio. La puissance d'amortissement en poids de l'amortisseur, soit comprimé, doit détendu, à une vitesse de fonctionnement moyenne.

SPECIFICATIONS BY END MOUNT
ESPECIFICACIONES POR TIPO DE MONTAJE
SPÉCIFICATIONS PAR FIXATION DES EXTRÉMITÉS

Gabriel	Mounting		Bore	External Diameter Illustration	Lengths			Dust Tube	Recoil Cutoff	Controls*	
	Upper	Lower			Extended	Collapsed	Stroke			Rebound	Compression
61530	EB1	ES83			25.48	15.2	10.28				
77461	EB1	ES83			25.39	15.18	10.21				
81082	EB1	ES83			23.23	13.87	9.36				
61547	EB1	ES83			23.01	14.07	8.94				
43167	EB1	ES83			22.99	13.88	9.11				
G63406	EB1	ES83			22.98	13.95	9.03				
G63809	EB1	ES83			22.98	13.95	9.03				
77809	EB1	ES83			22.92	13.9	9.02				
G63673	EB1	ES83			22.3	13.77	8.53				
G63810	EB1	ES185			31.6	18.57	13.03				
58810	EB1	ES185			31.42	18.42	13.00				
G63456	EB1	ES185			26.85	16.07	10.78				
77969	EB1	ES185			25.43	15.81	9.62				
77968	EB1	ES185			24.71	15.09	9.62				
58809	EB1	ES185			23.65	14.53	9.12				
81710	EB1	ES185			21.73	13.12	8.61				
G63409	EB1	ES185			21.48	13.2	8.28				
6850SE	EB1	S1			23.3	13.77	9.53				
85063	EB2	EB2	1-5/8"	C	32.01	18.85	13.16	YES	NO	762	174
83107	EB2	EB2	1-3/8"	A	31.66	18.4	13.25	YES	NO	352	77
83314	EB2	EB2	1-3/8"	B	30.64	18.11	12.53	YES	YES	633	143
83309	EB2	EB2	1-3/8"	B	28.64	17.11	11.53	YES	YES	589	135
89409	EB2	EB2	1-5/8"	G	27.13	16.92	10.2	YES	YES	567‡	165
83312	EB2	EB2	1-3/8"	B	26.64	16.11	10.53	YES	YES	527	152
83308	EB2	EB2	1-3/8"	B	25.14	15.36	9.78	YES	YES	445	180
83519	EB2	EB2	1-3/16"	F	23.83	14.35	9.48	YES	NO	292	132
83216	EB2	EB2	1-3/8"	A	23.51	14.48	9.03	YES	YES	776	262
85054	EB2	EB2	1-5/8"	C	23.26	14.37	8.89	YES	NO	602	104
83159	EB2	EB2	1-3/8"	A	21.85	13.56	8.29	YES	NO	658	149
85012	EB2	EB2	1-5/8"	C	21.02	13.23	7.79	YES	NO	523	199
89413	EB2	EB2	1-5/8"	G	20.94	13.53	7.41	YES	NO	536‡	201
85376	EB3	EB3	1-5/8"	D	33.27	19.73	13.54	YES	NO	668	134
85301	EB3	EB3	1-5/8"	D	31.92	19.03	12.89	YES	NO	1442	455
83215	EB3	EB3	1-3/8"	A	26.64	16.36	10.28	YES	YES	697	108
89425	EB3	EB3	1-5/8"	G	26.5	16.93	9.57	YES	YES	1352‡	167
85314	EB3	EB3	1-5/8"	D	26.49	16.46	10.03	YES	YES	1216	169
89410	EB3	EB3	1-5/8"	G	26.34	16.57	9.77	YES	NO	1185‡	182

* Damping force, in pounds, to either extend or collapse the shock absorber at an average operating velocity. Fuerza de amortiguación en libras para extender o comprimir el amortiguador a una velocidad de operación promedio. La puissance d'amortissement en poids de l'amortisseur, soit comprimé, doit détendu, à une vitesse de fonctionnement moyenne.

SPECIFICATIONS BY END MOUNT
ESPECIFICACIONES POR TIPO DE MONTAJE
SPÉCIFICATIONS PAR FIXATION DES EXTRÉMITÉS

Gabriel	Mounting		Bore	External Diameter Illustration	Lengths			Dust Tube	Recoil Cutoff	Controls*	
	Upper	Lower			Extended	Collapsed	Stroke			Rebound	Compression
85001	EB3	EB3	1-5/8"	C	26.3	16.39	9.92	YES	NO	1202	186
83140	EB3	EB3	1-3/8"	A	25.28	15.53	9.75	YES	NO	738	88
83141	EB3	EB3	1-3/8"	A	25.27	15.52	9.75	YES	NO	408	113
85329	EB3	EB3	1-5/8"	D	24.52	15.48	9.04	YES	YES	1550	232
85007	EB3	EB3	1-5/8"	C	24.33	15.4	8.93	YES	YES	1008	171
83225	EB3	EB3	1-3/8"	A	24.14	15.11	9.03	YES	YES	482	159
85307	EB3	EB3	1-5/8"	D	23.98	15.08	8.89	YES	NO	1094	173
85702	EB3	EB3	1-5/8"	D	23.76	15.85	7.91	YES	YES	1093	825
85736	EB3	EB3	1-5/8"	D	23.61	15.2	8.41	YES	YES	1155	352
89420	EB3	EB3	1-5/8"	G	22.8	14.8	8	YES	NO	862‡	258
85302	EB3	EB3	1-5/8"	D	22.75	14.61	8.14	YES	NO	836	253
85304	EB3	EB3	1-5/8"	D	22.25	14.22	8.03	YES	NO	767	325
85716	EB3	EB3	1-5/8"	D	21.99	14.33	7.66	YES	YES	1220	175
85712	EB3	EB3	1-5/8"	D	20.5	13.47	7.04	YES	YES	1435	562
83214	EB3	EB3	1-3/8"	A	19.64	12.86	6.78	YES	YES	269	90
81825	EB4	EB4			21.1	12.99	8.11				
61632	EB4	EB4			20.79	13.01	7.78				
G63183	EB4	EB4			20.79	13.01	7.78				
82065	EB4	EB4			19.04	11.93	7.11				
43085	EB4	ES27			20.61	12.78	n/a				
83119	EB4	ES165	1-3/8"	A	23.96	14.84	9.12	YES	NO	354	300
G63605	EB19	ES27			24.24	14.71	9.53				
83024	ES10	ES10	1-3/8"	2-1/2" D/T	11.65	8.66	3	YES	YES	811	320
83021	ES10	ES10	1-3/8"	A	9.41	7.4	2.01	YES	YES	745	315
82035	ES24	EB1			14.64	9.53	5.11				
49162	ES24	ES24			20.02	12.79	7.23				
G63306	ES24	ES24			19.85	12.57	7.28				
49107	ES24	ES24			19.27	12.29	6.98				
82003	ES24	ES24			18.55	11.44	7.11				
61517	ES24	ES24			14.98	9.95	5.03				
G63357	ES24	ES24			14.98	9.95	5.03				
58357	ES24	ES24			14.68	10.06	4.62				
G63403	ES26	ES26			24.58	14.8	9.78				
58403	ES26	ES26			24.48	14.95	9.53				
77403	ES26	ES26			24.31	14.78	9.53				
G63671	ES26	ES26			22.48	13.7	8.78				
81342	ES27	EB4			28.89	16.78	12.11				

* Damping force, in pounds, to either extend or collapse the shock absorber at an average operating velocity. Fuerza de amortiguación en libras para extender o comprimir el amortiguador a una velocidad de operación promedio. La puissance d'amortissement en poids de l'amortisseur, soit comprimé, doit détendu, à une vitesse de fonctionnement moyenne.

SPECIFICATIONS BY END MOUNT
ESPECIFICACIONES POR TIPO DE MONTAJE
SPÉCIFICATIONS PAR FIXATION DES EXTRÉMITÉS

Gabriel	Mounting		Bore	External Diameter Illustration	Lengths			Dust Tube	Recoil Cutoff	Controls*	
	Upper	Lower			Extended	Collapsed	Stroke			Rebound	Compression
81091	ES27	EB4			25.14	15.28	9.86				
49149	ES27	EB4			24.93	15.64	9.29				
G63353	ES27	EB4			24.74	14.96	9.78				
49212	ES27	ES27			21.02	13.29	7.73				
G63413	ES27	ES27			20.76	12.98	7.78				
61522	ES27	ES27			20.49	12.63	7.86				
81496	ES27	ES27			20.49	12.63	7.86				
61516	ES31	ES24			18.23	11.37	6.86				
81113	ES31	ES24			18.23	11.37	6.86				
G63411	ES31	ES26			18.58	11.8	6.78				
G63347	ES31	ES35			18.08	11.55	6.53				
61710	ES34	ES34			27.58	17.14	10.44				
G63971	ES34	ES34			27.58	17.14	10.44				
77950	ES34	ES34			27.5	17.5	10.00				
77412	ES34	ES34			26.77	16.26	10.51				
61642	ES34	ES34			26.76	15.98	10.78				
81921	ES34	ES34			26.76	15.67	11.09				
58412	ES34	ES34			26.68	16.18	10.50				
G64013	ES34	ES34			26.52	16.33	10.19				
61716	ES34	ES34			26.5	16.33	10.17				
77675	ES34	ES34			26.25	15.74	10.51				
G64121	ES34	ES34			25.35	16.17	9.18				
77976	ES34	ES34			24.84	16.07	8.76				
49235	ES34	ES34			24.77	15.04	9.73				
81873	ES34	ES34			24.74	14.88	9.86				
58662	ES34	ES34			24.68	15.36	9.32				
G63662	ES34	ES34			24.58	15.05	9.53				
61600	ES34	ES34			24.51	14.98	9.53				
77662	ES34	ES34			24.31	14.78	9.53				
43181	ES34	ES34			24.24	14.88	9.36				
G63366	ES34	ES34			23.26	14.23	9.03				
G63866	ES34	ES34	1-3/8"		22.81	14.12	8.69				
G63918	ES34	ES141			21.25	13.56	7.69				
82086	ES35	ES35			25.54	14.93	10.61				
83137	ES36	ES36	1-3/8"	A	30.04	17.79	12.25	YES	YES	517	132
85976	ES36	ES36	1-5/8"	G	29.92	18.12	11.8	YES	YES	582	138
85013	ES36	ES36	1-5/8"	C	29.79	17.76	12.04	YES	YES	1019	219

* Damping force, in pounds, to either extend or collapse the shock absorber at an average operating velocity. Fuerza de amortiguación en libras para extender o comprimir el amortiguador a una velocidad de operación promedio. La puissance d'amortissement en poids de l'amortisseur, soit comprimé, soit détendu, à une vitesse de fonctionnement moyenne.

SPECIFICATIONS BY END MOUNT
ESPECIFICACIONES POR TIPO DE MONTAJE
SPÉCIFICATIONS PAR FIXATION DES EXTRÉMITÉS

Gabriel	Mounting		Bore	External Diameter Illustration	Lengths			Dust Tube	Recoil Cutoff	Controls*	
	Upper	Lower			Extended	Collapsed	Stroke			Rebound	Compression
89414	ES36	ES36	1-5/8"	G	29.65	18.18	11.46	YES	YES	1045‡	217
83209	ES36	ES36	1-3/8"	A	29.64	17.61	12.03	YES	YES	670	78
85006	ES36	ES36	1-5/8"	C	28.54	17.13	11.41	YES	YES	1019	219
83125	ES36	ES36	1-3/8"	A	28.15	17.16	10.99	YES	YES	625	115
85043	ES36	ES36	1-5/8"	C	27.63	16.85	10.78	YES	YES	628	163
85010	ES36	ES36	1-5/8"	C	26.8	16.26	10.54	YES	YES	1019	219
83123	ES36	ES36	1-3/8"	A	26.65	16.41	10.24	YES	YES	589	119
85036	ES36	ES36	1-5/8"	C	26.38	16.29	10.09	YES	YES	633	119
89405	ES36	ES36	1-5/8"	G	26.3	16.57	9.73	YES	YES	1009‡	249
83122	ES36	ES36	1-3/8"	A	25.28	15.79	9.49	YES	YES	661	201
85005	ES36	ES36	1-5/8"	C	24.76	15.24	9.52	YES	YES	1019	219
89406	ES36	ES36	1-5/8"	G	24.76	15.82	8.93	YES	YES	658‡	125
89430	ES36	ES36	1-5/8"	G	24.61	15.66	8.94	YES	YES	1462‡	279
83126	ES36	ES36	1-3/8"	A	24.41	15.27	9.14	YES	YES	625	115
85909	ES36	ES36	1-5/8"	G	24.25	15.19	9.06	YES	YES	700	255
85030	ES36	ES36	1-5/8"	C	24.05	14.89	9.16	YES	YES	1019	219
83221	ES36	ES36	1-3/8"	A	24.01	14.73	9.28	YES	YES	599	153
89440	ES36	ES36	1-5/8"	G	23.9	15.31	8.59	YES	YES	1498‡	561
83144	ES36	ES36	1-3/8"	A	23.78	15.03	8.74	YES	YES	596	93
85058	ES36	ES36	1-5/8"	C	22.67	14.26	8.41	YES	YES	722	114
85919	ES36	ES36	1-5/8"	G	22.52	14.33	8.19	YES	YES	1265	121
89431	ES36	ES36	1-5/8"	G	22.41	14.16	8.25	YES	NO	751‡	211
85014	ES36	ES36	1-5/8"	C	21.76	13.74	8.02	YES	YES	1019	219
83124	ES36	ES36	1-3/8"	A	21.65	13.77	7.88	YES	YES	750	137
89407	ES36	ES36	1-5/8"	G	21.61	14.17	7.45	YES	YES	652‡	218
85910	ES36	ES36	1-5/8"	G	20.79	13.54	7.25	YES	YES	1074	219
85029	ES36	ES36	1-5/8"	C	20.54	13.11	7.43	YES	YES	1019	219
83127	ES36	ES36	1-3/8"	A	20.16	13.14	7.01	YES	YES	940	218
85000	ES36	ES36	1-5/8"	C	17.28	11.5	5.78	YES	YES	1019	219
89436	ES36	ES36	1-5/8"	G	17.24	12.04	5.2	YES	YES	998‡	217
83157	ES36	ES90	1-3/8"	A	26.38	15.76	10.61	YES	NO	446	303
83164	ES36	ES165	1-3/8"	C	24.22	14.59	9.63	YES	NO	426	274
85072	ES36	ES176	1-5/8"	C	24.17	14.81	9.36	YES	YES	1387	305
58808	ES41	ES41			28.38	16.75	11.63				
61614	ES41	ES41			22.98	13.95	9.03				
G64044	ES49	ES49			25.98	16.22	9.76				
G64089	ES56	ES56			20.43	13.03	7.4				

* Damping force, in pounds, to either extend or collapse the shock absorber at an average operating velocity. Fuerza de amortiguación en libras para extender o comprimir el amortiguador a una velocidad de operación promedio. La puissance d'amortissement en poids de l'amortisseur, soit comprimé, doit détendu, à une vitesse de fonctionnement moyenne.

SPECIFICATIONS BY END MOUNT
ESPECIFICACIONES POR TIPO DE MONTAJE
SPÉCIFICATIONS PAR FIXATION DES EXTRÉMITÉS

Gabriel	Mounting		Bore	External Diameter Illustration	Lengths			Dust Tube	Recoil Cutoff	Controls*	
	Upper	Lower			Extended	Collapsed	Stroke			Rebound	Compression
14072	ES83	EB18			28.22	16.49	11.73				
81821	ES83	ES83			23.23	13.87	9.36				
G63455	ES83	ES83			22.98	13.95	9.03				
77455	ES83	ES83			22.92	13.9	9.02				
83131	ES83	ES83	1-3/8"	A	27.8	18.18	9.62	YES	NO	212	129
85995	ES90	ES36	1-5/8"	G	23.5	14.52	8.98	YES	NO	1830	173
83180	ES90	ES83	1-3/8"		30.2	21.24	8.96	YES	NO	909	204
83364	ES90	ES83	1-3/8"	A	24.06	15.07	8.99	YES	YES	855	206
85082	ES90	ES90	1-5/8"	C	28.6	20.64	7.97	YES	YES	1435	266
85926	ES90	ES90	1-5/8"	G	26.5	17.96	8.54	YES	YES	1387	279
85656	ES90	ES90	1-5/8"	G	26.49	16.94	9.55	YES	YES	1225	274
85927	ES90	ES90	1-5/8"	G	24.76	15.47	9.3	YES	YES	1288	388
83101	ES90	ES90	1-3/8"	A	24.63	15.13	9.49	YES	YES	481	142
85957	ES90	ES90	1-5/8"	G	20.78	13.19	7.6	YES	NO	1583	138
85928	ES90	ES90	1-5/8"	G	20.31	13.24	7.07	YES	NO	957	229
83135	ES90	ES90	1-3/8"	A	19.49	12.38	7.11	YES	NO	519	121
83169	ES90	ES90	1-3/8"	A	18.55	11.91	6.64	YES	NO	599	171
85122	ES120	S21	1-5/8"	C	22.22	13.78	8.44	YES	YES	926	162
83120	ES120	S21	1-3/8"	A	22.17	13.66	8.51	YES	YES	779	164
83154	ES120	S21	1-3/8"	A	20.78	12.72	8.06	YES	YES	599	140
58609	ES126	ES45			16.49	11.05	5.44				
61542	ES126	ES128			16.73	10.95	5.78				
G63609	ES126	ES128			16.5	10.97	5.53				
81726	ES126	ES128			16.48	10.87	5.61				
77609	ES126	ES128			16.43	10.95	5.48				
83160	ES128	ES36	1-3/8"	A	24.31	14.9	9.37	YES	YES	920	161
85650	ES136	ES34	1-5/8"	G	24.88	16.35	8.53	YES	NO	941	463
83056	ES136	ES136	1-5/8"	C	11.53	8.63	2.89	YES	YES	3830	737
83006	ES149	EB1	1-3/8"	A	10.71	8.52†	2.78	YES	YES	525	182
83038	ES149	EB1	1-3/8"	A	10.45†	8.41†	3	YES	YES	336	242
83039	ES149	ES149	1-3/8"	A	10.44†	8.4†	3	YES	YES	876	326
85180	ES150	ES36	1-5/8"	C	20.94	13.83	7.11	YES	YES	681	283
85181	ES150	ES150	1-5/8"	C	26.33	17.06	9.27	YES	YES	681	285
89449	ES150	ES150	1-5/8"	G	23.25	14.9	8.35	YES	NO	1519‡	324
85918	ES150	ES150	1-5/8"	G	22.97	14.58	8.39	YES	NO	1726	412
85958	ES150	ES150	1-5/8"	G	22.89	14.5	8.39	YES	YES	1926	281
89503	ES150	ES150	1-5/8"	G	21.28	13.72	7.56	YES	NO	1033‡	123
85920	ES150	ES150	1-5/8"	G	21.16	13.57	7.59	YES	NO	845	49

* Damping force, in pounds, to either extend or collapse the shock absorber at an average operating velocity. Fuerza de amortiguación en libras para extender o comprimir el amortiguador a una velocidad de operación promedio. La puissance d'amortissement en poids de l'amortisseur, soit comprimé, doit détendu, à une vitesse de fonctionnement moyenne.

SPECIFICATIONS BY END MOUNT
ESPECIFICACIONES POR TIPO DE MONTAJE
SPÉCIFICATIONS PAR FIXATION DES EXTRÉMITÉS

Gabriel	Mounting		Bore	External Diameter Illustration	Lengths			Dust Tube	Recoil Cutoff	Controls*	
	Upper	Lower			Extended	Collapsed	Stroke			Rebound	Compression
85959	ES150	ES150	1-5/8"	G	21.16	13.57	7.59	YES	YES	1021	123
83066	ES153	ES153	1-3/8"	A	11.15†	9.2†	2.78	YES	YES	599	221
85125	ES158	ES159	1-5/8"	C	26.9	16.64	10.26	YES	YES	1479	183
85724	ES158	ES159	1-5/8"	D	22.81	14.51	8.3	YES	YES	1235	454
89443	ES158	ES159	1-5/8"	G	22.19	14.66	7.53	YES	YES	1206‡	466
85331	ES158	ES159	1-5/8"	D	19.62	12.85	6.77	YES	YES	1757	396
85335	ES158	ES159	1-5/8"	D	19.62	12.85	6.77	YES	YES	827	107
85188	ES161	ES162	1-5/8"	C	25.31	15.52	9.79	YES	YES	1074	255
83142	ES162	S42	1-3/8"	A	23.92	14.49	9.43	YES	YES	367	131
83143	ES162	S42	1-3/8"	A	21.92	13.51	8.41	YES	YES	403	137
83025	ES163	ES163	1-3/8"	A	8.02	6.53	1.48	YES	YES	710	230
83118	ES164	ES90	1-3/8"	A	24.45	14.71	9.74	YES	NO	410	311
83040	ES171	ES172	1-3/8"	A	10.44†	8.4†	3	YES	YES	876	326
89459	ES174	EB3	1-5/8"	G	25.63	16.14	9.49	YES	NO	1179‡	314
85070	ES174	EB3	1-5/8"	C	25.59	15.83	9.76	YES	NO	1100	310
85067	ES174	ES136	1-5/8"	C	30.54	18.15	12.39	YES	YES	676	170
89451	ES174	ES136	1-5/8"	G	30.39	18.54	11.86	YES	YES	645‡	172
85989	ES174	ES136	1-5/8"	G	20.78	13.15	7.63	YES	NO	1812	351
89460	ES174	ES136	1-5/8"	G	20.58	13.03	7.55	YES	NO	997‡	384
85084	ES174	ES136	1-5/8"	C	20.59	13.03	7.57	YES	NO	1145	407
85985	ES174	S43	1-5/8"	G	19.04	12.31	6.73	YES	YES	2068	723
85936	ES174	S43	1-5/8"	G	17.27	11.48	5.79	YES	YES	1479	337
89456	ES174	S43	1-5/8"	G	17.04	11.63	5.4	YES	YES	975‡	377
85986	ES175	ES150	1-5/8"	G	21.25	13.66	7.59	YES	YES	1754	221
83243	ES175	ES175	1-3/8"	A	24.41	15.26	9.15	YES	YES	296	170
83398	ES175	ES175	1-3/8"	A	23.23	15.38	7.85	YES	YES	293	168
85670	ES175	ES175	1-5/8"	G	23.19	14.67	8.52	YES	YES	591	176
83163	ES175	ES175	1-3/8"	A	20.75	13.01	7.74	YES	NO	828	98
83175	ES175	ES175	1-3/8"	A	20.48	13.19	7.29	YES	NO	1245	156
83397	ES175	ES175	1-3/8"	A	18.67	11.91	6.76	YES	NO	303	101
85031	ES176	EB2	1-5/8"	C	25.63	15.87	9.76	YES	NO	941	257
85923	ES177	ES161	1-5/8"	G	22.52	14.52	8	YES	YES	1940	221
89458	ES177	ES161	1-5/8"	G	22.48	14.6	7.88	YES	YES	1575‡	222
85932	ES178	ES150	1-5/8"	G	21.26	13.7	7.56	YES	YES	1102	430
89453	ES178	ES150	1-5/8"	G	21.14	13.93	7.21	YES	YES	860‡	435
85962	ES178	ES176	1-5/8"	G	21.8	13.66	8.15	YES	YES	2206	240
83148	ES179	ES179	1-3/8"	A	30	17.83	12.17	YES	YES	604	149

* Damping force, in pounds, to either extend or collapse the shock absorber at an average operating velocity. Fuerza de amortiguación en libras para extender o comprimir el amortiguador a una velocidad de operación promedio. La puissance d'amortissement en poids de l'amortisseur, soit comprimé, doit détendu, à une vitesse de fonctionnement moyenne.

SPECIFICATIONS BY END MOUNT
ESPECIFICACIONES POR TIPO DE MONTAJE
SPÉCIFICATIONS PAR FIXATION DES EXTRÉMITÉS

Gabriel	Mounting		Bore	External Diameter Illustration	Lengths			Dust Tube	Recoil Cutoff	Controls*	
	Upper	Lower			Extended	Collapsed	Stroke			Rebound	Compression
85978	ES179	ES179	1-5/8"	G	29.84	18.16	11.69	YES	YES	582	138
83147	ES179	ES179	1-3/8"	A	28.54	17.4	11.15	YES	YES	358	128
83166	ES179	ES179	1-3/8"	A	25.28	15.78	9.49	YES	YES	622	132
83168	ES179	ES179	1-3/8"	A	25.28	15.78	9.49	YES	YES	246	88
85956	ES183	ES184	1-5/8"	G	30.65	18.77	11.88	YES	YES	979	373
61656	ES185	ES185			31.51	18.48	13.03				
61654	ES185	ES185			28.76	16.98	11.78				
61655	ES185	ES185			23.01	14.07	8.94				
61554	ES185	ES185			21.48	13.2	8.28				
83054	ES185	ES185	1-3/8"	A	10.28	7.56	2.72	YES	YES	1004	184
83391	ES190	ES190	1-3/8"	A	25.52	15.61	9.91	YES	NO	590	105
G64164	ES210	ES13			19.95	12.81	7.14				
G64177	ES216	ES19			25.86	16.1	9.76				
G64148	LU1	DS1			18.39	14.09	4.3				
34073	S1	BP7			14.29	9.37	4.92				
61556	S1	BP7			14.2	9.09	5.11				
G63950	S1	BP7			14.2	9.09	5.11				
G63418	S1	BP11			13.95	9.17	4.78				
81834	S1	BP13			15.7	9.84	5.86				
G63360	S1	BP13			15.7	9.92	5.78				
58359	S1	BP13			13.92	9.14	4.78				
61523	S1	BP13			13.7	8.92	4.78				
81096	S1	BP13			13.7	8.84	4.86				
G63359	S1	BP13			13.7	8.92	4.78				
34052	S1	BP13			13.62	9	4.62				
61529	S1	BP4			14.1	9.34	4.76				
6856SE	S1	EB1			27.3	15.77	11.53				
82066	S1	EB1			22.7	13.34	9.36				
43140	S1	EB1			20.92	12.84	8.08				
82155	S1	EB1			20.7	12.34	8.36				
83518	S1	EB2	1-3/16"		24.4	14.26	10.14	YES	NO	153	82
83515	S1	EB2	1-3/16"		23.34	13.89	9.45	YES	NO	643	205
G63432	S1	EB19	1-3/8"		21.11	12.83	8.28				
G63387	S1	ES25			23.32	14.04	9.28				
49178	S1	ES25			23.12	13.89	9.23				
49173	S1	ES25			19.24	12.01	7.23				
81242	S1	ES25			19.2	11.59	7.61				

* Damping force, in pounds, to either extend or collapse the shock absorber at an average operating velocity. Fuerza de amortiguación en libras para extender o comprimir el amortiguador a una velocidad de operación promedio. La puissance d'amortissement en poids de l'amortisseur, soit comprimé, doit détendu, à une vitesse de fonctionnement moyenne.

SPECIFICATIONS BY END MOUNT
ESPECIFICACIONES POR TIPO DE MONTAJE
SPÉCIFICATIONS PAR FIXATION DES EXTRÉMITÉS

Gabriel	Mounting		Bore	External Diameter Illustration	Lengths			Dust Tube	Recoil Cutoff	Controls*	
	Upper	Lower			Extended	Collapsed	Stroke			Rebound	Compression
43099	S1	ES25			19.17	11.77	7.40				
G63350	S1	ES25			18.82	11.79	7.03				
61518	S1	ES25			18.73	11.7	7.03				
61546	S1	ES64			18.45	11.67	6.78				
6803SE	S1	S1			22.52	13.36	9.16				
82034	S1	S1			22.17	12.81	9.36				
6861SE	S1	S1			20.27	11.99	8.28				
6802SE	S1	S1			20.02	12.11	7.91				
81270	S1	S1			17.67	10.56	7.11				
61685	S11	BP9			14.12	9.68	4.44				
G63895	S11	BP9			14.12	9.68	4.44				
61683	S11	LU1			15.07	10.44	4.63				
G63893	S11	LU1			15.07	10.44	4.63				
61555	S12	BP7			14.14	9.11	5.03				
77375	S12	BP7			14.14	9.04	5.10				
G63375	S12	BP7			14.14	9.11	5.03				
81920	S12	BP11			14.71	10.1	4.61				
61641	S12	BP11			14.7	10.17	4.53				
77783	S12	BP11			14.64	10.12	4.52				
G63783	S12	BP11			14.59	10.21	4.38				
G63410	S12	EB1			18.55	11.77	6.78				
34058	S12	ES3			17.13	11.01	n/a				
81925	S12	ES7			14.7	9.59	5.11				
61521	S12	ES25			16.45	10.67	5.78				
77661	S12	ES34			13.72	9.5	4.22				
G63817	S12	ES60			15.8	11.02	4.78				
77817	S12	ES60			15.73	10.94	4.79				
61663	S12	ES60			15.7	10.92	4.78				
58817	S12	ES60			15.59	10.96	4.63				
81490	S12	ES83			14.85	9.84	5.01				
G63715	S12	ES171			28.55	16.52	12.03				
61612	S12	ES171			28.39	16.36	12.03				
81913	S12	ES171			28.39	16.28	12.11				
77715	S12	ES171			28.32	16.33	11.99				
G63778	S12	ES171			24.55	14.52	10.03				
61638	S12	ES171			24.45	14.42	10.03				
81892	S12	ES171			24.2	14.09	10.11				

* Damping force, in pounds, to either extend or collapse the shock absorber at an average operating velocity. Fuerza de amortiguación en libras para extender o comprimir el amortiguador a una velocidad de operación promedio. La puissance d'amortissement en poids de l'amortisseur, soit comprimé, doit détendu, à une vitesse de fonctionnement moyenne.

SPECIFICATIONS BY END MOUNT
ESPECIFICACIONES POR TIPO DE MONTAJE
SPÉCIFICATIONS PAR FIXATION DES EXTRÉMITÉS

Gabriel	Mounting		Bore	External Diameter Illustration	Lengths			Dust Tube	Recoil Cutoff	Controls*	
	Upper	Lower			Extended	Collapsed	Stroke			Rebound	Compression
49237	S12	ES171			24.18	14.45	9.73				
83317	S16	ES90	1-3/8"	B	27.03	16	11.34	YES	YES		
83613	S16	S16	1-3/8"	A	21.04	12.76	8.28	YES	YES	601	242
85033	S21	EB3	1-5/8"	C	27.26	17.4	9.86	YES	YES	764	254
89427	S21	EB3	1-5/8"	G	27.19	17.62	9.57	YES	YES	794‡	253
85311	S21	EB3	1-5/8"	D	23.95	14.79	9.16	YES	YES	764	254
85988	S21	EB3	1-5/8"	G	23.84	14.87	8.97	YES	YES	1200	138
89424	S21	EB3	1-5/8"	G	23.73	15.14	8.59	YES	YES	794‡	253
83395	S21	ES178	1-3/8"	A	27.19	16.28	10.91	YES	NO	616	105
89455	S21	S21	1-5/8"	G	26.31	16.03	10.28	YES	YES	791‡	276
89447	S21	S21	1-5/8"	G	23.63	14.69	8.94	YES	YES	702‡	241
83102	S21	S21	1-3/8"	A	22.89	13.54	9.35	YES	YES	513	333
89423	S21	S21	1-5/8"	G	18.67	12.21	6.46	YES	YES	1352‡	573
G63614	S36	EB1	1-3/8"		15.09	10.06	5.03				
G51856	S92	LU1			21.18	15.11	6.07				
G57147	TMT3S	LU1			21.18	15.11	6.07				
85009	S21	ES36	1-5/8"	C	23.56	14.4	9.16	YES	YES	857	144
83134	S21	ES36	1-3/8"	A	22.27	13.51	8.77	YES	NO	430	49
85921	S21	ES36	1-5/8"	G	22.07	13.57	8.5	YES	NO	2053	339
85351	S21	ES36	1-5/8"	D	20.61	12.82	7.79	YES	NO	1887	259
83395	S21	ES178	1-3/8"	A	27.19	16.28	10.91	YES	NO	616	105
83136	S21	S21	1-3/8"	A	29.31	16.8	12.51	YES	NO	914	65
85069	S21	S21	1-5/8"	C	26.31	15.97	10.33	YES	YES	762	255
89455	S21	S21	1-5/8"	G	26.31	16.03	10.28	YES	YES	791‡	276
85071	S21	S21	1-5/8"	C	25.57	15.02	10.55	YES	NO	610	107
83456	S21	S21	1-3/8"	B	24.03	14.25	9.78	YES	YES	566	80
89447	S21	S21	1-5/8"	G	23.63	14.69	8.94	YES	YES	702‡	241
83102	S21	S21	1-3/8"	A	22.89	13.54	9.35	YES	YES	513	333
85124	S21	S21	1-5/8"	C	20.91	12.9	8.01	YES	YES	1086	222
83103	S21	S21	1-3/8"	A	19.66	11.93	7.74	YES	YES	517	301
85902	S21	S21	1-5/8"	G	19.03	12.09	6.93	YES	YES	1441	267
89423	S21	S21	1-5/8"	G	18.67	12.21	6.46	YES	YES	1352‡	573
85310	S21	S21	1-5/8"	D	18.63	11.71	6.92	YES	YES	1379	578
85900	S21	S21	1-5/8"	G	17.33	11.23	6.11	YES	YES	1467	337
81713	S29	BP7			14.42	9.31	5.11				
58489	S29	BP11			14.64	9.61	5.03				
61544	S29	BP11			14.54	9.75	4.79				

* Damping force, in pounds, to either extend or collapse the shock absorber at an average operating velocity. Fuerza de amortiguación en libras para extender o comprimir el amortiguador a una velocidad de operación promedio. La puissance d'amortissement en poids de l'amortisseur, soit comprimé, doit détendu, à une vitesse de fonctionnement moyenne.

**SPECIFICATIONS BY END MOUNT
ESPECIFICACIONES POR TIPO DE MONTAJE
SPÉCIFICATIONS PAR FIXATION DES EXTRÉMITÉS**

Gabriel	Mounting		Bore	External Diameter Illustration	Lengths			Dust Tube	Recoil Cutoff	Controls*	
	Upper	Lower			Extended	Collapsed	Stroke			Rebound	Compression
G63489	S29	BP11			14.42	9.64	4.78				
77489	S29	BP11			14.36	9.55	4.81				
81668	S29	BP11			14.32	9.56	4.76				
77807	S36	EB1			15.33	10.34	4.99				
G63622	S36	EB1			15.32	10.29	5.03				
58807	S36	EB1			15.24	10.11	5.13				
G63614	S36	EB1	1-3/8"		15.09	10.06	5.03				
58622	S36	EB1			15.04	10.16	4.88				
77614	S36	EB1			15.04	10.05	4.99				
34076	S36	EB1			14.59	9.87	n/a				
81744	S36	EB1			14.52	9.76	4.76				
61591	S36	EB1			14.47	9.71	4.76				
81394	S36	ES25			17.47	11.21	6.26				
G63386	S36	ES25			16.11	10.58	5.53				
61520	S36	ES41			15.34	10.31	5.03				
G63414	S36	ES41			15.09	10.06	5.03				
81828	S36	ES83			22.72	14.21	8.51				
G63623	S36	ES83			22.57	14.29	8.28				
58623	S36	ES83			22.54	13.91	8.63				
77414	S36	ES83			15.33	10.34	4.99				
61646	S36	ES185			22.57	14.29	8.28				
77714	S38	BP7			15.34	9.84	5.50				
77949	S38	BP27			16.16	10.67	5.49				
77716	S38	ES26			15.32	9.84	5.48				
77948	S38	ES34			23.5	14.75	8.75				
G63674	S38	ES34			23.39	14.36	9.03				
G64009	S38	ES34			23.29	14.25	9.04				
61635	S38	ES34			23.27	14.24	9.03				
77674	S38	ES34			23.27	14.27	9.00				
77673	S38	ES34			22.38	13.84	8.54				
61634	S38	ES34			22.3	13.77	8.53				
81919	S38	ES34			22.3	13.54	8.76				
61680	S38	ES34			20.83	13.39	7.44				
G63886	S38	ES34			20.8	13.36	7.44				
77951	S38	ES34			20.5	13	7.50				
61599	S38	ES34			13.8	9.52	4.28				

* Damping force, in pounds, to either extend or collapse the shock absorber at an average operating velocity. Fuerza de amortiguación en libras para extender o comprimir el amortiguador a una velocidad de operación promedio. La puissance d'amortissement en poids de l'amortisseur, soit comprimé, doit détendu, à une vitesse de fonctionnement moyenne.

SPECIFICATIONS BY END MOUNT
ESPECIFICACIONES POR TIPO DE MONTAJE
SPÉCIFICATIONS PAR FIXATION DES EXTRÉMITÉS

Gabriel	Mounting		Bore	External Diameter Illustration	Lengths			Dust Tube	Recoil Cutoff	Controls*	
	Upper	Lower			Extended	Collapsed	Stroke			Rebound	Compression
G63661	S38	ES34			13.8	9.52	4.28				
81928	S38	ES34			13.78	9.52	4.26				
77623	S38	ES83			22.38	13.84	8.54				
77980	S38	ES204			23	14.39	8.61				
83114	S40	ES35	1-3/8"	A	23.02	13.78	9.24	YES	NO	450	102
83162	S40	ES190	1-3/8"	A	24.35	14.69	9.67	YES	NO	877	52
85332	S42	ES36	1-5/8"	D	20.64	12.98	7.66	YES	YES	2351	967
85182	S43	S43	1-5/8"	C	26.86	16.04	10.82	YES	NO	708	232
G63610	S47	EB1			21.95	13.17	8.78				
G64043	S61	BP38			14.09	9.68	4.41				
61611	S62	BP7			15.48	9.95	5.53				
81912	S62	BP7			15.48	9.87	5.61				
G63714	S62	BP7			15.39	9.86	5.53				
58714	S62	BP7			15.26	9.98	5.28				
G63716	S62	ES26			16.39	9.86	6.53				
61613	S62	ES26			15.48	9.95	5.53				
81914	S62	ES26			15.48	9.87	5.61				
77967	S62	ES34			20.75	13.13	7.62				
G63969	S62	ES34			20.75	13.31	7.44				
85649	S62	ES34	1-5/8"	G	23.16	16.46	6.7	YES	NO	875	421
61714	S62	ES77			23.36	14.22	9.14				
G64011	S62	ES87			23.36	14.21	9.15				
58944	S62	ES204			20.73	13.35	7.38				
G56778	S68	CL1			21.37	14.37	7				
G51856	S92	LU1			21.18	15.11	6.07				
G57802	TMR4S	CL3			17.20	9.96	7.24				
G57816	TMT3S	LP4			27.17	18.98	8.19				
G57147	TMT3S	LU1			21.18	15.11	6.07				
G57800	TMU2B1S	LP4			26.73	19.49	7.24				
G57801	TMU2B1S	LP4			26.73	19.49	7.24				

* Damping force, in pounds, to either extend or collapse the shock absorber at an average operating velocity. Fuerza de amortiguación en libras para extender o comprimir el amortiguador a una velocidad de operación promedio. La puissance d'amortissement en poids de l'amortisseur, soit comprimé, doit détendu, à une vitesse de fonctionnement moyenne.

**SPECIFICATIONS BY PART NUMBER
ESPECIFICACIONES POR NÚMERO DE PARTE
SPÉCIFICATIONS PAR NUMÉRO DE PIÈCE**

Gabriel	Mounting		Bore	External Diameter Illustration	Lengths			Dust Tube	Recoil Cutoff	Controls*	
	Upper	Lower			Extended	Collapsed	Stroke			Rebound	Compression
14017	EB1	EB1			24.04	14.43	9.61				
14072	ES83	EB18			28.22	16.49	11.73				
34036	EB1	ES24			14.16	9.53	4.63				
34052	S1	BP13			13.62	9	4.62				
34058	S12	ES3			17.13	11.01	n/a				
34073	S1	BP7			14.29	9.37	4.92				
34076	S36	EB1			14.59	9.87	n/a				
43048	EB1	EB1			20.45	12.62	7.83				
43058	EB1	ES25			19.95	12.37	7.58				
43085	EB4	ES27			20.61	12.78	n/a				
43099	S1	ES25			19.17	11.77	7.40				
43111	EB1	ES34			22.9	13.82	9.08				
43140	S1	EB1			20.92	12.84	8.08				
43163	BP14	ES34			25.05	15.69	9.36				
43167	EB1	ES83			22.99	13.88	9.11				
43180	BP8	ES34			23.55	14.19	9.36				
43181	ES34	ES34			24.24	14.88	9.36				
49107	ES24	ES24			19.27	12.29	6.98				
49127	EB1	ES25			19.87	12.63	7.24				
49149	ES27	EB4			24.93	15.64	9.29				
49155	EB1	ES34			23.27	14.29	8.98				
49162	ES24	ES24			20.02	12.79	7.23				
49173	S1	ES25			19.24	12.01	7.23				
49178	S1	ES25			23.12	13.89	9.23				
49212	ES27	ES27			21.02	13.29	7.73				
49218	BP14	ES34			26.34	16.36	9.98				
49231	BP14	ES34			24.27	14.79	9.48				
49235	ES34	ES34			24.77	15.04	9.73				
49237	S12	ES171			24.18	14.45	9.73				
49310	EB1	EB1			20.35	12.75	7.60				
58357	ES24	ES24			14.68	10.06	4.62				
58359	S1	BP13			13.92	9.14	4.78				
58403	ES26	ES26			24.48	14.95	9.53				
58412	ES34	ES34			26.68	16.18	10.50				
58488	BP14	ES34			26.69	16.02	10.63				
58489	S29	BP11			14.64	9.61	5.03				
58609	ES126	ES45			16.49	11.05	5.44				

* Damping force, in pounds, to either extend or collapse the shock absorber at an average operating velocity. Fuerza de amortiguación en libras para extender o comprimir el amortiguador a una velocidad de operación promedio. La puissance d'amortissement en poids de l'amortisseur, soit comprimé, doit détendu, à une vitesse de fonctionnement moyenne.

SPECIFICATIONS BY PART NUMBER
ESPECIFICACIONES POR NÚMERO DE PARTE
SPECIFICATIONS PAR NUMÉRO DE PIÈCE

Gabriel	Mounting		Bore	External Diameter Illustration	Lengths			Dust Tube	Recoil Cutoff	Controls*	
	Upper	Lower			Extended	Collapsed	Stroke			Rebound	Compression
58622	S36	EB1			15.04	10.16	4.88				
58623	S36	ES83			22.54	13.91	8.63				
58638	BP14	ES34			23.87	14.49	9.38				
58662	ES34	ES34			24.68	15.36	9.32				
58714	S62	BP7			15.26	9.98	5.28				
58807	S36	EB1			15.24	10.11	5.13				
58808	EB1	ES83			28.38	16.75	11.63				
58809	EB1	ES83			23.65	14.53	9.12				
58810	EB1	ES83			31.42	18.42	13.00				
58817	S12	ES60			15.59	10.96	4.63				
58944	S62	ES204			20.73	13.35	7.38				
61500	EB1	EB1			20.23	12.37	7.86				
61516	ES31	ES24			18.23	11.37	6.86				
61517	ES24	ES24			14.98	9.95	5.03				
61518	S1	ES25			18.73	11.7	7.03				
61519	EB1	ES25			19.98	12.45	7.53				
61520	S36	ES41			15.34	10.31	5.03				
61521	S12	ES25			16.45	10.67	5.78				
61522	ES27	ES27			20.49	12.63	7.86				
61523	S1	BP13			13.7	8.92	4.78				
61524	EB1	ES34			23.26	14.23	9.03				
61525	EB1	ES24			15.01	9.95	5.06				
61529	S1	BP4			14.1	9.34	4.76				
61530	EB1	ES83			25.48	15.2	10.28				
61542	ES126	ES128			16.73	10.95	5.78				
61543	BP14	ES34			26.76	16.23	10.53				
61544	S29	BP11			14.54	9.75	4.79				
61546	S1	ES64			18.45	11.67	6.78				
61547	EB1	ES83			23.01	14.07	8.94				
61554	ES185	ES185			21.48	13.2	8.28				
61555	S12	BP7			14.14	9.11	5.03				
61556	S1	BP7			14.2	9.09	5.11				
61565	BP14	ES34			24.26	14.73	9.53				
61591	S36	EB1			14.47	9.71	4.76				
61599	S38	ES34			13.8	9.52	4.28				
61600	ES34	ES34			24.51	14.98	9.53				
61611	S62	BP7			15.48	9.95	5.53				

* Damping force, in pounds, to either extend or collapse the shock absorber at an average operating velocity. Fuerza de amortiguación en libras para extender o comprimir el amortiguador a una velocidad de operación promedio. La puissance d'amortissement en poids de l'amortisseur, soit comprimé, doit détendu, à une vitesse de fonctionnement moyenne.

**SPECIFICATIONS BY PART NUMBER
ESPECIFICACIONES POR NÚMERO DE PARTE
SPÉCIFICATIONS PAR NUMÉRO DE PIÈCE**

Gabriel	Mounting		Bore	External Diameter Illustration	Lengths			Dust Tube	Recoil Cutoff	Controls*	
	Upper	Lower			Extended	Collapsed	Stroke			Rebound	Compression
61612	S12	ES171			28.39	16.36	12.03				
61613	S62	ES26			15.48	9.95	5.53				
61614	ES41	ES41			22.98	13.95	9.03				
61632	EB4	EB4			20.79	13.01	7.78				
61634	S38	ES34			22.3	13.77	8.53				
61635	S38	ES34			23.27	14.24	9.03				
61638	S12	ES171			24.45	14.42	10.03				
61641	S12	BP11			14.7	10.17	4.53				
61642	ES34	ES34			26.76	15.98	10.78				
61646	S36	ES185			22.57	14.29	8.28				
61654	ES185	ES185			28.76	16.98	11.78				
61655	ES185	ES185			23.01	14.07	8.94				
61656	ES185	ES185			31.51	18.48	13.03				
61663	S12	ES60			15.7	10.92	4.78				
61680	S38	ES34			20.83	13.39	7.44				
61682	EB1	ES83			31.36	18.67	12.69				
61683	S11	LU1			15.07	10.44	4.63				
61685	S11	BP9			14.12	9.68	4.44				
61687	BP14	ES34			23.87	14.68	9.19				
61710	ES34	ES34			27.58	17.14	10.44				
61713	EB1	ES83			26.94	16	10.94				
61714	S62	ES77			23.36	14.22	9.14				
61716	ES34	ES34			26.5	16.33	10.17				
6802SE	S1	S1			20.02	12.11	7.91				
6803SE	S1	S1			22.52	13.36	9.16				
6804SE	EB1	EB1			24.08	14.67	9.41				
6828SE	EB1	EB1			21.23	12.87	8.36				
6847SE	EB1	ES65			23	13.83	9.17				
6850SE	EB1	S1			23.3	13.77	9.53				
6853SE	EB1	ES24			19.33	12.05	7.28				
6854SE	EB1	EB1			23.03	14.27	8.76				
6855SE	EB1	EB1			23.83	14.3	9.53				
6856SE	S1	EB1			27.3	15.77	11.53				
6861SE	S1	S1			20.27	11.99	8.28				
77375	S12	BP7			14.14	9.04	5.10				
77403	ES26	ES26			24.31	14.78	9.53				
77412	ES34	ES34			26.77	16.26	10.51				

* Damping force, in pounds, to either extend or collapse the shock absorber at an average operating velocity. Fuerza de amortiguación en libras para extender o comprimir el amortiguador a una velocidad de operación promedio. La puissance d'amortissement en poids de l'amortisseur, soit comprimé, doit détendu, à une vitesse de fonctionnement moyenne.

SPECIFICATIONS BY PART NUMBER
ESPECIFICACIONES POR NÚMERO DE PARTE
SPECIFICATIONS PAR NUMÉRO DE PIÈCE

Gabriel	Mounting		Bore	External Diameter Illustration	Lengths			Dust Tube	Recoil Cutoff	Controls*	
	Upper	Lower			Extended	Collapsed	Stroke			Rebound	Compression
77414	S36	ES83			15.33	10.34	4.99				
77455	ES83	ES83			22.92	13.9	9.02				
77461	EB1	ES83			25.39	15.18	10.21				
77488	BP14	ES34			26.77	16.26	10.51				
77489	S29	BP11			14.36	9.55	4.81				
77607	BP14	ES83			25.39	15.18	10.21				
77609	ES126	ES128			16.43	10.95	5.48				
77614	S36	EB1			15.04	10.05	4.99				
77623	S38	ES83			22.38	13.84	8.54				
77638	BP14	ES34			24.31	14.78	9.53				
77661	S12	ES34			13.72	9.5	4.22				
77662	ES34	ES34			24.31	14.78	9.53				
77673	S38	ES34			22.38	13.84	8.54				
77674	S38	ES34			23.27	14.27	9.00				
77675	ES34	ES34			26.25	15.74	10.51				
77714	S38	BP7			15.34	9.84	5.50				
77715	S12	ES171			28.32	16.33	11.99				
77716	S38	ES26			15.32	9.84	5.48				
77783	S12	BP11			14.64	10.12	4.52				
77807	S36	EB1			15.33	10.34	4.99				
77808	EB1	ES83			28.73	16.92	11.81				
77809	EB1	ES83			22.92	13.9	9.02				
77810	EB1	ES83			31.53	18.5	13.03				
77817	S12	ES60			15.73	10.94	4.79				
77837	BP14	ES83			28.73	16.92	11.81				
77907	EB1	EB1			19.87	12.23	7.64				
77948	S38	ES34			23.5	14.75	8.75				
77949	S38	BP27			16.16	10.67	5.49				
77950	ES34	ES34			27.5	17.5	10.00				
77951	S38	ES34			20.5	13	7.50				
77952	EB1	ES83			29.68	17.43	12.25				
77967	S62	ES34			20.75	13.13	7.62				
77968	EB1	ES185			24.71	15.09	9.62				
77969	EB1	ES185			25.43	15.81	9.62				
77976	ES34	ES34			24.84	16.07	8.76				
77980	S38	ES204			23	14.39	8.61				
77986	EB1	ES48			31.01	18.65	12.36				

* Damping force, in pounds, to either extend or collapse the shock absorber at an average operating velocity. Fuerza de amortiguación en libras para extender o comprimir el amortiguador a una velocidad de operación promedio. La puissance d'amortissement en poids de l'amortisseur, soit comprimé, doit détendu, à une vitesse de fonctionnement moyenne.

SPECIFICATIONS BY PART NUMBER
ESPECIFICACIONES POR NÚMERO DE PARTE
SPÉCIFICATIONS PAR NUMÉRO DE PIÈCE

Gabriel	Mounting		Bore	External Diameter Illustration	Lengths			Dust Tube	Recoil Cutoff	Controls*	
	Upper	Lower			Extended	Collapsed	Stroke			Rebound	Compression
77987	EB1	ES48			27.24	16.38	10.86				
81039	EB1	ES24			14.73	9.62	5.11				
81082	EB1	ES83			23.23	13.87	9.36				
81091	ES27	EB4			25.14	15.28	9.86				
81096	S1	BP13			13.7	8.84	4.86				
81113	ES31	ES24			18.23	11.37	6.86				
81147	EB1	EB1			20.23	12.37	7.86				
81164	EB1	ES34			23.23	13.87	9.36				
81242	S1	ES25			19.2	11.59	7.61				
81270	S1	S1			17.67	10.56	7.11				
81318	EB1	EB1			22.73	13.87	8.86				
81342	ES27	EB4			28.89	16.78	12.11				
81394	S36	ES25			17.47	11.21	6.26				
81484	EB1	ES25			20.23	12.37	7.86				
81490	S12	ES83			14.85	9.84	5.01				
81496	ES27	ES27			20.49	12.63	7.86				
81510	EB1	ES83			25.73	15.12	10.61				
81667	BP14	ES34			26.95	16.19	10.76				
81668	S29	BP11			14.32	9.56	4.76				
81676	EB1	EB1			17.73	11.12	6.61				
81710	EB1	ES185			21.73	13.12	8.61				
81713	S29	BP7			14.42	9.31	5.11				
81726	ES126	ES128			16.48	10.87	5.61				
81744	S36	EB1			14.52	9.76	4.76				
81821	ES83	ES83			23.23	13.87	9.36				
81825	EB4	EB4			21.1	12.99	8.11				
81828	S36	ES83			22.72	14.21	8.51				
81834	S1	BP13			15.7	9.84	5.86				
81873	ES34	ES34			24.74	14.88	9.86				
81892	S12	ES171			24.2	14.09	10.11				
81912	S62	BP7			15.48	9.87	5.61				
81913	S12	ES171			28.39	16.28	12.11				
81914	S62	ES26			15.48	9.87	5.61				
81919	S38	ES34			22.3	13.54	8.76				
81920	S12	BP11			14.71	10.1	4.61				
81921	ES34	ES34			26.76	15.67	11.09				
81925	S12	ES7			14.7	9.59	5.11				

* Damping force, in pounds, to either extend or collapse the shock absorber at an average operating velocity. Fuerza de amortiguación en libras para extender o comprimir el amortiguador a una velocidad de operación promedio. La puissance d'amortissement en poids de l'amortisseur, soit comprimé, doit détendu, à une vitesse de fonctionnement moyenne.

SPECIFICATIONS BY PART NUMBER
ESPECIFICACIONES POR NÚMERO DE PARTE
SPECIFICATIONS PAR NUMÉRO DE PIÈCE

Gabriel	Mounting		Bore	External Diameter Illustration	Lengths			Dust Tube	Recoil Cutoff	Controls*	
	Upper	Lower			Extended	Collapsed	Stroke			Rebound	Compression
81928	S38	ES34			13.78	9.52	4.26				
82003	ES24	ES24			18.55	11.44	7.11				
82007	EB1	EB1			18.23	11.37	6.86				
82012	BP6	ES25			16.04	10.53	5.51				
82034	S1	S1			22.17	12.81	9.36				
82035	ES24	EB1			14.64	9.53	5.11				
82047	EB1	EB1			20.23	12.37	7.86				
82060	EB1	EB1			23.23	13.87	9.36				
82065	EB4	EB4			19.04	11.93	7.11				
82066	S1	EB1			22.7	13.34	9.36				
82086	ES35	ES35			25.54	14.93	10.61				
82147	EB1	ES25			23.23	13.87	9.36				
82155	S1	EB1			20.7	12.34	8.36				
83006	ES149	EB1	1-3/8"	A	10.71	8.52†	2.78	YES	YES	525	182
83021	ES10	ES10	1-3/8"	A	9.41	7.4	2.01	YES	YES	745	315
83024	ES10	ES10	1-3/8"	2-1/2" D/T	11.65	8.66	3	YES	YES	811	320
83025	ES163	ES163	1-3/8"	A	8.02	6.53	1.48	YES	YES	710	230
83038	ES149	EB1	1-3/8"	A	10.45†	8.41†	3	YES	YES	336	242
83039	ES149	ES149	1-3/8"	A	10.44†	8.4†	3	YES	YES	876	326
83040	ES171	ES172	1-3/8"	A	10.44†	8.4†	3	YES	YES	876	326
83054	ES185	ES185	1-3/8"	A	10.28	7.56	2.72	YES	YES	1004	184
83056	ES136	ES136	1-5/8"	C	11.53	8.63	2.89	YES	YES	3830	737
83066	ES153	ES153	1-3/8"	A	11.15†	9.2†	2.78	YES	YES	599	221
83101	ES90	ES90	1-3/8"	A	24.63	15.13	9.49	YES	YES	481	142
83102	S21	S21	1-3/8"	A	22.89	13.54	9.35	YES	YES	513	333
83103	S21	S21	1-3/8"	A	19.66	11.93	7.74	YES	YES	517	301
83107	EB2	EB2	1-3/8"	A	31.66	18.4	13.25	YES	NO	352	77
83114	S40	ES35	1-3/8"	A	23.02	13.78	9.24	YES	NO	450	102
83118	ES164	ES90	1-3/8"	A	24.45	14.71	9.74	YES	NO	410	311
83119	EB4	ES165	1-3/8"	A	23.96	14.84	9.12	YES	NO	354	300
83120	ES120	S21	1-3/8"	A	22.17	13.66	8.51	YES	YES	779	164
83122	ES36	ES36	1-3/8"	A	25.28	15.79	9.49	YES	YES	661	201
83123	ES36	ES36	1-3/8"	A	26.65	16.41	10.24	YES	YES	589	119
83124	ES36	ES36	1-3/8"	A	21.65	13.77	7.88	YES	YES	750	137
83125	ES36	ES36	1-3/8"	A	28.15	17.16	10.99	YES	YES	625	115
83126	ES36	ES36	1-3/8"	A	24.41	15.27	9.14	YES	YES	625	115
83127	ES36	ES36	1-3/8"	A	20.16	13.14	7.01	YES	YES	940	218

* Damping force, in pounds, to either extend or collapse the shock absorber at an average operating velocity. Fuerza de amortiguación en libras para extender o comprimir el amortiguador a una velocidad de operación promedio. La puissance d'amortissement en poids de l'amortisseur, soit comprimé, doit détendu, à une vitesse de fonctionnement moyenne.

**SPECIFICATIONS BY PART NUMBER
ESPECIFICACIONES POR NÚMERO DE PARTE
SPÉCIFICATIONS PAR NUMÉRO DE PIÈCE**

Gabriel	Mounting		Bore	External Diameter Illustration	Lengths			Dust Tube	Recoil Cutoff	Controls*	
	Upper	Lower			Extended	Collapsed	Stroke			Rebound	Compression
83131	ES83	ES83	1-3/8"	A	27.8	18.18	9.62	YES	NO	212	129
83134	S21	ES36	1-3/8"	A	22.27	13.51	8.77	YES	NO	430	49
83135	ES90	ES90	1-3/8"	A	19.49	12.38	7.11	YES	NO	519	121
83136	S21	S21	1-3/8"	A	29.31	16.8	12.51	YES	NO	914	65
83137	ES36	ES36	1-3/8"	A	30.04	17.79	12.25	YES	YES	517	132
83140	EB3	EB3	1-3/8"	A	25.28	15.53	9.75	YES	NO	738	88
83141	EB3	EB3	1-3/8"	A	25.27	15.52	9.75	YES	NO	408	113
83142	ES162	S42	1-3/8"	A	23.92	14.49	9.43	YES	YES	367	131
83143	ES162	S42	1-3/8"	A	21.92	13.51	8.41	YES	YES	403	137
83144	ES36	ES36	1-3/8"	A	23.78	15.03	8.74	YES	YES	596	93
83147	ES179	ES179	1-3/8"	A	28.54	17.4	11.15	YES	YES	358	128
83148	ES179	ES179	1-3/8"	A	30	17.83	12.17	YES	YES	604	149
83154	ES120	S21	1-3/8"	A	20.78	12.72	8.06	YES	YES	599	140
83157	ES36	ES90	1-3/8"	A	26.38	15.76	10.61	YES	NO	446	303
83159	EB2	EB2	1-3/8"	A	21.85	13.56	8.29	YES	NO	658	149
83160	ES128	ES36	1-3/8"	A	24.31	14.9	9.37	YES	YES	920	161
83162	S40	ES190	1-3/8"	A	24.35	14.69	9.67	YES	NO	877	52
83163	ES175	ES175	1-3/8"	A	20.75	13.01	7.74	YES	NO	828	98
83164	ES36	ES165	1-3/8"	C	24.22	14.59	9.63	YES	NO	426	274
83166	ES179	ES179	1-3/8"	A	25.28	15.78	9.49	YES	YES	622	132
83168	ES179	ES179	1-3/8"	A	25.28	15.78	9.49	YES	YES	246	88
83169	ES90	ES90	1-3/8"	A	18.55	11.91	6.64	YES	NO	599	171
83175	ES175	ES175	1-3/8"	A	20.48	13.19	7.29	YES	NO	1245	156
83180	ES90	ES83	1-3/8"		30.2	21.24	8.96	YES	NO	909	204
83209	ES36	ES36	1-3/8"	A	29.64	17.61	12.03	YES	YES	670	78
83214	EB3	EB3	1-3/8"	A	19.64	12.86	6.78	YES	YES	269	90
83215	EB3	EB3	1-3/8"	A	26.64	16.36	10.28	YES	YES	697	108
83216	EB2	EB2	1-3/8"	A	23.51	14.48	9.03	YES	YES	776	262
83221	ES36	ES36	1-3/8"	A	24.01	14.73	9.28	YES	YES	599	153
83225	EB3	EB3	1-3/8"	A	24.14	15.11	9.03	YES	YES	482	159
83243	ES175	ES175	1-3/8"	A	24.41	15.26	9.15	YES	YES	296	170
83308	EB2	EB2	1-3/8"	B	25.14	15.36	9.78	YES	YES	445	180
83309	EB2	EB2	1-3/8"	B	28.64	17.11	11.53	YES	YES	589	135
83312	EB2	EB2	1-3/8"	B	26.64	16.11	10.53	YES	YES	527	152
83314	EB2	EB2	1-3/8"	B	30.64	18.11	12.53	YES	YES	633	143
83317	S16	ES90	1-3/8"	B	27.03	16	11.34	YES	YES		
83364	ES90	ES83	1-3/8"	A	24.06	15.07	8.99	YES	YES	855	206
83391	ES190	ES190	1-3/8"	A	25.52	15.61	9.91	YES	NO	590	105

* Damping force, in pounds, to either extend or collapse the shock absorber at an average operating velocity. Fuerza de amortiguación en libras para extender o comprimir el amortiguador a una velocidad de operación promedio. La puissance d'amortissement en poids de l'amortisseur, soit comprimé, doit détendu, à une vitesse de fonctionnement moyenne.

SPECIFICATIONS BY PART NUMBER
ESPECIFICACIONES POR NÚMERO DE PARTE
SPÉCIFICATIONS PAR NUMÉRO DE PIÈCE

Gabriel	Mounting		Bore	External Diameter Illustration	Lengths			Dust Tube	Recoil Cutoff	Controls*	
	Upper	Lower			Extended	Collapsed	Stroke			Rebound	Compression
83395	S21	ES178	1-3/8"	A	27.19	16.28	10.91	YES	NO	616	105
83397	ES175	ES175	1-3/8"	A	18.67	11.91	6.76	YES	NO	303	101
83398	ES175	ES175	1-3/8"	A	23.23	15.38	7.85	YES	YES	293	168
83456	S21	S21	1-3/8"	B	24.03	14.25	9.78	YES	YES	566	80
83515	S1	EB2	1-3/16"		23.34	13.89	9.45	YES	NO	643	205
83518	S1	EB2	1-3/16"		24.4	14.26	10.14	YES	NO	153	82
83519	EB2	EB2	1-3/16"	F	23.83	14.35	9.48	YES	NO	292	132
83613	S16	S16	1-3/8"	A	21.04	12.76	8.28	YES	YES	601	242
85000	ES36	ES36	1-5/8"	C	17.28	11.5	5.78	YES	YES	1019	219
85001	EB3	EB3	1-5/8"	C	26.3	16.39	9.92	YES	NO	1202	186
85005	ES36	ES36	1-5/8"	C	24.76	15.24	9.52	YES	YES	1019	219
85006	ES36	ES36	1-5/8"	C	28.54	17.13	11.41	YES	YES	1019	219
85007	EB3	EB3	1-5/8"	C	24.33	15.4	8.93	YES	YES	1008	171
85009	S21	ES36	1-5/8"	C	23.56	14.4	9.16	YES	YES	857	144
85010	ES36	ES36	1-5/8"	C	26.8	16.26	10.54	YES	YES	1019	219
85012	EB2	EB2	1-5/8"	C	21.02	13.23	7.79	YES	NO	523	199
85013	ES36	ES36	1-5/8"	C	29.79	17.76	12.04	YES	YES	1019	219
85014	ES36	ES36	1-5/8"	C	21.76	13.74	8.02	YES	YES	1019	219
85029	ES36	ES36	1-5/8"	C	20.54	13.11	7.43	YES	YES	1019	219
85030	ES36	ES36	1-5/8"	C	24.05	14.89	9.16	YES	YES	1019	219
85031	ES176	EB2	1-5/8"	C	25.63	15.87	9.76	YES	NO	941	257
85033	S21	EB3	1-5/8"	C	27.26	17.4	9.86	YES	YES	764	254
85036	ES36	ES36	1-5/8"	C	26.38	16.29	10.09	YES	YES	633	119
85043	ES36	ES36	1-5/8"	C	27.63	16.85	10.78	YES	YES	628	163
85054	EB2	EB2	1-5/8"	C	23.26	14.37	8.89	YES	NO	602	104
85058	ES36	ES36	1-5/8"	C	22.67	14.26	8.41	YES	YES	722	114
85063	EB2	EB2	1-5/8"	C	32.01	18.85	13.16	YES	NO	762	174
85067	ES174	ES136	1-5/8"	C	30.54	18.15	12.39	YES	YES	676	170
85069	S21	S21	1-5/8"	C	26.31	15.97	10.33	YES	YES	762	255
85070	ES174	EB3	1-5/8"	C	25.59	15.83	9.76	YES	NO	1100	310
85071	S21	S21	1-5/8"	C	25.57	15.02	10.55	YES	NO	610	107
85072	ES36	ES176	1-5/8"	C	24.17	14.81	9.36	YES	YES	1387	305
85082	ES90	ES90	1-5/8"	C	28.6	20.64	7.97	YES	YES	1435	266
85084	ES174	ES136	1-5/8"	C	20.59	13.03	7.57	YES	NO	1145	407
85122	ES120	S21	1-5/8"	C	22.22	13.78	8.44	YES	YES	926	162
85124	S21	S21	1-5/8"	C	20.91	12.9	8.01	YES	YES	1086	222
85125	ES158	ES159	1-5/8"	C	26.9	16.64	10.26	YES	YES	1479	183

* Damping force, in pounds, to either extend or collapse the shock absorber at an average operating velocity. Fuerza de amortiguación en libras para extender o comprimir el amortiguador a una velocidad de operación promedio. La puissance d'amortissement en poids de l'amortisseur, soit comprimé, doit détendu, à une vitesse de fonctionnement moyenne.

**SPECIFICATIONS BY PART NUMBER
ESPECIFICACIONES POR NÚMERO DE PARTE
SPÉCIFICATIONS PAR NUMÉRO DE PIÈCE**

Gabriel	Mounting		Bore	External Diameter Illustration	Lengths			Dust Tube	Recoil Cutoff	Controls*	
	Upper	Lower			Extended	Collapsed	Stroke			Rebound	Compression
85180	ES150	ES36	1-5/8"	C	20.94	13.83	7.11	YES	YES	681	283
85181	ES150	ES150	1-5/8"	C	26.33	17.06	9.27	YES	YES	681	285
85182	S43	S43	1-5/8"	C	26.86	16.04	10.82	YES	NO	708	232
85188	ES161	ES162	1-5/8"	C	25.31	15.52	9.79	YES	YES	1074	255
85301	EB3	EB3	1-5/8"	D	31.92	19.03	12.89	YES	NO	1442	455
85302	EB3	EB3	1-5/8"	D	22.75	14.61	8.14	YES	NO	836	253
85304	EB3	EB3	1-5/8"	D	22.25	14.22	8.03	YES	NO	767	325
85307	EB3	EB3	1-5/8"	D	23.98	15.08	8.89	YES	NO	1094	173
85310	S21	S21	1-5/8"	D	18.63	11.71	6.92	YES	YES	1379	578
85311	S21	EB3	1-5/8"	D	23.95	14.79	9.16	YES	YES	764	254
85314	EB3	EB3	1-5/8"	D	26.49	16.46	10.03	YES	YES	1216	169
85329	EB3	EB3	1-5/8"	D	24.52	15.48	9.04	YES	YES	1550	232
85331	ES158	ES159	1-5/8"	D	19.62	12.85	6.77	YES	YES	1757	396
85332	S42	ES36	1-5/8"	D	20.64	12.98	7.66	YES	YES	2351	967
85335	ES158	ES159	1-5/8"	D	19.62	12.85	6.77	YES	YES	827	107
85351	S21	ES36	1-5/8"	D	20.61	12.82	7.79	YES	NO	1887	259
85376	EB3	EB3	1-5/8"	D	33.27	19.73	13.54	YES	NO	668	134
85649	S62	ES34	1-5/8"	G	23.16	16.46	6.7	YES	NO	875	421
85650	ES136	ES34	1-5/8"	G	24.88	16.35	8.53	YES	NO	941	463
85656	ES90	ES90	1-5/8"	G	26.49	16.94	9.55	YES	YES	1225	274
85670	ES175	ES175	1-5/8"	G	23.19	14.67	8.52	YES	YES	591	176
85702	EB3	EB3	1-5/8"	D	23.76	15.85	7.91	YES	YES	1093	825
85712	EB3	EB3	1-5/8"	D	20.5	13.47	7.04	YES	YES	1435	562
85716	EB3	EB3	1-5/8"	D	21.99	14.33	7.66	YES	YES	1220	175
85724	ES158	ES159	1-5/8"	D	22.81	14.51	8.3	YES	YES	1235	454
85736	EB3	EB3	1-5/8"	D	23.61	15.2	8.41	YES	YES	1155	352
85900	S21	S21	1-5/8"	G	17.33	11.23	6.11	YES	YES	1467	337
85902	S21	S21	1-5/8"	G	19.03	12.09	6.93	YES	YES	1441	267
85909	ES36	ES36	1-5/8"	G	24.25	15.19	9.06	YES	YES	700	255
85910	ES36	ES36	1-5/8"	G	20.79	13.54	7.25	YES	YES	1074	219
85918	ES150	ES150	1-5/8"	G	22.97	14.58	8.39	YES	NO	1726	412
85919	ES36	ES36	1-5/8"	G	22.52	14.33	8.19	YES	YES	1265	121
85920	ES150	ES150	1-5/8"	G	21.16	13.57	7.59	YES	NO	845	49
85921	S21	ES36	1-5/8"	G	22.07	13.57	8.5	YES	NO	2053	339
85923	ES177	ES161	1-5/8"	G	22.52	14.52	8	YES	YES	1940	221
85926	ES90	ES90	1-5/8"	G	26.5	17.96	8.54	YES	YES	1387	279
85927	ES90	ES90	1-5/8"	G	24.76	15.47	9.3	YES	YES	1288	388

* Damping force, in pounds, to either extend or collapse the shock absorber at an average operating velocity. Fuerza de amortiguación en libras para extender o comprimir el amortiguador a una velocidad de operación promedio. La puissance d'amortissement en poids de l'amortisseur, soit comprimé, doit détendu, à une vitesse de fonctionnement moyenne.

SPECIFICATIONS BY PART NUMBER
ESPECIFICACIONES POR NÚMERO DE PARTE
SPECIFICATIONS PAR NUMÉRO DE PIÈCE

Gabriel	Mounting		Bore	External Diameter Illustration	Lengths			Dust Tube	Recoil Cutoff	Controls*	
	Upper	Lower			Extended	Collapsed	Stroke			Rebound	Compression
85928	ES90	ES90	1-5/8"	G	20.31	13.24	7.07	YES	NO	957	229
85932	ES178	ES150	1-5/8"	G	21.26	13.7	7.56	YES	YES	1102	430
85936	ES174	S43	1-5/8"	G	17.27	11.48	5.79	YES	YES	1479	337
85956	ES183	ES184	1-5/8"	G	30.65	18.77	11.88	YES	YES	979	373
85957	ES90	ES90	1-5/8"	G	20.78	13.19	7.6	YES	NO	1583	138
85958	ES150	ES150	1-5/8"	G	22.89	14.5	8.39	YES	YES	1926	281
85959	ES150	ES150	1-5/8"	G	21.16	13.57	7.59	YES	YES	1021	123
85962	ES178	ES176	1-5/8"	G	21.8	13.66	8.15	YES	YES	2206	240
85976	ES36	ES36	1-5/8"	G	29.92	18.12	11.8	YES	YES	582	138
85978	ES179	ES179	1-5/8"	G	29.84	18.16	11.69	YES	YES	582	138
85985	ES174	S43	1-5/8"	G	19.04	12.31	6.73	YES	YES	2068	723
85986	ES175	ES150	1-5/8"	G	21.25	13.66	7.59	YES	YES	1754	221
85988	S21	EB3	1-5/8"	G	23.84	14.87	8.97	YES	YES	1200	138
85989	ES174	ES136	1-5/8"	G	20.78	13.15	7.63	YES	NO	1812	351
85995	ES90	ES36	1-5/8"	G	23.5	14.52	8.98	YES	NO	1830	173
89405	ES36	ES36	1-5/8"	G	26.3	16.57	9.73	YES	YES	1009‡	249
89406	ES36	ES36	1-5/8"	G	24.76	15.82	8.93	YES	YES	658‡	125
89407	ES36	ES36	1-5/8"	G	21.61	14.17	7.45	YES	YES	652‡	218
89409	EB2	EB2	1-5/8"	G	27.13	16.92	10.2	YES	YES	567‡	165
89410	EB3	EB3	1-5/8"	G	26.34	16.57	9.77	YES	NO	1185‡	182
89413	EB2	EB2	1-5/8"	G	20.94	13.53	7.41	YES	NO	536‡	201
89414	ES36	ES36	1-5/8"	G	29.65	18.18	11.46	YES	YES	1045‡	217
89420	EB3	EB3	1-5/8"	G	22.8	14.8	8	YES	NO	862‡	258
89423	S21	S21	1-5/8"	G	18.67	12.21	6.46	YES	YES	1352‡	573
89424	S21	EB3	1-5/8"	G	23.73	15.14	8.59	YES	YES	794‡	253
89425	EB3	EB3	1-5/8"	G	26.5	16.93	9.57	YES	YES	1352‡	167
89427	S21	EB3	1-5/8"	G	27.19	17.62	9.57	YES	YES	794‡	253
89430	ES36	ES36	1-5/8"	G	24.61	15.66	8.94	YES	YES	1462‡	279
89431	ES36	ES36	1-5/8"	G	22.41	14.16	8.25	YES	NO	751‡	211
89436	ES36	ES36	1-5/8"	G	17.24	12.04	5.2	YES	YES	998‡	217
89440	ES36	ES36	1-5/8"	G	23.9	15.31	8.59	YES	YES	1498‡	561
89443	ES158	ES159	1-5/8"	G	22.19	14.66	7.53	YES	YES	1206‡	466
89447	S21	S21	1-5/8"	G	23.63	14.69	8.94	YES	YES	702‡	241
89449	ES150	ES150	1-5/8"	G	23.25	14.9	8.35	YES	NO	1519‡	324
89451	ES174	ES136	1-5/8"	G	30.39	18.54	11.86	YES	YES	645‡	172
89453	ES178	ES150	1-5/8"	G	21.14	13.93	7.21	YES	YES	860‡	435
89455	S21	S21	1-5/8"	G	26.31	16.03	10.28	YES	YES	791‡	276

* Damping force, in pounds, to either extend or collapse the shock absorber at an average operating velocity. Fuerza de amortiguación en libras para extender o comprimir el amortiguador a una velocidad de operación promedio. La puissance d'amortissement en poids de l'amortisseur, soit comprimé, doit détendu, à une vitesse de fonctionnement moyenne.

**SPECIFICATIONS BY PART NUMBER
ESPECIFICACIONES POR NÚMERO DE PARTE
SPÉCIFICATIONS PAR NUMÉRO DE PIÈCE**

Gabriel	Mounting		Bore	External Diameter Illustration	Lengths			Dust Tube	Recoil Cutoff	Controls*	
	Upper	Lower			Extended	Collapsed	Stroke			Rebound	Compression
89456	ES174	S43	1-5/8"	G	17.04	11.63	5.4	YES	YES	975‡	377
89458	ES177	ES161	1-5/8"	G	22.48	14.6	7.88	YES	YES	1575‡	222
89459	ES174	EB3	1-5/8"	G	25.63	16.14	9.49	YES	NO	1179‡	314
89460	ES174	ES136	1-5/8"	G	20.58	13.03	7.55	YES	NO	997‡	384
89503	ES150	ES150	1-5/8"	G	21.28	13.72	7.56	YES	NO	1033‡	123
G51856	S92	LU1			21.18	15.11	6.07				
G56778	S68	CL1			21.37	14.37	7				
G57147	TMT3S	LU1			21.18	15.11	6.07				
G57800	TMU2B1S	LP4			26.73	19.49	7.24				
G57801	TMU2B1S	LP4			26.73	19.49	7.24				
G57802	TMR4S	CL3			17.20	9.96	7.24				
G57816	TMT3S	LP4			27.17	18.98	8.19				
G63183	EB4	EB4			20.79	13.01	7.78				
G63299	EB1	EB1	1-3/8"		18.08	11.55	6.53				
G63306	ES24	ES24			19.85	12.57	7.28				
G63347	ES31	ES35			18.08	11.55	6.53				
G63349	EB1	ES34			23.33	14.3	9.03				
G63350	S1	ES25			18.82	11.79	7.03				
G63353	ES27	EB4			24.74	14.96	9.78				
G63355	EB1	ES24			14.98	9.95	5.03				
G63357	ES24	ES24			14.98	9.95	5.03				
G63359	S1	BP13			13.7	8.92	4.78				
G63360	S1	BP13			15.7	9.92	5.78				
G63366	ES34	ES34			23.26	14.23	9.03				
G63375	S12	BP7			14.14	9.11	5.03				
G63377	EB1	ES25			20.08	12.55	7.53				
G63386	S36	ES25			16.11	10.58	5.53				
G63387	S1	ES25			23.32	14.04	9.28				
G63394	EB1	ES24			16.01	10.48	5.53				
G63403	ES26	ES26			24.58	14.8	9.78				
G63405	EB1	EB1			20.01	12.48	7.53				
G63406	EB1	ES83			22.98	13.95	9.03				
G63409	EB1	ES185			21.48	13.2	8.28				
G63410	S12	EB1			18.55	11.77	6.78				
G63411	ES31	ES26			18.58	11.8	6.78				
G63413	ES27	ES27			20.76	12.98	7.78				
G63414	S36	ES41			15.09	10.06	5.03				

* Damping force, in pounds, to either extend or collapse the shock absorber at an average operating velocity. Fuerza de amortiguación en libras para extender o comprimir el amortiguador a una velocidad de operación promedio. La puissance d'amortissement en poids de l'amortisseur, soit comprimé, doit détendu, à une vitesse de fonctionnement moyenne.

SPECIFICATIONS BY PART NUMBER
ESPECIFICACIONES POR NÚMERO DE PARTE
SPECIFICATIONS PAR NUMÉRO DE PIÈCE

Gabriel	Mounting		Bore	External Diameter Illustration	Lengths			Dust Tube	Recoil Cutoff	Controls*	
	Upper	Lower			Extended	Collapsed	Stroke			Rebound	Compression
G63418	S1	BP11			13.95	9.17	4.78				
G63419	EB1	EB1			24.08	14.55	9.53				
G63432	S1	EB19	1-3/8"		21.11	12.83	8.28				
G63455	ES83	ES83			22.98	13.95	9.03				
G63456	EB1	ES83			26.85	16.07	10.78				
G63461	EB1	ES83			25.51	15.23	10.28				
G63488	BP14	ES34			26.61	16.33	10.28				
G63489	S29	BP11			14.42	9.64	4.78				
G63605	EB19	ES27			24.24	14.71	9.53				
G63607	BP14	ES185	1-3/8"		25.58	15.3	10.28				
G63609	ES126	ES128			16.5	10.97	5.53				
G63610	S47	EB1			21.95	13.17	8.78				
G63614	S36	EB1	1-3/8"		15.09	10.06	5.03				
G63622	S36	EB1			15.32	10.29	5.03				
G63623	S36	ES83			22.57	14.29	8.28				
G63625	EB1	ES24			22.56	13.78	8.78				
G63638	BP14	ES34			24.33	14.8	9.53				
G63661	S38	ES34			13.8	9.52	4.28				
G63662	ES34	ES34			24.58	15.05	9.53				
G63671	ES26	ES26			22.48	13.7	8.78				
G63673	EB1	ES83			22.3	13.77	8.53				
G63674	S38	ES34			23.39	14.36	9.03				
G63675	EB1	ES83			26.86	16.08	10.78				
G63692	EB1	EB1			27.58	16.3	11.28				
G63714	S62	BP7			15.39	9.86	5.53				
G63715	S12	ES171			28.55	16.52	12.03				
G63716	S62	ES26			16.39	9.86	6.53				
G63778	S12	ES171			24.55	14.52	10.03				
G63783	S12	BP11			14.59	10.21	4.38				
G63808	EB1	ES83			28.86	17.08	11.78				
G63809	EB1	ES83			22.98	13.95	9.03				
G63810	EB1	ES185			31.6	18.57	13.03				
G63817	S12	ES60			15.8	11.02	4.78				
G63837	BP8	ES41	1-3/8"		28.23	17.95	10.28				
G63866	ES34	ES34	1-3/8"		22.81	14.12	8.69				
G63886	S38	ES34			20.8	13.36	7.44				

* Damping force, in pounds, to either extend or collapse the shock absorber at an average operating velocity. Fuerza de amortiguación en libras para extender o comprimir el amortiguador a una velocidad de operación promedio. La puissance d'amortissement en poids de l'amortisseur, soit comprimé, soit détendu, à une vitesse de fonctionnement moyenne.

**SPECIFICATIONS BY PART NUMBER
ESPECIFICACIONES POR NÚMERO DE PARTE
SPÉCIFICATIONS PAR NUMÉRO DE PIÈCE**

Gabriel	Mounting		Bore	External Diameter Illustration	Lengths			Dust Tube	Recoil Cutoff	Controls*	
	Upper	Lower			Extended	Collapsed	Stroke			Rebound	Compression
G63888	EB1	ES83			31.36	18.67	12.69				
G63893	S11	LU1			15.07	10.44	4.63				
G63895	S11	BP9			14.12	9.68	4.44				
G63897	BP14	ES34			23.87	14.68	9.19				
G63907	EB1	EB1			20.23	12.37	7.86				
G63918	ES34	ES141			21.25	13.56	7.69				
G63950	S1	BP7			14.2	9.09	5.11				
G63969	S62	ES34			20.75	13.31	7.44				
G63971	ES34	ES34			27.58	17.14	10.44				
G64009	S38	ES34			23.29	14.25	9.04				
G64010	EB1	ES83			26.94	16	10.94				
G64011	S62	ES87			23.36	14.21	9.15				
G64013	ES34	ES34			26.52	16.33	10.19				
G64043	S61	BP38			14.09	9.68	4.41				
G64044	ES49	ES49			25.98	16.22	9.76				
G64089	ES56	ES56			20.43	13.03	7.4				
G64121	ES34	ES34			25.35	16.17	9.18				
G64148	LU1	DS1			18.39	14.09	4.3				
G64164	ES210	ES13			19.95	12.81	7.14				
G64177	ES216	ES19			25.86	16.1	9.76				
G64268	EB1	ES56			31.34	18.70	12.64				
G64269	EB1	ES56			26.93	16.04	10.89				

* Damping force, in pounds, to either extend or collapse the shock absorber at an average operating velocity. Fuerza de amortiguación en libras para extender o comprimir el amortiguador a una velocidad de operación promedio. La puissance d'amortissement en poids de l'amortisseur, soit comprimé, doit détendu, à une vitesse de fonctionnement moyenne.

QUESTIONS ANSWERED.



800.999.3903 | ANSWERGARAGE.COM

Gabriel®

THE ORIGINAL

Ride Control Answer Garage/Tech Line:

800.999.3903

For application, technical and
product questions
Monday - Friday, 8AM - 5PM CT

Gabriel Customer Service:

800.251.5932

To place and track orders
Monday - Friday, 7AM - 5PM CT

Watch our Videos:

Gabriel®
Shock Selector



Last Mile
Delivery



ReadyMount®
Installation



MaxControl™
Installation



FIND MORE AT GABRIEL.COM
part lookup, product info, technical help & training

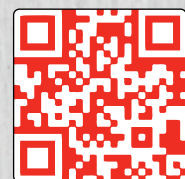

Ride Control, LLC, 39300 Country Club Dr.
Farmington Hills, MI 48331, 248.247.7600