

Gabriel®

THE ORIGINAL

2025

LAST MILE DELIVERY / MEDIUM DUTY SHOCKS & STRUTS CATALOG



SCAN TO WATCH!

*Explore Gabriel's lineup of premium
last mile delivery shocks & struts!*



Gabriel.com

Table of Contents

Last Mile Delivery

Last Mile Delivery Shocks & Struts - Application Listing.....	3
Last Mile Delivery Shocks & Struts - Numerical Listing.....	67

Medium Duty

Medium Duty Shocks - Application Listing.....	88
Medium Duty Shocks - Numerical Listing	212

Competitive & OEM Interchange.....	232
------------------------------------	-----

End Mount Specifications.....	432
-------------------------------	-----

Specifications by End Mount	439
-----------------------------------	-----

Specifications by Part Number	451
-------------------------------------	-----



Last Mile Delivery Shocks & Struts

(Alphabetical Listing)

(Numerical Listing)

**Amortiguadores y Struts
para entrega de
última final**

(Lista alfabética)
(Listado numérico)

**Amortisseurs et Jambes de Force
pour la livraison du dernier
kilomètre**

(Liste alphabétique)
(Ordre numérique)

Gabriel[®]

THE ORIGINAL



SCAN TO WATCH!

For more information
on Last Mile Delivery



[Gabriel.com/LastMile](https://gabriel.com/LastMile)

APPLICATION GUIDE

Year	Fitment Notes	OEM#								
			Fleetline\ Gas SLX	Classic\ Ultra\ ProGuard\ Guardian	Max Control\ LTV Severe Duty\ Load Carrier	Steering Dampers\ Steering Stabilizer\ Cab Shock	Fleetline\ Gas SLX	Classic\ Ultra\ ProGuard\ Guardian	Max Control\ LTV Severe Duty\ Load Carrier\ HiJackers	Steering Dampers\ Steering Stabilizer\ Cab Shock

CHEVROLET

CHEVROLET

C20 PANEL

67	All		O/O			34036 ⁸				
----	-----	--	-----	--	--	--------------------	--	--	--	--

C30 PANEL

63-66	All		O/O			34036 ⁸				
-------	-----	--	-----	--	--	--------------------	--	--	--	--

C60 KODIAK

90-96	Conventional Cab w/ Front Shock with O.E.M. Number	88982682 15588554 15887728 15174898 19152843 22064230 15123676	O/O	83136							
	Conventional Cab w/15000, 19000, 21000 lb Multileaf Springs	15174902 88982686 22064232									
	Conventional Cab w/19000, 21000, 23000 lb Taperleaf Springs (EXC Low Profile Vehicle)	22064233									
	Truck Cabs with Link Cabmate Model GMC104TK	1201-0054 1202-0054	O/O								

C3500HD

91-02	I Beam Front Axle						O/O		43180 ⁸	
	Exc. I Beam Front Axle						O/O	61543	43163 ⁸ 58488	



C4500 KODIAK

03-09	C Chassis - Conventional Cab	88982682 15588554 15887728 19152843 22064230 15123676	O/O	83136						
	C Chassis - Conventional Cab w/19000, 21000, 23000 lb Taperleaf Springs (EXC Low Profile Vehicle)	22064233								
	C Chassis - Conventional Cab With 15000, 19000, 21000 lb Multileaf Springs	15174902 88982686 22064232								
	Truck Cabs with Link Cabmate Model GMC104TK	1201-0054 1202-0054	O/O							
90-02	C Chassis - Conventional Cab 83000 Series	88982682 15588554 15887728 19152843 22064230 15123676	O/O	83136						
	C Chassis - Conventional Cab w/19000, 21000, 23000 lb Taperleaf Springs (EXC Low Profile Vehicle) 83000 Series	22064233								
	C Chassis - Conventional Cab With 15000, 19000, 21000 lb Multileaf Springs 85000 Series	15174902 88982686 22064232								
83-99	C Chassis - Conventional Cab with 9100 to 17500 lb Rear Axle 83000 Series	22064432	O/O					83221		

C5500 KODIAK

03-09	C Chassis - Conventional Cab	88982682 15588554 15887728 19152843 22064230 15123676	O/O	83136						
	C Chassis - Conventional Cab w/19000, 21000, 23000 lb Taperleaf Springs (EXC Low Profile Vehicle)	22064233								

APPLICATION GUIDE

Year	Fitment Notes	OEM#								
			Fleetline/ Gas SLX	Classic/ Ultra/ ProGuard/ Guardian	Max Control/ LTV Severe Duty/ Load Carrier	Steering Dampers/ Steering Stabilizer/ Cab Shock	Fleetline/ Gas SLX	Classic/ Ultra/ ProGuard/ Guardian	Max Control/ LTV Severe Duty/ Load Carrier/ HiJackers	Steering Dampers/ Steering Stabilizer/ Cab Shock

CHEVROLET

CHEVROLET

C5500 KODIAK (cont)

03-09	C Chassis - Conventional Cab With 15000, 19000, 21000 lb Multileaf Springs	15174902 88982686 22064232			85071
	Truck Cabs with Link Cabmate Model GMC104TK	1201-0054 1202-0054	O	83021	O
92-02	C Chassis - Conventional Cab 83000 Series	88982682 15588554 15887728 19152843 22064230 15123676		83136
	C Chassis - Conventional Cab w/19000, 21000, 23000 lb Taperleaf Springs (EXC Low Profile Vehicle) 83000 Series	22064233			83136
	C Chassis - Conventional Cab With 15000, 19000, 21000 lb Multileaf Springs 85000 Series	15174902 88982686 22064232			85071
92-99	C Chassis - Conventional Cab with 9100 to 17500 lb Rear Axle 83000 Series	22064432		O	83221
90-91	C Chassis - Conventional Cab	88982682 15588554 15887728 19152843 22064230 15123676		83136
	C Chassis - Conventional Cab w/19000, 21000, 23000 lb Taperleaf Springs (EXC Low Profile Vehicle)	22064233			83136
	C Chassis - Conventional Cab With 15000, 19000, 21000 lb Multileaf Springs	15174902 88982686 22064232			85071
	C Chassis - Conventional Cab with 9100 to 17500 lb Rear Axle	22064432		O	83221
	Truck Cabs with Link Cabmate Model GMC104TK	1201-0054 1202-0054	O	83021	O
83-89	C Chassis - Conventional Cab with 9100 to 17500 lb Rear Axle 83000 Series	22064432		O	83221



C6500 KODIAK

03-09	Models with Hendrickson Air Suspension with O.E.M. Number	60670-005 060665-003 12474917 15740554 59057-001 47902-29		O	83137
97-99	Models with Hendrickson Air Suspension with O.E.M. Number	60670-005 060665-003 12474917 15740554 59057-001 47902-29		O	83137

C7500 KODIAK

00-01	Conventional Cab w/ Front Shock with O.E.M. Number	88982682 15588554 15887728 15174898 19152843 22064230 15123676		83136
	Conventional Cab w/15000, 19000, 21000 lb Multileaf Springs	15174902 88982686 22064232			85071
	Conventional Cab w/19000, 21000, 23000 lb Taperleaf Springs (EXC Low Profile Vehicle)	22064233			83136
	Models with Hendrickson Air Suspension (Stamping number 47902-13)	12474915 15963161		O	83122 89406

APPLICATION GUIDE

Year	Fitment Notes	OEM#								
			Fleetline\ Gas SLX	Classic\ Ultra\ ProGuard\ Guardian	Max Control\ LTV Severe Duty\ Load Carrier	Steering Dampers\ Steering Stabilizer\ Cab Shock	Fleetline\ Gas SLX	Classic\ Ultra\ ProGuard\ Guardian	Max Control\ LTV Severe Duty\ Load Carrier\ HiJackers	Steering Dampers\ Steering Stabilizer\ Cab Shock

CHEVROLET

CHEVROLET

C7500 KODIAK (cont)

00-01	Models with Hendrickson Air Suspension with O.E.M. Number	60670-005 060665-003 12474917 15740554 59057-001 47902-29			83137
	Truck Cabs with Link Cabmate Model GMC104TK	1201-0054 1202-0054		83021	

EXPRESS 4500

09-22	All			61685 G63895	61687 G63897	58638 77638
-------	-----	--	--	------	-----------------	------	------	--	------	-----------------	----------------	------

FLEETLINE

49-52	All			82026 G63610	61592 81340 82066	43140 ⁸ 49205 ⁷
-------	-----	--	--	------	-----------------	------	------	--	------	-------------------------	--	------

FLEETLINE TRUCK

49-52	All			82026 G63610	61592 81340 82066	43140 ⁸ 49205 ⁷
-------	-----	--	--	------	-----------------	------	------	--	------	-------------------------	--	------

K20 PANEL

67	All			G63306
----	-----	--	--	------	------	------	------	--	------	--------	------	------

LCF 3500

16-23	All	98381010 98232671		83515
		98380746			83159

LCF 3500HD

18	83000 Series	98381010 98232671		83515
		98380746			83159
16-17	All	98381010 98232671		83515
		98380746			83159

P60

92-96	Motorhome Chassis	22064233			83136
-------	-------------------	----------	--	------	------	------	------	--	-------	------	------	------

P6000

92-96	Motorhome Chassis	22064233			83136
-------	-------------------	----------	--	------	------	------	------	--	-------	------	------	------

PICKUP 3/4 TON, C20



75-86	All			61525 81039 G63355
	Crew Cab Pickup			34036 ⁸	G63366	58930
	Standard Cab Pickup			34036 ⁸	61524 81164 G63349	43111 ⁸ 49155 ⁷
63-86	Single System Steering Stabilizer			6802SE ⁸⁴								
73-74	Crew Cab Pickup			61525 81039 G63355	34036 ⁸
	Standard Cab Pickup			61524 81164	43111 ⁸ 49155 ⁷
67-72	All			61525 81039 G63355	34036 ⁸	G63306

7 Pair Packs, Air hose kit included.;

8 Pair Packs.;

84 Replacement damper for vehicles with the Gabriel Aftermarket mounting kit;

APPLICATION GUIDE

Year	Fitment Notes	OEM#								
			Fleetline/ Gas SLX	Classic/ Ultra/ ProGuard/ Guardian	Max Control/ LTV Severe Duty/ Load Carrier	Steering Dampers/ Steering Stabilizer/ Cab Shock	Fleetline/ Gas SLX	Classic/ Ultra/ ProGuard/ Guardian	Max Control/ LTV Severe Duty/ Load Carrier/ HiJackers	Steering Dampers/ Steering Stabilizer/ Cab Shock

CHEVROLET

CHEVROLET

PICKUP 3/4 TON, C20 (cont)

67-72	Coil(RearSpringType)		82003	49107 ⁷	...
	Leaf(RearSpringType)		49162 ⁷	...
63-66	All		...	61525 81039 G63355	34036 ⁸	G63306	49162 ⁷	...
60-62	All		...	82035	82086

PICKUP 3/4 TON, C25 / C2500

88-00	All		...	61544 81668 G63489	34073 ⁸ 58489 77489	61543 81667 G63488	43163 ⁸ 49218 ⁷ 58488 77488	...
92-99	Exc. OE Unit		...	6853SE ⁸⁶						

PICKUP 3/4 TON, K20

81-86	Exc. Lift Kit		...	G63347	61524 81164 G63349	43111 ⁸	...
	Quad Suspension Long Shock; Exc. Lift Kit		...	61522 ⁸ 81496 ⁸
	Quad Suspension Short Shock; Exc. Lift Kit		...	61516 ⁸
	Standard Suspension; Exc. Lift Kit		...	81113 ⁸	49155 ⁷	...
73-86	All		14017
	Steering Stabilizer		6804SE ⁸⁰							
67-86	Dual System Steering Stabilizer		6802SE ⁸⁴							
75-80	Exc. Lift Kit		...	61516 ⁸ 81113 ⁸ G63347	61524 81164 G63349	43111 ⁸ 49155 ⁷	...
73-74	Exc. Lift Kit		...	61516 ⁸ 81113 ⁸ G63347	61524 81164	43111 ⁸ 49155 ⁷	...
69-72	Exc. Lift Kit		...	61516 ⁸ 81113 ⁸ G63347
67-72	All		G63306
61-72	Steering Stabilizer		6803SE ⁸⁴							

PICKUP 3/4 TON, K25 / K2500

99-00	Exc. OE Unit		6853SE ⁸⁶							
88-00	All		...	61542 81726 G63609	58609 77609	61543 81667 G63488	43163 ⁸ 49218 ⁷ 58488 77488	...

PICKUP 3/4 TON, R20

87-88	All		...	61525 81039 G63355
	Crew Cab Pickup		34036 ⁸	G63366	58930	...
	Single System Steering Stabilizer		6802SE ⁸⁴							
87	Standard Cab Pickup		61524 81164 G63349	43111 ⁸ 49155 ⁷	...

6 It is recommended that when replacing shocks on vehicles with "quad shocks" all 4 shocks should be matched by series.;

8 Pair Packs.;



84 Replacement damper for vehicles with the Gabriel Aftermarket mounting kit;

7 Pair Packs, Air hose kit included.;

80 Mounting bracket not required, install on O.E. Shock Mounts. See Ref. C for optional Steering Stabilizer Boots.;

86 Exc. OE Unit;

APPLICATION GUIDE

Year	Fitment Notes	OEM#								
			Fleetline\ Gas SLX	Classic\ Ultra\ ProGuard\ Guardian	Max Control\ LTV Severe Duty\ Load Carrier	Steering Dampers\ Steering Stabilizer\ Cab Shock	Fleetline\ Gas SLX	Classic\ Ultra\ ProGuard\ Guardian	Max Control\ LTV Severe Duty\ Load Carrier\ HiJackers	Steering Dampers\ Steering Stabilizer\ Cab Shock

CHEVROLET

CHEVROLET

PICKUP 3/4 TON, R2500

89	All		00	61525 81039 G63355	34036 ⁸	00	G63366	58930
	Single System Steering Stabilizer		00	6802SE ⁸⁴								

PICKUP 3/4 TON, SILVERADO 2500

11-18	All		00	00	G64121
05-08	All		01	61663 81925 G63817	58817 77817	00	61642 81921 G63675	58412 77412
99-04	All		01	00	61642 81921 G63675	58412 77412
	4WD		01	61663 81925 G63817	58817 77817	00
	RWD, Exc. Electronic Adjustable Suspension		01	61641 81920 G63783	77783	00

PICKUP 3/4 TON, SILVERADO 2500 HD

11-24	All		00	G64148	00	G64121	43181 ⁸ 77976
05-10	9200# GVW		01	61663 G63817	58817 77817	00
01-10	All		01	00	61642 81921 G63675	58412 77412
01-09	9200# GVW w/ OE Unit - 15059138 15155638		00	6853SE ⁸²								
	9200# GVW w/o OE Unit - 15059138 15155638		00	6803SE ⁸⁴								
01-04	9200# GVW		01	58817 77817	00
	4WD, 9200# GVW		01	61663 G63817	00
	RWD		01	61641 81920 G63783	77783	00

PICKUP 3/4 TON, V20

87	All		00	14017	00	49155 ⁷
	Exc. Quad Suspension and Lift Kit		00	61516 G63347	00	61524 81164 G63349	43111 ⁸
	Quad Suspension Long Shock; Exc. Lift Kit		00	61522 ⁸ 81496 ⁸	00
	Dual System Steering Stabilizer		00	6802SE ⁸⁴								
	Steering Stabilizer		00	6804SE ⁸⁰								

PICKUP 1 TON, C30

75-86	All		00	61525 81039 G63355	34036 ⁸	00	G63366	58930
73-86	Single System Steering Stabilizer; with Cooler		00	6802SE ⁸⁴								
63-74	All		00	61525 81039 G63355	34036 ⁸	00
67-72	Exc. 11,000# Rear Axle		00	00	G63306	49162 ⁷
61-72	Single System Steering Stabilizer		00	6802SE ⁸⁴								

6 It is recommended that when replacing shocks on vehicles with "quad shocks" all 4 shocks should be matched by series.;

8 Pair Packs.;



82 Use kit if listed, See Ref. C for optional Steering Stabilizer Boots.;

7 Pair Packs, Air hose kit included.;

80 Mounting bracket not required, install on O.E. Shock Mounts. See Ref. C for optional Steering Stabilizer Boots.;

84 Replacement damper for vehicles with the Gabriel Aftermarket mounting kit;

APPLICATION GUIDE

Year	Fitment Notes	OEM#								
			Fleetline/ Gas SLX	Classic/ Ultra/ ProGuard/ Guardian	Max Control/ LTV Severe Duty/ Load Carrier	Steering Dampers/ Steering Stabilizer/ Cab Shock	Fleetline/ Gas SLX	Classic/ Ultra/ ProGuard/ Guardian	Max Control/ LTV Severe Duty/ Load Carrier/ HiJackers	Steering Dampers/ Steering Stabilizer/ Cab Shock

CHEVROLET

CHEVROLET

PICKUP 1 TON, C30 (cont)

61-62	All		82035
-------	-----	--	-------	-----	-----	-----	-----	-----	-----

PICKUP 1 TON, C35/3500

98-00	Crew Cab; Exc. HD Straight Front Axle		61544 G63489	58489	G63488
92-00	Exc. HD Straight Front Axle		81668
	Exc. HD Straight Front Axle		61544 G63489	58489 77489	G63488
	Extended & Standard Cab; Exc. HD Straight Front Axle		81667
91-00	All		49218 ⁷ 77488	...
88-00	Extended & Standard Cab; Exc. Straight Front Axle		...	34073 ⁸
92-97	Crew Cab; Exc. HD Straight Front Axle		61544 G63489	58489 77489	G63488
88-91	Cab & Chassis Exc. HD Solid Front Axle		58930	...
	Cab & Chassis; Exc. HD Solid Front Axle		61525 81039 G63355	34036 ⁸	G63366
91	Extended & Standard Cab; Exc. HD Straight Front Axle		61544 81668 G63489	58489 77489	81667 G63488
88-90	Extended & Standard Cab; Exc. HD Straight Front Axle		61544 81668 G63489	58489 77489	61543 81667 G63488	43163 ⁸ 49218 ⁷ 58488 77488	...

PICKUP 1 TON, K30

77-86	All		G63411	...	14017	...	61642 81921 G63675	58412 77412	...
	Dual System Steering Stabilizer		6802SE ⁸⁴						
	Steering Stabilizer		6804SE ⁸⁰						
73-74	All		14017

PICKUP 1 TON, K35 / K3500

95-00	Exc. OE Unit		6853SE ⁸⁶						
88-00	All		61542 81726 G63609	58609 77609	61543 81667 G63488	43163 ⁸ 49218 ⁷ 58488 77488	...

PICKUP 1 TON, R30

87-88	All		61525 81039 G63355	34036 ⁸	G63366	58930	...
	Single System Steering Stabilizer; with Cooler		6802SE ⁸⁴						

PICKUP 1 TON, R3500

90-91	All		81039 G63411	...	14017	...	61642 81921 G63675	58412 77412	...
89-91	Single System Steering Stabilizer; with Cooler		6802SE ⁸⁴						
89	All		81039	...	14017
	Exc. Standard Cab		G63411	61642 81921 G63675	58412 77412	...

7 Pair Packs, Air hose kit included.;



80 Mounting bracket not required, install on O.E. Shock Mounts. See Ref. C for optional Steering Stabilizer Boots.;

86 Exc. OE Unit;

8 Pair Packs.;

84 Replacement damper for vehicles with the Gabriel Aftermarket mounting kit;

APPLICATION GUIDE

Year	Fitment Notes	OEM#								
			Fleetline\ Gas SLX	Classic\ Ultra\ ProGuard\ Guardian	Max Control\ LTV Severe Duty\ Load Carrier	Steering Dampers\ Steering Stabilizer\ Cab Shock	Fleetline\ Gas SLX	Classic\ Ultra\ ProGuard\ Guardian	Max Control\ LTV Severe Duty\ Load Carrier\ HiJackers	Steering Dampers\ Steering Stabilizer\ Cab Shock

CHEVROLET

CHEVROLET

PICKUP 1 TON, R3500 (cont)

89	Standard Cab Pickup				61525 G63355	34036 ⁸			G63366	58930		
----	---------------------	--	--	--	-----------------	--------------------	--	--	--------	-------	--	--

PICKUP 1 TON, SILVERADO 3500

15-18	All								G64121			
11-13	All								G64121			
01-09	All				61663 81925 G63817	58817 77817			61642 81921 G63675	58412 77412		

PICKUP 1 TON, SILVERADO 3500 HD

11-24	All				G64148				G64121	43181 ⁸ 77976		
08-10	All				61663 G63817	58817 77817			61642 81921 G63675	58412 77412		
07	All				61663 G63817	58817 77817			61642 G63675	58412		
	Classic									77412		

PICKUP 1 TON, V30

87-88	All				G63411				61642 81921 G63675	58412 77412		
-------	-----	--	--	--	--------	--	--	--	--------------------------	----------------	--	--

PICKUP 1 TON, V3000 / V3500

89-91	All				G63411				61642 81921 G63675	58412 77412		
-------	-----	--	--	--	--------	--	--	--	--------------------------	----------------	--	--

SILVERADO 2500 HD CLASSIC

07	All				61663 G63817	77817			61642 G63675	58412 77412		
	9200# GVW					58817						

SILVERADO 3500 CLASSIC

07	All								81921	58412		
	Heavy Duty					58817						



SILVERADO 4500 HD

19-22	Diesel Low Cab Forward models with 14,000 to 15,000 lb Rear	8983807460 8-98380-746-0							83159			
	Diesel Low Cab Forward models with 14,500 lb GVWR	8983810100			83515							
	Diesel Low Cab Forward models with 15,000 to 16,000 lb Rear	8983807470							83159			
	Diesel Low Cab Forward models with 16,000 lb to 19,500 lb GVWR	8983810120			83515							
	Models with 11K, 13.5K or 15.5K VARI-RATE Rear Suspension	4208946C1 4206863C1							83398			
	Models with 7,000 to 8,000 lb Front Axle	3989717C1			83135							
	Models with IROS Rear	4214011C2							85670			
	Models with Taperleaf Front	4109582C1 4089293C1 4109583C1 4207304C1			83397							
	Models with 4 x 4 Rear	4109458C2							83243			

SILVERADO 5500 HD

19-23	Models with 11K, 13.5K or 15.5K VARI-RATE Rear Suspension	4208946C1 4206863C1							83398			
-------	---	------------------------	--	--	--	--	--	--	-------	--	--	--

APPLICATION GUIDE

Year	Fitment Notes	OEM#								
			Fleetline/ Gas SLX	Classic/ Ultra/ ProGuard/ Guardian	Max Control/ LTV Severe Duty/ Load Carrier	Steering Dampers/ Steering Stabilizer/ Cab Shock	Fleetline/ Gas SLX	Classic/ Ultra/ ProGuard/ Guardian	Max Control/ LTV Severe Duty/ Load Carrier/ HiJackers	Steering Dampers/ Steering Stabilizer/ Cab Shock

CHEVROLET

CHEVROLET

SILVERADO 5500 HD (cont)

19-23	Models with Taperleaf Front	4109582C1 4089293C1 4109583C1 4207304C1	OO	83397	
19-22	Diesel Low Cab Forward models with 14,000 to 15,000 lb Rear	8983807460 8-98380-746-0	OO	OO	83159
	Diesel Low Cab Forward models with 14,500 lb GVWR	8983810100	IO	83515	OO	83159
	Diesel Low Cab Forward models with 15,000 to 16,000 lb Rear	8983807470	OO	OO	83159
	Diesel Low Cab Forward models with 16,000 lb to 19,500 lb GVWR	8983810120	IO	83515	OO	83243
	Models with 4 x 4 Rear	4109458C2	OO	OO	83135
	Models with 7,000 to 8,000 lb Front Axle	3989717C1	OO	83135	OO	85670
	Models with IROS Rear	4214011C2	OO	OO	85670

SILVERADO 6500 HD

19-23	Models with 11K, 13.5K or 15.5K VARI-RATE Rear Suspension	4208946C1 4206863C1	OO	OO	83398
	Models with Taperleaf Front	4109582C1 4089293C1 4109583C1 4207304C1	OO	83397	OO	83243
19-22	Models with 4 x 4 Rear	4109458C2	OO	OO	83135
	Models with 7,000 to 8,000 lb Front Axle	3989717C1	OO	83135	OO	85670
	Models with IROS Rear	4214011C2	OO	OO	85670



T5500

97-09	FL1 Tilt Cab with 8100 lb Axle 83000 Series	22165188 22165187 22064804 22064805	IT	83136	OO	85071
	FL2 Tilt Cab with 5000 to 11000 lb Axle 83000 Series	22166442 22064807	IT	83136	OO	83136
	FL3 Tilt Cab with 14575 lb Axle 83000 Series	22165189 22064806	IT	83136	OO	83136
90-06	Tilt Cab w/15000, 19000, 21000 lb Multileaf Springs 85000 Series	15174902 22064232	IT	IT	83136

T6500

04-09	FL1 Tilt Cab with 8100 lb Axle	22165188 22165187 22064804 22064805	IT	83136	OO	85071
	FL2 Tilt Cab with 5000 to 11000 lb Axle	22166442 22064807	IT	83136	OO	83136
	FL3 Tilt Cab with 14575 lb Axle	22165189 22064806	IT	83136	OO	83136
04-06	Tilt Cab w/15000, 19000, 21000 lb Multileaf Springs	15174902 22064232	IT	IT	85071
03	FL1 Tilt Cab with 8100 lb Axle 83000 Series	22165188 22165187 22064804 22064805	IT	83136	OO	85071
	FL2 Tilt Cab with 5000 to 11000 lb Axle 83000 Series	22166442 22064807	IT	83136	OO	83136
	FL3 Tilt Cab with 14575 lb Axle 83000 Series	22165189 22064806	IT	83136	OO	83136
	Tilt Cab w/15000, 19000, 21000 lb Multileaf Springs 85000 Series	15174902 22064232	IT	IT	85071

APPLICATION GUIDE

Year	Fitment Notes	OEM#								
			Fleetline\ Gas SLX	Classic\ Ultra\ ProGuard\ Guardian	Max Control\ LTV Severe Duty\ Load Carrier	Steering Dampers\ Steering Stabilizer\ Cab Shock	Fleetline\ Gas SLX	Classic\ Ultra\ ProGuard\ Guardian	Max Control\ LTV Severe Duty\ Load Carrier\ HiJackers	Steering Dampers\ Steering Stabilizer\ Cab Shock

CHEVROLET

CHEVROLET

T6500 (cont)

97-02	FL1 Tilt Cab with 8100 lb Axle	22165188 22165187 22064804 22064805		83136
	FL2 Tilt Cab with 5000 to 11000 lb Axle	22166442 22064807		83136
	FL3 Tilt Cab with 14575 lb Axle	22165189 22064806		83136
	Tilt Cab w/15000, 19000, 21000 lb Multileaf Springs	15174902 22064232			85071
97-99	Tilt Cab w/19000, 21000, 23000 lb Taperleaf Springs (EXC Low Profile Veh.)	22064233			83136
99	Models with Hendrickson Air Suspension (Stamping number 47902-13)	12474915 15963161			83122 89406
92-96	Tilt Cab w/19000, 21000, 23000 lb Taperleaf Springs (EXC Low Profile Veh.) 83000 Series	22064233			83136
90-96	Tilt Cab w/15000, 19000, 21000 lb Multileaf Springs 85000 Series	15174902 22064232			85071

VAN 1/2 TON, G / EXPRESS

78-95	All			61517 G63357 ⁵	58357	61522 81496 ⁶ G63413	49212 ⁷
70-95	Single System Steering Stabilizer			6802SE ⁸⁴								
71-77	All			61517 G63357 ⁵	58357	G63306	49162 ⁷
67-70	All			G63306	49162 ⁷
70	Independent Front Suspension			61517 G63357 ⁵	58357
64-66	All			82003

VAN 1/2 TON, P SERIES

74-80	All			61525 81039 G63355	34036 ⁸	G63366	58930 77662
73	All			61525 81039 G63355	34036 ⁸	61524 81164 G63349	43111 ⁸ 49155 ⁷
67-72	All			61525 81039 G63355	34036 ⁸	82003	49107 ⁷
63-66	All			61525 81039 G63355	34036 ⁸	G63306	49162 ⁷
61-62	All			82035	82086

VAN 3/4 TON, G / EXPRESS

23-24	All	PC3Z-18124-SDA, PC3Z-18124-BBA, PC3Z-18124-BCA, PC3Z-18124-BFA, PC3Z-18124-DAA, PC3Z-18124-SAA, PC3Z-18124-DBA, PC3Z-18124-SCA		58638
24	All			61685 G63895	61687 G63897	77638
17-23	All			61685 G63895	61687 G63897	43180 ⁸ 77638
10-16	All			61685	61687 G63897	43180 ⁸ 77638

5 Use kit No. 140719 to replace O.E. hardware for lower shock absorber mounting when studs break or self-tapping screws are not longer useable.;



7 Pair Packs, Air hose kit included.;

84 Replacement damper for vehicles with the Gabriel Aftermarket mounting kit;

6 It is recommended that when replacing shocks on vehicles with "quad shocks" all 4 shocks should be matched by series.;

8 Pair Packs.;

APPLICATION GUIDE

Year	Fitment Notes	OEM#								
			Fleetline/ Gas SLX	Classic/ Ultra/ ProGuard/ Guardian	Max Control/ LTV Severe Duty/ Load Carrier	Steering Dampers/ Steering Stabilizer/ Cab Shock	Fleetline/ Gas SLX	Classic/ Ultra/ ProGuard/ Guardian	Max Control/ LTV Severe Duty/ Load Carrier/ HiJackers	Steering Dampers/ Steering Stabilizer/ Cab Shock

CHEVROLET

CHEVROLET

VAN 3/4 TON, G / EXPRESS (cont)

03-16	Coil(FrontSpringType)		1	G63895	
03-12	Torsion Bar (FrontSpringType)		1	61683 G63893	
07-09	All			010	61687 G63897	43180 ⁸ 58638 77638
03-06	All			010	61687 G63897	43180 ⁸ 77638
96-02	Exc. 8600# GVW		1	61555 81713 ⁵ G63375 ⁵	34073 ⁸ 77375	010	61565 G63638	43180 ⁸ 49231 ⁷ 58638 77638
78-95	All		010	G63357 ⁵	010
	Exc. 8600# GVW		010	61517	58357	010	61522 81496 ⁶ G63413	49212 ⁷
70-95	Single System Steering Stabilizer		010	6802SE ⁸⁴								
71-77	All		010	61517 G63357 ⁵	58357	010	G63306	49162 ⁷
70	All		010	58357	010	G63306	49162 ⁷
	Independent Front Suspension		010	61517 G63357 ⁵	010
67-69	All		010	010	G63306	49162 ⁷

VAN 3/4 TON, P SERIES

79-89	All		010	61525 81039 G63355	34036 ⁸	010	G63366	58930 77662
73-78	All		010	61525 81039 G63355	34036 ⁸	010	61524 81164 G63349	43111 ⁸ 49155 ⁷
68-72	All		010	61525 81039 G63355	34036 ⁸	010	G63306	49162 ⁷
63-67	All		010	82047	010
61-62	All		010	82047	010	82155	43140 ⁸ 49203 ⁷

VAN 1 TON, G / EXPRESS

25	All			010	61687
23-24	All	PC3Z-18124-SDA, PC3Z-18124-BBA, PC3Z-18124-BCA, PC3Z-18124-BFA, PC3Z-18124-DAA, PC3Z-18124-SAA, PC3Z-18124-DBA, PC3Z-18124-SCA		010	58638
24	All		1	61685 G63895	010	G63897	77638
17-23	All		1	61685 G63895	010	61687 G63897	43180 ⁸ 77638
13-16	All		1	61685	010	61687 G63897	43180 ⁸ 77638
03-16	Coil(FrontSpringType)		1	G63895	010
10-12	All		1	61685	010	43180 ⁸ 58638 77638
03-12	Single Rear Wheels			010	61687 G63897

5 Use kit No. 140719 to replace O.E. hardware for lower shock absorber mounting when studs break or self-tapping screws are not longer useable.;



7 Pair Packs, Air hose kit included.;

84 Replacement damper for vehicles with the Gabriel Aftermarket mounting kit;

6 It is recommended that when replacing shocks on vehicles with "quad shocks" all 4 shocks should be matched by series.;

8 Pair Packs.;

APPLICATION GUIDE

Year	Fitment Notes	OEM#								
			Fleetline\ Gas SLX	Classic\ Ultra\ ProGuard\ Guardian	Max Control\ LTV Severe Duty\ Load Carrier	Steering Dampers\ Steering Stabilizer\ Cab Shock	Fleetline\ Gas SLX	Classic\ Ultra\ ProGuard\ Guardian	Max Control\ LTV Severe Duty\ Load Carrier\ HiJackers	Steering Dampers\ Steering Stabilizer\ Cab Shock

CHEVROLET

CHEVROLET

VAN 1 TON, G / EXPRESS (cont)

03-12	Torsion Bar (FrontSpringType)			G63893
07-09	All			43180 ⁸ 77638
03-06	All			43180 ⁸ 58638 77638
97-02	All			61555 81713 ⁵ G63375 ⁵	77375	61565	43180 ⁸ 49231 ⁷
	Exc. 8600# GVW			34073 ⁸	G63638
96	All			61517 61555 81713 ⁵ G63357 G63375 ⁵	58357 77375	43180 ⁸ 49231 ⁷
	Exc. 8600# GVW			34073 ⁸	61565
	Cutaway Van			58357	G63671
94-95	Single System Steering Stabilizer; HD with Straight Front Axle & Tilt Hood			6804SE ⁸⁰								
92-95	9200# GVW			77403
	Cutaway Van			61522 81496 ⁶ G63671	49212 ⁷ 58403
78-95	All			61517 G63357	58357
	Exc. Cutaway Van			G63413
71-95	Single System Steering Stabilizer			6802SE ⁸⁴								
79-91	9200# GVW			G63403	77403
	Cutaway Van			61522 81496 ⁶	49212 ⁷ 58403
78	Cutaway Van			61522 81496 ⁶	49212 ⁷
76-77	All			G63357	G63306	49162 ⁷
75	110.0 / 279.4(WheelBase)			G63306	49162 ⁷
	125.0 / 317.5(WheelBase)			G63306	49162 ⁷
	146.0 / 370.8(WheelBase)			61517 G63357	58357
71-74	All			61517 G63357	58357	G63306	49162 ⁷

VAN 1 TON, P SERIES

86-99	Motorhome Chassis w/ I-Beam Front Suspension			G63625
85-99	Motorhome Chassis w/ Independent Front Suspension			G63394
73-99	All			G63366	58930
92-96	Motorhome Chassis	22064233			83136
85-93	Single System Steering Stabilizer; w/ I-Beam Front Suspension			6804SE ⁸⁰								
73-90	Cutaway Chassis			61525 81039 G63355	34036 ⁸

5 Use kit No. 140719 to replace O.E. hardware for lower shock absorber mounting when studs break or self-tapping screws are not longer useable.;

7 Pair Packs, Air hose kit included.;



80 Mounting bracket not required, install on O.E. Shock Mounts. See Ref. C for optional Steering Stabilizer Boots.;

6 It is recommended that when replacing shocks on vehicles with "quad shocks" all 4 shocks should be matched by series.;

8 Pair Packs.;

84 Replacement damper for vehicles with the Gabriel Aftermarket mounting kit;

APPLICATION GUIDE

Year	Fitment Notes	OEM#								
			Fleetline/ Gas SLX	Classic/ Ultra/ ProGuard/ Guardian	Max Control/ LTV Severe Duty/ Load Carrier	Steering Dampers/ Steering Stabilizer/ Cab Shock	Fleetline/ Gas SLX	Classic/ Ultra/ ProGuard/ Guardian	Max Control/ LTV Severe Duty/ Load Carrier/ HiJackers	Steering Dampers/ Steering Stabilizer/ Cab Shock

CHEVROLET

CHEVROLET

VAN 1 TON, P SERIES (cont)

85	Motorhome Chassis w/ I-Beam Front Suspension		OO	G63403	58403 77403
74-84	Motorhome Chassis		OO	G63394
68-72	All		OO	34036 ⁸
	Cutaway Chassis		OO	61525 81039 G63355
	Exc. 11,000# Rear Axle		OO	G63306	49162'
63-67	All		OO	82047
61-62	All		OO	82047	82155	43140 ⁸ 49203'

W4500 TILTMASTER

87-10	Models with 11000 lb & 13000 lb Suspension	9516306471 97083029 94454987 98232671 97083027 8972536200 8-94454-986-0 8-94454-987-0 97253620 8-97253-620-0 8944549870 8944549860	OO	83515
-------	--	---	----	-------	------	------	------	------	------	------

W5500 TILTMASTER

88-10	Models with 11000 lb & 13000 lb Suspension	97253620	OO	83515
-------	--	----------	----	-------	------	------	------	------	------	------

W6500 TILTMASTER

87-96	Models with 11000 lb & 13000 lb Suspension	1-51630-168-1	OO	83515
-------	--	---------------	----	-------	------	------	------	------	------	------

DODGE

DODGE

M300

74	All		OO	82065
----	-----	--	----	------	------	------	------	-------	------	------

M350

74	All		OO	82065
----	-----	--	----	------	------	------	------	-------	------	------

PICKUP 3/4 TON, D200 SERIES

82-93	All		OO	81091 G63353	49149'
	Exc. Heavy Duty Package		OO	61523 ³⁵ 81096 ³⁵ G63359 ³⁵	34052 ⁸ 58359 ³⁵
	Heavy Duty Package		OO	81834 G63360 ³⁵
73-93	Single System Steering Stabilizer		OO	6802SE ⁸⁴						
75-81	Heavy Duty Package		OO	G63360 ³⁵
	165.0 / 419.1 (WheelBase) Heavy Duty Package		OO	81834
81	All		OO	81091 G63353
	Exc. Heavy Duty Package		OO	61523 ³⁵ 81096 ³⁵ G63359 ³⁵	34052 ⁸ 58359 ³⁵	49149'
72-80	All		OO	81091 G63353	49149'



7 Pair Packs, Air hose kit included.;

35 Slight grinding of control arm opening is required to install product made before

8 Pair Packs.;

84 Replacement damper for vehicles with the Gabriel Aftermarket mounting kit;

APPLICATION GUIDE

Year	Fitment Notes	OEM#								
			Fleetline\ Gas SLX	Classic\ Ultra\ ProGuard\ Guardian	Max Control\ LTV Severe Duty\ Load Carrier	Steering Dampers\ Steering Stabilizer\ Cab Shock	Fleetline\ Gas SLX	Classic\ Ultra\ ProGuard\ Guardian	Max Control\ LTV Severe Duty\ Load Carrier\ HiJackers	Steering Dampers\ Steering Stabilizer\ Cab Shock

DODGE

DODGE

PICKUP 3/4 TON, D200 SERIES (cont)

72-80	Exc. Heavy Duty Package		...	61523 ³⁵ 81096 ³⁵ G63359 ³⁵	34052 ⁸ 58359 ³⁵
72-74	Heavy Duty Package		...	81834 G63360 ³⁵
60-71	Single System Steering Stabilizer; with I Beam Axle		6802SE ⁸⁴						
60	All		...	82065

PICKUP 3/4 TON, W200 SERIES

90-93	Single System Steering Stabilizer		6802SE ⁸⁴						
81-93	Exc. Crew Cab & Lift Kit		...	61632 81825 G63183	81342	...
69-89	Single System Steering Stabilizer		6803SE ⁸⁴						
60-86	Dual System Steering Stabilizer; Exc. Vacuum Servo Mounted on Drivers Side of Axle		6802SE ⁸⁴						
72-80	All		...	61632 81825 G63183	81342	...
69-71	All		...	61632 81825 G63183
61-67	All		...	61632 81825 G63183
60-67	Single System Steering Stabilizer		6803SE ⁸⁴						
60	All		...	82065

PICKUP 1 TON, D300 SERIES

75-93	Single System Steering Stabilizer		6802SE ⁸⁴							
72-93	All		81091 G63353	49149 ⁷	...
	Heavy Duty Package		...	81834 G63360 ³⁵	
72-74	Single System Steering Stabilizer; with Coil Spring Front Suspension		6802SE ⁸⁴							
61-71	All		82065	...	
60-71	Single System Steering Stabilizer; with I Beam Axle		6802SE ⁸⁴							

PICKUP 1 TON, W300 SERIES

90-93	Single System Steering Stabilizer		6802SE ⁸⁴						
81-93	Exc. Quad Suspension and Lift Kit		...	61632 81825 G63183	81342	...
60-89	Single System Steering Stabilizer		6803SE ⁸⁴						
60-86	Dual System Steering Stabilizer; Exc. Vacuum Servo Mounted on Drivers Side of Axle		6802SE ⁸⁴						
72-80	All		...	61632 81825 G63183	81342	...
61-71	All		...	61632 81825 G63183	61632 81825 G63183	...



7 Pair Packs, Air hose kit included.;

35 Slight grinding of control arm opening is required to install product made before Aug 1988.;

8 Pair Packs.;

84 Replacement damper for vehicles with the Gabriel Aftermarket mounting kit;

APPLICATION GUIDE

Year	Fitment Notes	OEM#								
			Fleetline/ Gas SLX	Classic/ Ultra/ ProGuard/ Guardian	Max Control/ LTV Severe Duty/ Load Carrier	Steering Dampers/ Steering Stabilizer/ Cab Shock	Fleetline/ Gas SLX	Classic/ Ultra/ ProGuard/ Guardian	Max Control/ LTV Severe Duty/ Load Carrier/ HiJackers	Steering Dampers/ Steering Stabilizer/ Cab Shock

DODGE

DODGE

PICKUP 3/4 TON, RAM 2500 (SEE RAM 2500)

07-10	4WD		 O	61714 G64011	77948	 O	61716
03-10	All		 O	 O	77950
	4WD, 8800# GVW		 O	 O	G64013
	RWD		 O	77949	 O
	RWD, Crew Cab Pickup		 O	 O	61710 G63971
00-07	4WD; With OEM # 52106909AB, AC, AD		 O	6847SE ⁸²								
06	4WD		 O	61714 G64011	 O	61716
	4WD; Exc. 5.7L		 O	77948	 O
	4WD; w/5.7L		 O	77980	 O
04-05	4WD		 O	61714 G64011	77948	 O	61716
03	Exc. 8800# GVW		 O	 O	61600 81873 G63662
	4WD		 O	77948	 O	61716
99-02	4WD, Exc. 8800# GVW		 O	61634 81919 G63673	77673	 O
94-02	Exc. 8800# GVW		 O	 O	61600 81873 G63662	49235' 58662 77662
	4WD, 8800# GVW		 O	61635 G63674	77674	 O	61642 81921 G63675	77675
	RWD		 O	61599 81928 G63661	77661	 O
96-98	4WD, Exc. 8800# GVW		 O	61634 G63673	77673	 O
94-97	4WD; With OEM 52038276		 O	6804SE ⁸⁰								
94-95	4WD, Exc. 8800# GVW		 O	61634 81919 G63673	77673	 O



PICKUP 1 TON, RAM 3500 (SEE RAM 3500)

08-10	RWD, Crew Cab Pickup		 O	 O	G63971
07-10	4WD		 O	G63673	77948	 O
03-10	All		 O	 O	77950
	RWD		 O	77949	 O
03-07	RWD, Crew Cab Pickup		 O	 O	61710 G63971
00-07	4WD; With OEM # 52106909AB, AC, AD		 O	6847SE ⁸²								
	RWD; With OEM # 52106909AB, AC, AD and Solid Front Axle		 O	6847SE ⁸²								
06	4WD		 O	G63673	 O
	4WD, Exc. 5.9L		 O	77948	 O
	4WD; w/5.7L		 O	77980	 O
03-05	4WD		 O	G63673	77948	 O
94-02	4WD		 O	61635 G63674	77674	 O	61642 81921 G63675	77675

7 Pair Packs, Air hose kit included.;

80 Mounting bracket not required, install on O.E. Shock Mounts. See Ref. C for optional Steering Stabilizer Boots.;

APPLICATION GUIDE

Year	Fitment Notes	OEM#								
			Fleetline/ Gas SLX	Classic/ Ultra/ ProGuard/ Guardian	Max Control/ LTV Severe Duty/ Load Carrier	Steering Dampers/ Steering Stabilizer/ Cab Shock	Fleetline/ Gas SLX	Classic/ Ultra/ ProGuard/ Guardian	Max Control/ LTV Severe Duty/ Load Carrier/ HiJackers	Steering Dampers/ Steering Stabilizer/ Cab Shock

DODGE

DODGE

PICKUP 1 TON, RAM 3500 (SEE RAM 3500) (cont)

94-02	RWD, Exc. Solid Front Axle		61599 81928 G63661	77661	61600 81873 G63662	43181 ⁸ 49235 ⁷ 58662 77662
	RWD, Solid Front Axle		61635 G63674	77674	61642 81921 G63675	77675
94-97	4WD; With OEM 52038276		6804SE ⁶⁰								
	RWD; w/ OEM 52038276 Solid Front Axle		6804SE ⁶⁰								

SPRINTER 2500

07-09	All		G57802 ⁴⁰
	Single Rear Wheels		G63918
03-06	All		G56778
	Exc. Dual Rear Wheels		G63918

SPRINTER 3500

07-09	All		G57802 ⁴⁰
	Single Rear Wheels		G63918
03-06	All		G56778
	Exc. Dual Rear Wheels		G63918

VAN 1/2 TON, A / B SERIES / RAM

99-03	109.3 / 277.6(WheelBase) Exc. 7000# GVW		61523 ³⁵ 81096 ³⁵ G63359 ³⁵	34052 ⁸ 58359 ³⁵	61522 ⁶ 81496 G63413	43085 ⁸ 49212 ⁷
82-98	109.6 / 278.4(WheelBase) Exc. 7000# GVW		61523 ³⁵ 81096 ³⁵ G63359 ³⁵	34052 ⁸ 58359 ³⁵	61522 ⁶ 81496 G63413	43085 ⁸ 49212 ⁷
71-87	Single System Steering Stabilizer		6803SE ⁸⁴								
81	109.6 / 278.4(WheelBase) Exc. 7000# GVW		61523 ³⁵ 81096 ³⁵ G63359 ³⁵	58359 ³⁵	61522 ⁶ 81496 G63413	43085 ⁸
71-80	All		61523 ³⁵ 81096 ³⁵	34052 ⁸ 58359 ³⁵	61522 ⁶ 81496 G63413	43085 ⁸ 49212 ⁷
	Exc. 4000# Front Axle		G63359 ³⁵
71	Single System Steering Stabilizer; with I Beam Axle		6802SE ⁸⁴								



VAN 3/4 TON, A / B SERIES / RAM

81-03	All		61523 ³⁵ 81096 ³⁵ G63359 ³⁵	34052 ⁸ 58359 ³⁵	61522 ⁶ 81496 G63413	43085 ⁸ 49212 ⁷
80-87	Single System Steering Stabilizer		6803SE ⁸⁴								
71-80	All		61523 ³⁵ 81096 ³⁵	34052 ⁸ 58359 ³⁵	61522 ⁶ 81496 G63413	43085 ⁸ 49212 ⁷
	Exc. 4000# Front Axle		G63359 ³⁵
78-79	Van Charger Special		6803SE ⁸⁴								

6 It is recommended that when replacing shocks on vehicles with "quad shocks" all 4 shocks should be matched by series;
 8 Pair Packs;
 40 Complete Assembled Unit;
 84 Replacement damper for vehicles with the Gabriel Aftermarket mounting kit;

7 Pair Packs, Air hose kit included.;
 35 Slight grinding of control arm opening is required to install product made before Aug 1988.;
 80 Mounting bracket not required, install on O.E. Shock Mounts. See Ref. C for optional Steering Stabilizer Boots;;

APPLICATION GUIDE

Year	Fitment Notes	OEM#								
			Fleetline/ Gas SLX	Classic/ Ultra/ ProGuard/ Guardian	Max Control/ LTV Severe Duty/ Load Carrier	Steering Dampers/ Steering Stabilizer/ Cab Shock	Fleetline/ Gas SLX	Classic/ Ultra/ ProGuard/ Guardian	Max Control/ LTV Severe Duty/ Load Carrier/ HiJackers	Steering Dampers/ Steering Stabilizer/ Cab Shock

DODGE

DODGE

VAN 3/4 TON, A / B SERIES / RAM (cont)

71-77	Single System Steering Stabilizer		OO						6803SE ⁸⁴
71	Single System Steering Stabilizer; with I Beam Axle		OO						6802SE ⁸⁴

VAN 1 TON, A / B SERIES / RAM

95-03	All		⊖	61523 ³⁵ 81096 ³⁵ G63359 ³⁵	34052 ⁸ 58359 ³⁵	OO	61522 ⁸ 81496 G63413	43085 ⁸ 49212 ⁷
94	All			OO	61522 ⁸ 81496	43085 ⁸ 49212 ⁷
	Exc. 4000# Front Axle		⊖	61523 ³⁵ 81096 ³⁵ G63359 ³⁵	34052 ⁸ 58359 ³⁵	OO	G63413
71-93	All			OO	61522 ⁸ 81496 G63413	43085 ⁸ 49212 ⁷
	4000# Front Axle		⊖	81834 G63360 ³⁵
	Exc. 4000# Front Axle		⊖	61523 ³⁵ 81096 ³⁵ G63359 ³⁵	34052 ⁸ 58359 ³⁵
71-87	Single System Steering Stabilizer		OO						6803SE ⁸⁴			
71	Single System Steering Stabilizer; with I Beam Axle		OO						6802SE ⁸⁴			

VAN 1 TON, P SERIES

66-72	All			OO	82065
61-64	All			OO	82065

VAN, CB300

78-80	All			OO	61522 ⁸ 81496 G63413	43085 ⁸ 49212 ⁷
	Exc. 4000# Front Axle		⊖	61523 ³⁵ 81096 ³⁵ G63359 ³⁵	34052 ⁸ 58359 ³⁵
74-80	4000# Front Axle		⊖	81834 G63360 ³⁵
74-77	Exc. 4000# Front Axle		⊖	61523 ³⁵ 81096 ³⁵ G63359 ³⁵
	Up through 8300# GVW		⊖	34052 ⁸ 58359 ³⁵
77	All			OO	61522 ⁸ 81496 G63413	43085 ⁸
	Over 8300# GVW			OO	49212 ⁷
75-76	All			OO	61522 ⁸ 81496 G63413	43085 ⁸ 49212 ⁷
74	All			OO	61522 ⁸ 81496 G63413	43085 ⁸
	Over 8300# GVW			OO	49212 ⁷

FIAT

FIAT

124



68-76	Wagon			OO	82156
67	Wagon			OO	82156	49310 ⁷

6 It is recommended that when replacing shocks on vehicles with "quad shocks" all 4 shocks should be matched by series.;
8 Pair Packs.;

7 Pair Packs, Air hose kit included.;

35 Slight grinding of control arm opening is required to install product made before Aug 1988.;

APPLICATION GUIDE

Year	Fitment Notes	OEM#								
			Fleetline\ Gas SLX	Classic\ Ultra\ ProGuard\ Guardian	Max Control\ LTV Severe Duty\ Load Carrier	Steering Dampers\ Steering Stabilizer\ Cab Shock	Fleetline\ Gas SLX	Classic\ Ultra\ ProGuard\ Guardian	Max Control\ LTV Severe Duty\ Load Carrier\ HiJackers	Steering Dampers\ Steering Stabilizer\ Cab Shock

FIAT

FIAT

124 (cont)

66	Wagon		49310 ⁷	...
----	-------	--	-----	-----	-----	-----	-----	-----	--------------------	-----

1100

66-67	Exc. Wagon		82155	43140 ⁸	...
	Wagon		82156	49310 ⁷	...

1500

66-67	Exc. Wagon		82155
	Wagon		82156	49310 ⁷	...
64-65	Exc. Wagon		82155	43140 ⁸	...
	Wagon		82156

FORD

FORD

C600

80-86	Models with 3100 lb Spring and 7000 lb Axle	D7HT-18045-JA	83308
	Models with 4040, 5040 lb Springs and 7000, 9000, 12000 lb Axles	D2EF-18045-AA	83312

E-450 ECONOLINE SUPER DUTY

00-02	All		...	G63622	58622 77614	61646 G63623	58623 77623	...
	Exc. Cutaway Chassis		77623	...
	Steering Stabilizer		6828SE ⁸⁰

E-550 ECONOLINE SUPER DUTY

02	All		61655
	Steering Stabilizer		6828SE ⁸⁰

E-550 SUPER DUTY

03	All		61655
	Steering Stabilizer		6828SE ⁸⁰

ECONOLINE

00-06	All		...	G63622	58622	61646 G63623	58623	...
61-67	All		...	61506 81318 G63492	82007 G63299	49311 ⁷	...

ECONOLINE SUPER DUTY

96-99	All		77614	77623	...
	Steering Stabilizer		6828SE ⁸⁰

ECONOLINE VAN

61-67	Steering Stabilizer		6802SE ⁸⁴
-------	---------------------	--	-----	-----	-----	-----	-----	----------------------	-----	-----

EXCURSION

00-05	4WD		...	G63809	77809	G63837	77837	...
	4WD; With OE Unit		6854SE ⁸⁰



7 Pair Packs, Air hose kit included.;

80 Mounting bracket not required, install on O.E. Shock Mounts. See Ref. C for optional Steering Stabilizer Boots.;

8 Pair Packs.;

84 Replacement damper for vehicles with the Gabriel Aftermarket mounting kit;

APPLICATION GUIDE

Year	Fitment Notes	OEM#								
			Fleetline/ Gas SLX	Classic/ Ultra/ ProGuard/ Guardian	Max Control/ LTV Severe Duty/ Load Carrier	Steering Dampers/ Steering Stabilizer/ Cab Shock	Fleetline/ Gas SLX	Classic/ Ultra/ ProGuard/ Guardian	Max Control/ LTV Severe Duty/ Load Carrier/ HiJackers	Steering Dampers/ Steering Stabilizer/ Cab Shock

FORD

FORD

EXCURSION (cont)

00-05	RWD		I O	G63614	77614	O O	G63607	77607
-------	-----	--	--------	------	--------	-------	------	--------	------	--------	-------	------

F-53

08-23	F53 Chassis with 24,000 lb GVW to 26,000 lb GVW 85000 Series	ASH-25821 ASH-1161 HU9Z-18124-A	O O	85006	
		ASH-25820 ASH-1162			O O	85005
	F53 Chassis with 24,000 lb GVW to 26,000 lb GVW 89000 Series	ASH-25820 ASH-1162			O O	89430
06-23	F-53 Chassis with 16,000 lb GVW to 18,000 lb GVW 83000 Series	ASH-1206 9U94-18080-AA 9U9Z-18125-B AT-621 ASH-25825 ASH-25824 9U9Z-18125-A ASH-1023 ASH-1230 ASH-137 HU9Z-18125-B	O O		O O	83122
		ASH-1206 9U94-18080-AA 9U9Z-18125-B AT-621 ASH-25825 ASH-25824 9U9Z-18125-A ASH-1023 ASH-1230 ASH-137 HU9Z-18125-B			O O	89406
	F53 Chassis with 16,000 lb GVW to 22,000 lb GVW 83000 Series	ASH-1229 HU94-18045-AA ASH-1228 9U94-18045-AA ASH-1205 AT-620 ASH-1022 HU9Z-18124-B HU9Z-18124-C HU94-18045-BA ASH-294 9U9Z-18124-A 9U9Z-18124-B ASH-25822 ASH-25823 1C34-18045-JA AT-766	O O	83209
	F53 Chassis with 16,000 lb GVW to 22,000 lb GVW 89000 Series	ASH-1229 HU94-18045-AA ASH-1228 9U94-18045-AA ASH-1205 AT-620 ASH-1022 HU9Z-18124-B HU9Z-18124-C HU94-18045-BA ASH-294 9U9Z-18124-A 9U9Z-18124-B ASH-25822 ASH-25823 1C34-18045-JA AT-766	O O	89414
11-20	F53 Stripped Chassis Commercial Stripped Chassis, 19,500 lb to 22,000 lb GVW 85000 Series	471700007203 ASH-24634 DU94-18045-CB	O O	85013
		471700007203 ASH-24634 DU94-18045-CB	O O	89414
	F53 Stripped Chassis With BT Delivery Van Pack, 16,000 LB. GVW 85000 Series	471700009775 DU94-18080-CA 471700007117 DU94-18080-CB	O O		O O	85010

APPLICATION GUIDE

Year	Fitment Notes	OEM#								
			Fleetline\ Gas SLX	Classic\ Ultra\ ProGuard\ Guardian	Max Control\ LTV Severe Duty\ Load Carrier	Steering Dampers\ Steering Stabilizer\ Cab Shock	Fleetline\ Gas SLX	Classic\ Ultra\ ProGuard\ Guardian	Max Control\ LTV Severe Duty\ Load Carrier\ HiJackers	Steering Dampers\ Steering Stabilizer\ Cab Shock



FORD

FORD

F-53 (cont)

99-04	F-53 Chassis with 16,000 lb GVW to 18,000 lb GVW 83000 Series	ASH-1206 9U94-18080-AA AT-621 ASH-25824 9U9Z-18125-A ASH-1023 ASH-1230 ASH-137 HU9Z-18125-B	oio	83122
	F-53 Chassis with 16,000 lb GVW to 18,000 lb GVW 89000 Series	ASH-1206 9U94-18080-AA AT-621 ASH-25824 9U9Z-18125-A ASH-1023 ASH-1230 ASH-137 HU9Z-18125-B	oio	89406
	F53 Chassis with 16,000 lb GVW to 22,000 lb GVW 83000 Series	ASH-1229 HU94-18045-AA ASH-1228 9U94-18045-AA ASH-1205 AT-620 ASH-1022 HU9Z-18124-B HU9Z-18124-C HU94-18045-BA ASH-294 9U9Z-18124-A 9U9Z-18124-B ASH-25822 ASH-25823 1C34-18045-JA AT-766	oio	83209
	F53 Chassis with 16,000 lb GVW to 22,000 lb GVW 89000 Series	ASH-1229 HU94-18045-AA ASH-1228 9U94-18045-AA ASH-1205 AT-620 ASH-1022 HU9Z-18124-B HU9Z-18124-C HU94-18045-BA ASH-294 9U9Z-18124-A 9U9Z-18124-B ASH-25822 ASH-25823 1C34-18045-JA AT-766	oio	89414
88-97	F53 Chassis with 16,000 lb GVW to 22,000 lb GVW 83000 Series	ASH-1229 HU94-18045-AA ASH-1228 9U94-18045-AA ASH-1205 AT-620 ASH-1022 HU9Z-18124-B HU9Z-18124-C HU94-18045-BA ASH-294 9U9Z-18124-A 9U9Z-18124-B ASH-25822 ASH-25823 1C34-18045-JA AT-766	oio	83209

APPLICATION GUIDE

Year	Fitment Notes	OEM#								
			Fleetline/ Gas SLX	Classic/ Ultra/ ProGuard/ Guardian	Max Control/ LTV Severe Duty/ Load Carrier	Steering Dampers/ Steering Stabilizer/ Cab Shock	Fleetline/ Gas SLX	Classic/ Ultra/ ProGuard/ Guardian	Max Control/ LTV Severe Duty/ Load Carrier/ HiJackers	Steering Dampers/ Steering Stabilizer/ Cab Shock

FORD

FORD

F-53 (cont)

88-97	F53 Chassis with 16,000 lb GVW to 22,000 lb GVW 89000 Series	ASH-1229 HU94-18045-AA ASH-1228 9U94-18045-AA ASH-1205 AT-620 ASH-1022 HU9Z-18124-B HU9Z-18124-C HU94-18045-BA ASH-294 9U9Z-18124-A 9U9Z-18124-B ASH-25822 ASH-25823 1C34-18045-JA AT-766	89414	OO
-------	--	---	-------	------	------	------	----	------	------	------	------

F-59 COMMERCIAL STRIPPED CHASSIS

24	MotorHomes with Ford F59 Commercial Chassis with 24,000 lb GVW to 26,000 lb GVW 85000 Series	ASH-25821 ASH-1161 HU9Z-18124-A	85006	OO
11-23	MotorHomes with Ford F59 Commercial Chassis with 24,000 lb GVW to 26,000 lb GVW	ASH-25821 ASH-1161 HU9Z-18124-A	85006	OO
11-21	F59 Commercial Chassis with 16,000 lb or 19,500 GVW	471700009775 CU9Z-18125-A ASH-12261 ASH-24523 ASH-24589 DU94-18080-CA BU9Z-18125-A 471700007117 ASH-24474 DU94-18080-CB DU9Z-18125-A DU9Z-18125-B	OO	85010
	F59 Commercial Chassis with 16,000 lb to 22,000 GVW	ASH-12251 CU9Z-18124-A ASH-24473 BU9Z-18124-A ASH-24522 ASH-24634 DU9Z-18124-A DU9Z-18124-B	85013	OO
89-97	F59 Commercial Chassis with 16,000 lb or 19,500 GVW	471700009775 CU9Z-18125-A ASH-12261 ASH-24523 ASH-24589 DU94-18080-CA BU9Z-18125-A 471700007117 ASH-24474 DU94-18080-CB DU9Z-18125-A DU9Z-18125-B	OO	85010
	F59 Commercial Chassis with 16,000 lb to 22,000 GVW	ASH-12251 CU9Z-18124-A ASH-24473 BU9Z-18124-A ASH-24522 ASH-24634 DU9Z-18124-A DU9Z-18124-B	85013	OO

F-200



86-90	All		I O	81490	OO
-------	-----	--	--------	------	-------	------	------	----	------	------	------

F-250 HD

97	All		OO	OO	77809	
	4WD		OO	61614 81821 G63455	77414 ⁶	OO	61530 81510 G63461	77461

⁶ It is recommended that when replacing shocks on vehicles with "quad shocks" all 4

APPLICATION GUIDE

Year	Fitment Notes	OEM#								
			Fleetline\ Gas SLX	Classic\ Ultra\ ProGuard\ Guardian	Max Control\ LTV Severe Duty\ Load Carrier	Steering Dampers\ Steering Stabilizer\ Cab Shock	Fleetline\ Gas SLX	Classic\ Ultra\ ProGuard\ Guardian	Max Control\ LTV Severe Duty\ Load Carrier\ HiJackers	Steering Dampers\ Steering Stabilizer\ Cab Shock

FORD

FORD

F-250 HD (cont)

97	RWD			O	O	61520 81490 G63414		O	O	61547 81082 G63809	43167*
----	-----	--	--	---	---	------	--------------------------	------	------	--	---	---	------	--------------------------	--------	------

F-600 SUPER DUTY

20-24	All	KC3Z-3E651-C		O	O	14072		O	O	
	Applications with OEM Number	PC3Z-18124-AGA PC3Z-18124-ARA PC3Z-18124-AKA		O	O	G63622		O	O	
		PC3Z-18124-SBA, PC3Z-18124-JA		O	O	G63886	77967		O	O
	4 X 2, Models with RWD and OEM number	HC3Z-18125-B, HC3Z-18125-ED, EC3Z-18125-EE, EC3Z-18125-EF, PC3Z-18125-CFA, PC3Z-18125-CEA		O	O		O	O	77987



LN600

80-85	Models with 11000, 13000, 15000, 17000 lb Axles	D7HT-18080-BA		O	O		O	O	83225
	Models with 3000, 3300 lb Springs and 5000, 5500, 6000, 7000 lb Axles	D7HT-18045-GA		O	O	83308		O	O
	Models with 4400 lb Spring and 7000, 9000 lb Axles	D2EF-18045-AA		O	O	83312		O	O

PICKUP 3/4 TON, F-250 / SUPERDUTY

23-24	4WD	PC3Z-18124-SDA, PC3Z-18124-BBA, PC3Z-18124-BCA, PC3Z-18124-BFA, PC3Z-18124-DAA, PC3Z-18124-SAA, PC3Z-18124-DBA, PC3Z-18124-SCA		O	O	G63886	77951		O	O
	RWD	PC3Z-18124-AFA PC3Z-18124-AEA PC3Z-18124-AHA		O	O	G63622		O	O
		PC3Z-18124-SDA, PC3Z-18124-BBA, PC3Z-18124-BCA, PC3Z-18124-BFA, PC3Z-18124-DAA, PC3Z-18124-SAA, PC3Z-18124-DBA, PC3Z-18124-SCA		O	O	58807 77807		O	O
22-24	4WD	KC3Z-3E651-C		O	O	14072		O	O
24	4WD			O	O	61680		O	O
		PC3Z-18125-Y, PC3Z-18125-BA, PC3Z-18125-AA, PC3Z-18125-K, PC3Z-18125-X, PC3Z-18125-DA, PC3Z-18125-S, PC3Z-18125-CA, PC3Z-18125-J		O	O		O	O	77988
	RWD	PC3Z-18125-CFA, PC3Z-18125-CCA, PC3Z-18125-CEA, PC3Z-18125-CDA		O	O		O	O	G64269
23	4WD			O	O	61680		O	O	G64268	77988
	RWD			O	O		O	O	G64269
17-22	RWD			O	O	58807 77807		O	O	G64269
	RWD, Exc. Off Road			O	O	G63622		O	O
22	4WD			O	O	61680 G63886	77951		O	O	G64268	77988

APPLICATION GUIDE

Year	Fitment Notes	OEM#								
			Fleetline/ Gas SLX	Classic/ Ultra/ ProGuard/ Guardian	Max Control/ LTV Severe Duty/ Load Carrier	Steering Dampers/ Steering Stabilizer/ Cab Shock	Fleetline/ Gas SLX	Classic/ Ultra/ ProGuard/ Guardian	Max Control/ LTV Severe Duty/ Load Carrier/ HiJackers	Steering Dampers/ Steering Stabilizer/ Cab Shock

FORD

FORD

PICKUP 3/4 TON, F-250 / SUPERDUTY (cont)

17-21	4WD		I O	61680 G63886	77951	14072	I O	G64268	77988
13-16	4WD		I O	61680 G63886	77951	14072	I O	61682	77952
	RWD		I O	58807 77807	I O	G63888
12-16	RWD, w/ Off Road Package		I O	G63886	I O	61682
11-16	RWD, Exc. Off Road		I O	G63622	I O	61713 G64010
11-12	RWD		I O	58807 77807	I O
08-12	4WD		I O	61680 G63886	77951	14072	I O	61682 G63888	77952
05-10	RWD		I O	G63622	58807 77807	I O	G64010
00-10	Steering Stabilizer		I O	6828SE ⁸⁰								
10	RWD, Exc. Off Road		I O	I O	61713
05-09	RWD, Exc. Off Road		I O	G63622	I O	61713
99-09	RWD, w/ Off Road		I O	G63886	I O
05-07	4WD		I O	61680 G63886	77951	I O	61682 G63888	77952
	4WD, Exc. OE Unit		I O	6856SE ⁸⁶								
01-04	4WD		I O	61655 61680 G63809 G63886	58809 77809 77951	I O	61656 G63810	58810 77810
99-04	4WD; Replacement Kit		I O	6855SE ⁸²								
	Exc. OE Unit		I O	6850SE ⁸⁶								
	RWD		I O	G63622	58807 77807	I O	61654 G63808	58808 77808
	RWD, Exc. Off Road		I O	G63622	I O
99-03	4WD; With OE Unit		I O	6854SE ⁸⁰								
00	4WD		I O	61655 G63809	58809 77809	I O	61656 G63810	58810 77810
97-99	4WD, Up through 8500# GVW		I O	61613 81914 G63716	77716	I O	61612 81913 G63715	77715
	RWD, Up through 8500# GVW		I O	61611 81912 G63714	58714 77714	I O	61638 81892 G63778	49237 ⁷
99	4WD		I O	61655 61680 G63809 G63886	58809 77809 77951	I O	61656 G63810	58810 77810
	Steering Stabilizer		I O	6828SE ⁸⁰	6828SE ⁸⁰ 6861SE ⁸²	6828SE ⁸⁰ 6861SE ⁸²	6828SE ⁸⁰ 6861SE ⁸²	I O	6828SE ⁸⁰ 6861SE ⁸²	6828SE ⁸⁰ 6861SE ⁸²	6828SE ⁸⁰ 6861SE ⁸²
98	4WD, Over 8500# GVW		I O	61614 G63455	77455	I O
	Steering Stabilizer		I O	6861SE ⁸²								
97	4WD, Over 8500# GVW		I O	61614 81821 G63455	77455	I O	61530 81510 G63461	77461
	RWD, Over 8500# GVW		I O	61520 ⁶ 81490 G63414	77414 ⁶	I O	61547 81082 G63809	43167 ⁸ 77809
	Steering Stabilizer		I O	6828SE ⁸⁰	6828SE ⁸⁰ 6861SE ⁸²	6828SE ⁸⁰ 6861SE ⁸²	6828SE ⁸⁰ 6861SE ⁸²	I O	6828SE ⁸⁰ 6861SE ⁸²	6828SE ⁸⁰ 6861SE ⁸²	6828SE ⁸⁰ 6861SE ⁸²

6 It is recommended that when replacing shocks on vehicles with "quad shocks" all 4 shocks should be matched by series.;
8 Pair Packs.;



7 Pair Packs, Air hose kit included.;

80 Mounting bracket not required, install on O.E. Shock Mounts. See Ref. C for optional Steering Stabilizer Boots.;

82 Use kit if listed, See Ref. C for optional Steering Stabilizer Boots.;

86 Exc. OE Unit;

APPLICATION GUIDE

Year	Fitment Notes	OEM#								
			Fleetline\ Gas SLX	Classic\ Ultra\ ProGuard\ Guardian	Max Control\ LTV Severe Duty\ Load Carrier	Steering Dampers\ Steering Stabilizer\ Cab Shock	Fleetline\ Gas SLX	Classic\ Ultra\ ProGuard\ Guardian	Max Control\ LTV Severe Duty\ Load Carrier\ HiJackers	Steering Dampers\ Steering Stabilizer\ Cab Shock

FORD

FORD

PICKUP 3/4 TON, F-250 / SUPERDUTY (cont)

92-96	Steering Stabilizer			6828SE ⁸⁰								
87-96	4WD			61614 81821 G63455	77455	61530 81510 G63461	77461
80-96	4WD; Single System Steering Stabilizer			6802SE ⁸⁴								
	RWD			61520 ⁶ 81490 G63414	77414 ⁶	61547 81082 G63809	43167 ⁸ 77809
96	RWD, Up through 8500# GVW			61611	58714 77714
86	4WD			81510 G63461
	4WD, Clevis Type Lower Front Mount; Exc. Dual Rear Wheels or Lift Kit			61530	77461
82-85	4WD, Clevis Type Lower Front Mount; Exc. Dual Rear Wheels or Lift Kit			61530 81510 G63461	77461
80-82	4WD, Standard Cab Pickup			G63410
82	4WD			61546 ⁶
80-81	4WD			61546 ⁶	61530 81510 G63461	77461
77-79	4WD; Standard Cab, Cab & Chassis; All From Serial No. Y20001			G63387	49178 ⁷
75-79	RWD			G63386
	RWD, Cab & Chassis			81242 G63350	43058 ⁸ 49127 ⁷
	RWD, Crew Cab Pickup			61518
	RWD, Extended Cab Pickup			61519 81484 G63377	43058 ⁸ 49127 ⁷
	RWD, Standard Cab Pickup			81242 G63350	43099 ⁸ 49173 ⁷
	RWD; Single System Steering Stabilizer			6802SE ⁸⁴								
70-79	RWD, 4WD Quad Suspension Rearward of Front Axle			34058 ⁸
	RWD; Quad Suspension Rearward of Front Axle			61521 ⁶
68-78	4WD; Up through Serial No. Y2000			82034
	4WD; Up through Serial No. Y20000			82147
75-77	Single System Steering Stabilizer			6803SE ⁸⁴								
71-74	RWD; Exc. Extended Cab & Chassis Cab			49173 ⁷
70-74	RWD; Exc. Supercab			81242
	RWD; Standard Cab Pickup			43099 ⁸
65-74	RWD, 4WD Quad Suspension Rearward of Front Axle, Non Quad Suspension			G63386
	RWD; Exc. Supercab			G63350
	RWD; Supercab			G63377
	RWD			61518	43058 ⁸

6 It is recommended that when replacing shocks on vehicles with "quad shocks" all 4 shocks should be matched by series.;

8 Pair Packs.;

84 Replacement damper for vehicles with the Gabriel Aftermarket mounting kit;

7 Pair Packs, Air hose kit included.;

80 Mounting bracket not required, install on O.E. Shock Mounts. See Ref. C for optional Steering Stabilizer Boots.;

APPLICATION GUIDE

Year	Fitment Notes	OEM#								
			Fleetline\ Gas SLX	Classic\ Ultra\ ProGuard\ Guardian	Max Control\ LTV Severe Duty\ Load Carrier	Steering Dampers\ Steering Stabilizer\ Cab Shock	Fleetline\ Gas SLX	Classic\ Ultra\ ProGuard\ Guardian	Max Control\ LTV Severe Duty\ Load Carrier\ HiJackers	Steering Dampers\ Steering Stabilizer\ Cab Shock

FORD

FORD

PICKUP 3/4 TON, F-250 / SUPERDUTY (cont)

65-74	RWD; Supercab											
60-74	Steering Stabilizer			6803SE ⁸⁴								
65-69	Supercab											
	RWD; Quad Suspension Rearward of Front Axle											
66-67	4WD; Up through Serial No. Y20000											
61-65	4WD											
61-64	All											
	All											
56-59	All											
53-55	All											

PICKUP 1 TON, F-350 / SUPERDUTY

23-24	4WD	PC3Z-18124-SDA, PC3Z-18124-BBA, PC3Z-18124-BCA, PC3Z-18124-BFA, PC3Z-18124-DAA, PC3Z-18124-SAA, PC3Z-18124-DBA, PC3Z-18124-SCA										
	RWD	PC3Z-18124-AFA, PC3Z-18124-AEA, PC3Z-18124-AHA										
	RWD	PC3Z-18124-SDA, PC3Z-18124-BBA, PC3Z-18124-BCA, PC3Z-18124-BFA, PC3Z-18124-DAA, PC3Z-18124-SAA, PC3Z-18124-DBA, PC3Z-18124-SCA										
22-24	4WD	KC3Z-3E651-C										
24	4WD											
	4WD	PC3Z-18125-Y, PC3Z-18125-BA, PC3Z-18125-AA, PC3Z-18125-K, PC3Z-18125-X, PC3Z-18125-DA, PC3Z-18125-S, PC3Z-18125-CA, PC3Z-18125-J										
	RWD	PC3Z-18125-CFA, PC3Z-18125-CCA, PC3Z-18125-CEA, PC3Z-18125-CDA										
23	4WD											
	RWD											
17-22	RWD											
22	4WD											



6 It is recommended that when replacing shocks on vehicles with "quad shocks" all 4 shocks should be matched by series.;

7 Pair Packs, Air hose kit included.;

8 Pair Packs.;

84 Replacement damper for vehicles with the Gabriel Aftermarket mounting kit;

APPLICATION GUIDE

Year	Fitment Notes	OEM#								
			Fleetline\ Gas SLX	Classic\ Ultra\ ProGuard\ Guardian	Max Control\ LTV Severe Duty\ Load Carrier	Steering Dampers\ Steering Stabilizer\ Cab Shock	Fleetline\ Gas SLX	Classic\ Ultra\ ProGuard\ Guardian	Max Control\ LTV Severe Duty\ Load Carrier\ HiJackers	Steering Dampers\ Steering Stabilizer\ Cab Shock

FORD



FORD

PICKUP 1 TON, F-350 / SUPERDUTY (cont)

22	RWD	PC3Z-18124-SDA, PC3Z-18124-BBA, PC3Z-18124-BCA, PC3Z-18124-BFA, PC3Z-18124-DAA, PC3Z-18124-SAA, PC3Z-18124-DBA, PC3Z-18124-SCA	0	58807	0
17-21	4WD		0	61680 G63886	77951	14072	0	G64268	77988
13-16	All		0	61680 G63886	58807 77807	0
	4WD		0	61680	77951	14072	0	G63888	77952
	4WD, Exc. Off Road		0	G63886	0
	4WD, w/ Off Road Package		0	0	61682
11-16	4WD		0	77951	0
	Exc. Off Road		0	G63622	0
05-16	RWD		0	G63622	58807 77807	0	G64010
	RWD, Exc. Off Road		0	0	61713
11-12	All		0	61680 G63886	77807	0
08-12	4WD		0	61680 G63886	77951	14072	0
05-12	4WD; Single Rear Wheels; Exc. Cab & Chassis		0	0	61682 G63888	77952
99-10	Steering Stabilizer		0	6828SE ⁸⁰								
99-09	All		0	61680 G63886	77807	0
	4WD		0	77951	0
	Exc. Off Road		0	G63622	0
05-07	4WD		0	61680 G63886	77951	0
99-04	4WD		0	61655 G63809	58809 77809	0	61656 G63810	58810 77810
	4WD; Replacement Kit		0	6855SE ⁸²								
	Exc. OE Unit		0	6850SE ⁸⁶								
	RWD		0	G63622	58807 77807	0	61654 G63808	58808 77808
99-03	4WD; With OE Unit		0	6854SE ⁸⁰								
86-97	4WD		0	61614 81821 G63455	77455	0
	4WD, Dual Rear Wheels		0	0	61530 81510 G63461	77461
	4WD, Exc. Dual Rear Wheels		0	0	G63456
80-97	RWD		0	61520 ⁶ 81490 G63414	77414 ⁶	0
	RWD, Dual Rear Wheels		0	0	61554 81710 G63409

6 It is recommended that when replacing shocks on vehicles with "quad shocks" all 4 shocks should be matched by series;
80 Mounting bracket not required, install on O.E. Shock Mounts. See Ref. C for optional Steering Stabilizer Boots;;
82 Use kit if listed, See Ref. C for optional Steering Stabilizer Boots.;;
86 Exc. OE Unit;

APPLICATION GUIDE

Year	Fitment Notes	OEM#								
			Fleetline\ Gas SLX	Classic\ Ultra\ ProGuard\ Guardian	Max Control\ LTV\ Severe Duty\ Load Carrier	Steering Dampers\ Steering Stabilizer\ Cab Shock	Fleetline\ Gas SLX	Classic\ Ultra\ ProGuard\ Guardian	Max Control\ LTV\ Severe Duty\ Load Carrier\ HiJackers	Steering Dampers\ Steering Stabilizer\ Cab Shock

FORD

FORD

PICKUP 1 TON, F-350 / SUPERDUTY (cont)



80-97	RWD, Exc. Dual Rear Wheels		O O	61547 81082 G63809	43167 ⁸ 77809	
97	Steering Stabilizer		O O	6802SE ⁸⁴ 6828SE ⁸⁰	6802SE ⁸⁴ 6828SE ⁸⁰	6802SE ⁸⁴ 6828SE ⁸⁰	6802SE ⁸⁴ 6828SE ⁸⁰	O O	6802SE ⁸⁴ 6828SE ⁸⁰	6802SE ⁸⁴ 6828SE ⁸⁰	6802SE ⁸⁴ 6828SE ⁸⁰	
92-96	RWD; Dual System Steering Stabilizer		O O	6802SE ⁸⁴								
	Steering Stabilizer		O O	6828SE ⁸⁰								
89-91	RWD; Single System Steering Stabilizer		O O	6802SE ⁸⁴								
82-88	RWD; Single System Steering Stabilizer; w/o Anti-Sway Bar		O O	6802SE ⁸⁴								
82-85	4WD, Clevis Type Lower Front Mount; Exc. Dual Rear Wheels or Lift Kit		O O	61530 81510 G63461	77461	
80-81	4WD		O O	61546 ⁶ G63410	O O	61530 81510 G63461	77461
79-81	RWD; Dual System Steering Stabilizer		O O	6802SE ⁸⁴								
75-79	RWD, RWD, 4WD Quad Suspension Rearward of Front Axle, Non Quad Suspension		O O	G63386	O O
	RWD, Cab & Chassis		O O	O O	43099 ⁸ 49173 ⁷
	RWD, Extended Cab Pickup		O O	O O	G63350	43099 ⁸ 49173 ⁷
	RWD, Standard Cab Pickup		O O	O O	61519 81484 G63377	43058 ⁸
	RWD; Supercab		O O	O O	81242
73-79	RWD, 4WD Quad Suspension Rearward of Front Axle		O O	34058 ⁸	O O
	RWD; Standard Cab Pickup		O O	O O	49127 ⁷
67-79	RWD; Extended Cab		O O	O O	61518
	RWD; Quad Suspension Rearward of Front Axle		O O	61521 ⁶ 81394 ⁶	O O
79	4WD		O O	O O	G63387	49178 ⁷
75-78	Dual System Steering Stabilizer		O O	6802SE ⁸⁴								
75-77	Single System Steering Stabilizer		O O	6803SE ⁸⁴								
73-74	RWD; Supercab		O O	O O	G63377
	RWD; Exc. Supercab		O O	O O	61519 81484
	RWD; Supercab		O O	O O	43058 ⁸
67-74	RWD, 4WD Quad Suspension Rearward of Front Axle, Non Quad Suspension		O O	G63386	O O
65-74	Single System Steering Stabilizer; w/ Twin I Beam Axle		O O	6802SE ⁸⁴								
	Steering Stabilizer		O O	6803SE ⁸⁴								
74	RWD, Extended Cab & Chassis Cab		O O	O O	49173 ⁷
	RWD, Supercab		O O	O O	G63350	43099 ⁸
67-73	RWD, Supercab		O O	O O	G63350
65-66	All		O O	81147	O O	61500 G63405	43048 ⁸

6 It is recommended that when replacing shocks on vehicles with "quad shocks" all 4 shocks should be matched by series.;
8 Pair Packs.;

7 Pair Packs, Air hose kit included.;

80 Mounting bracket not required, install on O.E. Shock Mounts. See Ref. C for optional Steering Stabilizer Boots.;

APPLICATION GUIDE

Year	Fitment Notes	OEM#								
			Fleetline\ Gas SLX	Classic\ Ultra\ ProGuard\ Guardian	Max Control\ LTV Severe Duty\ Load Carrier	Steering Dampers\ Steering Stabilizer\ Cab Shock	Fleetline\ Gas SLX	Classic\ Ultra\ ProGuard\ Guardian	Max Control\ LTV Severe Duty\ Load Carrier\ HiJackers	Steering Dampers\ Steering Stabilizer\ Cab Shock

FORD

FORD

PICKUP 1 TON, F-350 / SUPERDUTY (cont)

61-64	All		61500 81147 G63405	43048 ⁸	...
60-64	Steering Stabilizer		6802SE ⁸⁴	6802SE ⁸⁴ 6803SE ⁸⁴	6802SE ⁸⁴ 6803SE ⁸⁴	6802SE ⁸⁴ 6803SE ⁸⁴	6802SE ⁸⁴ 6803SE ⁸⁴	6802SE ⁸⁴ 6803SE ⁸⁴	6802SE ⁸⁴ 6803SE ⁸⁴	6802SE ⁸⁴ 6803SE ⁸⁴
60	All		81270
53-55	All		81676

PICKUP P100

65-67	Single System Steering Stabilizer		6802SE ⁸⁴							
-------	-----------------------------------	--	----------------------	--	--	--	--	--	--	--

PICKUP P350

76	Up through 8000# GVW		...	61500 G63405
68-75	Up through 8000# GVW		...	61500 81147 G63405
68-73	Single System Steering Stabilizer		6802SE ⁸⁴							



PICKUP P400

75-76	Up through 8000# GVW		...	61500 81147 G63405
-------	----------------------	--	-----	--------------------------	-----	-----	-----	-----	-----	-----

PICKUP, F-450 SUPERDUTY

22-24	4 X 4	KC3Z-3E651-C	14072
24	All	PC3Z-18124-CGA, PC3Z-18124-HA, PC3Z-18124-ARA, PC3Z-18124-SGA	77967
	4 X 4, Models with 4WD and OEM number	ASH-85927 LC3Z-18125-W ASH-866127 ASH-866139 HC3Z-18125-EP HC3Z-18125-X PC3Z-18125-F ASH-85789	77986
	RWD, Models with RWD and OEM number	HC3Z-18125-ED HC3Z-18125-EE HC3Z-18125-B ASH-85857	77987
17-23	Models with 4WD and OEM number	ASH-85927 LC3Z-18125-W ASH-866127 ASH-866139 LC3Z-18125-J HC3Z-18125-EP HC3Z-18125-X ASH-85789	77986
	Models with RWD and OEM number	ASH-25770 HC3Z-18125-ED HC3Z-18125-EE HC3Z-18125-B ASH-85857 ASH-85856	77987
13-23	All		77967
17-21	4 X 4		14072
13-16	4 X 2		77968
	4 X 4		14072	...	77969
09-12	All		58944
08-12	4 X 4		14072
07-08	All		...	G63969	58944 77967

APPLICATION GUIDE

Year	Fitment Notes	OEM#								
			Fleetline\ Gas SLX	Classic\ Ultra\ ProGuard\ Guardian	Max Control\ LTV\ Severe Duty\ Load Carrier	Steering Dampers\ Steering Stabilizer\ Cab Shock	Fleetline\ Gas SLX	Classic\ Ultra\ ProGuard\ Guardian	Max Control\ LTV\ Severe Duty\ Load Carrier\ HiJackers	Steering Dampers\ Steering Stabilizer\ Cab Shock

FORD

FORD



PICKUP, F-450 SUPERDUTY (cont)

05-07	4 X 2		0	77968	
	4 X 4		0	77969	
99-07	Models with single or dual rear wheels with 165" or 201" wheel base	AT-611 F81A-18080-DCA AT-610 ASH-23488 ASH-247 F81Z-18125-DC ASH-23486	0	G63461	
05-06	All		0	G63969	77967	
99-04	All		0	61655 G63809	58809 77809	0	77461
	Steering Stabilizer		0	6854SE ⁸⁰								
97	All		0	G63692	0	61554 G63409	43167 ⁸

PICKUP, F-550 SUPERDUTY

24	All	PC3Z-18124-CGA, PC3Z-18124-HA, PC3Z-18124-ARA, PC3Z-18124-SGA	0	77967
	4 X 4		0	14072
	4 X 4, Models with 4WD and OEM number	ASH-85927 LC3Z-18125-W ASH-866127 ASH-866139 HC3Z-18125-EP HC3Z-18125-X PC3Z-18125-F ASH-85789	0	77986
	RWD, Models with RWD and OEM number	ASH-25770 HC3Z-18125-ED HC3Z-18125-EE HC3Z-18125-B ASH-85857 ASH-85856	0	77987
17-23	Models with 4WD and OEM number	ASH-85927 LC3Z-18125-W ASH-866127 ASH-866139 LC3Z-18125-J HC3Z-18125-EP HC3Z-18125-X ASH-85789	0	77986
	Models with RWD and OEM number	ASH-25770 HC3Z-18125-ED HC3Z-18125-EE HC3Z-18125-B ASH-85857 ASH-85856	0	77987
13-23	All		0	77967
23	4 X 4	KC3Z-3E651-C	0	14072
17-22	4 X 4		0	14072
13-16	4 X 2		0	77968
	4 X 4		0	14072	77969
10-12	All		0	58944
08-12	4 X 4		0	14072
05-07	All		0	G63969	77967
	4 X 2		0	77968
	4 X 4		0	77969

APPLICATION GUIDE

Year	Fitment Notes	OEM#								
			Fleetline\ Gas SLX	Classic\ Ultra\ ProGuard\ Guardian	Max Control\ LTV Severe Duty\ Load Carrier	Steering Dampers\ Steering Stabilizer\ Cab Shock	Fleetline\ Gas SLX	Classic\ Ultra\ ProGuard\ Guardian	Max Control\ LTV Severe Duty\ Load Carrier\ HiJackers	Steering Dampers\ Steering Stabilizer\ Cab Shock

FORD

FORD

PICKUP, F-550 SUPERDUTY (cont)

99-07	Models with single or dual rear wheels with 165" or 201" wheel base	AT-611 F81A-18080-DCA AT-610 ASH-23488 ASH-247 F81Z-18125-DC ASH-23486											
99-04	All												
	Steering Stabilizer			6854SE ⁶⁰									

TRANSIT-150

25	All												
23-24	All												
15-22	All												

TRANSIT-250

25	All												
23-24	All												
15-22	All												

TRANSIT-350

25	All												
23-24	All												
15-22	All												

VAN 1/2 TON, ECONOLINE / CLUB WAGON

03-14	All												
02	All												

VAN 3/4 TON, ECONOLINE / CLUB WAGON / SUPERDUTY

03-14	All												
96-04	Steering Stabilizer			6828SE ⁶⁰									
92-02	All												
75-91	RWD, 4WD Quad Suspension Rearward of Front Axle												
	RWD, 4WD Quad Suspension Rearward of Front Axle, Non Quad Suspension												
91	All												
90	All												
88-89	All												
87	All												
86	All												
85	All												

6 It is recommended that when replacing shocks on vehicles with "quad shocks" all 4 shocks should be matched by series.;

8 Pair Packs.;



48 Installation Hardware Included.;

7 Pair Packs, Air hose kit included.;

40 Complete Assembled Unit.;

80 Mounting bracket not required, install on O.E. Shock Mounts. See Ref. C for optional Steering Stabilizer Boots.;

APPLICATION GUIDE

Year	Fitment Notes	OEM#								
			Fleetline/ Gas SLX	Classic/ Ultra/ ProGuard/ Guardian	Max Control/ LTV Severe Duty/ Load Carrier	Steering Dampers/ Steering Stabilizer/ Cab Shock	Fleetline/ Gas SLX	Classic/ Ultra/ ProGuard/ Guardian	Max Control/ LTV Severe Duty/ Load Carrier/ HiJackers	Steering Dampers/ Steering Stabilizer/ Cab Shock

FORD

FORD

VAN 3/4 TON, ECONOLINE / CLUB WAGON / SUPERDUTY (cont)

82-84	All			O		O	G63387	49178'
79-81	All			O	81394		O	G63387	49178'
74-79	QuadraVan Special			O	6803SE ⁸⁴									
75-78	All			O		O	G63387	49178'
69-74	All			O	82012		O	61519 81484 G63377	43058 ⁸ 49127 ⁷
	Single System Steering Stabilizer; with Twin I-Beam Axle			O	6802SE ⁸⁴									

VAN 1 TON, ECONOLINE / CLUB WAGON / SUPERDUTY

21-24	Steering Stabilizer			O	6828SE ⁸⁰									
24	All	8C2Z18124D		O	G63622		O
		8C2Z18125D		O		O	G63623
				O	81744 ⁴⁸	58622 77614		O	61646 81828	49178' 58623 77623
21-23	All			O	81744 ⁴⁸ G63622	58622 77614		O	61646 81828 G63623	49178' 58623 77623
12-19	All			O	81744 ⁴⁸ G63622	34076 ⁸ 58622 77614		O	61646 81828 G63623	49178' 58623
	Exc. Cutaway Chassis			O	77614		O	81828	58623 77623
92-19	Steering Stabilizer			O	6828SE ⁸⁰									
10-11	All			O	61591 81744 ⁴⁸ G63622	34076 ⁸ 58622 77614		O	61646 81828 G63623	49178' 58623
08-11	Exc. Cutaway Chassis			O	58622 77614		O	61646 81828 G63623	58623 77623
09	All			O	61591 81744 ⁴⁸ G63622	34076 ⁸ 58622 77614		O	61646 G63623	49178' 58623
07-08	All			O	61591 81744 ⁴⁸ G63622	34076 ⁸ 58622 77614		O	61646 G63623	49178' 58623 77623
	Cutaway Chassis			O	58622		O	58623
07	Exc. Cutaway Chassis			O	G63622	58622 77614		O	61646 81828 G63623	49178' 58623 77623
04-06	Exc. Cutaway Chassis			O	58622		O	61646 81828 G63623	58623 77623
06	All			O	61591 81744 ⁴⁸ G63622	34076 ⁸ 58622 77614		O	61646 G63623	49178' 58623
04-05	All			O	61591 81744 ⁴⁸ G63622	34076 ⁸ 58622 77614		O	61646 81828 G63623	49178' 58623
92-05	Cutaway Chassis			O	G63622	58622 77614		O	G63623	58623 77623
99-03	All			O	61591 81744 ⁴⁸ G63622	34076 ⁸ 58622 77614		O	61646 81828 G63623	49178' 58623 77623
03	Exc. Cutaway Chassis			O		O	77623
92-98	All			O	61591 81744 ⁴⁸	34076 ⁸		O	61646 81828	49178'
77-91	All			O		O	49178'

7 Pair Packs, Air hose kit included.;



48 Installation Hardware Included;

84 Replacement damper for vehicles with the Gabriel Aftermarket mounting kit;

8 Pair Packs.;

80 Mounting bracket not required, install on O.E. Shock Mounts. See Ref. C for optional Steering Stabilizer Boots.;

APPLICATION GUIDE

Year	Fitment Notes	OEM#								
			Fleetline\ Gas SLX	Classic\ Ultra\ ProGuard\ Guardian	Max Control\ LTV Severe Duty\ Load Carrier	Steering Dampers\ Steering Stabilizer\ Cab Shock	Fleetline\ Gas SLX	Classic\ Ultra\ ProGuard\ Guardian	Max Control\ LTV Severe Duty\ Load Carrier\ HiJackers	Steering Dampers\ Steering Stabilizer\ Cab Shock

FORD

FORD

VAN 1 TON, ECONOLINE / CLUB WAGON / SUPERDUTY (cont)

77-91	RWD, 4WD Quad Suspension Rearward of Front Axle			34058 ⁸
75-91	Cutaway Chassis			G63387
	Cutaway Chassis RWD, 4WD Quad Suspension Rearward of Front Axle, Non Quad Suspension			G63386
	Exc. Cutaway Chassis			49178 ⁷
	Exc. Cutaway Chassis RWD, 4WD Quad Suspension Rearward of Front Axle			34058 ⁸
	Exc. Cutaway Chassis RWD, 4WD Quad Suspension Rearward of Front Axle, Non Quad Suspension			61521 ⁶ 81394
69-74	All			82012	61519 81484 G63377	43058 ⁸ 49127 ⁷

FREIGHTLINER

FREIGHTLINER

B2

05-23	Models with 12000 lb Taperleaf Front Suspension	10-13634-000 10-13211-000		85918
	Models with FAS II (40,000 lb) Rear Air Suspension	16-15817-000 16-13957-000 16-18708-000 481700006848 471700002809 SDA471700002809			85724 89443
05-22	Models with 15,000 lb Rear Suspension	6803260000			83120

FC70

99-04	Models with 10,000 to 18,000 lb Suspension	6803230300 471700003009 10-13759-000 GBL665538		85006
	Models with 6000 to 9000 lb Front axle	6803230200		85043
	Models with FAS II (40,000 lb) Rear Air Suspension	16-15817-000 16-13957-000 16-18708-000			85724 89443

FL50



95-05	Day Cab Suspensions with O.E.M. Number	18-32999-001 18-60295-000 18-30378-000		83006	
	Models with 10,000 to 18,000 lb Suspension	6803230300 471700003009 10-13759-000 GBL665538		85006
	Models with 15,000 lb Rear Suspension	6803260000 GBL654725			83120
	Models with 6000 to 9000 lb Front axle	6803230200		85043
	Models with FAS II (40,000 lb) Rear Air Suspension	16-15817-000 16-13957-000			85724 89443

FL60

96-05	Day Cab Suspensions with O.E.M. Number	18-32999-001 18-60295-000 18-30378-000		83006	
91-05	Models with 10,000 to 18,000 lb Suspension	6803230300 471700003009 10-13759-000 GBL665538		85006

6 It is recommended that when replacing shocks on vehicles with "quad shocks" all 4 shocks 7 Pair Packs, Air hose kit included.; should be matched by series.;
8 Pair Packs.;

APPLICATION GUIDE

Year	Fitment Notes	OEM#								
			Fleetline/ Gas SLX	Classic/ Ultra/ ProGuard/ Guardian	Max Control/ LTV Severe Duty/ Load Carrier	Steering Dampers/ Steering Stabilizer/ Cab Shock	Fleetline/ Gas SLX	Classic/ Ultra/ ProGuard/ Guardian	Max Control/ LTV Severe Duty/ Load Carrier/ HiJackers	Steering Dampers/ Steering Stabilizer/ Cab Shock

FREIGHTLINER

FL60 (cont)

91-05	Models with 6000 to 9000 lb Front axle	6803230200	O	85043
	Models with FAS II (40,000 lb) Rear Air Suspension	16-15817-000 16-13957-000	O	O	85724 89443
	Trucks with Link Cabmate Models FRT153BC-A , FRT106BC or FRT106HD-A	1201-0054 1202-0054	O	83021
	w/ 15000 lb Rear Suspension	6803260000 GBL654725	O	O	83120

FREIGHTLINER



M2

05-21	Models O.E.M. Number 85000 Series	10-13592-000 47170000440	O	85959
05-21	Models with FAS II (40,000 lb) Rear Air Suspension	16-15817-000 16-18708-000 481700006848 471700002809 SDA471700002809	O	O	85724 89443
	Models with Freightliner TufTrac Rear Air Suspension	481700125969 16-15770-000	O	O	85956
	Models with Hendrickson HMX 400/460 Haulmax with 16.5" Saddle	60680-004L 60680-004 H60680-004	O	O	83143
	Models with Hendrickson HMX 400/460 Haulmax with 17.5" & 18.5" Saddle	60680-005L HDR60680-005 60680-005	O	O	83142
	Models with Rear 10000 lb - 15000 lb Low Profile AirLiner	16-18711-000 16-16577-000 471700002996	O	O	85335
	Models with Rear 52" Spring ,10000 lb - 15000 lb	16-16486-000 16-18710-000 471700002995	O	O	83134
	Models with Rear 52" Spring ,18000 lb - 23000 lb	471700002994 16-16442-000 16-18709-000	O	O	83134
05-15	Models with Freightliner Low Profile Rear Air Suspension (18,000 to 40,000 lb)	16-15765-000 471700002993 16-18707-000	O	O	85921
	Models with Freightliner Low Profile Rear Air Suspension (18,000 to 40,000 lb)	16-14259-000 471700002992 16-18706-000	O	O	85331

M2 100

02-10	Models with FAS II (40,000 lb) Rear Air Suspension	16-15817-000 16-18708-000 481700006848 471700002809 SDA471700002809	O	O	85724 89443
	Models with Freightliner Low Profile Rear Air Suspension (18,000 to 40,000 lb)	16-14259-000 471700002992 16-18706-000	O	O	85331
	Models with Freightliner TufTrac Rear Air Suspension	481700125969 16-15770-000	O	O	85956
	Models with Hendrickson HMX 400/460 Haulmax with 16.5" Saddle	60680-004L 60680-004 H60680-004	O	O	83143
	Models with Hendrickson HMX 400/460 Haulmax with 17.5" & 18.5" Saddle	60680-005L HDR60680-005 60680-005	O	O	83142
	Models with Rear 10000 lb - 15000 lb Low Profile AirLiner	16-18711-000 16-16577-000 471700002996	O	O	85335
	Models with Rear 52" Spring ,10000 lb - 15000 lb	16-16486-000 16-18710-000 471700002995	O	O	83134
	Models with Rear 52" Spring ,18000 lb - 23000 lb	471700002994 16-16442-000 16-18709-000	O	O	83134
	Models with Rear 60" Spring ,18000 lb - 23000 lb	16-15765-000 471700002993 16-18707-000	O	O	85921

APPLICATION GUIDE

Year	Fitment Notes	OEM#								
			Fleetline\ Gas SLX	Classic\ Ultra\ ProGuard\ Guardian	Max Control\ LTV Severe Duty\ Load Carrier	Steering Dampers\ Steering Stabilizer\ Cab Shock	Fleetline\ Gas SLX	Classic\ Ultra\ ProGuard\ Guardian	Max Control\ LTV Severe Duty\ Load Carrier\ HiJackers	Steering Dampers\ Steering Stabilizer\ Cab Shock

FREIGHTLINER

FREIGHTLINER

M2 106

09-24	Models with 8000 to 16000 lb Front Axle and Taperleaf Spring	10-13760-000 10-13592-000 47170000440 471700002991 SDA471700002991	010	85959
02-24	Day Cab Models with Spring Suspensions	18-47350-000 18-60766-000 814903003482	010	83040
	Models with FAS II (40,000 lb) Rear Air Suspension	16-15817-000 16-18708-000 481700006848 471700002809 SDA471700002809	010	85724 89443
	Models with Freightliner TufTrac Rear Air Suspension	481700125969 16-15770-000	010	85956
	Models with Hendrickson HMX 400/460 Haulmax with 16.5" Saddle	60680-004L 60680-004 H60680-004	010	83143
	Models with Hendrickson HMX 400/460 Haulmax with 17.5" & 18.5" Saddle	60680-005L HDR60680-005 60680-005	010	83142
02-23	Models with Rear 10000 lb - 15000 lb Low Profile AirLiner	16-18711-000 16-16577-000 471700002996	010	85335
	Models with Rear 52" Spring ,10000 lb - 15000 lb	16-16486-000 16-18710-000 471700002995	010	83134
	Models with Rear 52" Spring ,18000 lb - 23000 lb	471700002994 16-16442-000 16-18709-000	010	83134
	Models with Rear 60" Spring ,18000 lb - 23000 lb	16-15765-000 471700002993 16-18707-000	010	85921
	Models with Reyco 79KB Rear Steel Spring Suspension	19495-01 16725-01	010	83126 89430
02-15	Models with Freightliner Low Profile Rear Air Suspension (18,000 to 40,000 lb)	16-14259-000 471700002992 16-18706-000	010	85331
02-08	Models with 10000 to 12000 lb. Taper-leaf Spring Suspension	10-12390-000	010	85920
	Models with 6000 to 9000 lb Front axle	10-12388-000	010	85920

MT45

98-23	Step Van Models with O.E.M. Number	16-20628-000 471700003011 16-22004-000 471700011302 16-19138-000	010	85058
	Walkin Step Van Models (18 Foot) with O.E.M. Number	16-20552-000 16-16542-000 16-15064-000 471700010991 16-15436-000	010	83154
99-20	MT45 Step Van - w/35" Front Spring	16-15473-000 16-15474-000	010	83157
	MT45 Step Van - w/38" Front Spring	16-15475-000	010	83164
98-20	Models with O.E.M. Number	16-15394-000	010	83120

MT55

	MT55 Models w/8000 lb. flat leaf front suspension 85000 Series	16-17684-000 16-15676-000	010	85058
	MT55 Models w/8000 lb. flat leaf front suspension 89000 Series	16-17684-000 16-15676-000	010	89431
	MT55 Step Van with O.E.M. Number To 2020 83000 Series	16-16542-000 16-15436-000	010	83154
99-24	Models with Freightliner Low Profile Rear Air Suspension	16-18706-000	010	85331
	MT55 Chassis with O.E.M. Number	16-17759-000 471700000447 16-20632-000	010	85919

APPLICATION GUIDE

Year	Fitment Notes	OEM#								
			Fleetline/ Gas SLX	Classic/ Ultra/ ProGuard/ Guardian	Max Control/ LTV Severe Duty/ Load Carrier	Steering Dampers/ Steering Stabilizer/ Cab Shock	Fleetline/ Gas SLX	Classic/ Ultra/ ProGuard/ Guardian	Max Control/ LTV Severe Duty/ Load Carrier/ HiJackers	Steering Dampers/ Steering Stabilizer/ Cab Shock

FREIGHTLINER

FREIGHTLINER

MT55 (cont)

99-20	MT55 Step Van - w/35" Front Spring	16-15473-000 16-15474-000	O	83157
	MT55 Step Van - w/38" Front Spring	16-15475-000	O	83164
99-11	Models with O.E.M. Number	16-16262-000 16-15934-000 16-15705-000	O

SPRINTER 2500

07-18	All		I	G57802 ⁴⁰
02-06	All		I	G56778

SPRINTER 3500

19-20	All		O	G64089
07-18	All		I	G57802 ⁴⁰	G64089

VARIOUS

	M-Line Walk in Van with O.E.M. Number 83000 Series	P117099 MAE 16949	I	83120
	Step Van Models with O.E.M. Number 85000 Series	471700003011 16-19138-000	O	85058
	Step Van Models with O.E.M. Number 89000 Series	471700003011 16-19138-000	O	89431

GMC

GMC



C3500HD

01-02	All		O	61543
91-02	Exc. I Beam Front Axle		O	43163 ⁸
	Exc. I Beam Front Axle		O	58488
91-00	Solid Front Axle		O	61543

C4500 TOPKICK

03-09	C Chassis - Conventional Cab with 15000, 19000, 21000 lb Multileaf Springs	15174902 88982686 22064232	I	85071
	C Chassis - Conventional Cab with 19000, 21000, 23000 lb Taperleaf Springs (EXC Low Profile Vehicle)	22064233	I	83136
	C Chassis - Conventional Cab with Front Shock with O.E.M. Number	88982682 15588554 15887728 19152843 22064230 15123676	I	83136
	Models with Link Cabmate Model GMT560	1201-1043 1202-1043	O	83025
	Truck Cabs with Link Cabmate Model GMC104TK	1201-0054 1202-0054	O	83021
90-02	C Chassis - Conventional Cab with 15000, 19000, 21000 lb Multileaf Springs 85000 Series	15174902 88982686 22064232	I	85071
	C Chassis - Conventional Cab with 19000, 21000, 23000 lb Taperleaf Springs (EXC Low Profile Vehicle) 83000 Series	22064233	I	83136
	C Chassis - Conventional Cab with Front Shock with O.E.M. Number 83000 Series	88982682 15588554 15887728 19152843 22064230 15123676	I	83136

APPLICATION GUIDE

Year	Fitment Notes	OEM#								
			Fleetline\ Gas SLX	Classic\ Ultra\ ProGuard\ Guardian	Max Control\ LTV Severe Duty\ Load Carrier	Steering Dampers\ Steering Stabilizer\ Cab Shock	Fleetline\ Gas SLX	Classic\ Ultra\ ProGuard\ Guardian	Max Control\ LTV Severe Duty\ Load Carrier\ HiJackers	Steering Dampers\ Steering Stabilizer\ Cab Shock

GMC

GMC

C5500 TOPKICK

03-09	C Chassis - Conventional Cab with 15000, 19000, 21000 lb Multileaf Springs	15174902 88982686 22064232			85071
	C Chassis - Conventional Cab with 19000, 21000, 23000 lb Taperleaf Springs (EXC Low Profile Vehicle)	22064233			83136
	C Chassis - Conventional Cab with Front Shock with O.E.M. Number	88982682 15588554 15887728 19152843 22064230 15123676		83136
	Models with Link Cabmate Model GMT560	1201-1043 1202-1043		00		83025
	Truck Cabs with Link Cabmate Model GMC104TK	1201-0054 1202-0054		00		83021
90-02	C Chassis - Conventional Cab with 15000, 19000, 21000 lb Multileaf Springs 85000 Series	15174902 88982686 22064232			85071
	C Chassis - Conventional Cab with 19000, 21000, 23000 lb Taperleaf Springs (EXC Low Profile Vehicle) 83000 Series	22064233			83136
	C Chassis - Conventional Cab with Front Shock with O.E.M. Number 83000 Series	88982682 15588554 15887728 19152843 22064230 15123676		83136

C6000 TOPKICK

90-96	Truck Cabs with Link Cabmate Model GMC104TK	1201-0054 1202-0054		00		83021
-------	---	------------------------	--	----	------	------	------	--	-------	------	------	------

C6500 TOPKICK

03-09	Truck Cabs with Link Cabmate Model GMC104TK	1201-0054 1202-0054		00		83021
97-01	Truck Cabs with Link Cabmate Model GMC104TK	1201-0054 1202-0054		00		83021

C7000 TOPKICK

90-96	Truck Cabs with Link Cabmate Model GMC104TK	1201-0054 1202-0054		00		83021
-------	---	------------------------	--	----	------	------	------	--	-------	------	------	------

C7500 TOPKICK

97-09	Truck Cabs with Link Cabmate Model GMC104TK	1201-0054 1202-0054		00		83021
-------	---	------------------------	--	----	------	------	------	--	-------	------	------	------

PICKUP 3/4 TON, C25 / C2500



88-00	All			00	61544 81668 G63489	34073 ⁸ 58489 77489		00	61543 81667 G63488	43163 ⁸ 49218 ⁷ 58488 77488
85-86	Crew Cab Pickup			00		00	G63366
83-86	All			00	81039		00	81164
	Cab & Chassis			00		00	61524 G63349	43111 ⁸ 49155 ⁷
	Exc. Extended Cab			00	61525 G63355	34036 ⁸		00
	Standard Cab Pickup			00		00	61524 G63349	43111 ⁸ 49155 ⁷
67-86	Single System Steering Stabilizer			00	6802SE ⁸⁴									
73-83	Crew Cab Pickup			00		00	G63366
79-82	Cab & Chassis			00		00	61524 81164 G63349	43111 ⁸ 49155 ⁷

7 Pair Packs, Air hose kit included.;

8 Pair Packs.;

84 Replacement damper for vehicles with the Gabriel Aftermarket mounting kit;

APPLICATION GUIDE

Year	Fitment Notes	OEM#								
			Fleetline/ Gas SLX	Classic/ Ultra/ ProGuard/ Guardian	Max Control/ LTV Severe Duty/ Load Carrier	Steering Dampers/ Steering Stabilizer/ Cab Shock	Fleetline/ Gas SLX	Classic/ Ultra/ ProGuard/ Guardian	Max Control/ LTV Severe Duty/ Load Carrier/ HiJackers	Steering Dampers/ Steering Stabilizer/ Cab Shock

GMC

GMC

PICKUP 3/4 TON, C25 / C2500 (cont)

79-82	Exc. Extended Cab		O	61525 81039 G63355	34036 ⁶	O	
	Standard Cab Pickup		O	O	61524 81164 G63349	43111 ⁸ 49155 ⁷
75-78	Cab & Chassis		O	O	81164	49155 ⁷
	Exc. Extended Cab		O	61525 81039 G63355	34036 ⁶	O	61524 G63349	43111 ⁸
	Standard Cab Pickup		O	O	81164	49155 ⁷
73-74	All		O	61525 81039 G63355	34036 ⁶	O	43111 ⁸ 49155 ⁷
	Exc. Crew Cab & Bonus Cab		O	O	61524 G63349
67-72	Coil(RearSpringType)		O	O	82003	49107 ⁷
72	All		O	61525 81039 G63355	34036 ⁶	O
	Leaf(RearSpringType)		O	O	G63306	49162 ⁷
71	All		O	61525 81039 G63355	34036 ⁶	O	G63306
	Leaf(RearSpringType)		O	O	49162 ⁷
67-70	All		O	61525 81039 G63355	34036 ⁶	O
	Leaf(RearSpringType)		O	O	G63306	49162 ⁷

PICKUP 3/4 TON, K25 / K2500

99-00	9200# GVW with OE Unit - 15059138 15155638		O	6853SE ⁶²								
88-00	All		O	61542 81726 G63609	58609 77609	O	61543 81667 G63488	43163 ⁸ 49218 ⁷ 58488 77488
81-86	Quad Suspension Long Shock; Exc. Lift Kit		O	61522 ⁶ 81496 ⁶	O
73-86	All		O	14017	O
	Exc. Lift Kit		O	O	61524 81164 G63349	43111 ⁸
	Exc. Quad Suspension and Lift Kit		O	61516 81113 ⁶ G63347	O	49155 ⁷
	Single System Steering Stabilizer		O	6804SE ⁸⁰								
67-86	Dual System Steering Stabilizer		O	6802SE ⁸⁴								
69-72	Exc. Quad Suspension and Lift Kit		O	61516 81113 ⁶ G63347	O
67-72	Single System Steering Stabilizer		O	6803SE ⁸⁴								

PICKUP 3/4 TON, R2500

87-89	Crew Cab Pickup		O	O	G63366
	Exc. Crew Cab & Bonus Cab		O	61525 81039 G63355	34036 ⁶	O	61524 81164 G63349	43111 ⁸ 49155 ⁷

6 It is recommended that when replacing shocks on vehicles with "quad shocks" all 4 shocks should be matched by series.;
8 Pair Packs.;





7 Pair Packs, Air hose kit included.;

80 Mounting bracket not required, install on O.E. Shock Mounts. See Ref. C for optional Steering Stabilizer Boots.;

82 Use kit if listed, See Ref. C for optional Steering Stabilizer Boots.;

84 Replacement damper for vehicles with the Gabriel Aftermarket mounting kit;





APPLICATION GUIDE

Year	Fitment Notes	OEM#								
			 Fleetline\ Gas SLX	Classic\ Ultra\ ProGuard\ Guardian	Max Control\ LTV\ Severe Duty\ Load Carrier	Steering Dampers\ Steering Stabilizer\ Cab Shock	 Fleetline\ Gas SLX	Classic\ Ultra\ ProGuard\ Guardian	Max Control\ LTV\ Severe Duty\ Load Carrier\ HiJackers	Steering Dampers\ Steering Stabilizer\ Cab Shock







GMC

GMC

PICKUP 1 TON, C35/3500 (cont)

67-72	All			61525 81039 G63355	34036 ⁶	
	Exc. 11,000# Rear Axle				G63306	49162 ⁷





PICKUP 1 TON, K35 / K3500

88-00	All			61542 81726 G63609	58609 77609		61543 81667 G63488	43163 ⁸ 49218 ⁷ 58488 77488
77-86	All			G63411	14017		61642 81921 G63675	58412 77412
73-74	All			14017	





PICKUP 1 TON, R3500

87-91	All			61525 81039 G63355	34036 ⁶		G63366
-------	-----	--	---	------	--------------------------	--------------------	------	---	------	--------	------	------

PICKUP 1 TON, V3000 / V3500

87-91	All			G63411	14017		61642 81921 G63675	58412 77412
87-88	Quad Suspension Long Shock; Exc. Lift Kit			81496 ⁶	







PICKUP 2500 SERIES

66	All			61525 81039 G63355	
61-62	All			82035	









SAVANA 4500

10-20	All			61685 G63895		61687 G63897	77638
-------	-----	--	---	------	-----------------	------	------	---	------	-----------------	-------	------

SIERRA 2500

99-04	All			58817		61642 81921 G63675	58412 77412
	4WD			61663 81925 G63817	77817	
	4WD; Up through 8600# GVW; Exc. OE Steering Stabilizer			6853SE ⁸²								
	RWD, Exc. Electronic Adjustable Suspension			61641 81920 G63783	77783	

SIERRA 2500 HD



11-24	All			G64148		G64121	43181 ⁸ 77976
01-10	All			58817		61642 81921 G63675	58412 77412
	4WD			61663 G63817	77817	
01-09	9200# GVW with OE Unit - 15059138 15155638			6853SE ⁸²								
01-04	RWD			61641 81920 G63783	77783	

6 It is recommended that when replacing shocks on vehicles with "quad shocks" all 4 7 Pair Packs, Air hose kit included.;

shocks should be matched by series.;

82 Use kit if listed, See Ref. C for optional Steering Stabilizer Boots.;

APPLICATION GUIDE

Year	Fitment Notes	OEM#								
			Fleetline\ Gas SLX	Classic\ Ultra\ ProGuard\ Guardian	Max Control\ LTV Severe Duty\ Load Carrier	Steering Dampers\ Steering Stabilizer\ Cab Shock	Fleetline\ Gas SLX	Classic\ Ultra\ ProGuard\ Guardian	Max Control\ LTV Severe Duty\ Load Carrier\ HiJackers	Steering Dampers\ Steering Stabilizer\ Cab Shock

GMC

GMC

SIERRA 2500 HD CLASSIC

07	All								58412	
	4WD								77412	

SIERRA 3500

01-06	All			61663 G63817	58817 77817			61642 81921 G63675	58412 77412	
-------	-----	--	--	-----------------	----------------	--	--	--------------------------	----------------	--

SIERRA 3500 CLASSIC

07	All			61663	58817			61642	58412 77412	
----	-----	--	--	-------	-------	--	--	-------	----------------	--

SIERRA 3500 HD

11-24	All			G64148				G64121	43181 [®] 77976	
07-10	All							61642 81921 G63675	58412 77412	
	Torsion Bar(FrontSpringType)			61663 G63817	58817 77817					



T5500

97-09	FL1 Tilt Cab with 8100 lb Axle 83000 Series	22165188 22165187 22064804 22064805		83136						
	FL2 Tilt Cab with 5000 to 11000 lb Axle 83000 Series	22166442 22064807		83136						
	FL3 Tilt Cab with 14575 lb Axle 83000 Series	22165189 22064806		83136						
90-06	Tilt Cab with 15000, 19000, 21000 lb Multileaf Springs 85000 Series	15174902 22064232						85071		
92-99	Tilt Cab with 19000, 21000, 23000 lb Taperleaf Springs (EXC Low Profile Veh.) 83000 Series	22064233						83136		
99	Models with Hendrickson Air Suspension (Stamping number 47902-13) 83000 Series	12474915 15963161						83122		
	Models with Hendrickson Air Suspension (Stamping number 47902-13) 89000 Series	12474915 15963161						89406		

T6500

04-09	FL1 Tilt Cab with 8100 lb Axle	22165188 22165187 22064804 22064805		83136						
	FL2 Tilt Cab with 5000 to 11000 lb Axle	22166442 22064807		83136						
	FL3 Tilt Cab with 14575 lb Axle	22165189 22064806		83136						
04-06	Tilt Cab with 15000, 19000, 21000 lb Multileaf Springs	15174902 22064232						85071		
03	FL1 Tilt Cab with 8100 lb Axle 83000 Series	22165188 22165187 22064804 22064805		83136						
	FL2 Tilt Cab with 5000 to 11000 lb Axle 83000 Series	22166442 22064807		83136						
	FL3 Tilt Cab with 14575 lb Axle 83000 Series	22165189 22064806		83136						
	Tilt Cab with 15000, 19000, 21000 lb Multileaf Springs 85000 Series	15174902 22064232						85071		
97-02	FL1 Tilt Cab with 8100 lb Axle	22165188 22165187 22064804 22064805		83136						

APPLICATION GUIDE

Year	Fitment Notes	OEM#								
			Fleetline/ Gas SLX	Classic/ Ultra/ ProGuard/ Guardian	Max Control/ LTV Severe Duty/ Load Carrier	Steering Dampers/ Steering Stabilizer/ Cab Shock	Fleetline/ Gas SLX	Classic/ Ultra/ ProGuard/ Guardian	Max Control/ LTV Severe Duty/ Load Carrier/ HiJackers	Steering Dampers/ Steering Stabilizer/ Cab Shock

GMC

GMC

T6500 (cont)

97-02	FL2 Tilt Cab with 5000 to 11000 lb Axle	22166442 22064807	I T	83136	
	FL3 Tilt Cab with 14575 lb Axle	22165189 22064806	I T	83136	
	Tilt Cab with 15000, 19000, 21000 lb Multileaf Springs	15174902 22064232	I T	85071
97-99	Tilt Cab with 19000, 21000, 23000 lb Taperleaf Springs (EXC Low Profile Veh.)	22064233	I T	83136
99	Models with Hendrickson Air Suspension (Stamping number 47902-13)	12474915 15963161	O O	83122 89406
92-96	Tilt Cab with 19000, 21000, 23000 lb Taperleaf Springs (EXC Low Profile Veh.) 83000 Series	22064233	I T	83136
90-96	Tilt Cab with 15000, 19000, 21000 lb Multileaf Springs 85000 Series	15174902 22064232	I T	85071

VAN 1/2 TON, G / SAVANA

12-14	AWD, Torsion Bar(FrontSpringType)		I N	61683 G63893
08-14	All		O O	G63896	43180 ⁸ 49231 ⁷ 58638
03-14	RWD		O O	77638
	RWD, Coil(FrontSpringType)		I O	61684 G63894
03-11	Exc. Upfitter Package and Cutaway Chassis		O O	61565
	Torsion Bar (FrontSpringType)		I N	61683 G63893
07	All		O O	G63896	43180 ⁸ 49231 ⁷
03-06	All		O O	G63896	43180 ⁸ 49231 ⁷ 58638
96-02	All		I O	61555	61565 G63896	43180 ⁸ 49231 ⁷ 58638
	Exc. 8600# GVW		I O	34073 ⁸
	RWD		I O	81713 ⁵ G63375 ⁵	77375	77638
78-95	All		O O	61517 G63357	58357	61522 81496 G63413	49212 ⁷
70-95	Single System Steering Stabilizer		O O	6802SE ⁸⁴								
71-77	All		O O	61517 G63357	58357	G63306	49162 ⁷
70	All		O O	58357	G63306	49162 ⁷
	Independent Front Suspension		O O	61517 G63357
67-69	All		O O	G63306	49162 ⁷
64-66	All		O O	82003

VAN 1/2 TON, P SERIES



74-80	All		O O	61525 81039 G63355	34036 ⁸	G63366	77662
73	All		O O	61525 81039 G63355	34036 ⁸	61524 81164 G63349	43111 ⁸ 49155 ⁷

5 Use kit No. 140719 to replace O.E. hardware for lower shock absorber mounting when studs break or self-tapping screws are not longer useable.;

7 Pair Packs, Air hose kit included.;

84 Replacement damper for vehicles with the Gabriel Aftermarket mounting kit;

APPLICATION GUIDE

Year	Fitment Notes	OEM#								
			Fleetline\ Gas SLX	Classic\ Ultra\ ProGuard\ Guardian	Max Control\ LTV Severe Duty\ Load Carrier	Steering Dampers\ Steering Stabilizer\ Cab Shock	Fleetline\ Gas SLX	Classic\ Ultra\ ProGuard\ Guardian	Max Control\ LTV Severe Duty\ Load Carrier\ HiJackers	Steering Dampers\ Steering Stabilizer\ Cab Shock

GMC

GMC

VAN 1/2 TON, P SERIES (cont)

68-72	All		010	61525 81039 G63355	34036 ⁸	010	82003
	Coil(RearSpringType)		010	010	49107 ⁷
67	All		010	61525 81039 G63355	34036 ⁸	010	G63306	49162 ⁷

VAN 3/4 TON, G / SAVANA

25	All		010	010	61687
23-24	All	PC3Z-18124-SDA, PC3Z-18124-BBA, PC3Z-18124-BCA, PC3Z-18124-BFA, PC3Z-18124-DAA, PC3Z-18124-SAA, PC3Z-18124-DBA, PC3Z-18124-SCA	010	010	58638
24	All		010	61685 G63895	010	G63897	77638
17-23	All		010	61685 G63895	010	61687 G63897	43180 ⁸ 77638
10-16	All		010	61685	010	61687 G63897	43180 ⁸ 77638
03-16	Coil(FrontSpringType)		010	G63895	010
03-12	Torsion Bar (FrontSpringType)		010	61683 G63893	010
03-09	All		010	010	61687 G63897	43180 ⁸ 77638
96-02	Exc. 8600# GVW		010	61555 81713 ⁵ G63375 ⁵	34073 ⁸ 77375	010	61565 G63638	43180 ⁸ 49231 ⁷ 58638 77638
78-95	Exc. 8600# GVW		010	61517 G63357	58357	010	61522 81496 G63413	49212 ⁷
70-95	Single System Steering Stabilizer		010	6802SE ⁸⁴								
71-77	All		010	61517 G63357	58357	010	G63306	49162 ⁷
67-70	All		010	010	G63306	49162 ⁷
70	Independent Front Suspension		010	61517 G63357	58357	010

VAN 3/4 TON, P SERIES

79-89	All		010	61525 81039 G63355	34036 ⁸	010	G63366
73-78	All		010	61525 81039 G63355	34036 ⁸	010	61524 81164 G63349	43111 ⁸ 49155 ⁷
68-72	All		010	61525 81039 G63355	34036 ⁸	010	G63306	49162 ⁷
67	All		010	82047	010



VAN 1 TON, G / SAVANA

25	All		010	010	61687
----	-----	--	-----	------	------	------	------	-----	------	-------	------	------

5 Use kit No. 140719 to replace O.E. hardware for lower shock absorber mounting when studs break or self-tapping screws are not longer useable;
8 Pair Packs.;

7 Pair Packs, Air hose kit included.;
84 Replacement damper for vehicles with the Gabriel Aftermarket mounting kit;

APPLICATION GUIDE

Year	Fitment Notes	OEM#								
			Fleetline/ Gas SLX	Classic/ Ultra/ ProGuard/ Guardian	Max Control/ LTV Severe Duty/ Load Carrier	Steering Dampers/ Steering Stabilizer/ Cab Shock	Fleetline/ Gas SLX	Classic/ Ultra/ ProGuard/ Guardian	Max Control/ LTV Severe Duty/ Load Carrier/ HiJackers	Steering Dampers/ Steering Stabilizer/ Cab Shock

GMC

GMC

VAN 1 TON, G / SAVANA (cont)

23-24	All	PC3Z-18124-SDA, PC3Z-18124-BBA, PC3Z-18124-BCA, PC3Z-18124-BFA, PC3Z-18124-DAA, PC3Z-18124-SAA, PC3Z-18124-DBA, PC3Z-18124-SCA		58638	
24	All			61685 G63895	G63897	77638	
17-23	All			61685 G63895	61687 G63897	43180 ⁸ 77638	
13-16	All			61685	61687 G63897	43180 ⁸ 77638	
03-16	Coil(FrontSpringType)			G63895	
10-12	All			61685	43180 ⁸ 77638	
03-12	Single Rear Wheels			61687 G63897	
	Torsion Bar (FrontSpringType)			G63893	
04-09	All			43180 ⁸ 77638	
03	All			43180 ⁸	
97-02	All			61555 81713 ⁵ G63375 ⁵	77375	43180 ⁸ 49231 ⁷	
96-02	Exc. 8600# GVW			34073 ⁸	61565 G63638	58638 77638	
96	All			61555 81713 ⁵ G63375 ⁵	58357 77375	43180 ⁸ 49231 ⁷	
	7100, 7400 and 8600# GVW			77638	
	Cutaway Van			G63671	
	Cutaway Van 9200# GVW			G63403	
	Exc. Cutaway Van			61522 ⁸ 81496 G63413	
94-95	Single System Steering Stabilizer; HD with Straight Front Axle & Tilt Hood			6804SE ⁸⁰							
93-95	Cutaway Van 9200# GVW			G63403	77403	
92-95	Cutaway Van			G63671	58403	
79-95	Exc. Cutaway Van			61522 ⁸ 81496 G63413	49212 ⁷	
78-95	All			61517 G63357	58357	
71-95	Single System Steering Stabilizer			6802SE ⁸⁴							
92	Cutaway Van 9200# GVW			77403	
79-91	Cutaway Van			58403	
	Cutaway Van 9200# GVW			G63403	77403	
78	Cutaway Van			61522 ⁸ 81496 G63413	49212 ⁷	
76-77	All			61517 G63357	58357	G63306	49162 ⁷	

5 Use kit No. 140719 to replace O.E. hardware for lower shock absorber mounting when studs break or self-tapping screws are not longer useable.;

7 Pair Packs, Air hose kit included.;



80 Mounting bracket not required, install on O.E. Shock Mounts. See Ref. C for optional Steering Stabilizer Boots.;

6 It is recommended that when replacing shocks on vehicles with "quad shocks" all 4 shocks should be matched by series.;

8 Pair Packs.;

84 Replacement damper for vehicles with the Gabriel Aftermarket mounting kit.;

APPLICATION GUIDE

Year	Fitment Notes	OEM#								
			Fleetline\ Gas SLX	Classic\ Ultra\ ProGuard\ Guardian	Max Control\ LTV Severe Duty\ Load Carrier	Steering Dampers\ Steering Stabilizer\ Cab Shock	Fleetline\ Gas SLX	Classic\ Ultra\ ProGuard\ Guardian	Max Control\ LTV Severe Duty\ Load Carrier\ HiJackers	Steering Dampers\ Steering Stabilizer\ Cab Shock

GMC

GMC

VAN 1 TON, G / SAVANA (cont)

75	110.0 / 279.4(WheelBase)			61517	58357	G63306	49162 ⁷
	125.0 / 317.5(WheelBase)			61517	58357	G63306	49162 ⁷
	146.0 / 370.8(WheelBase)			G63357
71-74	All			61517 G63357	58357	G63306
	Exc. 146" Wheelbase			49162 ⁷

VAN 1 TON, P SERIES

86-99	Motorhome Chassis w/ I-Beam Front Suspension			G63625
85-99	Motorhome Chassis w/ Independent Front Suspension			G63394
75-99	All			G63366	77662
75-90	Cutaway Chassis			61525 81039 G63355	34036 ⁸
85	Motorhome Chassis w/ I-Beam Front Suspension			G63403	58403 77403
75-84	Motorhome Chassis			G63394
73-74	All			G63366
74	Cutaway Chassis			34036 ⁸
	Base, Cutaway Chassis			61525 81039 G63355	77662
	Motorhome			G63394	77662
73	Base, Cutaway Chassis			61525 81039 G63355	34036 ⁸	77662
68-72	All			61525 81039 G63355	34036 ⁸
	Exc. 11,000# Rear Axle			G63306	49162 ⁷
67	All			82047

VAN, PB 1000 SERIES

63-65	All			61525 81039 G63355	34036 ⁸	G63306	49162 ⁷
-------	-----	--	--	------	--------------------------	--------------------	------	--	------	--------	--------------------	------

W4500 FORWARD

92-10	Models with 11000 lb & 13000 lb Suspension	9516306471 97083029 94454987 98232671 97083027 8972536200 8-94454-986-0 8-94454-987-0 97253620 8-97253-620-0 8944549870 8944549860		83515
-------	--	---	--	-------	------	------	------	--	------	------	------	------



W5500 FORWARD

88-10	Models with 11000 lb & 13000 lb Suspension	97253620		83515
-------	--	----------	--	-------	------	------	------	--	------	------	------	------

W6500 FORWARD

87-96	Models with 11000 lb & 13000 lb Suspension	1-51630-168-1		83515
-------	--	---------------	--	-------	------	------	------	--	------	------	------	------

APPLICATION GUIDE

Year	Fitment Notes	OEM#								
			Fleetline/ Gas SLX	Classic/ Ultra/ ProGuard/ Guardian	Max Control/ LTV Severe Duty/ Load Carrier	Steering Dampers/ Steering Stabilizer/ Cab Shock	Fleetline/ Gas SLX	Classic/ Ultra/ ProGuard/ Guardian	Max Control/ LTV Severe Duty/ Load Carrier/ HiJackers	Steering Dampers/ Steering Stabilizer/ Cab Shock

HINO

HINO

145

05-10	Models with O.E.M. Number	S4850-03710 48500-3710A 48500-3710	O O	83126
-------	---------------------------	--	--------	-------	------	------	------	------	------	------	------

155

13-20	Models with O.E.M. Number	48511-80162 48511-37320	I O	83518
		48531-37351		O O	83519

165

05-10	Models with O.E.M. Number	S4850-03710 48500-3710A 48500-3710	O O O	83126
-------	---------------------------	--	-------------	-------	------	------	------	------	------	------	------

185

05-10	Models with O.E.M. Number	S4850-03710 48500-3710A 48500-3710	O O O	83126
		48500-3720 S4850-03720	O O	83140

195

21	Models with O.E.M. Number 83000 Series	48511-80162 48511-37320	I O	83518
		48531-37362 48531-37361		O O	83519
12-20	Models with O.E.M. Number	48511-80162 48511-37320	I O	83518
		48531-37362 48531-37361		O O	83519

238

08-14	Models with Hendrickson Comfort Air (Single Axle - 19K)	48530-E0100 60670-014L 60670-031L 60670-019L 60670-029L	O O	83166
05-14	Models with O.E.M. Number	48500-3720 S4850-03720	O O	83140

258

08-23	Models with Hendrickson Comfort Air (Single Axle - 19K)	48530-E0100 60670-014L 48530-E0390 60670-031L 60670-019L 60670-029L	O O O	83166
15-21	Models with O.E.M. Number	48500-E0420	O O	83391
06-14	Models with O.E.M. Number	48500-3720 S4850-03720	O O	83140



258ALP

08-14	Models with Hendrickson Comfort Air (Single Axle - 19K)	48530-E0100 60670-014L 60670-031L 60670-019L 60670-029L	O O	83166
-------	--	---	--------	------	------	------	------	-------	------	------	------

268

08-23	Models with Hendrickson Comfort Air (Single Axle - 19K)	48530-E0100 60670-014L 48530-E0390 60670-031L 60670-019L 60670-029L	O O O	83166
15-22	Models with O.E.M. Number	48500-E0420	O O	83391
05-14	Models with O.E.M. Number	48500-3720 S4850-03720	O O	83140

APPLICATION GUIDE

Year	Fitment Notes	OEM#								
			Fleetline\ Gas SLX	Classic\ Ultra\ ProGuard\ Guardian	Max Control\ LTV Severe Duty\ Load Carrier	Steering Dampers\ Steering Stabilizer\ Cab Shock	Fleetline\ Gas SLX	Classic\ Ultra\ ProGuard\ Guardian	Max Control\ LTV Severe Duty\ Load Carrier\ HiJackers	Steering Dampers\ Steering Stabilizer\ Cab Shock

HINO

HINO

268, 268A SERIES

	Models with Hendrickson Rear Air Suspension (Shock stamping #) 83000 Series	60670-012	83168
--	---	-----------	-----	-----	-----	-----	-------	-----	-----	-----

268A

08-14	Models with Hendrickson Comfort Air (Single Axle - 19K)	48530-E0100 60670-014L 60670-031L 60670-019L 60670-029L	83166
	Models with O.E.M. Number	48500-3720 S4850-03720	83140

ADDITIONAL APPLICATIONS

	Conventional Hino Models with Hendrickson Comfort Air Suspension (19,000 lb & 21,000 lb Capacity) 83000 Series	60670-013	83148
	Conventional Hino Models with Hendrickson Comfort Air Suspension 83000 Series	60670-020	83148

FA, FB SERIES

98	FA1517, FA1817, FB1817 Ultra Truck Shock	G63419
----	--	-------	-----	-----	-----	-----	-----	--------	-----	-----

FA15

92	FA, FB Models Trucks with:	S4850-01950 48500-1950 48500-2750 S4850-02750 66639	...	G63610
		S4853-02510 S4853-01910 48530-2510 34802 48530-1910	83216

FA1415

93-97	(FA15)	48500-1950	...	G63610
		48530-1910	83216
	FA, FB Models Trucks with:	S4850-01950 48500-1950 48500-2750 S4850-02750 66639	...	G63610
		S4853-02510 S4853-01910 48530-2510 34802 48530-1910	83216
		FA1415 (FA15), FB1715 (FB15)	48500-1950	...	G63610
	48530-1910		83216



FA1517

98-04	FA, FB Models Trucks with:	S4850-01950 48500-1950 48500-2750 S4850-02750 66639	...	G63610
		S4853-02510 S4853-01910 48530-2510 34802 48530-1910	83216
98	All	48530-2510	83216
	FA1517, FA1817, FB1817	48530-2510	83216

FA1817

98	83000 Series	48530-2510	83216
----	--------------	------------	-----	-----	-----	-----	-----	-------	-----	-----

APPLICATION GUIDE

Year	Fitment Notes	OEM#								
			Fleetline/ Gas SLX	Classic/ Ultra/ ProGuard/ Guardian	Max Control/ LTV Severe Duty/ Load Carrier	Steering Dampers/ Steering Stabilizer/ Cab Shock	Fleetline/ Gas SLX	Classic/ Ultra/ ProGuard/ Guardian	Max Control/ LTV Severe Duty/ Load Carrier/ HiJackers	Steering Dampers/ Steering Stabilizer/ Cab Shock

HINO

HINO

FB14

89-91	FA, FB Models Trucks with:	S4850-01950 48500-1950 48500-2750 S4850-02750 66639	↓ O		G63610								
		S4853-02510 S4853-01910 48530-2510 34802 48530-1910	↓ O					O O	83216				

FB15

92	FA, FB Models Trucks with:	S4850-01950 48500-1950 48500-2750 S4850-02750 66639	↓ O		G63610								
		S4853-02510 S4853-01910 48530-2510 34802 48530-1910	↓ O					O O	83216				

FB1715

93-97	FA, FB Models Trucks with:	S4850-01950 48500-1950 48500-2750 S4850-02750 66639	↓ O		G63610								
		S4853-02510 S4853-01910 48530-2510 34802 48530-1910	↓ O					O O	83216				
	FA1415 (FA15), FB1715 (FB15)	↓ O	48500-1950		G63610						O O	83216	

FB1817

98-04	FA, FB Models Trucks with:	S4850-01950 48500-1950 48500-2750 S4850-02750 66639	↓ O		G63610								
		S4853-02510 S4853-01910 48530-2510 34802 48530-1910	↓ O					O O	83216				
	FE Models Trucks with:	S4850-01941 48500-1941	O O	83141									
98	All	48530-2510	↓ O							O O	83216		
		FA1517, FA1817, FB1817	↓ O							O O	83216		

FD16

86-87	Models with O.E.M. Number	48530-1880											
-------	---------------------------	------------	--	--	--	--	--	--	--	--	--	--	--

FD17

88-92	Models with O.E.M. Number	48530-1880											
-------	---------------------------	------------	--	--	--	--	--	--	--	--	--	--	--



FD2218

93-97	(FD5H). FE5H, FF5H	48500-1801	O O	83216									
		48530-1880	↓ O					O O	83215				

FD2218LD

93-97	(FD5H). FE5H, FF5H 83000 Series	48530-1880											
-------	---------------------------------	------------	--	--	--	--	--	--	--	--	--	--	--

APPLICATION GUIDE

Year	Fitment Notes	OEM#								
			Fleetline\ Gas SLX	Classic\ Ultra\ ProGuard\ Guardian	Max Control\ LTV Severe Duty\ Load Carrier	Steering Dampers\ Steering Stabilizer\ Cab Shock	Fleetline\ Gas SLX	Classic\ Ultra\ ProGuard\ Guardian	Max Control\ LTV Severe Duty\ Load Carrier\ HiJackers	Steering Dampers\ Steering Stabilizer\ Cab Shock

HINO

HINO

FD2218LP

93-97	Models with O.E.M. Number	48500-1801	83216
		48530-1880	83215

FE SERIES

98-04	Models Trucks with O.E.M. Number 83000 Series	S4850-01941 48500-1941	83141
-------	---	---------------------------	-------	------	------	------	------	------	------

FE16

86-87	All	48500-1801	83216
-------	-----	------------	-------	------	------	------	------	------	------

FE2620

98	All	48530-1880	83215
----	-----	------------	------	------	------	------	-------	------	------

GC17

90-91	GC17	48500-1801	83216
-------	------	------------	-------	------	------	------	------	------	------

GC20

92	GC20	48500-1801	83216
----	------	------------	-------	------	------	------	------	------	------

L6

22-24	Models with Hendrickson Comfort Air (Single Axle - 19K) 83000 Series	48530-E0100 60670-014L 48530-E0390 60670-031L 60670-019L 60670-029L	83166
	Models with O.E.M. Number 83000 Series	48500-E0420	83391
21	Models with Hendrickson Comfort Air (Single Axle - 19K)	48530-E0100 60670-014L 60670-031L 60670-019L 60670-029L	83166
	Models with O.E.M. Number	48500-E0420	83391

INTERNATIONAL

INTERNATIONAL

200

74-75	Steering Stabilizer						6802SE ⁸⁴		
-------	---------------------	--	--	--	--	--	----------------------	--	--

1200C

68	Exc. 166" Wheelbase		81147 82007	81147	43048 ⁸
	Single System Steering Stabilizer; 1/2 Ton, 3/4 Ton & Travelall						6802SE ⁸⁴			

1200D

69-70	Single System Steering Stabilizer; 1/2 Ton, 3/4 Ton & Travelall						6802SE ⁸⁴		
-------	---	--	--	--	--	--	----------------------	--	--



1210

71-73	Single System Steering Stabilizer; 1/2 Ton, 3/4 Ton & Travelall						6802SE ⁸⁴		
-------	---	--	--	--	--	--	----------------------	--	--

1300C

68	Exc. 166" Wheelbase		81147 82007	81147	43048 ⁸
	Single System Steering Stabilizer; 1/2 Ton, 3/4 Ton & Travelall						6802SE ⁸⁴			

APPLICATION GUIDE

Year	Fitment Notes	OEM#								
			Fleetline\ Gas SLX	Classic\ Ultra\ ProGuard\ Guardian	Max Control\ LTV Severe Duty\ Load Carrier	Steering Dampers\ Steering Stabilizer\ Cab Shock	Fleetline\ Gas SLX	Classic\ Ultra\ ProGuard\ Guardian	Max Control\ LTV Severe Duty\ Load Carrier\ HiJackers	Steering Dampers\ Steering Stabilizer\ Cab Shock

INTERNATIONAL

1300D

69-70	Single System Steering Stabilizer; 1/2 Ton, 3/4 Ton & Travelall		O	O							6802SE ⁸⁴
-------	---	--	---	---	--	--	--	--	--	--	----------------------

1310

71-73	Single System Steering Stabilizer; 1/2 Ton, 3/4 Ton & Travelall		O	O							6802SE ⁸⁴
-------	---	--	---	---	--	--	--	--	--	--	----------------------

4300

02-20	Models with 6,000 to 8,000 lb Front Suspension	3533356C1 3533356C2	O	O	83135							
	Models with Hendrickson HAS - 230 or 460 Rear Air Suspension	60675-003 H60675-003 3514952C1 60675-003L 57905-001								O	O	85976
	Models with O.E.M. Number	2509223C92 2509223C91 2509221C91	O	O					83054			
02-15	Models with 12,000 lb Front axle	3533357C1 3533357C2 3533357C3	O	O	85957							
02-13	Models with 22,000 lb Rear Spring Suspension	501906C91 501906C92 OE13424S	O	O						O	83317	
08-09	Models with 9,000 to 10,000 lb Front Suspension	6127088C1 3578105C2	O	O	83163							
	Models with International 40,000 lb Rear Air Suspension	3549099C2								O	85923 89458	

4300LP

11-18	Models with O.E.M. Number	2509223C92 2509223C91 2509221C91	O	O							83054
13	Models with O.E.M. Number	1660846C92	O	O	83101						
08-09	Models with O.E.M. Number	2509223C92 2509223C91 2509221C91	O	O							83054



4400

02-19	Models with 6,000 to 8,000 lb Front Suspension	3533356C1 3533356C2	O	O	83135							
	Models with Hendrickson HAS - 230 or 460 Rear Air Suspension	60675-003 H60675-003 3514952C1 60675-003L 57905-001								O	O	85976
	Models with O.E.M. Number	2509223C92 2509223C91 2509221C91	O	O					83054			
02-15	Models with 12,000 lb Front axle	3533357C1 3533357C2 3533357C3	O	O	85957							
02-13	Models with 22,000 lb Rear Spring Suspension	501906C91 501906C92 OE13424S	O	O						O	83317	
08-09	Models with 9,000 to 10,000 lb Front Suspension	6127088C1 3578105C2	O	O	83163							
	Models with International 40,000 lb Rear Air Suspension	3549099C2								O	85923 89458	

4400LP

19	Models with O.E.M. Number	2509223C92 2509223C91 2509221C91	O	O							83054
11	Models with O.E.M. Number	2509223C92 2509223C91 2509221C91	O	O							83054

APPLICATION GUIDE

Year	Fitment Notes	OEM#								
			Fleetline\ Gas SLX	Classic\ Ultra\ ProGuard\ Guardian	Max Control\ LTV Severe Duty\ Load Carrier	Steering Dampers\ Steering Stabilizer\ Cab Shock	Fleetline\ Gas SLX	Classic\ Ultra\ ProGuard\ Guardian	Max Control\ LTV Severe Duty\ Load Carrier\ HiJackers	Steering Dampers\ Steering Stabilizer\ Cab Shock

INTERNATIONAL

4400LP (cont)

03-09	Models with O.E.M. Number	2509223C92 2509223C91 2509221C91	OIO	83054
-------	---------------------------	--	-----	------	------	------	-------	------	------	------	------

INTERNATIONAL

CV515

24	Models with 11K, 13.5K or 15.5K VARI-RATE Rear Suspension 83000 Series	4208946C1 4206863C1	OIO	83398
	Models with Taperleaf Front 83000 Series	4109582C1 4089293C1 4109583C1 4207304C1	OIO	83397
19-22	Models with 11K, 13.5K or 15.5K VARI-RATE Rear Suspension	4208946C1 4206863C1	OIO	83398
	Models with 4 x 4 Rear	4109458C2	OIO	83243
	Models with IROS Rear	4214011C2	OIO	85670
	Models with Taperleaf Front	4109582C1 4089293C1 4109583C1 4207304C1	OIO	83397

DURASTAR

16-20	Models with 10,500 or 13,500 lb Vari-Rate Rear Spring Suspension	6127087C1 3586902C2 3586902C3	OIO	83364
	Models with 11,000 lb to 14,000 lb Front axle	6127714C1	OIO	85928
15-20	Models with 6,000 to 8,000 lb Front Suspension	6127688C1 3533356C3	OIO	83169
	Models with Hendrickson HAS - 230 or 460 Rear Air Suspension	60675-003 H60675-003 3514952C1 60675-003L 57905-001	OIO	85976
	Models with O.E.M. Number	2509223C92 2509223C91 2509221C91	OIO	83054
16-19	Models with 20,000 lb International IROS Air Suspension	6127713C1	OIO	85656
15-19	Models with 9,000 to 10,000 lb Front Suspension	6127088C1 OE13402S 3578105C2 3578105C1	OIO	83163
16-17	Models with Vari-Rate Rear Spring Suspension	6127700C1	OIO	83395
15	Models with 12,000 lb Front axle	3533357C1 3533357C2 3533357C3	OIO	85957
13	Models with 12,000 lb Front axle	3533357C1 3533357C2 3533357C3	OIO	85957
	Models with 22,000 lb Rear Spring Suspension	501906C91 501906C92 OE13424S	OIO	83317
	Models with 6,000 to 8,000 lb Front Suspension	6127688C1 3533356C3	OIO	83169
	Models with 9,000 to 10,000 lb Front Suspension	6127088C1 OE13402S 3578105C2 3578105C1	OIO	83163
	Models with Hendrickson HAS - 230 or 460 Rear Air Suspension	60675-003 H60675-003 3514952C1 60675-003L 57905-001	OIO	85976
	Models with O.E.M. Number	2509223C92 2509223C91 2509221C91	OIO	83054

APPLICATION GUIDE

Year	Fitment Notes	OEM#								
			Fleetline/ Gas SLX	Classic/ Ultra/ ProGuard/ Guardian	Max Control/ LTV Severe Duty/ Load Carrier	Steering Dampers/ Steering Stabilizer/ Cab Shock	Fleetline/ Gas SLX	Classic/ Ultra/ ProGuard/ Guardian	Max Control/ LTV Severe Duty/ Load Carrier/ HiJackers	Steering Dampers/ Steering Stabilizer/ Cab Shock

INTERNATIONAL

DURASTAR - 1000 SERIES

1300 Models Ultra Truck Shock	66400 56110-T8123 56110-T8129	I O	G63432
-------------------------------	-------------------------------------	--------	------	--------	------	------	------	------	------	------

INTERNATIONAL

DURASTAR - 4300, 4400 SERIES

	Models with 20,000 lb International IROS Air Suspension To 2015 85000 Series	3578858C1 3578858C2	O O	85656
	Models with International IROS Air Suspension 85000 Series	3553628C1 3553628C2 3553628C3 3553628C4	O O O	85927
	Models with O.E.M. Number 85000 Series	6127690C1	O O	85923
	Models with O.E.M. Number 89000 Series	6127690C1	O O	89458
16-20	Models with 11,000 lb to 14,000 lb Front axle 85000 Series	6127714C1	O O	85928
16-19	Models with 20,000 lb International IROS Air Suspension 85000 Series	6127713C1	O O	85656
13-18	Models with 6,000 to 8,000 lb Front Suspension 83000 Series	6127688C1 3533356C3	O O	83169
10-15	Models with 12,000 lb Front axle 85000 Series	3533357C1 3533357C2 3533357C3	O O	85957
10-12	Models with 6,000 to 8,000 lb Front Suspension 83000 Series	3533356C1 3533356C2	O O	83135
	School Bus models with 6,000 to 8,000 lb Front Suspension 83000 Series	3533356C1 3533356C2	O O	83135
10-11	Models with 40,000 lb Rear Air Suspension 85000 Series	3549099C2	O O	85923
	Models with 40,000 lb Rear Air Suspension 89000 Series	3549099C2	O O	89458

EMV607

23	Models with 12,000 lb Parabolic Taper Leaf Springs 85000 Series	6127714C1	O O	85928
----	---	-----------	--------	-------	------	------	------	------	------	------

M1100 / M1200

68-72	All		O O	82007	O O	61500 81147 G63405	43048 ⁸ 49310 ⁷
	Single System Steering Stabilizer; 1/2 & 3/4 Ton with I-Beam Axle		O O	6802SE ⁸⁴								

M1400

69	All		O O	82007	O O	61500 81147 G63405	43048 ⁸ 49310 ⁷
	Single System Steering Stabilizer; 1/2 & 3/4 Ton with I-Beam Axle		O O	6802SE ⁸⁴								



MV607

20-22	Models with 20,000 lb International IROS Air Suspension	6127713C2	O O	85656
19-22	Models with 11,000 lb to 14,000 lb Taper-leaf Springs	6127714C1	O O	85928
	Models with 6,000 to 8,000 lb Front Suspension	4164146C1 6127688C1	O O	83169
	Models with 9,000 to 10,000 lb Front Suspension	6127088C1	O O	83163

7 Pair Packs, Air hose kit included.;

8 Pair Packs.;

APPLICATION GUIDE

Year	Fitment Notes	OEM#								
			Fleetline\ Gas SLX	Classic\ Ultra\ ProGuard\ Guardian	Max Control\ LTV Severe Duty\ Load Carrier	Steering Dampers\ Steering Stabilizer\ Cab Shock	Fleetline\ Gas SLX	Classic\ Ultra\ ProGuard\ Guardian	Max Control\ LTV Severe Duty\ Load Carrier\ HiJackers	Steering Dampers\ Steering Stabilizer\ Cab Shock

INTERNATIONAL

INTERNATIONAL

MV607 (cont)

19-22	Models with Hendrickson HAS - 230 or 460 Rear Air Suspension	60675-003 H60675-003 3514952C1 60675-003L			85976
	Models with International 21,000 lb Rear Air Suspension	6127666C1			85642

TERRASTAR

12-18	Models with 10,500 or 13,500 lb Vari-Rate Rear Spring Suspension	6127087C1 3586902C2 3586902C3			83364
	Models with 6,000 to 7,000 lb Front Axle	3989717C1 3991991C1 OE 18513 3902993C1 3902993C3 OE17103		83135
14	4 WD Models with Rear Spring Suspension	6127096C1 3945165C1			83180

TRAVELALL

75	Single System Steering Stabilizer			6803SE ⁸⁴							
	Steering Stabilizer			6802SE ⁸⁴							

ISUZU

ISUZU

ADDITIONAL APPLICATIONS

85	KS22 Models (All) 83000 Series	8-97083-027-0		83515
	KS22 Models (All) 85000 Series	9-51630-666-2 9-51630-666-0			85012
	KS22 Models (All) 89000 Series	9-51630-666-2 9-51630-666-0			89413

ALL MODELS WITH

	Models with O.E.M. Number 83000 Series	8-97253-623-0 8-97253-621-0 8-97253-616-0 898098-1270		83515
--	--	--	--	-------	------	------	------	--	------	------	------	------



FRR

00-04	All	1-51630-219-1 1-51630-219-0 51630219		83114
95-98	All	1-51630-219-1 1-51630-219-0 51630219		83114

FSR

97-02	Models with 15000, 19000, 21000 lb Multileaf Springs	8-22064232-0			85071
	Models with 19000, 21000, 23000 lb Taperleaf Springs (EXC Low Profile Veh.)	8-22064233-0			83136
	Models with FL1 Tilt Cab with 8100 lb Axle (Including Low Profile)	8-22064804-0 8-22064805-0		83136
87-96	FSR Models	1-51630-217-1		83114
		1-51630-167-0			83613
87-92	FSR Models	1-51630-160-0		83162
		51630168 1-51630-168-1		83515
86	Models with O.E.M. Number 83000 Series	1-51630-217-1		83114
		1-51630-160-0		83162

APPLICATION GUIDE

Year	Fitment Notes	OEM#								
			Fleetline/ Gas SLX	Classic/ Ultra/ ProGuard/ Guardian	Max Control/ LTV Severe Duty/ Load Carrier	Steering Dampers/ Steering Stabilizer/ Cab Shock	Fleetline/ Gas SLX	Classic/ Ultra/ ProGuard/ Guardian	Max Control/ LTV Severe Duty/ Load Carrier/ HiJackers	Steering Dampers/ Steering Stabilizer/ Cab Shock

ISUZU

ISUZU

FSR (cont)

86	Models with O.E.M. Number 83000 Series	51630168 1-51630-168-1	 O	83515
----	---	---------------------------	-------	-------	------	------	------	------	------	------	------



FTR

18-24	Models with Hendrickson HAS suspension	8-97517-966-1 60670-005 60670-005L 8-97517-966-0		83137
18-20	FTR Diesel Models with Std Cab	8-98321-912-1	 I	85071
00-11	Models with Hendrickson HAS suspension	8-97517-966-1 60670-005 60670-005L 8-97517-966-0	 O	83137
05-09	Models with O.E.M. Number	98098127 8-98232672-0 8-98098-127-0	 O	83515
		98098059 8-98098-059-0 8-98098-059-1 8-98316-228-0	 O	83159
97-09	Models with 19000, 21000, 23000 lb Taperleaf Springs (EXC Low Profile Veh.)	8-22064233-0	 I	83136
90-09	Models with 15000, 19000, 21000 lb Multileaf Springs	15174902 8-22064232-0 88982686	 I	85071
	Models with O.E.M. Number	88982682 8-22064-806-0 8-22064-807-0 15123676	 I	83136
88-96	Models with O.E.M. Number	1-51630-167-0	 I	83613

FVR

	Models with Hendrickson HAS suspension 83000 Series	12474915	 O	83122
	Models with Hendrickson HAS suspension 89000 Series	12474915	 O	89406
10-11	Models with Hendrickson HAS suspension	8-97517-966-1 60670-005 60670-005L 8-97517-966-0	 O	83137
00-08	Models with Hendrickson HAS suspension	8-97517-966-1 60670-005 60670-005L 8-97517-966-0	 O	83137
97-08	Models with 19000, 21000, 23000 lb Taperleaf Springs (EXC Low Profile Veh.)	8-22064233-0	 I	83136
	Models with O.E.M. Number	88982682 15887728 8-22064-806-0 8-22064-807-0 19152843	 I	83136
94-08	Models with 15000, 19000, 21000 lb Multileaf Springs	8-22064232-0 88982686	 I	85071
94-96	FVR Short & Middle Chassis	1-51630-160-0	 O	83162
	Models with O.E.M. Number	1-51630-167-0	 I	83613
90-92	Models with 15000, 19000, 21000 lb Multileaf Springs	8-22064232-0 88982686	 I	85071
88-92	FVR Short & Middle Chassis	1-51630-160-0	 O	83162
	Models with O.E.M. Number	1-51630-167-0	 I	83613

APPLICATION GUIDE

Year	Fitment Notes	OEM#								
			Fleetline\ Gas SLX	Classic\ Ultra\ ProGuard\ Guardian	Max Control\ LTV Severe Duty\ Load Carrier	Steering Dampers\ Steering Stabilizer\ Cab Shock	Fleetline\ Gas SLX	Classic\ Ultra\ ProGuard\ Guardian	Max Control\ LTV Severe Duty\ Load Carrier\ HiJackers	Steering Dampers\ Steering Stabilizer\ Cab Shock

ISUZU

ISUZU



NPR

95-20	Models with O.E.M. Number	98098059 8-97253-665-0 98098058 8-97253-651-2 8-97253-664-0 97253664 98316227 97253665 97253651 8-98098-058-0 8-98098-058-1 8-98098-059-0 8-98098-059-1 8-98316227-0 8-98316-228-0	83159
86-20	Models with O.E.M. Number	8-97253-620-1 98098125 8-98381-012-0 97083029 94454987 98232671 8-98381-010-0 97083027 8-98232671-1 8-98232671-0 97253620 8-94454-647-1 8-97253-620-0 8-98098-125-0 8-97083-027-0 9-51630-647-1 8-97083-029-0 51630647 94454986 8-94454-986-0 8-94454-987-0	83515
86-95	All	9-51630-666-2 51630666 9-51630-666-0	85012 89413
84-85	Models with O.E.M. Number 83000 Series	8-97253-620-1 98098125 8-98381-012-0 97083029 94454987 98232671 8-98381-010-0 97083027 8-98232671-1 8-98232671-0 97253620 8-94454-647-1 8-97253-620-0 8-98098-125-0 8-97083-027-0 9-51630-647-1 8-97083-029-0 51630647 94454986 8-94454-986-0 8-94454-987-0	83515	

NPR-HD

20-23	Models with 14,000 to 15,000 lb Rear	8-98380-746-0	83159
	Models with 15,000 to 16,000 lb Rear	8-98380-747-0	83159
03-23	Models with O.E.M. Number	98098059 8-97253-665-0 98098058 8-98098-058-0 8-98098-058-1 8-98098-059-0 8-98098-059-1 8-98316227-0 8-98316-228-0 98316227 97253665	83159

APPLICATION GUIDE

Year	Fitment Notes	OEM#								
			Fleetline\ Gas SLX	Classic\ Ultra\ ProGuard\ Guardian	Max Control\ LTV Severe Duty\ Load Carrier	Steering Dampers\ Steering Stabilizer\ Cab Shock	Fleetline\ Gas SLX	Classic\ Ultra\ ProGuard\ Guardian	Max Control\ LTV Severe Duty\ Load Carrier\ HiJackers	Steering Dampers\ Steering Stabilizer\ Cab Shock

ISUZU

ISUZU

NPR-HD (cont)

99-23	Models with O.E.M. Number	8-97253-620-1 98098125 8-98381-012-0 97083029 94454987 98232671 8-98381-010-0 97083027 8-98232671-1 8-98232671-0 97253620 8-94454-647-1 8-97253-620-0 8-98098-125-0 8-97083-027-0 9-51630-647-1 8-97083-029-0 51630647 94454986 8-94454-986-0 8-94454-987-0	I O	83515
-------	---------------------------	---	--------	-------	------	------	------	------	------	------	------

NPR-XD

23	Models with 14,000 to 15,000 lb GVW 83000 Series	8-98381-010-0	I O	83515	
		8-98380-746-0	O	83159
	Models with 15,000 to 16,000 lb GVW 83000 Series	8-98381-012-0	I O	83515
		8-98380-747-0	O	83159
15-22	Models with 14,000 to 15,000 lb GVW	8-98381-010-0	I O	83515	
		8-98380-746-0	O	83159
	Models with 15,000 to 16,000 lb GVW	8-98381-012-0	I O	83515
		8-98380-747-0	O	83159



NQR

20-23	Models with 15,000 to 16,000 lb Rear	8-98380-747-0		O	83159
94-23	Models with O.E.M. Number	8-97253-620-1	I O	83515	O
		98098125											
		8-98381-012-0											
		97083029											
		94454987											
		98232671											
		8-98381-010-0											
		97083027											
		8-98232671-1											
		8-98232671-0											
		97253620											
		8-94454-647-1											
		8-97253-620-0											
		8-98098-125-0											
8-97083-027-0													
9-51630-647-1													
8-97083-029-0													
51630647													
94454986													
8-94454-986-0													
8-94454-987-0													
03-19	Models with O.E.M. Number	98098059	O	O	83159
		8-97253-665-0											
		8-98098-059-0											
		8-98098-059-1											
		8-98343986-0											
8-98316-228-0													
97253665													
98343986													
02	Diesel	8-97253-664-0	O	O	83159
		97253664											
95-97	Diesel	8-97253-664-0	O	O	83159
		97253664											

NRR

20-23	Models with 15,000 to 16,000 lb Rear	8-98380-747-0		O	83159
-------	--------------------------------------	---------------	--	------	------	------	------	------	---	-------	------	------	------

APPLICATION GUIDE

Year	Fitment Notes	OEM#								
			Fleetline\ Gas SLX	Classic\ Ultra\ ProGuard\ Guardian	Max Control\ LTV Severe Duty\ Load Carrier	Steering Dampers\ Steering Stabilizer\ Cab Shock	Fleetline\ Gas SLX	Classic\ Ultra\ ProGuard\ Guardian	Max Control\ LTV Severe Duty\ Load Carrier\ HiJackers	Steering Dampers\ Steering Stabilizer\ Cab Shock

ISUZU

ISUZU

NRR (cont)

05-23	Models with O.E.M. Number	8-97253-620-1 98098125 8-98381-012-0 97083029 94454987 98232671 8-98381-010-0 97083027 8-98232671-1 8-98232671-0 97253620 8-94454-647-1 8-97253-620-0 8-98098-125-0 8-97083-027-0 9-51630-647-1 8-97083-029-0 51630647 94454986 8-94454-986-0 8-94454-987-0	 O-I	83515						
05-19	Models with O.E.M. Number	98098059 8-97253-665-0 8-98098-059-0 8-98098-059-1 8-98343986-0 8-98316-228-0 97253665 98343986	 O-I	 O-I	83159
88-94	All	1-51630-219-1 1-51630-217-1 1-51630-217-0 51630217	 O-I	83114	 O-I
	Models with O.E.M. Number	8-97253-620-1 98098125 8-98381-012-0 97083029 94454987 98232671 8-98381-010-0 97083027 8-98232671-1 8-98232671-0 97253620 8-94454-647-1 8-97253-620-0 8-98098-125-0 8-97083-027-0 9-51630-647-1 8-97083-029-0 51630647 94454986 8-94454-986-0 8-94454-987-0	 O-I	83515	 O-I

REACH

11-15	Models with O.E.M. Number	8-98381-010-0	 O-I	83515					
		8-98380-746-0	 O-I	 O-I	83159

KENWORTH

KENWORTH



K270

13-24	Models with 10,000 lb to 12,000 lb Front Axle	1707378PAC BFRG 072	 I	85182						
	Models with Hendrickson HAS - 210L or HAS - 230L Rear Air Suspension	60670-008 60670-008L	 I	 O-I	83123 89405
	Models with Hendrickson HAS - 230 Rear Air Suspension	60670-005 60670-005PLUS-2 60670-005L	 I	 O-I	83137
	Models with Reyco 102 or 79KB Suspension (Drive Axle)	19495-01 16725-01	 I	 O-I	83126 89430

K300

93-05	All with Air Glide 100 Suspension with 8 air bags, 4 units required	K374-29 K374-32	 I					
			 I	85310 89423	 I

APPLICATION GUIDE

Year	Fitment Notes	OEM#								
			Fleetline/ Gas SLX	Classic/ Ultra/ ProGuard/ Guardian	Max Control/ LTV Severe Duty/ Load Carrier	Steering Dampers/ Steering Stabilizer/ Cab Shock	Fleetline/ Gas SLX	Classic/ Ultra/ ProGuard/ Guardian	Max Control/ LTV Severe Duty/ Load Carrier/ HiJackers	Steering Dampers/ Steering Stabilizer/ Cab Shock

KENWORTH

KENWORTH

K300 (cont)

93-05	All with Air Glide 200 with 40,000 lb Suspension with 8 air bags, 4 units required	665903 70701 665944	I T	85900	
	All with Air Glide 200 with 46,000 lb Suspension with 8 air bags, 4 units required	665945 665906	I T	85902	
	K300 COE Medium Duty	665565	O O	85007	
	Models with 12,000 lb Taper Leaf Front Springs (5/8" Top Mounting bolt)	665617 B71-1000	O O	85031	
	Models with Hendrickson Rear Air Suspension	47902-19	O O	O O	83123 89405
	Models with Multiple Leaf Springs on Front Axle (3/4" Mounting bolts)	B71-1003 K374-33 K374-3	O O	83312	O O	83126 89430
	Models with Reyco 102 or 79KB Suspension (Drive Axle)	19495-01 16725-01	O O	O O	83126 89430
	Models with Reyco 1209 or 1212 Suspension (Steer Axle)	19495-01	O O	83126	O O	83126 89430
	Models with Taper Leaf Springs on Front Axle (1" Mounting bolts)	B71-1002 K374-16 K374-27 K374-26	O O	85001	O O	83136
Models with Woodhead Shock (Stamping Number ACHB 966)	ACHB966	O O	I T	83136	



T170

08-22	Models with Reyco 79KB Rear Steel Spring Suspension	19495-01 16725-01	O O	O O	83126 89430
08-13	Models with 8,000 lb Taper Leaf Front Springs	665617	O O	85031	O O	83126 89430

T270

24	Models with AG210L Rear Air Suspension 85000 Series	C71-1017 C71-1011	O O	I T	85069
20-23	Models with Air Glide 400L (AG400L) Rear Air Suspension	C71-1017	O O	I T	85069
08-23	Models with AG210L Rear Air Suspension	C71-1017 C71-1011	O O	I T	85069 89455
	Models with Hendrickson HAS - 210L or HAS - 230L Rear Air Suspension	60670-008 60670-008L	O O	O O	83123 89405
	Models with Hendrickson HMX 400/460 Haulmax with 16.5" Saddle	60680-004L 60680-004 64178-001	O O	I T	83143
15-22	Models with 10,000 lb to 14,600 lb Taperleaf Springs and Set Back Front Axles	B71-6019	O O	85989	O O	83126 89430
	Models with 16,000 lb to 20,000 lb Taperleaf Springs and Set Back Front Axles	B71-6020	O O	85989	O O	83126 89430
08-22	Models with Hendrickson Primaax 230, 232, 460, 462, 690 and 692 Air Suspension (8-1/2" to 10" Ride Height)	60657-003 60657-003L	O O	O O	85072
10-14	Models with 10,000 lb to 12,000 lb Front Axle	B71-6005	O O	85084	O O	83137
	Models with 13,200 lb to 14,600 lb Front Axle	B71-6006	O O	85084	O O	83137
	Models with 8,000 lb Front Axle	B71-6004	O O	85084	O O	83137
08-14	Models with Hendrickson HAS - 400 (Standard) Rear Air Suspension	60670-005 60670-005L	O O	O O	83137
08-10	Models with 12,000 lb Front Axle	665617	O O	85031	O O	83137

APPLICATION GUIDE

Year	Fitment Notes	OEM#								
			Fleetline\ Gas SLX	Classic\ Ultra\ ProGuard\ Guardian	Max Control\ LTV Severe Duty\ Load Carrier	Steering Dampers\ Steering Stabilizer\ Cab Shock	Fleetline\ Gas SLX	Classic\ Ultra\ ProGuard\ Guardian	Max Control\ LTV Severe Duty\ Load Carrier\ HiJackers	Steering Dampers\ Steering Stabilizer\ Cab Shock

KENWORTH

KENWORTH

T280

21-24	Models with Reyco 102 or 79KB Suspension (Drive Axle)	19495-01		OO	83126 89430
24	Models with 10,000 lb to 12,000 lb Mono-leaf front springs	B71-6019	OO	85989

T300

	All with Air Glide 100 Suspension with 8 air bags, 4 units required 85000 Series	K374-29 K374-32			OO	85310
	All with Air Glide 100 Suspension with 8 air bags, 4 units required 89000 Series	K374-29 K374-32			OO	89423
	All with Air Glide 200 with 40,000 lb Suspension with 8 air bags, 4 units required 85000 Series	665903 70701 665944			OO	85900
	Models with Hendrickson Rear Air Suspension 83000 Series	60670-004			OO	83123
	Models with Hendrickson Rear Air Suspension 89000 Series	60670-004			OO	89405
	Models with Multiple Leaf Springs on Front Axle (3/4" Mounting bolts) 83000 Series	B71-1003 K374-33 K374-3	OO	83312
	Models with Multiple Leaf Springs on Front Axle (3/4" Mounting bolts) 89000 Series	B71-1003 K374-33 K374-3	OO	89409
	Models with Reyco 102 or 79KB Suspension (Drive Axle) To 2022 83000 Series	19495-01 16725-01			OO	83126
	Models with Reyco 102 or 79KB Suspension (Drive Axle) To 2022 89000 Series	19495-01 16725-01			OO	89430
	Models with Reyco 1209 or 1212 Suspension (Steer Axle) To 2022 83000 Series	19495-01	OO	83126
	Models with Reyco 1209 or 1212 Suspension (Steer Axle) To 2022 89000 Series	19495-01	OO	89430
	Models with Taper Leaf Springs on Front Axle (1" Mounting bolts) 85000 Series	B71-1002 K374-16 K374-27 K374-26	OO	85001
	Models with Taper Leaf Springs on Front Axle (1" Mounting bolts) 89000 Series	B71-1002 K374-16 K374-27 K374-26	OO	89410
	Models with Woodhead Shock (Stamping Number ACHB 966) 83000 Series	ACHB966			OO	83136
00-08	All with Air Glide 200 with 46,000 lb Suspension with 8 air bags, 4 units required	665945 665906			OO	85902
	Models with 12,000 lb Taper Leaf Front Springs (5/8" Top Mounting bolt)	665617 B71-1000	OO	85031
	Models with Hendrickson HAS - 210L or HAS - 230L Rear Air Suspension	60670-008 60670-008L			OO	83123 89405
	Models with Reyco 102 or 79KB Suspension (Drive Axle)	19495-01 16725-01			OO	83126 89430
	Models with Reyco 1209 or 1212 Suspension (Steer Axle)	19495-01			OO	83126 89430



LEISURE TRAVEL

LEISURE TRAVEL

WONDER

19-22	MotorHomes with Ford Transit-350 Chassis			OO	G57816 ⁴⁰
-------	--	--	--	----	------	----------------------	------	------	--	------	------	------	------

APPLICATION GUIDE

Year	Fitment Notes	OEM#								
			Fleetline/ Gas SLX	Classic/ Ultra/ ProGuard/ Guardian	Max Control/ LTV Severe Duty/ Load Carrier	Steering Dampers/ Steering Stabilizer/ Cab Shock	Fleetline/ Gas SLX	Classic/ Ultra/ ProGuard/ Guardian	Max Control/ LTV Severe Duty/ Load Carrier/ HiJackers	Steering Dampers/ Steering Stabilizer/ Cab Shock

LION

LION

LION6

21-22	Models with Hendrickson Comfort Air Suspension (21K Capacity)	60670-030L 60670-030	O	O	83166
	Trucks with Hendrickson Softek Suspension (12,500 lb Capacity)	58913-010L 58913-010	O	85106	O

MACK

MACK

MD6

24	Models with 10,000 lb Taperleaf Springs	78530771 471700015341	O	83127	O
	Models with O.E.M. Number	23145372	O	83066	O
		23159760	O	O	85188
23	Models with 10,000 lb Taperleaf Springs 83000 Series	78530771 471700015341	O	83127	O
	Models with O.E.M. Number 83000 Series	23145372	O	O	83066
	Models with O.E.M. Number 85000 Series	23159760	O	O	85188
21-22	Models with 10,000 lb Taperleaf Springs	78530771 471700015341	O	83127	O
	Models with O.E.M. Number	23145372	O	83066	O
		23159760	O	O	85188

MARMON HERRINGTON

MARMON HERRINGTON

57 GLIDER

96-97	Conventional Tractors with Link Cabmate Model MARC57-B	1201-0054 1202-0054	O	83021	O
90-94	Conventional Tractors with Link Cabmate Model MARC57-B	1201-0054 1202-0054	O	83021	O

MERCEDES-BENZ

MERCEDES-BENZ

SPRINTER

07-10	All		O	O	G64089
04-06	All		O	G56778	O
	Exc. Dual Rear Wheels		O	O	G63918

SPRINTER 2500

10-18	All		O	G57802 ⁴⁰	O
-------	-----	--	---	------	----------------------	------	------	---	------	------	------	------

SPRINTER 3500

19-20	All		O	O	G64089
11-18	All		O	G57802 ⁴⁰	O	G64089
10	All		O	G57802 ⁴⁰	O

MITSUBISHI FUSO

MITSUBISHI FUSO

FE

96-04	Model with O.E.M. Number	MC114595	O	O	G63405
	Models with O.E.M. Number	MK433638 MA302296	O	G63610	O
87-04	Model with O.E.M. Number	MB161497	O	O	G63299

APPLICATION GUIDE

Year	Fitment Notes	OEM#								
			Fleetline\ Gas SLX	Classic\ Ultra\ ProGuard\ Guardian	Max Control\ LTV Severe Duty\ Load Carrier	Steering Dampers\ Steering Stabilizer\ Cab Shock	Fleetline\ Gas SLX	Classic\ Ultra\ ProGuard\ Guardian	Max Control\ LTV Severe Duty\ Load Carrier\ HiJackers	Steering Dampers\ Steering Stabilizer\ Cab Shock

MITSUBISHI FUSO

MITSUBISHI FUSO

FE145

05-11	Models with O.E.M. Number	MK433638 MK302296	 O	G63610				
-------	---------------------------	----------------------	-------	------	--------	------	------	--	--	--	--

FG

98-04	Model with O.E.M. Number	MC714595		 O	G63405
-------	--------------------------	----------	--	------	------	------	------	-------	------	--------	------	------

FH

97-04	Models with O.E.M. Number	MC826268	 O	G63610				
-------	---------------------------	----------	-------	------	--------	------	------	--	--	--	--

FK

91-94	FK457 Models with O.E.M. Number	MC814614	 O	85009				
88-91	FK455 Models with O.E.M. Number	MC814614	 O	85009				

NISSAN

NISSAN

NV1500

12-19	All			 O	G64164
-------	-----	--	--	------	------	------	------	-------	------	--------	------	------

NV2500

12-19	All			 O	G64164
-------	-----	--	--	------	------	------	------	-------	------	--------	------	------

NV3500

12-19	All			 O	G64164
-------	-----	--	--	------	------	------	------	-------	------	--------	------	------

PETERBILT

PETERBILT



210

08-15	Models with Reyco 102 or 79KB Suspension (Drive Axle)	19495-01 16725-01 TK19679		 O	83126 89430
-------	---	---------------------------------	--	------	------	------	------	-------	----------------	------	------	------

220

13-24	Models with 12,000 lb Front Axle	1707378PAC BFRG 072	 I	85182					
	Models with Hendrickson HAS - 210L or HAS - 230L Rear Air Suspension	60670-008PLUS-2 60670-008 60670-008L		 O	83123 89405
	Models with Reyco 102 or 79KB Suspension (Drive Axle)	19495-01 16725-01 TK19679		 O	83126 89430
13-22	Models with Reyco 102AR (Standard) Rear Air Suspension	12887-02 12887-01		 O	85013 89414
13	Models with 12,000 lb Front Axle	B71-6016A B71-6016 02-02738	 O	85012					
10	Models with 12,000 lb Front Axle	B71-6016A B71-6016 02-02738	 O	85012					
	Models with Hendrickson HAS - 210L or HAS - 230L Rear Air Suspension	60670-008PLUS-2 60670-008 60670-008L		 O	83123 89405
	Models with Reyco 102 or 79KB Suspension (Drive Axle)	19495-01 16725-01 TK19679		 O	83126 89430
	Models with Reyco 102AR (Standard) Rear Air Suspension	12887-02 12887-01		 O	85013 89414
07	Models with 12,000 lb Front Axle	B71-6016A B71-6016 02-02738	 O	85012					
	Models with Hendrickson HAS - 210L or HAS - 230L Rear Air Suspension	60670-008PLUS-2 60670-008 60670-008L		 O	83123 89405
	Models with Reyco 102 or 79KB Suspension (Drive Axle)	19495-01 16725-01 TK19679		 O	83126 89430

APPLICATION GUIDE

Year	Fitment Notes	OEM#								
			Fleetline/ Gas SLX	Classic/ Ultra/ ProGuard/ Guardian	Max Control/ LTV Severe Duty/ Load Carrier	Steering Dampers/ Steering Stabilizer/ Cab Shock	Fleetline/ Gas SLX	Classic/ Ultra/ ProGuard/ Guardian	Max Control/ LTV Severe Duty/ Load Carrier/ HiJackers	Steering Dampers/ Steering Stabilizer/ Cab Shock

PETERBILT

PETERBILT

220 (cont)

07	Models with Reyco 102AR (Standard) Rear Air Suspension	12887-02 12887-01							
----	--	----------------------	--	------	------	------	------	--	--	--	--	--	--

325

08-19	Models with 12000 lb Set Back Front Axle	B71-6016A B71-6016 02-02738											
	Models with Reyco 102 or 79KB Suspension (Drive Axle)	19495-01 TK19679											
08-15	Models with 8,000 lb Front Axle	B71-6004											

330

	Models with O.E.M. Number 85000 Series	B71-6017 02-03020											
--	--	----------------------	--	--	--	--	--	--	--	--	--	--	--

536

22-24	Models with 10,000 lb to 14,600 lb Taperleaf Springs and Set Back Front Axles	B71-6019											
	Models with Air Trac Suspension (40,000 lb)	C71-6003											
	Models with Peterbilt Low Air Leaf Suspension	C71-1017											

PLYMOUTH

PLYMOUTH

VAN 1/2 TON, PB SERIES

81-83	All												
-------	-----	--	--	--	--	--	--	--	--	--	--	--	--

VAN 3/4 TON, PB SERIES

74-83	All												
-------	-----	--	--	--	--	--	--	--	--	--	--	--	--

VAN 1 TON, PB SERIES

74-83	All												
	4000# Front Axle												
	Exc. 4000# Front Axle												

RAM

RAM

1500 CLASSIC

19-22	Old Body Style												
19-20	All												
	4WD, Old Body Style												
	RWD, Old Body Style												
19	4WD												

1500 (SEE DODGE RAM 1500)



16-18	4WD, Exc. Air Suspension												
	RWD, Exc. Air Suspension												

6 It is recommended that when replacing shocks on vehicles with "quad shocks" all 4 shocks should be matched by series.;
8 Pair Packs.;

7 Pair Packs, Air hose kit included.;

35 Slight grinding of control arm opening is required to install product made before Aug 1988.;

APPLICATION GUIDE

Year	Fitment Notes	OEM#								
			Fleetline\ Gas SLX	Classic\ Ultra\ ProGuard\ Guardian	Max Control\ LTV Severe Duty\ Load Carrier	Steering Dampers\ Steering Stabilizer\ Cab Shock	Fleetline\ Gas SLX	Classic\ Ultra\ ProGuard\ Guardian	Max Control\ LTV Severe Duty\ Load Carrier\ HiJackers	Steering Dampers\ Steering Stabilizer\ Cab Shock

RAM

RAM

1500 (SEE DODGE RAM 1500) (cont)

18	All			58412 77412
13-17	All			G63675	58412 77412
11-15	4WD			G51856 G57147 ⁴⁰
	RWD			G64043
12	All			58412 77412
11	All			G63675	58412 77412

2500 (SEE DODGE RAM 2500)

14-20	4WD			G64009	77948
	RWD			77949
	RWD, Standard Cab Pickup			G64043
11-13	All			77950
	4WD			G64009	77948	61716 G64013
	RWD, Standard Cab Pickup			G64043	77949

3500 (SEE DODGE RAM 3500)

21-24	4WD	6842 8082AB, 6844 9356AB, 6844 9675AB, 6844 9676AB, 9844 9357AB, 6844 9677AB, 6847 2701AC		G63673
20-24	All	6845 0002AC, 6845 0108AC, 6844 9857AC, 6844 9366AC, 6844 9673AC, 6844 9358AC, 6844 9360AC		G64121	77976
11-20	4WD			G63673	77948
	RWD			77949
	RWD, Crew Cab Pickup			G63971
	RWD, Standard Cab Pickup			G64043
11-13	All			77950



4500

12-18	Models with O.E.M. Number	05168295AB 05168284AC 6811 1104AB-001 6811 1105AC 6811 1105AC-001 6811 1104AB		85649
		05168296AA 6811 1107AA 6811 1107AA-001		85650

5500

12-18	Models with O.E.M. Number	05168295AB 05168284AC 6811 1104AB-001 6811 1105AC 6811 1105AC-001 6811 1104AB		85649
		05168296AA 6811 1107AA 6811 1107AA-001		85650

APPLICATION GUIDE

Year	Fitment Notes	OEM#								
			Fleetline/ Gas SLX	Classic/ Ultra/ ProGuard/ Guardian	Max Control/ LTV Severe Duty/ Load Carrier	Steering Dampers/ Steering Stabilizer/ Cab Shock	Fleetline/ Gas SLX	Classic/ Ultra/ ProGuard/ Guardian	Max Control/ LTV Severe Duty/ Load Carrier/ HiJackers	Steering Dampers/ Steering Stabilizer/ Cab Shock

RAM

RAM

CV

12-15	All			G57206 ⁴⁰				
	Exc. Load Leveling			O	G64042

PROMASTER 1500

14-25	Left			G57800 ⁴⁰				
	Right			G57801 ⁴⁰				

PROMASTER 2500

14-25	Left			G57800 ⁴⁰				
	Right			G57801 ⁴⁰				

PROMASTER 3500

14-25	Left			G57800 ⁴⁰				
	Right			G57801 ⁴⁰				

PROMASTER CITY

15-21	Left			G57852 ⁴⁰				
	Right			G57853 ⁴⁰				

STERLING TRUCK

STERLING TRUCK



ACTERRA

	Models with 11000 to 12000 lb Front axle 85000 Series	6803230300		O 85006				
03-10	All Models with Freightliner TuffTrac Rear Air Suspension	481700125969 16-15770-000					
	Models with 15000 lb Rear Suspension	6803260000		O	83120
	Models with FAS II (40,000 lb) Rear Air Suspension	16-15817-000 16-13957-000 XC45-18080-BA		O	85724 89443
	Models with Hendrickson Front Airtek	58913-003L 471700131331 58913-003	O	85932				
01-09	Models with 10000 to 12000 lb. Taper-leaf Spring Suspension 85000 Series	10-12390-000	O	85920				
	Models with 10000 to 12000 lb. Taper-leaf Spring Suspension 89000 Series	10-12390-000	O	89503				
	Models with 6000 to 9000 lb Front axle 85000 Series	10-12388-000	O	85920				
	Models with 6000 to 9000 lb Front axle 89000 Series	10-12388-000	O	89503				

ACTERRA 5500

01-07	Models with 15000 lb Rear Suspension	6803260000					
	Models with FAS II (40,000 lb) Rear Air Suspension	16-15817-000 16-13957-000 XC45-18080-BA		O	83120
	Models with Hendrickson Front Airtek	58913-003L 471700131331 58913-003	O	85932				

APPLICATION GUIDE

Year	Fitment Notes	OEM#								
			Fleetline\ Gas SLX	Classic\ Ultra\ ProGuard\ Guardian	Max Control\ LTV Severe Duty\ Load Carrier	Steering Dampers\ Steering Stabilizer\ Cab Shock	Fleetline\ Gas SLX	Classic\ Ultra\ ProGuard\ Guardian	Max Control\ LTV Severe Duty\ Load Carrier\ HiJackers	Steering Dampers\ Steering Stabilizer\ Cab Shock

STERLING TRUCK

ACTERRA 6500

01-07	Models with 15000 lb Rear Suspension	6803260000			83120
	Models with FAS II (40,000 lb) Rear Air Suspension	16-15817-000 16-13957-000 XC45-18080-BA			85724 89443
	Models with Hendrickson Front Airtek	58913-003L 471700131331 58913-003		85932

STERLING TRUCK

BULLET 45

08-10	Models with O.E.M. Number	05168295AB 05168284AC 6811 1104AB-001 6811 1105AC 6811 1105AC-001 6811 1104AB		85649
		05168296AA 6811 1107AA 6811 1107AA-001			85650

BULLET 55

08-10	Models with O.E.M. Number	05168295AB 05168284AC 6811 1104AB-001 6811 1105AC 6811 1105AC-001 6811 1104AB		85649
		05168296AA 6811 1107AA 6811 1107AA-001			85650

UD

UD

1200

99-04	Models with O.E.M. Number	E61000T825 561000T825		83515
-------	---------------------------	--------------------------	--	-------	------	------	------	--	------	------	------	------

1300

05-07	Models with O.E.M. Number	E61000T825 561000T825		83515
-------	---------------------------	--------------------------	--	-------	------	------	------	--	------	------	------	------

1400

94-10	Models with O.E.M. Number	E61000T825 561000T825		83515
-------	---------------------------	--------------------------	--	-------	------	------	------	--	------	------	------	------

1800

89-94	Models with O.E.M. Number	56101-Z5008 56110-Z5008		83114
-------	---------------------------	----------------------------	--	-------	------	------	------	--	------	------	------	------

1800CS

99-04	Models with O.E.M. Number	56101-Z5008 56110-Z5008		83114
-------	---------------------------	----------------------------	--	-------	------	------	------	--	------	------	------	------

2000

89-94	Models with O.E.M. Number	56101-Z5008 56110-Z5008		83114
-------	---------------------------	----------------------------	--	-------	------	------	------	--	------	------	------	------

2600

89-13	Models with O.E.M. Number	56110-Z5014 56110-Z5017 56101-Z5014 56101-Z5017		83162
-------	---------------------------	--	--	-------	------	------	------	--	------	------	------	------



UD 18HD SERIES

99-10	Models with 22.5" Tires Ultra Truck Shock	56110-30Z02 56101-30Z02		G63610
-------	---	----------------------------	--	------	--------	------	------	--	------	------	------	------

UD 1300

99-10	UD 1300 Models Steer Axle Ultra Truck Shock	66400 56110-T8123 56110-T8129		G63432
-------	---	-------------------------------------	--	------	--------	------	------	--	------	------	------	------

APPLICATION GUIDE

Year	Fitment Notes	OEM#								
			Fleetline/ Gas SLX	Classic/ Ultra/ ProGuard/ Guardian	Max Control/ LTV Severe Duty/ Load Carrier	Steering Dampers/ Steering Stabilizer/ Cab Shock	Fleetline/ Gas SLX	Classic/ Ultra/ ProGuard/ Guardian	Max Control/ LTV Severe Duty/ Load Carrier/ HiJackers	Steering Dampers/ Steering Stabilizer/ Cab Shock

UD UD

UD 1800 SERIES

11-13	Models with 22.5" Tires Ultra Truck Shock	56110-30Z02 56101-30Z02	I O	G63610
95-98	Models with 22.5" Tires Ultra Truck Shock	56110-30Z02 56101-30Z02	I O	G63610

UD 2000 SERIES

95-13	Models with 22.5" Tires Ultra Truck Shock	56110-30Z02 56101-30Z02	I O	G63610
-------	---	----------------------------	--------	------	--------	------	------	------	------	------	------	------

UPS TRUCK UPS TRUCK

VARIOUS

	Models with O.E.M. Number 83000 Series	P117099		O T	83120
--	--	---------	--	------	------	------	------	------	--------	-------	------	------	------

WORKHORSE WORKHORSE

W20

04-09	Models with O.E.M. Number	W0005663 F4-BE5-F325-HO 24-153256		I T	85124
01-09	All	24-153249 F4-BE5-B492-HO W0005662 W0006254 24-186629 F4-BE5-A832-MO F4-BE5-F324-HO	O O	85125

W22

04-09	Models with O.E.M. Number	W0005663 F4-BE5-F325-HO 24-153256		I T	85124
01-09	All	24-153249 F4-BE5-B492-HO W0005662 W0006254 24-186629 F4-BE5-A832-MO F4-BE5-F324-HO	O O	85125

W24

04-09	Models with O.E.M. Number	W0005663 F4-BE5-F325-HO 24-153256		I T	85124
	MotorHome Chassis with O.E.M. Number	24-153249 F4-BE5-B492-HO W0005662 W0006254 24-186629 F4-BE5-A832-MO F4-BE5-F324-HO	O O	85125

Numerical listing

Shock	POP	Alternative No.	MTG Acc. Supplied
Pos.	Year	Application	
Steering Dampers			
14017	A		142387
F	77-86	CHEVROLET	PICKUP 1 TON, K30 All
F	73-74	PICKUP 1 TON, K30 All	
F	89-91	PICKUP 1 TON, R3500 All	
F	87-88	PICKUP 1 TON, V30 All	
F	89-91	PICKUP 1 TON, V3000 / V3500 All	
F	73-86	PICKUP 3/4 TON, K20 All	
F	87	PICKUP 3/4 TON, V20 All	
F	77-86	GMC	PICKUP 1 TON, K35 / K3500 All
F	73-74	PICKUP 1 TON, K35 / K3500 All	
F	87-91	PICKUP 1 TON, V3000 / V3500 All	
F	73-86	PICKUP 3/4 TON, K25 / K2500 All	
F	87	PICKUP 3/4 TON, V2500 All	

14072	A		
F	20-24	FORD	F-600 SUPER DUTY All
F	08-24	PICKUP 1 TON, F-350 / SUPERDUTY 4WD	
F	08-24	PICKUP 3/4 TON, F-250 / SUPERDUTY 4WD	
F	08-24	PICKUP, F-450 SUPERDUTY 4 X 4	
F	08-24	PICKUP, F-550 SUPERDUTY 4 X 4	

Steering Stabilizer

Shock	POP	Alternative No.	MTG Acc. Supplied
Pos.	Year	Application	
6802SE	B		141998
F	82-86	CHEVROLET	PICKUP 1 TON, C30 6.2L 8Cyl V (379), 3.98 101.0(Bore)3.82 97.0(Stroke) Single System Steering Stabilizer; w/ Cooler All models with factory frame bracket. Kit 143168 required to install to linkage.
F	75-86	PICKUP 1 TON, C30 4.8L 6Cyl L (292), 3.88 98.4(Bore)4.13 104.8(Stroke) Single System Steering Stabilizer; w/ Cooler All models with factory frame bracket. Kit 143168 required to install to linkage.	
F	75-86	PICKUP 1 TON, C30 5.7L 8Cyl V (350), 4.00 101.6(Bore)3.48 88.5(Stroke) Single System Steering Stabilizer; w/ Cooler All models with factory frame bracket. Kit 143168 required to install to linkage.	
F	80	PICKUP 1 TON, C30 4.1L 6Cyl L (250), 3.68 93.5(Bore)3.91 99.3(Stroke) Single System Steering Stabilizer; w/ Cooler All models with factory frame bracket. Kit 143168 required to install to linkage.	
F	79	PICKUP 1 TON, C30 4.1L 6Cyl L (250) Single System Steering Stabilizer; w/ Cooler All models with factory frame bracket. Kit 143168 required to install to linkage.	
F	76-78	PICKUP 1 TON, C30 6.6L 8Cyl V (400), 4.13 104.8(Bore)3.76 95.5(Stroke) Single System Steering Stabilizer; w/ Cooler All models with factory frame bracket. Kit 143168 required to install to linkage.	
F	78	PICKUP 1 TON, C30 4.1L 6Cyl L (250), 3.68 93.5(Bore)3.91 99.3(Stroke) Single System Steering Stabilizer; w/ Cooler All models with factory frame bracket. Kit 143168 required to install to linkage.	
F	78	PICKUP 1 TON, C30 5.0L 8Cyl V (305), 3.74 94.9(Bore)3.48 88.4(Stroke) Single System Steering Stabilizer; w/ Cooler All models with factory frame bracket. Kit 143168 required to install to linkage.	
F	75	PICKUP 1 TON, C30 4.1L 6Cyl L (250), 3.68 93.5(Bore)3.91 99.3(Stroke) Single System Steering Stabilizer; w/ Cooler All models with factory frame bracket. Kit 143168 required to install to linkage.	
F	73-74	PICKUP 1 TON, C30 All Single System Steering Stabilizer; w/ Cooler All models with factory frame bracket. Kit 143168 required to install to linkage.	
F	61-72	PICKUP 1 TON, C30 All Single System Steering Stabilizer All models with factory frame bracket. Kit 143168 required to install to linkage.	

Steering Dampers, Steering Stabilizer

Shock	POP	Alternative No.	MTG Acc. Supplied
Pos.	Year	Application	
6802SE	B (cont)		141998
F	77-86	PICKUP 1 TON, K30 All Dual System Steering Stabilizer All models with factory frame bracket. Kit 143168 required to install to linkage.	
F	87-88	PICKUP 1 TON, R30 4.8L 6Cyl L (292), 3.88 98.4(Bore)4.13 104.8(Stroke) Single System Steering Stabilizer; w/ Cooler All models with factory frame bracket. Kit 143168 required to install to linkage.	
F	87-88	PICKUP 1 TON, R30 5.7L 8Cyl V (350), 4.00 101.6(Bore)3.48 88.5(Stroke) Single System Steering Stabilizer; w/ Cooler All models with factory frame bracket. Kit 143168 required to install to linkage.	
F	87-88	PICKUP 1 TON, R30 6.2L 8Cyl V (379), 3.98 101.0(Bore)3.82 97.0(Stroke) Single System Steering Stabilizer; w/ Cooler All models with factory frame bracket. Kit 143168 required to install to linkage.	
F	89-91	PICKUP 1 TON, R3500 5.7L 8Cyl V (350), 4.00 101.6(Bore)3.48 88.5(Stroke) Single System Steering Stabilizer; w/ Cooler All models with factory frame bracket. Kit 143168 required to install to linkage.	
F	63-86	PICKUP 3/4 TON, C20 All Single System Steering Stabilizer All models with factory frame bracket. Kit 143168 required to install to linkage.	
F	67-86	PICKUP 3/4 TON, K20 All Dual System Steering Stabilizer All models with factory frame bracket. Kit 143168 required to install to linkage.	
F	87-88	PICKUP 3/4 TON, R20 All Single System Steering Stabilizer All models with factory frame bracket. Kit 143168 required to install to linkage.	
F	89	PICKUP 3/4 TON, R2500 All Single System Steering Stabilizer All models with factory frame bracket. Kit 143168 required to install to linkage.	
F	87	PICKUP 3/4 TON, V20 All Dual System Steering Stabilizer All models with factory frame bracket. Kit 143168 required to install to linkage.	
F	70-95	VAN 1/2 TON, G / EXPRESS All Single System Steering Stabilizer All models with factory frame bracket. Kit 143168 required to install to linkage.	
F	71-95	VAN 1 TON, G / EXPRESS All Single System Steering Stabilizer All models with factory frame bracket. Kit 143168 required to install to linkage.	
F	70-95	VAN 3/4 TON, G / EXPRESS All Single System Steering Stabilizer All models with factory frame bracket. Kit 143168 required to install to linkage.	
F	75-93	DODGE PICKUP 1 TON, D300 SERIES All Single System Steering Stabilizer All models with factory frame bracket. Kit 143168 required to install to linkage.	
F	72-74	PICKUP 1 TON, D300 SERIES All Single System Steering Stabilizer; w/ Coil Spring Front Suspension All models with factory frame bracket. Kit 143168 required to install to linkage.	
F	60-71	PICKUP 1 TON, D300 SERIES All Single System Steering Stabilizer; w/ I-Beam Axle All models with factory frame bracket. Kit 143168 required to install to linkage.	
F	90-93	PICKUP 1 TON, W300 SERIES All Single System Steering Stabilizer All models with factory frame bracket. Kit 143168 required to install to linkage.	

Numerical listing

Shock	POP	Alternative No.	MTG Acc. Supplied
Pos.	Year	Application	
6802SE	B (cont)		141998
F	60-86	PICKUP 1 TON, W300 SERIES All Dual System Steering Stabilizer; Exc. Vacuum Servo Mounted on Drivers Side of Axle All models with factory frame bracket. Kit 143168 required to install to linkage.	
F	73-93	PICKUP 3/4 TON, D200 SERIES All Single System Steering Stabilizer All models with factory frame bracket. Kit 143168 required to install to linkage.	
F	60-71	PICKUP 3/4 TON, D200 SERIES All Single System Steering Stabilizer; w/ I-Beam Axle All models with factory frame bracket. Kit 143168 required to install to linkage.	
F	90-93	PICKUP 3/4 TON, W200 SERIES All Single System Steering Stabilizer All models with factory frame bracket. Kit 143168 required to install to linkage.	
F	60-86	PICKUP 3/4 TON, W200 SERIES All Dual System Steering Stabilizer; Exc. Vacuum Servo Mounted on Drivers Side of Axle All models with factory frame bracket. Kit 143168 required to install to linkage.	
F	71	VAN 1/2 TON, A / B SERIES / RAM All Single System Steering Stabilizer; w/ I-Beam Axle All models with factory frame bracket. Kit 143168 required to install to linkage.	
F	71	VAN 1 TON, A / B SERIES / RAM All Single System Steering Stabilizer; w/ I-Beam Axle All models with factory frame bracket. Kit 143168 required to install to linkage.	
F	71	VAN 3/4 TON, A / B SERIES / RAM All Single System Steering Stabilizer; w/ I-Beam Axle All models with factory frame bracket. Kit 143168 required to install to linkage.	
F	61-67	FORD ECONOLINE VAN Van Single System Steering Stabilizer All models with factory frame bracket. Kit 143168 required to install to linkage.	
F	92-97	PICKUP 1 TON, F-350 / SUPERDUTY RWD Dual System Steering Stabilizer All models with factory frame bracket. Kit 143168 required to install to linkage.	
F	89-91	PICKUP 1 TON, F-350 / SUPERDUTY RWD Single System Steering Stabilizer All models with factory frame bracket. Kit 143168 required to install to linkage.	
F	82-88	PICKUP 1 TON, F-350 / SUPERDUTY RWD Single System Steering Stabilizer; Exc. Anti-Sway Bar All models with factory frame bracket. Kit 143168 required to install to linkage.	
F	79-81	PICKUP 1 TON, F-350 / SUPERDUTY RWD Dual System Steering Stabilizer All models with factory frame bracket. Kit 143168 required to install to linkage.	
F	75-78	PICKUP 1 TON, F-350 / SUPERDUTY All Dual System Steering Stabilizer All models with factory frame bracket. Kit 143168 required to install to linkage.	
F	65-74	PICKUP 1 TON, F-350 / SUPERDUTY All Single System Steering Stabilizer; w/ Twin I Beam Axle All models with factory frame bracket. Kit 143168 required to install to linkage.	
F	60-64	PICKUP 1 TON, F-350 / SUPERDUTY All Single System Steering Stabilizer w/ I Beam Axle All models with factory frame bracket. Kit 143168 required to install to linkage.	
F	80-96	PICKUP 3/4 TON, F-250 / SUPERDUTY 4WD Single System Steering Stabilizer All models with factory frame bracket. Kit 143168 required to install to linkage.	

Numerical listing

Shock	POP	Alternative No.	MTG Acc. Supplied
Pos.	Year	Application	
6802SE	B (cont)		141998
F	75-79	PICKUP 3/4 TON, F-250 / SUPERDUTY RWD Single System Steering Stabilizer All models with factory frame bracket. Kit 143168 required to install to linkage.	
F	65-67	PICKUP P100 All Single System Steering Stabilizer All models with factory frame bracket. Kit 143168 required to install to linkage.	
F	68-73	PICKUP P350 All Single System Steering Stabilizer All models with factory frame bracket. Kit 143168 required to install to linkage.	
F	69-74	VAN 3/4 TON, ECONOLINE / CLUB WAGON / SUPERDUTY All Single System Steering Stabilizer; w/ Twin I-Beam Axle All models with factory frame bracket. Kit 143168 required to install to linkage.	
F	75-86	GMC PICKUP 1 TON, C35/3500 Crew Cab Pickup Single System Steering Stabilizer All models with factory frame bracket. Kit 143168 required to install to linkage.	
F	72-74	PICKUP 1 TON, C35/3500 All Single System Steering Stabilizer All models with factory frame bracket. Kit 143168 required to install to linkage.	
F	67-86	PICKUP 3/4 TON, C25 / C2500 All Single System Steering Stabilizer All models with factory frame bracket. Kit 143168 required to install to linkage.	
F	67-86	PICKUP 3/4 TON, K25 / K2500 All Dual System Steering Stabilizer All models with factory frame bracket. Kit 143168 required to install to linkage.	
F	87-89	PICKUP 3/4 TON, R2500 All Single System Steering Stabilizer All models with factory frame bracket. Kit 143168 required to install to linkage.	
F	87	PICKUP 3/4 TON, V2500 All AN49 All models with factory frame bracket. Kit 143168 required to install to linkage.	
F	70-95	VAN 1/2 TON, G / SAVANA All Single System Steering Stabilizer All models with factory frame bracket. Kit 143168 required to install to linkage.	
F	71-95	VAN 1 TON, G / SAVANA All Single System Steering Stabilizer All models with factory frame bracket. Kit 143168 required to install to linkage.	
F	70-95	VAN 3/4 TON, G / SAVANA All Single System Steering Stabilizer All models with factory frame bracket. Kit 143168 required to install to linkage.	
F	74-75	INTERNATIONAL 200 All Single System Steering Stabilizer All models with factory frame bracket. Kit 143168 required to install to linkage.	
F	68	1200C All Single System Steering Stabilizer; 1/2 Ton, 3/4 Ton & Travelall All models with factory frame bracket. Kit 143168 required to install to linkage.	
F	69-70	1200D All Single System Steering Stabilizer; 1/2 Ton, 3/4 Ton & Travelall All models with factory frame bracket. Kit 143168 required to install to linkage.	
F	71-73	1210 All Single System Steering Stabilizer; 1/2 Ton, 3/4 Ton & Travelall All models with factory frame bracket. Kit 143168 required to install to linkage.	
F	68	1300C All Single System Steering Stabilizer; 1/2 Ton, 3/4 Ton & Travelall All models with factory frame bracket. Kit 143168 required to install to linkage.	
F	69-70	1300D All Single System Steering Stabilizer; 1/2 Ton, 3/4 Ton & Travelall All models with factory frame bracket. Kit 143168 required to install to linkage.	

Steering Stabilizer

Shock	POP	Alternative No.	MTG Acc. Supplied
Pos.	Year	Application	
6802SE	B (cont)		141998
F	71-73	1310 All Single System Steering Stabilizer; 1/2 Ton, 3/4 Ton & Travelall All models with factory frame bracket. Kit 143168 required to install to linkage.	
F	68-72	M1100 / M1200 All Single System Steering Stabilizer; 1/2 and 3/4 Ton I-Beam Axle All models with factory frame bracket. Kit 143168 required to install to linkage.	
F	69	M1400 All Single System Steering Stabilizer; 1/2 and 3/4 Ton I-Beam Axle All models with factory frame bracket. Kit 143168 required to install to linkage.	
F	75	TRAVELALL RWD Single System Steering Stabilizer All models with factory frame bracket. Kit 143168 required to install to linkage.	
6803SE	W		141998
F	61-72	CHEVROLET PICKUP 3/4 TON, K20 All Single System Steering Stabilizer	
F	01-09	PICKUP 3/4 TON, SILVERADO 2500 HD All 9200# GVW w/o OE Unit - 15059138 15155638	
F	60-89	DODGE PICKUP 1 TON, W300 SERIES All Single System Steering Stabilizer	
F	69-89	PICKUP 3/4 TON, W200 SERIES All Single System Steering Stabilizer	
F	60-67	PICKUP 3/4 TON, W200 SERIES All Single System Steering Stabilizer	
F	71-87	VAN 1/2 TON, A / B SERIES / RAM All Single System Steering Stabilizer	
F	71-87	VAN 1 TON, A / B SERIES / RAM All Single System Steering Stabilizer	
F	80-87	VAN 3/4 TON, A / B SERIES / RAM All Single System Steering Stabilizer	
F	78-79	VAN 3/4 TON, A / B SERIES / RAM All Van Charger Special	
F	71-77	VAN 3/4 TON, A / B SERIES / RAM All Single System Steering Stabilizer	
F	75-77	FORD PICKUP 1 TON, F-350 / SUPERDUTY Manual Steering Single System Steering Stabilizer	
F	60-74	PICKUP 1 TON, F-350 / SUPERDUTY All Single System Steering Stabilizer	
F	75-77	PICKUP 3/4 TON, F-250 / SUPERDUTY 4WD, Manual Steering Single System Steering Stabilizer	
F	60-74	PICKUP 3/4 TON, F-250 / SUPERDUTY All Single System Steering Stabilizer	
F	74-79	VAN 3/4 TON, ECONOLINE / CLUB WAGON / SUPERDUTY All QuadraVan Special	
F	67-72	GMC PICKUP 3/4 TON, K25 / K2500 All Single System Steering Stabilizer	
F	75	INTERNATIONAL TRAVELALL 4WD Single System Steering Stabilizer	
6804SE	A		500498,141397
F	77-86	CHEVROLET PICKUP 1 TON, K30 All Single System Steering Stabilizer	
F	73-86	PICKUP 3/4 TON, K20 All Single System Steering Stabilizer	
F	87	PICKUP 3/4 TON, V20 All Single System Steering Stabilizer	
F	94-95	VAN 1 TON, G / EXPRESS All Single System Steering Stabilizer; HD w/ Straight Front Axle & Tilt Hood	
F	85-93	VAN 1 TON, P SERIES All Single System Steering Stabilizer; w/ I-Beam Front Suspension	
F	94-97	DODGE PICKUP 1 TON, RAM 3500 (SEE RAM 3500) 4WD With OEM 52038276	
F	94-97	PICKUP 1 TON, RAM 3500 (SEE RAM 3500) RWD w/ OEM 52038276 Solid Front Axle	
F	94-97	PICKUP 3/4 TON, RAM 2500 (SEE RAM 2500) 4WD With OEM 52038276	
F	73-86	GMC PICKUP 3/4 TON, K25 / K2500 All Single System Steering Stabilizer	
F	87	PICKUP 3/4 TON, V2500 All Single System Steering Stabilizer	

Numerical listing

Shock	POP	Alternative No.	MTG Acc. Supplied
Pos.	Year	Application	
6804SE	A (cont)		500498,141397
F	94-95	VAN 1 TON, G / SAVANA All Single System Steering Stabilizer; HD w/ Straight Front Axle & Tilt Hood	
6828SE	D		142718
F	00-02	FORD E-450 ECONOLINE SUPER DUTY All Single System Steering Stabilizer	
F	02	E-550 ECONOLINE SUPER DUTY All Single System Steering Stabilizer	
F	03	E-550 SUPER DUTY All Single System Steering Stabilizer	
F	96-99	ECONOLINE SUPER DUTY All Single System Steering Stabilizer	
F	99-10	PICKUP 1 TON, F-350 / SUPERDUTY RWD Single System Steering Stabilizer	
F	92-97	PICKUP 1 TON, F-350 / SUPERDUTY RWD Single System Steering Stabilizer	
F	99-10	PICKUP 3/4 TON, F-250 / SUPERDUTY RWD Single System Steering Stabilizer	
F	92-97	PICKUP 3/4 TON, F-250 / SUPERDUTY RWD Single System Steering Stabilizer	
F	21-24	VAN 1 TON, ECONOLINE / CLUB WAGON / SUPERDUTY All Single System Steering Stabilizer	
F	92-19	VAN 1 TON, ECONOLINE / CLUB WAGON / SUPERDUTY All Single System Steering Stabilizer	
F	96-04	VAN 3/4 TON, ECONOLINE / CLUB WAGON / SUPERDUTY All Single System Steering Stabilizer	
6847SE	D		143081
F	00-07	DODGE PICKUP 1 TON, RAM 3500 (SEE RAM 3500) 4WD With OEM # 52106909AB, AC, AD	
F	00-07	PICKUP 1 TON, RAM 3500 (SEE RAM 3500) RWD With OEM # 52106909AB, AC, AD and Solid Front Axle	
F	00-07	PICKUP 3/4 TON, RAM 2500 (SEE RAM 2500) 4WD With OEM # 52106909AB, AC, AD	
6850SE	D		143168
F	99-04	FORD PICKUP 1 TON, F-350 / SUPERDUTY 4WD Exc. OE Unit	
F	99-04	PICKUP 3/4 TON, F-250 / SUPERDUTY 4WD Exc. OE Unit	
6853SE	B		143155
F	95-00	CHEVROLET PICKUP 1 TON, K35 / K3500 All Exc. OE Unit	
F	92-99	PICKUP 3/4 TON, C25 / C2500 All Exc. OE Unit	
F	99-00	PICKUP 3/4 TON, K25 / K2500 All Exc. OE Unit	
F	01-09	PICKUP 3/4 TON, SILVERADO 2500 HD 4WD 9200# GVW w/ OE Unit - 15059138 15155638	
F	99-00	GMC PICKUP 3/4 TON, K25 / K2500 4WD 9200# GVW w/ OE Unit - 15059138 15155638	
F	99-04	SIERRA 2500 4WD Single System Steering Stabilizer; Up through 8600# GVW; Exc. OE Steering Stabilizer	
F	01-09	SIERRA 2500 HD 4WD 9200# GVW w/ OE Unit - 15059138 15155638	
6854SE	C		142718
F	00-05	FORD EXCURSION 4WD With OE Unit	
F	99-03	PICKUP 1 TON, F-350 / SUPERDUTY 4WD With OE Unit	
F	99-03	PICKUP 3/4 TON, F-250 / SUPERDUTY 4WD With OE Unit	
F	99-04	PICKUP, F-450 SUPERDUTY 4 X 4 Single System Steering Stabilizer	
F	99-04	PICKUP, F-550 SUPERDUTY 4 X 4 Single System Steering Stabilizer	
6855SE	D		143154
F	99-04	FORD PICKUP 1 TON, F-350 / SUPERDUTY 4WD Replacement Kit	
F	99-04	PICKUP 3/4 TON, F-250 / SUPERDUTY 4WD Replacement Kit	
6856SE	W		143156,143077
F	05-07	FORD PICKUP 3/4 TON, F-250 / SUPERDUTY 4WD Exc. OE Unit	

Numerical listing

Steering Stabilizer, Front Load Carrier, Rear Load Carrier

Numerical listing

Shock	POP	Alternative No.	MTG Acc. Supplied
Pos.	Year	Application	
6861SE	W		143160
F	97-99	FORD PICKUP 3/4 TON, F-250 / SUPERDUTY 4WD, Torsion Bar (FrontSpringType) Single System Steering Stabilizer	
Front Load Carrier			
34036	A		140357
F	67	CHEVROLET C20 PANEL All	
F	63-66	C30 PANEL All	
F	63-86	PICKUP 1 TON, C30 All	
F	88-91	PICKUP 1 TON, C35/3500 Cab & Chassis Exc. HD Solid Front Axle	
F	87-88	PICKUP 1 TON, R30 All	
F	89	PICKUP 1 TON, R3500 Standard Cab Pickup	
F	75-86	PICKUP 3/4 TON, C20 Crew Cab Pickup	
F	75-86	PICKUP 3/4 TON, C20 Standard Cab Pickup	
F	63-74	PICKUP 3/4 TON, C20 All	
F	87-88	PICKUP 3/4 TON, R20 Crew Cab Pickup	
F	89	PICKUP 3/4 TON, R2500 All	
F	63-80	VAN 1/2 TON, P SERIES All	
F	73-90	VAN 1 TON, P SERIES All Cutaway Chassis	
F	68-72	VAN 1 TON, P SERIES All	
F	68-89	VAN 3/4 TON, P SERIES All	
F	88-91	GMC PICKUP 1 TON, C35/3500 Cab & Chassis Exc. I Beam Front Axle	
F	67-78	PICKUP 1 TON, C35/3500 All	
F	87-91	PICKUP 1 TON, R3500 All	
F	75-86	PICKUP 3/4 TON, C25 / C2500 Cab & Chassis	
F	75-86	PICKUP 3/4 TON, C25 / C2500 Crew Cab Pickup	
F	75-86	PICKUP 3/4 TON, C25 / C2500 Standard Cab Pickup	
F	67-74	PICKUP 3/4 TON, C25 / C2500 All	
F	87-89	PICKUP 3/4 TON, R2500 All Exc. Crew Cab & Bonus Cab	
F	67-80	VAN 1/2 TON, P SERIES All	
F	74-90	VAN 1 TON, P SERIES All Cutaway Chassis	
F	73	VAN 1 TON, P SERIES Base Cutaway Chassis	
F	68-72	VAN 1 TON, P SERIES All	
F	68-89	VAN 3/4 TON, P SERIES All	
F	63-65	VAN, PB 1000 SERIES All	
34052	A		140126
F	72-93	DODGE PICKUP 3/4 TON, D200 SERIES All Exc. Heavy Duty Package	
F	99-03	VAN 1/2 TON, A / B SERIES / RAM 109.3 / 277.6 (WheelBase) Exc. 7000# GVW	
F	82-98	VAN 1/2 TON, A / B SERIES / RAM 109.6 / 278.4 (WheelBase) Exc. 7000# GVW	
F	71-80	VAN 1/2 TON, A / B SERIES / RAM All	
F	95-03	VAN 1 TON, A / B SERIES / RAM All	
F	71-94	VAN 1 TON, A / B SERIES / RAM All Exc. 4000# Front Axle	
F	71-03	VAN 3/4 TON, A / B SERIES / RAM All	
F	78-80	VAN, CB300 All Exc. 4000# Front Axle	
F	74-77	VAN, CB300 All Up through 8300# GVW	
F	81-83	PLYMOUTH VAN 1/2 TON, PB SERIES All	
F	74-83	VAN 1 TON, PB SERIES All Exc. 4000# Front Axle	
F	74-83	VAN 3/4 TON, PB SERIES All	
34058	B		140780
F	73-79	FORD PICKUP 1 TON, F-350 / SUPERDUTY All Quad Suspension Rearward of Front Axle	
F	70-79	PICKUP 3/4 TON, F-250 / SUPERDUTY All Quad Suspension Rearward of Front Axle	
F	77-91	VAN 1 TON, ECONOLINE / CLUB WAGON / SUPERDUTY All RWD, 4WD Quad Suspension Rearward of Front Axle	
F	75-91	VAN 1 TON, ECONOLINE / CLUB WAGON / SUPERDUTY All Exc. Cutaway Chassis RWD, 4WD Quad Suspension Rearward of Front Axle	

Shock	POP	Alternative No.	MTG Acc. Supplied
Pos.	Year	Application	
34058	B (cont)		140780
F	75-91	VAN 3/4 TON, ECONOLINE / CLUB WAGON / SUPERDUTY All RWD, 4WD Quad Suspension Rearward of Front Axle	
34073	A		141041
F	92-00	CHEVROLET PICKUP 1 TON, C35/3500 All Exc. Straight Front Axle	
F	88-91	PICKUP 1 TON, C35/3500 Extended Cab Pickup Exc. Straight Front Axle	
F	88-91	PICKUP 1 TON, C35/3500 Standard Cab Pickup Exc. Straight Front Axle	
F	88-00	PICKUP 3/4 TON, C25 / C2500 All	
F	96-02	VAN 1 TON, G / EXPRESS All Exc. 8600# GVW	
F	96-02	VAN 3/4 TON, G / EXPRESS All Exc. 8600# GVW	
F	88-00	GMC PICKUP 1 TON, C35/3500 All	
F	88-00	PICKUP 3/4 TON, C25 / C2500 All	
F	96-02	VAN 1/2 TON, G / SAVANA All Exc. 8600# GVW	
F	96-02	VAN 1 TON, G / SAVANA All Exc. 8600# GVW	
F	96-02	VAN 3/4 TON, G / SAVANA All Exc. 8600# GVW	
34076	A		140780
F	92-19	FORD VAN 1 TON, ECONOLINE / CLUB WAGON / SUPERDUTY All	
F	92-14	VAN 3/4 TON, ECONOLINE / CLUB WAGON / SUPERDUTY All	
Rear Load Carrier			
43048	A		
R	61-66	FORD PICKUP 1 TON, F-350 / SUPERDUTY All	
R	61-64	PICKUP 3/4 TON, F-250 / SUPERDUTY All	
F	68-76	PICKUP P350 All Up through 8000# GVW	
F	75-76	PICKUP P400 All Up through 8000# GVW	
F	68	INTERNATIONAL 1200C All Exc. 166" Wheelbase	
R	68	1200C All Exc. 166" Wheelbase	
F	68	1300C All Exc. 166" Wheelbase	
R	68	1300C All Exc. 166" Wheelbase	
R	68-72	M1100 / M1200 All	
R	69	M1400 All	
43058	C		140739
R	75-79	FORD PICKUP 1 TON, F-350 / SUPERDUTY Standard Cab Pickup, RWD	
R	73-74	PICKUP 1 TON, F-350 / SUPERDUTY Standard Cab Pickup RWD	
R	75-79	PICKUP 3/4 TON, F-250 / SUPERDUTY Cab & Chassis, RWD	
R	75-79	PICKUP 3/4 TON, F-250 / SUPERDUTY Extended Cab Pickup, RWD	
R	73-74	PICKUP 3/4 TON, F-250 / SUPERDUTY RWD	
R	65-72	PICKUP 3/4 TON, F-250 / SUPERDUTY All RWD	
R	69-74	VAN 1 TON, ECONOLINE / CLUB WAGON / SUPERDUTY All	
R	69-74	VAN 3/4 TON, ECONOLINE / CLUB WAGON / SUPERDUTY All	
43085	C		140724
R	99-03	DODGE VAN 1/2 TON, A / B SERIES / RAM 109.3 / 277.6 (WheelBase) Exc. 7000# GVW	
R	81-98	VAN 1/2 TON, A / B SERIES / RAM 109.6 / 278.4 (WheelBase) Exc. 7000# GVW	
R	71-80	VAN 1/2 TON, A / B SERIES / RAM All	
R	71-03	VAN 1 TON, A / B SERIES / RAM All	
R	71-03	VAN 3/4 TON, A / B SERIES / RAM All	
R	74-80	VAN, CB300 All	
R	81-83	PLYMOUTH VAN 1/2 TON, PB SERIES All	
R	74-83	VAN 1 TON, PB SERIES All	
R	74-83	VAN 3/4 TON, PB SERIES All	
43099	B		140126
R	75-79	FORD PICKUP 1 TON, F-350 / SUPERDUTY Cab & Chassis, RWD	

Shock	POP	Alternative No.	MTG Acc. Supplied
Pos.	Year	Application	
43099	B (cont)		140126
R	75-79	PICKUP 1 TON, F-350 / SUPERDUTY Extended Cab Pickup, RWD	
R	74	PICKUP 1 TON, F-350 / SUPERDUTY RWD Supercab	
R	75-79	PICKUP 3/4 TON, F-250 / SUPERDUTY Standard Cab Pickup, RWD	
R	73-74	PICKUP 3/4 TON, F-250 / SUPERDUTY RWD Standard Cab Pickup	
R	70-72	PICKUP 3/4 TON, F-250 / SUPERDUTY All RWD; Standard Cab Pickup	
43111	C		140702
R	75-86	CHEVROLET PICKUP 3/4 TON, C20 Standard Cab Pickup	
R	73-74	PICKUP 3/4 TON, C20 All Standard Cab Pickup	
R	73-86	PICKUP 3/4 TON, K20 All Exc. Lift Kit	
R	87	PICKUP 3/4 TON, R20 Standard Cab Pickup	
R	87	PICKUP 3/4 TON, V20 All Exc. Quad Suspension and Lift Kit	
R	73	VAN 1/2 TON, P SERIES All	
R	73-78	VAN 3/4 TON, P SERIES All	
R	75-86	GMC PICKUP 3/4 TON, C25 / C2500 Cab & Chassis	
R	75-86	PICKUP 3/4 TON, C25 / C2500 Standard Cab Pickup	
R	73-74	PICKUP 3/4 TON, C25 / C2500 All	
R	73-86	PICKUP 3/4 TON, K25 / K2500 All Exc. Lift Kit	
R	88-89	PICKUP 3/4 TON, R2500 All Exc. Crew Cab & Bonus Cab	
R	87	PICKUP 3/4 TON, R2500 Cab & Chassis Exc. Crew Cab & Bonus Cab	
R	87	PICKUP 3/4 TON, R2500 Standard Cab Pickup Exc. Crew Cab & Bonus Cab	
R	87	PICKUP 3/4 TON, V2500 All Exc. Lift Kit	
R	73	VAN 1/2 TON, P SERIES All	
R	73-78	VAN 3/4 TON, P SERIES All	
43140	A		141150
R	49-52	CHEVROLET FLEETLINE All	
R	49-52	FLEETLINE TRUCK All	
R	61-62	VAN 1 TON, P SERIES All	
R	61-62	VAN 3/4 TON, P SERIES All	
R	66-67	FIAT 1100 All Exc. Wagon	
R	64-65	1500 All Exc. Wagon	
43163	A		
R	91-02	CHEVROLET C3500HD All Solid Front Axle	
R	88-90	PICKUP 1 TON, C35/3500 Extended Cab Pickup Exc. HD Straight Front Axle	
R	88-90	PICKUP 1 TON, C35/3500 Standard Cab Pickup Exc. HD Straight Front Axle	
R	88-00	PICKUP 1 TON, K35 / K3500 All	
R	88-00	PICKUP 3/4 TON, C25 / C2500 All	
R	88-00	PICKUP 3/4 TON, K25 / K2500 All	
R	91-02	GMC C3500HD All Exc. I Beam Front Axle	
R	91-00	PICKUP 1 TON, C35/3500 All Exc. I Beam Front Axle	
R	88-90	PICKUP 1 TON, C35/3500 Extended Cab Pickup Exc. HD Straight Front Axle	
R	88-90	PICKUP 1 TON, C35/3500 Standard Cab Pickup Exc. HD Straight Front Axle	
R	88-00	PICKUP 1 TON, K35 / K3500 All	
R	88-00	PICKUP 3/4 TON, C25 / C2500 All	
R	88-00	PICKUP 3/4 TON, K25 / K2500 All	
43167	A		
R	97	FORD F-250 HD RWD	
R	80-97	PICKUP 1 TON, F-350 / SUPERDUTY RWD Exc. Dual Rear Wheels	
R	97	PICKUP 3/4 TON, F-250 / SUPERDUTY RWD Over 8500# GVW	
R	80-96	PICKUP 3/4 TON, F-250 / SUPERDUTY RWD	
R	97	PICKUP, F-450 SUPERDUTY All	

Numerical listing

Shock	POP	Alternative No.	MTG Acc. Supplied
Pos.	Year	Application	
43180	A		141099
R	91-02	CHEVROLET C3500HD All I Beam Front Axle	
R	96-23	VAN 1 TON, G / EXPRESS All	
R	03-23	VAN 3/4 TON, G / EXPRESS All	
R	96-02	VAN 3/4 TON, G / EXPRESS All Exc. 8600# GVW	
R	96-14	GMC VAN 1/2 TON, G / SAVANA All	
R	96-23	VAN 1 TON, G / SAVANA All	
R	03-23	VAN 3/4 TON, G / SAVANA All	
R	96-02	VAN 3/4 TON, G / SAVANA All Exc. 8600# GVW	
43181	A		
R	11-24	CHEVROLET PICKUP 1 TON, SILVERADO 3500 HD All	
R	11-24	PICKUP 3/4 TON, SILVERADO 2500 HD All	
R	94-02	DODGE PICKUP 1 TON, RAM 3500 (SEE RAM 3500) RWD Exc. Solid Front Axle	
R	11-24	GMC SIERRA 2500 HD All	
R	11-24	SIERRA 3500 HD All	
HiJackers			
49107	D		141099
R	67-72	CHEVROLET PICKUP 3/4 TON, C20 All Coil(RearSpringType)	
R	67-72	VAN 1/2 TON, P SERIES All	
R	67-72	GMC PICKUP 3/4 TON, C25 / C2500 All Coil(RearSpringType)	
R	68-72	VAN 1/2 TON, P SERIES All Coil(RearSpringType)	
49127	D	140739,141137,141099	
R	75-79	FORD PICKUP 1 TON, F-350 / SUPERDUTY Standard Cab Pickup, RWD	
R	73-74	PICKUP 1 TON, F-350 / SUPERDUTY Standard Cab Pickup RWD	
R	75-79	PICKUP 3/4 TON, F-250 / SUPERDUTY Cab & Chassis, RWD	
R	75-79	PICKUP 3/4 TON, F-250 / SUPERDUTY Extended Cab Pickup, RWD	
R	65-69	PICKUP 3/4 TON, F-250 / SUPERDUTY All Supercab	
R	69-74	VAN 1 TON, ECONOLINE / CLUB WAGON / SUPERDUTY All	
R	69-74	VAN 3/4 TON, ECONOLINE / CLUB WAGON / SUPERDUTY All	
49149	W		141099
R	72-93	DODGE PICKUP 1 TON, D300 SERIES All	
R	82-93	PICKUP 3/4 TON, D200 SERIES All	
R	81	PICKUP 3/4 TON, D200 SERIES All Exc. Heavy Duty Package	
R	72-80	PICKUP 3/4 TON, D200 SERIES All	
49155	A		140702,141099
R	75-86	CHEVROLET PICKUP 3/4 TON, C20 Standard Cab Pickup	
R	73-74	PICKUP 3/4 TON, C20 All Standard Cab Pickup	
R	81-86	PICKUP 3/4 TON, K20 All Standard Suspension; Exc. Lift Kit	
R	73-80	PICKUP 3/4 TON, K20 All Exc. Lift Kit	
R	87	PICKUP 3/4 TON, R20 Standard Cab Pickup	
R	87	PICKUP 3/4 TON, V20 All	
R	73	VAN 1/2 TON, P SERIES All	
R	73-78	VAN 3/4 TON, P SERIES All	
R	75-86	GMC PICKUP 3/4 TON, C25 / C2500 Cab & Chassis	
R	75-86	PICKUP 3/4 TON, C25 / C2500 Standard Cab Pickup	
R	73-74	PICKUP 3/4 TON, C25 / C2500 All	
R	73-86	PICKUP 3/4 TON, K25 / K2500 All Exc. Quad Suspension and Lift Kit	
R	88-89	PICKUP 3/4 TON, R2500 All Exc. Crew Cab & Bonus Cab	
R	87	PICKUP 3/4 TON, R2500 Cab & Chassis Exc. Crew Cab & Bonus Cab	
R	87	PICKUP 3/4 TON, R2500 Standard Cab Pickup Exc. Crew Cab & Bonus Cab	
R	87	PICKUP 3/4 TON, V2500 All Exc. Lift Kit	
R	73	VAN 1/2 TON, P SERIES All	
R	73-78	VAN 3/4 TON, P SERIES All	

Rear Load Carrier, HiJackers, Ultra Struts

Shock	POP	Alternative No.	MTG Acc. Supplied
Pos.	Year	Application	
49162	W		141058,141099
R	67-72	CHEVROLET PICKUP 1 TON, C30 All Exc. 11,000# Rear Axle	
R	67-72	PICKUP 3/4 TON, C20 All Leaf(RearSpringType)	
R	63-66	PICKUP 3/4 TON, C20 All	
R	67-77	VAN 1/2 TON, G / EXPRESS All	
R	63-66	VAN 1/2 TON, P SERIES All	
R	76-77	VAN 1 TON, G / EXPRESS All	
R	75	VAN 1 TON, G / EXPRESS 110.0 / 279.4 (WheelBase)	
R	75	VAN 1 TON, G / EXPRESS 125.0 / 317.5 (WheelBase)	
R	71-74	VAN 1 TON, G / EXPRESS All	
R	68-72	VAN 1 TON, P SERIES All Exc. 11,000# Rear Axle	
R	67-77	VAN 3/4 TON, G / EXPRESS All	
R	68-72	VAN 3/4 TON, P SERIES All	
R	67-72	GMC PICKUP 1 TON, C35/3500 All Exc. 11,000# Rear Axle	
R	67-72	PICKUP 3/4 TON, C25 / C2500 All Leaf(RearSpringType)	
R	67-77	VAN 1/2 TON, G / SAVANA All	
R	67	VAN 1/2 TON, P SERIES All	
R	76-77	VAN 1 TON, G / SAVANA All	
R	75	VAN 1 TON, G / SAVANA 110.0 / 279.4 (WheelBase)	
R	75	VAN 1 TON, G / SAVANA 125.0 / 317.5 (WheelBase)	
R	71-74	VAN 1 TON, G / SAVANA All Exc. 146" Wheelbase	
R	68-72	VAN 1 TON, P SERIES All Exc. 11,000# Rear Axle	
R	67-77	VAN 3/4 TON, G / SAVANA All	
R	68-72	VAN 3/4 TON, P SERIES All	
R	63-65	VAN, PB 1000 SERIES All	
49173	W		140126,141099
R	75-79	FORD PICKUP 1 TON, F-350 / SUPERDUTY Cab & Chassis, RWD	
R	75-79	PICKUP 1 TON, F-350 / SUPERDUTY Extended Cab Pickup, RWD	
R	74	PICKUP 1 TON, F-350 / SUPERDUTY RWD Extended Cab & Chassis Cab	
R	75-79	PICKUP 3/4 TON, F-250 / SUPERDUTY Standard Cab Pickup, RWD	
R	71-74	PICKUP 3/4 TON, F-250 / SUPERDUTY All RWD; Exc. Extended Cab & Chassis Cab	
49178	B		140126,141099
R	79	FORD PICKUP 1 TON, F-350 / SUPERDUTY 4WD	
R	77-79	PICKUP 3/4 TON, F-250 / SUPERDUTY Cab & Chassis, 4WD All From Serial No. Y20001	
R	77-79	PICKUP 3/4 TON, F-250 / SUPERDUTY Standard Cab Pickup, 4WD All From Serial No. Y20001	
R	21-24	VAN 1 TON, ECONOLINE / CLUB WAGON / SUPERDUTY All	
R	77-19	VAN 1 TON, ECONOLINE / CLUB WAGON / SUPERDUTY All	
R	07	VAN 1 TON, ECONOLINE / CLUB WAGON / SUPERDUTY All Exc. Cutaway Chassis	
R	75-91	VAN 1 TON, ECONOLINE / CLUB WAGON / SUPERDUTY All Exc. Cutaway Chassis	
R	75-14	VAN 3/4 TON, ECONOLINE / CLUB WAGON / SUPERDUTY All	
49203	D		142261,141099
R	61-62	CHEVROLET VAN 1 TON, P SERIES All	
R	61-62	VAN 3/4 TON, P SERIES All	
R	56-60	FORD PICKUP 3/4 TON, F-250 / SUPERDUTY All	
49205	D		141150,141099
R	49-52	CHEVROLET FLEETLINE All	
R	49-52	FLEETLINE TRUCK All	
49212	C		141099
R	78-95	CHEVROLET VAN 1/2 TON, G / EXPRESS All	
R	78-95	VAN 1 TON, G / EXPRESS Cutaway Van	
R	78-95	VAN 3/4 TON, G / EXPRESS All Exc. 8600# GVW	
R	99-03	DODGE VAN 1/2 TON, A / B SERIES / RAM 109.3 / 277.6 (WheelBase) Exc. 7000# GVW	

Numerical listing

Shock	POP	Alternative No.	MTG Acc. Supplied
Pos.	Year	Application	
49212	C (cont)		141099
R	82-98	VAN 1/2 TON, A / B SERIES / RAM 109.6 / 278.4 (WheelBase) Exc. 7000# GVW	
R	71-80	VAN 1/2 TON, A / B SERIES / RAM All	
R	71-03	VAN 1 TON, A / B SERIES / RAM All	
R	71-03	VAN 3/4 TON, A / B SERIES / RAM All	
R	78-80	VAN, CB300 All	
R	77	VAN, CB300 All Over 8300# GVW	
R	75-76	VAN, CB300 All	
R	74	VAN, CB300 All Over 8300# GVW	
R	78-95	GMC VAN 1/2 TON, G / SAVANA All	
R	85-95	VAN 1 TON, G / SAVANA Extended Cargo Van	
R	85-95	VAN 1 TON, G / SAVANA Extended Passenger Van	
R	79-95	VAN 1 TON, G / SAVANA Standard Cargo Van	
R	79-95	VAN 1 TON, G / SAVANA Standard Passenger Van	
R	78	VAN 1 TON, G / SAVANA Cutaway Van	
R	78-95	VAN 3/4 TON, G / SAVANA All Exc. 8600# GVW	
R	81-83	PLYMOUTH VAN 1/2 TON, PB SERIES All	
R	74-83	VAN 1 TON, PB SERIES All	
R	74-83	VAN 3/4 TON, PB SERIES All	
49218	A		141099
R	91-00	CHEVROLET PICKUP 1 TON, C35/3500 All	
R	88-90	PICKUP 1 TON, C35/3500 Extended Cab Pickup	
R	88-90	PICKUP 1 TON, C35/3500 Standard Cab Pickup	
R	88-00	PICKUP 1 TON, K35 / K3500 All	
R	88-00	PICKUP 3/4 TON, C25 / C2500 All	
R	88-00	PICKUP 3/4 TON, K25 / K2500 All	
R	92-00	GMC PICKUP 1 TON, C35/3500 Cab & Chassis Exc. HD Straight Front Axle	
R	88-91	PICKUP 1 TON, C35/3500 All Exc. HD Straight Front Axle	
R	88-00	PICKUP 1 TON, K35 / K3500 All	
R	88-00	PICKUP 3/4 TON, C25 / C2500 All	
R	88-00	PICKUP 3/4 TON, K25 / K2500 All	
49231	B		141099
R	96-02	CHEVROLET VAN 1 TON, G / EXPRESS All	
R	96-02	VAN 3/4 TON, G / EXPRESS All Exc. 8600# GVW	
R	96-14	GMC VAN 1/2 TON, G / SAVANA All	
R	96-02	VAN 1 TON, G / SAVANA All	
R	96-02	VAN 3/4 TON, G / SAVANA All Exc. 8600# GVW	
49235	A		141099
R	94-02	DODGE PICKUP 1 TON, RAM 3500 (SEE RAM 3500) RWD Exc. Solid Front Axle	
R	94-02	PICKUP 3/4 TON, RAM 2500 (SEE RAM 2500) All Exc. 8800# GVW	
49237	W		142700,141099
R	97-99	FORD PICKUP 3/4 TON, F-250 / SUPERDUTY RWD Up through 8500# GVW	
49310	D		140788,141099
R	67	FIAT 124 Wagon	
R	66	124 All Wagon	
R	66-67	1100 All Wagon	
R	66-67	1500 All Wagon	
R	68-72	INTERNATIONAL M1100 / M1200 All	
R	69	M1400 All	
49311	A		141099
R	61-67	FORD ECONOLINE All	
Ultra Struts			
G51856	C		
F	16-18	RAM 1500 (SEE DODGE RAM 1500) 4WD Exc. Air Suspension	
F	11-15	1500 (SEE DODGE RAM 1500) 4WD	
F	19-20	1500 CLASSIC 4WD Old Body Style	
G56778	W		143172
F	03-06	DODGE SPRINTER 2500 All	
F	03-06	SPRINTER 3500 All	

Numerical listing

Shock	POP	Alternative No.	MTG Acc. Supplied
Pos.	Year	Application	
G56778	W	(cont)	143172
F	02-06	FREIGHTLINER SPRINTER 2500 All	
F	04-06	MERCEDES-BENZ SPRINTER All	
Ultra ReadyMount			
G57147	C		
F	16-18	RAM 1500 (SEE DODGE RAM 1500) 4WD Exc. Air Suspension	
F	11-15	1500 (SEE DODGE RAM 1500) 4WD	
F	19-20	1500 CLASSIC 4WD Old Body Style	
G57206	B		
F	12-15	RAM C/V All	
G57800	A		
F	14-25	RAM PROMASTER 1500 All Left	
F	14-25	PROMASTER 2500 All Left	
F	14-25	PROMASTER 3500 All Left	
G57801	A		
F	14-25	RAM PROMASTER 1500 All Right	
F	14-25	PROMASTER 2500 All Right	
F	14-25	PROMASTER 3500 All Right	
G57802	W		
F	07-09	DODGE SPRINTER 2500 All	
F	07-09	SPRINTER 3500 All	
F	07-18	FREIGHTLINER SPRINTER 2500 All	
F	07-18	SPRINTER 3500 All	
F	10-18	MERCEDES-BENZ SPRINTER 2500 All	
F	10-18	SPRINTER 3500 All	
G57816	D		
F	15-22	FORD TRANSIT-150 All	
F	15-22	TRANSIT-250 All	
F	15-22	TRANSIT-350 All	
F	19-22	LEISURE TRAVEL WONDER All MotorHomes with Ford Transit-350 Chassis	
G57852	W		
F	15-21	RAM PROMASTER CITY All Left	
G57853	W		
F	15-21	RAM PROMASTER CITY All Right	
LTV Severe Duty			
58357	C		
F	71-95	CHEVROLET VAN 1/2 TON, G / EXPRESS All	
F	70	VAN 1/2 TON, G / EXPRESS All Independent Front Suspension	
F	78-96	VAN 1 TON, G / EXPRESS All	
F	96	VAN 1 TON, G / EXPRESS Cutaway Van	
F	75	VAN 1 TON, G / EXPRESS 146.0 / 370.8 (WheelBase)	
F	71-74	VAN 1 TON, G / EXPRESS All	
F	78-95	VAN 3/4 TON, G / EXPRESS All Exc. 8600# GVW	
F	70-77	VAN 3/4 TON, G / EXPRESS All	
F	70-95	GMC VAN 1/2 TON, G / SAVANA All	
F	76-96	VAN 1 TON, G / SAVANA All	
F	75	VAN 1 TON, G / SAVANA 110.0 / 279.4 (WheelBase)	
F	75	VAN 1 TON, G / SAVANA 125.0 / 317.5 (WheelBase)	
F	71-74	VAN 1 TON, G / SAVANA All	
F	78-95	VAN 3/4 TON, G / SAVANA All Exc. 8600# GVW	
F	71-77	VAN 3/4 TON, G / SAVANA All	
F	70	VAN 3/4 TON, G / SAVANA All Independent Front Suspension	
58359	D		140126
F	72-93	DODGE PICKUP 3/4 TON, D200 SERIES All Exc. Heavy Duty Package	
F	99-03	VAN 1/2 TON, A / B SERIES / RAM 109.3 / 277.6 (WheelBase) Exc. 7000# GVW	
F	81-98	VAN 1/2 TON, A / B SERIES / RAM 109.6 / 278.4 (WheelBase) Exc. 7000# GVW	
F	71-80	VAN 1/2 TON, A / B SERIES / RAM All	
F	95-03	VAN 1 TON, A / B SERIES / RAM All	
F	71-94	VAN 1 TON, A / B SERIES / RAM All Exc. 4000# Front Axle	
F	71-03	VAN 3/4 TON, A / B SERIES / RAM All	

Ultra Struts, Ultra ReadyMount, LTV Severe Duty

Shock	POP	Alternative No.	MTG Acc. Supplied
Pos.	Year	Application	
58359	D	(cont)	140126
F	78-80	VAN, CB300 All Exc. 4000# Front Axle	
F	74-77	VAN, CB300 All Up through 8300# GVW	
F	81-83	PLYMOUTH VAN 1/2 TON, PB SERIES All	
F	74-83	VAN 1 TON, PB SERIES All Exc. 4000# Front Axle	
F	74-83	VAN 3/4 TON, PB SERIES All	
58403	D		
R	79-95	CHEVROLET VAN 1 TON, G / EXPRESS Cutaway Van	
F	85	VAN 1 TON, P SERIES All Motorhome Chassis w/ I-Beam Front Suspension	
R	79-95	GMC VAN 1 TON, G / SAVANA Cutaway Van	
F	85	VAN 1 TON, P SERIES All Motorhome Chassis w/ I-Beam Front Suspension	
58412	A		
R	77-86	CHEVROLET PICKUP 1 TON, K30 All	
R	90-91	PICKUP 1 TON, R3500 All	
R	89	PICKUP 1 TON, R3500 Cab & Chassis	
R	89	PICKUP 1 TON, R3500 Crew Cab Pickup	
R	01-09	PICKUP 1 TON, SILVERADO 3500 All	
R	07-10	PICKUP 1 TON, SILVERADO 3500 HD All	
R	87-88	PICKUP 1 TON, V30 All	
R	89-91	PICKUP 1 TON, V3000 / V3500 All	
R	99-08	PICKUP 3/4 TON, SILVERADO 2500 All	
R	01-10	PICKUP 3/4 TON, SILVERADO 2500 HD All	
R	07	SILVERADO 2500 HD CLASSIC All	
R	07	SILVERADO 3500 CLASSIC All	
R	77-86	GMC PICKUP 1 TON, K35 / K3500 All	
R	87-91	PICKUP 1 TON, V3000 / V3500 All	
R	99-04	SIERRA 2500 All	
R	01-10	SIERRA 2500 HD All	
R	07	SIERRA 2500 HD CLASSIC All	
R	01-06	SIERRA 3500 All	
R	07	SIERRA 3500 CLASSIC All	
R	07-10	SIERRA 3500 HD All	
R	11-18	RAM 1500 (SEE DODGE RAM 1500) All	
R	19-22	1500 CLASSIC All Old Body Style	
58488	A		
R	91-02	CHEVROLET C3500HD All Solid Front Axle	
R	88-90	PICKUP 1 TON, C35/3500 Extended Cab Pickup Exc. HD Straight Front Axle	
R	88-90	PICKUP 1 TON, C35/3500 Standard Cab Pickup Exc. HD Straight Front Axle	
R	88-00	PICKUP 1 TON, K35 / K3500 All	
R	88-00	PICKUP 3/4 TON, C25 / C2500 All	
R	88-00	PICKUP 3/4 TON, K25 / K2500 All	
R	91-02	GMC C3500HD All Solid Front Axle	
R	98-99	PICKUP 1 TON, C35/3500 Cab & Chassis Exc. I Beam Front Axle	
R	88-97	PICKUP 1 TON, C35/3500 All Exc. I Beam Front Axle	
R	88-00	PICKUP 1 TON, K35 / K3500 All	
R	88-00	PICKUP 3/4 TON, C25 / C2500 All	
R	88-00	PICKUP 3/4 TON, K25 / K2500 All	
58489	A		141537
F	92-00	CHEVROLET PICKUP 1 TON, C35/3500 Crew Cab Pickup Exc. HD Straight Front Axle	
F	88-00	PICKUP 1 TON, C35/3500 Extended Cab Pickup Exc. HD Straight Front Axle	
F	88-00	PICKUP 1 TON, C35/3500 Standard Cab Pickup Exc. HD Straight Front Axle	
F	88-00	PICKUP 3/4 TON, C25 / C2500 All	
F	92-00	GMC PICKUP 1 TON, C35/3500 Crew Cab Pickup Exc. HD Straight Front Axle	
F	88-00	PICKUP 1 TON, C35/3500 Extended Cab Pickup Exc. HD Straight Front Axle	

Numerical listing

Shock	POP	Alternative No.	MTG Acc. Supplied
Pos.	Year	Application	
58489	A	(cont)	141537
F	88-00	PICKUP 1 TON, C35/3500 Standard Cab Pickup Exc. HD Straight Front Axle	
F	88-00	PICKUP 3/4 TON, C25 / C2500 All	
58609	A		140780
F	88-00	CHEVROLET PICKUP 1 TON, K35 / K3500 All	
F	88-00	PICKUP 3/4 TON, K25 / K2500 All	
F	88-00	GMC PICKUP 1 TON, K35 / K3500 All	
F	88-00	PICKUP 3/4 TON, K25 / K2500 All	
58622	W		142617
F	00-02	FORD E-450 ECONOLINE SUPER DUTY All	
F	00-06	ECONOLINE All	
F	21-24	VAN 1 TON, ECONOLINE / CLUB WAGON / SUPERDUTY All	
F	99-19	VAN 1 TON, ECONOLINE / CLUB WAGON / SUPERDUTY All	
F	04-11	VAN 1 TON, ECONOLINE / CLUB WAGON / SUPERDUTY All Exc. Cutaway Chassis	
F	07-08	VAN 1 TON, ECONOLINE / CLUB WAGON / SUPERDUTY All Cutaway Chassis	
F	92-05	VAN 1 TON, ECONOLINE / CLUB WAGON / SUPERDUTY All Cutaway Chassis	
F	92-14	VAN 3/4 TON, ECONOLINE / CLUB WAGON / SUPERDUTY All	
58623	D		142617
R	00-02	FORD E-450 ECONOLINE SUPER DUTY All	
R	00-06	ECONOLINE All	
R	21-24	VAN 1 TON, ECONOLINE / CLUB WAGON / SUPERDUTY All	
R	04-19	VAN 1 TON, ECONOLINE / CLUB WAGON / SUPERDUTY All Exc. Cutaway Chassis	
R	99-19	VAN 1 TON, ECONOLINE / CLUB WAGON / SUPERDUTY All	
R	07-08	VAN 1 TON, ECONOLINE / CLUB WAGON / SUPERDUTY All Cutaway Chassis	
R	92-05	VAN 1 TON, ECONOLINE / CLUB WAGON / SUPERDUTY All Cutaway Chassis	
R	92-14	VAN 3/4 TON, ECONOLINE / CLUB WAGON / SUPERDUTY All	
58638	A		
R	09-22	CHEVROLET EXPRESS 4500 All	
R	23-24	VAN 1 TON, G / EXPRESS All	
R	10-12	VAN 1 TON, G / EXPRESS All	
R	03-06	VAN 1 TON, G / EXPRESS All	
R	23-24	VAN 3/4 TON, G / EXPRESS All	
R	07-09	VAN 3/4 TON, G / EXPRESS All	
R	96-02	VAN 3/4 TON, G / EXPRESS All Exc. 8600# GVW	
R	08-14	GMC VAN 1/2 TON, G / SAVANA All	
R	96-06	VAN 1/2 TON, G / SAVANA All	
R	23-24	VAN 1 TON, G / SAVANA All	
R	96-02	VAN 1 TON, G / SAVANA All Exc. 8600# GVW	
R	23-24	VAN 3/4 TON, G / SAVANA All	
R	96-02	VAN 3/4 TON, G / SAVANA All Exc. 8600# GVW	
58662	C		
R	94-02	DODGE PICKUP 1 TON, RAM 3500 (SEE RAM 3500) RWD Exc. Solid Front Axle	
R	94-02	PICKUP 3/4 TON, RAM 2500 (SEE RAM 2500) All Exc. 8800# GVW	
58714	W		142731
F	96-99	FORD PICKUP 3/4 TON, F-250 / SUPERDUTY RWD Up through 8500# GVW	
58807	C		142617
F	22-24	FORD PICKUP 1 TON, F-350 / SUPERDUTY RWD	
F	13-16	PICKUP 1 TON, F-350 / SUPERDUTY All	
F	99-16	PICKUP 1 TON, F-350 / SUPERDUTY RWD	
F	99-24	PICKUP 3/4 TON, F-250 / SUPERDUTY RWD	

Numerical listing

Shock	POP	Alternative No.	MTG Acc. Supplied
Pos.	Year	Application	
58808	W		
R	99-04	FORD PICKUP 1 TON, F-350 / SUPERDUTY RWD	
R	99-04	PICKUP 3/4 TON, F-250 / SUPERDUTY RWD	
58809	B		
F	99-04	FORD PICKUP 1 TON, F-350 / SUPERDUTY 4WD	
F	99-04	PICKUP 3/4 TON, F-250 / SUPERDUTY 4WD	
F	99-04	PICKUP, F-450 SUPERDUTY All	
F	99-04	PICKUP, F-550 SUPERDUTY All	
58810	C		
R	99-04	FORD PICKUP 1 TON, F-350 / SUPERDUTY 4WD	
R	99-04	PICKUP 3/4 TON, F-250 / SUPERDUTY 4WD	
58817	A		141665
F	01-09	CHEVROLET PICKUP 1 TON, SILVERADO 3500 All	
F	07-10	PICKUP 1 TON, SILVERADO 3500 HD All	
F	05-08	PICKUP 3/4 TON, SILVERADO 2500 All	
F	99-04	PICKUP 3/4 TON, SILVERADO 2500 4WD	
F	01-10	PICKUP 3/4 TON, SILVERADO 2500 HD All 9200# GVW	
F	07	SILVERADO 2500 HD CLASSIC All 9200# GVW	
F	07	SILVERADO 3500 CLASSIC All Heavy Duty	
F	99-04	GMC SIERRA 2500 All	
F	01-10	SIERRA 2500 HD All	
F	01-06	SIERRA 3500 All	
F	07	SIERRA 3500 CLASSIC All	
F	07-10	SIERRA 3500 HD Torsion Bar (FrontSpringType)	
58929	D		140780
F	03-14	FORD VAN 1/2 TON, ECONOLINE / CLUB WAGON All	
58930	A		
R	75-86	CHEVROLET PICKUP 1 TON, C30 All	
R	88-91	PICKUP 1 TON, C35/3500 Cab & Chassis Exc. HD Solid Front Axle	
R	87-88	PICKUP 1 TON, R30 All	
R	89	PICKUP 1 TON, R3500 Standard Cab Pickup	
R	75-86	PICKUP 3/4 TON, C20 Crew Cab Pickup	
R	87-88	PICKUP 3/4 TON, R20 Crew Cab Pickup	
R	89	PICKUP 3/4 TON, R2500 All	
R	74-80	VAN 1/2 TON, P SERIES All	
R	73-99	VAN 1 TON, P SERIES All	
R	79-89	VAN 3/4 TON, P SERIES All	
58944	W		
F	07-12	FORD PICKUP, F-450 SUPERDUTY All	
F	10-12	PICKUP, F-550 SUPERDUTY All	
Ultra Truck Shock			
G63183	W		
F	81-93	DODGE PICKUP 1 TON, W300 SERIES All Exc. Quad Suspension and Lift Kit	
F	61-80	PICKUP 1 TON, W300 SERIES All	
F	61-71	PICKUP 1 TON, W300 SERIES All	
F	90-93	PICKUP 3/4 TON, W200 SERIES Extended Cab Pickup Exc. Lift Kit	
F	88-93	PICKUP 3/4 TON, W200 SERIES Cab & Chassis Exc. Lift Kit	
F	81-93	PICKUP 3/4 TON, W200 SERIES Standard Cab Pickup Exc. Lift Kit	
F	86	PICKUP 3/4 TON, W200 SERIES Cab & Chassis Exc. Lift Kit	
F	81-83	PICKUP 3/4 TON, W200 SERIES Cab & Chassis Exc. Lift Kit	
F	81-82	PICKUP 3/4 TON, W200 SERIES Extended Cab Pickup Exc. Lift Kit	
F	69-80	PICKUP 3/4 TON, W200 SERIES All	
F	61-67	PICKUP 3/4 TON, W200 SERIES All	
G63299	W		140885
R	61-67	FORD ECONOLINE All	
R	87-04	MITSUBISHI FUSO FE All Model with O.E.M. Number	

LTV Severe Duty, Ultra Truck Shock

Shock	POP	Alternative No.	MTG Acc. Supplied
Pos.	Year	Application	
G63306	C		
R	67	CHEVROLET K20 PANEL All	
R	67-72	PICKUP 1 TON, C30 All Exc. 11,000# Rear Axle	
R	63-72	PICKUP 3/4 TON, C20 All	
R	67-72	PICKUP 3/4 TON, K20 All	
R	67-77	VAN 1/2 TON, G / EXPRESS All	
R	63-66	VAN 1/2 TON, P SERIES All	
R	76-77	VAN 1 TON, G / EXPRESS All	
R	75	VAN 1 TON, G / EXPRESS 110.0 / 279.4 (WheelBase)	
R	75	VAN 1 TON, G / EXPRESS 125.0 / 317.5 (WheelBase)	
R	71-74	VAN 1 TON, G / EXPRESS All	
R	68-72	VAN 1 TON, P SERIES All Exc. 11,000# Rear Axle	
R	67-77	VAN 3/4 TON, G / EXPRESS All	
R	68-72	VAN 3/4 TON, P SERIES All	
R	67-72	GMC PICKUP 1 TON, C35/3500 All Exc. 11,000# Rear Axle	
R	72	PICKUP 3/4 TON, C25 / C2500 All Leaf(RearSpringType)	
R	71	PICKUP 3/4 TON, C25 / C2500 All	
R	67-70	PICKUP 3/4 TON, C25 / C2500 All Leaf(RearSpringType)	
R	67-77	VAN 1/2 TON, G / SAVANA All	
R	67	VAN 1/2 TON, P SERIES All	
R	76-77	VAN 1 TON, G / SAVANA All	
R	75	VAN 1 TON, G / SAVANA 110.0 / 279.4 (WheelBase)	
R	75	VAN 1 TON, G / SAVANA 125.0 / 317.5 (WheelBase)	
R	71-74	VAN 1 TON, G / SAVANA All	
R	68-72	VAN 1 TON, P SERIES All Exc. 11,000# Rear Axle	
R	67-77	VAN 3/4 TON, G / SAVANA All	
R	68-72	VAN 3/4 TON, P SERIES All	
R	63-65	VAN, PB 1000 SERIES All	
G63347	C		
F	69-86	CHEVROLET PICKUP 3/4 TON, K20 All Exc. Lift Kit	
F	87	PICKUP 3/4 TON, V20 All Exc. Quad Suspension and Lift Kit	
F	69-86	GMC PICKUP 3/4 TON, K25 / K2500 All Exc. Quad Suspension and Lift Kit	
F	87	PICKUP 3/4 TON, V2500 All Exc. Lift Kit	
G63349	A		140357
R	75-86	CHEVROLET PICKUP 3/4 TON, C20 Standard Cab Pickup	
R	75-86	PICKUP 3/4 TON, K20 All Exc. Lift Kit	
R	87	PICKUP 3/4 TON, R20 Standard Cab Pickup	
R	87	PICKUP 3/4 TON, V20 All Exc. Quad Suspension and Lift Kit	
R	73	VAN 1/2 TON, P SERIES All	
R	73-78	VAN 3/4 TON, P SERIES All	
R	75-86	GMC PICKUP 3/4 TON, C25 / C2500 Cab & Chassis	
R	75-86	PICKUP 3/4 TON, C25 / C2500 Standard Cab Pickup	
R	73-74	PICKUP 3/4 TON, C25 / C2500 All Exc. Crew Cab & Bonus Cab	
R	73-86	PICKUP 3/4 TON, K25 / K2500 All Exc. Lift Kit	
R	88-89	PICKUP 3/4 TON, R2500 All Exc. Crew Cab & Bonus Cab	
R	87	PICKUP 3/4 TON, R2500 Cab & Chassis Exc. Crew Cab & Bonus Cab	
R	87	PICKUP 3/4 TON, R2500 Standard Cab Pickup Exc. Crew Cab & Bonus Cab	
R	87	PICKUP 3/4 TON, V2500 All Exc. Lift Kit	
R	73	VAN 1/2 TON, P SERIES All	
R	73-78	VAN 3/4 TON, P SERIES All	
G63350	C		140126
R	75-79	FORD PICKUP 1 TON, F-350 / SUPERDUTY Extended Cab Pickup, RWD	
R	67-74	PICKUP 1 TON, F-350 / SUPERDUTY RWD Supercab	
R	75-79	PICKUP 3/4 TON, F-250 / SUPERDUTY Cab & Chassis, RWD	
R	75-79	PICKUP 3/4 TON, F-250 / SUPERDUTY Standard Cab Pickup, RWD	

Numerical listing

Shock	POP	Alternative No.	MTG Acc. Supplied
Pos.	Year	Application	
G63350	C (cont)		140126
R	65-74	PICKUP 3/4 TON, F-250 / SUPERDUTY All RWD; Exc. Supercab	
G63353	C		
R	72-93	DODGE PICKUP 1 TON, D300 SERIES All	
R	72-93	PICKUP 3/4 TON, D200 SERIES All	
G63355	A		140702
F	63-86	CHEVROLET PICKUP 1 TON, C30 All	
F	88-91	PICKUP 1 TON, C35/3500 Cab & Chassis Exc. HD Solid Front Axle	
F	87-88	PICKUP 1 TON, R30 All	
F	89	PICKUP 1 TON, R3500 Standard Cab Pickup	
F	63-86	PICKUP 3/4 TON, C20 All	
F	87-88	PICKUP 3/4 TON, R20 All	
F	89	PICKUP 3/4 TON, R2500 All	
F	63-80	VAN 1/2 TON, P SERIES All	
F	68-90	VAN 1 TON, P SERIES All Cutaway Chassis	
F	68-89	VAN 3/4 TON, P SERIES All	
F	88-90	GMC PICKUP 1 TON, C35/3500 Cab & Chassis Exc. HD Solid Front Axle	
F	67-78	PICKUP 1 TON, C35/3500 All	
F	87-91	PICKUP 1 TON, R3500 All	
F	85-86	PICKUP 3/4 TON, C25 / C2500 Crew Cab Pickup	
F	75-86	PICKUP 3/4 TON, C25 / C2500 Cab & Chassis	
F	75-86	PICKUP 3/4 TON, C25 / C2500 Standard Cab Pickup	
F	75-83	PICKUP 3/4 TON, C25 / C2500 Crew Cab Pickup	
F	67-74	PICKUP 3/4 TON, C25 / C2500 All	
F	87-89	PICKUP 3/4 TON, R2500 All Exc. Crew Cab & Bonus Cab	
F	66	PICKUP 2500 SERIES All	
F	67-80	VAN 1/2 TON, P SERIES All	
F	75-90	VAN 1 TON, P SERIES All Cutaway Chassis	
F	73-74	VAN 1 TON, P SERIES Base Cutaway Chassis	
F	68-72	VAN 1 TON, P SERIES All	
F	68-89	VAN 3/4 TON, P SERIES All	
F	63-65	VAN, PB 1000 SERIES All	
G63357	C		
F	71-95	CHEVROLET VAN 1/2 TON, G / EXPRESS All	
F	70	VAN 1/2 TON, G / EXPRESS All Independent Front Suspension	
F	76-96	VAN 1 TON, G / EXPRESS All	
F	75	VAN 1 TON, G / EXPRESS 146.0 / 370.8 (WheelBase)	
F	71-74	VAN 1 TON, G / EXPRESS All	
F	71-95	VAN 3/4 TON, G / EXPRESS All	
F	70	VAN 3/4 TON, G / EXPRESS All Independent Front Suspension	
F	71-95	GMC VAN 1/2 TON, G / SAVANA All	
F	70	VAN 1/2 TON, G / SAVANA All Independent Front Suspension	
F	76-95	VAN 1 TON, G / SAVANA All	
F	75	VAN 1 TON, G / SAVANA 146.0 / 370.8 (WheelBase)	
F	71-74	VAN 1 TON, G / SAVANA All	
F	78-95	VAN 3/4 TON, G / SAVANA All Exc. 8600# GVW	
F	71-77	VAN 3/4 TON, G / SAVANA All	
F	70	VAN 3/4 TON, G / SAVANA All Independent Front Suspension	
G63359	B		140126
F	72-93	DODGE PICKUP 3/4 TON, D200 SERIES All Exc. Heavy Duty Package	
F	99-03	VAN 1/2 TON, A / B SERIES / RAM 109.3 / 277.6 (WheelBase) Exc. 7000# GVW	
F	81-98	VAN 1/2 TON, A / B SERIES / RAM 109.6 / 278.4 (WheelBase) Exc. 7000# GVW	
F	71-80	VAN 1/2 TON, A / B SERIES / RAM All Exc. 4000# Front Axle	
F	95-03	VAN 1 TON, A / B SERIES / RAM All	
F	71-94	VAN 1 TON, A / B SERIES / RAM All Exc. 4000# Front Axle	
F	81-03	VAN 3/4 TON, A / B SERIES / RAM All	
F	71-80	VAN 3/4 TON, A / B SERIES / RAM All Exc. 4000# Front Axle	

Numerical listing

Shock	POP	Alternative No.	MTG Acc. Supplied
Pos.	Year	Application	
G63359	B (cont)		140126
F	74-80	VAN, CB300 All Exc. 4000# Front Axle	
F	81-83	PLYMOUTH VAN 1/2 TON, PB SERIES All	
F	74-83	VAN 1 TON, PB SERIES All Exc. 4000# Front Axle	
F	74-83	VAN 3/4 TON, PB SERIES All	
G63360	D		140126
F	72-93	DODGE PICKUP 1 TON, D300 SERIES All Heavy Duty Package	
F	72-93	PICKUP 3/4 TON, D200 SERIES All Heavy Duty Package	
F	71-93	VAN 1 TON, A / B SERIES / RAM All 4000# Front Axle	
F	74-80	VAN, CB300 All 4000# Front Axle	
F	74-83	PLYMOUTH VAN 1 TON, PB SERIES All 4000# Front Axle	
G63366	A		
R	75-86	CHEVROLET PICKUP 1 TON, C30 All	
R	88-91	PICKUP 1 TON, C35/3500 Cab & Chassis Exc. HD Solid Front Axle	
R	87-88	PICKUP 1 TON, R30 All	
R	89	PICKUP 1 TON, R3500 Standard Cab Pickup	
R	75-86	PICKUP 3/4 TON, C20 Crew Cab Pickup	
R	87-88	PICKUP 3/4 TON, R20 Crew Cab Pickup	
R	89	PICKUP 3/4 TON, R2500 All	
R	74-80	VAN 1/2 TON, P SERIES All	
R	73-99	VAN 1 TON, P SERIES All	
R	79-89	VAN 3/4 TON, P SERIES All	
R	88-91	GMC PICKUP 1 TON, C35/3500 Cab & Chassis Exc. HD Solid Front Axle	
R	73-78	PICKUP 1 TON, C35/3500 All	
R	87-91	PICKUP 1 TON, R3500 All	
R	85-86	PICKUP 3/4 TON, C25 / C2500 Crew Cab Pickup	
R	75-83	PICKUP 3/4 TON, C25 / C2500 Crew Cab Pickup	
R	73-74	PICKUP 3/4 TON, C25 / C2500 All Crew Cab	
R	87-89	PICKUP 3/4 TON, R2500 Crew Cab Pickup	
R	74-80	VAN 1/2 TON, P SERIES All	
R	73-99	VAN 1 TON, P SERIES All	
R	79-89	VAN 3/4 TON, P SERIES All	
G63375	A		140780,142615
F	96-02	CHEVROLET VAN 1 TON, G / EXPRESS All	
F	96-02	VAN 3/4 TON, G / EXPRESS All Exc. 8600# GVW	
F	96-02	GMC VAN 1/2 TON, G / SAVANA RWD	
F	96-02	VAN 1 TON, G / SAVANA All	
F	96-02	VAN 3/4 TON, G / SAVANA All Exc. 8600# GVW	
G63377	B		141137
R	75-79	FORD PICKUP 1 TON, F-350 / SUPERDUTY Standard Cab Pickup, RWD	
R	73-74	PICKUP 1 TON, F-350 / SUPERDUTY All RWD; Supercab	
R	75-79	PICKUP 3/4 TON, F-250 / SUPERDUTY Extended Cab Pickup, RWD	
R	65-74	PICKUP 3/4 TON, F-250 / SUPERDUTY All RWD; Supercab	
R	69-74	VAN 1 TON, ECONOLINE / CLUB WAGON / SUPERDUTY All	
R	69-74	VAN 3/4 TON, ECONOLINE / CLUB WAGON / SUPERDUTY All	
G63386	C		140780
F	75-79	FORD PICKUP 1 TON, F-350 / SUPERDUTY RWD RWD, 4WD Quad Suspension Rearward of Front Axle, Non Quad Suspension	
F	67-74	PICKUP 1 TON, F-350 / SUPERDUTY All RWD, 4WD Quad Suspension Rearward of Front Axle, Non Quad Suspension	
F	75-79	PICKUP 3/4 TON, F-250 / SUPERDUTY RWD RWD, 4WD Quad Suspension Rearward of Front Axle, Non Quad Suspension	

Ultra Truck Shock

Shock	POP	Alternative No.	MTG Acc. Supplied
Pos.	Year	Application	
G63386	C (cont)		140780
F	65-74	PICKUP 3/4 TON, F-250 / SUPERDUTY All RWD, 4WD Quad Suspension Rearward of Front Axle, Non Quad Suspension	
F	75-91	VAN 1 TON, ECONOLINE / CLUB WAGON / SUPERDUTY All Cutaway Chassis RWD, 4WD Quad Suspension Rearward of Front Axle, Non Quad Suspension	
F	75-91	VAN 3/4 TON, ECONOLINE / CLUB WAGON / SUPERDUTY All RWD, 4WD Quad Suspension Rearward of Front Axle, Non Quad Suspension	
G63387	D		140126
R	79	FORD PICKUP 1 TON, F-350 / SUPERDUTY 4WD	
R	77-79	PICKUP 3/4 TON, F-250 / SUPERDUTY Cab & Chassis, 4WD All From Serial No. Y20001	
R	77-79	PICKUP 3/4 TON, F-250 / SUPERDUTY Standard Cab Pickup, 4WD All From Serial No. Y20001	
R	75-91	VAN 1 TON, ECONOLINE / CLUB WAGON / SUPERDUTY All Cutaway Chassis	
R	75-91	VAN 3/4 TON, ECONOLINE / CLUB WAGON / SUPERDUTY All	
G63394	D		140702
F	85-99	CHEVROLET VAN 1 TON, P SERIES All Motorhome Chassis w/ Independent Front Suspension	
F	74-84	VAN 1 TON, P SERIES All Motorhome Chassis	
F	85-99	GMC VAN 1 TON, P SERIES All Motorhome Chassis w/ Independent Front Suspension	
F	75-84	VAN 1 TON, P SERIES All Motorhome Chassis	
F	74	VAN 1 TON, P SERIES Motorhome	
G63403	B		
R	79-91	CHEVROLET VAN 1 TON, G / EXPRESS All 9200# GVW	
F	85	VAN 1 TON, P SERIES All Motorhome Chassis w/ I-Beam Front Suspension	
R	93-96	GMC VAN 1 TON, G / SAVANA Cutaway Van 9200# GVW	
R	79-91	VAN 1 TON, G / SAVANA Cutaway Van 9200# GVW	
F	85	VAN 1 TON, P SERIES All Motorhome Chassis w/ I-Beam Front Suspension	
G63405	D		140884
R	61-66	FORD PICKUP 1 TON, F-350 / SUPERDUTY All	
R	61-64	PICKUP 3/4 TON, F-250 / SUPERDUTY All	
F	68-76	PICKUP P350 All Up through 8000# GVW	
F	75-76	PICKUP P400 All Up through 8000# GVW	
R	68-72	INTERNATIONAL M1100 / M1200 All	
R	69	M1400 All	
R	96-04	MITSUBISHI FUSO FE All Model with O.E.M. Number	
R	98-04	FG All Model with O.E.M. Number	
G63409	W		
R	80-97	FORD PICKUP 1 TON, F-350 / SUPERDUTY RWD Dual Rear Wheels	
R	97	PICKUP, F-450 SUPERDUTY All	
G63410	D		141047
F	80-81	FORD PICKUP 1 TON, F-350 / SUPERDUTY 4WD	
F	80-82	PICKUP 3/4 TON, F-250 / SUPERDUTY Standard Cab Pickup, 4WD	
G63411	C		
F	77-86	CHEVROLET PICKUP 1 TON, K30 All	
F	90-91	PICKUP 1 TON, R3500 All	
F	89	PICKUP 1 TON, R3500 Cab & Chassis	
F	89	PICKUP 1 TON, R3500 Crew Cab Pickup	
F	87-88	PICKUP 1 TON, V30 All	
F	89-91	PICKUP 1 TON, V3000 / V3500 All	

Numerical listing

Shock	POP	Alternative No.	MTG Acc. Supplied
Pos.	Year	Application	
G63411	C (cont)		
F	77-86	GMC PICKUP 1 TON, K35 / K3500 All	
F	87-91	PICKUP 1 TON, V3000 / V3500 All	
G63413	B		
R	78-95	CHEVROLET VAN 1/2 TON, G / EXPRESS All	
R	85-95	VAN 1 TON, G / EXPRESS Extended Cargo Van	
R	85-95	VAN 1 TON, G / EXPRESS Extended Passenger Van	
R	78-95	VAN 1 TON, G / EXPRESS Standard Cargo Van	
R	78-95	VAN 1 TON, G / EXPRESS Standard Passenger Van	
R	78	VAN 1 TON, G / EXPRESS Extended Cargo Van	
R	78-95	VAN 3/4 TON, G / EXPRESS All Exc. 8600# GVW	
R	99-03	DODGE VAN 1/2 TON, A / B SERIES / RAM 109.3 / 277.6 (WheelBase) Exc. 7000# GVW	
R	81-98	VAN 1/2 TON, A / B SERIES / RAM 109.6 / 278.4 (WheelBase) Exc. 7000# GVW	
R	71-80	VAN 1/2 TON, A / B SERIES / RAM All	
R	95-03	VAN 1 TON, A / B SERIES / RAM All	
R	94	VAN 1 TON, A / B SERIES / RAM All Exc. 4000# Front Axle	
R	71-93	VAN 1 TON, A / B SERIES / RAM All	
R	71-03	VAN 3/4 TON, A / B SERIES / RAM All	
R	74-80	VAN, CB300 All	
R	78-95	GMC VAN 1/2 TON, G / SAVANA All	
R	85-96	VAN 1 TON, G / SAVANA Extended Cargo Van	
R	85-96	VAN 1 TON, G / SAVANA Extended Passenger Van	
R	79-96	VAN 1 TON, G / SAVANA Standard Cargo Van	
R	79-96	VAN 1 TON, G / SAVANA Standard Passenger Van	
R	78	VAN 1 TON, G / SAVANA Cutaway Van	
R	78-95	VAN 3/4 TON, G / SAVANA All Exc. 8600# GVW	
R	81-83	PLYMOUTH VAN 1/2 TON, PB SERIES All	
R	74-83	VAN 1 TON, PB SERIES All	
R	74-83	VAN 3/4 TON, PB SERIES All	
G63414	A		140780
F	97	FORD F-250 HD RWD	
F	80-97	PICKUP 1 TON, F-350 / SUPERDUTY RWD	
F	97	PICKUP 3/4 TON, F-250 / SUPERDUTY RWD Over 8500# GVW	
F	80-96	PICKUP 3/4 TON, F-250 / SUPERDUTY RWD	
G63419	W		
R	98	HINO FA, FB SERIES	
G63432	W		141349,140169
F		INTERNATIONAL DURASTAR - 1000 SERIES	
F		UD UD 1300	
G63455	C		
F	97	FORD F-250 HD 4WD	
F	86-97	PICKUP 1 TON, F-350 / SUPERDUTY 4WD	
F	97-98	PICKUP 3/4 TON, F-250 / SUPERDUTY 4WD Over 8500# GVW	
F	87-96	PICKUP 3/4 TON, F-250 / SUPERDUTY 4WD	
G63456	W		
R	86-97	FORD PICKUP 1 TON, F-350 / SUPERDUTY 4WD Exc. Dual Rear Wheels	
G63461	B		
R	97	FORD F-250 HD 4WD	
R	86-97	PICKUP 1 TON, F-350 / SUPERDUTY 4WD Dual Rear Wheels	
R	82-85	PICKUP 1 TON, F-350 / SUPERDUTY 4WD Clevis Type Lower Front Mount; Exc. Dual Rear Wheels or Lift Kit	

Numerical listing

Shock	POP	Alternative No.	MTG Acc. Supplied
Pos.	Year	Application	
G63461	B	(cont)	142389
R	80-81	PICKUP 1 TON, F-350 / SUPERDUTY 4WD	
R	97	PICKUP 3/4 TON, F-250 / SUPERDUTY 4WD Over 8500# GVW	
R	86-96	PICKUP 3/4 TON, F-250 / SUPERDUTY 4WD	
R	82-85	PICKUP 3/4 TON, F-250 / SUPERDUTY 4WD Clevis Type Lower Front Mount; Exc. Dual Rear Wheels or Lift Kit	
R	80-81	PICKUP 3/4 TON, F-250 / SUPERDUTY 4WD	
R	99-07	PICKUP, F-450 SUPERDUTY All Models with single or dual rear wheels with 165" or 201" wheel base	
R	99-07	PICKUP, F-550 SUPERDUTY All Models with single or dual rear wheels with 165" or 201" wheel base	
G63488	A		141277
R	92-00	CHEVROLET PICKUP 1 TON, C35/3500 Crew Cab Pickup Exc. HD Straight Front Axle	
R	92-00	PICKUP 1 TON, C35/3500 Standard Cab Pickup Exc. HD Straight Front Axle	
R	88-00	PICKUP 1 TON, C35/3500 Extended Cab Pickup Exc. HD Straight Front Axle	
R	88-90	PICKUP 1 TON, C35/3500 Standard Cab Pickup Exc. HD Straight Front Axle	
R	88-00	PICKUP 1 TON, K35 / K3500 All	
R	88-00	PICKUP 3/4 TON, C25 / C2500 All	
R	88-00	PICKUP 3/4 TON, K25 / K2500 All	
R	92-00	GMC PICKUP 1 TON, C35/3500 Crew Cab Pickup Exc. HD Straight Front Axle	
R	88-00	PICKUP 1 TON, C35/3500 Extended Cab Pickup Exc. HD Straight Front Axle	
R	88-00	PICKUP 1 TON, C35/3500 Standard Cab Pickup Exc. HD Straight Front Axle	
R	88-00	PICKUP 1 TON, K35 / K3500 All	
R	88-00	PICKUP 3/4 TON, C25 / C2500 All	
R	88-00	PICKUP 3/4 TON, K25 / K2500 All	
G63489	A		141277
F	92-00	CHEVROLET PICKUP 1 TON, C35/3500 Crew Cab Pickup Exc. HD Straight Front Axle	
F	88-00	PICKUP 1 TON, C35/3500 Extended Cab Pickup Exc. HD Straight Front Axle	
F	88-00	PICKUP 1 TON, C35/3500 Standard Cab Pickup Exc. HD Straight Front Axle	
F	88-00	PICKUP 3/4 TON, C25 / C2500 All	
F	92-00	GMC PICKUP 1 TON, C35/3500 Crew Cab Pickup Exc. HD Straight Front Axle	
F	88-00	PICKUP 1 TON, C35/3500 Extended Cab Pickup Exc. HD Straight Front Axle	
F	88-00	PICKUP 1 TON, C35/3500 Standard Cab Pickup Exc. HD Straight Front Axle	
F	88-00	PICKUP 3/4 TON, C25 / C2500 All	
G63492	A		141137
F	61-67	FORD ECONOLINE All	
G63607	W		140719
R	00-05	FORD EXCURSION RWD	
G63609	A		142389
F	88-00	CHEVROLET PICKUP 1 TON, K35 / K3500 All	
F	88-00	PICKUP 3/4 TON, K25 / K2500 All	
F	88-00	GMC PICKUP 1 TON, K35 / K3500 All	
F	88-00	PICKUP 3/4 TON, K25 / K2500 All	
G63610	C		142389
F	49-52	CHEVROLET FLEETLINE All	
F	49-52	FLEETLINE TRUCK All	
F	92	HINO FA15 All FA, FB Models Trucks with:	
F	93-97	FA1415 All (FA15)	
F	93-97	FA1415 All FA, FB Models Trucks with:	
F	93-97	FA1415 All FA1415 (FA15), FB1715 (FB15)	

Ultra Truck Shock

Shock	POP	Alternative No.	MTG Acc. Supplied
Pos.	Year	Application	
G63610	C	(cont)	142389
F	98-04	FA1517 All FA, FB Models Trucks with:	
F	89-91	FB14 All FA, FB Models Trucks with:	
F	92	FB15 All FA, FB Models Trucks with:	
F	93-97	FB1715 All FA, FB Models Trucks with:	
F	93-97	FB1715 All FA1415 (FA15), FB1715 (FB15)	
F	98-04	FB1817 All FA, FB Models Trucks with:	
F	05-11	MINIBUS FUSO FE145 All Models with O.E.M. Number	
F	96-04	FE All Models with O.E.M. Number	
F	97-04	FH All Models with O.E.M. Number	
F	99-10	UD UD 18HD SERIES	
F	11-13	UD 1800 SERIES	
F	95-98	UD 1800 SERIES	
F	95-13	UD 2000 SERIES	
G63614	B		140780
F	00-05	FORD EXCURSION RWD	
G63622	A		142617
F	00-02	FORD E-450 ECONOLINE SUPER DUTY All	
F	00-06	ECONOLINE All	
F	20-24	F-600 SUPER DUTY All Applications with OEM Number	
F	99-24	PICKUP 1 TON, F-350 / SUPERDUTY RWD	
F	11-16	PICKUP 1 TON, F-350 / SUPERDUTY All Exc. Off Road	
F	99-09	PICKUP 1 TON, F-350 / SUPERDUTY All Exc. Off Road	
F	23-24	PICKUP 3/4 TON, F-250 / SUPERDUTY RWD	
F	11-22	PICKUP 3/4 TON, F-250 / SUPERDUTY RWD Exc. Off Road	
F	99-10	PICKUP 3/4 TON, F-250 / SUPERDUTY RWD	
F	99-09	PICKUP 3/4 TON, F-250 / SUPERDUTY RWD Exc. Off Road	
F	21-24	VAN 1 TON, ECONOLINE / CLUB WAGON / SUPERDUTY All	
F	99-19	VAN 1 TON, ECONOLINE / CLUB WAGON / SUPERDUTY All	
F	07	VAN 1 TON, ECONOLINE / CLUB WAGON / SUPERDUTY All Exc. Cutaway Chassis	
F	92-05	VAN 1 TON, ECONOLINE / CLUB WAGON / SUPERDUTY All Cutaway Chassis	
F	92-14	VAN 3/4 TON, ECONOLINE / CLUB WAGON / SUPERDUTY All	
G63623	A		142617
R	00-02	FORD E-450 ECONOLINE SUPER DUTY All	
R	00-06	ECONOLINE All	
R	21-24	VAN 1 TON, ECONOLINE / CLUB WAGON / SUPERDUTY All	
R	99-19	VAN 1 TON, ECONOLINE / CLUB WAGON / SUPERDUTY All	
R	04-11	VAN 1 TON, ECONOLINE / CLUB WAGON / SUPERDUTY All Exc. Cutaway Chassis	
R	92-05	VAN 1 TON, ECONOLINE / CLUB WAGON / SUPERDUTY All Cutaway Chassis	
R	92-14	VAN 3/4 TON, ECONOLINE / CLUB WAGON / SUPERDUTY All	
G63625	C		140702
F	86-99	CHEVROLET VAN 1 TON, P SERIES All Motorhome Chassis w/ I-Beam Front Suspension	
F	86-99	GMC VAN 1 TON, P SERIES All Motorhome Chassis w/ I-Beam Front Suspension	
G63638	A		142389
R	97-02	CHEVROLET VAN 1 TON, G / EXPRESS All Exc. 8600# GVW	
R	96-02	VAN 3/4 TON, G / EXPRESS All Exc. 8600# GVW	
R	96-02	GMC VAN 1 TON, G / SAVANA All Exc. 8600# GVW	
R	96-02	VAN 3/4 TON, G / SAVANA All Exc. 8600# GVW	

Numerical listing

Shock	POP	Alternative No.	MTG Acc. Supplied
Pos.	Year	Application	
G63661	C		143000
F	94-02	DODGE PICKUP 1 TON, RAM 3500 (SEE RAM 3500) RWD Exc. Solid Front Axle	
F	94-02	PICKUP 3/4 TON, RAM 2500 (SEE RAM 2500) RWD	
G63662	A		143000
R	94-02	DODGE PICKUP 1 TON, RAM 3500 (SEE RAM 3500) RWD Exc. Solid Front Axle	
R	94-03	PICKUP 3/4 TON, RAM 2500 (SEE RAM 2500) All Exc. 8800# GVW	
G63671	W		143000
R	92-96	CHEVROLET VAN 1 TON, G / EXPRESS Cutaway Van	
R	92-96	GMC VAN 1 TON, G / SAVANA Cutaway Van	
G63673	B		143000
F	03-10	DODGE PICKUP 1 TON, RAM 3500 (SEE RAM 3500) 4WD	
F	94-02	PICKUP 3/4 TON, RAM 2500 (SEE RAM 2500) 4WD Exc. 8800# GVW	
F	11-24	RAM 3500 (SEE DODGE RAM 3500) 4WD	
G63674	D		142731
F	94-02	DODGE PICKUP 1 TON, RAM 3500 (SEE RAM 3500) 4WD	
F	94-02	PICKUP 1 TON, RAM 3500 (SEE RAM 3500) RWD Solid Front Axle	
F	94-02	PICKUP 3/4 TON, RAM 2500 (SEE RAM 2500) 4WD 8800# GVW	
G63675	A		142731
R	77-86	CHEVROLET PICKUP 1 TON, K30 All	
R	90-91	PICKUP 1 TON, R3500 All	
R	89	PICKUP 1 TON, R3500 Cab & Chassis, RWD	
R	89	PICKUP 1 TON, R3500 Crew Cab Pickup, RWD	
R	01-09	PICKUP 1 TON, SILVERADO 3500 All	
R	07-10	PICKUP 1 TON, SILVERADO 3500 HD All	
R	87-88	PICKUP 1 TON, V30 All	
R	89-91	PICKUP 1 TON, V3000 / V3500 All	
R	99-08	PICKUP 3/4 TON, SILVERADO 2500 All	
R	01-10	PICKUP 3/4 TON, SILVERADO 2500 HD All	
R	07	SILVERADO 2500 HD CLASSIC All	
R	94-02	DODGE PICKUP 1 TON, RAM 3500 (SEE RAM 3500) 4WD	
R	94-02	PICKUP 1 TON, RAM 3500 (SEE RAM 3500) RWD Solid Front Axle	
R	94-02	PICKUP 3/4 TON, RAM 2500 (SEE RAM 2500) 4WD 8800# GVW	
R	77-86	GMC PICKUP 1 TON, K35 / K3500 All	
R	87-91	PICKUP 1 TON, V3000 / V3500 All	
R	99-04	SIERRA 2500 All	
R	01-10	SIERRA 2500 HD All	
R	01-06	SIERRA 3500 All	
R	07-10	SIERRA 3500 HD All	
R	13-17	RAM 1500 (SEE DODGE RAM 1500) All	
R	11	1500 (SEE DODGE RAM 1500) All	
R	19	1500 CLASSIC 4WD	
G63692	W		142731
F	97	FORD PICKUP, F-450 SUPERDUTY All	
G63714	B		142731
F	97-99	FORD PICKUP 3/4 TON, F-250 / SUPERDUTY RWD Up through 8500# GVW	
G63715	B		142700
R	97-99	FORD PICKUP 3/4 TON, F-250 / SUPERDUTY 4WD Up through 8500# GVW	
G63716	B		142731
F	97-99	FORD PICKUP 3/4 TON, F-250 / SUPERDUTY 4WD Up through 8500# GVW	
G63778	C		142700
R	97-99	FORD PICKUP 3/4 TON, F-250 / SUPERDUTY RWD Up through 8500# GVW	

Numerical listing

Shock	POP	Alternative No.	MTG Acc. Supplied
Pos.	Year	Application	
G63783 A 141665			
F	99-04	CHEVROLET PICKUP 3/4 TON, SILVERADO 2500 RWD Exc. Electronic Adjustable Suspension	
F	01-04	PICKUP 3/4 TON, SILVERADO 2500 HD RWD	
F	99-04	GMC SIERRA 2500 RWD Exc. Electronic Adjustable Suspension	
F	01-04	SIERRA 2500 HD RWD	
G63808 W			
R	99-04	FORD PICKUP 1 TON, F-350 / SUPERDUTY RWD	
R	99-04	PICKUP 3/4 TON, F-250 / SUPERDUTY RWD	
G63809 A			
F	00-05	FORD EXCURSION 4WD	
R	97	F-250 HD RWD	
F	99-04	PICKUP 1 TON, F-350 / SUPERDUTY 4WD	
R	80-97	PICKUP 1 TON, F-350 / SUPERDUTY RWD Exc. Dual Rear Wheels	
F	99-04	PICKUP 3/4 TON, F-250 / SUPERDUTY 4WD	
R	97	PICKUP 3/4 TON, F-250 / SUPERDUTY RWD Over 8500# GVW	
R	80-96	PICKUP 3/4 TON, F-250 / SUPERDUTY RWD	
F	99-04	PICKUP, F-450 SUPERDUTY All	
F	99-04	PICKUP, F-550 SUPERDUTY All	
G63810 C			
R	99-04	FORD PICKUP 1 TON, F-350 / SUPERDUTY 4WD	
R	99-04	PICKUP 3/4 TON, F-250 / SUPERDUTY 4WD	
G63817 A 141665			
F	01-09	CHEVROLET PICKUP 1 TON, SILVERADO 3500 All	
F	07-10	PICKUP 1 TON, SILVERADO 3500 HD All	
F	05-08	PICKUP 3/4 TON, SILVERADO 2500 All	
F	99-04	PICKUP 3/4 TON, SILVERADO 2500 4WD	
F	05-10	PICKUP 3/4 TON, SILVERADO 2500 HD All 9200# GVW	
F	01-04	PICKUP 3/4 TON, SILVERADO 2500 HD 4WD 9200# GVW	
F	07	SILVERADO 2500 HD CLASSIC All	
F	99-04	GMC SIERRA 2500 4WD	
F	01-10	SIERRA 2500 HD 4WD	
F	01-06	SIERRA 3500 All	
F	07-10	SIERRA 3500 HD Torsion Bar (FrontSpringType)	
G63837 W			
R	00-05	FORD EXCURSION 4WD	
G63886 A 142731			
F	20-24	FORD F-600 SUPER DUTY All Applications with OEM Number	
F	17-24	PICKUP 1 TON, F-350 / SUPERDUTY 4WD	
F	13-16	PICKUP 1 TON, F-350 / SUPERDUTY 4WD Exc. Off Road	
F	11-16	PICKUP 1 TON, F-350 / SUPERDUTY All	
F	05-12	PICKUP 1 TON, F-350 / SUPERDUTY 4WD	
F	99-09	PICKUP 1 TON, F-350 / SUPERDUTY All	
F	01-24	PICKUP 3/4 TON, F-250 / SUPERDUTY 4WD	
F	12-16	PICKUP 3/4 TON, F-250 / SUPERDUTY RWD w/ Off Road Package	
F	99-09	PICKUP 3/4 TON, F-250 / SUPERDUTY RWD w/ Off Road	
F	99	PICKUP 3/4 TON, F-250 / SUPERDUTY 4WD	
G63888 D			
R	13-16	FORD PICKUP 1 TON, F-350 / SUPERDUTY 4WD	
R	05-12	PICKUP 1 TON, F-350 / SUPERDUTY Crew Cab Pickup, 4WD Single Rear Wheels	
R	05-12	PICKUP 1 TON, F-350 / SUPERDUTY Extended Cab Pickup, 4WD Single Rear Wheels	

Ultra Truck Shock, ProGuard

Shock	POP	Alternative No.	MTG Acc. Supplied
Pos.	Year	Application	
G63888 D (cont)			
R	05-12	PICKUP 1 TON, F-350 / SUPERDUTY Standard Cab Pickup, 4WD Single Rear Wheels	
R	13-16	PICKUP 3/4 TON, F-250 / SUPERDUTY RWD	
R	05-12	PICKUP 3/4 TON, F-250 / SUPERDUTY 4WD	
G63893 C 143276			
F	03-12	CHEVROLET VAN 1 TON, G / EXPRESS All Torsion Bar (FrontSpringType)	
F	06-12	VAN 3/4 TON, G / EXPRESS All Torsion Bar (FrontSpringType)	
F	03-05	VAN 3/4 TON, G / EXPRESS Torsion Bar (FrontSpringType)	
F	10-14	GMC VAN 1/2 TON, G / SAVANA AWD, Torsion Bar (FrontSpringType)	
F	03-09	VAN 1/2 TON, G / SAVANA Torsion Bar (FrontSpringType)	
F	03-12	VAN 1 TON, G / SAVANA All Torsion Bar (FrontSpringType)	
F	04-12	VAN 3/4 TON, G / SAVANA All Torsion Bar (FrontSpringType)	
F	03	VAN 3/4 TON, G / SAVANA Torsion Bar (FrontSpringType)	
G63894 B 143276			
F	03-14	GMC VAN 1/2 TON, G / SAVANA RWD, Coil (FrontSpringType)	
G63895 A 143276			
F	09-22	CHEVROLET EXPRESS 4500 All	
F	17-24	VAN 1 TON, G / EXPRESS All	
F	03-16	VAN 1 TON, G / EXPRESS Coil (FrontSpringType)	
F	17-24	VAN 3/4 TON, G / EXPRESS All	
F	03-16	VAN 3/4 TON, G / EXPRESS Coil (FrontSpringType)	
F	10-20	GMC SAVANA 4500 All	
F	17-24	VAN 1 TON, G / SAVANA All	
F	03-16	VAN 1 TON, G / SAVANA Coil (FrontSpringType)	
F	17-24	VAN 3/4 TON, G / SAVANA All	
F	03-16	VAN 3/4 TON, G / SAVANA Coil (FrontSpringType)	
G63896 B			
R	96-14	GMC VAN 1/2 TON, G / SAVANA All	
G63897 A			
R	09-22	CHEVROLET EXPRESS 4500 All	
R	13-24	VAN 1 TON, G / EXPRESS All	
R	03-12	VAN 1 TON, G / EXPRESS All Single Rear Wheels	
R	03-24	VAN 3/4 TON, G / EXPRESS All	
R	10-20	GMC SAVANA 4500 All	
R	13-24	VAN 1 TON, G / SAVANA All	
R	03-12	VAN 1 TON, G / SAVANA All Single Rear Wheels	
R	03-24	VAN 3/4 TON, G / SAVANA All	
G63918 W			
R	07-09	DODGE SPRINTER 2500 All Single Rear Wheels	
R	03-06	SPRINTER 2500 All Exc. Dual Rear Wheels	
R	07-09	SPRINTER 3500 All Single Rear Wheels	
R	03-06	SPRINTER 3500 All Exc. Dual Rear Wheels	
R	02-06	FREIGHTLINER SPRINTER 2500 All	
R	04-06	MERCEDES-BENZ SPRINTER All Exc. Dual Rear Wheels	
G63969 W 143146			
F	05-08	FORD PICKUP, F-450 SUPERDUTY All	
F	05-07	PICKUP, F-550 SUPERDUTY All	
G63971 W			
R	03-10	DODGE PICKUP 1 TON, RAM 3500 (SEE RAM 3500) Crew Cab Pickup, RWD	
R	03-10	PICKUP 3/4 TON, RAM 2500 (SEE RAM 2500) Crew Cab Pickup, RWD	
R	11-20	RAM 3500 (SEE DODGE RAM 3500) Crew Cab Pickup, RWD	
G64009 W 142731			
F	11-20	RAM 2500 (SEE DODGE RAM 2500) 4WD	

Numerical listing

Shock	POP	Alternative No.	MTG Acc. Supplied
Pos.	Year	Application	
G64010 D			
R	05-16	FORD PICKUP 1 TON, F-350 / SUPERDUTY RWD	
R	11-16	PICKUP 3/4 TON, F-250 / SUPERDUTY RWD Exc. Off Road	
R	05-10	PICKUP 3/4 TON, F-250 / SUPERDUTY RWD	
G64011 W 142731			
F	04-10	DODGE PICKUP 3/4 TON, RAM 2500 (SEE RAM 2500) 4WD	
G64013 W			
R	03-10	DODGE PICKUP 3/4 TON, RAM 2500 (SEE RAM 2500) 4WD 8800# GVW	
R	11-13	RAM 2500 (SEE DODGE RAM 2500) 4WD	
G64042 A			
R	12-15	RAM C/V All Exc. Load Leveling	
G64043 C			
F	16-18	RAM 1500 (SEE DODGE RAM 1500) RWD Exc. Air Suspension	
F	11-15	1500 (SEE DODGE RAM 1500) RWD	
F	19-20	1500 CLASSIC RWD Old Body Style	
F	11-20	2500 (SEE DODGE RAM 2500) Standard Cab Pickup, RWD	
F	11-20	3500 (SEE DODGE RAM 3500) Standard Cab Pickup, RWD	
G64089 W			
R	07-20	FREIGHTLINER SPRINTER 3500 All	
R	07-10	MERCEDES-BENZ SPRINTER All	
R	11-20	SPRINTER 3500 All	
G64121 A			
R	15-18	CHEVROLET PICKUP 1 TON, SILVERADO 3500 All	
R	11-13	PICKUP 1 TON, SILVERADO 3500 All	
R	11-24	PICKUP 1 TON, SILVERADO 3500 HD All	
R	11-18	PICKUP 3/4 TON, SILVERADO 2500 All	
R	11-24	PICKUP 3/4 TON, SILVERADO 2500 HD All	
R	11-24	GMC SIERRA 2500 HD All	
R	11-24	SIERRA 3500 HD All	
R	20-24	RAM 3500 (SEE DODGE RAM 3500) All	
G64148 A			
F	11-24	CHEVROLET PICKUP 1 TON, SILVERADO 3500 HD All	
F	11-24	PICKUP 3/4 TON, SILVERADO 2500 HD All	
F	11-24	GMC SIERRA 2500 HD All	
F	11-24	SIERRA 3500 HD All	
G64164 W			
R	12-19	NISSAN NV1500 All	
R	12-19	NV2500 All	
R	12-19	NV3500 All	
G64177 W			
R	25	FORD TRANSIT-150	
R	15-24	TRANSIT-150 All	
R	25	TRANSIT-250	
R	15-24	TRANSIT-250 All	
R	25	TRANSIT-350	
R	15-24	TRANSIT-350 All	
G64268 W			
R	17-24	FORD PICKUP 1 TON, F-350 / SUPERDUTY 4WD	
R	17-23	PICKUP 3/4 TON, F-250 / SUPERDUTY 4WD	
G64269 W			
R	17-24	FORD PICKUP 1 TON, F-350 / SUPERDUTY RWD	
R	17-24	PICKUP 3/4 TON, F-250 / SUPERDUTY RWD	
ProGuard			
61500 A			
R	61-66	FORD PICKUP 1 TON, F-350 / SUPERDUTY All	
R	61-64	PICKUP 3/4 TON, F-250 / SUPERDUTY All	

Numerical listing

Shock	POP	Alternative No.	MTG Acc. Supplied
Pos.	Year	Application	
61500		A (cont)	
F	68-76	PICKUP P350 All Up through 8000# GVW	
F	75-76	PICKUP P400 All Up through 8000# GVW	
R	68-72	INTERNATIONAL M1100 / M1200 All	
R	69	M1400 All	
61506		A	141137
F	61-67	FORD ECONOLINE All	
61516		C	
F	81-86	CHEVROLET PICKUP 3/4 TON, K20 All Quad Suspension Short Shock; Exc. Lift Kit	
F	69-80	PICKUP 3/4 TON, K20 All Exc. Lift Kit	
F	87	PICKUP 3/4 TON, V20 All Exc. Quad Suspension and Lift Kit	
F	69-86	GMC PICKUP 3/4 TON, K25 / K2500 All Exc. Quad Suspension and Lift Kit	
F	87	PICKUP 3/4 TON, V2500 All Quad Suspension Short Shock; Exc. Lift Kit	
61517		C	
F	71-95	CHEVROLET VAN 1/2 TON, G / EXPRESS All	
F	70	VAN 1/2 TON, G / EXPRESS All Independent Front Suspension	
F	78-96	VAN 1 TON, G / EXPRESS All	
F	75	VAN 1 TON, G / EXPRESS 146.0 / 370.8 (WheelBase)	
F	71-74	VAN 1 TON, G / EXPRESS All	
F	78-95	VAN 3/4 TON, G / EXPRESS All Exc. 8600# GVW	
F	71-77	VAN 3/4 TON, G / EXPRESS All	
F	70	VAN 3/4 TON, G / EXPRESS All Independent Front Suspension	
F	71-95	GMC VAN 1/2 TON, G / SAVANA All	
F	70	VAN 1/2 TON, G / SAVANA All Independent Front Suspension	
F	76-95	VAN 1 TON, G / SAVANA All	
F	75	VAN 1 TON, G / SAVANA 110.0 / 279.4 (WheelBase)	
F	75	VAN 1 TON, G / SAVANA 125.0 / 317.5 (WheelBase)	
F	71-74	VAN 1 TON, G / SAVANA All	
F	78-95	VAN 3/4 TON, G / SAVANA All Exc. 8600# GVW	
F	71-77	VAN 3/4 TON, G / SAVANA All	
F	70	VAN 3/4 TON, G / SAVANA All Independent Front Suspension	
61518		C	140126
R	75-79	FORD PICKUP 1 TON, F-350 / SUPERDUTY Extended Cab Pickup, RWD	
R	67-74	PICKUP 1 TON, F-350 / SUPERDUTY RWD Extended Cab	
R	75-79	PICKUP 3/4 TON, F-250 / SUPERDUTY Crew Cab Pickup, RWD	
R	70-74	PICKUP 3/4 TON, F-250 / SUPERDUTY RWD	
R	65-69	PICKUP 3/4 TON, F-250 / SUPERDUTY All RWD	
61519		A	141137
R	75-79	FORD PICKUP 1 TON, F-350 / SUPERDUTY Standard Cab Pickup, RWD	
R	73-74	PICKUP 1 TON, F-350 / SUPERDUTY All RWD; Exc. Supercab	
R	75-79	PICKUP 3/4 TON, F-250 / SUPERDUTY Extended Cab Pickup, RWD	
R	73-74	PICKUP 3/4 TON, F-250 / SUPERDUTY RWD Supercab	
R	65-72	PICKUP 3/4 TON, F-250 / SUPERDUTY All RWD; Supercab	
R	69-74	VAN 1 TON, ECONOLINE / CLUB WAGON / SUPERDUTY All	
R	69-74	VAN 3/4 TON, ECONOLINE / CLUB WAGON / SUPERDUTY All	
61520		A	140780
F	97	FORD F-250 HD RWD	
F	80-97	PICKUP 1 TON, F-350 / SUPERDUTY RWD	
F	97	PICKUP 3/4 TON, F-250 / SUPERDUTY RWD Over 8500# GVW	

ProGuard

Shock	POP	Alternative No.	MTG Acc. Supplied
Pos.	Year	Application	
61520		A (cont)	140780
F	80-96	PICKUP 3/4 TON, F-250 / SUPERDUTY RWD	
61521		B	140780
F	68-79	FORD PICKUP 1 TON, F-350 / SUPERDUTY RWD Quad Suspension Rearward of Front Axle	
F	67	PICKUP 1 TON, F-350 / SUPERDUTY All Quad Suspension Rearward of Front Axle	
F	70-79	PICKUP 3/4 TON, F-250 / SUPERDUTY RWD Quad Suspension Rearward of Front Axle	
F	65-69	PICKUP 3/4 TON, F-250 / SUPERDUTY All RWD; Quad Suspension Rearward of Front Axle	
F	75-91	VAN 1 TON, ECONOLINE / CLUB WAGON / SUPERDUTY All Exc. Cutaway Chassis RWD, 4WD Quad Suspension Rearward of Front Axle, Non Quad Suspension	
F	75-91	VAN 3/4 TON, ECONOLINE / CLUB WAGON / SUPERDUTY All RWD, 4WD Quad Suspension Rearward of Front Axle, Non Quad Suspension	
61522		A	
F	81-86	CHEVROLET PICKUP 3/4 TON, K20 All Quad Suspension Long Shock; Exc. Lift Kit	
F	87	PICKUP 3/4 TON, V20 All Quad Suspension Long Shock; Exc. Lift Kit	
R	78-95	VAN 1/2 TON, G / EXPRESS All	
R	78-95	VAN 1 TON, G / EXPRESS Cutaway Van	
R	78-95	VAN 3/4 TON, G / EXPRESS All Exc. 8600# GVW	
R	99-03	DODGE VAN 1/2 TON, A / B SERIES / RAM 109.3 / 277.6 (WheelBase) Exc. 7000# GVW	
R	81-98	VAN 1/2 TON, A / B SERIES / RAM 109.6 / 278.4 (WheelBase) Exc. 7000# GVW	
R	71-80	VAN 1/2 TON, A / B SERIES / RAM All	
R	71-03	VAN 1 TON, A / B SERIES / RAM All	
R	71-03	VAN 3/4 TON, A / B SERIES / RAM All	
R	74-80	VAN, CB300 All	
F	81-86	GMC PICKUP 3/4 TON, K25 / K2500 All Quad Suspension Long Shock; Exc. Lift Kit	
F	87	PICKUP 3/4 TON, V2500 All Quad Suspension Long Shock; Exc. Lift Kit	
R	78-95	VAN 1/2 TON, G / SAVANA All	
R	85-96	VAN 1 TON, G / SAVANA Extended Cargo Van	
R	85-96	VAN 1 TON, G / SAVANA Extended Passenger Van	
R	79-96	VAN 1 TON, G / SAVANA Standard Cargo Van	
R	79-96	VAN 1 TON, G / SAVANA Standard Passenger Van	
R	78	VAN 1 TON, G / SAVANA Cutaway Van	
R	78-95	VAN 3/4 TON, G / SAVANA All Exc. 8600# GVW	
R	81-83	PLYMOUTH VAN 1/2 TON, PB SERIES All	
R	74-83	VAN 1/2 TON, PB SERIES All	
R	74-83	VAN 3/4 TON, PB SERIES All	
61523		B	140126
F	72-93	DODGE PICKUP 3/4 TON, D200 SERIES All Exc. Heavy Duty Package	
F	99-03	VAN 1/2 TON, A / B SERIES / RAM 109.3 / 277.6 (WheelBase) Exc. 7000# GVW	
F	81-98	VAN 1/2 TON, A / B SERIES / RAM 109.6 / 278.4 (WheelBase) Exc. 7000# GVW	
F	71-80	VAN 1/2 TON, A / B SERIES / RAM All	
F	95-03	VAN 1 TON, A / B SERIES / RAM All	
F	71-94	VAN 1 TON, A / B SERIES / RAM All Exc. 4000# Front Axle	
F	71-03	VAN 3/4 TON, A / B SERIES / RAM All	
F	74-80	VAN, CB300 All Exc. 4000# Front Axle	
F	81-83	PLYMOUTH VAN 1/2 TON, PB SERIES All	

Numerical listing

Shock	POP	Alternative No.	MTG Acc. Supplied
Pos.	Year	Application	
61523		B (cont)	140126
F	74-83	VAN 1 TON, PB SERIES All Exc. 4000# Front Axle	
F	74-83	VAN 3/4 TON, PB SERIES All	
61524		B	140357
R	75-86	CHEVROLET PICKUP 3/4 TON, C20 Standard Cab Pickup	
R	73-74	PICKUP 3/4 TON, C20 All Standard Cab Pickup	
R	73-86	PICKUP 3/4 TON, K20 All Exc. Lift Kit	
R	87	PICKUP 3/4 TON, R20 Standard Cab Pickup	
R	87	PICKUP 3/4 TON, V20 All Exc. Quad Suspension and Lift Kit	
R	73	VAN 1/2 TON, P SERIES All	
R	73-78	VAN 3/4 TON, P SERIES All	
R	75-86	GMC PICKUP 3/4 TON, C25 / C2500 Cab & Chassis	
R	75-86	PICKUP 3/4 TON, C25 / C2500 Standard Cab Pickup	
R	73-74	PICKUP 3/4 TON, C25 / C2500 All Exc. Crew Cab & Bonus Cab	
R	73-86	PICKUP 3/4 TON, K25 / K2500 All Exc. Lift Kit	
R	88-89	PICKUP 3/4 TON, R2500 All Exc. Crew Cab & Bonus Cab	
R	87	PICKUP 3/4 TON, R2500 Cab & Chassis Exc. Crew Cab & Bonus Cab	
R	87	PICKUP 3/4 TON, R2500 Standard Cab Pickup Exc. Crew Cab & Bonus Cab	
R	87	PICKUP 3/4 TON, V2500 All Exc. Lift Kit	
R	73	VAN 1/2 TON, P SERIES All	
R	73-78	VAN 3/4 TON, P SERIES All	
61525		A	140702
F	63-86	CHEVROLET PICKUP 1 TON, C30 All	
F	88-91	PICKUP 1 TON, C35/3500 Cab & Chassis Exc. HD Solid Front Axle	
F	87-88	PICKUP 1 TON, R30 All	
F	89	PICKUP 1 TON, R3500 Standard Cab Pickup	
F	63-86	PICKUP 3/4 TON, C20 All	
F	87-88	PICKUP 3/4 TON, R20 All	
F	89	PICKUP 3/4 TON, R2500 All	
F	63-80	VAN 1/2 TON, P SERIES All	
F	68-90	VAN 1 TON, P SERIES All Cutaway Chassis	
F	68-89	VAN 3/4 TON, P SERIES All	
F	88-91	GMC PICKUP 1 TON, C35/3500 Cab & Chassis Exc. I Beam Front Axle	
F	67-78	PICKUP 1 TON, C35/3500 All	
F	87-91	PICKUP 1 TON, R3500 All	
F	85-86	PICKUP 3/4 TON, C25 / C2500 Crew Cab Pickup	
F	75-86	PICKUP 3/4 TON, C25 / C2500 Cab & Chassis	
F	75-86	PICKUP 3/4 TON, C25 / C2500 Standard Cab Pickup	
F	75-83	PICKUP 3/4 TON, C25 / C2500 Crew Cab Pickup	
F	67-74	PICKUP 3/4 TON, C25 / C2500 All	
F	87-89	PICKUP 3/4 TON, R2500 All Exc. Crew Cab & Bonus Cab	
F	66	PICKUP 2500 SERIES All	
F	67-80	VAN 1/2 TON, P SERIES All	
F	75-90	VAN 1 TON, P SERIES All Cutaway Chassis	
F	73-74	VAN 1 TON, P SERIES Base Cutaway Chassis	
F	68-72	VAN 1 TON, P SERIES All	
F	68-89	VAN 3/4 TON, P SERIES All	
F	63-65	VAN, PB 1000 SERIES All	
61530		A	
R	97	FORD F-250 HD 4WD	
R	86-97	PICKUP 1 TON, F-350 / SUPERDUTY 4WD Dual Rear Wheels	
R	82-85	PICKUP 1 TON, F-350 / SUPERDUTY 4WD Clevis Type Lower Front Mount; Exc. Dual Rear Wheels or Lift Kit	
R	80-81	PICKUP 1 TON, F-350 / SUPERDUTY 4WD	
R	97	PICKUP 3/4 TON, F-250 / SUPERDUTY 4WD Over 8500# GVW	

Numerical listing

Shock	POP	Alternative No.	MTG Acc. Supplied
Pos.	Year	Application	
61530	A	(cont)	
R	87-96	PICKUP 3/4 TON, F-250 / SUPERDUTY 4WD	
R	82-86	PICKUP 3/4 TON, F-250 / SUPERDUTY 4WD Clevis Type Lower Front Mount; Exc. Dual Rear Wheels or Lift Kit	
R	80-81	PICKUP 3/4 TON, F-250 / SUPERDUTY 4WD	
61542	A		
F	88-00	CHEVROLET PICKUP 1 TON, K35 / K3500 All	
F	88-00	PICKUP 3/4 TON, K25 / K2500 All	
F	88-00	GMC PICKUP 1 TON, K35 / K3500 All	
F	88-00	PICKUP 3/4 TON, K25 / K2500 All	
61543	A		
R	91-02	CHEVROLET C3500HD All Solid Front Axle	
R	88-90	PICKUP 1 TON, C35/3500 Extended Cab Pickup Exc. HD Straight Front Axle	
R	88-90	PICKUP 1 TON, C35/3500 Standard Cab Pickup Exc. HD Straight Front Axle	
R	88-00	PICKUP 1 TON, K35 / K3500 All	
R	88-00	PICKUP 3/4 TON, C25 / C2500 All	
R	88-00	PICKUP 3/4 TON, K25 / K2500 All	
R	01-02	GMC C3500HD All	
R	91-00	C3500HD All Solid Front Axle	
R	91-00	PICKUP 1 TON, C35/3500 All Exc. I Beam Front Axle	
R	88-90	PICKUP 1 TON, C35/3500 All Exc. HD Straight Front Axle	
R	88-00	PICKUP 1 TON, K35 / K3500 All	
R	88-00	PICKUP 3/4 TON, C25 / C2500 All	
R	88-00	PICKUP 3/4 TON, K25 / K2500 All	
61544	A	141277	
F	92-00	CHEVROLET PICKUP 1 TON, C35/3500 Crew Cab Pickup Exc. HD Straight Front Axle	
F	88-00	PICKUP 1 TON, C35/3500 Extended Cab Pickup Exc. HD Straight Front Axle	
F	88-00	PICKUP 1 TON, C35/3500 Standard Cab Pickup Exc. HD Straight Front Axle	
F	88-00	PICKUP 3/4 TON, C25 / C2500 All	
F	92-00	GMC PICKUP 1 TON, C35/3500 Crew Cab Pickup Exc. HD Straight Front Axle	
F	88-00	PICKUP 1 TON, C35/3500 Extended Cab Pickup Exc. HD Straight Front Axle	
F	88-00	PICKUP 1 TON, C35/3500 Standard Cab Pickup Exc. HD Straight Front Axle	
F	88-00	PICKUP 3/4 TON, C25 / C2500 All	
61546	C	141047	
F	80-81	FORD PICKUP 1 TON, F-350 / SUPERDUTY 4WD	
F	80-82	PICKUP 3/4 TON, F-250 / SUPERDUTY 4WD	
61547	A		
R	97	FORD F-250 HD RWD	
R	80-97	PICKUP 1 TON, F-350 / SUPERDUTY RWD Exc. Dual Rear Wheels	
R	97	PICKUP 3/4 TON, F-250 / SUPERDUTY RWD Over 8500# GVW	
R	80-96	PICKUP 3/4 TON, F-250 / SUPERDUTY RWD	
61554	C		
R	80-97	FORD PICKUP 1 TON, F-350 / SUPERDUTY RWD Dual Rear Wheels	
R	97	PICKUP, F-450 SUPERDUTY All	
61555	B	142615	
F	96-02	CHEVROLET VAN 1 TON, G / EXPRESS All	
F	96-02	VAN 3/4 TON, G / EXPRESS All Exc. 8600# GVW	
F	96-02	GMC VAN 1/2 TON, G / SAVANA All	
F	96-02	VAN 1 TON, G / SAVANA All	
F	96-02	VAN 3/4 TON, G / SAVANA All Exc. 8600# GVW	

ProGuard

Shock	POP	Alternative No.	MTG Acc. Supplied
Pos.	Year	Application	
61565	C		
R	97-02	CHEVROLET VAN 1 TON, G / EXPRESS All	
R	96	VAN 1 TON, G / EXPRESS All Exc. 8600# GVW	
R	96-02	VAN 3/4 TON, G / EXPRESS All Exc. 8600# GVW	
R	03-11	GMC VAN 1/2 TON, G / SAVANA All Exc. Upfitter Package and Cutaway Chassis	
R	96-02	VAN 1/2 TON, G / SAVANA All	
R	96-02	VAN 1 TON, G / SAVANA All Exc. 8600# GVW	
R	96-02	VAN 3/4 TON, G / SAVANA All Exc. 8600# GVW	
61591	D	140780	
F	02-14	FORD VAN 1/2 TON, ECONOLINE / CLUB WAGON All	
F	92-11	VAN 1 TON, ECONOLINE / CLUB WAGON / SUPERDUTY All	
F	92-02	VAN 3/4 TON, ECONOLINE / CLUB WAGON / SUPERDUTY All	
61592	W	142389	
R	49-52	CHEVROLET FLEETLINE All	
R	49-52	FLEETLINE TRUCK All	
61599	B	143000	
F	94-02	DODGE PICKUP 1 TON, RAM 3500 (SEE RAM 3500) RWD Exc. Solid Front Axle	
F	94-02	PICKUP 3/4 TON, RAM 2500 (SEE RAM 2500) RWD	
61600	A		
R	94-02	DODGE PICKUP 1 TON, RAM 3500 (SEE RAM 3500) RWD Exc. Solid Front Axle	
R	94-03	PICKUP 3/4 TON, RAM 2500 (SEE RAM 2500) All Exc. 8800# GVW	
61611	B	142731	
F	96-99	FORD PICKUP 3/4 TON, F-250 / SUPERDUTY RWD Up through 8500# GVW	
61612	C	142700	
R	97-99	FORD PICKUP 3/4 TON, F-250 / SUPERDUTY 4WD Up through 8500# GVW	
61613	B	142731	
F	97-99	FORD PICKUP 3/4 TON, F-250 / SUPERDUTY 4WD Up through 8500# GVW	
61614	D		
F	97	FORD F-250 HD 4WD	
F	86-97	PICKUP 1 TON, F-350 / SUPERDUTY 4WD	
F	97-98	PICKUP 3/4 TON, F-250 / SUPERDUTY 4WD Over 8500# GVW	
F	87-96	PICKUP 3/4 TON, F-250 / SUPERDUTY 4WD	
61632	W		
F	81-93	DODGE PICKUP 1 TON, W300 SERIES All Exc. Quad Suspension and Lift Kit	
F	61-80	PICKUP 1 TON, W300 SERIES All	
R	61-71	PICKUP 1 TON, W300 SERIES All	
F	90-93	PICKUP 3/4 TON, W200 SERIES Extended Cab Pickup Exc. Lift Kit	
F	88-93	PICKUP 3/4 TON, W200 SERIES Cab & Chassis Exc. Lift Kit	
F	81-93	PICKUP 3/4 TON, W200 SERIES Standard Cab Pickup Exc. Lift Kit	
F	86	PICKUP 3/4 TON, W200 SERIES Cab & Chassis Exc. Lift Kit	
F	81-83	PICKUP 3/4 TON, W200 SERIES Cab & Chassis Exc. Lift Kit	
F	81-82	PICKUP 3/4 TON, W200 SERIES Extended Cab Pickup Exc. Lift Kit	
F	69-80	PICKUP 3/4 TON, W200 SERIES All	
F	61-67	PICKUP 3/4 TON, W200 SERIES All	
61634	W	142731	
F	94-02	DODGE PICKUP 3/4 TON, RAM 2500 (SEE RAM 2500) 4WD Exc. 8800# GVW	
61635	C	142731	
F	94-02	DODGE PICKUP 1 TON, RAM 3500 (SEE RAM 3500) 4WD	

Numerical listing

Shock	POP	Alternative No.	MTG Acc. Supplied
Pos.	Year	Application	
61635	C	(cont)	
F	94-02	PICKUP 1 TON, RAM 3500 (SEE RAM 3500) RWD Solid Front Axle	142731
F	94-02	PICKUP 3/4 TON, RAM 2500 (SEE RAM 2500) 4WD 8800# GVW	
61638	C	142700	
R	97-99	FORD PICKUP 3/4 TON, F-250 / SUPERDUTY RWD Up through 8500# GVW	
61641	A	141665	
F	99-04	CHEVROLET PICKUP 3/4 TON, SILVERADO 2500 RWD Exc. Electronic Adjustable Suspension	
F	01-04	PICKUP 3/4 TON, SILVERADO 2500 HD RWD	
F	99-04	GMC SIERRA 2500 RWD Exc. Electronic Adjustable Suspension	
F	01-04	SIERRA 2500 HD RWD	
61642	A		
R	77-86	CHEVROLET PICKUP 1 TON, K30 All	
R	90-91	PICKUP 1 TON, R3500 All	
R	89	PICKUP 1 TON, R3500 Cab & Chassis, RWD	
R	89	PICKUP 1 TON, R3500 Crew Cab Pickup, RWD	
R	01-09	PICKUP 1 TON, SILVERADO 3500 All	
R	07-10	PICKUP 1 TON, SILVERADO 3500 HD All	
R	87-88	PICKUP 1 TON, V30 All	
R	89-91	PICKUP 1 TON, V3000 / V3500 All	
R	99-08	PICKUP 3/4 TON, SILVERADO 2500 All	
R	01-10	PICKUP 3/4 TON, SILVERADO 2500 HD All	
R	07	SILVERADO 2500 HD CLASSIC All	
R	94-02	DODGE PICKUP 1 TON, RAM 3500 (SEE RAM 3500) 4WD	
R	94-02	PICKUP 1 TON, RAM 3500 (SEE RAM 3500) RWD Solid Front Axle	
R	94-02	PICKUP 3/4 TON, RAM 2500 (SEE RAM 2500) 4WD 8800# GVW	
R	77-86	GMC PICKUP 1 TON, K35 / K3500 All	
R	87-91	PICKUP 1 TON, V3000 / V3500 All	
R	99-04	SIERRA 2500 All	
R	01-10	SIERRA 2500 HD All	
R	01-06	SIERRA 3500 All	
R	07	SIERRA 3500 CLASSIC All	
R	07-10	SIERRA 3500 HD All	
61646	W	142617	
R	00-02	FORD E-450 ECONOLINE SUPER DUTY All	
R	00-06	ECONOLINE All	
R	21-24	VAN 1 TON, ECONOLINE / CLUB WAGON / SUPERDUTY All	
R	92-19	VAN 1 TON, ECONOLINE / CLUB WAGON / SUPERDUTY All	
R	04-11	VAN 1 TON, ECONOLINE / CLUB WAGON / SUPERDUTY All Exc. Cutaway Chassis	
R	92-14	VAN 3/4 TON, ECONOLINE / CLUB WAGON / SUPERDUTY All	
61654	W		
R	99-04	FORD PICKUP 1 TON, F-350 / SUPERDUTY RWD	
R	99-04	PICKUP 3/4 TON, F-250 / SUPERDUTY RWD	
61655	B		
R	02	FORD E-550 ECONOLINE SUPER DUTY All	
R	03	E-550 SUPER DUTY All	
F	99-04	PICKUP 1 TON, F-350 / SUPERDUTY 4WD	
F	99-04	PICKUP 3/4 TON, F-250 / SUPERDUTY 4WD	
F	99-04	PICKUP, F-450 SUPERDUTY All	
F	99-04	PICKUP, F-550 SUPERDUTY All	
61656	C		
R	99-04	FORD PICKUP 1 TON, F-350 / SUPERDUTY 4WD	
R	99-04	PICKUP 3/4 TON, F-250 / SUPERDUTY 4WD	
61663	A	141665	
F	01-09	CHEVROLET PICKUP 1 TON, SILVERADO 3500 All	

Numerical listing

Shock	POP	Alternative No.	MTG Acc. Supplied
Pos.	Year	Application	
61663	A (cont)		141665
F	07-10	PICKUP 1 TON, SILVERADO 3500 HD All	
F	05-08	PICKUP 3/4 TON, SILVERADO 2500 All	
F	99-04	PICKUP 3/4 TON, SILVERADO 2500 4WD	
F	05-10	PICKUP 3/4 TON, SILVERADO 2500 HD All 9200# GVW	
F	01-04	PICKUP 3/4 TON, SILVERADO 2500 HD 4WD 9200# GVW	
F	07	SILVERADO 2500 HD CLASSIC All	
F	99-04	GMC SIERRA 2500 4WD	
F	01-10	SIERRA 2500 HD 4WD	
F	01-06	SIERRA 3500 All	
F	07	SIERRA 3500 CLASSIC All	
F	07-10	SIERRA 3500 HD Torsion Bar (FrontSpringType)	
61680	A		142731
F	05-24	FORD PICKUP 1 TON, F-350 / SUPERDUTY 4WD	
F	11-16	PICKUP 1 TON, F-350 / SUPERDUTY All	
F	99-09	PICKUP 1 TON, F-350 / SUPERDUTY All	
F	01-24	PICKUP 3/4 TON, F-250 / SUPERDUTY 4WD	
F	99	PICKUP 3/4 TON, F-250 / SUPERDUTY 4WD	
61682	B		
R	13-16	FORD PICKUP 1 TON, F-350 / SUPERDUTY 4WD w/ Off Road Package	
R	05-12	PICKUP 1 TON, F-350 / SUPERDUTY Crew Cab Pickup, 4WD Single Rear Wheels	
R	05-12	PICKUP 1 TON, F-350 / SUPERDUTY Extended Cab Pickup, 4WD Single Rear Wheels	
R	05-12	PICKUP 1 TON, F-350 / SUPERDUTY Standard Cab Pickup, 4WD Single Rear Wheels	
R	12-16	PICKUP 3/4 TON, F-250 / SUPERDUTY RWD w/ Off Road Package	
R	05-16	PICKUP 3/4 TON, F-250 / SUPERDUTY 4WD	
61683	W		143276
F	06-12	CHEVROLET VAN 3/4 TON, G / EXPRESS All Torsion Bar (FrontSpringType)	
F	03-05	VAN 3/4 TON, G / EXPRESS Torsion Bar (FrontSpringType)	
F	10-14	GMC VAN 1/2 TON, G / SAVANA AWD, Torsion Bar (FrontSpringType)	
F	04-09	VAN 1/2 TON, G / SAVANA Torsion Bar (FrontSpringType)	
F	03	VAN 1/2 TON, G / SAVANA Torsion Bar (FrontSpringType) Torsion Bar (FrontSpringType)	
F	06-12	VAN 3/4 TON, G / SAVANA All Torsion Bar (FrontSpringType)	
F	03-05	VAN 3/4 TON, G / SAVANA AWD, Torsion Bar (FrontSpringType)	
61684	D		143276
F	03-14	GMC VAN 1/2 TON, G / SAVANA RWD, Coil (FrontSpringType)	
61685	A		143078
F	09-22	CHEVROLET EXPRESS 4500 All	
F	10-24	VAN 1 TON, G / EXPRESS All	
F	10-24	VAN 3/4 TON, G / EXPRESS All	
F	10-20	GMC SAVANA 4500 All	
F	10-24	VAN 1 TON, G / SAVANA All	
F	10-24	VAN 3/4 TON, G / SAVANA All	
61687	A		
R	09-22	CHEVROLET EXPRESS 4500 All	
R	25	VAN 1 TON, G / EXPRESS All	
R	13-23	VAN 1 TON, G / EXPRESS All	
R	03-12	VAN 1 TON, G / EXPRESS All Single Rear Wheels	
R	03-24	VAN 3/4 TON, G / EXPRESS All	
R	10-20	GMC SAVANA 4500 All	
R	25	VAN 1 TON, G / SAVANA All	
R	13-23	VAN 1 TON, G / SAVANA All	
R	03-12	VAN 1 TON, G / SAVANA All Single Rear Wheels	
R	25	VAN 3/4 TON, G / SAVANA All	
R	03-23	VAN 3/4 TON, G / SAVANA All	

ProGuard, Max Control

Shock	POP	Alternative No.	MTG Acc. Supplied
Pos.	Year	Application	
61710	W		
R	03-07	DODGE PICKUP 1 TON, RAM 3500 (SEE RAM 3500) Crew Cab Pickup, RWD	
R	03-10	PICKUP 3/4 TON, RAM 2500 (SEE RAM 2500) Crew Cab Pickup, RWD	
61713	D		
R	05-16	FORD PICKUP 1 TON, F-350 / SUPERDUTY RWD Exc. Off Road	
R	05-16	PICKUP 3/4 TON, F-250 / SUPERDUTY RWD Exc. Off Road	
61714	D		142731
F	04-10	DODGE PICKUP 3/4 TON, RAM 2500 (SEE RAM 2500) 4WD	
61716	C		
R	03-10	DODGE PICKUP 3/4 TON, RAM 2500 (SEE RAM 2500) 4WD	
R	11-13	RAM 2500 (SEE DODGE RAM 2500) 4WD	
Max Control			
77375	C		140780
F	96-02	CHEVROLET VAN 1 TON, G / EXPRESS All	
F	96-02	VAN 3/4 TON, G / EXPRESS All Exc. 8600# GVW	
F	96-02	GMC VAN 1/2 TON, G / SAVANA RWD	
F	96-02	VAN 1 TON, G / SAVANA All	
F	96-02	VAN 3/4 TON, G / SAVANA All Exc. 8600# GVW	
77403	D		
R	79-95	CHEVROLET VAN 1 TON, G / EXPRESS All 9200# GVW	
F	85	VAN 1 TON, P SERIES All Motorhome Chassis w/ I-Beam Front Suspension	
R	79-95	GMC VAN 1 TON, G / SAVANA Cutaway Van 9200# GVW	
F	85	VAN 1 TON, P SERIES All Motorhome Chassis w/ I-Beam Front Suspension	
77412	A		
R	77-86	CHEVROLET PICKUP 1 TON, K30 All	
R	90-91	PICKUP 1 TON, R3500 All	
R	89	PICKUP 1 TON, R3500 Cab & Chassis, RWD	
R	89	PICKUP 1 TON, R3500 Crew Cab Pickup, RWD	
R	01-09	PICKUP 1 TON, SILVERADO 3500 All	
R	08-10	PICKUP 1 TON, SILVERADO 3500 HD All	
R	07	PICKUP 1 TON, SILVERADO 3500 HD All Classic	
R	87-88	PICKUP 1 TON, V30 All	
R	89-91	PICKUP 1 TON, V3000 / V3500 All	
R	99-08	PICKUP 3/4 TON, SILVERADO 2500 All	
R	01-10	PICKUP 3/4 TON, SILVERADO 2500 HD All	
R	07	SILVERADO 2500 HD CLASSIC All	
R	77-86	GMC PICKUP 1 TON, K35 / K3500 All	
R	87-91	PICKUP 1 TON, V3000 / V3500 All	
R	99-04	SIERRA 2500 All	
R	01-10	SIERRA 2500 HD All	
R	07	SIERRA 2500 HD CLASSIC 4WD	
R	01-06	SIERRA 3500 All	
R	07	SIERRA 3500 CLASSIC All	
R	07-10	SIERRA 3500 HD All	
R	11-18	RAM 1500 (SEE DODGE RAM 1500) All	
R	19-20	1500 CLASSIC All	
77414	C		140780
F	97	FORD F-250 HD 4WD	
F	80-97	PICKUP 1 TON, F-350 / SUPERDUTY RWD	
F	97	PICKUP 3/4 TON, F-250 / SUPERDUTY RWD Over 8500# GVW	
F	80-96	PICKUP 3/4 TON, F-250 / SUPERDUTY RWD	
77455	C		
F	86-97	FORD PICKUP 1 TON, F-350 / SUPERDUTY 4WD	

Numerical listing

Shock	POP	Alternative No.	MTG Acc. Supplied
Pos.	Year	Application	
77455	C (cont)		
F	97-98	PICKUP 3/4 TON, F-250 / SUPERDUTY 4WD Over 8500# GVW	
F	87-96	PICKUP 3/4 TON, F-250 / SUPERDUTY 4WD	
77461	B		
R	97	FORD F-250 HD 4WD	
R	86-97	PICKUP 1 TON, F-350 / SUPERDUTY 4WD Dual Rear Wheels	
R	82-85	PICKUP 1 TON, F-350 / SUPERDUTY 4WD Clevis Type Lower Front Mount; Exc. Dual Rear Wheels or Lift Kit	
R	80-81	PICKUP 1 TON, F-350 / SUPERDUTY 4WD	
R	97	PICKUP 3/4 TON, F-250 / SUPERDUTY 4WD Over 8500# GVW	
R	87-96	PICKUP 3/4 TON, F-250 / SUPERDUTY 4WD	
R	82-86	PICKUP 3/4 TON, F-250 / SUPERDUTY 4WD Clevis Type Lower Front Mount; Exc. Dual Rear Wheels or Lift Kit	
R	80-81	PICKUP 3/4 TON, F-250 / SUPERDUTY 4WD	
R	99-04	PICKUP, F-450 SUPERDUTY All	
R	99-04	PICKUP, F-550 SUPERDUTY All	
77488	B		
R	91-00	CHEVROLET PICKUP 1 TON, C35/3500 All	
R	89-90	PICKUP 1 TON, C35/3500 Extended Cab Pickup	
R	89-90	PICKUP 1 TON, C35/3500 Standard Cab Pickup	
R	88	PICKUP 1 TON, C35/3500 Extended Cab Pickup Exc. HD Straight Front Axle	
R	88	PICKUP 1 TON, C35/3500 Standard Cab Pickup Exc. HD Straight Front Axle	
R	88-00	PICKUP 1 TON, K35 / K3500 All	
R	88-00	PICKUP 3/4 TON, C25 / C2500 All	
R	88-00	PICKUP 3/4 TON, K25 / K2500 All	
R	91-00	GMC PICKUP 1 TON, C35/3500 All	
R	88-90	PICKUP 1 TON, C35/3500 Extended Cab Pickup Exc. HD Straight Front Axle	
R	88-90	PICKUP 1 TON, C35/3500 Standard Cab Pickup Exc. HD Straight Front Axle	
R	88-00	PICKUP 1 TON, K35 / K3500 All	
R	88-00	PICKUP 3/4 TON, C25 / C2500 All	
R	88-00	PICKUP 3/4 TON, K25 / K2500 All	
77489	C		
F	98-00	CHEVROLET PICKUP 1 TON, C35/3500 All Exc. HD Straight Front Axle	
F	92-97	PICKUP 1 TON, C35/3500 Crew Cab Pickup Exc. HD Straight Front Axle	
F	88-97	PICKUP 1 TON, C35/3500 Extended Cab Pickup Exc. HD Straight Front Axle	
F	88-97	PICKUP 1 TON, C35/3500 Standard Cab Pickup Exc. HD Straight Front Axle	
F	88-00	PICKUP 3/4 TON, C25 / C2500 All	
F	92-00	GMC PICKUP 1 TON, C35/3500 Crew Cab Pickup Exc. HD Straight Front Axle	
F	88-00	PICKUP 1 TON, C35/3500 Extended Cab Pickup Exc. HD Straight Front Axle	
F	88-00	PICKUP 1 TON, C35/3500 Standard Cab Pickup Exc. HD Straight Front Axle	
F	88-00	PICKUP 3/4 TON, C25 / C2500 All	
77607	W		140719
R	00-05	FORD EXCURSION RWD	
77608	W		140780
F	02-14	FORD VAN 1/2 TON, ECONOLINE / CLUB WAGON All	
77609	A		
F	88-00	CHEVROLET PICKUP 1 TON, K35 / K3500 All	
F	88-00	PICKUP 3/4 TON, K25 / K2500 All	

Numerical listing

Shock	POP	Alternative No.	MTG Acc. Supplied
Pos.	Year	Application	
77609	A (cont)		
F	88-00	GMC PICKUP 1 TON, K35 / K3500 All	
F	88-00	PICKUP 3/4 TON, K25 / K2500 All	
77614	A		140780
F	00-02	FORD E-450 ECONOLINE SUPER DUTY All	
F	96-99	ECONOLINE SUPER DUTY All	
F	00-05	EXCURSION RWD	
F	21-24	VAN 1 TON, ECONOLINE / CLUB WAGON / SUPERDUTY All	
F	07-19	VAN 1 TON, ECONOLINE / CLUB WAGON / SUPERDUTY All Exc. Cutaway Chassis	
F	99-19	VAN 1 TON, ECONOLINE / CLUB WAGON / SUPERDUTY All	
F	92-05	VAN 1 TON, ECONOLINE / CLUB WAGON / SUPERDUTY All Cutaway Chassis	
F	92-14	VAN 3/4 TON, ECONOLINE / CLUB WAGON / SUPERDUTY All	
77623	D		142731
R	00-02	FORD E-450 ECONOLINE SUPER DUTY All	
R	00-02	E-450 ECONOLINE SUPER DUTY All Exc. Cutaway Chassis	
R	96-99	ECONOLINE SUPER DUTY All	
R	21-24	VAN 1 TON, ECONOLINE / CLUB WAGON / SUPERDUTY All	
R	03-19	VAN 1 TON, ECONOLINE / CLUB WAGON / SUPERDUTY All Exc. Cutaway Chassis	
R	07-08	VAN 1 TON, ECONOLINE / CLUB WAGON / SUPERDUTY All	
R	92-05	VAN 1 TON, ECONOLINE / CLUB WAGON / SUPERDUTY All Cutaway Chassis	
R	99-03	VAN 1 TON, ECONOLINE / CLUB WAGON / SUPERDUTY All	
R	92-14	VAN 3/4 TON, ECONOLINE / CLUB WAGON / SUPERDUTY All	
77638	A		
R	09-22	CHEVROLET EXPRESS 4500 All	
R	03-24	VAN 1 TON, G / EXPRESS All	
R	03-24	VAN 3/4 TON, G / EXPRESS All	
R	96-02	VAN 3/4 TON, G / EXPRESS All Exc. 8600# GVW	
R	10-20	GMC SAVANA 4500 All	
R	96-14	VAN 1/2 TON, G / SAVANA RWD	
R	04-24	VAN 1 TON, G / SAVANA All	
R	96-02	VAN 1 TON, G / SAVANA All Exc. 8600# GVW	
R	96	VAN 1 TON, G / SAVANA All 7100, 7400 and 8600# GVW	
R	03-24	VAN 3/4 TON, G / SAVANA All	
R	96-02	VAN 3/4 TON, G / SAVANA All Exc. 8600# GVW	
77661	D		
F	94-02	DODGE PICKUP 1 TON, RAM 3500 (SEE RAM 3500) RWD Exc. Solid Front Axle	
F	94-02	PICKUP 3/4 TON, RAM 2500 (SEE RAM 2500) RWD	
77662	C		
R	74-80	CHEVROLET VAN 1/2 TON, P SERIES All	
R	79-89	VAN 3/4 TON, P SERIES All	
R	94-02	DODGE PICKUP 1 TON, RAM 3500 (SEE RAM 3500) RWD Exc. Solid Front Axle	
R	94-02	PICKUP 3/4 TON, RAM 2500 (SEE RAM 2500) All Exc. 8800# GVW	
R	74-80	GMC VAN 1/2 TON, P SERIES All	
R	75-99	VAN 1 TON, P SERIES All	
R	73-74	VAN 1 TON, P SERIES Base Cutaway Chassis	
R	74	VAN 1 TON, P SERIES Motorhome	
77673	W		142731
F	94-02	DODGE PICKUP 3/4 TON, RAM 2500 (SEE RAM 2500) 4WD Exc. 8800# GVW	
77674	D		142731
F	94-02	DODGE PICKUP 1 TON, RAM 3500 (SEE RAM 3500) 4WD	
F	94-02	PICKUP 1 TON, RAM 3500 (SEE RAM 3500) RWD Solid Front Axle	
F	94-02	PICKUP 3/4 TON, RAM 2500 (SEE RAM 2500) 4WD 8800# GVW	

Max Control

Shock	POP	Alternative No.	MTG Acc. Supplied
Pos.	Year	Application	
77675	D		
R	94-02	DODGE PICKUP 1 TON, RAM 3500 (SEE RAM 3500) 4WD	
R	94-02	PICKUP 1 TON, RAM 3500 (SEE RAM 3500) RWD Solid Front Axle	
R	94-02	PICKUP 3/4 TON, RAM 2500 (SEE RAM 2500) 4WD 8800# GVW	
77714	W		142731
F	96-99	FORD PICKUP 3/4 TON, F-250 / SUPERDUTY RWD Up through 8500# GVW	
77715	C		142700
R	97-99	FORD PICKUP 3/4 TON, F-250 / SUPERDUTY 4WD Up through 8500# GVW	
77716	A		142731
F	97-99	FORD PICKUP 3/4 TON, F-250 / SUPERDUTY 4WD Up through 8500# GVW	
77783	C		141665
F	99-04	CHEVROLET PICKUP 3/4 TON, SILVERADO 2500 RWD Exc. Electronic Adjustable Suspension	
F	01-04	PICKUP 3/4 TON, SILVERADO 2500 HD RWD	
F	99-04	GMC SIERRA 2500 RWD Exc. Electronic Adjustable Suspension	
F	01-04	SIERRA 2500 HD RWD	
77807	C		142617
F	99-24	FORD PICKUP 1 TON, F-350 / SUPERDUTY RWD	
F	11-16	PICKUP 1 TON, F-350 / SUPERDUTY All	
F	99-09	PICKUP 1 TON, F-350 / SUPERDUTY All	
F	99-24	PICKUP 3/4 TON, F-250 / SUPERDUTY RWD	
77808	W		
R	99-04	FORD PICKUP 1 TON, F-350 / SUPERDUTY RWD	
R	99-04	PICKUP 3/4 TON, F-250 / SUPERDUTY RWD	
77809	A		
F	00-05	FORD EXCURSION 4WD	
R	97	F-250 HD All	
F	99-04	PICKUP 1 TON, F-350 / SUPERDUTY 4WD	
R	80-97	PICKUP 1 TON, F-350 / SUPERDUTY RWD Exc. Dual Rear Wheels	
F	99-04	PICKUP 3/4 TON, F-250 / SUPERDUTY 4WD	
R	97	PICKUP 3/4 TON, F-250 / SUPERDUTY RWD Over 8500# GVW	
R	80-96	PICKUP 3/4 TON, F-250 / SUPERDUTY RWD	
F	99-04	PICKUP, F-450 SUPERDUTY All	
F	99-04	PICKUP, F-550 SUPERDUTY All	
77810	A		
R	99-04	FORD PICKUP 1 TON, F-350 / SUPERDUTY 4WD	
R	99-04	PICKUP 3/4 TON, F-250 / SUPERDUTY 4WD	
77817	A		141665
F	01-09	CHEVROLET PICKUP 1 TON, SILVERADO 3500 All	
F	07-10	PICKUP 1 TON, SILVERADO 3500 HD All	
F	05-08	PICKUP 3/4 TON, SILVERADO 2500 All	
F	99-04	PICKUP 3/4 TON, SILVERADO 2500 4WD	
F	01-10	PICKUP 3/4 TON, SILVERADO 2500 HD All 9200# GVW	
F	07	SILVERADO 2500 HD CLASSIC All	
F	99-04	GMC SIERRA 2500 4WD	
F	01-10	SIERRA 2500 HD 4WD	
F	01-06	SIERRA 3500 All	
F	07-10	SIERRA 3500 HD Torsion Bar (FrontSpringType)	
77837	W		
R	00-05	FORD EXCURSION 4WD	
77948	B		142731
F	07-10	DODGE PICKUP 1 TON, RAM 3500 (SEE RAM 3500) 4WD	

Numerical listing

Shock	POP	Alternative No.	MTG Acc. Supplied
Pos.	Year	Application	
77948	B (cont)		142731
F	06	PICKUP 1 TON, RAM 3500 (SEE RAM 3500) 4WD Exc. 5.9L	
F	03-05	PICKUP 1 TON, RAM 3500 (SEE RAM 3500) 4WD	
F	07-10	PICKUP 3/4 TON, RAM 2500 (SEE RAM 2500) 4WD	
F	06	PICKUP 3/4 TON, RAM 2500 (SEE RAM 2500) 4WD, 4.7L 8Cyl V (287), 3.66 93.0(Bore)3.41 86.5(Stroke)	
F	06	PICKUP 3/4 TON, RAM 2500 (SEE RAM 2500) 4WD, 5.9L 6Cyl L (359), 4.02 102.0(Bore)4.72 120.0(Stroke)	
F	03-05	PICKUP 3/4 TON, RAM 2500 (SEE RAM 2500) 4WD	
F	11-20	RAM 2500 (SEE DODGE RAM 2500) 4WD	
F	11-20	3500 (SEE DODGE RAM 3500) 4WD	
77949	W		143000
F	03-10	DODGE PICKUP 1 TON, RAM 3500 (SEE RAM 3500) RWD	
F	03-10	PICKUP 3/4 TON, RAM 2500 (SEE RAM 2500) RWD	
F	14-20	RAM 2500 (SEE DODGE RAM 2500) RWD	
F	11-13	2500 (SEE DODGE RAM 2500) Standard Cab Pickup, RWD	
F	11-20	3500 (SEE DODGE RAM 3500) RWD	
77950	A		
R	03-10	DODGE PICKUP 1 TON, RAM 3500 (SEE RAM 3500) All	
R	03-10	PICKUP 3/4 TON, RAM 2500 (SEE RAM 2500) All	
R	11-13	RAM 2500 (SEE DODGE RAM 2500) All	
R	11-13	3500 (SEE DODGE RAM 3500) All	
77951	C		142731
F	05-24	FORD PICKUP 1 TON, F-350 / SUPERDUTY 4WD	
F	11-16	PICKUP 1 TON, F-350 / SUPERDUTY All 4WD	
F	99-09	PICKUP 1 TON, F-350 / SUPERDUTY All 4WD	
F	01-24	PICKUP 3/4 TON, F-250 / SUPERDUTY 4WD	
F	99	PICKUP 3/4 TON, F-250 / SUPERDUTY 4WD	
77952	A		
R	13-16	FORD PICKUP 1 TON, F-350 / SUPERDUTY 4WD	
R	05-12	PICKUP 1 TON, F-350 / SUPERDUTY Crew Cab Pickup, 4WD Single Rear Wheels	
R	05-12	PICKUP 1 TON, F-350 / SUPERDUTY Extended Cab Pickup, 4WD Single Rear Wheels	
R	05-12	PICKUP 1 TON, F-350 / SUPERDUTY Standard Cab Pickup, 4WD Single Rear Wheels	
R	05-16	PICKUP 3/4 TON, F-250 / SUPERDUTY 4WD	
77967	D		143146
F	20-24	FORD F-600 SUPER DUTY All Applications with OEM Number	
F	13-24	PICKUP, F-450 SUPERDUTY All	
F	05-08	PICKUP, F-450 SUPERDUTY All	
F	13-24	PICKUP, F-550 SUPERDUTY All	
F	05-07	PICKUP, F-550 SUPERDUTY All	
77968	W		
R	13-16	FORD PICKUP, F-450 SUPERDUTY 4 X 2	
R	05-07	PICKUP, F-450 SUPERDUTY 4 X 2	
R	13-16	PICKUP, F-550 SUPERDUTY 4 X 2	
R	05-07	PICKUP, F-550 SUPERDUTY 4 X 2	
77969	W		
R	13-16	FORD PICKUP, F-450 SUPERDUTY 4 X 4	
R	05-07	PICKUP, F-450 SUPERDUTY 4 X 4	
R	13-16	PICKUP, F-550 SUPERDUTY 4 X 4	
R	05-07	PICKUP, F-550 SUPERDUTY 4 X 4	
77976	A		
R	11-24	CHEVROLET PICKUP 1 TON, SILVERADO 3500 HD All	
R	11-24	PICKUP 3/4 TON, SILVERADO 2500 HD All	
R	11-24	GMC SIERRA 2500 HD All	

Numerical listing

Shock	POP	Alternative No.	MTG Acc. Supplied
Pos.	Year	Application	
77976		A (cont)	
R	11-24	SIERRA 3500 HD All	
R	20-24	RAM 3500 (SEE DODGE RAM 3500) All	
77980		W	142731
F	06	DODGE PICKUP 1 TON, RAM 3500 (SEE RAM 3500) 4WD, 5.7L 8Cyl V (345), 3.92 99.57(Bore)3.58 90.93(Stroke)	
F	06	PICKUP 3/4 TON, RAM 2500 (SEE RAM 2500) 4WD, 5.7L 8Cyl V (345), 3.92 99.57(Bore)3.58 90.93(Stroke)	
77986		W	
R	24	FORD PICKUP, F-450 SUPERDUTY 4 X 4 Models with 4WD and OEM number	
R	17-23	PICKUP, F-450 SUPERDUTY All Models with 4WD and OEM number	
R	24	PICKUP, F-550 SUPERDUTY 4 X 4 Models with 4WD and OEM number	
R	17-23	PICKUP, F-550 SUPERDUTY All Models with 4WD and OEM number	
77987		W	
R	20-24	FORD F-600 SUPER DUTY 4 X 2 Models with RWD and OEM number	
R	24	PICKUP, F-450 SUPERDUTY RWD Models with RWD and OEM number	
R	17-23	PICKUP, F-450 SUPERDUTY All Models with RWD and OEM number	
R	24	PICKUP, F-550 SUPERDUTY RWD Models with RWD and OEM number	
R	17-23	PICKUP, F-550 SUPERDUTY All Models with RWD and OEM number	
77988		W	
R	17-24	FORD PICKUP 1 TON, F-350 / SUPERDUTY 4WD	
R	17-24	PICKUP 3/4 TON, F-250 / SUPERDUTY 4WD	
Guardian Shock			
81039		A	140357
F	63-86	CHEVROLET PICKUP 1 TON, C30 All	
F	88-91	PICKUP 1 TON, C35/3500 Cab & Chassis Exc. HD Solid Front Axle	
F	87-88	PICKUP 1 TON, R30 All	
F	89-91	PICKUP 1 TON, R3500 All	
F	63-86	PICKUP 3/4 TON, C20 All	
F	87-88	PICKUP 3/4 TON, R20 All	
F	89	PICKUP 3/4 TON, R2500 All	
F	63-80	VAN 1/2 TON, P SERIES All	
F	68-90	VAN 1 TON, P SERIES All Cutaway Chassis	
F	68-89	VAN 3/4 TON, P SERIES All	
F	88-91	GMC PICKUP 1 TON, C35/3500 Cab & Chassis	
F	80-86	PICKUP 1 TON, C35/3500 All	
F	67-78	PICKUP 1 TON, C35/3500 All	
F	87-91	PICKUP 1 TON, R3500 All	
F	83-86	PICKUP 3/4 TON, C25 / C2500 All	
F	75-82	PICKUP 3/4 TON, C25 / C2500 Cab & Chassis	
F	75-82	PICKUP 3/4 TON, C25 / C2500 Crew Cab Pickup	
F	75-82	PICKUP 3/4 TON, C25 / C2500 Standard Cab Pickup	
F	67-74	PICKUP 3/4 TON, C25 / C2500 All	
F	87-89	PICKUP 3/4 TON, R2500 All Exc. Crew Cab & Bonus Cab	
F	66	PICKUP 2500 SERIES All	
F	67-80	VAN 1/2 TON, P SERIES All	
F	75-90	VAN 1 TON, P SERIES All Cutaway Chassis	
F	73-74	VAN 1 TON, P SERIES Base Cutaway Chassis	
F	68-72	VAN 1 TON, P SERIES All	
F	68-89	VAN 3/4 TON, P SERIES All	
F	63-65	VAN, PB 1000 SERIES All	
81082		C	
R	97	FORD F-250 HD RWD	
R	80-97	PICKUP 1 TON, F-350 / SUPERDUTY RWD Exc. Dual Rear Wheels	
R	97	PICKUP 3/4 TON, F-250 / SUPERDUTY RWD Over 8500# GVW	
R	80-96	PICKUP 3/4 TON, F-250 / SUPERDUTY RWD	

Max Control, Guardian Shock

Shock	POP	Alternative No.	MTG Acc. Supplied
Pos.	Year	Application	
81091		B	
R	72-93	DODGE PICKUP 1 TON, D300 SERIES All	
R	72-93	PICKUP 3/4 TON, D200 SERIES All	
81096		C	140126
F	72-93	DODGE PICKUP 3/4 TON, D200 SERIES All Exc. Heavy Duty Package	
F	99-03	VAN 1/2 TON, A / B SERIES / RAM 109.3 / 277.6 (WheelBase) Exc. 7000# GVW	
F	81-98	VAN 1/2 TON, A / B SERIES / RAM 109.6 / 278.4 (WheelBase) Exc. 7000# GVW	
F	71-80	VAN 1/2 TON, A / B SERIES / RAM All	
F	95-03	VAN 1 TON, A / B SERIES / RAM All	
F	71-94	VAN 1 TON, A / B SERIES / RAM All Exc. 4000# Front Axle	
F	71-03	VAN 3/4 TON, A / B SERIES / RAM All	
F	74-80	VAN, CB300 All Exc. 4000# Front Axle	
F	81-83	PLYMOUTH VAN 1/2 TON, PB SERIES All	
F	74-83	VAN 1 TON, PB SERIES All Exc. 4000# Front Axle	
F	74-83	VAN 3/4 TON, PB SERIES All	
81113		D	
F	81-86	CHEVROLET PICKUP 3/4 TON, K20 All Standard Suspension; Exc. Lift Kit	
F	69-80	PICKUP 3/4 TON, K20 All Exc. Lift Kit	
F	69-86	GMC PICKUP 3/4 TON, K25 / K2500 All Exc. Quad Suspension and Lift Kit	
F	87	PICKUP 3/4 TON, V2500 All Quad Suspension Short Shock; Exc. Lift Kit	
81147		B	
F	65-66	FORD PICKUP 1 TON, F-350 / SUPERDUTY All	
R	61-64	PICKUP 1 TON, F-350 / SUPERDUTY All	
R	61-64	PICKUP 3/4 TON, F-250 / SUPERDUTY All	
F	68-75	PICKUP P350 All Up through 8000# GVW	
F	75-76	PICKUP P400 All Up through 8000# GVW	
F	68	INTERNATIONAL 1200C All Exc. 166" Wheelbase	
R	68	1200C All Exc. 166" Wheelbase	
F	68	1300C All Exc. 166" Wheelbase	
R	68	1300C All Exc. 166" Wheelbase	
R	68-72	M1100 / M1200 All	
R	69	M1400 All	
81164		B	140357
R	75-86	CHEVROLET PICKUP 3/4 TON, C20 Standard Cab Pickup	
R	73-74	PICKUP 3/4 TON, C20 All Standard Cab Pickup	
R	73-86	PICKUP 3/4 TON, K20 All Exc. Lift Kit	
R	87	PICKUP 3/4 TON, R20 Standard Cab Pickup	
R	87	PICKUP 3/4 TON, V20 All Exc. Quad Suspension and Lift Kit	
R	73	VAN 1/2 TON, P SERIES All	
R	73-78	VAN 3/4 TON, P SERIES All	
R	83-86	GMC PICKUP 3/4 TON, C25 / C2500 All	
R	75-82	PICKUP 3/4 TON, C25 / C2500 Cab & Chassis	
R	75-82	PICKUP 3/4 TON, C25 / C2500 Standard Cab Pickup	
R	73-86	PICKUP 3/4 TON, K25 / K2500 All Exc. Lift Kit	
R	88-89	PICKUP 3/4 TON, R2500 All Exc. Crew Cab & Bonus Cab	
R	87	PICKUP 3/4 TON, R2500 Cab & Chassis Exc. Crew Cab & Bonus Cab	
R	87	PICKUP 3/4 TON, R2500 Standard Cab Pickup Exc. Crew Cab & Bonus Cab	
R	87	PICKUP 3/4 TON, V2500 All Exc. Lift Kit	
R	73	VAN 1/2 TON, P SERIES All	
R	73-78	VAN 3/4 TON, P SERIES All	

Numerical listing

Shock	POP	Alternative No.	MTG Acc. Supplied
Pos.	Year	Application	
81242		B	140126
R	75-79	FORD PICKUP 1 TON, F-350 / SUPERDUTY Extended Cab Pickup, RWD	
R	75-79	PICKUP 3/4 TON, F-250 / SUPERDUTY Cab & Chassis, RWD	
R	75-79	PICKUP 3/4 TON, F-250 / SUPERDUTY Standard Cab Pickup, RWD	
R	73-74	PICKUP 3/4 TON, F-250 / SUPERDUTY RWD Exc. Supercab	
R	70-72	PICKUP 3/4 TON, F-250 / SUPERDUTY All RWD; Exc. Supercab	
81270		A	140523
R	60	FORD PICKUP 1 TON, F-350 / SUPERDUTY All	
F	56-59	PICKUP 3/4 TON, F-250 / SUPERDUTY All	
81318		C	141137
F	61-67	FORD ECONOLINE All	
81340		D	141041
R	49-52	CHEVROLET FLEETLINE All	
R	49-52	FLEETLINE TRUCK All	
81342		D	
R	81-93	DODGE PICKUP 1 TON, W300 SERIES All Exc. Quad Suspension and Lift Kit	
R	72-80	PICKUP 1 TON, W300 SERIES All	
R	90-93	PICKUP 3/4 TON, W200 SERIES Extended Cab Pickup Exc. Lift Kit	
R	88-93	PICKUP 3/4 TON, W200 SERIES Cab & Chassis Exc. Lift Kit	
R	81-93	PICKUP 3/4 TON, W200 SERIES Standard Cab Pickup Exc. Lift Kit	
R	86	PICKUP 3/4 TON, W200 SERIES Cab & Chassis Exc. Lift Kit	
R	81-83	PICKUP 3/4 TON, W200 SERIES Cab & Chassis Exc. Lift Kit	
R	81-82	PICKUP 3/4 TON, W200 SERIES Extended Cab Pickup Exc. Lift Kit	
R	72-80	PICKUP 3/4 TON, W200 SERIES All	
81394		B	140780
F	79	FORD PICKUP 1 TON, F-350 / SUPERDUTY RWD Quad Suspension Rearward of Front Axle	
F	68-78	PICKUP 1 TON, F-350 / SUPERDUTY All Quad Suspension Rearward of Front Axle	
F	67	PICKUP 1 TON, F-350 / SUPERDUTY All RWD; Quad Suspension Rearward of Front Axle	
F	65-69	PICKUP 3/4 TON, F-250 / SUPERDUTY All RWD; Quad Suspension Rearward of Front Axle	
F	75-91	VAN 1 TON, ECONOLINE / CLUB WAGON / SUPERDUTY All Exc. Cutaway Chassis RWD, 4WD Quad Suspension Rearward of Front Axle, Non Quad Suspension	
F	75-91	VAN 3/4 TON, ECONOLINE / CLUB WAGON / SUPERDUTY All RWD, 4WD Quad Suspension Rearward of Front Axle, Non Quad Suspension	
F	90	VAN 3/4 TON, ECONOLINE / CLUB WAGON / SUPERDUTY All	
F	87	VAN 3/4 TON, ECONOLINE / CLUB WAGON / SUPERDUTY All	
F	85	VAN 3/4 TON, ECONOLINE / CLUB WAGON / SUPERDUTY All	
F	79-81	VAN 3/4 TON, ECONOLINE / CLUB WAGON / SUPERDUTY All	
81484		B	141137
R	75-79	FORD PICKUP 1 TON, F-350 / SUPERDUTY Standard Cab Pickup, RWD	
R	73-74	PICKUP 1 TON, F-350 / SUPERDUTY All RWD; Exc. Supercab	
R	75-79	PICKUP 3/4 TON, F-250 / SUPERDUTY Extended Cab Pickup, RWD	
R	73-74	PICKUP 3/4 TON, F-250 / SUPERDUTY RWD Supercab	
R	65-72	PICKUP 3/4 TON, F-250 / SUPERDUTY All RWD; Supercab	
R	69-74	VAN 1 TON, ECONOLINE / CLUB WAGON / SUPERDUTY All	
R	69-74	VAN 3/4 TON, ECONOLINE / CLUB WAGON / SUPERDUTY All	

Numerical listing

Shock	POP	Alternative No.	MTG Acc. Supplied
Pos.	Year	Application	
81490	C		140780
F	86-90	FORD F-200 All	
F	97	F-250 HD RWD	
F	80-97	PICKUP 1 TON, F-350 / SUPERDUTY RWD	
F	97	PICKUP 3/4 TON, F-250 / SUPERDUTY RWD Over 8500# GVW	
F	80-96	PICKUP 3/4 TON, F-250 / SUPERDUTY RWD	
81495	A		141150
R	56-60	FORD PICKUP 3/4 TON, F-250 / SUPERDUTY All	
81496	D		
F	81-86	CHEVROLET PICKUP 3/4 TON, K20 All Quad Suspension Long Shock; Exc. Lift Kit	
F	87	PICKUP 3/4 TON, V20 All Quad Suspension Long Shock; Exc. Lift Kit	
R	78-95	VAN 1/2 TON, G / EXPRESS All	
R	78-95	VAN 1 TON, G / EXPRESS Cutaway Van	
R	78-95	VAN 3/4 TON, G / EXPRESS All Exc. 8600# GVW	
R	99-03	DODGE VAN 1/2 TON, A / B SERIES / RAM 109.3 / 277.6 (WheelBase) Exc. 7000# GVW	
R	81-98	VAN 1/2 TON, A / B SERIES / RAM 109.6 / 278.4 (WheelBase) Exc. 7000# GVW	
R	71-80	VAN 1/2 TON, A / B SERIES / RAM All	
R	71-03	VAN 1 TON, A / B SERIES / RAM All	
R	71-03	VAN 3/4 TON, A / B SERIES / RAM All	
R	74-80	VAN, CB300 All	
F	87-88	GMC PICKUP 1 TON, V3000 / V3500 All Quad Suspension Long Shock; Exc. Lift Kit	
F	81-86	PICKUP 3/4 TON, K25 / K2500 All Quad Suspension Long Shock; Exc. Lift Kit	
F	87	PICKUP 3/4 TON, V2500 All Quad Suspension Long Shock; Exc. Lift Kit	
R	78-95	VAN 1/2 TON, G / SAVANA All	
R	85-96	VAN 1 TON, G / SAVANA Extended Cargo Van	
R	85-96	VAN 1 TON, G / SAVANA Extended Passenger Van	
R	79-96	VAN 1 TON, G / SAVANA Standard Cargo Van	
R	79-96	VAN 1 TON, G / SAVANA Standard Passenger Van	
R	78	VAN 1 TON, G / SAVANA Cutaway Van	
R	78-95	VAN 3/4 TON, G / SAVANA All Exc. 8600# GVW	
R	81-83	PLYMOUTH VAN 1/2 TON, PB SERIES All	
R	74-83	VAN 1 TON, PB SERIES All	
R	74-83	VAN 3/4 TON, PB SERIES All	
81510	C		
R	97	FORD F-250 HD 4WD	
R	86-97	PICKUP 1 TON, F-350 / SUPERDUTY 4WD Dual Rear Wheels	
R	82-85	PICKUP 1 TON, F-350 / SUPERDUTY 4WD Clevis Type Lower Front Mount; Exc. Dual Rear Wheels or Lift Kit	
R	80-81	PICKUP 1 TON, F-350 / SUPERDUTY 4WD	
R	97	PICKUP 3/4 TON, F-250 / SUPERDUTY 4WD Over 8500# GVW	
R	86-96	PICKUP 3/4 TON, F-250 / SUPERDUTY 4WD	
R	82-85	PICKUP 3/4 TON, F-250 / SUPERDUTY 4WD Clevis Type Lower Front Mount; Exc. Dual Rear Wheels or Lift Kit	
R	80-81	PICKUP 3/4 TON, F-250 / SUPERDUTY 4WD	
81667	C		
R	88-00	CHEVROLET PICKUP 1 TON, C35/3500 Extended Cab Pickup Exc. HD Straight Front Axle	
R	88-00	PICKUP 1 TON, C35/3500 Standard Cab Pickup Exc. HD Straight Front Axle	
R	88-00	PICKUP 1 TON, K35 / K3500 All	
R	88-00	PICKUP 3/4 TON, C25 / C2500 All	

Guardian Shock

Shock	POP	Alternative No.	MTG Acc. Supplied
Pos.	Year	Application	
81667	C (cont)		
R	88-00	PICKUP 3/4 TON, K25 / K2500 All	
R	89-00	GMC PICKUP 1 TON, C35/3500 Extended Cab Pickup Exc. HD Straight Front Axle	
R	88-00	PICKUP 1 TON, C35/3500 Standard Cab Pickup Exc. HD Straight Front Axle	
R	88-00	PICKUP 1 TON, K35 / K3500 All	
R	88-00	PICKUP 3/4 TON, C25 / C2500 All	
R	88-00	PICKUP 3/4 TON, K25 / K2500 All	
81668	C		141277
F	92-00	CHEVROLET PICKUP 1 TON, C35/3500 All Exc. HD Straight Front Axle	
F	88-91	PICKUP 1 TON, C35/3500 Extended Cab Pickup Exc. HD Straight Front Axle	
F	88-91	PICKUP 1 TON, C35/3500 Standard Cab Pickup Exc. HD Straight Front Axle	
F	88-00	PICKUP 3/4 TON, C25 / C2500 All	
F	88-00	GMC PICKUP 1 TON, C35/3500 All Exc. HD Straight Front Axle	
F	88-00	PICKUP 3/4 TON, C25 / C2500 All	
81676	A		
R	53-55	FORD PICKUP 1 TON, F-350 / SUPERDUTY All	
R	53-55	PICKUP 3/4 TON, F-250 / SUPERDUTY All	
81710	C		
R	80-97	FORD PICKUP 1 TON, F-350 / SUPERDUTY RWD Dual Rear Wheels	
81713	C		140800
F	96-02	CHEVROLET VAN 1 TON, G / EXPRESS All	
F	96-02	VAN 3/4 TON, G / EXPRESS All Exc. 8600# GVW	
F	96-02	GMC VAN 1/2 TON, G / SAVANA RWD	
F	96-02	VAN 1 TON, G / SAVANA All	
F	96-02	VAN 3/4 TON, G / SAVANA All Exc. 8600# GVW	
81726	W		
F	88-00	CHEVROLET PICKUP 1 TON, K35 / K3500 All	
F	88-00	PICKUP 3/4 TON, K25 / K2500 All	
F	88-00	GMC PICKUP 1 TON, K35 / K3500 All	
F	88-00	PICKUP 3/4 TON, K25 / K2500 All	
81744	A		140780
F	21-24	FORD VAN 1 TON, ECONOLINE / CLUB WAGON / SUPERDUTY All	
F	92-19	VAN 1 TON, ECONOLINE / CLUB WAGON / SUPERDUTY All	
F	92-14	VAN 3/4 TON, ECONOLINE / CLUB WAGON / SUPERDUTY All	
81821	D		
F	97	FORD F-250 HD 4WD	
F	86-97	PICKUP 1 TON, F-350 / SUPERDUTY 4WD	
F	97	PICKUP 3/4 TON, F-250 / SUPERDUTY 4WD Over 8500# GVW	
F	87-96	PICKUP 3/4 TON, F-250 / SUPERDUTY 4WD	
81825	D		
F	81-93	DODGE PICKUP 1 TON, W300 SERIES All Exc. Quad Suspension and Lift Kit	
F	61-80	PICKUP 1 TON, W300 SERIES All	
R	61-71	PICKUP 1 TON, W300 SERIES All	
F	90-93	PICKUP 1 TON, W200 SERIES Extended Cab Pickup Exc. Lift Kit	
F	88-93	PICKUP 3/4 TON, W200 SERIES Cab & Chassis Exc. Lift Kit	
F	81-93	PICKUP 3/4 TON, W200 SERIES Standard Cab Pickup Exc. Lift Kit	
F	86	PICKUP 3/4 TON, W200 SERIES Cab & Chassis Exc. Lift Kit	
F	81-83	PICKUP 3/4 TON, W200 SERIES Cab & Chassis Exc. Lift Kit	
F	81-82	PICKUP 3/4 TON, W200 SERIES Extended Cab Pickup Exc. Lift Kit	
F	69-80	PICKUP 3/4 TON, W200 SERIES All	
F	61-67	PICKUP 3/4 TON, W200 SERIES All	

Numerical listing

Shock	POP	Alternative No.	MTG Acc. Supplied
Pos.	Year	Application	
81828	W		142617
R	21-24	FORD VAN 1 TON, ECONOLINE / CLUB WAGON / SUPERDUTY All	
R	10-19	VAN 1 TON, ECONOLINE / CLUB WAGON / SUPERDUTY All	
R	04-19	VAN 1 TON, ECONOLINE / CLUB WAGON / SUPERDUTY All Exc. Cutaway Chassis	
R	92-05	VAN 1 TON, ECONOLINE / CLUB WAGON / SUPERDUTY All	
R	92-14	VAN 3/4 TON, ECONOLINE / CLUB WAGON / SUPERDUTY All	
81834	W		140126
F	72-93	DODGE PICKUP 1 TON, D300 SERIES All Heavy Duty Package	
F	82-93	PICKUP 3/4 TON, D200 SERIES All Heavy Duty Package	
F	75-81	PICKUP 3/4 TON, D200 SERIES 165.0 / 419.1 (WheelBase) Heavy Duty Package	
F	72-74	PICKUP 3/4 TON, D200 SERIES All Heavy Duty Package	
F	71-93	VAN 1 TON, A / B SERIES / RAM All 4000# Front Axle	
F	74-80	VAN, CB300 All 4000# Front Axle	
F	74-83	PLYMOUTH VAN 1 TON, PB SERIES All 4000# Front Axle	
81873	B		
R	94-02	DODGE PICKUP 1 TON, RAM 3500 (SEE RAM 3500) RWD Exc. Solid Front Axle	
R	94-03	PICKUP 3/4 TON, RAM 2500 (SEE RAM 2500) All Exc. 8800# GVW	
81892	D		142700
R	97-99	FORD PICKUP 3/4 TON, F-250 / SUPERDUTY RWD Up through 8500# GVW	
81912	C		142731
F	97-99	FORD PICKUP 3/4 TON, F-250 / SUPERDUTY RWD Up through 8500# GVW	
81913	D		142700
R	97-99	FORD PICKUP 3/4 TON, F-250 / SUPERDUTY 4WD Up through 8500# GVW	
81914	D		142731
F	97-99	FORD PICKUP 3/4 TON, F-250 / SUPERDUTY 4WD Up through 8500# GVW	
81919	D		142731
F	99-02	DODGE PICKUP 3/4 TON, RAM 2500 (SEE RAM 2500) 4WD Exc. 8800# GVW	
F	94-95	PICKUP 3/4 TON, RAM 2500 (SEE RAM 2500) 4WD Exc. 8800# GVW	
81920	B		141665
F	99-04	CHEVROLET PICKUP 3/4 TON, SILVERADO 2500 RWD Exc. Electronic Adjustable Suspension	
F	01-04	PICKUP 1 TON, SILVERADO 2500 HD RWD	
F	99-04	GMC SIERRA 2500 RWD Exc. Electronic Adjustable Suspension	
F	01-04	SIERRA 2500 HD RWD	
81921	A		
R	77-86	CHEVROLET PICKUP 1 TON, K30 All	
R	90-91	PICKUP 1 TON, R3500 All	
R	89	PICKUP 1 TON, R3500 Cab & Chassis, RWD	
R	89	PICKUP 1 TON, R3500 Crew Cab Pickup, RWD	
R	01-09	PICKUP 1 TON, SILVERADO 3500 All	
R	08-10	PICKUP 1 TON, SILVERADO 3500 HD All	
R	87-88	PICKUP 1 TON, V30 All	
R	89-91	PICKUP 1 TON, V3000 / V3500 All	
R	99-08	PICKUP 3/4 TON, SILVERADO 2500 All	
R	01-10	PICKUP 3/4 TON, SILVERADO 2500 HD All	
R	07	SILVERADO 3500 CLASSIC All	
R	94-02	DODGE PICKUP 1 TON, RAM 3500 (SEE RAM 3500) 4WD	
R	94-02	PICKUP 1 TON, RAM 3500 (SEE RAM 3500) RWD Solid Front Axle	

Numerical listing

Guardian Shock, Classic Shock Absorbers, 83000 Series

Numerical listing

Shock	POP	Alternative No.	MTG Acc. Supplied
Pos.	Year	Application	
81921	A (cont)		
R	94-02	PICKUP 3/4 TON, RAM 2500 (SEE RAM 2500) 4WD 8800# GVW	
R	77-86	GMC PICKUP 1 TON, K35 / K3500 All	
R	87-91	PICKUP 1 TON, V3000 / V3500 All	
R	99-04	SIERRA 2500 All	
R	01-10	SIERRA 2500 HD All	
R	01-06	SIERRA 3500 All	
R	07-10	SIERRA 3500 HD All	
81925	D		141665
F	01-09	CHEVROLET PICKUP 1 TON, SILVERADO 3500 All	
F	05-08	PICKUP 3/4 TON, SILVERADO 2500 All	
F	99-04	PICKUP 3/4 TON, SILVERADO 2500 4WD	
F	99-04	GMC SIERRA 2500 4WD	
81928	W		143000
F	94-02	DODGE PICKUP 1 TON, RAM 3500 (SEE RAM 3500) RWD Exc. Solid Front Axle	
F	94-02	PICKUP 3/4 TON, RAM 2500 (SEE RAM 2500) RWD	
Classic Shock Absorbers			
82003	A		
R	67-72	CHEVROLET PICKUP 3/4 TON, C20 All Coil(RearSpringType)	
R	64-66	VAN 1/2 TON, G / EXPRESS All	
R	67-72	VAN 1/2 TON, P SERIES All	
R	67-72	GMC PICKUP 3/4 TON, C25 / C2500 All Coil(RearSpringType)	
R	64-66	VAN 1/2 TON, G / SAVANA All	
R	68-72	VAN 1/2 TON, P SERIES All	
82007	B		140349
R	61-67	FORD ECONOLINE All	
F	68	INTERNATIONAL 1200C All Exc. 166" Wheelbase	
F	68	1300C All Exc. 166" Wheelbase	
F	68-72	M1100 / M1200 All	
F	69	M1400 All	
82012	C		
F	69-74	FORD VAN 1 TON, ECONOLINE / CLUB WAGON / SUPERDUTY All	
F	69-74	VAN 3/4 TON, ECONOLINE / CLUB WAGON / SUPERDUTY All	
82026	A		140455
F	49-52	CHEVROLET FLEETLINE All	
F	49-52	FLEETLINE TRUCK All	
82034	C		141138
F	73-78	FORD PICKUP 3/4 TON, F-250 / SUPERDUTY 4WD Up through Serial No. Y2000	
F	68-72	PICKUP 3/4 TON, F-250 / SUPERDUTY All 4WD; Up through Serial No. Y2000	
F	66-67	PICKUP 3/4 TON, F-250 / SUPERDUTY All 4WD; Up through Serial No. Y20000	
F	61-65	PICKUP 3/4 TON, F-250 / SUPERDUTY All 4WD	
82035	C		140357
F	61-62	CHEVROLET PICKUP 1 TON, C30 All	
F	60-62	PICKUP 3/4 TON, C20 All	
F	61-62	VAN 1/2 TON, P SERIES All	
F	61-62	GMC PICKUP 2500 SERIES All	
82047	A		140630
F	61-67	CHEVROLET VAN 1 TON, P SERIES All	
F	61-67	VAN 3/4 TON, P SERIES All	
F	67	GMC VAN 1 TON, P SERIES All	
F	67	VAN 3/4 TON, P SERIES All	
82065	C		140478
R	74	DODGE M300 All	
R	74	M350 All	
R	61-71	PICKUP 1 TON, D300 SERIES All	
F	60	PICKUP 3/4 TON, D200 SERIES All	
F	60	PICKUP 3/4 TON, W200 SERIES All	
R	66-72	VAN 1 TON, P SERIES All	
R	61-64	VAN 1 TON, P SERIES All	
82066	A		140455
R	49-52	CHEVROLET FLEETLINE All	
R	49-52	FLEETLINE TRUCK All	

Shock	POP	Alternative No.	MTG Acc. Supplied
Pos.	Year	Application	
82086	B		
R	60-62	CHEVROLET PICKUP 3/4 TON, C20 All	
R	61-62	VAN 1/2 TON, P SERIES All	
82147	D		
R	75-78	FORD PICKUP 3/4 TON, F-250 / SUPERDUTY 4WD Up through Serial No. Y20000	
R	66-74	PICKUP 3/4 TON, F-250 / SUPERDUTY All 4WD; Up through Serial No. Y20000	
82155	A		141041
R	61-62	CHEVROLET VAN 1 TON, P SERIES All	
R	61-62	VAN 3/4 TON, P SERIES All	
R	66-67	FIAT 1100 All Exc. Wagon	
R	64-67	1500 All Exc. Wagon	
82156	A		
R	75-76	FIAT 124 All Wagon	
R	67-74	124 Wagon Wagon	
R	66-67	1100 All Wagon	
R	64-67	1500 All Wagon	
83000 Series			
83101	D		
F	13	INTERNATIONAL 4300LP All Models with O.E.M. Number	
83114	W		140780 (1)
F	00-04	ISUZU FRR All	
F	95-98	FRR All	
F	86	FSR	
F	87-96	FSR All FSR Models	
F	88-94	NRR All	
F	89-94	UD 1800 All Models with O.E.M. Number	
F	99-04	1800CS All Models with O.E.M. Number	
F	89-94	2000 All Models with O.E.M. Number	
83120	W		145089-000(1)/145143(1)
R	05-22	FREIGHTLINER B2 All Models with 15,000 lb Rear Suspension	
R	95-05	FL50 All Models with 15,000 lb Rear Suspension	
R	91-05	FL60 All w/ 15000 lb Rear Suspension	
R	98-20	MT45 All Models with O.E.M. Number	
R	99-11	MT55 All Models with O.E.M. Number	
R		VARIOUS	
R	03-10	STERLING TRUCK ACTERRA All Models with 15000 lb Rear Suspension	
R	01-07	ACTERRA 5500 All Models with 15000 lb Rear Suspension	
R	01-07	ACTERRA 6500 All Models with 15000 lb Rear Suspension	
R		UPS TRUCK VARIOUS	
83122	W		
R	00-01	CHEVROLET C7500 KODIAK All Models with Hendrickson Air Suspension (Stamping number 47902-13)	
R	99	T6500 All Models with Hendrickson Air Suspension (Stamping number 47902-13)	
R	06-23	FORD F-53	
R	99-04	F-53	
R	99	GMC T5500	
R	99	T6500 All Models with Hendrickson Air Suspension (Stamping number 47902-13)	
R		ISUZU FVR	
83123	C		
R	13-24	KENWORTH K270 All Models with Hendrickson HAS - 210L or HAS - 230L Rear Air Suspension	
R	93-05	K300 All Models with Hendrickson Rear Air Suspension	
R	08-23	T270 All Models with Hendrickson HAS - 210L or HAS - 230L Rear Air Suspension	
R		T300	
R	00-08	T300 All Models with Hendrickson HAS - 210L or HAS - 230L Rear Air Suspension	

Shock	POP	Alternative No.	MTG Acc. Supplied
Pos.	Year	Application	
83123	C (cont)		
R	13-24	PETERBILT 220 All Models with Hendrickson HAS - 210L or HAS - 230L Rear Air Suspension	
R	10	220 All Models with Hendrickson HAS - 210L or HAS - 230L Rear Air Suspension	
R	07	220 All Models with Hendrickson HAS - 210L or HAS - 230L Rear Air Suspension	
83126	D		
R	02-23	FREIGHTLINER M2 106 All Models with Reycy 79KB Rear Steel Spring Suspension	
F	05-10	HINO 145 All Models with O.E.M. Number	
F	05-10	165 All Models with O.E.M. Number	
F	05-10	185 All Models with O.E.M. Number	
R	13-24	KENWORTH K270 All Models with Reycy 102 or 79KB Suspension (Drive Axle)	
R	93-05	K300 All Models with Reycy 102 or 79KB Suspension (Drive Axle)	
F	93-05	K300 All Models with Reycy 1209 or 1212 Suspension (Steer Axle)	
R	08-22	T170 All Models with Reycy 79KB Rear Steel Spring Suspension	
R	08-23	T270 All Models with Reycy 102 or 79KB Suspension (Drive Axle)	
R	21-24	T280 All Models with Reycy 102 or 79KB Suspension (Drive Axle)	
F		T300	
R		T300	
R	00-08	T300 All Models with Reycy 102 or 79KB Suspension (Drive Axle)	
R	00-08	T300 All Models with Reycy 1209 or 1212 Suspension (Steer Axle)	
R	08-15	PETERBILT 210 All Models with Reycy 102 or 79KB Suspension (Drive Axle)	
R	13-24	220 All Models with Reycy 102 or 79KB Suspension (Drive Axle)	
R	10	220 All Models with Reycy 102 or 79KB Suspension (Drive Axle)	
R	07	220 All Models with Reycy 102 or 79KB Suspension (Drive Axle)	
R	08-19	325 All Models with Reycy 102 or 79KB Suspension (Drive Axle)	
83127	C		
F	23	MACK MD6	
F	24	MD6 All Models with 10,000 lb Taperleaf Springs	
F	21-22	MD6 All Models with 10,000 lb Taperleaf Springs	
83134	W		145054 (1)
R	05-21	FREIGHTLINER M2 All Models with Rear 52" Spring ,10000 lb - 15000 lb	
R	05-21	M2 All Models with Rear 52" Spring ,18000 lb - 23000 lb	
R	02-10	M2 100 All Models with Rear 52" Spring ,10000 lb - 15000 lb	
R	02-10	M2 100 All Models with Rear 52" Spring ,18000 lb - 23000 lb	
R	02-23	M2 106 All Models with Rear 52" Spring ,10000 lb - 15000 lb	
R	02-23	M2 106 All Models with Rear 52" Spring ,18000 lb - 23000 lb	
83135	C		
F	19-22	CHEVROLET SILVERADO 4500 HD All Models with 7,000 to 8,000 lb Front Axle	
F	19-22	SILVERADO 5500 HD All Models with 7,000 to 8,000 lb Front Axle	
F	19-22	SILVERADO 6500 HD All Models with 7,000 to 8,000 lb Front Axle	
F	02-20	INTERNATIONAL 4300 All Models with 6,000 to 8,000 lb Front Suspension	
F	02-19	4400 All Models with 6,000 to 8,000 lb Front Suspension	
F	10-12	DURASTAR - 4300, 4400 SERIES	
F	12-18	TERRASTAR All Models with 6,000 to 7,000 lb Front Axle	
83136	W		145054 (2)
F	90-96	CHEVROLET C60 KODIAK All Conventional Cab w/ Front Shock with O.E.M. Number	
R	90-96	C60 KODIAK All Conventional Cab w/19000, 21000, 23000 lb Taperleaf Springs (EXC Low Profile Vehicle)	
F	90-02	C4500 KODIAK	

Numerical listing

Shock	POP	Alternative No.	MTG Acc. Supplied
Pos.	Year	Application	
83136	W	(cont)	145054 (2)
R	90-02	C4500 KODIAK	
F	03-09	C4500 KODIAK All C Chassis - Conventional Cab	
R	03-09	C4500 KODIAK All C Chassis - Conventional Cab w/19000, 21000, 23000 lb Taperleaf Springs (EXC Low Profile Vehicle)	
F	92-02	C5500 KODIAK	
R	92-02	C5500 KODIAK	
F	03-09	C5500 KODIAK All C Chassis - Conventional Cab	
R	03-09	C5500 KODIAK All C Chassis - Conventional Cab w/19000, 21000, 23000 lb Taperleaf Springs (EXC Low Profile Vehicle)	
F	90-91	C5500 KODIAK All C Chassis - Conventional Cab	
R	90-91	C5500 KODIAK All C Chassis - Conventional Cab w/19000, 21000, 23000 lb Taperleaf Springs (EXC Low Profile Vehicle)	
F	00-01	C7500 KODIAK All Conventional Cab w/ Front Shock with O.E.M. Number	
R	00-01	C7500 KODIAK All Conventional Cab w/19000, 21000, 23000 lb Taperleaf Springs (EXC Low Profile Vehicle)	
R	92-96	P60 All Motorhome Chassis	
R	92-96	P6000 All Motorhome Chassis	
F	97-09	T5500	
R	92-99	T5500	
F	03	T6500	
R	92-96	T6500	
F	04-09	T6500 All FL1 Tilt Cab with 8100 lb Axle	
F	04-09	T6500 All FL2 Tilt Cab with 5000 to 11000 lb Axle	
F	04-09	T6500 All FL3 Tilt Cab with 14575 lb Axle	
F	97-02	T6500 All FL1 Tilt Cab with 8100 lb Axle	
F	97-02	T6500 All FL2 Tilt Cab with 5000 to 11000 lb Axle	
F	97-02	T6500 All FL3 Tilt Cab with 14575 lb Axle	
R	97-99	T6500 All Tilt Cab w/19000, 21000, 23000 lb Taperleaf Springs (EXC Low Profile Veh.)	
R	92-96	VAN 1 TON, P SERIES All Motorhome Chassis	
F	90-02	GMC C4500 TOPKICK	
R	90-02	C4500 TOPKICK	
R	03-09	C4500 TOPKICK All C Chassis - Conventional Cab with 19000, 21000, 23000 lb Taperleaf Springs (EXC Low Profile Vehicle)	
F	03-09	C4500 TOPKICK All C Chassis - Conventional Cab with Front Shock with O.E.M. Number	
F	90-02	C5500 TOPKICK	
R	90-02	C5500 TOPKICK	
R	03-09	C5500 TOPKICK All C Chassis - Conventional Cab with 19000, 21000, 23000 lb Taperleaf Springs (EXC Low Profile Vehicle)	
F	03-09	C5500 TOPKICK All C Chassis - Conventional Cab with Front Shock with O.E.M. Number	
F	97-09	T5500	
R	92-99	T5500	
F	03	T6500	
R	92-96	T6500	
F	04-09	T6500 All FL1 Tilt Cab with 8100 lb Axle	
F	04-09	T6500 All FL2 Tilt Cab with 5000 to 11000 lb Axle	
F	04-09	T6500 All FL3 Tilt Cab with 14575 lb Axle	
F	97-02	T6500 All FL1 Tilt Cab with 8100 lb Axle	
F	97-02	T6500 All FL2 Tilt Cab with 5000 to 11000 lb Axle	
F	97-02	T6500 All FL3 Tilt Cab with 14575 lb Axle	
R	97-99	T6500 All Tilt Cab with 19000, 21000, 23000 lb Taperleaf Springs (EXC Low Profile Veh.)	
R	97-02	ISUZU FSR All Models with 19000, 21000, 23000 lb Taperleaf Springs (EXC Low Profile Veh.)	
F	97-02	FSR All Models with FL1 Tilt Cab with 8100 lb Axle (Including Low Profile)	

83000 Series

Shock	POP	Alternative No.	MTG Acc. Supplied
Pos.	Year	Application	
83136	W	(cont)	145054 (2)
R	97-09	FTR All Models with 19000, 21000, 23000 lb Taperleaf Springs (EXC Low Profile Veh.)	
F	90-09	FTR All Models with O.E.M. Number	
R	97-08	FVR All Models with 19000, 21000, 23000 lb Taperleaf Springs (EXC Low Profile Veh.)	
F	97-08	FVR All Models with O.E.M. Number	
R	93-05	KENWORTH K300 All Models with Woodhead Shock (Stamping Number ACHB 966)	
R		T300	
83137	W		
R	03-09	CHEVROLET C6500 KODIAK All Models with Hendrickson Air Suspension with O.E.M. Number	
R	97-99	C6500 KODIAK All Models with Hendrickson Air Suspension with O.E.M. Number	
R	00-01	C7500 KODIAK All Models with Hendrickson Air Suspension with O.E.M. Number	
R	18-24	ISUZU FTR All Models with Hendrickson HAS suspension	
R	00-11	FTR All Models with Hendrickson HAS suspension	
R	10-11	FVR All Models with Hendrickson HAS suspension	
R	00-08	FVR All Models with Hendrickson HAS suspension	
R	13-24	KENWORTH K270 All Models with Hendrickson HAS - 230 Rear Air Suspension	
R	08-14	T270 All Models with Hendrickson HAS - 400 (Standard) Rear Air Suspension	
83140	D		415010-802(2)/145148(2)
F	05-10	HINO 185 All Models with O.E.M. Number	
F	05-14	238 All Models with O.E.M. Number	
F	06-14	258 All Models with O.E.M. Number	
F	05-14	268 All Models with O.E.M. Number	
F	08-14	268A All Models with O.E.M. Number	
83141	W		415010-802(2)/145148(2)
F	98-04	HINO FB1817 All FE Models Trucks with:	
F	98-04	FE SERIES	
83142	C		145128 (1)
R	05-21	FREIGHTLINER M2 All Models with Hendrickson HMX 400/460 Haulmax with 17.5" & 18.5" Saddle	
R	02-10	M2 100 All Models with Hendrickson HMX 400/460 Haulmax with 17.5" & 18.5" Saddle	
R	02-24	M2 106 All Models with Hendrickson HMX 400/460 Haulmax with 17.5" & 18.5" Saddle	
83143	D		145128 (1)
R	05-21	FREIGHTLINER M2 All Models with Hendrickson HMX 400/460 Haulmax with 16.5" Saddle	
R	02-10	M2 100 All Models with Hendrickson HMX 400/460 Haulmax with 16.5" Saddle	
R	02-24	M2 106 All Models with Hendrickson HMX 400/460 Haulmax with 16.5" Saddle	
R	08-23	KENWORTH T270 All Models with Hendrickson HMX 400/460 Haulmax with 16.5" Saddle	
83148	D		
R		HINO ADDITIONAL APPLICATIONS	
83154	D		145089-000 (1)
R	98-23	FREIGHTLINER MT45 All Walkin Step Van Models (18 Foot) with O.E.M. Number	
R		MT55	
83157	W		
F	99-20	FREIGHTLINER MT45 All MT45 Step Van - w/35" Front Spring	
F	99-20	MT55 All MT55 Step Van - w/35" Front Spring	
83159	W		TR0027 (4)
R	16-23	CHEVROLET LCF 3500 All	

Numerical listing

Shock	POP	Alternative No.	MTG Acc. Supplied
Pos.	Year	Application	
83159	W	(cont)	TR0027 (4)
R	18	LCF 3500HD	
R	16-17	LCF 3500HD All	
R	19-22	SILVERADO 4500 HD All Diesel Low Cab Forward models with 14,000 to 15,000 lb Rear	
R	19-22	SILVERADO 4500 HD All Diesel Low Cab Forward models with 15,000 to 16,000 lb Rear	
R	19-22	SILVERADO 5500 HD All Diesel Low Cab Forward models with 14,000 to 15,000 lb Rear	
R	19-22	SILVERADO 5500 HD All Diesel Low Cab Forward models with 15,000 to 16,000 lb Rear	
R	05-09	ISUZU FTR All Models with O.E.M. Number	
R	95-20	NPR All Models with O.E.M. Number	
R	20-23	NPR-HD All Models with 14,000 to 15,000 lb Rear	
R	20-23	NPR-HD All Models with 15,000 to 16,000 lb Rear	
R	03-23	NPR-HD All Models with O.E.M. Number	
R	23	NPR-XD	
R	15-22	NPR-XD All Models with 14,000 to 15,000 lb GVW	
R	15-22	NPR-XD All Models with 15,000 to 16,000 lb Rear	
R	20-23	NQR All Models with 15,000 to 16,000 lb Rear	
R	03-19	NQR All Models with O.E.M. Number	
R	02	NQR All Diesel	
R	95-97	NQR All Diesel	
R	20-23	NRR All Models with 15,000 to 16,000 lb Rear	
R	05-19	NRR All Models with O.E.M. Number	
R	11-15	REACH All Models with O.E.M. Number	
83162	W		140780(1)/145116 & 406422 & 415010-802(1)
F	86	ISUZU FSR	
F	87-92	FSR All FSR Models	
F	94-96	FVR All FVR Short & Middle Chassis	
F	88-92	FVR All FVR Short & Middle Chassis	
F	89-13	UD 2600 All Models with O.E.M. Number	
83163	B		
F	08-09	INTERNATIONAL 4300 All Models with 9,000 to 10,000 lb Front Suspension	
F	08-09	4400 All Models with 9,000 to 10,000 lb Front Suspension	
F	15-19	DURASTAR All Models with 9,000 to 10,000 lb Front Suspension	
F	13	DURASTAR All Models with 9,000 to 10,000 lb Front Suspension	
F	19-22	MV607 All Models with 9,000 to 10,000 lb Front Suspension	
83164	W		
F	99-20	FREIGHTLINER MT45 All MT45 Step Van - w/38" Front Spring	
F	99-20	MT55 All MT55 Step Van - w/38" Front Spring	
83166	W		
R	08-14	HINO 238 All Models with Hendrickson Comfort Air (Single Axle - 19K)	
R	08-23	258 All Models with Hendrickson Comfort Air (Single Axle - 19K)	
R	08-14	258ALP All Models with Hendrickson Comfort Air (Single Axle - 19K)	
R	08-23	268 All Models with Hendrickson Comfort Air (Single Axle - 19K)	
R	08-14	268A All Models with Hendrickson Comfort Air (Single Axle - 19K)	
R	22-24	L6	
R	21	L6 All Models with Hendrickson Comfort Air (Single Axle - 19K)	
R	21-22	LION LION6 All Models with Hendrickson Comfort Air Suspension (21K Capacity)	
83168	W		
R		HINO 268, 268A SERIES	

Numerical listing

Shock	POP	Alternative No.	MTG Acc. Supplied
Pos.	Year	Application	
83169	W		
F 15-20	INTERNATIONAL DURASTAR All Models with 6,000 to 8,000 lb Front Suspension		
F 13	DURASTAR All Models with 6,000 to 8,000 lb Front Suspension		
F 13-18	DURASTAR - 4300, 4400 SERIES		
F 19-22	MV607 All Models with 6,000 to 8,000 lb Front Suspension		
83180	W		
R 14	INTERNATIONAL TERRASTAR All 4 WD Models with Rear Spring Suspension		
83209	D		
F 06-23	FORD F-53		
F 99-04	F-53		
F 88-97	F-53		
83215	W		401754 (4)
R 86-87	HINO FD16 All Models with O.E.M. Number		
R 88-92	FD17 All Models with O.E.M. Number		
R 93-97	FD2218 All (FD5H), FE5H, FF5H		
R 93-97	FD2218LD		
R 93-97	FD2218LP All Models with O.E.M. Number		
R 98	FE2620 All		
83216	W		140149 (1)
R 92	HINO FA15 All FA, FB Models Trucks with:		
R 93-97	FA1415 All (FA15)		
R 93-97	FA1415 All FA, FB Models Trucks with:		
R 93-97	FA1415 All FA1415 (FA15), FB1715 (FB15)		
R 98-04	FA1517 All FA, FB Models Trucks with:		
R 98	FA1517 All		
R 98	FA1517 All FA1517, FA1817, FB1817		
R 98	FA1817		
R 89-91	FB14 All FA, FB Models Trucks with:		
R 92	FB15 All FA, FB Models Trucks with:		
R 93-97	FB1715 All FA, FB Models Trucks with:		
R 93-97	FB1715 All FA1415 (FA15), FB1715 (FB15)		
R 98-04	FB1817 All FA, FB Models Trucks with:		
R 98	FB1817 All		
R 98	FB1817 All FA1517, FA1817, FB1817		
F 93-97	FD2218 All (FD5H), FE5H, FF5H		
F 93-97	FD2218LP All Models with O.E.M. Number		
F 86-87	FE16 All		
F 90-91	GC17 All GC17		
F 92	GC20 All GC20		
83221	W		
R 83-99	CHEVROLET C4500 KODIAK		
R 92-99	C5500 KODIAK		
R 83-89	C5500 KODIAK		
R 90-91	C5500 KODIAK All C Chassis - Conventional Cab with 9100 to 17500 lb Rear Axle		
83225	W		401754 (4)
R 80-85	FORD LN600 All Models with 11000, 13000, 15000, 17000 lb Axles		
83243	W		
R 19-21	CHEVROLET SILVERADO 4500 HD All Models with 4 x 4 Rear		
R 19-22	SILVERADO 5500 HD All Models with 4 x 4 Rear		
R 19-22	SILVERADO 6500 HD All Models with 4 x 4 Rear		
R 19-22	INTERNATIONAL CV515 All Models with 4 x 4 Rear		
83308	W		140149 (1)
F 80-86	FORD C600 All Models with 3100 lb Spring and 7000 lb Axle		
F 80-85	LN600 All Models with 3000, 3300 lb Springs and 5000, 5500, 6000, 7000 lb Axles		

83000 Series, Cab Shock

Shock	POP	Alternative No.	MTG Acc. Supplied
Pos.	Year	Application	
83312	W		140149 (1)
F 80-86	FORD C600 All Models with 4040, 5040 lb Springs and 7000, 9000, 12000 lb Axles		
F 80-85	LN600 All Models with 4400 lb Spring and 7000, 9000 lb Axles		
F 93-05	KENWORTH K300 All Models with Multiple Leaf Springs on Front Axle (3/4" Mounting bolts)		
F	T300		
83317	W		141083 (1)
R 02-13	INTERNATIONAL 4300 All Models with 22,000 lb Rear Spring Suspension		
R 02-13	4400 All Models with 22,000 lb Rear Spring Suspension		
R 13	DURASTAR All Models with 22,000 lb Rear Spring Suspension		
83364	W		
R 16-20	INTERNATIONAL DURASTAR All Models with 10,500 or 13,500 lb Vari-Rate Rear Spring Suspension		
R 12-18	TERRASTAR All Models with 10,500 or 13,500 lb Vari-Rate Rear Spring Suspension		
83391	W		145177 (2)
F 15-21	HINO 258 All Models with O.E.M. Number		
F 15-22	268 All Models with O.E.M. Number		
F 22-24	L6		
F 21	L6 All Models with O.E.M. Number		
83395	W		145054 (1)
R 16-17	INTERNATIONAL DURASTAR All Models with Vari-Rate Rear Spring Suspension		
83397	W		
F 19-22	CHEVROLET SILVERADO 4500 HD All Models with Taperleaf Front		
F 19-23	SILVERADO 5500 HD All Models with Taperleaf Front		
F 19-23	SILVERADO 6500 HD All Models with Taperleaf Front		
F 24	INTERNATIONAL CV515		
F 19-22	CV515 All Models with Taperleaf Front		
83398	W		
R 19-22	CHEVROLET SILVERADO 4500 HD All Models with 11K, 13.5K or 15.5K VARI-RATE Rear Suspension		
R 19-23	SILVERADO 5500 HD All Models with 11K, 13.5K or 15.5K VARI-RATE Rear Suspension		
R 19-23	SILVERADO 6500 HD All Models with 11K, 13.5K or 15.5K VARI-RATE Rear Suspension		
R 24	INTERNATIONAL CV515		
R 19-22	CV515 All Models with 11K, 13.5K or 15.5K VARI-RATE Rear Suspension		
83515	W		140885 (1)
F 16-23	CHEVROLET LCF 3500 All		
F 18	LCF 3500HD		
F 16-17	LCF 3500HD All		
F 19-22	SILVERADO 4500 HD All Diesel Low Cab Forward models with 14,500 lb GVWR		
F 19-22	SILVERADO 4500 HD All Diesel Low Cab Forward models with 16,000 lb to 19,500 lb GVWR		
F 19-22	SILVERADO 5500 HD All Diesel Low Cab Forward models with 14,500 lb GVWR		
F 19-22	SILVERADO 5500 HD All Diesel Low Cab Forward models with 16,000 lb to 19,500 lb GVWR		
F 87-10	W4500 TILTMMASTER All Models with 11000 lb & 13000 lb Suspension		
F 88-10	W5500 TILTMMASTER All Models with 11000 lb & 13000 lb Suspension		
F 87-96	W6500 TILTMMASTER All Models with 11000 lb & 13000 lb Suspension		
F 92-10	GMC W4500 FORWARD All Models with 11000 lb & 13000 lb Suspension		
F 88-10	W5500 FORWARD All Models with 11000 lb & 13000 lb Suspension		

Numerical listing

Shock	POP	Alternative No.	MTG Acc. Supplied
Pos.	Year	Application	
83515	W (cont)		140885 (1)
F 87-96	W6500 FORWARD All Models with 11000 lb & 13000 lb Suspension		
F 85	ISUZU ADDITIONAL APPLICATIONS		
F	ALL MODELS WITH FSR		
F 86	FSR		
F 87-92	FSR All FSR Models		
F 05-09	FTR All Models with O.E.M. Number		
F 84-85	NPR		
F 86-20	NPR All Models with O.E.M. Number		
F 99-23	NPR-HD All Models with O.E.M. Number		
F 23	NPR-XD		
F 15-22	NPR-XD All Models with 14,000 to 15,000 lb GVW		
F 15-22	NPR-XD All Models with 15,000 to 16,000 lb GVW		
F 94-23	NQR All Models with O.E.M. Number		
F 05-23	NRR All Models with O.E.M. Number		
F 88-94	NRR All Models with O.E.M. Number		
F 11-15	REACH All Models with O.E.M. Number		
F 99-04	UD 1200 All Models with O.E.M. Number		
F 05-07	1300 All Models with O.E.M. Number		
F 94-10	1400 All Models with O.E.M. Number		
83518	W		141041 (1)/TR0027 (2)
F 13-20	HINO 155 All Models with O.E.M. Number		
F 21	195		
F 12-20	195 All Models with O.E.M. Number		
83519	W		401011 (4)
R 13-20	HINO 155 All Models with O.E.M. Number		
R 21	195		
R 12-20	195 All Models with O.E.M. Number		
83613	W		141083 (2)
R 87-96	ISUZU FSR All FSR Models		
R 88-96	FTR All Models with O.E.M. Number		
R 94-96	FVR All Models with O.E.M. Number		
R 88-92	FVR All Models with O.E.M. Number		
Cab Shock			
83006	W		
95-05	FREIGHTLINER FL50 All Day Cab Suspensions with O.E.M. Number		
96-05	FL60 All Day Cab Suspensions with O.E.M. Number		
83021	C		
90-96	CHEVROLET C60 KODIAK All Truck Cabs with Link Cabmate Model GMC104TK		
03-09	C4500 KODIAK All Truck Cabs with Link Cabmate Model GMC104TK		
03-09	C5500 KODIAK All Truck Cabs with Link Cabmate Model GMC104TK		
90-91	C5500 KODIAK All Truck Cabs with Link Cabmate Model GMC104TK		
00-01	C7500 KODIAK All Truck Cabs with Link Cabmate Model GMC104TK		
91-05	FREIGHTLINER FL60 All Trucks with Link Cabmate Models FRT153BC-A, FRT106BC or FRT106HD-A		
03-09	GMC C4500 TOPKICK All Truck Cabs with Link Cabmate Model GMC104TK		
03-09	C5500 TOPKICK All Truck Cabs with Link Cabmate Model GMC104TK		
90-96	C6000 TOPKICK All Truck Cabs with Link Cabmate Model GMC104TK		
03-09	C6500 TOPKICK All Truck Cabs with Link Cabmate Model GMC104TK		
97-01	C6500 TOPKICK All Truck Cabs with Link Cabmate Model GMC104TK		
90-96	C7000 TOPKICK All Truck Cabs with Link Cabmate Model GMC104TK		

Numerical listing

Shock	POP	Alternative No.	MTG Acc. Supplied
Pos.	Year	Application	
83021	C	(cont)	
R	97-09	C7500 TOPKICK All Truck Cabs with Link Cabmate Model GMC104TK	
R	96-97	MARMON HERRINGTON 57 GLIDER All Conventional Tractors with Link Cabmate Model MARC57-B	
R	90-94	57 GLIDER All Conventional Tractors with Link Cabmate Model MARC57-B	
83025	C		
R	03-09	GMC C4500 TOPKICK All Models with Link Cabmate Model GMT560	
R	03-09	C5500 TOPKICK All Models with Link Cabmate Model GMT560	
83040	W		
R	02-24	FREIGHTLINER M2 106 All Day Cab Models with Spring Suspensions	
83054	W		
R	02-20	INTERNATIONAL 4300 All Models with O.E.M. Number	
R	11-18	4300LP All Models with O.E.M. Number	
R	08-09	4300LP All Models with O.E.M. Number	
R	02-19	4400 All Models with O.E.M. Number	
R	19	4400LP All Models with O.E.M. Number	
R	11	4400LP All Models with O.E.M. Number	
R	03-09	4400LP All Models with O.E.M. Number	
R	15-20	DURASTAR All Models with O.E.M. Number	
R	13	DURASTAR All Models with O.E.M. Number	
83066	W		
R	23	MACK MD6	
R	24	MD6 All Models with O.E.M. Number	
R	21-22	MD6 All Models with O.E.M. Number	
85000 Series			
85001	B	401754 (4)	
F	93-05	KENWORTH K300 All Models with Taper Leaf Springs on Front Axle (1" Mounting bolts)	
F		T300	
85005	C		
R	08-23	FORD F-53	
85006	B		
F	08-23	FORD F-53	
F	24	F-59 COMMERCIAL STRIPPED CHASSIS	
F	11-23	F-59 COMMERCIAL STRIPPED CHASSIS All MotorHomes with Ford F59 Commercial Chassis with 24,000 lb GVW to 26,000 lb GVW	
F	99-04	FREIGHTLINER FC70 All Models with 10,000 to 18,000 lb Suspension	
F	95-05	FL50 All Models with 10,000 to 18,000 lb Suspension	
F	91-05	FL60 All Models with 10,000 to 18,000 lb Suspension	
F		STERLING TRUCK ACTERRA	
85007	W	401754 (4)	
F	93-05	KENWORTH K300 All K300 COE Medium Duty	
85009	W	145054 (1)	
F	91-94	MITSUBISHI FUSO FK All FK457 Models with O.E.M. Number	
F	88-91	FK All FK455 Models with O.E.M. Number	
85010	W		
R	11-20	FORD F-53	
R	11-21	F-59 COMMERCIAL STRIPPED CHASSIS All F59 Commercial Chassis with 16,000 lb or 19,500 GVW	
R	89-97	F-59 COMMERCIAL STRIPPED CHASSIS All F59 Commercial Chassis with 16,000 lb or 19,500 GVW	

Cab Shock, 85000 Series

Shock	POP	Alternative No.	MTG Acc. Supplied
Pos.	Year	Application	
85012	B	145080 (2)	
R	85	ISUZU ADDITIONAL APPLICATIONS	
R	86-95	NPR All	
F	13	PETERBILT 220 All Models with 12,000 lb Front Axle	
F	10	220 All Models with 12,000 lb Front Axle	
F	07	220 All Models with 12,000 lb Front Axle	
F	08-19	325 All Models with 12000 lb Set Back Front Axle	
85013	C		
F	11-20	FORD F-53	
F	11-21	F-59 COMMERCIAL STRIPPED CHASSIS All F59 Commercial Chassis with 16,000 lb to 22,000 GVW	
F	89-97	F-59 COMMERCIAL STRIPPED CHASSIS All F59 Commercial Chassis with 16,000 lb to 22,000 GVW	
R	13-22	PETERBILT 220 All Models with Reyco 102AR (Standard) Rear Air Suspension	
R	10	220 All Models with Reyco 102AR (Standard) Rear Air Suspension	
R	07	220 All Models with Reyco 102AR (Standard) Rear Air Suspension	
85031	D	145147(1)/TR0027(2)	
F	93-05	KENWORTH K300 All Models with 12,000 lb Taper Leaf Front Springs (5/8" Top Mounting bolt)	
F	08-13	T170 All Models with 8,000 lb Taper Leaf Front Springs	
F	08-10	T270 All Models with 12,000 lb Front Axle	
F	00-08	T300 All Models with 12,000 lb Taper Leaf Front Springs (5/8" Top Mounting bolt)	
85043	W		
F	99-04	FREIGHTLINER FC70 All Models with 6000 to 9000 lb Front axle	
F	95-05	FL50 All Models with 6000 to 9000 lb Front axle	
F	91-05	FL60 All Models with 6000 to 9000 lb Front axle	
85058	C		
F	98-23	FREIGHTLINER MT45 All Step Van Models with O.E.M. Number	
F		MT55	
F		VARIOUS	
85069	A	145089-000 (2)	
R	24	KENWORTH T270	
R	20-23	T270 All Models with Air Glide 400L (AG400L) Rear Air Suspension	
R	08-23	T270 All Models with AG210L Rear Air Suspension	
R	22-24	PETERBILT 536 All Models with Peterbilt Low Air Leaf Suspension	
85071	W	145054 (2)	
R	90-96	CHEVROLET C60 KODIAK All Conventional Cab w/15000, 19000, 21000 lb Multileaf Springs	
R	90-02	C4500 KODIAK	
R	03-09	C4500 KODIAK All C Chassis - Conventional Cab With 15000, 19000, 21000 lb Multileaf Springs	
R	92-02	C5500 KODIAK	
R	03-09	C5500 KODIAK All C Chassis - Conventional Cab With 15000, 19000, 21000 lb Multileaf Springs	
R	90-91	C5500 KODIAK All C Chassis - Conventional Cab With 15000, 19000, 21000 lb Multileaf Springs	
R	00-01	C7500 KODIAK All Conventional Cab w/15000, 19000, 21000 lb Multileaf Springs	
R	90-06	T5500	
R	03	T6500	
R	90-96	T6500	
R	04-06	T6500 All Tilt Cab w/15000, 19000, 21000 lb Multileaf Springs	
R	97-02	T6500 All Tilt Cab w/15000, 19000, 21000 lb Multileaf Springs	
R	90-02	GMC C4500 TOPKICK	
R	03-09	C4500 TOPKICK All C Chassis - Conventional Cab with 15000, 19000, 21000 lb Multileaf Springs	
R	90-02	C5500 TOPKICK	

Numerical listing

Shock	POP	Alternative No.	MTG Acc. Supplied
Pos.	Year	Application	
85071	W	(cont)	
R	03-09	C5500 TOPKICK All C Chassis - Conventional Cab with 15000, 19000, 21000 lb Multileaf Springs	
R	90-06	T5500	
R	03	T6500	
R	90-96	T6500	
R	04-06	T6500 All Tilt Cab with 15000, 19000, 21000 lb Multileaf Springs	
R	97-02	T6500 All Tilt Cab with 15000, 19000, 21000 lb Multileaf Springs	
R	97-02	ISUZU FSR All Models with 15000, 19000, 21000 lb Multileaf Springs	
F	18-20	FTR All FTR Diesel Models with Std Cab	
R	90-09	FTR All Models with 15000, 19000, 21000 lb Multileaf Springs	
R	94-08	FVR All Models with 15000, 19000, 21000 lb Multileaf Springs	
R	90-92	FVR All Models with 15000, 19000, 21000 lb Multileaf Springs	
85072	C		
R	08-22	KENWORTH T270 All Models with Hendrickson Primaax 230, 232, 460, 462, 690 and 692 Air Suspension (8-1/2" to 10" Ride Height)	
85084	C		
F	10-14	KENWORTH T270 All Models with 10,000 lb to 12,000 lb Front Axle	
F	10-14	T270 All Models with 13,200 lb to 14,600 lb Front Axle	
F	10-14	T270 All Models with 8,000 lb Front Axle	
F	08-15	PETERBILT 325 All Models with 8,000 lb Front Axle	
85106	W		
F	21-22	LION LION6 All Trucks with Hendrickson Softek Suspension (12,500 lb Capacity)	
85124	W	145054 (2)	
R	04-09	WORKHORSE W20 All Models with O.E.M. Number	
R	04-09	W22 All Models with O.E.M. Number	
R	04-09	W24 All Models with O.E.M. Number	
85125	W		
F	01-09	WORKHORSE W20 All	
F	01-09	W22 All	
F	04-09	W24 All MotorHome Chassis with O.E.M. Number	
85182	W	145089-200 (2)	
F	13-24	KENWORTH K270 All Models with 10,000 lb to 12,000 lb Front Axle	
F	13-24	PETERBILT 220 All Models with 12,000 lb Front Axle	
85188	D		
R	23	MACK MD6	
R	24	MD6 All Models with O.E.M. Number	
R	21-22	MD6 All Models with O.E.M. Number	
85310	B	141108 (1)	
R	93-05	KENWORTH K300 All All with Air Glide 100 Suspension with 8 air bags, 4 units required	
R		T300	
85331	C		
R	05-15	FREIGHTLINER M2 All Models with Freightliner Low Profile Rear Air Suspension (18,000 to 40,000 lb)	
R	02-10	M2 100 All Models with Freightliner Low Profile Rear Air Suspension (18,000 to 40,000 lb)	
R	02-15	M2 106 All Models with Freightliner Low Profile Rear Air Suspension (18,000 to 40,000 lb)	
R	99-24	MT55 All Models with Freightliner Low Profile Rear Air Suspension	
85335	W		
R	05-21	FREIGHTLINER M2 All Models with Rear 10000 lb - 15000 lb Low Profile AirLiner	
R	02-10	M2 100 All Models with Rear 10000 lb - 15000 lb Low Profile AirLiner	

Numerical listing

Shock	POP	Alternative No.	MTG Acc. Supplied
Pos.	Year	Application	
85335	W (cont)		
R	02-23	M2 106 All Models with Rear 10000 lb - 15000 lb Low Profile AirLiner	
85642	A		
R	19-22	INTERNATIONAL MV607 All Models with International 21,000 lb Rear Air Suspension	
85649	W		143146 (1)
F	12-18	RAM 4500 All Models with O.E.M. Number	
F	12-18	5500 All Models with O.E.M. Number	
F	08-10	STERLING TRUCK BULLET 45 All Models with O.E.M. Number	
F	08-10	BULLET 55 All Models with O.E.M. Number	
85650	W		
R	12-18	RAM 4500 All Models with O.E.M. Number	
R	12-18	5500 All Models with O.E.M. Number	
R	08-10	STERLING TRUCK BULLET 45 All Models with O.E.M. Number	
R	08-10	BULLET 55 All Models with O.E.M. Number	
85656	C		
R	16-19	INTERNATIONAL DURASTAR All Models with 20,000 lb International IROS Air Suspension	
R	16-19	DURASTAR - 4300, 4400 SERIES	
R	20-22	MV607 All Models with 20,000 lb International IROS Air Suspension	
85670	W		
R	19-22	CHEVROLET SILVERADO 4500 HD All Models with IROS Rear	
R	19-22	SILVERADO 5500 HD All Models with IROS Rear	
R	19-22	SILVERADO 6500 HD All Models with IROS Rear	
R	19-22	INTERNATIONAL CV515 All Models with IROS Rear	
85724	A		
R	05-23	FREIGHTLINER B2 All Models with FAS II (40,000 lb) Rear Air Suspension	
R	99-04	FC70 All Models with FAS II (40,000 lb) Rear Air Suspension	
R	95-05	FL50 All Models with FAS II (40,000 lb) Rear Air Suspension	
R	91-05	FL60 All Models with FAS II (40,000 lb) Rear Air Suspension	
R	05-21	M2 All Models with FAS II (40,000 lb) Rear Air Suspension	
R	02-10	M2 100 All Models with FAS II (40,000 lb) Rear Air Suspension	
R	02-24	M2 106 All Models with FAS II (40,000 lb) Rear Air Suspension	
R	03-10	STERLING TRUCK ACTERRA All Models with FAS II (40,000 lb) Rear Air Suspension	
R	01-07	ACTERRA 5500 All Models with FAS II (40,000 lb) Rear Air Suspension	
R	01-07	ACTERRA 6500 All Models with FAS II (40,000 lb) Rear Air Suspension	
85900	B		145054 (2)
R	93-05	KENWORTH K300 All All with Air Glide 200 with 40,000 lb Suspension with 8 air bags, 4 units required	
R		T300	
85902	W		145054 (2)
R	93-05	KENWORTH K300 All All with Air Glide 200 with 46,000 lb Suspension with 8 air bags, 4 units required	
R	00-08	T300 All All with Air Glide 200 with 46,000 lb Suspension with 8 air bags, 4 units required	
85910	W		
F		PETERBILT 330	
85918	A		
F	05-23	FREIGHTLINER B2 All Models with 12000 lb Taperleaf Front Suspension	

85000 Series, 89000 Series

Shock	POP	Alternative No.	MTG Acc. Supplied
Pos.	Year	Application	
85919	A		
F	99-24	FREIGHTLINER MT55 All MT55 Chassis with O.E.M. Number	
85920	B		
F	02-08	FREIGHTLINER M2 106 All Models with 10000 to 12000 lb. Taper-leaf Spring Suspension	
F	02-08	M2 106 All Models with 6000 to 9000 lb Front axle	
F	01-09	STERLING TRUCK ACTERRA	
85921	W		145054 (1)
R	05-21	FREIGHTLINER M2 All Models with Rear 60" Spring ,18000 lb - 23000 lb	
R	02-10	M2 100 All Models with Rear 60" Spring ,18000 lb - 23000 lb	
R	02-23	M2 106 All Models with Rear 60" Spring ,18000 lb - 23000 lb	
85923	D		
R	08-09	INTERNATIONAL 4300 All Models with International 40,000 lb Rear Air Suspension	
R	08-09	4400 All Models with International 40,000 lb Rear Air Suspension	
R		DURASTAR - 4300, 4400 SERIES	
R	10-11	DURASTAR - 4300, 4400 SERIES	
85927	W		
R		INTERNATIONAL DURASTAR - 4300, 4400 SERIES	
85928	C		
F	16-20	INTERNATIONAL DURASTAR All Models with 11,000 lb to 14,000 lb Front axle	
F	16-20	DURASTAR - 4300, 4400 SERIES	
F	23	EMV607	
F	19-22	MV607 All Models with 11,000 lb to 14,000 lb Taper-leaf Springs	
85932	C		
F	03-10	STERLING TRUCK ACTERRA All Models with Hendrickson Front Airtek	
F	01-07	ACTERRA 5500 All Models with Hendrickson Front Airtek	
F	01-07	ACTERRA 6500 All Models with Hendrickson Front Airtek	
85956	C		
R	05-21	FREIGHTLINER M2 All Models with Freightliner TufTrac Rear Air Suspension	
R	02-10	M2 100 All Models with Freightliner TufTrac Rear Air Suspension	
R	02-24	M2 106 All Models with Freightliner TufTrac Rear Air Suspension	
R	03-10	STERLING TRUCK ACTERRA All All Models with Freightliner TufTrac Rear Air Suspension	
85957	D		
F	02-15	INTERNATIONAL 4300 All Models with 12,000 lb Front axle	
F	02-15	4400 All Models with 12,000 lb Front axle	
F	15	DURASTAR All Models with 12,000 lb Front axle	
F	13	DURASTAR All Models with 12,000 lb Front axle	
F	10-15	DURASTAR - 4300, 4400 SERIES	
85959	A		
F		FREIGHTLINER M2	
F	09-24	M2 106 All Models with 8000 to 16000 lb Front Axle and Taperleaf Spring	
85976	D		
R	02-20	INTERNATIONAL 4300 All Models with Hendrickson HAS - 230 or 460 Rear Air Suspension	
R	02-19	4400 All Models with Hendrickson HAS - 230 or 460 Rear Air Suspension	
R	15-20	DURASTAR All Models with Hendrickson HAS - 230 or 460 Rear Air Suspension	
R	13	DURASTAR All Models with Hendrickson HAS - 230 or 460 Rear Air Suspension	

Numerical listing

Shock	POP	Alternative No.	MTG Acc. Supplied
Pos.	Year	Application	
85976	D (cont)		
R	19-22	MV607 All Models with Hendrickson HAS - 230 or 460 Rear Air Suspension	
85988	D		145099 (1)
R	22-24	PETERBILT 536 All Models with Air Trac Suspension (40,000 lb)	
85989	A		
F	15-22	KENWORTH T270 All Models with 10,000 lb to 14,600 lb Taperleaf Springs and Set Back Front Axles	
F	15-22	T270 All Models with 16,000 lb to 20,000 lb Taperleaf Springs and Set Back Front Axles	
F	24	T280 All Models with 10,000 lb to 12,000 lb Mono-leaf front springs	
F	22-24	PETERBILT 536 All Models with 10,000 lb to 14,600 lb Taperleaf Springs and Set Back Front Axles	
89000 Series			
89405	W		
R	13-24	KENWORTH K270 All Models with Hendrickson HAS - 210L or HAS - 230L Rear Air Suspension	
R	93-05	K300 All Models with Hendrickson Rear Air Suspension	
R	08-23	T270 All Models with Hendrickson HAS - 210L or HAS - 230L Rear Air Suspension	
R		T300	
R	00-08	T300 All Models with Hendrickson HAS - 210L or HAS - 230L Rear Air Suspension	
R	13-24	PETERBILT 220 All Models with Hendrickson HAS - 210L or HAS - 230L Rear Air Suspension	
R	10	220 All Models with Hendrickson HAS - 210L or HAS - 230L Rear Air Suspension	
R	07	220 All Models with Hendrickson HAS - 210L or HAS - 230L Rear Air Suspension	
89406	W		
R	00-01	CHEVROLET C7500 KODIAK All Models with Hendrickson Air Suspension (Stamping number 47902-13)	
R	99	T6500 All Models with Hendrickson Air Suspension (Stamping number 47902-13)	
R	06-23	FORD F-53	
R	99-04	F-53	
R	99	GMC T5500	
R	99	T6500 All Models with Hendrickson Air Suspension (Stamping number 47902-13)	
R		ISUZU FVR	
89409	W		140149 (1)
F	80-86	FORD C600 All Models with 4040, 5040 lb Springs and 7000, 9000, 12000 lb Axles	
F	80-85	LN600 All Models with 4400 lb Spring and 7000, 9000 lb Axles	
F	93-05	KENWORTH K300 All Models with Multiple Leaf Springs on Front Axle (3/4" Mounting bolts)	
F		T300	
89410	C		401754 (4)
F	93-05	KENWORTH K300 All Models with Taper Leaf Springs on Front Axle (1" Mounting bolts)	
F		T300	
89413	W		145080 (2)
R	85	ISUZU ADDITIONAL APPLICATIONS	
R	86-95	NPR All	
F	13	PETERBILT 220 All Models with 12,000 lb Front Axle	
F	10	220 All Models with 12,000 lb Front Axle	
F	07	220 All Models with 12,000 lb Front Axle	
F	08-19	325 All Models with 12000 lb Set Back Front Axle	
89414	W		
F	06-23	FORD F-53	
F	99-04	F-53	
F	88-97	F-53	

Numerical listing

Shock	POP	Alternative No.	MTG Acc. Supplied
Pos.	Year	Application	
89414 W (cont)			
F	11-21	F-59 COMMERCIAL STRIPPED CHASSIS All F59 Commercial Chassis with 16,000 lb to 22,000 GVW	
F	89-97	F-59 COMMERCIAL STRIPPED CHASSIS All F59 Commercial Chassis with 16,000 lb to 22,000 GVW	
R	13-22	PETERBILT 220 All Models with Reyco 102AR (Standard) Rear Air Suspension	
R	10	220 All Models with Reyco 102AR (Standard) Rear Air Suspension	
R	07	220 All Models with Reyco 102AR (Standard) Rear Air Suspension	
89423 W 141108 (1)			
R	93-05	KENWORTH K300 All All with Air Glide 100 Suspension with 8 air bags, 4 units required	
R		T300	
89430 C			
R	08-23	FORD F-53	
R	02-23	FREIGHTLINER M2 106 All Models with Reyco 79KB Rear Steel Spring Suspension	
F	05-10	HINO 145 All Models with O.E.M. Number	
F	05-10	165 All Models with O.E.M. Number	
F	05-10	185 All Models with O.E.M. Number	
R	13-24	KENWORTH K270 All Models with Reyco 102 or 79KB Suspension (Drive Axle)	
R	93-05	K300 All Models with Reyco 102 or 79KB Suspension (Drive Axle)	
F	93-05	K300 All Models with Reyco 1209 or 1212 Suspension (Steer Axle)	
R	08-22	T170 All Models with Reyco 79KB Rear Steel Spring Suspension	
R	08-23	T270 All Models with Reyco 102 or 79KB Suspension (Drive Axle)	
R	21-24	T280 All Models with Reyco 102 or 79KB Suspension (Drive Axle)	
F		T300	
R		T300	
R	00-08	T300 All Models with Reyco 102 or 79KB Suspension (Drive Axle)	
R	00-08	T300 All Models with Reyco 1209 or 1212 Suspension (Steer Axle)	
R	08-15	PETERBILT 210 All Models with Reyco 102 or 79KB Suspension (Drive Axle)	
R	13-24	220 All Models with Reyco 102 or 79KB Suspension (Drive Axle)	
R	10	220 All Models with Reyco 102 or 79KB Suspension (Drive Axle)	
R	07	220 All Models with Reyco 102 or 79KB Suspension (Drive Axle)	
R	08-19	325 All Models with Reyco 102 or 79KB Suspension (Drive Axle)	
89431 W			
F	98-23	FREIGHTLINER MT45 All Step Van Models with O.E.M. Number	
F		MT55	
F		VARIOUS	
89443 C			
R	05-23	FREIGHTLINER B2 All Models with FAS II (40,000 lb) Rear Air Suspension	
R	99-04	FC70 All Models with FAS II (40,000 lb) Rear Air Suspension	
R	95-05	FL50 All Models with FAS II (40,000 lb) Rear Air Suspension	
R	91-05	FL60 All Models with FAS II (40,000 lb) Rear Air Suspension	
R	05-21	M2 All Models with FAS II (40,000 lb) Rear Air Suspension	
R	02-10	M2 100 All Models with FAS II (40,000 lb) Rear Air Suspension	
R	02-24	M2 106 All Models with FAS II (40,000 lb) Rear Air Suspension	
R	03-10	STERLING TRUCK ACTERRA All Models with FAS II (40,000 lb) Rear Air Suspension	
R	01-07	ACTERRA 5500 All Models with FAS II (40,000 lb) Rear Air Suspension	
R	01-07	ACTERRA 6500 All Models with FAS II (40,000 lb) Rear Air Suspension	

89000 Series

Shock	POP	Alternative No.	MTG Acc. Supplied
Pos.	Year	Application	
89449 D			
F	05-23	FREIGHTLINER B2 All Models with 12000 lb Taperleaf Front Suspension	
89453 W			
F	03-10	STERLING TRUCK ACTERRA All Models with Hendrickson Front Airtek	
F	01-07	ACTERRA 5500 All Models with Hendrickson Front Airtek	
F	01-07	ACTERRA 6500 All Models with Hendrickson Front Airtek	
89455 C 141108 (1)			
R	08-23	KENWORTH T270 All Models with AG210L Rear Air Suspension	
R	22-24	PETERBILT 536 All Models with Peterbilt Low Air Leaf Suspension	
89458 W			
R	08-09	INTERNATIONAL 4300 All Models with International 40,000 lb Rear Air Suspension	
R	08-09	4400 All Models with International 40,000 lb Rear Air Suspension	
R		DURASTAR - 4300, 4400 SERIES	
R	10-11	DURASTAR - 4300, 4400 SERIES	
89460 W			
F	10-14	KENWORTH T270 All Models with 10,000 lb to 12,000 lb Front Axle	
F	10-14	T270 All Models with 13,200 lb to 14,600 lb Front Axle	
F	10-14	T270 All Models with 8,000 lb Front Axle	
F	08-15	PETERBILT 325 All Models with 8,000 lb Front Axle	
89503 W			
F	02-08	FREIGHTLINER M2 106 All Models with 10000 to 12000 lb. Taper-leaf Spring Suspension	
F	02-08	M2 106 All Models with 6000 to 9000 lb Front axle	
F	01-09	STERLING TRUCK ACTERRA	

Numerical listing

Shock	POP	Alternative No.	MTG Acc. Supplied
Pos.	Year	Application	



Medium Duty Shocks

(Alphabetical Listing)

(Numerical Listing)

Amortiguadores de servicio mediano

(Lista alfabética)

(Listado numérico)



Amortisseurs à usage moyen

(Liste alphabétique)

(Ordre numérique)

Gabriel[®]
THE ORIGINAL

APPLICATION GUIDE

Year	Fitment Notes	OEM#								
			Fleetline/ Gas SLX	Classic/ Ultra/ ProGuard/ Guardian	Max Control/ LTV Severe Duty/ Load Carrier	Steering Dampers/ Steering Stabilizer/ Cab Shock	Fleetline/ Gas SLX	Classic/ Ultra/ ProGuard/ Guardian	Max Control/ LTV Severe Duty/ Load Carrier/ HiJackers	Steering Dampers/ Steering Stabilizer/ Cab Shock

BERKSHIRE COACH ULTRA 24

BERKSHIRE COACH

17-24	Coaches with Ford E350 or E450 Chassis LTV Severe Duty	8C2Z-18124-D 8C24-18045-DA ASH-1154	↓ ○	58622
		8C24-18080-DB ASH-1136 8C2Z-18125-D	↓ ○	58623
	Coaches with Ford E350 or E450 Chassis Max Control	8C2Z-18124-D 8C24-18045-DA ASH-1154	↓ ○	77614
		8C24-18080-DB ASH-1136 8C2Z-18125-D	↓ ○	77623
	Coaches with Ford E350 or E450 Chassis Ultra Truck Shock	8C2Z-18124-D 8C24-18045-DA ASH-1154	↓ ○	G63622
		8C24-18080-DB ASH-1136 8C2Z-18125-D	↓ ○	G63623

ULTRA 28

17-24	Coaches with Ford E450 Chassis LTV Severe Duty	8C2Z-18124-D 8C24-18045-DA ASH-1154	↓ ○	58622
		8C24-18080-DB ASH-1136 8C2Z-18125-D	↓ ○	58623
	Coaches with Ford E450 Chassis Max Control	8C2Z-18124-D 8C24-18045-DA ASH-1154	↓ ○	77614
		8C24-18080-DB ASH-1136 8C2Z-18125-D	↓ ○	77623
	Coaches with Ford E450 Chassis Ultra Truck Shock	8C2Z-18124-D 8C24-18045-DA ASH-1154	↓ ○	G63622
		8C24-18080-DB ASH-1136 8C2Z-18125-D	↓ ○	G63623

BLUE BIRD

BLUE BIRD

MICROBIRD TYPE A SCHOOL BUS

92-24	Models with Ford E350 or E450 Chassis LTV Severe Duty	8C2Z-18124-D 8C24-18045-DA ASH-1154 AT-163G	↓ ○	58622
		8C24-18080-DB ASH-1136 8C2Z-18125-D AT-164G	↓ ○	58623
	Models with Ford E350 or E450 Chassis Max Control	8C2Z-18124-D 8C24-18045-DA ASH-1154 AT-163G	↓ ○	77614
		8C24-18080-DB ASH-1136 8C2Z-18125-D AT-164G	↓ ○	77623
	Models with Ford E350 or E450 Chassis Ultra Truck Shock	8C2Z-18124-D 8C24-18045-DA ASH-1154 AT-163G	↓ ○	G63622
		8C24-18080-DB ASH-1136 8C2Z-18125-D AT-164G	↓ ○	G63623



CHAMPION BUS INC.

CHAMPION BUS INC.

AMERICAN COACH

	Shuttle buses with Ford E350 or E450 Chassis (Up to 2023) To 2020 LTV Severe Duty	8C24-18080-DB ASH-1136 8C2Z-18125-D AT-164G	↓ ○	58623
--	---	--	--------	------	------	------	------	------	-------	------	------

APPLICATION GUIDE

Year	Fitment Notes	OEM#								
			Fleetline\ Gas SLX	Classic\ Ultra\ ProGuard\ Guardian	Max Control\ LTV Severe Duty\ Load Carrier	Steering Dampers\ Steering Stabilizer\ Cab Shock	Fleetline\ Gas SLX	Classic\ Ultra\ ProGuard\ Guardian	Max Control\ LTV Severe Duty\ Load Carrier\ HiJackers	Steering Dampers\ Steering Stabilizer\ Cab Shock

CHAMPION BUS INC.

CHAMPION BUS INC.

AMERICAN COACH (cont)

Shuttle buses with Ford E350 or E450 Chassis (Up to 2023) To 2020 Max Control	8C24-18080-DB ASH-1136 8C2Z-18125-D AT-164G		77623
Shuttle buses with Ford E350 or E450 Chassis (Up to 2023) To 2020 Ultra Truck Shock	8C24-18080-DB ASH-1136 8C2Z-18125-D AT-164G		G63623
Shuttle buses with Ford E350 or E450 Chassis (Up to 2023) To 2023 LTV Severe Duty	8C2Z-18124-D 8C24-18045-DA ASH-1154 AT-163G		58622
Shuttle buses with Ford E350 or E450 Chassis (Up to 2023) To 2023 Max Control	8C2Z-18124-D 8C24-18045-DA ASH-1154 AT-163G		77614
Shuttle buses with Ford E350 or E450 Chassis (Up to 2023) To 2023 Ultra Truck Shock	8C2Z-18124-D 8C24-18045-DA ASH-1154 AT-163G		G63622



CHALLENGER

Shuttle buses with Ford E350 or E450 Chassis (Up to 2023) LTV Severe Duty	8C2Z-18124-D 8C24-18045-DA ASH-1154 AT-163G		58622
	8C24-18080-DB ASH-1136 8C2Z-18125-D AT-164G		58623
Shuttle buses with Ford E350 or E450 Chassis (Up to 2023) Max Control	8C2Z-18124-D 8C24-18045-DA ASH-1154 AT-163G		77614
	8C24-18080-DB ASH-1136 8C2Z-18125-D AT-164G		77623
Shuttle buses with Ford E350 or E450 Chassis (Up to 2023) Ultra Truck Shock	8C2Z-18124-D 8C24-18045-DA ASH-1154 AT-163G		G63622
	8C24-18080-DB ASH-1136 8C2Z-18125-D AT-164G		G63623

CRUSADER

Shuttle buses with Ford E350 Chassis To 2020 LTV Severe Duty	8C24-18080-DB ASH-1136 8C2Z-18125-D AT-164G		58623
Shuttle buses with Ford E350 Chassis To 2020 Max Control	8C24-18080-DB ASH-1136 8C2Z-18125-D AT-164G		77623
Shuttle buses with Ford E350 Chassis To 2020 Ultra Truck Shock	8C24-18080-DB ASH-1136 8C2Z-18125-D AT-164G		G63623
Shuttle buses with Ford E350 Chassis To 2023 LTV Severe Duty	8C2Z-18124-D 8C24-18045-DA ASH-1154 AT-163G		58622
Shuttle buses with Ford E350 Chassis To 2023 Max Control	8C2Z-18124-D 8C24-18045-DA ASH-1154 AT-163G		77614
Shuttle buses with Ford E350 Chassis To 2023 Ultra Truck Shock	8C2Z-18124-D 8C24-18045-DA ASH-1154 AT-163G		G63622

APPLICATION GUIDE

Year	Fitment Notes	OEM#								
			Fleetline/ Gas SLX	Classic/ Ultra/ ProGuard/ Guardian	Max Control/ LTV Severe Duty/ Load Carrier	Steering Dampers/ Steering Stabilizer/ Cab Shock	Fleetline/ Gas SLX	Classic/ Ultra/ ProGuard/ Guardian	Max Control/ LTV Severe Duty/ Load Carrier/ HiJackers	Steering Dampers/ Steering Stabilizer/ Cab Shock

CHAMPION BUS INC.

CHAMPION BUS INC.

LF TRANSPORT

Shuttle buses with Ford E450 Chassis (Up to 2023) LTV Severe Duty	8C2Z-18124-D 8C24-18045-DA ASH-1154 AT-163G	 O	58622				
	8C24-18080-DB ASH-1136 8C2Z-18125-D AT-164G	 O			58623	
Shuttle buses with Ford E450 Chassis (Up to 2023) Max Control	8C2Z-18124-D 8C24-18045-DA ASH-1154 AT-163G	 O	77614				
	8C24-18080-DB ASH-1136 8C2Z-18125-D AT-164G	 O			77623	
Shuttle buses with Ford E450 Chassis (Up to 2023) Ultra Truck Shock	8C2Z-18124-D 8C24-18045-DA ASH-1154 AT-163G	 O	G63622				
	8C24-18080-DB ASH-1136 8C2Z-18125-D AT-164G	 O		G63623		

VARIOUS

GMC P6000 Chassis 83000 Series	22064230	 T	83136				
--------------------------------	----------	-------	-------	------	------	------	--	--	--	--

CHEVROLET

CHEVROLET



4, 40, 4000 & 4500 SERIES

69-72	All - Exc. Tilt Cab 83000 Series	22012096 3192892	 O	83221				
67-72	S-40 School Bus 83000 Series	22012096 3192892	 O	83221				
69-70	D-D Forward Control with 9000 & 11000 lb. Axles - Exc. Tilt Cab 83000 Series	22012096 3192892	 O	83221				
	D-D Forward Control with Tilt Cab 83000 Series	4940606 22012095	 O	83126				
	D-D Forward Control with Tilt Cab 89000 Series	4940606 22012095	 O	89430				
67-68	TDM 4 Cycle Detroit Diesel with Tandem Axle - Exc. Tilt Cab 83000 Series	22012096 3192892	 O	83221			
60-68	C-40 , P-40, SS-40 Models 85000 Series	 O	85005				
	C-40 , P-40, SS-40 Models 89000 Series	 O	89430				
68	Cowl - Exc. School Bus 83000 Series	22012096 3192892	 O	83221				

5, 50, 5000 & 5500 SERIES

76-89	C Chassis - Conventional Cab 83000 Series	22012196	 O	83221			
	C, M, S Chassis - Conventional Cab 83000 Series	22012169 22012096	 O	83221			
75-80	C, M, S Chassis - Conventional Cab 83000 Series	4975510	 O	83221				
73-80	C, M, S Chassis - Conventional Cab 83000 Series	22007750 4975494 4975467	 O	83207				
	C, M, S Chassis - Conventional Cab 89000 Series	22007750 4975494 4975467	 O	89407				
71-72	TDM 4 Cycle Detroit Diesel with Tandem Axle - Exc. Tilt Cab 83000 Series	4940606 22012095	 O	83126			
	TDM 4 Cycle Detroit Diesel with Tandem Axle - Exc. Tilt Cab 89000 Series	4940606 22012095	 O	89430			

APPLICATION GUIDE

Year	Fitment Notes	OEM#								
			Fleetline\ Gas SLX	Classic\ Ultra\ ProGuard\ Guardian	Max Control\ LTV Severe Duty\ Load Carrier	Steering Dampers\ Steering Stabilizer\ Cab Shock	Fleetline\ Gas SLX	Classic\ Ultra\ ProGuard\ Guardian	Max Control\ LTV Severe Duty\ Load Carrier\ HiJackers	Steering Dampers\ Steering Stabilizer\ Cab Shock

CHEVROLET

CHEVROLET

5, 50, 5000 & 5500 SERIES (cont)

69-72	All - Exc. Tilt Cab 83000 Series	22012096 3192892	OO	83221
69-70	D-D Forward Control with 9000 & 11000 lb. Axles - Exc. Tilt Cab 83000 Series	22012096 3192892	OO	83221
	D-D Forward Control with Tilt Cab 83000 Series	4940606 22012095	OO	83126
	D-D Forward Control with Tilt Cab 89000 Series	4940606 22012095	OO	89430
63-69	C-50, M-50, S-50, SE-50, T-50 Models 83000 Series	OO	83221
	C-50, M-50, S-50, SE-50, T-50 Models 85000 Series	OO	85005
	C-50, M-50, S-50, SE-50, T-50 Models 89000 Series	OO	89430
67-68	TDM 4 Cycle Detroit Diesel with Tandem Axle - Exc. Tilt Cab 83000 Series	22012096 3192892	OO	83221
68	Cowl - Exc. School Bus 83000 Series	22012096 3192892	OO	83221

B - SERIES - SCHOOL BUS

	Models with O.E.M. Number 83000 Series	88982682 15588554 22064230 15123676		83136
--	--	--	--	-------	------	------	------	------	------	------	------

B6

90-07	B6, B7 Model School Bus Chassis With 15000, 19000, 21000 lb Multileaf Springs 85000 Series	15174902 22064232		85071
-------	--	----------------------	--	------	------	------	------	-------	------	------	------

C - SERIES (C6500, C7500, C8500) KODIAK

	Models with O.E.M. Number 83000 Series	88982684		83136
--	--	----------	--	-------	------	------	------	------	------	------	------



C60 KODIAK

90-96	Conventional Cab w/ Front Shock with O.E.M. Number	88982682 15588554 15887728 15174898 19152843 22064230 15123676		83136
	Conventional Cab w/15000, 19000, 21000 lb Multileaf Springs	15174902 88982686 22064232		85071
	Conventional Cab w/19000, 21000, 23000 lb Taperleaf Springs (EXC Low Profile Vehicle)	22064233		83136
	Truck Cabs with Link Cabmate Model GMC104TK	1201-0054 1202-0054	OO	83021

C4500 KODIAK

03-09	C Chassis - Conventional Cab	88982682 15588554 15887728 19152843 22064230 15123676		83136
	C Chassis - Conventional Cab w/19000, 21000, 23000 lb Taperleaf Springs (EXC Low Profile Vehicle)	22064233		83136
	C Chassis - Conventional Cab With 15000, 19000, 21000 lb Multileaf Springs	15174902 88982686 22064232		85071
	Truck Cabs with Link Cabmate Model GMC104TK	1201-0054 1202-0054	OO	83021

APPLICATION GUIDE

Year	Fitment Notes	OEM#								
			Fleetline/ Gas SLX	Classic/ Ultra/ ProGuard/ Guardian	Max Control/ LTV Severe Duty/ Load Carrier	Steering Dampers/ Steering Stabilizer/ Cab Shock	Fleetline/ Gas SLX	Classic/ Ultra/ ProGuard/ Guardian	Max Control/ LTV Severe Duty/ Load Carrier/ HiJackers	Steering Dampers/ Steering Stabilizer/ Cab Shock

CHEVROLET

CHEVROLET



C4500 KODIAK (cont)

90-02	C Chassis - Conventional Cab 83000 Series	88982682 15588554 15887728 19152843 22064230 15123676	 T	83136	
	C Chassis - Conventional Cab w/19000, 21000, 23000 lb Taperleaf Springs (EXC Low Profile Vehicle) 83000 Series	22064233	83136
	C Chassis - Conventional Cab With 15000, 19000, 21000 lb Multileaf Springs 85000 Series	15174902 88982686 22064232	85071
83-99	C Chassis - Conventional Cab with 9100 to 17500 lb Rear Axle 83000 Series	22064432	83221

C5500 KODIAK

03-09	C Chassis - Conventional Cab	88982682 15588554 15887728 19152843 22064230 15123676	 T	83136	
	C Chassis - Conventional Cab w/19000, 21000, 23000 lb Taperleaf Springs (EXC Low Profile Vehicle)	22064233	83136
	C Chassis - Conventional Cab With 15000, 19000, 21000 lb Multileaf Springs	15174902 88982686 22064232	85071
	Truck Cabs with Link Cabmate Model GMC104TK	1201-0054 1202-0054	O O	83021
92-02	C Chassis - Conventional Cab 83000 Series	88982682 15588554 15887728 19152843 22064230 15123676	 T	83136	
	C Chassis - Conventional Cab w/19000, 21000, 23000 lb Taperleaf Springs (EXC Low Profile Vehicle) 83000 Series	22064233	83136
	C Chassis - Conventional Cab With 15000, 19000, 21000 lb Multileaf Springs 85000 Series	15174902 88982686 22064232	85071
92-99	C Chassis - Conventional Cab with 9100 to 17500 lb Rear Axle 83000 Series	22064432	83221
90-91	C Chassis - Conventional Cab	88982682 15588554 15887728 19152843 22064230 15123676	 T	83136	
	C Chassis - Conventional Cab w/19000, 21000, 23000 lb Taperleaf Springs (EXC Low Profile Vehicle)	22064233	83136
	C Chassis - Conventional Cab With 15000, 19000, 21000 lb Multileaf Springs	15174902 88982686 22064232	85071
	C Chassis - Conventional Cab with 9100 to 17500 lb Rear Axle	22064432	83221
	Truck Cabs with Link Cabmate Model GMC104TK	1201-0054 1202-0054	O O	83021
83-89	C Chassis - Conventional Cab with 9100 to 17500 lb Rear Axle 83000 Series	22064432	83221

APPLICATION GUIDE

Year	Fitment Notes	OEM#								
			Fleetline\ Gas SLX	Classic\ Ultra\ ProGuard\ Guardian	Max Control\ LTV Severe Duty\ Load Carrier	Steering Dampers\ Steering Stabilizer\ Cab Shock	Fleetline\ Gas SLX	Classic\ Ultra\ ProGuard\ Guardian	Max Control\ LTV Severe Duty\ Load Carrier\ HiJackers	Steering Dampers\ Steering Stabilizer\ Cab Shock

CHEVROLET

CHEVROLET

C6500 KODIAK

97-09	Conventional Cab w/ Front Shock with O.E.M. Number	88982682 15588554 15887728 15174898 19152843 22064230 15123676		83136
	Conventional Cab w/15000, 19000, 21000 lb Multileaf Springs	15174902 88982686 22064232		85071
	Conventional Cab w/19000, 21000, 23000 lb Taperleaf Springs (EXC Low Profile Vehicle)	22064233		83136
	Models with Hendrickson Air Suspension (Stamping number 47902-13)	12474915 15963161		83122 89406
	Models with Hendrickson Air Suspension with O.E.M. Number	60670-005 060665-003 12474917 15740554 59057-001 47902-29		83137
	Truck Cabs with Link Cabmate Model GMC104TK	1201-0054 1202-0054		83021
97-99	Conventional Cab with 9100 to 17500 lb Rear Axle	22064432		83221

C7500 KODIAK

00-01	Conventional Cab w/ Front Shock with O.E.M. Number	88982682 15588554 15887728 15174898 19152843 22064230 15123676		83136
	Conventional Cab w/15000, 19000, 21000 lb Multileaf Springs	15174902 88982686 22064232		85071
	Conventional Cab w/19000, 21000, 23000 lb Taperleaf Springs (EXC Low Profile Vehicle)	22064233		83136
	Models with Hendrickson Air Suspension (Stamping number 47902-13)	12474915 15963161		83122 89406
	Models with Hendrickson Air Suspension with O.E.M. Number	60670-005 060665-003 12474917 15740554 59057-001 47902-29		83137
	Truck Cabs with Link Cabmate Model GMC104TK	1201-0054 1202-0054		83021

EXPRESS 4500

09-22	All			61685 G63895	61687 G63897	58638 77638
-------	-----	--	--	------	-----------------	------	------	------	-----------------	----------------	------



LCF 3500

16-23	All	98381010 98232671		83515
		98380746		83159

LCF 3500HD

18	83000 Series	98381010 98232671		83515
		98380746		83159
16-17	All	98381010 98232671		83515
		98380746		83159

APPLICATION GUIDE

Year	Fitment Notes	OEM#								
			Fleetline/ Gas SLX	Classic/ Ultra/ ProGuard/ Guardian	Max Control/ LTV Severe Duty/ Load Carrier	Steering Dampers/ Steering Stabilizer/ Cab Shock	Fleetline/ Gas SLX	Classic/ Ultra/ ProGuard/ Guardian	Max Control/ LTV Severe Duty/ Load Carrier/ HiJackers	Steering Dampers/ Steering Stabilizer/ Cab Shock

CHEVROLET

CHEVROLET

P60

92-96	Motorhome Chassis	22064233
-------	-------------------	----------	-------	-------	-------	-------	-------	-------	-------	-------	-------	-------	-------

P6000

92-96	Motorhome Chassis	22064233
-------	-------------------	----------	-------	-------	-------	-------	-------	-------	-------	-------	-------	-------	-------

SILVERADO 4500 HD

19-22	Diesel Low Cab Forward models with 14,000 to 15,000 lb Rear	8983807460 8-98380-746-0
	Diesel Low Cab Forward models with 14,500 lb GVWR	8983810100	 O	83515
	Diesel Low Cab Forward models with 15,000 to 16,000 lb Rear	8983807470	 O	83159
	Diesel Low Cab Forward models with 16,000 lb to 19,500 lb GVWR	8983810120	 O	83515
	Models with 11K, 13.5K or 15.5K VARI-RATE Rear Suspension	4208946C1 4206863C1	 O	83398
	Models with 7,000 to 8,000 lb Front Axle	3989717C1	 O	83135
	Models with IROS Rear	4214011C2	 O	85670
19-21	Models with 4 x 4 Rear	4109458C2	 O	83243
	Models with Taperleaf Front	4109582C1 4089293C1 4109583C1 4207304C1	 O	83397
	Models with 4 x 4 Rear	4109458C2	 O	83243

SILVERADO 5500 HD

19-23	Models with 11K, 13.5K or 15.5K VARI-RATE Rear Suspension	4208946C1 4206863C1
	Models with Taperleaf Front	4109582C1 4089293C1 4109583C1 4207304C1	 O	83397
19-22	Diesel Low Cab Forward models with 14,000 to 15,000 lb Rear	8983807460 8-98380-746-0	 O	83159
	Diesel Low Cab Forward models with 14,500 lb GVWR	8983810100	 O	83515
	Diesel Low Cab Forward models with 15,000 to 16,000 lb Rear	8983807470	 O	83159
	Diesel Low Cab Forward models with 16,000 lb to 19,500 lb GVWR	8983810120	 O	83515
	Models with 4 x 4 Rear	4109458C2	 O	83243
	Models with 7,000 to 8,000 lb Front Axle	3989717C1	 O	83135
	Models with IROS Rear	4214011C2	 O	85670



SILVERADO 6500 HD

19-23	Models with 11K, 13.5K or 15.5K VARI-RATE Rear Suspension	4208946C1 4206863C1
	Models with Taperleaf Front	4109582C1 4089293C1 4109583C1 4207304C1	 O	83397
19-22	Models with 4 x 4 Rear	4109458C2	 O	83243
	Models with 7,000 to 8,000 lb Front Axle	3989717C1	 O	83135
	Models with IROS Rear	4214011C2	 O	85670

T5500

97-09	FL1 Tilt Cab with 8100 lb Axle 83000 Series	22165188 22165187 22064804 22064805
-------	---	--	-------	-------	-------	-------	-------	-------	-------	-------	-------	-------	-------

APPLICATION GUIDE

Year	Fitment Notes	OEM#								
			Fleetline\ Gas SLX	Classic\ Ultra\ ProGuard\ Guardian	Max Control\ LTV Severe Duty\ Load Carrier	Steering Dampers\ Steering Stabilizer\ Cab Shock	Fleetline\ Gas SLX	Classic\ Ultra\ ProGuard\ Guardian	Max Control\ LTV Severe Duty\ Load Carrier\ HiJackers	Steering Dampers\ Steering Stabilizer\ Cab Shock

CHEVROLET

CHEVROLET

T5500 (cont)

97-09	FL2 Tilt Cab with 5000 to 11000 lb Axle 83000 Series	22166442 22064807		83136
	FL3 Tilt Cab with 14575 lb Axle 83000 Series	22165189 22064806		83136
90-06	Tilt Cab w/15000, 19000, 21000 lb Multileaf Springs 85000 Series	15174902 22064232			85071
92-99	Tilt Cab w/19000, 21000, 23000 lb Taperleaf Springs (EXC Low Profile Veh.) 83000 Series	22064233			83136

T6500

04-09	FL1 Tilt Cab with 8100 lb Axle	22165188 22165187 22064804 22064805		83136
	FL2 Tilt Cab with 5000 to 11000 lb Axle	22166442 22064807		83136
	FL3 Tilt Cab with 14575 lb Axle	22165189 22064806		83136
04-06	Tilt Cab w/15000, 19000, 21000 lb Multileaf Springs	15174902 22064232			85071
03	FL1 Tilt Cab with 8100 lb Axle 83000 Series	22165188 22165187 22064804 22064805		83136
	FL2 Tilt Cab with 5000 to 11000 lb Axle 83000 Series	22166442 22064807		83136
	FL3 Tilt Cab with 14575 lb Axle 83000 Series	22165189 22064806		83136
	Tilt Cab w/15000, 19000, 21000 lb Multileaf Springs 85000 Series	15174902 22064232			85071
97-02	FL1 Tilt Cab with 8100 lb Axle	22165188 22165187 22064804 22064805		83136
	FL2 Tilt Cab with 5000 to 11000 lb Axle	22166442 22064807		83136
	FL3 Tilt Cab with 14575 lb Axle	22165189 22064806		83136
	Tilt Cab w/15000, 19000, 21000 lb Multileaf Springs	15174902 22064232			85071
97-99	Tilt Cab w/19000, 21000, 23000 lb Taperleaf Springs (EXC Low Profile Veh.)	22064233			83136
99	Models with Hendrickson Air Suspension (Stamping number 47902-13)	12474915 15963161			83122 89406
92-96	Tilt Cab w/19000, 21000, 23000 lb Taperleaf Springs (EXC Low Profile Veh.) 83000 Series	22064233			83136
90-96	Tilt Cab w/15000, 19000, 21000 lb Multileaf Springs 85000 Series	15174902 22064232			85071

VAN 1 TON, P SERIES

92-96	Motorhome Chassis	22064233			83136
-------	-------------------	----------	--	------	------	------	------	--	-------	------	------	------



W4500 TILTMASER

87-10	Models with 11000 lb & 13000 lb Suspension	9516306471 97083029 94454987 98232671 97083027 8972536200 8-94454-986-0 8-94454-987-0 97253620 8-97253-620-0 8944549870 8944549860		83515
-------	--	---	--	-------	------	------	------	--	------	------	------	------

W5500 TILTMASER

88-10	Models with 11000 lb & 13000 lb Suspension	97253620		83515
-------	--	----------	--	-------	------	------	------	--	------	------	------	------

APPLICATION GUIDE

Year	Fitment Notes	OEM#								
			Fleetline/ Gas SLX	Classic/ Ultra/ ProGuard/ Guardian	Max Control/ LTV Severe Duty/ Load Carrier	Steering Dampers/ Steering Stabilizer/ Cab Shock	Fleetline/ Gas SLX	Classic/ Ultra/ ProGuard/ Guardian	Max Control/ LTV Severe Duty/ Load Carrier/ HiJackers	Steering Dampers/ Steering Stabilizer/ Cab Shock

CHEVROLET

CHEVROLET

W6500 TILTMASTER

87-96	Models with 11000 lb & 13000 lb Suspension	1-51630-168-1	 O	83515				
-------	--	---------------	-------	-------	------	------	------	--	--	--	--

CHRYSLER

CHRYSLER

MOTORHOME CHASSIS

73-81	M & R-300, 400, 500 Motorhome Chassis Ultra Truck Shock	3638112		 O		G63183
63-72	M-300, M-375 & R-375 Motorhome Chassis Ultra Truck Shock	2961043 3633744		 O		G63183

COACH HOUSE

COACH HOUSE

PLATINUM

03-24	Motorhomes with Ford E450 Chassis	8C2Z-18124-D 8C24-18045-DA ASH-1154 AT-163G	 O	G63622	58622 77614
		8C24-18080-DB ASH-1136 8C2Z-18125-D AT-164G	 O	 O	G63623	58623 77623

PLATINUM III

19-22	MotorHomes with Ford Transit-350 Chassis		 O	G57816 ⁶⁰	 O		G64177
-------	--	--	-------	------	----------------------	------	------	-------	--	--------	------	------

PLATINUM IV

23-24	Motorhomes with Ford E450 Chassis	8C2Z-18124-D 8C24-18045-DA ASH-1154 AT-163G	 O	G63622	58622 77614
		8C24-18080-DB ASH-1136 8C2Z-18125-D AT-164G	 O	 O	G63623	58623 77623



COACHMEN

COACHMEN

AURORA

09	MotorHomes with Ford F53 Chassis with 16,000 lb GVW to 22,000 lb GVW 83000 Series	ASH-1229 ASH-1228 9U94-18045-AA ASH-1205 AT-620 ASH-1022 1C34-18045-AA ASH-294 9U9Z-18124-A ASH-25822 ASH-25823 1C34-18045-JA AT-766	 O	83209
		ASH-1206 9U94-18080-AA AT-621 ASH-25824 9U9Z-18125-A ASH-1023 ASH-1230 ASH-137	 O	 O	83122
	MotorHomes with Ford F53 Chassis with 16,000 lb GVW to 22,000 lb GVW 89000 Series	ASH-1229 ASH-1228 9U94-18045-AA ASH-1205 AT-620 ASH-1022 1C34-18045-AA ASH-294 9U9Z-18124-A ASH-25822 ASH-25823 1C34-18045-JA AT-766	 O	89414

APPLICATION GUIDE

Year	Fitment Notes	OEM#								
			Fleetline\ Gas SLX	Classic\ Ultra\ ProGuard\ Guardian	Max Control\ LTV Severe Duty\ Load Carrier	Steering Dampers\ Steering Stabilizer\ Cab Shock	Fleetline\ Gas SLX	Classic\ Ultra\ ProGuard\ Guardian	Max Control\ LTV Severe Duty\ Load Carrier\ HiJackers	Steering Dampers\ Steering Stabilizer\ Cab Shock

COACHMEN

COACHMEN

AURORA (cont)

09	MotorHomes with Ford F53 Chassis with 16,000 lb GVW to 22,000 lb GVW 89000 Series	ASH-1206 9U94-18080-AA AT-621 ASH-25824 9U9Z-18125-A ASH-1023 ASH-1230 ASH-137	OIO	83209	89406	OIO
08	MotorHomes with Ford F53 Chassis with 16,000 lb GVW to 22,000 lb GVW	ASH-1229 ASH-1228 9U94-18045-AA ASH-1205 AT-620 ASH-1022 1C34-18045-AA ASH-294 9U9Z-18124-A ASH-25822 ASH-25823 1C34-18045-JA AT-766	OIO	83209	OIO
08		ASH-1206 9U94-18080-AA AT-621 ASH-25824 9U9Z-18125-A ASH-1023 ASH-1230 ASH-137	OIO	83122 89406	OIO
07	MotorHomes with Ford F53 Chassis with 16,000 lb GVW to 22,000 lb GVW 83000 Series	ASH-1229 ASH-1228 9U94-18045-AA ASH-1205 AT-620 ASH-1022 1C34-18045-AA ASH-294 9U9Z-18124-A ASH-25822 ASH-25823 1C34-18045-JA AT-766	OIO	83209	OIO
07		ASH-1206 9U94-18080-AA AT-621 ASH-25824 9U9Z-18125-A ASH-1023 ASH-1230 ASH-137	OIO	83122	OIO
07	MotorHomes with Ford F53 Chassis with 16,000 lb GVW to 22,000 lb GVW 89000 Series	ASH-1229 ASH-1228 9U94-18045-AA ASH-1205 AT-620 ASH-1022 1C34-18045-AA ASH-294 9U9Z-18124-A ASH-25822 ASH-25823 1C34-18045-JA AT-766	OIO	89414	OIO
07		ASH-1206 9U94-18080-AA AT-621 ASH-25824 9U9Z-18125-A ASH-1023 ASH-1230 ASH-137	OIO	89406	OIO
04-06	MotorHomes with Ford F53 Chassis with 16,000 lb GVW to 22,000 lb GVW	ASH-1229 ASH-1228 9U94-18045-AA ASH-1205 AT-620 ASH-1022 1C34-18045-AA ASH-294 9U9Z-18124-A ASH-25822 ASH-25823 1C34-18045-JA AT-766	OIO	83209	OIO

APPLICATION GUIDE

Year	Fitment Notes	OEM#								
			Fleetline/ Gas SLX	Classic/ Ultra/ ProGuard/ Guardian	Max Control/ LTV Severe Duty/ Load Carrier	Steering Dampers/ Steering Stabilizer/ Cab Shock	Fleetline/ Gas SLX	Classic/ Ultra/ ProGuard/ Guardian	Max Control/ LTV Severe Duty/ Load Carrier/ HiJackers	Steering Dampers/ Steering Stabilizer/ Cab Shock

COACHMEN

COACHMEN

AURORA (cont)

04-06	MotorHomes with Ford F53 Chassis with 16,000 lb GVW to 22,000 lb GVW	ASH-1206 9U94-18080-AA AT-621 ASH-25824 9U9Z-18125-A ASH-1023 ASH-1230 ASH-137									83122 89406			
-------	--	---	--	--	--	--	--	--	--	--	----------------	--	--	--

BEYOND

19-22	MotorHomes with Ford Transit-350 Chassis				G57816 ⁶⁰							G64177		
-------	--	--	--	--	----------------------	--	--	--	--	--	--	--------	--	--

CATALINA

	MotorHomes with Ford E350 or E450 Chassis LTV Severe Duty	8C2Z-18124-D 8C24-18045-DA ASH-1154 AT-163G			58622									
		8C24-18080-DB ASH-1136 8C2Z-18125-D AT-164G									58623			
	MotorHomes with Ford E350 or E450 Chassis Max Control	8C2Z-18124-D 8C24-18045-DA ASH-1154 AT-163G			77614									
		8C24-18080-DB ASH-1136 8C2Z-18125-D AT-164G									77623			
	MotorHomes with Ford E350 or E450 Chassis Ultra Truck Shock	8C2Z-18124-D 8C24-18045-DA ASH-1154 AT-163G			G63622									
		8C24-18080-DB ASH-1136 8C2Z-18125-D AT-164G									G63623			



CLASS A MOTORHOMES

	MotorHomes with Freightliner XC Chassis 83000 Series	66153-002 F4-BE5-C832-MO			83124									
	MotorHomes with Freightliner XC Chassis 89000 Series	66153-002 F4-BE5-C832-MO			89407									

CONCORD

23-24	MotorHomes with Ford E350 or E450 Chassis	8C2Z-18124-D 8C24-18045-DA ASH-1154 AT-163G			G63622	58622 77614									
		8C24-18080-DB ASH-1136 8C2Z-18125-D AT-164G									G63623	58623 77623			
20-22	MotorHomes with Ford E350 or E450 Chassis LTV Severe Duty	8C2Z-18124-D 8C24-18045-DA ASH-1154 AT-163G			58622										
		8C24-18080-DB ASH-1136 8C2Z-18125-D AT-164G									58623				
	MotorHomes with Ford E350 or E450 Chassis Max Control	8C2Z-18124-D 8C24-18045-DA ASH-1154 AT-163G			77614										
		8C24-18080-DB ASH-1136 8C2Z-18125-D AT-164G									77623				
MotorHomes with Ford E350 or E450 Chassis Ultra Truck Shock	8C2Z-18124-D 8C24-18045-DA ASH-1154 AT-163G			G63622											
	8C24-18080-DB ASH-1136 8C2Z-18125-D AT-164G														

APPLICATION GUIDE

Year	Fitment Notes	OEM#								
			Fleetline\ Gas SLX	Classic\ Ultra\ ProGuard\ Guardian	Max Control\ LTV Severe Duty\ Load Carrier	Steering Dampers\ Steering Stabilizer\ Cab Shock	Fleetline\ Gas SLX	Classic\ Ultra\ ProGuard\ Guardian	Max Control\ LTV Severe Duty\ Load Carrier\ HiJackers	Steering Dampers\ Steering Stabilizer\ Cab Shock

COACHMEN

COACHMEN

CONCORD (cont)

20-22	MotorHomes with Ford E350 or E450 Chassis Ultra Truck Shock	8C24-18080-DB ASH-1136 8C2Z-18125-D AT-164G		G63623
07-19	MotorHomes with Ford E350 or E450 Chassis	8C2Z-18124-D 8C24-18045-DA ASH-1154 AT-163G		G63622	58622 77614
		8C24-18080-DB ASH-1136 8C2Z-18125-D AT-164G		G63623	58623 77623
04-06	MotorHomes with Ford E350 or E450 Chassis LTV Severe Duty	8C2Z-18124-D 8C24-18045-DA ASH-1154 AT-163G		58622
		8C24-18080-DB ASH-1136 8C2Z-18125-D AT-164G		58623
	MotorHomes with Ford E350 or E450 Chassis Max Control	8C2Z-18124-D 8C24-18045-DA ASH-1154 AT-163G		77614
		8C24-18080-DB ASH-1136 8C2Z-18125-D AT-164G		77623
MotorHomes with Ford E350 or E450 Chassis Ultra Truck Shock	8C2Z-18124-D 8C24-18045-DA ASH-1154 AT-163G	8C24-18080-DB ASH-1136 8C2Z-18125-D AT-164G		G63622
				G63623

CROSS COUNTRY

06	MotorHomes with Freightliner XC Chassis ADL200 Suspension w/ 20K Rear 85000 Series	16-16873-000			85029
	MotorHomes with Freightliner XC Chassis AS120 Front Suspension 83000 Series	16-16874-000 16-16737-000 141700131810		83160
	MotorHomes with Freightliner XC Chassis Rear Shock with O.E.M. Number 85000 Series	141700131809 16-16736-000			85029
	MotorHomes with Freightliner XC Chassis ZF - IFS Front Suspension with 23,000 lb GVW or Greater 85000 Series	16-18103-000 481700000493		85900



CROSS COUNTRY ELITE

03-05	MotorHomes with Freightliner XC Chassis ADL200 Suspension w/ 20K Rear 85000 Series	16-16873-000			85029
	MotorHomes with Freightliner XC Chassis AS120 Front Suspension 83000 Series	16-16874-000 16-16737-000 141700131810		83160
	MotorHomes with Freightliner XC Chassis Rear Shock with O.E.M. Number 85000 Series	141700131809 16-16736-000			85029
	MotorHomes with Freightliner XC Chassis ZF - IFS Front Suspension with 23,000 lb GVW or Greater 85000 Series	16-18103-000 481700000493		85900

CROSS COUNTRY SE

03-05	MotorHomes with Freightliner XC Chassis ADL200 Suspension w/ 20K Rear 85000 Series	16-16873-000			85029
	MotorHomes with Freightliner XC Chassis AS120 Front Suspension 83000 Series	16-16874-000 16-16737-000 141700131810		83160

APPLICATION GUIDE

Year	Fitment Notes	OEM#								
			Fleetline/ Gas SLX	Classic/ Ultra/ ProGuard/ Guardian	Max Control/ LTV Severe Duty/ Load Carrier	Steering Dampers/ Steering Stabilizer/ Cab Shock	Fleetline/ Gas SLX	Classic/ Ultra/ ProGuard/ Guardian	Max Control/ LTV Severe Duty/ Load Carrier/ HiJackers	Steering Dampers/ Steering Stabilizer/ Cab Shock

COACHMEN

COACHMEN

CROSS COUNTRY SE (cont)

03-05	MotorHomes with Freightliner XC Chassis Rear Shock with O.E.M. Number 85000 Series	141700131809 16-16736-000			85029
	MotorHomes with Freightliner XC Chassis ZF - IFS Front Suspension with 23,000 lb GVW or Greater 85000 Series	16-18103-000 481700000493		85900

CROSS TRAIL TRANSIT

21-22	MotorHomes with Ford Transit-350 Chassis			G57816 [®]	G64177
-------	--	--	--	------	---------------------	------	------	--	------	--------	------	------

ENCORE

21-24	MotorHomes with Ford F53 Chassis with 16,000 lb GVW to 22,000 lb GVW	ASH-1229 ASH-1228 9U94-18045-AA ASH-1205 AT-620 ASH-1022 1C34-18045-AA ASH-294 9U9Z-18124-A ASH-25822 ASH-25823 1C34-18045-JA AT-766		83209
	ASH-1206 9U94-18080-AA AT-621 ASH-25824 9U9Z-18125-A ASH-1023 ASH-1230 ASH-137		83122 89406

ENCOUNTER

11-16	MotorHomes with Ford F53 Chassis with 16,000 lb GVW to 22,000 lb GVW	ASH-1229 ASH-1228 9U94-18045-AA ASH-1205 AT-620 ASH-1022 1C34-18045-AA ASH-294 9U9Z-18124-A ASH-25822 ASH-25823 1C34-18045-JA AT-766		83209
	ASH-1206 9U94-18080-AA AT-621 ASH-25824 9U9Z-18125-A ASH-1023 ASH-1230 ASH-137		83122 89406

FREEDOM EXPRESS

09	MotorHomes with Ford E350 or E450 Chassis	8C2Z-18124-D 8C24-18045-DA ASH-1154 AT-163G		G63622	58622 77614
	8C24-18080-DB ASH-1136 8C2Z-18125-D AT-164G		G63623	58623 77623
04-08	MotorHomes with Ford E350 or E450 Chassis LTV Severe Duty	8C2Z-18124-D 8C24-18045-DA ASH-1154 AT-163G		58622
	8C24-18080-DB ASH-1136 8C2Z-18125-D AT-164G			58623

APPLICATION GUIDE

Year	Fitment Notes	OEM#								
			Fleetline\ Gas SLX	Classic\ Ultra\ ProGuard\ Guardian	Max Control\ LTV Severe Duty\ Load Carrier	Steering Dampers\ Steering Stabilizer\ Cab Shock	Fleetline\ Gas SLX	Classic\ Ultra\ ProGuard\ Guardian	Max Control\ LTV Severe Duty\ Load Carrier\ HiJackers	Steering Dampers\ Steering Stabilizer\ Cab Shock

COACHMEN

COACHMEN

FREEDOM EXPRESS (cont)

04-08	MotorHomes with Ford E350 or E450 Chassis Max Control	8C2Z-18124-D 8C24-18045-DA ASH-1154 AT-163G		o		o		o		o		o		o		o		o		o		o		
		8C24-18080-DB ASH-1136 8C2Z-18125-D AT-164G		o		o		o		o		o		o		o		o		o		o		o
	MotorHomes with Ford E350 or E450 Chassis Ultra Truck Shock	8C2Z-18124-D 8C24-18045-DA ASH-1154 AT-163G		o		o		o		o		o		o		o		o		o		o		o
		8C24-18080-DB ASH-1136 8C2Z-18125-D AT-164G		o		o		o		o		o		o		o		o		o		o		o



FREELANDER

08-24	MotorHomes with Ford E350 or E450 Chassis	8C2Z-18124-D 8C24-18045-DA ASH-1154 AT-163G		o		o		o		o		o		o		o		o		o		o		
		8C24-18080-DB ASH-1136 8C2Z-18125-D AT-164G		o		o		o		o		o		o		o		o		o		o		o
03-07	MotorHomes with Ford E350 or E450 Chassis LTV Severe Duty	8C2Z-18124-D 8C24-18045-DA ASH-1154 AT-163G		o		o		o		o		o		o		o		o		o		o		
		8C24-18080-DB ASH-1136 8C2Z-18125-D AT-164G		o		o		o		o		o		o		o		o		o		o		o
	MotorHomes with Ford E350 or E450 Chassis Max Control	8C2Z-18124-D 8C24-18045-DA ASH-1154 AT-163G		o		o		o		o		o		o		o		o		o		o		o
		8C24-18080-DB ASH-1136 8C2Z-18125-D AT-164G		o		o		o		o		o		o		o		o		o		o		o
	MotorHomes with Ford E350 or E450 Chassis Ultra Truck Shock	8C2Z-18124-D 8C24-18045-DA ASH-1154 AT-163G		o		o		o		o		o		o		o		o		o		o		o
		8C24-18080-DB ASH-1136 8C2Z-18125-D AT-164G		o		o		o		o		o		o		o		o		o		o		o

LEPRECHAUN

11-24	MotorHomes with Ford E350 or E450 Chassis	8C2Z-18124-D 8C24-18045-DA ASH-1154 AT-163G		o		o		o		o		o		o		o		o		o		o		
		8C24-18080-DB ASH-1136 8C2Z-18125-D AT-164G		o		o		o		o		o		o		o		o		o		o		o
10	MotorHomes with Ford E350 or E450 Chassis LTV Severe Duty	8C2Z-18124-D 8C24-18045-DA ASH-1154 AT-163G		o		o		o		o		o		o		o		o		o		o		
		8C24-18080-DB ASH-1136 8C2Z-18125-D AT-164G		o		o		o		o		o		o		o		o		o		o		o
	MotorHomes with Ford E350 or E450 Chassis Max Control	8C2Z-18124-D 8C24-18045-DA ASH-1154 AT-163G		o		o		o		o		o		o		o		o		o		o		o
		8C24-18080-DB ASH-1136 8C2Z-18125-D AT-164G		o		o		o		o		o		o		o		o		o		o		o

APPLICATION GUIDE

Year	Fitment Notes	OEM#								
			Fleetline/ Gas SLX	Classic/ Ultra/ ProGuard/ Guardian	Max Control/ LTV Severe Duty/ Load Carrier	Steering Dampers/ Steering Stabilizer/ Cab Shock	Fleetline/ Gas SLX	Classic/ Ultra/ ProGuard/ Guardian	Max Control/ LTV Severe Duty/ Load Carrier/ HiJackers	Steering Dampers/ Steering Stabilizer/ Cab Shock

COACHMEN

COACHMEN



LEPRECHAUN (cont)

10	MotorHomes with Ford E350 or E450 Chassis Ultra Truck Shock	8C2Z-18124-D 8C24-18045-DA ASH-1154 AT-163G	 O	G63622
		8C24-18080-DB ASH-1136 8C2Z-18125-D AT-164G	 O	 O	G63623
08-09	MotorHomes with Ford E350 or E450 Chassis	8C2Z-18124-D 8C24-18045-DA ASH-1154 AT-163G	 O	G63622	58622 77614
		8C24-18080-DB ASH-1136 8C2Z-18125-D AT-164G	 O	 O	G63623
03-07	MotorHomes with Ford E350 or E450 Chassis LTV Severe Duty	8C2Z-18124-D 8C24-18045-DA ASH-1154 AT-163G	 O	58622
		8C24-18080-DB ASH-1136 8C2Z-18125-D AT-164G	 O	 O
	MotorHomes with Ford E350 or E450 Chassis Max Control	8C2Z-18124-D 8C24-18045-DA ASH-1154 AT-163G	 O	77614
		8C24-18080-DB ASH-1136 8C2Z-18125-D AT-164G	 O	 O
	MotorHomes with Ford E350 or E450 Chassis Ultra Truck Shock	8C2Z-18124-D 8C24-18045-DA ASH-1154 AT-163G	 O	G63622
		8C24-18080-DB ASH-1136 8C2Z-18125-D AT-164G	 O	 O	G63623

MIRADA

08-24	MotorHomes with Ford F53 Chassis with 16,000 lb GVW to 22,000 lb GVW	ASH-1229 ASH-1228 9U94-18045-AA ASH-1205 AT-620 ASH-1022 1C34-18045-AA ASH-294 9U9Z-18124-A ASH-25822 ASH-25823 1C34-18045-JA AT-766	 OO	83209
		ASH-1206 9U94-18080-AA AT-621 ASH-25824 9U9Z-18125-A ASH-1023 ASH-1230 ASH-137	 OO	 OO	83122 89406
99-07	MotorHomes with Ford F53 Chassis with 16,000 lb GVW to 22,000 lb GVW 83000 Series	ASH-1229 ASH-1228 9U94-18045-AA ASH-1205 AT-620 ASH-1022 1C34-18045-AA ASH-294 9U9Z-18124-A ASH-25822 ASH-25823 1C34-18045-JA AT-766	 OO	83209

APPLICATION GUIDE

Year	Fitment Notes	OEM#								
			Fleetline\ Gas SLX	Classic\ Ultra\ ProGuard\ Guardian	Max Control\ LTV Severe Duty\ Load Carrier	Steering Dampers\ Steering Stabilizer\ Cab Shock	Fleetline\ Gas SLX	Classic\ Ultra\ ProGuard\ Guardian	Max Control\ LTV Severe Duty\ Load Carrier\ HiJackers	Steering Dampers\ Steering Stabilizer\ Cab Shock

COACHMEN

COACHMEN

MIRADA (cont)

99-07	MotorHomes with Ford F53 Chassis with 16,000 lb GVW to 22,000 lb GVW 83000 Series	ASH-1206 9U94-18080-AA AT-621 ASH-25824 9U9Z-18125-A ASH-1023 ASH-1230 ASH-137	OIO	83122
	MotorHomes with Ford F53 Chassis with 16,000 lb GVW to 22,000 lb GVW 89000 Series	ASH-1229 ASH-1228 9U94-18045-AA ASH-1205 AT-620 ASH-1022 1C34-18045-AA ASH-294 9U9Z-18124-A ASH-25822 ASH-25823 1C34-18045-JA AT-766	OIO	89414
	ASH-1206 9U94-18080-AA AT-621 ASH-25824 9U9Z-18125-A ASH-1023 ASH-1230 ASH-137	OIO	89406

NOVA

25	20C, Left	OIO	G57800 ⁴⁰
	20C, Right	OIO	G57801 ⁴⁰



PATHFINDER

98-03	MotorHomes with Ford E350 or E450 Chassis LTV Severe Duty	8C2Z-18124-D 8C24-18045-DA ASH-1154 AT-163G	OIO	58622
		8C24-18080-DB ASH-1136 8C2Z-18125-D AT-164G	OIO	58623
	MotorHomes with Ford E350 or E450 Chassis Max Control	8C2Z-18124-D 8C24-18045-DA ASH-1154 AT-163G	OIO	77614
		8C24-18080-DB ASH-1136 8C2Z-18125-D AT-164G	OIO	77623
	MotorHomes with Ford E350 or E450 Chassis Ultra Truck Shock	8C2Z-18124-D 8C24-18045-DA ASH-1154 AT-163G	OIO	G63622
		8C24-18080-DB ASH-1136 8C2Z-18125-D AT-164G	OIO	G63623

PURSUIT

13-24	MotorHomes with Ford F53 Chassis with 16,000 lb GVW to 22,000 lb GVW	ASH-1229 ASH-1228 9U94-18045-AA ASH-1205 AT-620 ASH-1022 1C34-18045-AA ASH-294 9U9Z-18124-A ASH-25822 ASH-25823 1C34-18045-JA AT-766	OIO	83209
-------	--	--	-----	-------	------	------	------	------	------

APPLICATION GUIDE

Year	Fitment Notes	OEM#								
			Fleetline/ Gas SLX	Classic/ Ultra/ ProGuard/ Guardian	Max Control/ LTV Severe Duty/ Load Carrier	Steering Dampers/ Steering Stabilizer/ Cab Shock	Fleetline/ Gas SLX	Classic/ Ultra/ ProGuard/ Guardian	Max Control/ LTV Severe Duty/ Load Carrier/ HiJackers	Steering Dampers/ Steering Stabilizer/ Cab Shock

COACHMEN

COACHMEN



PURSUIT (cont)

13-24	MotorHomes with Ford F53 Chassis with 16,000 lb GVW to 22,000 lb GVW	ASH-1206 9U94-18080-AA AT-621 ASH-25824 9U9Z-18125-A ASH-1023 ASH-1230 ASH-137	O/O	83122 89406	O/O
04-12	MotorHomes with Ford F53 Chassis with 16,000 lb GVW to 22,000 lb GVW 83000 Series	ASH-1229 ASH-1228 9U94-18045-AA ASH-1205 AT-620 ASH-1022 1C34-18045-AA ASH-294 9U9Z-18124-A ASH-25822 ASH-25823 1C34-18045-JA AT-766	O/O	83209
		ASH-1206 9U94-18080-AA AT-621 ASH-25824 9U9Z-18125-A ASH-1023 ASH-1230 ASH-137	O/O	83122
	MotorHomes with Ford F53 Chassis with 16,000 lb GVW to 22,000 lb GVW 89000 Series	ASH-1229 ASH-1228 9U94-18045-AA ASH-1205 AT-620 ASH-1022 1C34-18045-AA ASH-294 9U9Z-18124-A ASH-25822 ASH-25823 1C34-18045-JA AT-766	O/O	89414
		ASH-1206 9U94-18080-AA AT-621 ASH-25824 9U9Z-18125-A ASH-1023 ASH-1230 ASH-137	O/O	89406

SANTARA

99-06	MotorHomes with Ford E350 or E450 Chassis LTV Severe Duty	8C2Z-18124-D 8C24-18045-DA ASH-1154 AT-163G	O/O	58622	
		8C24-18080-DB ASH-1136 8C2Z-18125-D AT-164G	O/O	58623
	MotorHomes with Ford E350 or E450 Chassis Max Control	8C2Z-18124-D 8C24-18045-DA ASH-1154 AT-163G	O/O	77614
		8C24-18080-DB ASH-1136 8C2Z-18125-D AT-164G	O/O	77623
	MotorHomes with Ford E350 or E450 Chassis Ultra Truck Shock	8C2Z-18124-D 8C24-18045-DA ASH-1154 AT-163G	O/O	G63622
		8C24-18080-DB ASH-1136 8C2Z-18125-D AT-164G	O/O	G63623

APPLICATION GUIDE

Year	Fitment Notes	OEM#								
			Fleetline\ Gas SLX	Classic\ Ultra\ ProGuard\ Guardian	Max Control\ LTV Severe Duty\ Load Carrier	Steering Dampers\ Steering Stabilizer\ Cab Shock	Fleetline\ Gas SLX	Classic\ Ultra\ ProGuard\ Guardian	Max Control\ LTV Severe Duty\ Load Carrier\ HiJackers	Steering Dampers\ Steering Stabilizer\ Cab Shock

COLLINS BUS CORP.

COLLINS BUS CORP.

VARIOUS

Type A School Bus models with Ford E350 & E450 Chassis (Up to 2022) LTV Severe Duty	ASH-1154	 O	58622	 O
	ASH-1136	 O	 O	58623
Type A School Bus models with Ford E350 & E450 Chassis (Up to 2022) Max Control	ASH-1154	 O	77614	 O
	ASH-1136	 O	 O	77623
Type A School Bus models with Ford E350 & E450 Chassis (Up to 2022) Ultra Truck Shock	ASH-1154	 O	G63622	 O
	ASH-1136	 O	 O	G63623

COUNTRY COACH

COUNTRY COACH

AFFINITY

00-10	MotorHomes with Gillig Chassis w/ Neway I-beam front	 O	85723	 O
	MotorHomes with Neway IFS	 O	85029	 O	83124 89407
	MotorHomes with Ridewell Front Suspension	 O	85712	 O
	MotorHomes with Ridewell Rear Suspension	 O	 O	85734

DAMON

DAMON



CLASS A MOTORHOMES

04-11	Models with Workhorse W20 , W22, & W24 MotorHome Chassis with O.E.M. Number 85000 Series	 O	 O	85124
98-11	Models with Workhorse W20 , W22, & W24 MotorHome Chassis with O.E.M. Number 98 - 11 85000 Series	 O	85125	 O

DAYBREAK

12-13	MotorHomes with Ford F53 Chassis with 16,000 lb GVW to 22,000 lb GVW 83000 Series	 O	83209	 O
		 O	 O	83122
	MotorHomes with Ford F53 Chassis with 16,000 lb GVW to 22,000 lb GVW 89000 Series	 O	89414	 O

APPLICATION GUIDE

Year	Fitment Notes	OEM#								
			Fleetline\ Gas SLX	Classic\ Ultra\ ProGuard\ Guardian	Max Control\ LTV Severe Duty\ Load Carrier	Steering Dampers\ Steering Stabilizer\ Cab Shock	Fleetline\ Gas SLX	Classic\ Ultra\ ProGuard\ Guardian	Max Control\ LTV Severe Duty\ Load Carrier\ HiJackers	Steering Dampers\ Steering Stabilizer\ Cab Shock

DAMON

DAMON



DAYBREAK (cont)

12-13	MotorHomes with Ford F53 Chassis with 16,000 lb GVW to 22,000 lb GVW 89000 Series	ASH-1206 9U94-18080-AA AT-621 ASH-25824 9U9Z-18125-A ASH-1023 ASH-1230 ASH-137	OIO	89406
99	MotorHomes with Ford F53 Chassis with 16,000 lb GVW to 22,000 lb GVW 83000 Series	ASH-1229 ASH-1228 9U94-18045-AA ASH-1205 AT-620 ASH-1022 1C34-18045-AA ASH-294 9U9Z-18124-A ASH-25822 ASH-25823 1C34-18045-JA AT-766	OIO	83209
		ASH-1206 9U94-18080-AA AT-621 ASH-25824 9U9Z-18125-A ASH-1023 ASH-1230 ASH-137	OIO	83122
99	MotorHomes with Ford F53 Chassis with 16,000 lb GVW to 22,000 lb GVW 89000 Series	ASH-1229 ASH-1228 9U94-18045-AA ASH-1205 AT-620 ASH-1022 1C34-18045-AA ASH-294 9U9Z-18124-A ASH-25822 ASH-25823 1C34-18045-JA AT-766	OIO	89414
		ASH-1206 9U94-18080-AA AT-621 ASH-25824 9U9Z-18125-A ASH-1023 ASH-1230 ASH-137	OIO	89406

INTRUDER

99	MotorHomes with Ford F53 Chassis with 16,000 lb GVW to 22,000 lb GVW 83000 Series	ASH-1229 ASH-1228 9U94-18045-AA ASH-1205 AT-620 ASH-1022 1C34-18045-AA ASH-294 9U9Z-18124-A ASH-25822 ASH-25823 1C34-18045-JA AT-766	OIO	83209
		ASH-1206 9U94-18080-AA AT-621 ASH-25824 9U9Z-18125-A ASH-1023 ASH-1230 ASH-137	OIO	83122

APPLICATION GUIDE

Year	Fitment Notes	OEM#								
			Fleetline\ Gas SLX	Classic\ Ultra\ ProGuard\ Guardian	Max Control\ LTV Severe Duty\ Load Carrier	Steering Dampers\ Steering Stabilizer\ Cab Shock	Fleetline\ Gas SLX	Classic\ Ultra\ ProGuard\ Guardian	Max Control\ LTV Severe Duty\ Load Carrier\ HiJackers	Steering Dampers\ Steering Stabilizer\ Cab Shock

DAMON

DAMON

INTRUDER (cont)

99	MotorHomes with Ford F53 Chassis with 16,000 lb GVW to 22,000 lb GVW 89000 Series	ASH-1229 ASH-1228 9U94-18045-AA ASH-1205 AT-620 ASH-1022 1C34-18045-AA ASH-294 9U9Z-18124-A ASH-25822 ASH-25823 1C34-18045-JA AT-766	oio	89414
		ASH-1206 9U94-18080-AA AT-621 ASH-25824 9U9Z-18125-A ASH-1023 ASH-1230 ASH-137	oio	89406

OUTLAW

12-14	MotorHomes with Ford F53 Chassis with 16,000 lb GVW to 22,000 lb GVW 83000 Series	ASH-1229 ASH-1228 9U94-18045-AA ASH-1205 AT-620 ASH-1022 1C34-18045-AA ASH-294 9U9Z-18124-A ASH-25822 ASH-25823 1C34-18045-JA AT-766	oio	83209	
		ASH-1206 9U94-18080-AA AT-621 ASH-25824 9U9Z-18125-A ASH-1023 ASH-1230 ASH-137	oio	83122
		ASH-1229 ASH-1228 9U94-18045-AA ASH-1205 AT-620 ASH-1022 1C34-18045-AA ASH-294 9U9Z-18124-A ASH-25822 ASH-25823 1C34-18045-JA AT-766	oio	89414
	MotorHomes with Ford F53 or E450 Chassis Max Control	ASH-1206 9U94-18080-AA AT-621 ASH-25824 9U9Z-18125-A ASH-1023 ASH-1230 ASH-137	oio	89406	



DIAMOND COACH

DIAMOND COACH

SHUTTLE BUSES

	All Shuttle buses with Ford E350 or E450 Chassis LTV Severe Duty	8C2Z-18124-D 8C24-18045-DA ASH-1154 AT-163G	oio	58622
		8C24-18080-DB ASH-1136 8C2Z-18125-D AT-164G	oio	58623
	All Shuttle buses with Ford E350 or E450 Chassis Max Control	8C2Z-18124-D 8C24-18045-DA ASH-1154 AT-163G	oio	77614

APPLICATION GUIDE

Year	Fitment Notes	OEM#								
			Fleetline/ Gas SLX	Classic/ Ultra/ ProGuard/ Guardian	Max Control/ LTV Severe Duty/ Load Carrier	Steering Dampers/ Steering Stabilizer/ Cab Shock	Fleetline/ Gas SLX	Classic/ Ultra/ ProGuard/ Guardian	Max Control/ LTV Severe Duty/ Load Carrier/ HiJackers	Steering Dampers/ Steering Stabilizer/ Cab Shock

DIAMOND COACH

DIAMOND COACH

SHUTTLE BUSES (cont)

	All Shuttle buses with Ford E350 or E450 Chassis Max Control	8C24-18080-DB ASH-1136 8C2Z-18125-D AT-164G		77623
	All Shuttle buses with Ford E350 or E450 Chassis Ultra Truck Shock	8C2Z-18124-D 8C24-18045-DA ASH-1154 AT-163G		G63622
		8C24-18080-DB ASH-1136 8C2Z-18125-D AT-164G		G63623

DODGE

DODGE

D50

79-82	RWD			61556 G63950	61500 81147 G63907	43048 ⁸ 49310 ⁷ 77907
	Single System Steering Stabilizer			6802SE ⁸⁴								
82	4WD			61529 G63418	G63419

RAIDER

87-89	All			61529 G63418	81318	49311 ⁷
	Exc. Sport Utility			G63492
	2.6L 4Cyl			61506
	Single System Steering Stabilizer			6802SE ⁸⁴								
89	Sport Utility			G63604

DODGE TRUCK

DODGE TRUCK

D SERIES- CONVENTIONAL CAB 4 X 2

74-78	D-500, D-600, D-700, D-800 Ultra Truck Shock	3633643		G63183
73	D-500, D-600, D-800 Ultra Truck Shock	2516009		G63183

P SERIES - FORWARD CONTROL

72-82	P-300 Ultra Truck Shock	G63183
63-78	P-400 Ultra Truck Shock	G63183
63-71	PC-500 and PC-600, PD-500 and PD-600 Ultra Truck Shock	G63183

W-SERIES AND POWER WAGONS

74-78	W-600 Models Ultra Truck Shock	3633643		G63183
73	W-600 Models Ultra Truck Shock	2960707		G63183
		2516009		G63183
61-72	W-500, WT-500 Models Ultra Truck Shock	G63183

DUTCHMEN RV

DUTCHMEN RV

CLASS C MOTORHOMES



92-09	All Motorhomes with Ford E350 or E450 Chassis LTV Severe Duty	8C2Z-18124-D 8C24-18045-DA ASH-1154 AT-163G		58622
-------	---	--	--	------	------	-------	------	--	------	------	------	------

7 Pair Packs, Air hose kit included.;

8 Pair Packs.;

108 84 Replacement damper for vehicles with the Gabriel Aftermarket mounting kit;

APPLICATION GUIDE

Year	Fitment Notes	OEM#								
			Fleetline\ Gas SLX	Classic\ Ultra\ ProGuard\ Guardian	Max Control\ LTV Severe Duty\ Load Carrier	Steering Dampers\ Steering Stabilizer\ Cab Shock	Fleetline\ Gas SLX	Classic\ Ultra\ ProGuard\ Guardian	Max Control\ LTV Severe Duty\ Load Carrier\ HiJackers	Steering Dampers\ Steering Stabilizer\ Cab Shock

DUTCHMEN RV

DUTCHMEN RV

CLASS C MOTORHOMES (cont)

92-09	All Motorhomes with Ford E350 or E450 Chassis LTV Severe Duty	8C24-18080-DB ASH-1136 8C2Z-18125-D AT-164G	58623	...
	All Motorhomes with Ford E350 or E450 Chassis Max Control	8C2Z-18124-D 8C24-18045-DA ASH-1154 AT-163G	oi	77614
		8C24-18080-DB ASH-1136 8C2Z-18125-D AT-164G	oi	77623	...
	All Motorhomes with Ford E350 or E450 Chassis Ultra Truck Shock	8C2Z-18124-D 8C24-18045-DA ASH-1154 AT-163G	oi	...	G63622
8C24-18080-DB ASH-1136 8C2Z-18125-D AT-164G		oi	G63623	...	

JAMBOREE

15-20	Motorhomes with Ford E350 or E450 Chassis LTV Severe Duty	8C2Z-18124-D 8C24-18045-DA ASH-1154 AT-163G	oi	58622	
		8C24-18080-DB ASH-1136 8C2Z-18125-D AT-164G	oi	58623	...	
		Motorhomes with Ford E350 or E450 Chassis Max Control	8C2Z-18124-D 8C24-18045-DA ASH-1154 AT-163G	oi	77614
			8C24-18080-DB ASH-1136 8C2Z-18125-D AT-164G	oi	77623	...
	Motorhomes with Ford E350 or E450 Chassis Ultra Truck Shock	8C2Z-18124-D 8C24-18045-DA ASH-1154 AT-163G	oi	...	G63622	
		8C24-18080-DB ASH-1136 8C2Z-18125-D AT-164G	oi	G63623	...	

DYNAMAX CORP

DYNAMAX CORP

DX3

13-24	Models with 8000 to 16000 lb Front Axle and Taperleaf Spring	10-13760-000 471700002991 SDA471700002991	oi	85959
	Models with Airliner 21,000 lb Rear Air Suspension	16-15817-000 16-18708-000 481700006848 471700002809 SDA471700002809	oi	85724 89443	...





DYNAQUEST

05-07	Models with 10000 to 12000 lb. Taper-leaf Spring Suspension	10-12390-000	oi	85920
	Models with Airliner 18,000 lb Rear Air Suspension	16-15817-000 16-18708-000 481700006848 471700002809 SDA471700002809	oi	85724 89443	...

DYNAQUEST ST

09-14	Models with 8000 to 16000 lb Front Axle and Taperleaf Spring	10-13760-000 471700002991 SDA471700002991	oi	85959
-------	--	---	----	-------	-----	-----	-----	-----	-----

APPLICATION GUIDE

Year	Fitment Notes	OEM#								
			 Fleetline\ Gas SLX	Classic\ Ultra\ ProGuard\ Guardian	Max Control\ LTV\ Severe Duty\ Load Carrier	Steering Dampers\ Steering Stabilizer\ Cab Shock	 Fleetline\ Gas SLX	Classic\ Ultra\ ProGuard\ Guardian	Max Control\ LTV\ Severe Duty\ Load Carrier\ HiJackers	Steering Dampers\ Steering Stabilizer\ Cab Shock





DYNAMAX CORP

DYNAMAX CORP





DYNAQUEST ST (cont)

09-14	Models with Airliner 18,000 lb Rear Air Suspension	16-15817-000 16-18708-000 481700006848 471700002809 SDA471700002809		85958				 85724 89443			
-------	--	---	---	-------	--	--	--	--	--	--	--











DYNAQUEST XL

09-24	Models with 12000 lb to 20000 Front Axle	10-13809-000 471700003920		85958							
	Models with FAS II (40,000 lb) Rear Air Suspension	16-15817-000 16-18708-000 481700006848 471700002809 SDA471700002809						 85724 89443			





EUROPA

21-24	Models with 8000 to 16000 lb Front Axle and Taperleaf Spring	10-13760-000 471700002991 SDA471700002991		85959							
	Models with Airliner 21,000 lb Rear Air Suspension	16-15817-000 16-18708-000 481700006848 471700002809 SDA471700002809						 85724 89443			





FORCE HD

22	Models with 8000 to 16000 lb Front Axle and Taperleaf Spring	10-13760-000 471700002991 SDA471700002991		85959							
	Models with Airliner 21,000 lb Rear Air Suspension	16-15817-000 16-18708-000 481700006848 471700002809 SDA471700002809						 85724 89443			
19-21	Models with 8000 to 16000 lb Front Axle and Taperleaf Spring 85000 Series	10-13760-000 471700002991 SDA471700002991		85959							
15-18	Models with 8000 to 16000 lb Front Axle and Taperleaf Spring	10-13760-000 471700002991 SDA471700002991		85959							
	Models with Airliner 21,000 lb Rear Air Suspension	16-15817-000 16-18708-000 481700006848 471700002809 SDA471700002809						 85724 89443			





GRAND SPORT

02-04	Models 23,000 lb Airliner Rear Air Suspension	16-15817-000 471700002808 16-18708-000 481700006848 471700002809 SDA471700002809						 85724 89443			
	Models with 12000 lb Taperleaf Front Suspension	10-13634-000 471700000449 10-13063-000 10-13021-000 10-13684-000 10-13211-000 471700131155		85918							



GRAND SPORT GT

09-14	Models with 14,600 lb Taperleaf Front Suspension	SDA471700003920 10-13809-000		85958							
	Models with Freightliner Airliner Rear Air Suspension	16-15817-000 16-18708-000 481700006848 471700002809 SDA471700002809						 85724 89443			

GRAND SPORT GT TOY HAULER

09-13	390TH Models with 12000 lb Taperleaf Front Suspension	10-13760-000 471700002991 SDA471700002991		85959							
	410TH & 450TH Models with 12000 lb Taperleaf Front Suspension	SDA471700003920 10-13809-000		85958							

APPLICATION GUIDE

Year	Fitment Notes	OEM#								
			Fleetline\ Gas SLX	Classic\ Ultra\ ProGuard\ Guardian	Max Control\ LTV Severe Duty\ Load Carrier	Steering Dampers\ Steering Stabilizer\ Cab Shock	Fleetline\ Gas SLX	Classic\ Ultra\ ProGuard\ Guardian	Max Control\ LTV Severe Duty\ Load Carrier\ HiJackers	Steering Dampers\ Steering Stabilizer\ Cab Shock

DYNAMAX CORP

DYNAMAX CORP

GRAND SPORT GT TOY HAULER (cont)

07-13	Models 21K or 23K Airliner Rear Air Suspension	16-15817-000 471700002808 16-18708-000 481700006848 471700002809 SDA471700002809	oio	85920	oio	85724 89443
07-08	390TH Models with 12000 lb Taperleaf Front Suspension	10-12390-000	oio	85920	oio
	410TH & 450TH Models with 12000 lb Taperleaf Front Suspension	10-13634-000 471700000449 10-13063-000 10-13021-000 10-13684-000 10-13211-000 471700131155	oio	85918	oio

GRAND SPORT M2

03-07	Models with 10000 to 12000 lb. Taper-leaf Spring Suspension	10-12390-000	oio	85920	oio
	Models with Airliner 21,000 lb Rear Air Suspension	16-15817-000 16-18708-000 481700006848 471700002809 SDA471700002809	oio	oio	85724 89443



GRAND SPORT ULTRA

09-14	Models with 14,000 lb Taperleaf Front Suspension	SDA471700003920 10-13809-000	oio	85958	oio
07-14	Models 23,000 lb Airliner Rear Air Suspension	16-15817-000 471700002808 16-18708-000 481700006848 471700002809 SDA471700002809	oio	oio	85724 89443
		10-13634-000 471700000449 10-13063-000 10-13021-000 10-13684-000 10-13211-000 471700131155	oio	85918	oio

ISATA 4

18-20	MotorHomes with Ford E350 or E450 Chassis	8C2Z-18124-D 8C24-18045-DA ASH-1154 AT-163G	oio	G63622	58622 77614	oio	
		8C24-18080-DB ASH-1136 8C2Z-18125-D AT-164G	oio	oio	G63623	58623 77623
92-17	MotorHomes with Ford E350 or E450 Chassis LTV Severe Duty	8C2Z-18124-D 8C24-18045-DA ASH-1154 AT-163G	oio	58622	oio	
		8C24-18080-DB ASH-1136 8C2Z-18125-D AT-164G	oio	oio	58623	
	MotorHomes with Ford E350 or E450 Chassis Max Control	8C2Z-18124-D 8C24-18045-DA ASH-1154 AT-163G	oio	77614	oio
		8C24-18080-DB ASH-1136 8C2Z-18125-D AT-164G	oio	oio	77623	
MotorHomes with Ford E350 or E450 Chassis Ultra Truck Shock	8C2Z-18124-D 8C24-18045-DA ASH-1154 AT-163G	oio	G63622	oio	
	8C24-18080-DB ASH-1136 8C2Z-18125-D AT-164G	oio	oio	G63623	

APPLICATION GUIDE

Year	Fitment Notes	OEM#								
			Fleetline/ Gas SLX	Classic/ Ultra/ ProGuard/ Guardian	Max Control/ LTV Severe Duty/ Load Carrier	Steering Dampers/ Steering Stabilizer/ Cab Shock	Fleetline/ Gas SLX	Classic/ Ultra/ ProGuard/ Guardian	Max Control/ LTV Severe Duty/ Load Carrier/ HiJackers	Steering Dampers/ Steering Stabilizer/ Cab Shock

ELDORADO NATIONAL ADVANTAGE

ELDORADO NATIONAL

Shuttle Buses with Ford E350 or E450 Chassis LTV Severe Duty	8C2Z-18124-D 8C24-18045-DA ASH-1154 AT-163G	 O	58622
	8C24-18080-DB ASH-1136 8C2Z-18125-D AT-164G	 O	58623
Shuttle Buses with Ford E350 or E450 Chassis Max Control	8C2Z-18124-D 8C24-18045-DA ASH-1154 AT-163G	 O	77614
	8C24-18080-DB ASH-1136 8C2Z-18125-D AT-164G	 O	77623
Shuttle Buses with Ford E350 or E450 Chassis Ultra Truck Shock	8C2Z-18124-D 8C24-18045-DA ASH-1154 AT-163G	 O	G63622
	8C24-18080-DB ASH-1136 8C2Z-18125-D AT-164G	 O	G63623



AEROLITE

Shuttle Buses with Ford E350 or E450 Chassis LTV Severe Duty	8C2Z-18124-D 8C24-18045-DA ASH-1154 AT-163G	 O	58622
	8C24-18080-DB ASH-1136 8C2Z-18125-D AT-164G	 O	58623
Shuttle Buses with Ford E350 or E450 Chassis Max Control	8C2Z-18124-D 8C24-18045-DA ASH-1154 AT-163G	 O	77614
	8C24-18080-DB ASH-1136 8C2Z-18125-D AT-164G	 O	77623
Shuttle Buses with Ford E350 or E450 Chassis Ultra Truck Shock	8C2Z-18124-D 8C24-18045-DA ASH-1154 AT-163G	 O	G63622
	8C24-18080-DB ASH-1136 8C2Z-18125-D AT-164G	 O	G63623

AEROTECH

Shuttle Buses with Ford E350 or E450 Chassis LTV Severe Duty	8C2Z-18124-D 8C24-18045-DA ASH-1154 AT-163G	 O	58622
	8C24-18080-DB ASH-1136 8C2Z-18125-D AT-164G	 O	58623
Shuttle Buses with Ford E350 or E450 Chassis Max Control	8C2Z-18124-D 8C24-18045-DA ASH-1154 AT-163G	 O	77614
	8C24-18080-DB ASH-1136 8C2Z-18125-D AT-164G	 O	77623
Shuttle Buses with Ford E350 or E450 Chassis Ultra Truck Shock	8C2Z-18124-D 8C24-18045-DA ASH-1154 AT-163G	 O	G63622
	8C24-18080-DB ASH-1136 8C2Z-18125-D AT-164G	 O	G63623

APPLICATION GUIDE

Year	Fitment Notes	OEM#								
			Fleetline\ Gas SLX	Classic\ Ultra\ ProGuard\ Guardian	Max Control\ LTV Severe Duty\ Load Carrier	Steering Dampers\ Steering Stabilizer\ Cab Shock	Fleetline\ Gas SLX	Classic\ Ultra\ ProGuard\ Guardian	Max Control\ LTV Severe Duty\ Load Carrier\ HiJackers	Steering Dampers\ Steering Stabilizer\ Cab Shock

EMERGENCY ONE VARIOUS

EMERGENCY ONE

	AERM Models with 10K Front Leaf Spring 85000 Series	90-2572	010	85329
	AERM Models with 21K Front Taper-Leaf Spring 85000 Series	90-2572	010	85329
	PAEM Models with 19K Front Taper-Leaf Spring 85000 Series	90-2572	010	85329
	PMPR Models with 19K Front Taper-Leaf Spring 85000 Series	90-2572	010	85329

ENTEGRA COACH ACCOLADE

ENTEGRA COACH

20-24	Models with Freightliner S2RV chassis	10-13976-000	010	85918
		16-16764-000	010	85724 89443

ACCOLADE XL

21-24	Models with Freightliner S2RV chassis	10-13976-000	010	85918
		16-16764-000	010	85724 89443



ESTEEM

18-24	MotorHomes with Ford E350 or E450 Chassis	8C2Z-18124-D 8C24-18045-DA ASH-1154 AT-163G	010	G63622	58622 77614	
		8C24-18080-DB ASH-1136 8C2Z-18125-D AT-164G	010	G63623	58623 77623
17	MotorHomes with Ford E350 or E450 Chassis LTV Severe Duty	8C2Z-18124-D 8C24-18045-DA ASH-1154 AT-163G	010	58622	
		8C24-18080-DB ASH-1136 8C2Z-18125-D AT-164G	010	58623	
	MotorHomes with Ford E350 or E450 Chassis Max Control	8C2Z-18124-D 8C24-18045-DA ASH-1154 AT-163G	010	77614
		8C24-18080-DB ASH-1136 8C2Z-18125-D AT-164G	010	77623
MotorHomes with Ford E350 or E450 Chassis Ultra Truck Shock	8C2Z-18124-D 8C24-18045-DA ASH-1154 AT-163G	010	G63622	
	8C24-18080-DB ASH-1136 8C2Z-18125-D AT-164G	010	G63623	

ODYSSEY

18-24	MotorHomes with Ford E350 or E450 Chassis	8C2Z-18124-D 8C24-18045-DA ASH-1154 AT-163G	010	G63622	58622 77614
		8C24-18080-DB ASH-1136 8C2Z-18125-D AT-164G	010	G63623	58623 77623
17	MotorHomes with Ford E350 or E450 Chassis LTV Severe Duty	8C2Z-18124-D 8C24-18045-DA ASH-1154 AT-163G	010	58622
		8C24-18080-DB ASH-1136 8C2Z-18125-D AT-164G	010	58623

APPLICATION GUIDE

Year	Fitment Notes	OEM#								
			Fleetline/ Gas SLX	Classic/ Ultra/ ProGuard/ Guardian	Max Control/ LTV Severe Duty/ Load Carrier	Steering Dampers/ Steering Stabilizer/ Cab Shock	Fleetline/ Gas SLX	Classic/ Ultra/ ProGuard/ Guardian	Max Control/ LTV Severe Duty/ Load Carrier/ HiJackers	Steering Dampers/ Steering Stabilizer/ Cab Shock

ENTEGRA COACH

ENTEGRA COACH

ODYSSEY (cont)

17	MotorHomes with Ford E350 or E450 Chassis Max Control	8C2Z-18124-D 8C24-18045-DA ASH-1154 AT-163G	 O	77614	
		8C24-18080-DB ASH-1136 8C2Z-18125-D AT-164G	 O	77623
	MotorHomes with Ford E350 or E450 Chassis Ultra Truck Shock	8C2Z-18124-D 8C24-18045-DA ASH-1154 AT-163G	 O	G63622
		8C24-18080-DB ASH-1136 8C2Z-18125-D AT-164G	 O	G63623

ODYSSEY SE

23-24	MotorHomes with Ford E450 Chassis	8C2Z-18124-D 8C24-18045-DA ASH-1154 AT-163G	 O	G63622	58622 77614
		8C24-18080-DB ASH-1136 8C2Z-18125-D AT-164G	 O	G63623	58623 77623

FEDERAL COACH

FEDERAL COACH

VARIOUS

	Spirit Series Shuttle buses with Ford E450 Chassis To 2020 LTV Severe Duty	ASH-1154	 O	58622	
		ASH-1136	 O	58623
	Spirit Series Shuttle buses with Ford E450 Chassis To 2020 Max Control	ASH-1154	 O	77614
		ASH-1136	 O	77623
	Spirit Series Shuttle buses with Ford E450 Chassis To 2020 Ultra Truck Shock	ASH-1154	 O	G63622	
		ASH-1136	 O	G63623	
09-19	Shuttle buses with Freightliner M2-106 Chassis 85000 Series	10-13760-000 471700002991 SDA471700002991	 O	85959	
02-19	Shuttle buses with Freightliner M2-106 Chassis 85000 Series	16-18708-000 471700002809	 O	85724	
		16-18708-000 471700002809	 O	89443	
02-08	Shuttle buses with Freightliner M2-106 Chassis 85000 Series	10-12388-000 10-12390-000	 O	85920	
		10-12388-000 10-12390-000	 O	89503	

FIAT

FIAT

124

68-76	Wagon		 O	82156
67	Wagon		 O	82156	49310 ⁷
66	Wagon		 O	49310 ⁷



1100

66-67	Exc. Wagon		 O	82155	43140 ⁸
	Wagon		 O	82156	49310 ⁷

1500

66-67	Exc. Wagon		 O	82155
-------	------------	--	-------	------	------	------	------	-------	------	------	------

APPLICATION GUIDE

Year	Fitment Notes	OEM#								
			Fleetline\ Gas SLX	Classic\ Ultra\ ProGuard\ Guardian	Max Control\ LTV Severe Duty\ Load Carrier	Steering Dampers\ Steering Stabilizer\ Cab Shock	Fleetline\ Gas SLX	Classic\ Ultra\ ProGuard\ Guardian	Max Control\ LTV Severe Duty\ Load Carrier\ HiJackers	Steering Dampers\ Steering Stabilizer\ Cab Shock

FIAT

FIAT

1500 (cont)

66-67	Wagon		oio	82156	49310 ⁷
64-65	Exc. Wagon		oio	82155	43140 ⁸
	Wagon		oio	82156

FLEETWOOD

FLEETWOOD

AXON

19-20	MotorHomes with Ford F53 Chassis with 16,000 lb GVW to 22,000 lb GVW 83000 Series	ASH-1229 ASH-1228 9U94-18045-AA ASH-1205 AT-620 ASH-1022 1C34-18045-AA ASH-294 9U9Z-18124-A ASH-25822 ASH-25823 1C34-18045-JA AT-766	oio	83209	oio	
		ASH-1206 9U94-18080-AA AT-621 ASH-25824 9U9Z-18125-A ASH-1023 ASH-1230 ASH-137	oio	oio	83122
	MotorHomes with Ford F53 Chassis with 16,000 lb GVW to 22,000 lb GVW 89000 Series	ASH-1229 ASH-1228 9U94-18045-AA ASH-1205 AT-620 ASH-1022 1C34-18045-AA ASH-294 9U9Z-18124-A ASH-25822 ASH-25823 1C34-18045-JA AT-766	oio	89414	oio
		ASH-1206 9U94-18080-AA AT-621 ASH-25824 9U9Z-18125-A ASH-1023 ASH-1230 ASH-137	oio	oio	89406



CLASS A MOTORHOMES

04-11	Models with Workhorse W20 , W22, & W24 MotorHome Chassis with O.E.M. Number 85000 Series	W0005663 F4-BE5-F325-HO 24-153256	oio	oio	85124
-------	--	---	-----	------	------	------	------	-----	-------	------	------

JAMBOREE

20	MotorHomes with Ford E350 or E450 Chassis LTV Severe Duty	8C2Z-18124-D 8C24-18045-DA ASH-1154 AT-163G	oio	58622	oio	
		8C24-18080-DB ASH-1136 8C2Z-18125-D AT-164G	oio	oio	58623	
	MotorHomes with Ford E350 or E450 Chassis Max Control	8C2Z-18124-D 8C24-18045-DA ASH-1154 AT-163G	oio	77614	oio
		8C24-18080-DB ASH-1136 8C2Z-18125-D AT-164G	oio	oio	77623

APPLICATION GUIDE

Year	Fitment Notes	OEM#								
			Fleetline/ Gas SLX	Classic/ Ultra/ ProGuard/ Guardian	Max Control/ LTV Severe Duty/ Load Carrier	Steering Dampers/ Steering Stabilizer/ Cab Shock	Fleetline/ Gas SLX	Classic/ Ultra/ ProGuard/ Guardian	Max Control/ LTV Severe Duty/ Load Carrier/ HiJackers	Steering Dampers/ Steering Stabilizer/ Cab Shock



FLEETWOOD

FLEETWOOD

JAMBOREE (cont)

20	MotorHomes with Ford E350 or E450 Chassis Ultra Truck Shock	8C2Z-18124-D 8C24-18045-DA ASH-1154 AT-163G	 ○	G63622	
		8C24-18080-DB ASH-1136 8C2Z-18125-D AT-164G	 ○	 ○	G63623
17-19	MotorHomes with Ford E350 or E450 Chassis	8C2Z-18124-D 8C24-18045-DA ASH-1154 AT-163G	 ○	G63622	58622 77614	
		8C24-18080-DB ASH-1136 8C2Z-18125-D AT-164G	 ○	 ○	G63623	58623 77623
14-16	MotorHomes with Ford E350 or E450 Chassis LTV Severe Duty	8C2Z-18124-D 8C24-18045-DA ASH-1154 AT-163G	 ○	58622	
		8C24-18080-DB ASH-1136 8C2Z-18125-D AT-164G	 ○	 ○	58623
	MotorHomes with Ford E350 or E450 Chassis Max Control	8C2Z-18124-D 8C24-18045-DA ASH-1154 AT-163G	 ○	77614
		8C24-18080-DB ASH-1136 8C2Z-18125-D AT-164G	 ○	 ○	77623
	MotorHomes with Ford E350 or E450 Chassis Ultra Truck Shock	8C2Z-18124-D 8C24-18045-DA ASH-1154 AT-163G	 ○	G63622
		8C24-18080-DB ASH-1136 8C2Z-18125-D AT-164G	 ○	 ○	G63623
08-13	MotorHomes with Ford E350 or E450 Chassis	8C2Z-18124-D 8C24-18045-DA ASH-1154 AT-163G	 ○	G63622	58622 77614	
		8C24-18080-DB ASH-1136 8C2Z-18125-D AT-164G	 ○	 ○	G63623	58623 77623
99-07	MotorHomes with Ford E350 or E450 Chassis LTV Severe Duty	8C2Z-18124-D 8C24-18045-DA ASH-1154 AT-163G	 ○	58622	
		8C24-18080-DB ASH-1136 8C2Z-18125-D AT-164G	 ○	 ○	58623
	MotorHomes with Ford E350 or E450 Chassis Max Control	8C2Z-18124-D 8C24-18045-DA ASH-1154 AT-163G	 ○	77614
		8C24-18080-DB ASH-1136 8C2Z-18125-D AT-164G	 ○	 ○	77623
	MotorHomes with Ford E350 or E450 Chassis Ultra Truck Shock	8C2Z-18124-D 8C24-18045-DA ASH-1154 AT-163G	 ○	G63622
		8C24-18080-DB ASH-1136 8C2Z-18125-D AT-164G	 ○	 ○	G63623

APPLICATION GUIDE

Year	Fitment Notes	OEM#								
			Fleetline\ Gas SLX	Classic\ Ultra\ ProGuard\ Guardian	Max Control\ LTV Severe Duty\ Load Carrier	Steering Dampers\ Steering Stabilizer\ Cab Shock	Fleetline\ Gas SLX	Classic\ Ultra\ ProGuard\ Guardian	Max Control\ LTV Severe Duty\ Load Carrier\ HiJackers	Steering Dampers\ Steering Stabilizer\ Cab Shock

FLEETWOOD SURGE



FLEETWOOD

19-20	MotorHomes with Ford E350 or E450 Chassis LTV Severe Duty	8C2Z-18124-D 8C24-18045-DA ASH-1154 AT-163G	OI	58622	OI
		8C24-18080-DB ASH-1136 8C2Z-18125-D AT-164G	OI	OI	58623
		8C2Z-18124-D 8C24-18045-DA ASH-1154 AT-163G	OI	77614	OI
	MotorHomes with Ford E350 or E450 Chassis Max Control	8C24-18080-DB ASH-1136 8C2Z-18125-D AT-164G	OI	OI	77623
		8C2Z-18124-D 8C24-18045-DA ASH-1154 AT-163G	OI	G63622	OI
		8C24-18080-DB ASH-1136 8C2Z-18125-D AT-164G	OI	OI	G63623
	MotorHomes with Ford E350 or E450 Chassis Ultra Truck Shock	8C2Z-18124-D 8C24-18045-DA ASH-1154 AT-163G	OI	G63622	OI
		8C24-18080-DB ASH-1136 8C2Z-18125-D AT-164G	OI	OI	G63623
		8C2Z-18124-D 8C24-18045-DA ASH-1154 AT-163G	OI	G63622	58622 77614	OI
18	MotorHomes with Ford E350 or E450 Chassis	8C24-18080-DB ASH-1136 8C2Z-18125-D AT-164G	OI	OI	G63623	58623 77623
		8C2Z-18124-D 8C24-18045-DA ASH-1154 AT-163G	OI	G63622	58622 77614	OI

TIOGA

14-16	MotorHomes with Ford E350 or E450 Chassis LTV Severe Duty	8C2Z-18124-D 8C24-18045-DA ASH-1154 AT-163G	OI	58622	OI
		8C24-18080-DB ASH-1136 8C2Z-18125-D AT-164G	OI	OI	58623
		8C2Z-18124-D 8C24-18045-DA ASH-1154 AT-163G	OI	77614	OI
	MotorHomes with Ford E350 or E450 Chassis Max Control	8C24-18080-DB ASH-1136 8C2Z-18125-D AT-164G	OI	OI	77623
		8C2Z-18124-D 8C24-18045-DA ASH-1154 AT-163G	OI	G63622	OI
		8C24-18080-DB ASH-1136 8C2Z-18125-D AT-164G	OI	OI	G63623
	MotorHomes with Ford E350 or E450 Chassis Ultra Truck Shock	8C2Z-18124-D 8C24-18045-DA ASH-1154 AT-163G	OI	G63622	OI
		8C24-18080-DB ASH-1136 8C2Z-18125-D AT-164G	OI	OI	G63623
		8C2Z-18124-D 8C24-18045-DA ASH-1154 AT-163G	OI	G63622	58622 77614	OI
08-13	MotorHomes with Ford E350 or E450 Chassis	8C24-18080-DB ASH-1136 8C2Z-18125-D AT-164G	OI	OI	G63623	58623 77623
		8C2Z-18124-D 8C24-18045-DA ASH-1154 AT-163G	OI	G63622	58622 77614	OI
99-07	MotorHomes with Ford E350 or E450 Chassis LTV Severe Duty	8C2Z-18124-D 8C24-18045-DA ASH-1154 AT-163G	OI	58622	OI
		8C24-18080-DB ASH-1136 8C2Z-18125-D AT-164G	OI	OI	58623

APPLICATION GUIDE

Year	Fitment Notes	OEM#								
			Fleetline/ Gas SLX	Classic/ Ultra/ ProGuard/ Guardian	Max Control/ LTV Severe Duty/ Load Carrier	Steering Dampers/ Steering Stabilizer/ Cab Shock	Fleetline/ Gas SLX	Classic/ Ultra/ ProGuard/ Guardian	Max Control/ LTV Severe Duty/ Load Carrier/ HiJackers	Steering Dampers/ Steering Stabilizer/ Cab Shock

FLEETWOOD

FLEETWOOD

TIOGA (cont)

99-07	MotorHomes with Ford E350 or E450 Chassis Max Control	8C2Z-18124-D 8C24-18045-DA ASH-1154 AT-163G	 O	77614	
		8C24-18080-DB ASH-1136 8C2Z-18125-D AT-164G	 O	77623
	MotorHomes with Ford E350 or E450 Chassis Ultra Truck Shock	8C2Z-18124-D 8C24-18045-DA ASH-1154 AT-163G	 O	G63622
		8C24-18080-DB ASH-1136 8C2Z-18125-D AT-164G	 O	G63623

FORD

FORD

C & CT SERIES - TILT CAB

64-67	C-550, C-600 with 6000 lb. Axle - Exc. with Power Steering Ultra Truck Shock	C6PF-18077-A	 O	G63306
-------	--	--------------	-------	------	--------	------	------	------	------	------

C600

80-86	Models with 3100 lb Spring and 7000 lb Axle	D7HT-18045-JA	 O	83308
	Models with 4040, 5040 lb Springs and 7000, 9000, 12000 lb Axles	D2EF-18045-AA	 O	83312

E-450 ECONOLINE SUPER DUTY

00-02	All		 O	G63622	58622 77614	61646 G63623	58623 77623
	Exc. Cutaway Chassis		 O	77623
	Steering Stabilizer		 O	6828SE ⁸⁰							

E-550 ECONOLINE SUPER DUTY

02	All		 O	61655
	Steering Stabilizer		 O	6828SE ⁸⁰							

E-550 SUPER DUTY

03	All		 O	61655
	Steering Stabilizer		 O	6828SE ⁸⁰							

F-53

08-23	F53 Chassis with 24,000 lb GVW to 26,000 lb GVW 85000 Series	ASH-25821 ASH-1161 HU9Z-18124-A	 O	85006
		ASH-25820 ASH-1162	 O	85005
	F53 Chassis with 24,000 lb GVW to 26,000 lb GVW 89000 Series	ASH-25820 ASH-1162	 O	89430
06-23	F-53 Chassis with 16,000 lb GVW to 18,000 lb GVW 83000 Series	ASH-1206 9U94-18080-AA 9U9Z-18125-B AT-621 ASH-25825 ASH-25824 9U9Z-18125-A ASH-1023 ASH-1230 ASH-137 HU9Z-18125-B	 O	83122

⁸⁰ Mounting bracket not required, install on O.E. Shock Mounts. See Ref. C for

APPLICATION GUIDE

Year	Fitment Notes	OEM#								
			Fleetline\ Gas SLX	Classic\ Ultra\ ProGuard\ Guardian	Max Control\ LTV Severe Duty\ Load Carrier	Steering Dampers\ Steering Stabilizer\ Cab Shock	Fleetline\ Gas SLX	Classic\ Ultra\ ProGuard\ Guardian	Max Control\ LTV Severe Duty\ Load Carrier\ HiJackers	Steering Dampers\ Steering Stabilizer\ Cab Shock



FORD

FORD

F-53 (cont)

06-23	F-53 Chassis with 16,000 lb GVW to 18,000 lb GVW 89000 Series	ASH-1206 9U94-18080-AA 9U9Z-18125-B AT-621 ASH-25825 ASH-25824 9U9Z-18125-A ASH-1023 ASH-1230 ASH-137 HU9Z-18125-B	oio	89406
	F53 Chassis with 16,000 lb GVW to 22,000 lb GVW 83000 Series	ASH-1229 HU94-18045-AA ASH-1228 9U94-18045-AA ASH-1205 AT-620 ASH-1022 HU9Z-18124-B HU9Z-18124-C HU94-18045-BA ASH-294 9U9Z-18124-A 9U9Z-18124-B ASH-25822 ASH-25823 1C34-18045-JA AT-766	oio	83209
	F53 Chassis with 16,000 lb GVW to 22,000 lb GVW 89000 Series	ASH-1229 HU94-18045-AA ASH-1228 9U94-18045-AA ASH-1205 AT-620 ASH-1022 HU9Z-18124-B HU9Z-18124-C HU94-18045-BA ASH-294 9U9Z-18124-A 9U9Z-18124-B ASH-25822 ASH-25823 1C34-18045-JA AT-766	oio	89414
11-20	F53 Stripped Chassis Commercial Stripped Chassis, 19,500 lb to 22,000 lb GVW 85000 Series	471700007203 ASH-24634 DU94-18045-CB	oio	85013
	F53 Stripped Chassis Commercial Stripped Chassis, 19,500 lb to 22,000 lb GVW 89000 Series	471700007203 ASH-24634 DU94-18045-CB	oio	89414
	F53 Stripped Chassis With BT Delivery Van Pack, 16,000 LB. GVW 85000 Series	471700009775 DU94-18080-CA 471700007117 DU94-18080-CB	oio	85010
99-04	F-53 Chassis with 16,000 lb GVW to 18,000 lb GVW 83000 Series	ASH-1206 9U94-18080-AA AT-621 ASH-25824 9U9Z-18125-A ASH-1023 ASH-1230 ASH-137 HU9Z-18125-B	oio	83122
	F-53 Chassis with 16,000 lb GVW to 18,000 lb GVW 89000 Series	ASH-1206 9U94-18080-AA AT-621 ASH-25824 9U9Z-18125-A ASH-1023 ASH-1230 ASH-137 HU9Z-18125-B	oio	89406

APPLICATION GUIDE

Year	Fitment Notes	OEM#								
			Fleetline/ Gas SLX	Classic/ Ultra/ ProGuard/ Guardian	Max Control/ LTV Severe Duty/ Load Carrier	Steering Dampers/ Steering Stabilizer/ Cab Shock	Fleetline/ Gas SLX	Classic/ Ultra/ ProGuard/ Guardian	Max Control/ LTV Severe Duty/ Load Carrier/ HiJackers	Steering Dampers/ Steering Stabilizer/ Cab Shock

FORD

FORD



F-53 (cont)

99-04	F53 Chassis with 16,000 lb GVW to 22,000 lb GVW 83000 Series	ASH-1229 HU94-18045-AA ASH-1228 9U94-18045-AA ASH-1205 AT-620 ASH-1022 HU9Z-18124-B HU9Z-18124-C HU94-18045-BA ASH-294 9U9Z-18124-A 9U9Z-18124-B ASH-25822 ASH-25823 1C34-18045-JA AT-766	OIO	83209
	F53 Chassis with 16,000 lb GVW to 22,000 lb GVW 89000 Series	ASH-1229 HU94-18045-AA ASH-1228 9U94-18045-AA ASH-1205 AT-620 ASH-1022 HU9Z-18124-B HU9Z-18124-C HU94-18045-BA ASH-294 9U9Z-18124-A 9U9Z-18124-B ASH-25822 ASH-25823 1C34-18045-JA AT-766	OIO	89414
88-97	F53 Chassis with 16,000 lb GVW to 22,000 lb GVW 83000 Series	ASH-1229 HU94-18045-AA ASH-1228 9U94-18045-AA ASH-1205 AT-620 ASH-1022 HU9Z-18124-B HU9Z-18124-C HU94-18045-BA ASH-294 9U9Z-18124-A 9U9Z-18124-B ASH-25822 ASH-25823 1C34-18045-JA AT-766	OIO	83209
	F53 Chassis with 16,000 lb GVW to 22,000 lb GVW 89000 Series	ASH-1229 HU94-18045-AA ASH-1228 9U94-18045-AA ASH-1205 AT-620 ASH-1022 HU9Z-18124-B HU9Z-18124-C HU94-18045-BA ASH-294 9U9Z-18124-A 9U9Z-18124-B ASH-25822 ASH-25823 1C34-18045-JA AT-766	OIO	89414

F-53 MOTORHOME CHASSIS

24	MotorHomes with Ford F53 Chassis with 24,000 lb GVW to 26,000 lb GVW 85000 Series	ASH-25821 ASH-1161 HU9Z-18124-A	OIO	85006
----	---	---------------------------------------	-----	-------	------	------	------	------	------	------	------

APPLICATION GUIDE

Year	Fitment Notes	OEM#								
			Fleetline\ Gas SLX	Classic\ Ultra\ ProGuard\ Guardian	Max Control\ LTV Severe Duty\ Load Carrier	Steering Dampers\ LTV Steering Stabilizer\ Cab Shock	Fleetline\ Gas SLX	Classic\ Ultra\ ProGuard\ Guardian	Max Control\ LTV Severe Duty\ Load Carrier\ HiJackers	Steering Dampers\ LTV Steering Stabilizer\ Cab Shock

FORD

FORD



F-53 MOTORHOME CHASSIS (cont)

05	MotorHomes with Ford F53 Chassis with 16,000 lb GVW to 22,000 lb GVW 83000 Series	ASH-1229 ASH-1228 9U94-18045-AA ASH-1205 AT-620 ASH-1022 1C34-18045-AA ASH-294 9U9Z-18124-A ASH-25822 ASH-25823 1C34-18045-JA AT-766	83209	oio
	MotorHomes with Ford F53 Chassis with 16,000 lb GVW to 22,000 lb GVW 89000 Series	ASH-1229 ASH-1228 9U94-18045-AA ASH-1205 AT-620 ASH-1022 1C34-18045-AA ASH-294 9U9Z-18124-A ASH-25822 ASH-25823 1C34-18045-JA AT-766	89414	oio
98	MotorHomes with Ford F53 Chassis with 16,000 lb GVW to 22,000 lb GVW 83000 Series	ASH-1229 ASH-1228 9U94-18045-AA ASH-1205 AT-620 ASH-1022 1C34-18045-AA ASH-294 9U9Z-18124-A ASH-25822 ASH-25823 1C34-18045-JA AT-766	83209	oio
	MotorHomes with Ford F53 Chassis with 16,000 lb GVW to 22,000 lb GVW 89000 Series	ASH-1229 ASH-1228 9U94-18045-AA ASH-1205 AT-620 ASH-1022 1C34-18045-AA ASH-294 9U9Z-18124-A ASH-25822 ASH-25823 1C34-18045-JA AT-766	89414	oio

F-59 COMMERCIAL STRIPPED CHASSIS

24	MotorHomes with Ford F59 Commercial Chassis with 24,000 lb GVW to 26,000 lb GVW 85000 Series	ASH-25821 ASH-1161 HU9Z-18124-A	85006	oio
11-23	MotorHomes with Ford F59 Commercial Chassis with 24,000 lb GVW to 26,000 lb GVW	ASH-25821 ASH-1161 HU9Z-18124-A	85006	oio
11-21	F59 Commercial Chassis with 16,000 lb or 19,500 GVW	471700009775 CU9Z-18125-A ASH-12261 ASH-24523 ASH-24589 DU94-18080-CA BU9Z-18125-A 471700007117 ASH-24474 DU94-18080-CB DU9Z-18125-A DU9Z-18125-B	85010	oio
	F59 Commercial Chassis with 16,000 lb to 22,000 GVW	ASH-12251 CU9Z-18124-A ASH-24473 BU9Z-18124-A ASH-24522 ASH-24634 DU9Z-18124-A DU9Z-18124-B	85013	oio

APPLICATION GUIDE

Year	Fitment Notes	OEM#								
			Fleetline\ Gas SLX	Classic\ Ultra\ ProGuard\ Guardian	Max Control\ LTV Severe Duty\ Load Carrier	Steering Dampers\ Steering Stabilizer\ Cab Shock	Fleetline\ Gas SLX	Classic\ Ultra\ ProGuard\ Guardian	Max Control\ LTV Severe Duty\ Load Carrier\ HiJackers	Steering Dampers\ Steering Stabilizer\ Cab Shock

FORD

FORD

F-SUPER DUTY (cont)

88-97	All		61554 81710 G63409	43167 ⁸	...
90-92	Steering Stabilizer		6802SE ⁸⁴		

LN600

80-85	Models with 11000, 13000, 15000, 17000 lb Axles	D7HT-18080-BA	83225
	Models with 3000, 3300 lb Springs and 5000, 5500, 6000, 7000 lb Axles	D7HT-18045-GA	83308
	Models with 4400 lb Spring and 7000, 9000 lb Axles	D2EF-18045-AA	83312

PICKUP P350

76	Up through 8000# GVW		...	61500 G63405
68-75	Up through 8000# GVW		...	61500 81147 G63405
68-73	Single System Steering Stabilizer		6802SE ⁸⁴		

PICKUP P400

75-76	Up through 8000# GVW		...	61500 81147 G63405
-------	----------------------	--	-----	--------------------------	-----	-----	-----	-----	-----	-----	-----	-----

PICKUP, F-450 SUPERDUTY

22-24	4 X 4	KC3Z-3E651-C	14072
24	All	PC3Z-18124-CGA, PC3Z-18124-HA, PC3Z-18124-ARA, PC3Z-18124-SGA	77967
	4 X 4, Models with 4WD and OEM number	ASH-85927 LC3Z-18125-W ASH-866127 ASH-866139 HC3Z-18125-EP HC3Z-18125-X PC3Z-18125-F ASH-85789	77986
	RWD, Models with RWD and OEM number	HC3Z-18125-ED HC3Z-18125-EE HC3Z-18125-B ASH-85857	77987
17-23	Models with 4WD and OEM number	ASH-85927 LC3Z-18125-W ASH-866127 ASH-866139 LC3Z-18125-J HC3Z-18125-EP HC3Z-18125-X ASH-85789	77986
	Models with RWD and OEM number	ASH-25770 HC3Z-18125-ED HC3Z-18125-EE HC3Z-18125-B ASH-85857 ASH-85856	77987
13-23	All		77967
17-21	4 X 4		14072
13-16	4 X 2		77968
	4 X 4		14072	77969
09-12	All		58944
08-12	4 X 4		14072

APPLICATION GUIDE

Year	Fitment Notes	OEM#								
			Fleetline/ Gas SLX	Classic/ Ultra/ ProGuard/ Guardian	Max Control/ LTV Severe Duty/ Load Carrier	Steering Dampers/ Steering Stabilizer/ Cab Shock	Fleetline/ Gas SLX	Classic/ Ultra/ ProGuard/ Guardian	Max Control/ LTV Severe Duty/ Load Carrier/ HiJackers	Steering Dampers/ Steering Stabilizer/ Cab Shock

FORD

FORD



PICKUP, F-450 SUPERDUTY (cont)

07-08	All			G63969	58944 77967
05-07	4 X 2			77968
	4 X 4			77969
99-07	Models with single or dual rear wheels with 165" or 201" wheel base	AT-611 F81A-18080-DCA AT-610 ASH-23488 ASH-247 F81Z-18125-DC ASH-23486		G63461
05-06	All			G63969	77967
99-04	All			61655 G63809	58809 77809	77461
	Steering Stabilizer			6854SE ⁸⁰								
97	All			G63692	61554 G63409	43167 ⁸

PICKUP, F-550 SUPERDUTY

24	All	PC3Z-18124-CGA, PC3Z-18124-HA, PC3Z-18124-ARA, PC3Z-18124-SGA		77967
	4 X 4			14072	
	4 X 4, Models with 4WD and OEM number	ASH-85927 LC3Z-18125-W ASH-866127 ASH-866139 HC3Z-18125-EP HC3Z-18125-X PC3Z-18125-F ASH-85789		77986
	RWD, Models with RWD and OEM number	ASH-25770 HC3Z-18125-ED HC3Z-18125-EE HC3Z-18125-B ASH-85857 ASH-85856		77987
17-23	Models with 4WD and OEM number	ASH-85927 LC3Z-18125-W ASH-866127 ASH-866139 LC3Z-18125-J HC3Z-18125-EP HC3Z-18125-X ASH-85789		77986
	Models with RWD and OEM number	ASH-25770 HC3Z-18125-ED HC3Z-18125-EE HC3Z-18125-B ASH-85857 ASH-85856		77987
13-23	All			77967
23	4 X 4	KC3Z-3E651-C		14072	
17-22	4 X 4			14072	
13-16	4 X 2			77968
	4 X 4			14072		77969
10-12	All			58944
08-12	4 X 4			14072	
05-07	All			G63969	77967
	4 X 2			77968

APPLICATION GUIDE

Year	Fitment Notes	OEM#								
			Fleetline\ Gas SLX	Classic\ Ultra\ ProGuard\ Guardian	Max Control\ LTV Severe Duty\ Load Carrier	Steering Dampers\ Steering Stabilizer\ Cab Shock	Fleetline\ Gas SLX	Classic\ Ultra\ ProGuard\ Guardian	Max Control\ LTV Severe Duty\ Load Carrier\ HiJackers	Steering Dampers\ Steering Stabilizer\ Cab Shock

FORD

FORD

PICKUP, F-550 SUPERDUTY (cont)

05-07	4 X 4			OO	77969
99-07	Models with single or dual rear wheels with 165" or 201" wheel base	AT-611 F81A-18080-DCA AT-610 ASH-23488 ASH-247 F81Z-18125-DC ASH-23486		OO	G63461
99-04	All		OO	61655 G63809	58809 77809	OO	77461
	Steering Stabilizer		OO	6854SE ⁹⁰								

VAN 1 TON, ECONOLINE / CLUB WAGON / SUPERDUTY

21-24	Steering Stabilizer		OO	6828SE ⁹⁰								
24	All	8C2Z18124D	OO	G63622	OO
		8C2Z18125D	OO	OO	G63623
			OO	81744 ⁴⁸	58622 77614	OO	61646 81828	49178 ⁷ 58623 77623
21-23	All		OO	81744 ⁴⁸ G63622	58622 77614	OO	61646 81828 G63623	49178 ⁷ 58623 77623
10-19	All		OO	81744 ⁴⁸ G63622	34076 ⁸ 58622 77614	OO	61646 81828 G63623	49178 ⁷ 58623
03-19	Exc. Cutaway Chassis		OO	OO	77623
	Steering Stabilizer		OO	6828SE ⁹⁰								
03-09	All		OO	G63622	58622 77614	OO	61646 G63623	58623

W AND WT SERIES - HI TILT CAB HIGHWAY TRACTOR

73-77	W-900, WT-900 with Air Suspension 83000 Series	D2HZ-18080-A D4HA-18080-AA		OO	83209
	W-900, WT-900 with Air Suspension 89000 Series	D2HZ-18080-A D4HA-18080-AA		OO	89414
66-77	W-900, W-950, W-1000, WT-900, WT-950, WT-1000 with 12000 & 15000 lb. Axle 85000 Series	C6TA-18045-Z C6TA-18045-Y	OO	85301	OO
66-71	W-900, W-950, W-1000, WT-900, WT-950, WT-1000 with 11000 lb. Axle 85000 Series	D2HA-18045-E1A D2HA-18045-E2B D2HA-18045-E1B D2HA-18045-E2A	OO	85304	OO

FOREST RIVER

FOREST RIVER



ALL AMERICAN

	MotorHomes with Ford E350 or E450 Chassis LTV Severe Duty	8C2Z-18124-D 8C24-18045-DA ASH-1154 AT-163G	OO	58622	OO
		8C24-18080-DB ASH-1136 8C2Z-18125-D AT-164G	OO	OO	58623
	MotorHomes with Ford E350 or E450 Chassis Max Control	8C2Z-18124-D 8C24-18045-DA ASH-1154 AT-163G	OO	77614	OO
		8C24-18080-DB ASH-1136 8C2Z-18125-D AT-164G	OO	OO	77623

7 Pair Packs, Air hose kit included.;
48 Installation Hardware Included;

8 Pair Packs.;
80 Mounting bracket not required, install on O.E. Shock Mounts. See Ref. C for optional Steering Stabilizer Boots.;

APPLICATION GUIDE

Year	Fitment Notes	OEM#								
			Fleetline/ Gas SLX	Classic/ Ultra/ ProGuard/ Guardian	Max Control/ LTV Severe Duty/ Load Carrier	Steering Dampers/ Steering Stabilizer/ Cab Shock	Fleetline/ Gas SLX	Classic/ Ultra/ ProGuard/ Guardian	Max Control/ LTV Severe Duty/ Load Carrier/ HiJackers	Steering Dampers/ Steering Stabilizer/ Cab Shock

FOREST RIVER

FOREST RIVER

ALL AMERICAN (cont)

	MotorHomes with Ford E350 or E450 Chassis Ultra Truck Shock	8C2Z-18124-D 8C24-18045-DA ASH-1154 AT-163G	↓ ○		G63622						
		8C24-18080-DB ASH-1136 8C2Z-18125-D AT-164G	↓ ○					G63623			

CLASS A MOTORHOMES

	MotorHomes with Workhorse UFO Chassis with Hendrickson Softek Front Suspension 83000 Series	66153-002 F4-BE5-C832-MO	↓ ○		83124						
		66153-002 F4-BE5-C832-MO	↓ ○								

FORESTER

20	MotorHomes with Ford E350 or E450 Chassis LTV Severe Duty	8C2Z-18124-D 8C24-18045-DA ASH-1154 AT-163G	↓ ○			58622					
		8C24-18080-DB ASH-1136 8C2Z-18125-D AT-164G	↓ ○					58623			
	MotorHomes with Ford E350 or E450 Chassis Max Control	8C2Z-18124-D 8C24-18045-DA ASH-1154 AT-163G	↓ ○			77614					
		8C24-18080-DB ASH-1136 8C2Z-18125-D AT-164G	↓ ○					77623			
04-19	MotorHomes with Ford E350 or E450 Chassis Ultra Truck Shock	8C2Z-18124-D 8C24-18045-DA ASH-1154 AT-163G	↓ ○		G63622						
		8C24-18080-DB ASH-1136 8C2Z-18125-D AT-164G	↓ ○					G63623			
	MotorHomes with Ford E350 or E450 Chassis	8C2Z-18124-D 8C24-18045-DA ASH-1154 AT-163G	↓ ○		G63622	58622 77614					
		8C24-18080-DB ASH-1136 8C2Z-18125-D AT-164G	↓ ○					G63623	58623 77623		



FORESTER GTS

15-18	MotorHomes with Ford E350 or E450 Chassis	8C2Z-18124-D 8C24-18045-DA ASH-1154 AT-163G	↓ ○		G63622	58622 77614					
		8C24-18080-DB ASH-1136 8C2Z-18125-D AT-164G	↓ ○					G63623	58623 77623		

FORESTER TS

17-22	MotorHomes with Ford Transit-350 Chassis		↓		G57816 [®]			G64177			
-------	--	--	---	--	---------------------	--	--	--------	--	--	--

APPLICATION GUIDE

Year	Fitment Notes	OEM#								
			Fleetline\ Gas SLX	Classic\ Ultra\ ProGuard\ Guardian	Max Control\ LTV Severe Duty\ Load Carrier	Steering Dampers\ Steering Stabilizer\ Cab Shock	Fleetline\ Gas SLX	Classic\ Ultra\ ProGuard\ Guardian	Max Control\ LTV Severe Duty\ Load Carrier\ HiJackers	Steering Dampers\ Steering Stabilizer\ Cab Shock

FOREST RIVER

FOREST RIVER

FR3

13-24	MotorHomes with Ford F53 Chassis with 16,000 lb GVW to 22,000 lb GVW	ASH-1229 ASH-1228 9U94-18045-AA ASH-1205 AT-620 ASH-1022 1C34-18045-AA ASH-294 9U9Z-18124-A ASH-25822 ASH-25823 1C34-18045-JA AT-766	oio	83209
		ASH-1206 9U94-18080-AA AT-621 ASH-25824 9U9Z-18125-A ASH-1023 ASH-1230 ASH-137	83122 89406

GEORGETOWN

08-17	MotorHomes with Ford F53 Chassis with 16,000 lb GVW to 22,000 lb GVW	ASH-1229 ASH-1228 9U94-18045-AA ASH-1205 AT-620 ASH-1022 1C34-18045-AA ASH-294 9U9Z-18124-A ASH-25822 ASH-25823 1C34-18045-JA AT-766	oio	83209
		ASH-1206 9U94-18080-AA AT-621 ASH-25824 9U9Z-18125-A ASH-1023 ASH-1230 ASH-137	83122 89406



GEORGETOWN GT3

16-24	MotorHomes with Ford F53 Chassis with 16,000 lb GVW to 22,000 lb GVW	ASH-1229 ASH-1228 9U94-18045-AA ASH-1205 AT-620 ASH-1022 1C34-18045-AA ASH-294 9U9Z-18124-A ASH-25822 ASH-25823 1C34-18045-JA AT-766	oio	83209
		ASH-1206 9U94-18080-AA AT-621 ASH-25824 9U9Z-18125-A ASH-1023 ASH-1230 ASH-137	83122 89406

GEORGETOWN GT5

17-24	MotorHomes with Ford F53 Chassis with 16,000 lb GVW to 22,000 lb GVW	ASH-1229 ASH-1228 9U94-18045-AA ASH-1205 AT-620 ASH-1022 1C34-18045-AA ASH-294 9U9Z-18124-A ASH-25822 ASH-25823 1C34-18045-JA AT-766	oio	83209
		ASH-1206 9U94-18080-AA AT-621 ASH-25824 9U9Z-18125-A ASH-1023 ASH-1230 ASH-137	83122 89406

APPLICATION GUIDE

Year	Fitment Notes	OEM#								
			Fleetline/ Gas SLX	Classic/ Ultra/ ProGuard/ Guardian	Max Control/ LTV Severe Duty/ Load Carrier	Steering Dampers/ Steering Stabilizer/ Cab Shock	Fleetline/ Gas SLX	Classic/ Ultra/ ProGuard/ Guardian	Max Control/ LTV Severe Duty/ Load Carrier/ HiJackers	Steering Dampers/ Steering Stabilizer/ Cab Shock

FOREST RIVER

FOREST RIVER

GEORGETOWN GT5 (cont)

17-24	MotorHomes with Ford F53 Chassis with 16,000 lb GVW to 22,000 lb GVW	ASH-1206 9U94-18080-AA AT-621 ASH-25824 9U9Z-18125-A ASH-1023 ASH-1230 ASH-137	83122 89406
-------	--	---	-------	-------	-------	-------	-------	----------------	-------	-------	-------

GEORGETOWN GT7

20-24	MotorHomes with Ford F53 Chassis with 16,000 lb GVW to 22,000 lb GVW	ASH-1229 ASH-1228 9U94-18045-AA ASH-1205 AT-620 ASH-1022 1C34-18045-AA ASH-294 9U9Z-18124-A ASH-25822 ASH-25823 1C34-18045-JA AT-766	83209
		ASH-1206 9U94-18080-AA AT-621 ASH-25824 9U9Z-18125-A ASH-1023 ASH-1230 ASH-137	83122 89406
	MotorHomes with Ford F53 Chassis with 24,000 lb GVW to 26,000 lb GVW	ASH-25821 ASH-1161	85006
		ASH-25820 ASH-1162	85005 89430

LEXINGTON

03-15	MotorHomes with Ford E350 or E450 Chassis	8C2Z-18124-D 8C24-18045-DA ASH-1154 AT-163G	G63622	58622 77614
		8C24-18080-DB ASH-1136 8C2Z-18125-D AT-164G	G63623	58623 77623

REFLECTION

02-04	MotorHomes with Freightliner XC Chassis & ADL200 Suspension w/ 20K Rear ADL200 Suspension w/ 20K Rear 85000 Series	16-16873-000	85029
		141700131809 16-16736-000	85029
		16-16874-000 16-16737-000 141700131810	83160
		16-18103-000 481700000493	85900

SOLERA

21-24	MotorHomes with Ford E350 or E450 Chassis	8C2Z-18124-D 8C24-18045-DA ASH-1154 AT-163G	G63622	58622 77614
		8C24-18080-DB ASH-1136 8C2Z-18125-D AT-164G	G63623	58623 77623
10-15	MotorHomes with Ford E350 or E450 Chassis	8C2Z-18124-D 8C24-18045-DA ASH-1154 AT-163G	G63622	58622 77614

APPLICATION GUIDE

Year	Fitment Notes	OEM#								
			Fleetline\ Gas SLX	Classic\ Ultra\ ProGuard\ Guardian	Max Control\ LTV Severe Duty\ Load Carrier	Steering Dampers\ Steering Stabilizer\ Cab Shock	Fleetline\ Gas SLX	Classic\ Ultra\ ProGuard\ Guardian	Max Control\ LTV Severe Duty\ Load Carrier\ HiJackers	Steering Dampers\ Steering Stabilizer\ Cab Shock

FOREST RIVER

SOLERA (cont)

10-15	MotorHomes with Ford E350 or E450 Chassis	8C24-18080-DB ASH-1136 8C2Z-18125-D AT-164G		G63623	58623 77623
-------	---	--	--	------	------	------	------	--	------	--------	----------------	------

FOREST RIVER



SUNSEEKER

23	MotorHomes with Ford E350 or E450 Chassis LTV Severe Duty	8C2Z-18124-D 8C24-18045-DA ASH-1154 AT-163G		58622
		8C24-18080-DB ASH-1136 8C2Z-18125-D AT-164G		58623
	MotorHomes with Ford E350 or E450 Chassis Max Control	8C2Z-18124-D 8C24-18045-DA ASH-1154 AT-163G		77614
		8C24-18080-DB ASH-1136 8C2Z-18125-D AT-164G		77623
	MotorHomes with Ford E350 or E450 Chassis Ultra Truck Shock	8C2Z-18124-D 8C24-18045-DA ASH-1154 AT-163G		G63622
		8C24-18080-DB ASH-1136 8C2Z-18125-D AT-164G		G63623
07-22	MotorHomes with Ford E350 or E450 Chassis	8C2Z-18124-D 8C24-18045-DA ASH-1154 AT-163G		G63622	58622 77614	
		8C24-18080-DB ASH-1136 8C2Z-18125-D AT-164G		G63623	58623 77623
99-06	MotorHomes with Ford E350 or E450 Chassis LTV Severe Duty	8C2Z-18124-D 8C24-18045-DA ASH-1154 AT-163G		58622
		8C24-18080-DB ASH-1136 8C2Z-18125-D AT-164G		58623
	MotorHomes with Ford E350 or E450 Chassis Max Control	8C2Z-18124-D 8C24-18045-DA ASH-1154 AT-163G		77614
		8C24-18080-DB ASH-1136 8C2Z-18125-D AT-164G		77623
	MotorHomes with Ford E350 or E450 Chassis Ultra Truck Shock	8C2Z-18124-D 8C24-18045-DA ASH-1154 AT-163G		G63622
		8C24-18080-DB ASH-1136 8C2Z-18125-D AT-164G		G63623

SUNSEEKER GTS

19-20	MotorHomes with Ford E350 or E450 Chassis LTV Severe Duty	8C2Z-18124-D 8C24-18045-DA ASH-1154 AT-163G		58622
		8C24-18080-DB ASH-1136 8C2Z-18125-D AT-164G		58623
	MotorHomes with Ford E350 or E450 Chassis Max Control	8C2Z-18124-D 8C24-18045-DA ASH-1154 AT-163G		77614

APPLICATION GUIDE

Year	Fitment Notes	OEM#								
			Fleetline/ Gas SLX	Classic/ Ultra/ ProGuard/ Guardian	Max Control/ LTV Severe Duty/ Load Carrier	Steering Dampers/ Steering Stabilizer/ Cab Shock	Fleetline/ Gas SLX	Classic/ Ultra/ ProGuard/ Guardian	Max Control/ LTV Severe Duty/ Load Carrier/ HiJackers	Steering Dampers/ Steering Stabilizer/ Cab Shock

FOREST RIVER

FOREST RIVER

SUNSEEKER GTS (cont)

19-20	MotorHomes with Ford E350 or E450 Chassis Max Control	8C24-18080-DB ASH-1136 8C2Z-18125-D AT-164G		77623
	MotorHomes with Ford E350 or E450 Chassis Ultra Truck Shock	8C2Z-18124-D 8C24-18045-DA ASH-1154 AT-163G		G63622
15-18	MotorHomes with Ford E350 or E450 Chassis	8C2Z-18124-D 8C24-18045-DA ASH-1154 AT-163G		G63622	58622 77614
		8C24-18080-DB ASH-1136 8C2Z-18125-D AT-164G		G63623	58623 77623

SUNSEEKER TS

17-22	MotorHomes with Ford Transit-350 Chassis			G57816 [®]	G64177
-------	--	--	--	------	---------------------	------	------	--	------	--------	------	------

TSUNAMI

02-06	MotorHomes with Freightliner XC Chassis & ADL200 Suspension w/ 20K Rear ADL200 Suspension w/ 20K Rear 85000 Series	16-16873-000			85029
	MotorHomes with Freightliner XC Chassis & ADL200 Suspension w/ 20K Rear Rear Shock with O.E.M. Number 85000 Series	141700131809 16-16736-000			85029
	MotorHomes with Freightliner XC Chassis and AS120 Front Suspension 83000 Series	16-16874-000 16-16737-000 141700131810		83160
	MotorHomes with Freightliner XC ChassisZF & IFS Front Suspension with 23,000 lb GVW or Greater ZF - IFS Front Suspension with 23,000 lb GVW or Greater 85000 Series	16-18103-000 481700000493		85900

FREIGHTLINER

FREIGHTLINER



B2

05-23	Models with 12000 lb Taperleaf Front Suspension	10-13634-000 10-13211-000		85918
	Models with FAS II (40,000 lb) Rear Air Suspension	16-15817-000 16-13957-000 16-18708-000 481700006848 471700002809 SDA471700002809			85724 89443
05-22	Models with 15,000 lb Rear Suspension	6803260000			83120

BUS CHASSIS

	FB Shuttle bus chassis with O.E.M. Number 85000 Series	16-16765-000 471700131775		85006
	School Bus Chassis with 7,000 lb Suspension 85000 Series	471700005079 10-13859-000		85005
	School Bus Chassis with 7,000 lb Suspension 89000 Series	471700005079 10-13859-000		89430
	Shuttle Bus Chassis 85000 Series	16-16082-000		85043
97-08	F65 School bus chassis with 10,000 to 18,000 lb Suspension 85000 Series	6803230300 471700003009 10-13759-000 GBL665538		85006

APPLICATION GUIDE

Year	Fitment Notes	OEM#								
			Fleetline\ Gas SLX	Classic\ Ultra\ ProGuard\ Guardian	Max Control\ LTV Severe Duty\ Load Carrier	Steering Dampers\ Steering Stabilizer\ Cab Shock	Fleetline\ Gas SLX	Classic\ Ultra\ ProGuard\ Guardian	Max Control\ LTV Severe Duty\ Load Carrier\ HiJackers	Steering Dampers\ Steering Stabilizer\ Cab Shock

FREIGHTLINER

FREIGHTLINER

BUS CHASSIS (cont)

97-08	F65 School bus chassis with Taperleaf Spring 83000 Series	6803260000 GBL654725	OIO	83120
-------	---	-------------------------	-----	-------	------	------	------	------	------	------	------

FC70

99-04	Models with 10,000 to 18,000 lb Suspension	6803230300 471700003009 10-13759-000 GBL665538	OIO	85006
	Models with 6000 to 9000 lb Front axle	6803230200	OIO	85043
	Models with FAS II (40,000 lb) Rear Air Suspension	16-15817-000 16-13957-000 16-18708-000			OIO	85724 89443

FL50

95-05	Day Cab Suspensions with O.E.M. Number	18-32999-001 18-60295-000 18-30378-000	OIO	83006	
	Models with 10,000 to 18,000 lb Suspension	6803230300 471700003009 10-13759-000 GBL665538	OIO	85006	
	Models with 15,000 lb Rear Suspension	6803260000 GBL654725			OIO	83120
	Models with 6000 to 9000 lb Front axle	6803230200	OIO	85043
	Models with FAS II (40,000 lb) Rear Air Suspension	16-15817-000 16-13957-000			OIO	85724 89443



FL60

96-05	Day Cab Suspensions with O.E.M. Number	18-32999-001 18-60295-000 18-30378-000	OIO	83006		
	91-05	Models with 10,000 to 18,000 lb Suspension	6803230300 471700003009 10-13759-000 GBL665538	OIO	85006	
		Models with 6000 to 9000 lb Front axle	6803230200	OIO	85043	
		Models with FAS II (40,000 lb) Rear Air Suspension	16-15817-000 16-13957-000			OIO	85724 89443
		Trucks with Link Cabmate Models FRT153BC-A, FRT106BC or FRT106HD-A	1201-0054 1202-0054	OIO	83021	
w/ 15000 lb Rear Suspension	6803260000 GBL654725			OIO	83120		

M2

	Models O.E.M. Number 85000 Series	10-13592-000 47170000440	OIO	85959	
05-21	Models with FAS II (40,000 lb) Rear Air Suspension	16-15817-000 16-18708-000 481700006848 471700002809 SDA471700002809		OIO	85724 89443
	Models with Freightliner TufTrac Rear Air Suspension	481700125969 16-15770-000		OIO	85956
	Models with Hendrickson HMX 400/460 Haulmax with 16.5" Saddle	60680-004L 60680-004 H60680-004		OIO	83143
	Models with Hendrickson HMX 400/460 Haulmax with 17.5" & 18.5" Saddle	60680-005L HDR60680-005 60680-005		OIO	83142
	Models with Rear 10000 lb - 15000 lb Low Profile AirLiner	16-18711-000 16-16577-000 471700002996		OIO	85335
	Models with Rear 52" Spring ,10000 lb - 15000 lb	16-16486-000 16-18710-000 471700002995		OIO	83134
	Models with Rear 52" Spring ,18000 lb - 23000 lb	471700002994 16-16442-000 16-18709-000		OIO	83134

APPLICATION GUIDE

Year	Fitment Notes	OEM#								
			Fleetline/ Gas SLX	Classic/ Ultra/ ProGuard/ Guardian	Max Control/ LTV Severe Duty/ Load Carrier	Steering Dampers/ Steering Stabilizer/ Cab Shock	Fleetline/ Gas SLX	Classic/ Ultra/ ProGuard/ Guardian	Max Control/ LTV Severe Duty/ Load Carrier/ HiJackers	Steering Dampers/ Steering Stabilizer/ Cab Shock

FREIGHTLINER

FREIGHTLINER

M2 (cont)

05-21	Models with Rear 60" Spring ,18000 lb - 23000 lb	16-15765-000 471700002993 16-18707-000	O 	85921
05-15	Models with Freightliner Low Profile Rear Air Suspension (18,000 to 40,000 lb)	16-14259-000 471700002992 16-18706-000	O O	85331



M2 100

02-10	Models with FAS II (40,000 lb) Rear Air Suspension	16-15817-000 16-18708-000 481700006848 471700002809 SDA471700002809	O O	85724 89443
	Models with Freightliner Low Profile Rear Air Suspension (18,000 to 40,000 lb)	16-14259-000 471700002992 16-18706-000	O O	85331
	Models with Freightliner TufTrac Rear Air Suspension	481700125969 16-15770-000	O O	85956
	Models with Hendrickson HMX 400/460 Haulmax with 16.5" Saddle	60680-004L 60680-004 H60680-004	O T	83143
	Models with Hendrickson HMX 400/460 Haulmax with 17.5" & 18.5" Saddle	60680-005L HDR60680-005 60680-005	O T	83142
	Models with Rear 10000 lb - 15000 lb Low Profile AirLiner	16-18711-000 16-16577-000 471700002996	O O	85335
	Models with Rear 52" Spring ,10000 lb - 15000 lb	16-16486-000 16-18710-000 471700002995	O 	83134
	Models with Rear 52" Spring ,18000 lb - 23000 lb	471700002994 16-16442-000 16-18709-000	O 	83134
	Models with Rear 60" Spring ,18000 lb - 23000 lb	16-15765-000 471700002993 16-18707-000	O 	85921

M2 106

09-24	Models with 8000 to 16000 lb Front Axle and Taperleaf Spring	10-13760-000 10-13592-000 471700000440 471700002991 SDA471700002991	O O	85959
02-24	Day Cab Models with Spring Suspensions	18-47350-000 18-60766-000 814903003482	O O	83040
	Models with FAS II (40,000 lb) Rear Air Suspension	16-15817-000 16-18708-000 481700006848 471700002809 SDA471700002809	O O	85724 89443
	Models with Freightliner TufTrac Rear Air Suspension	481700125969 16-15770-000	O O	85956
	Models with Hendrickson HMX 400/460 Haulmax with 16.5" Saddle	60680-004L 60680-004 H60680-004	O T	83143
	Models with Hendrickson HMX 400/460 Haulmax with 17.5" & 18.5" Saddle	60680-005L HDR60680-005 60680-005	O T	83142
02-23	Models with Rear 10000 lb - 15000 lb Low Profile AirLiner	16-18711-000 16-16577-000 471700002996	O O	85335
	Models with Rear 52" Spring ,10000 lb - 15000 lb	16-16486-000 16-18710-000 471700002995	O 	83134
	Models with Rear 52" Spring ,18000 lb - 23000 lb	471700002994 16-16442-000 16-18709-000	O 	83134
	Models with Rear 60" Spring ,18000 lb - 23000 lb	16-15765-000 471700002993 16-18707-000	O 	85921
	Models with Reyco 79KB Rear Steel Spring Suspension	19495-01 16725-01	O O	83126 89430

APPLICATION GUIDE

Year	Fitment Notes	OEM#								
			Fleetline\ Gas SLX	Classic\ Ultra\ ProGuard\ Guardian	Max Control\ LTV Severe Duty\ Load Carrier	Steering Dampers\ Steering Stabilizer\ Cab Shock	Fleetline\ Gas SLX	Classic\ Ultra\ ProGuard\ Guardian	Max Control\ LTV Severe Duty\ Load Carrier\ HiJackers	Steering Dampers\ Steering Stabilizer\ Cab Shock

FREIGHTLINER

FREIGHTLINER

M2 106 (cont)

02-15	Models with Freightliner Low Profile Rear Air Suspension (18,000 to 40,000 lb)	16-14259-000 47170002992 16-18706-000			85331
02-08	Models with 10000 to 12000 lb. Taper-leaf Spring Suspension	10-12390-000	010	85920
	Models with 6000 to 9000 lb Front axle	10-12388-000	010	85920

MB CHASSIS

	MB Chassis (VIP bus) 85000 Series	16-17760-000 471700131778 16-16827-000			85331
	MB55 Chassis 85000 Series	16-17759-000 471700000447	010	85919
	MB55 Models w/8000 lb. flat leaf front suspension 85000 Series	16-17684-000	010	85058
	MB55 Models w/8000 lb. flat leaf front suspension 89000 Series	16-17684-000	010	89431
	MB55 Shuttle bus w/8000 lb. flat leaf front suspension 85000 Series	16-15676-000	010	85058
	MB55 Shuttle bus w/8000 lb. flat leaf front suspension 89000 Series	16-15676-000	010	89431

MC CHASSIS

	MC Chassis with Hendrickson Softek Front Suspension 85000 Series	16-18094-000 471700000466		85959
	MC Chassis with O.E.M. Number 85000 Series	471700002727 16-18456-000	010	85959
	MC-L Chassis with 9,000 lb Suspension 85000 Series	471700002726 16-18455-000	010	85918
	MC-L Chassis with 9,000 lb Suspension 89000 Series	471700002726 16-18455-000	010	89449
96-99	MC Chassis for Class A Motorhomes 83000 Series	P117099	010	83120

MP 14

	MP 14 Chassis 83000 Series	16-15475-000		83164
--	----------------------------	--------------	--	-------	------	------	------	--	------	------	------	------

MP 19

	MP 19 Chassis 83000 Series	16-15475-000		83164
--	----------------------------	--------------	--	-------	------	------	------	--	------	------	------	------



MT45

98-23	Step Van Models with O.E.M. Number	16-20628-000 471700003011 16-22004-000 471700011302 16-19138-000		85058
	Walkin Step Van Models (18 Foot) with O.E.M. Number	16-20552-000 16-16542-000 16-15064-000 471700010991 16-15436-000	010	83154
99-20	MT45 Step Van - w/35" Front Spring	16-15473-000 16-15474-000	010	83157
	MT45 Step Van - w/38" Front Spring	16-15475-000	010	83164
98-20	Models with O.E.M. Number	16-15394-000	010	83120

MT55

	MT55 Models w/8000 lb. flat leaf front suspension 85000 Series	16-17684-000 16-15676-000		85058
	MT55 Models w/8000 lb. flat leaf front suspension 89000 Series	16-17684-000 16-15676-000	010	89431
	MT55 Step Van with O.E.M. Number To 2020 83000 Series	16-16542-000 16-15436-000	010	83154

APPLICATION GUIDE

Year	Fitment Notes	OEM#								
			Fleetline/ Gas SLX	Classic/ Ultra/ ProGuard/ Guardian	Max Control/ LTV Severe Duty/ Load Carrier	Steering Dampers/ Steering Stabilizer/ Cab Shock	Fleetline/ Gas SLX	Classic/ Ultra/ ProGuard/ Guardian	Max Control/ LTV Severe Duty/ Load Carrier/ HiJackers	Steering Dampers/ Steering Stabilizer/ Cab Shock

FREIGHTLINER

FREIGHTLINER

MT55 (cont)

99-24	Models with Freightliner Low Profile Rear Air Suspension	16-18706-000	O	O	O	O	O	O	O	O	O	O	O
	MT55 Chassis with O.E.M. Number	16-17759-000 47170000447 16-20632-000	O	O	O	O	O	O	O	O	O	O	O
99-20	MT55 Step Van - w/35" Front Spring	16-15473-000 16-15474-000	O	O	O	O	O	O	O	O	O	O	O
	MT55 Step Van - w/38" Front Spring	16-15475-000	O	O	O	O	O	O	O	O	O	O	O
99-11	Models with O.E.M. Number	16-16262-000 16-15934-000 16-15705-000	O	O	O	O	O	O	O	O	O	O	O

VARIOUS

	Fleetwood Motor Home with O.E.M. Number 83000 Series	GBL 651375 RW24285	O	O	O	O	O	O	O	O	O	O	O
	M-Line Walk in Van with O.E.M. Number 83000 Series	P117099 MAE 16949	O	O	O	O	O	O	O	O	O	O	O
	Models with 7000 lb Front Suspension 85000 Series	10-13776-000	O	O	O	O	O	O	O	O	O	O	O
	Models with 7000 lb Front Suspension 89000 Series	10-13776-000	O	O	O	O	O	O	O	O	O	O	O
	Models with Neway Air Suspension with shock stamping 85000 Series	90045083	O	O	O	O	O	O	O	O	O	O	O
	Oshkosh Motor Home with O.E.M. Number 83000 Series	1398980	O	O	O	O	O	O	O	O	O	O	O
	Step Van Models with O.E.M. Number 85000 Series	471700003011 16-19138-000	O	O	O	O	O	O	O	O	O	O	O
	Step Van Models with O.E.M. Number 89000 Series	471700003011 16-19138-000	O	O	O	O	O	O	O	O	O	O	O

VC CHASSIS

03-12	VC Chassis - ADL200 Suspension w/ 23,000 lb GVW & Higher 85000 Series	141700131809 16-16736-000	O	O	O	O	O	O	O	O	O	O	O
03-07	MotorHome Chassis with ZF - IFS Front Suspension (23,000 lb GVW & Higher) 85000 Series	16-18103-000 481700000493	I	I	I	I	I	I	I	I	I	I	I
	VC Chassis - ADL200 Suspension w/ 20K Rear 85000 Series	16-16873-000 471700131974	O	O	O	O	O	O	O	O	O	O	O
93-07	VC Chassis - Neway AS-120 Front Air Suspension (Up To 22000 lb GVW) 83000 Series	16-16737-000	O	O	O	O	O	O	O	O	O	O	O



XB CHASSIS

	MotorHome Chassis with Neway AS-120, 10,500 lb Front Air Suspension 83000 Series	141700000377 16-18075-000	O	O	O	O	O	O	O	O	O	O	O
	MotorHome Chassis with Neway AS-120, 12,000 lb Front Air Suspension 83000 Series	16-16874-000 141700000378 16-18076-000 141700131975	O	O	O	O	O	O	O	O	O	O	O

XC CHASSIS

	MotorHome Chassis with Neway AS-120, 10,500 lb Front Air Suspension 83000 Series	141700000377 16-18075-000	O	O	O	O	O	O	O	O	O	O	O
	MotorHome Chassis with Neway AS-120, 12,000 lb Front Air Suspension 83000 Series	16-16874-000 141700000378 16-18076-000 141700131975	O	O	O	O	O	O	O	O	O	O	O
	MotorHome Chassis with ZF- IFS, 12,000 lb Front Air Suspension 85000 Series	16-17144-000 481700000477 481700131919 16-17361-000	I	I	I	I	I	I	I	I	I	I	I
03-12	MotorHome Chassis with Neway AS-120 Front Air Suspension (23,000 lb GVW & Higher) 83000 Series	16-16874-000 16-16737-000 141700131810	O	O	O	O	O	O	O	O	O	O	O

APPLICATION GUIDE

Year	Fitment Notes	OEM#								
			Fleetline\ Gas SLX	Classic\ Ultra\ ProGuard\ Guardian	Max Control\ LTV Severe Duty\ Load Carrier	Steering Dampers\ Steering Stabilizer\ Cab Shock	Fleetline\ Gas SLX	Classic\ Ultra\ ProGuard\ Guardian	Max Control\ LTV Severe Duty\ Load Carrier\ HiJackers	Steering Dampers\ Steering Stabilizer\ Cab Shock

FREIGHTLINER

FREIGHTLINER

XC CHASSIS (cont)

03-12	XC Chassis - ADL200 Suspension w/ 23,000 lb GVW & Higher 85000 Series	141700131809 16-16736-000	OIO	85029
03-07	MotorHome Chassis with ZF - IFS Front Suspension (23,000 lb GVW & Higher) 85000 Series	16-18103-000 481700000493	I	85900
	XC Chassis - ADL200 Suspension w/ 20K Rear 85000 Series	16-16873-000 471700131974	OIO	85029
93-07	MotorHome Chassis with Neway AS-120 Front Air Suspension (Up To 22000 lb GVW) 83000 Series	16-16737-000	OIO	83160

XCS CHASSIS

01-02	XCS Chassis with Freightliner Rear Air Suspension 83000 Series	16-16093-000	OIO	83160
00-02	XCS Chassis (22000 lb GVW) w/ O.E.M. Number 83000 Series	16-15592-000	OIO	83154
	XCS Chassis (22000 lb GVW) w/ O.E.M. Number 85000 Series	16-15755-000 16-16043-000	OIO	85043

GEORGIE BOY MANUFACTURING

GEORGIE BOY MANUFACTURING



CLASS A MOTORHOMES

	Models with Workhorse UFO Chassis with Hendrickson Softek Front Suspension 83000 Series	66153-002 F4-BE5-C832-MO	OIO	83124	
	Models with Workhorse UFO Chassis with Hendrickson Softek Front Suspension 89000 Series	66153-002 F4-BE5-C832-MO	OIO	89407	
99-09	All Series MotorHomes with Ford F53 Chassis with 16,000 lb GVW to 22,000 lb GVW 83000 Series	ASH-1229 ASH-1228 9U94-18045-AA ASH-1205 AT-620 ASH-1022 1C34-18045-AA ASH-294 9U9Z-18124-A ASH-25822 ASH-25823 1C34-18045-JA AT-766	OIO	83209	
		ASH-1206 9U94-18080-AA AT-621 ASH-25824 9U9Z-18125-A ASH-1023 ASH-1230 ASH-137	OIO	83122
	All Series MotorHomes with Ford F53 Chassis with 16,000 lb GVW to 22,000 lb GVW 89000 Series	ASH-1229 ASH-1228 9U94-18045-AA ASH-1205 AT-620 ASH-1022 1C34-18045-AA ASH-294 9U9Z-18124-A ASH-25822 ASH-25823 1C34-18045-JA AT-766	OIO	89414
		ASH-1206 9U94-18080-AA AT-621 ASH-25824 9U9Z-18125-A ASH-1023 ASH-1230 ASH-137	OIO	89406

CLASS C MOTORHOMES

99-09	Maverick Series MotorHomes with Ford E450 Chassis LTV Severe Duty	ASH-1154	OIO	58622
-------	---	----------	-----	------	------	-------	------	------	------	------	------

APPLICATION GUIDE

Year	Fitment Notes	OEM#								
			Fleetline/ Gas SLX	Classic/ Ultra/ ProGuard/ Guardian	Max Control/ LTV Severe Duty/ Load Carrier	Steering Dampers/ Steering Stabilizer/ Cab Shock	Fleetline/ Gas SLX	Classic/ Ultra/ ProGuard/ Guardian	Max Control/ LTV Severe Duty/ Load Carrier/ HiJackers	Steering Dampers/ Steering Stabilizer/ Cab Shock

GEORGIE BOY MANUFACTURING CLASS C MOTORHOMES (cont)

GEORGIE BOY MANUFACTURING

99-09	Maverick Series MotorHomes with Ford E450 Chassis LTV Severe Duty	ASH-1136		O		O	58623	
	Maverick Series MotorHomes with Ford E450 Chassis Max Control	ASH-1154		O	77614		O
		ASH-1136		O		O	77623
	Maverick Series MotorHomes with Ford E450 Chassis Ultra Truck Shock	ASH-1154		O	G63622		O
		ASH-1136		O		O	G63623

GLAVAL BUS CO.

GLAVAL BUS CO.



CONCORDE II - SERIES

15-23	Models with F-650 chassis with 13,500, 15,500 & 19,000 lb Multi-leaf Rear Springs From 07/15 85000 Series	FC4Z-18125-A ASH-24660 471700011531 FC44-18080-AB		O		O	85180
	Models with F-650 chassis with 19.5" or 22.5" Wheels (22,000 lb GVW) From 07/15 85000 Series	FC4Z-18124-B FC4Z-18124-A ASH-24659 ASH-24658 471700011530 FC44-18045-BB		O	85181		O
04-15	Models with F-650 chassis with 21,000 lb Rear Air Suspension To 2015 85000 Series	3578858C1 3578858C2 4C4Z-18125-DA		O		O	85656
	Models with F-650 chassis with 22,000 lb Multi-leaf Rear Springs 83000 Series	4C4Z-18125-B 501906C92 ASH-24661		O		O	83317
00-15	Models with F-650 chassis with 10,000 lb Front Suspension 83000 Series	3584116C1 3584116C2 AA-616 4C4Z-18124-QA		O	83175		O
	Models with F-650 chassis with 12,000 & 13,200 lb Front Springs 85000 Series	4C4Z-18124-JB 3584118C2 AA-617 4C4Z-18124-RA AT-812		O	85928		O

VARIOUS

	Primetime Series Shuttle buses with Ford E350 Chassis To 2020 LTV Severe Duty	ASH-1136		O		O	58623	
	Primetime Series Shuttle buses with Ford E350 Chassis To 2020 Max Control	ASH-1136		O		O	77623	
	Primetime Series Shuttle buses with Ford E350 Chassis To 2020 Ultra Truck Shock	ASH-1136		O		O	G63623	
	Primetime Series Shuttle buses with Ford E350 Chassis To 2022 LTV Severe Duty	ASH-1154		O	58622		O	
	Primetime Series Shuttle buses with Ford E350 Chassis To 2022 Max Control	ASH-1154		O	77614		O	
	Primetime Series Shuttle buses with Ford E350 Chassis To 2022 Ultra Truck Shock	ASH-1154		O	G63622		O	
	Sport Series Shuttle buses with Ford E350 Chassis To 2020 LTV Severe Duty	ASH-1136		O		O	58623
	Sport Series Shuttle buses with Ford E350 Chassis To 2020 Max Control	ASH-1136		O		O	77623
	Sport Series Shuttle buses with Ford E350 Chassis To 2020 Ultra Truck Shock	ASH-1136		O		O	G63623
	Sport Series Shuttle buses with Ford E350 Chassis To 2022 LTV Severe Duty	ASH-1154		O	58622		O
	Sport Series Shuttle buses with Ford E350 Chassis To 2022 Max Control	ASH-1154		O	77614		O

APPLICATION GUIDE

Year	Fitment Notes	OEM#								
			Fleetline\ Gas SLX	Classic\ Ultra\ ProGuard\ Guardian	Max Control\ LTV Severe Duty\ Load Carrier	Steering Dampers\ Steering Stabilizer\ Cab Shock	Fleetline\ Gas SLX	Classic\ Ultra\ ProGuard\ Guardian	Max Control\ LTV Severe Duty\ Load Carrier\ HiJackers	Steering Dampers\ Steering Stabilizer\ Cab Shock

GLAVAL BUS CO.

GLAVAL BUS CO.

VARIOUS (cont)

	Sport Series Shuttle buses with Ford E350 Chassis To 2022 Ultra Truck Shock	ASH-1154		G63622
	Universal Series Shuttle buses with Ford E350 & E450 Chassis To 2020 LTV Severe Duty	ASH-1136		58623
	Universal Series Shuttle buses with Ford E350 & E450 Chassis To 2020 Max Control	ASH-1136		77623
	Universal Series Shuttle buses with Ford E350 & E450 Chassis To 2020 Ultra Truck Shock	ASH-1136		G63623
	Universal Series Shuttle buses with Ford E350 & E450 Chassis To 2022 LTV Severe Duty	ASH-1154		58622
	Universal Series Shuttle buses with Ford E350 & E450 Chassis To 2022 Max Control	ASH-1154		77614
	Universal Series Shuttle buses with Ford E350 & E450 Chassis To 2022 Ultra Truck Shock	ASH-1154		G63622

GMC

GMC

3500 & 4000 SERIES

63-66	Truck and School Bus 83000 Series	83221
	Truck and School Bus 85000 Series		85005
	Truck and School Bus 89000 Series		89430
60-62	3500, 4000, B-4000, L-4000, S-4000 with H-130, H-150 and 13800 Axles 83000 Series	83221



4500 SERIES

72-80	PS4620 P, 4650P Step Van (Walk-in) 3/4" Upper bolt 83000 Series	4940606 22012166 4975497 22007701 22002293 3192890 22012095		83126
	PS4620 P, 4650P Step Van (Walk-in) 3/4" Upper bolt 89000 Series	4940606 22012166 4975497 22007701 22002293 3192890 22012095		89430
	PS4620 P, 4650P Step Van (Walk-in) 5/8" Upper bolt 83000 Series	22007751		83303
	PS4620 P, 4650P Step Van (Walk-in) 83000 Series	22012096 3192892		83221
66-72	CE-4500, CS-4500 Conventional Cab with V-8 Gas or In-line 6 Gas Engines 83000 Series	22012096 3192892		83221
	EG-4500, EM-4500, ES-4500 Cab/Cowl with V-6 Gas or Diesel or In-line 6 Gas Engines 83000 Series	3171068 4940614 3192657 4963854 4963853		83216
		3171462 3192890 22012095		83126
EG-4500, EM-4500, ES-4500 Cab/Cowl with V-6 Gas or Diesel or In-line 6 Gas Engines 89000 Series	3171462 3192890 22012095		89430	

5000 SERIES

76-89	C Chassis - Conventional Cab 83000 Series	22012096 22012196		83221
-------	---	----------------------	--	------	------	------	------	------	-------	------	------	------	------

APPLICATION GUIDE

Year	Fitment Notes	OEM#								
			Fleetline/ Gas SLX	Classic/ Ultra/ ProGuard/ Guardian	Max Control/ LTV Severe Duty/ Load Carrier	Steering Dampers/ Steering Stabilizer/ Cab Shock	Fleetline/ Gas SLX	Classic/ Ultra/ ProGuard/ Guardian	Max Control/ LTV Severe Duty/ Load Carrier/ HiJackers	Steering Dampers/ Steering Stabilizer/ Cab Shock

GMC

GMC

5000 SERIES (cont)

75-80	C Chassis - Conventional Cab 83000 Series	4975510	OO	83221
73-80	C, S Chassis - Conventional Cab 83000 Series	22007750 4975494 4975467	OO	83207
	C, S Chassis - Conventional Cab 89000 Series	22007750 4975494 4975467	OO	89407
63-68	W-5000, BW-5000, DW-5000 85000 Series	OO	85005
	W-5000, BW-5000, DW-5000 89000 Series	OO	89430
60-62	5000, B-5000, L-5000, S-5000 with 1618 or 16802 Axle 83000 Series	OO	83221

5500 SERIES

73-89	C, S Chassis - Conventional Cab and School Bus 83000 Series	22012166 22012095	OO	83126
	C, S Chassis - Conventional Cab and School Bus 89000 Series	22012166 22012095	OO	89430
66-72	CE-5500, CS-5500 Conventional Cab with V-8 Gas or In-line 6 Gas Engines 83000 Series	22012096 3192892 3192891	OO	83221
	CG-5500, CM-5500, T-5500 Conventional & Tilt Cab with V-6 Gas or Diesel Engines 83000 Series	4940606 3192890 22012095	OO	83126
	CG-5500, CM-5500, T-5500 Conventional & Tilt Cab with V-6 Gas or Diesel Engines 89000 Series	4940606 3192890 22012095	OO	89430
	EG-5500, EM-5500, ES-5500 Cab/Cowl with 6 Cyl. Engines 83000 Series	3171068 4940614 3192657 4963854 4963853	OO	83216
		3171462 3192890 22012095	OO	83126
	EG-5500, EM-5500, ES-5500 Cab/Cowl with 6 Cyl. Engines 89000 Series	3171462 3192890 22012095	OO	89430
63-68	W-5500 85000 Series	OO	85005
	W-5500 89000 Series	OO	89430
60-68	LW-5500 85000 Series	OO	85307



6000 SERIES

79-80	W Chassis - 72" BBC Steel Tilt Cab 83000 Series	22007751	OO	83303
73-75	C, S Chassis - Conventional Cab and School Bus - Exc. with 18500, 20800 & 23000 lb. Rear Axle 83000 Series	22007750 4975494 4975467	OO	83207
	C, S Chassis - Conventional Cab and School Bus - Exc. with 18500, 20800 & 23000 lb. Rear Axle 89000 Series	22007750 4975494 4975467	OO	89407
60-68	L - 6000 85000 Series	OO	85307

C - SERIES (C4500, C5500) TOPKICK

90-99	C Chassis - Conventional Cab with 9100 to 17500 lb Rear Axle 83000 Series	22064432	OO	83221
83-89	C Chassis - Conventional Cab with 9100 to 17500 lb. Rear Axle 83000 Series	22064432	OO	83221

APPLICATION GUIDE

Year	Fitment Notes	OEM#								
			Fleetline\ Gas SLX	Classic\ Ultra\ ProGuard\ Guardian	Max Control\ LTV Severe Duty\ Load Carrier	Steering Dampers\ Steering Stabilizer\ Cab Shock	Fleetline\ Gas SLX	Classic\ Ultra\ ProGuard\ Guardian	Max Control\ LTV Severe Duty\ Load Carrier\ HiJackers	Steering Dampers\ Steering Stabilizer\ Cab Shock

GMC

GMC

C4500 TOPKICK

03-09	C Chassis - Conventional Cab with 15000, 19000, 21000 lb Multileaf Springs	15174902 88982686 22064232			85071	
	C Chassis - Conventional Cab with 19000, 21000, 23000 lb Taperleaf Springs (EXC Low Profile Vehicle)	22064233			83136	
	C Chassis - Conventional Cab with Front Shock with O.E.M. Number	88982682 15588554 15887728 19152843 22064230 15123676		83136	
	Models with Link Cabmate Model GMT560	1201-1043 1202-1043		000	83025	
	Truck Cabs with Link Cabmate Model GMC104TK	1201-0054 1202-0054		000	83021	
90-02	C Chassis - Conventional Cab with 15000, 19000, 21000 lb Multileaf Springs 85000 Series	15174902 88982686 22064232			85071	
	C Chassis - Conventional Cab with 19000, 21000, 23000 lb Taperleaf Springs (EXC Low Profile Vehicle) 83000 Series	22064233			83136	
	C Chassis - Conventional Cab with Front Shock with O.E.M. Number 83000 Series	88982682 15588554 15887728 19152843 22064230 15123676		83136	

C5500 TOPKICK

03-09	C Chassis - Conventional Cab with 15000, 19000, 21000 lb Multileaf Springs	15174902 88982686 22064232			85071	
	C Chassis - Conventional Cab with 19000, 21000, 23000 lb Taperleaf Springs (EXC Low Profile Vehicle)	22064233			83136	
	C Chassis - Conventional Cab with Front Shock with O.E.M. Number	88982682 15588554 15887728 19152843 22064230 15123676		83136	
	Models with Link Cabmate Model GMT560	1201-1043 1202-1043		000	83025	
	Truck Cabs with Link Cabmate Model GMC104TK	1201-0054 1202-0054		000	83021	
90-02	C Chassis - Conventional Cab with 15000, 19000, 21000 lb Multileaf Springs 85000 Series	15174902 88982686 22064232			85071	
	C Chassis - Conventional Cab with 19000, 21000, 23000 lb Taperleaf Springs (EXC Low Profile Vehicle) 83000 Series	22064233			83136	
	C Chassis - Conventional Cab with Front Shock with O.E.M. Number 83000 Series	88982682 15588554 15887728 19152843 22064230 15123676		83136	



C6000 TOPKICK

90-96	Truck Cabs with Link Cabmate Model GMC104TK	1201-0054 1202-0054		000	83021	
-------	---	------------------------	--	-----	------	------	------	-------	--	------	------	------	------

C6500 TOPKICK

03-09	Truck Cabs with Link Cabmate Model GMC104TK	1201-0054 1202-0054		000	83021	
97-01	Truck Cabs with Link Cabmate Model GMC104TK	1201-0054 1202-0054		000	83021	

APPLICATION GUIDE

Year	Fitment Notes	OEM#								
			Fleetline/ Gas SLX	Classic/ Ultra/ ProGuard/ Guardian	Max Control/ LTV Severe Duty/ Load Carrier	Steering Dampers/ Steering Stabilizer/ Cab Shock	Fleetline/ Gas SLX	Classic/ Ultra/ ProGuard/ Guardian	Max Control/ LTV Severe Duty/ Load Carrier/ HiJackers	Steering Dampers/ Steering Stabilizer/ Cab Shock

GMC

GMC

C7000 TOPKICK

90-96	Truck Cabs with Link Cabmate Model GMC104TK	1201-0054 1202-0054	O O	83021
-------	---	------------------------	--------	------	------	------	-------	------	------	------	------

C7500 TOPKICK

97-09	Truck Cabs with Link Cabmate Model GMC104TK	1201-0054 1202-0054	O O	83021
-------	---	------------------------	--------	------	------	------	-------	------	------	------	------

P - SERIES

92-96	Motorhome Chassis 83000 Series	22064233		I T	83136
-------	--------------------------------	----------	--	------	------	------	------	--------	-------	------	------	------

SAVANA 4500

10-20	All		I O	61685 G63895	O O	61687 G63897	77638
-------	-----	--	--------	------	-----------------	------	------	--------	------	-----------------	-------	------



T5500

97-09	FL1 Tilt Cab with 8100 lb Axle 83000 Series	22165188 22165187 22064804 22064805	I T	83136
	FL2 Tilt Cab with 5000 to 11000 lb Axle 83000 Series	22166442 22064807	I T	83136
	FL3 Tilt Cab with 14575 lb Axle 83000 Series	22165189 22064806	I T	83136
90-06	Tilt Cab with 15000, 19000, 21000 lb Multileaf Springs 85000 Series	15174902 22064232		I T	85071
92-99	Tilt Cab with 19000, 21000, 23000 lb Taperleaf Springs (EXC Low Profile Veh.) 83000 Series	22064233		I T	83136
99	Models with Hendrickson Air Suspension (Stamping number 47902-13) 83000 Series	12474915 15963161		O O	83122
	Models with Hendrickson Air Suspension (Stamping number 47902-13) 89000 Series	12474915 15963161		O O	89406

T6500

04-09	FL1 Tilt Cab with 8100 lb Axle	22165188 22165187 22064804 22064805	I T	83136
	FL2 Tilt Cab with 5000 to 11000 lb Axle	22166442 22064807	I T	83136
	FL3 Tilt Cab with 14575 lb Axle	22165189 22064806	I T	83136
04-06	Tilt Cab with 15000, 19000, 21000 lb Multileaf Springs	15174902 22064232		I T	85071
03	FL1 Tilt Cab with 8100 lb Axle 83000 Series	22165188 22165187 22064804 22064805	I T	83136
	FL2 Tilt Cab with 5000 to 11000 lb Axle 83000 Series	22166442 22064807	I T	83136
	FL3 Tilt Cab with 14575 lb Axle 83000 Series	22165189 22064806	I T	83136
	Tilt Cab with 15000, 19000, 21000 lb Multileaf Springs 85000 Series	15174902 22064232		I T	85071
97-02	FL1 Tilt Cab with 8100 lb Axle	22165188 22165187 22064804 22064805	I T	83136
	FL2 Tilt Cab with 5000 to 11000 lb Axle	22166442 22064807	I T	83136
	FL3 Tilt Cab with 14575 lb Axle	22165189 22064806	I T	83136
	Tilt Cab with 15000, 19000, 21000 lb Multileaf Springs	15174902 22064232		I T	85071
97-99	Tilt Cab with 19000, 21000, 23000 lb Taperleaf Springs (EXC Low Profile Veh.)	22064233		I T	83136

APPLICATION GUIDE

Year	Fitment Notes	OEM#								
			Fleetline\ Gas SLX	Classic\ Ultra\ ProGuard\ Guardian	Max Control\ LTV Severe Duty\ Load Carrier	Steering Dampers\ Steering Stabilizer\ Cab Shock	Fleetline\ Gas SLX	Classic\ Ultra\ ProGuard\ Guardian	Max Control\ LTV Severe Duty\ Load Carrier\ HiJackers	Steering Dampers\ Steering Stabilizer\ Cab Shock

GMC

GMC

T6500 (cont)

99	Models with Hendrickson Air Suspension (Stamping number 47902-13)	12474915 15963161			83122 89406
92-96	Tilt Cab with 19000, 21000, 23000 lb Taperleaf Springs (EXC Low Profile Veh.) 83000 Series	22064233			83136
90-96	Tilt Cab with 15000, 19000, 21000 lb Multileaf Springs 85000 Series	15174902 22064232			85071

W - SERIES (ISUZU)

	Models with O.E.M. Number 83000 Series	98098127 98098125 8-97083-029-0 898098-1250 94454987 97253616 8980981270 97201960 97253623 8-97201-960-0 97253621		83515
		98098059 898098-0590 898098-0581 98098058 8-97253665-0 898098-0580 97253665 97253651			83159

W4500 FORWARD

92-10	Models with 11000 lb & 13000 lb Suspension	9516306471 97083029 94454987 98232671 97083027 8972536200 8-94454-986-0 8-94454-987-0 97253620 8-97253-620-0 8944549870 8944549860		83515
-------	--	---	--	-------	------	------	------	--	------	------	------	------

W5500 FORWARD

88-10	Models with 11000 lb & 13000 lb Suspension	97253620		83515
-------	--	----------	--	-------	------	------	------	--	------	------	------	------

W6500 FORWARD

87-96	Models with 11000 lb & 13000 lb Suspension	1-51630-168-1		83515
-------	--	---------------	--	-------	------	------	------	--	------	------	------	------



GOSHEN COACH

GOSHEN COACH

VARIOUS

	Impule Series Shuttle buses with Ford E350 & E450 Chassis To 2020 LTV Severe Duty	ASH-1154		58622
		ASH-1136		58623
	Impule Series Shuttle buses with Ford E350 & E450 Chassis To 2020 Max Control	ASH-1154		77614
		ASH-1136		77623
	Impule Series Shuttle buses with Ford E350 & E450 Chassis To 2020 Ultra Truck Shock	ASH-1154		G63622
		ASH-1136		G63623
	Pacer II Series Shuttle buses with Ford E350 Chassis To 2020 LTV Severe Duty	ASH-1154		58622

APPLICATION GUIDE

Year	Fitment Notes	OEM#								
			Fleetline/ Gas SLX	Classic/ Ultra/ ProGuard/ Guardian	Max Control/ LTV Severe Duty/ Load Carrier	Steering Dampers/ Steering Stabilizer/ Cab Shock	Fleetline/ Gas SLX	Classic/ Ultra/ ProGuard/ Guardian	Max Control/ LTV Severe Duty/ Load Carrier/ HiJackers	Steering Dampers/ Steering Stabilizer/ Cab Shock

GOSHEN COACH

GOSHEN COACH

VARIOUS (cont)

	Pacer II Series Shuttle buses with Ford E350 Chassis To 2020 LTV Severe Duty	ASH-1136		O		O	58623
	Pacer II Series Shuttle buses with Ford E350 Chassis To 2020 Max Control	ASH-1154		O	77614		O
		ASH-1136		O		O	77623
	Pacer II Series Shuttle buses with Ford E350 Chassis To 2020 Ultra Truck Shock	ASH-1154		O	G63622		O
		ASH-1136		O		O	G63623

GRECH MOTORS

GRECH MOTORS

	Shuttle buses with Ford E450 Chassis To 2020 LTV Severe Duty	ASH-1154		O	58622		O
		ASH-1136		O		O	58623
	Shuttle buses with Ford E450 Chassis To 2020 Max Control	ASH-1154		O	77614		O
		ASH-1136		O		O	77623
	Shuttle buses with Ford E450 Chassis To 2020 Ultra Truck Shock	ASH-1154		O	G63622		O
		ASH-1136		O		O	G63623

GULF STREAM

GULF STREAM



ATRIUM

03-06	Models with Freightliner XC Chassis with ZF - IFS Front Suspension and 23,000 lb GVW or Greater 85000 Series	16-18103-000 481700000493		O	85900		O
	MotorHomes with Freightliner XC Chassis & AS120 Front Suspension AS120 Front Suspension 83000 Series	16-16874-000 16-16737-000 141700131810		O	83160		O
	MotorHomes with Freightliner XC Chassis and ADL200 Suspension w/ 20K Rear 85000 Series	16-16873-000 141700131809 16-16736-000		O		O	85029

BT CRUISER

16-24	MotorHomes with Ford E350 or E450 Chassis	8C2Z-18124-D 8C24-18045-DA ASH-1154 AT-163G		O	G63622	58622 77614		O	
		8C24-18080-DB ASH-1136 8C2Z-18125-D AT-164G		O		O	G63623	58623 77623
02-15	MotorHomes with Ford E350 or E450 Chassis LTV Severe Duty	8C2Z-18124-D 8C24-18045-DA ASH-1154 AT-163G		O	58622		O	
		8C24-18080-DB ASH-1136 8C2Z-18125-D AT-164G		O		O	58623
	MotorHomes with Ford E350 or E450 Chassis Max Control	8C2Z-18124-D 8C24-18045-DA ASH-1154 AT-163G		O	77614		O
		8C24-18080-DB ASH-1136 8C2Z-18125-D AT-164G		O		O	77623
MotorHomes with Ford E350 or E450 Chassis Ultra Truck Shock	8C2Z-18124-D 8C24-18045-DA ASH-1154 AT-163G		O	G63622		O	
	8C24-18080-DB ASH-1136 8C2Z-18125-D AT-164G		O		O	G63623	

APPLICATION GUIDE

Year	Fitment Notes	OEM#								
			Fleetline\ Gas SLX	Classic\ Ultra\ ProGuard\ Guardian	Max Control\ LTV Severe Duty\ Load Carrier	Steering Dampers\ Steering Stabilizer\ Cab Shock	Fleetline\ Gas SLX	Classic\ Ultra\ ProGuard\ Guardian	Max Control\ LTV Severe Duty\ Load Carrier\ HiJackers	Steering Dampers\ Steering Stabilizer\ Cab Shock

GULF STREAM CAVALIER



GULF STREAM

99-06	MotorHomes with Ford E350 or E450 Chassis LTV Severe Duty	ASH-1154		58622
		ASH-1136		58623
	MotorHomes with Ford E350 or E450 Chassis Max Control	ASH-1154		77614
		ASH-1136		77623
	MotorHomes with Ford E350 or E450 Chassis Ultra Truck Shock	ASH-1154		G63622
		ASH-1136		G63623

CONQUEST

16-24	MotorHomes with Ford E350 or E450 Chassis	8C2Z-18124-D 8C24-18045-DA ASH-1154 AT-163G		G63622	58622 77614	
		8C24-18080-DB ASH-1136 8C2Z-18125-D AT-164G		G63623	58623 77623
12-15	MotorHomes with Ford E350 or E450 Chassis LTV Severe Duty	8C2Z-18124-D 8C24-18045-DA ASH-1154 AT-163G		58622	
		8C24-18080-DB ASH-1136 8C2Z-18125-D AT-164G		58623
	MotorHomes with Ford E350 or E450 Chassis Max Control	8C2Z-18124-D 8C24-18045-DA ASH-1154 AT-163G		77614
		8C24-18080-DB ASH-1136 8C2Z-18125-D AT-164G		77623
	MotorHomes with Ford E350 or E450 Chassis Ultra Truck Shock	8C2Z-18124-D 8C24-18045-DA ASH-1154 AT-163G		G63622
		8C24-18080-DB ASH-1136 8C2Z-18125-D AT-164G		G63623
02-11	MotorHomes with Ford E350 or E450 Chassis	8C2Z-18124-D 8C24-18045-DA ASH-1154 AT-163G		G63622	58622 77614	
		8C24-18080-DB ASH-1136 8C2Z-18125-D AT-164G		G63623	58623 77623
93-01	MotorHomes with Ford E350 or E450 Chassis LTV Severe Duty	8C2Z-18124-D 8C24-18045-DA ASH-1154 AT-163G		58622	
		8C24-18080-DB ASH-1136 8C2Z-18125-D AT-164G		58623
	MotorHomes with Ford E350 or E450 Chassis Max Control	8C2Z-18124-D 8C24-18045-DA ASH-1154 AT-163G		77614
		8C24-18080-DB ASH-1136 8C2Z-18125-D AT-164G		77623
	MotorHomes with Ford E350 or E450 Chassis Ultra Truck Shock	8C2Z-18124-D 8C24-18045-DA ASH-1154 AT-163G		G63622
		8C24-18080-DB ASH-1136 8C2Z-18125-D AT-164G	

APPLICATION GUIDE

Year	Fitment Notes	OEM#								
			Fleetline/ Gas SLX	Classic/ Ultra/ ProGuard/ Guardian	Max Control/ LTV Severe Duty/ Load Carrier	Steering Dampers/ Steering Stabilizer/ Cab Shock	Fleetline/ Gas SLX	Classic/ Ultra/ ProGuard/ Guardian	Max Control/ LTV Severe Duty/ Load Carrier/ HiJackers	Steering Dampers/ Steering Stabilizer/ Cab Shock

GULF STREAM

CONQUEST (cont)

93-01	MotorHomes with Ford E350 or E450 Chassis Ultra Truck Shock	8C24-18080-DB ASH-1136 8C2Z-18125-D AT-164G											
-------	---	--	--	--	--	--	--	--	--	--	--	--	--

GULF STREAM

CONQUEST SPORT

10-11	MotorHomes with Ford E350 or E450 Chassis	8C2Z-18124-D 8C24-18045-DA ASH-1154 AT-163G			G63622	58622 77614							
		8C24-18080-DB ASH-1136 8C2Z-18125-D AT-164G								G63623	58623 77623		
01-02	MotorHomes with Ford E350 or E450 Chassis	8C2Z-18124-D 8C24-18045-DA ASH-1154 AT-163G			G63622	58622 77614							
		8C24-18080-DB ASH-1136 8C2Z-18125-D AT-164G								G63623	58623 77623		

ENDURA

08	MotorHomes with Chevy Kodiak Chassis	88982682 15588554 15887728 19152843 22064230 15123676		83136									
04-07	MotorHomes with Chevy Kodiak Chassis 83000 Series	88982682 15588554 15887728 19152843 22064230 15123676		83136									

FRIENDSHIP

02-06	Models with Freightliner XC Chassis with ZF - IFS Front Suspension and 23,000 lb GVW or Greater 85000 Series	16-18103-000 481700000493		85900									
	MotorHomes with Freightliner XC Chassis & AS120 Front Suspension AS120 Front Suspension 83000 Series	16-16874-000 16-16737-000 141700131810		83160									
	MotorHomes with Freightliner XC Chassis and ADL200 Suspension w/ 20K Rear 85000 Series	16-16873-000 141700131809 16-16736-000							85029				

INDEPENDENCE

00-11	MotorHomes with Ford E350 or E450 Chassis	8C2Z-18124-D 8C24-18045-DA ASH-1154 AT-163G			G63622	58622 77614							
		8C24-18080-DB ASH-1136 8C2Z-18125-D AT-164G								G63623	58623 77623		
02	Models with Freightliner XC Chassis with ZF - IFS Front Suspension and 23,000 lb GVW or Greater	16-18103-000 481700000493		85900									
	MotorHomes with Freightliner XC Chassis and ADL200 Suspension w/ 20K Rear	16-16873-000 141700131809 16-16736-000							85029				
	MotorHomes with Freightliner XC Chassis and AS120 Front Suspension	16-16874-000 16-16737-000 141700131810		83160									

MONTAJ

10-11	MotorHomes with Ford E350 or E450 Chassis	8C2Z-18124-D 8C24-18045-DA ASH-1154 AT-163G			G63622	58622 77614							
-------	---	--	--	--	--------	----------------	--	--	--	--	--	--	--

APPLICATION GUIDE

Year	Fitment Notes	OEM#								
			Fleetline\ Gas SLX	Classic\ Ultra\ ProGuard\ Guardian	Max Control\ LTV Severe Duty\ Load Carrier	Steering Dampers\ Steering Stabilizer\ Cab Shock	Fleetline\ Gas SLX	Classic\ Ultra\ ProGuard\ Guardian	Max Control\ LTV Severe Duty\ Load Carrier\ HiJackers	Steering Dampers\ Steering Stabilizer\ Cab Shock

GULF STREAM

GULF STREAM

MONTAJ (cont)

10-11	MotorHomes with Ford E350 or E450 Chassis	8C24-18080-DB ASH-1136 8C2Z-18125-D AT-164G								G63623	58623 77623	
-------	---	--	--	--	--	--	--	--	--	--------	----------------	--

SCENIC CRUISER

02-06	Models with Freightliner XC Chassis with ZF - IFS Front Suspension and 23,000 lb GVW or Greater 85000 Series	16-18103-000 481700000493										
	MotorHomes with Freightliner XC Chassis & AS120 Front Suspension AS120 Front Suspension 83000 Series	16-16874-000 16-16737-000 141700131810	83160									
	MotorHomes with Freightliner XC Chassis and ADL200 Suspension w/ 20K Rear 85000 Series	16-16873-000 141700131809 16-16736-000						85029				



ULTRA

00-08	MotorHomes with Ford E350 or E450 Chassis LTV Severe Duty	ASH-1154											
		ASH-1136											
	MotorHomes with Ford E350 or E450 Chassis Max Control	ASH-1154				77614							
		ASH-1136									77623		
	MotorHomes with Ford E350 or E450 Chassis Ultra Truck Shock	ASH-1154				G63622							
		ASH-1136									G63623		

YELLOWSTONE

05-11	MotorHomes with Ford E350 or E450 Chassis	8C2Z-18124-D 8C24-18045-DA ASH-1154 AT-163G											
		8C24-18080-DB ASH-1136 8C2Z-18125-D AT-164G								G63623	58623 77623		
02-04	Models with Freightliner XC Chassis with ZF - IFS Front Suspension and 23,000 lb GVW or Greater 85000 Series	16-18103-000 481700000493	85900										
	MotorHomes with Ford E350 or E450 Chassis LTV Severe Duty	8C2Z-18124-D 8C24-18045-DA ASH-1154 AT-163G											
		8C24-18080-DB ASH-1136 8C2Z-18125-D AT-164G									58623		
	MotorHomes with Ford E350 or E450 Chassis Max Control	8C2Z-18124-D 8C24-18045-DA ASH-1154 AT-163G					77614						
		8C24-18080-DB ASH-1136 8C2Z-18125-D AT-164G									77623		
	MotorHomes with Ford E350 or E450 Chassis Ultra Truck Shock	8C2Z-18124-D 8C24-18045-DA ASH-1154 AT-163G					G63622						
		8C24-18080-DB ASH-1136 8C2Z-18125-D AT-164G									G63623		
	MotorHomes with Freightliner XC Chassis & AS120 Front Suspension 83000 Series	16-16874-000 16-16737-000 141700131810	83160										
MotorHomes with Freightliner XC Chassis and ADL200 Suspension w/ 20K Rear 85000 Series	16-16873-000 141700131809 16-16736-000									85029			

APPLICATION GUIDE

Year	Fitment Notes	OEM#								
			Fleetline/ Gas SLX	Classic/ Ultra/ ProGuard/ Guardian	Max Control/ LTV Severe Duty/ Load Carrier	Steering Dampers/ Steering Stabilizer/ Cab Shock	Fleetline/ Gas SLX	Classic/ Ultra/ ProGuard/ Guardian	Max Control/ LTV Severe Duty/ Load Carrier/ HiJackers	Steering Dampers/ Steering Stabilizer/ Cab Shock

HINO

HINO

145

05-10	Models with O.E.M. Number	S4850-03710 48500-3710A 48500-3710	O O	83126
-------	---------------------------	--	--------	-------	------	------	------	------	------	------	------

155

13-20	Models with O.E.M. Number	48511-80162 48511-37320	I O	83518
		48531-37351		O O	83519

165

05-10	Models with O.E.M. Number	S4850-03710 48500-3710A 48500-3710	O O O	83126
-------	---------------------------	--	-------------	-------	------	------	------	------	------	------	------

185

05-10	Models with O.E.M. Number	S4850-03710 48500-3710A 48500-3710	O O O	83126
		48500-3720 S4850-03720	O O	83140

195

21	Models with O.E.M. Number 83000 Series	48511-80162 48511-37320	I O	83518
		48531-37362 48531-37361		O O	83519
12-20	Models with O.E.M. Number	48511-80162 48511-37320	I O	83518
		48531-37362 48531-37361		O O	83519

238

08-14	Models with Hendrickson Comfort Air (Single Axle - 19K)	48530-E0100 60670-014L 60670-031L 60670-019L 60670-029L	O O	83166
05-14	Models with O.E.M. Number	48500-3720 S4850-03720	O O	83140

258

08-23	Models with Hendrickson Comfort Air (Single Axle - 19K)	48530-E0100 60670-014L 48530-E0390 60670-031L 60670-019L 60670-029L	O O	83166
15-21	Models with O.E.M. Number	48500-E0420	O O	83391
06-14	Models with O.E.M. Number	48500-3720 S4850-03720	O O	83140

258ALP

08-14	Models with Hendrickson Comfort Air (Single Axle - 19K)	48530-E0100 60670-014L 60670-031L 60670-019L 60670-029L	O O	83166
-------	--	---	--------	------	------	------	------	-------	------	------	------



258LP

15-20	Models with O.E.M. Number	48500-E0420	O O	83391
-------	---------------------------	-------------	--------	-------	------	------	------	------	------	------	------

268

08-23	Models with Hendrickson Comfort Air (Single Axle - 19K)	48530-E0100 60670-014L 48530-E0390 60670-031L 60670-019L 60670-029L	O O	83166
15-22	Models with O.E.M. Number	48500-E0420	O O	83391

APPLICATION GUIDE

Year	Fitment Notes	OEM#								
			Fleetline\ Gas SLX	Classic\ Ultra\ ProGuard\ Guardian	Max Control\ LTV Severe Duty\ Load Carrier	Steering Dampers\ Steering Stabilizer\ Cab Shock	Fleetline\ Gas SLX	Classic\ Ultra\ ProGuard\ Guardian	Max Control\ LTV Severe Duty\ Load Carrier\ HiJackers	Steering Dampers\ Steering Stabilizer\ Cab Shock

HINO

HINO

268 (cont)

05-14	Models with O.E.M. Number	48500-3720 S4850-03720	 o	83140
-------	---------------------------	---------------------------	-------	-------	------	------	------	------	------	------	------

268, 268A SERIES

	Models with Hendrickson Rear Air Suspension (Shock stamping #) 83000 Series	60670-012	 o	83168
--	---	-----------	-------	------	------	------	------	------	-------	------	------	------

268A

08-14	Models with Hendrickson Comfort Air (Single Axle - 19K)	48530-E0100 60670-014L 60670-031L 60670-019L 60670-029L	 o	83166
	Models with O.E.M. Number	48500-3720 S4850-03720	 o	83140

ADDITIONAL APPLICATIONS

	Conventional Hino Models with Hendrickson Comfort Air Suspension (19,000 lb & 21,000 lb Capacity) 83000 Series	60670-013	 o	83148
	Conventional Hino Models with Hendrickson Comfort Air Suspension 83000 Series	60670-020	 o	83148

FA, FB SERIES

98	FA1517, FA1817, FB1817 Ultra Truck Shock	 o	G63419
----	--	------	-------	------	------	------	------	------	------	--------	------	------

FA14

89-91	FA, FB Models Trucks with:	S4853-01910	 o	83216
	Models with O.E.M. Number	S4850-01950 48500-1950 48500-2750 S4850-02750 66639	 o	G63610



FA15

92	FA, FB Models Trucks with:	S4850-01950 48500-1950 48500-2750 S4850-02750 66639	 o	G63610
		S4853-02510 S4853-01910 48530-2510 34802 48530-1910	 o	83216

FA1415

93-97	(FA15)	48500-1950	 o	G63610	
		48530-1910	 o	83216	
	FA, FB Models Trucks with:	S4850-01950 48500-1950 48500-2750 S4850-02750 66639	 o	G63610	
		S4853-02510 S4853-01910 48530-2510 34802 48530-1910	 o	83216
		FA1415 (FA15), FB1715 (FB15)	48500-1950	 o	G63610
	48530-1910		 o	83216

APPLICATION GUIDE

Year	Fitment Notes	OEM#								
			Fleetline/ Gas SLX	Classic/ Ultra/ ProGuard/ Guardian	Max Control/ LTV Severe Duty/ Load Carrier	Steering Dampers/ Steering Stabilizer/ Cab Shock	Fleetline/ Gas SLX	Classic/ Ultra/ ProGuard/ Guardian	Max Control/ LTV Severe Duty/ Load Carrier/ HiJackers	Steering Dampers/ Steering Stabilizer/ Cab Shock

HINO

HINO

FA1517

98-04	FA, FB Models Trucks with:	S4850-01950 48500-1950 48500-2750 S4850-02750 66639	↓ O		G63610							
		S4853-02510 S4853-01910 48530-2510 34802 48530-1910										
98	All	48530-2510										
	FA1517, FA1817, FB1817	48530-2510										

FA1817

98	83000 Series	48530-2510										
----	--------------	------------	--	--	--	--	--	--	--	--	--	--

FB14

89-91	FA, FB Models Trucks with:	S4850-01950 48500-1950 48500-2750 S4850-02750 66639	↓ O		G63610							
		S4853-02510 S4853-01910 48530-2510 34802 48530-1910										

FB15

92	FA, FB Models Trucks with:	S4850-01950 48500-1950 48500-2750 S4850-02750 66639	↓ O		G63610							
		S4853-02510 S4853-01910 48530-2510 34802 48530-1910										



FB1715

93-97	FA, FB Models Trucks with:	S4850-01950 48500-1950 48500-2750 S4850-02750 66639	↓ O		G63610							
		S4853-02510 S4853-01910 48530-2510 34802 48530-1910										
	FA1415 (FA15), FB1715 (FB15)	48500-1950	↓ O		G63610							
		48530-1910										

FB1817

98-04	FA, FB Models Trucks with:	S4850-01950 48500-1950 48500-2750 S4850-02750 66639	↓ O		G63610							
		S4853-02510 S4853-01910 48530-2510 34802 48530-1910										
	FE Models Trucks with:	S4850-01941 48500-1941	O		83141							
98	All	48530-2510										
	FA1517, FA1817, FB1817	48530-2510										

APPLICATION GUIDE

Year	Fitment Notes	OEM#								
			Fleetline\ Gas SLX	Classic\ Ultra\ ProGuard\ Guardian	Max Control\ LTV Severe Duty\ Load Carrier	Steering Dampers\ Steering Stabilizer\ Cab Shock	Fleetline\ Gas SLX	Classic\ Ultra\ ProGuard\ Guardian	Max Control\ LTV Severe Duty\ Load Carrier\ HiJackers	Steering Dampers\ Steering Stabilizer\ Cab Shock

HINO

HINO

FD16

86-87	Models with O.E.M. Number	48530-1880	83215
-------	---------------------------	------------	-----	-----	-----	-----	-------	-----	-----	-----

FD17

88-92	Models with O.E.M. Number	48530-1880	83215
-------	---------------------------	------------	-----	-----	-----	-----	-------	-----	-----	-----

FD2218

93-97	(FD5H). FE5H, FF5H	48500-1801	83216
		48530-1880	83215

FD2218LD

93-97	(FD5H). FE5H, FF5H 83000 Series	48530-1880	83215
-------	---------------------------------	------------	-----	-----	-----	-----	-------	-----	-----	-----

FD2218LP

93-97	Models with O.E.M. Number	48500-1801	83216
		48530-1880	83215

FE SERIES

98-04	Models Trucks with O.E.M. Number 83000 Series	S4850-01941 48500-1941	83141
-------	---	---------------------------	-------	-----	-----	-----	-----	-----	-----	-----

FE16

86-87	All	48500-1801	83216
-------	-----	------------	-------	-----	-----	-----	-----	-----	-----	-----

FE2620

98	All	48530-1880	83215
----	-----	------------	-----	-----	-----	-----	-------	-----	-----	-----

GC17

90-91	GC17	48500-1801	83216
-------	------	------------	-------	-----	-----	-----	-----	-----	-----	-----

GC20

92	GC20	48500-1801	83216
----	------	------------	-------	-----	-----	-----	-----	-----	-----	-----

L6

22-24	Models with Hendrickson Comfort Air (Single Axle - 19K) 83000 Series	48530-E0100 60670-014L 48530-E0390 60670-031L 60670-019L 60670-029L	83166
	Models with O.E.M. Number 83000 Series	48500-E0420	83391
21	Models with Hendrickson Comfort Air (Single Axle - 19K)	48530-E0100 60670-014L 60670-031L 60670-019L 60670-029L	83166
	Models with O.E.M. Number	48500-E0420	83391



L7

21	Models with Hendrickson Comfort Air (Single Axle - 21K & 23K)	60670-018 60670-030L 60670-030 48530-E0290 60670-018L	83166
	Models with O.E.M. Number	48500-E0420	83391

L8

21	Models with Hendrickson Comfort Air (Single Axle - 21K & 23K)	60670-018 60670-030L 60670-030 48530-E0290 60670-018L	83166
----	---	---	-----	-----	-----	-----	-------	-----	-----	-----

APPLICATION GUIDE



Year	Fitment Notes	OEM#								
			Fleetline/ Gas SLX	Classic/ Ultra/ ProGuard/ Guardian	Max Control/ LTV Severe Duty/ Load Carrier	Steering Dampers/ Steering Stabilizer/ Cab Shock	Fleetline/ Gas SLX	Classic/ Ultra/ ProGuard/ Guardian	Max Control/ LTV Severe Duty/ Load Carrier/ HiJackers	Steering Dampers/ Steering Stabilizer/ Cab Shock

HOLIDAY RAMBLER ADMIRAL

HOLIDAY RAMBLER

16-24	MotorHomes with Ford F53 Chassis with 16,000 lb GVW to 22,000 lb GVW	ASH-1229 ASH-1228 9U94-18045-AA ASH-1205 AT-620 ASH-1022 1C34-18045-AA ASH-294 9U9Z-18124-A ASH-25822 ASH-25823 1C34-18045-JA AT-766	83209
		OO	83122 89406
11-15	MotorHomes with Ford F53 Chassis with 16,000 lb GVW to 22,000 lb GVW 83000 Series	ASH-1229 ASH-1228 9U94-18045-AA ASH-1205 AT-620 ASH-1022 1C34-18045-AA ASH-294 9U9Z-18124-A ASH-25822 ASH-25823 1C34-18045-JA AT-766	83209
		OO	83122
11-15	MotorHomes with Ford F53 Chassis with 16,000 lb GVW to 22,000 lb GVW 89000 Series	ASH-1229 ASH-1228 9U94-18045-AA ASH-1205 AT-620 ASH-1022 1C34-18045-AA ASH-294 9U9Z-18124-A ASH-25822 ASH-25823 1C34-18045-JA AT-766	89414
		OO	89406
07-10	MotorHomes with Ford F53 Chassis with 16,000 lb GVW to 22,000 lb GVW	ASH-1229 ASH-1228 9U94-18045-AA ASH-1205 AT-620 ASH-1022 1C34-18045-AA ASH-294 9U9Z-18124-A ASH-25822 ASH-25823 1C34-18045-JA AT-766	83209
		OO	83122 89406

APPLICATION GUIDE

Year	Fitment Notes	OEM#								
			Fleetline\ Gas SLX	Classic\ Ultra\ ProGuard\ Guardian	Max Control\ LTV Severe Duty\ Load Carrier	Steering Dampers\ Steering Stabilizer\ Cab Shock	Fleetline\ Gas SLX	Classic\ Ultra\ ProGuard\ Guardian	Max Control\ LTV Severe Duty\ Load Carrier\ HiJackers	Steering Dampers\ Steering Stabilizer\ Cab Shock

HOLIDAY RAMBLER

HOLIDAY RAMBLER

ADMIRAL (cont)

02-06	MotorHomes with Ford F53 Chassis with 16,000 lb GVW to 22,000 lb GVW 83000 Series	ASH-1229 ASH-1228 9U94-18045-AA ASH-1205 AT-620 ASH-1022 1C34-18045-AA ASH-294 9U9Z-18124-A ASH-25822 ASH-25823 1C34-18045-JA AT-766	83209	oio	
		ASH-1206 9U94-18080-AA AT-621 ASH-25824 9U9Z-18125-A ASH-1023 ASH-1230 ASH-137	oio	83122
	MotorHomes with Ford F53 Chassis with 16,000 lb GVW to 22,000 lb GVW 89000 Series	ASH-1229 ASH-1228 9U94-18045-AA ASH-1205 AT-620 ASH-1022 1C34-18045-AA ASH-294 9U9Z-18124-A ASH-25822 ASH-25823 1C34-18045-JA AT-766	89414	oio
		ASH-1206 9U94-18080-AA AT-621 ASH-25824 9U9Z-18125-A ASH-1023 ASH-1230 ASH-137	oio	89406
00-01	Models with Workhorse W22 Chassis with 8.1L Gas V8	01809925	85010	oio	
	MotorHomes with Ford F53 Chassis with 16,000 lb GVW to 22,000 lb GVW	ASH-1229 ASH-1228 9U94-18045-AA ASH-1205 AT-620 ASH-1022 1C34-18045-AA ASH-294 9U9Z-18124-A ASH-25822 ASH-25823 1C34-18045-JA AT-766	83209	oio	
		ASH-1206 9U94-18080-AA AT-621 ASH-25824 9U9Z-18125-A ASH-1023 ASH-1230 ASH-137	oio	83122 89406

ADMIRAL SE

02-06	MotorHomes with Ford F53 Chassis with 16,000 lb GVW to 22,000 lb GVW	ASH-1229 ASH-1228 9U94-18045-AA ASH-1205 AT-620 ASH-1022 1C34-18045-AA ASH-294 9U9Z-18124-A ASH-25822 ASH-25823 1C34-18045-JA AT-766	83209	oio
-------	--	--	-------	-----	------	------	------	------	------	------	------

APPLICATION GUIDE

Year	Fitment Notes	OEM#								
			Fleetline/ Gas SLX	Classic/ Ultra/ ProGuard/ Guardian	Max Control/ LTV Severe Duty/ Load Carrier	Steering Dampers/ Steering Stabilizer/ Cab Shock	Fleetline/ Gas SLX	Classic/ Ultra/ ProGuard/ Guardian	Max Control/ LTV Severe Duty/ Load Carrier/ HiJackers	Steering Dampers/ Steering Stabilizer/ Cab Shock

HOLIDAY RAMBLER

HOLIDAY RAMBLER

ADMIRAL SE (cont)

02-06	MotorHomes with Ford F53 Chassis with 16,000 lb GVW to 22,000 lb GVW	ASH-1206 9U94-18080-AA AT-621 ASH-25824 9U9Z-18125-A ASH-1023 ASH-1230 ASH-137									83122 89406			
-------	--	---	--	--	--	--	--	--	--	--	----------------	--	--	--

ADMIRAL SVE

07	MotorHomes with Ford F53 Chassis with 16,000 lb GVW to 22,000 lb GVW	ASH-1229 ASH-1228 9U94-18045-AA ASH-1205 AT-620 ASH-1022 1C34-18045-AA ASH-294 9U9Z-18124-A ASH-25822 ASH-25823 1C34-18045-JA AT-766		83209										
		ASH-1206 9U94-18080-AA AT-621 ASH-25824 9U9Z-18125-A ASH-1023 ASH-1230 ASH-137											83122 89406	



ADMIRAL XE

16-18	MotorHomes with Ford F53 Chassis with 16,000 lb GVW to 22,000 lb GVW	ASH-1229 ASH-1228 9U94-18045-AA ASH-1205 AT-620 ASH-1022 1C34-18045-AA ASH-294 9U9Z-18124-A ASH-25822 ASH-25823 1C34-18045-JA AT-766		83209										
		ASH-1206 9U94-18080-AA AT-621 ASH-25824 9U9Z-18125-A ASH-1023 ASH-1230 ASH-137											83122 89406	

ALTERA

19	MotorHomes with Ford E450 Chassis LTV Severe Duty	8C2Z-18124-D 8C24-18045-DA ASH-1154 AT-163G				58622									
		8C24-18080-DB ASH-1136 8C2Z-18125-D AT-164G							58623						
	MotorHomes with Ford E450 Chassis Max Control	8C2Z-18124-D 8C24-18045-DA ASH-1154 AT-163G					77614								
		8C24-18080-DB ASH-1136 8C2Z-18125-D AT-164G							77623						
	MotorHomes with Ford E450 Chassis Ultra Truck Shock	8C2Z-18124-D 8C24-18045-DA ASH-1154 AT-163G				G63622									
		8C24-18080-DB ASH-1136 8C2Z-18125-D AT-164G								G63623					

APPLICATION GUIDE

Year	Fitment Notes	OEM#								
			Fleetline\ Gas SLX	Classic\ Ultra\ ProGuard\ Guardian	Max Control\ LTV Severe Duty\ Load Carrier	Steering Dampers\ Steering Stabilizer\ Cab Shock	Fleetline\ Gas SLX	Classic\ Ultra\ ProGuard\ Guardian	Max Control\ LTV Severe Duty\ Load Carrier\ HiJackers	Steering Dampers\ Steering Stabilizer\ Cab Shock

HOLIDAY RAMBLER

HOLIDAY RAMBLER



ALTERA (cont)

18	MotorHomes with Ford E450 Chassis	8C2Z-18124-D 8C24-18045-DA ASH-1154 AT-163G	o		G63622	58622 77614				
		8C24-18080-DB ASH-1136 8C2Z-18125-D AT-164G	o					G63623	58623 77623	

ATLANTIS

09-10	MotorHomes with Ford E450 Chassis	8C2Z-18124-D 8C24-18045-DA ASH-1154 AT-163G	o		G63622	58622 77614					
		8C24-18080-DB ASH-1136 8C2Z-18125-D AT-164G	o					G63623	58623 77623		
08	MotorHomes with Ford E450 Chassis LTV Severe Duty	8C2Z-18124-D 8C24-18045-DA ASH-1154 AT-163G	o			58622					
		8C24-18080-DB ASH-1136 8C2Z-18125-D AT-164G	o					58623			
	MotorHomes with Ford E450 Chassis Max Control	8C2Z-18124-D 8C24-18045-DA ASH-1154 AT-163G	o				77614				
		8C24-18080-DB ASH-1136 8C2Z-18125-D AT-164G	o					77623			
07	MotorHomes with Ford E450 Chassis	8C2Z-18124-D 8C24-18045-DA ASH-1154 AT-163G	o		G63622	58622 77614					
		8C24-18080-DB ASH-1136 8C2Z-18125-D AT-164G	o					G63623	58623 77623		
06	MotorHomes with Ford E450 Chassis LTV Severe Duty	8C2Z-18124-D 8C24-18045-DA ASH-1154 AT-163G	o			58622					
		8C24-18080-DB ASH-1136 8C2Z-18125-D AT-164G	o					58623			
	MotorHomes with Ford E450 Chassis Max Control	8C2Z-18124-D 8C24-18045-DA ASH-1154 AT-163G	o				77614				
		8C24-18080-DB ASH-1136 8C2Z-18125-D AT-164G	o					77623			
	MotorHomes with Ford E450 Chassis Ultra Truck Shock	8C2Z-18124-D 8C24-18045-DA ASH-1154 AT-163G	o			G63622					
		8C24-18080-DB ASH-1136 8C2Z-18125-D AT-164G	o					G63623			

APPLICATION GUIDE

Year	Fitment Notes	OEM#								
			Fleetline/ Gas SLX	Classic/ Ultra/ ProGuard/ Guardian	Max Control/ LTV Severe Duty/ Load Carrier	Steering Dampers/ Steering Stabilizer/ Cab Shock	Fleetline/ Gas SLX	Classic/ Ultra/ ProGuard/ Guardian	Max Control/ LTV Severe Duty/ Load Carrier/ HiJackers	Steering Dampers/ Steering Stabilizer/ Cab Shock

HOLIDAY RAMBLER

HOLIDAY RAMBLER

ATLANTIS (cont)

02-05	MotorHomes with Ford E450 Chassis	8C2Z-18124-D 8C24-18045-DA ASH-1154 AT-163G	 O		G63622	58622 77614					
		8C24-18080-DB ASH-1136 8C2Z-18125-D AT-164G	 O						G63623	58623 77623	
99-01	MotorHomes with Ford E450 Chassis LTV Severe Duty	8C2Z-18124-D 8C24-18045-DA ASH-1154 AT-163G	 O			58622					
		8C24-18080-DB ASH-1136 8C2Z-18125-D AT-164G	 O						58623		
	MotorHomes with Ford E450 Chassis Max Control	8C2Z-18124-D 8C24-18045-DA ASH-1154 AT-163G	 O				77614				
		8C24-18080-DB ASH-1136 8C2Z-18125-D AT-164G	 O						77623		
MotorHomes with Ford E450 Chassis Ultra Truck Shock	8C2Z-18124-D 8C24-18045-DA ASH-1154 AT-163G	 O			G63622						
	8C24-18080-DB ASH-1136 8C2Z-18125-D AT-164G	 O						G63623			



AUGUSTA

19	MotorHomes with Ford E450 Chassis	8C2Z-18124-D 8C24-18045-DA ASH-1154 AT-163G	 O		G63622	58622 77614				
		8C24-18080-DB ASH-1136 8C2Z-18125-D AT-164G	 O						G63623	58623 77623
15-16	MotorHomes with Ford E450 Chassis	8C2Z-18124-D 8C24-18045-DA ASH-1154 AT-163G	 O		G63622	58622 77614				
		8C24-18080-DB ASH-1136 8C2Z-18125-D AT-164G	 O						G63623	58623 77623
11	MotorHomes with Ford E450 Chassis	8C2Z-18124-D 8C24-18045-DA ASH-1154 AT-163G	 O		G63622	58622 77614				
		8C24-18080-DB ASH-1136 8C2Z-18125-D AT-164G	 O						G63623	58623 77623
08-09	MotorHomes with Ford E450 Chassis	8C2Z-18124-D 8C24-18045-DA ASH-1154 AT-163G	 O		G63622	58622 77614				
		8C24-18080-DB ASH-1136 8C2Z-18125-D AT-164G	 O						G63623	58623 77623

AUGUSTA B+

12-13	MotorHomes with Ford E450 Chassis	8C2Z-18124-D 8C24-18045-DA ASH-1154 AT-163G	 O		G63622	58622 77614				
		8C24-18080-DB ASH-1136 8C2Z-18125-D AT-164G	 O						G63623	58623 77623

APPLICATION GUIDE

Year	Fitment Notes	OEM#								
			Fleetline\ Gas SLX	Classic\ Ultra\ ProGuard\ Guardian	Max Control\ LTV Severe Duty\ Load Carrier	Steering Dampers\ Steering Stabilizer\ Cab Shock	Fleetline\ Gas SLX	Classic\ Ultra\ ProGuard\ Guardian	Max Control\ LTV Severe Duty\ Load Carrier\ HiJackers	Steering Dampers\ Steering Stabilizer\ Cab Shock

HOLIDAY RAMBLER

AUGUSTA B+ (cont)

10	MotorHomes with Ford E450 Chassis	8C2Z-18124-D 8C24-18045-DA ASH-1154 AT-163G		G63622	58622 77614
		8C24-18080-DB ASH-1136 8C2Z-18125-D AT-164G		G63623	58623 77623
07	MotorHomes with Ford E450 Chassis	8C2Z-18124-D 8C24-18045-DA ASH-1154 AT-163G		G63622	58622 77614
		8C24-18080-DB ASH-1136 8C2Z-18125-D AT-164G		G63623	58623 77623

HOLIDAY RAMBLER

AUGUSTA LX

16	MotorHomes with Ford E450 Chassis	8C2Z-18124-D 8C24-18045-DA ASH-1154 AT-163G		G63622	58622 77614
		8C24-18080-DB ASH-1136 8C2Z-18125-D AT-164G		G63623	58623 77623

AUGUSTA SPORT

07-10	MotorHomes with Ford E350 Chassis	8C2Z-18124-D 8C24-18045-DA ASH-1154 AT-163G		G63622	58622 77614
		8C24-18080-DB ASH-1136 8C2Z-18125-D AT-164G		G63623	58623 77623



AUGUSTA TOURING SEDAN

07-09	MotorHomes with Ford E350 Chassis	8C2Z-18124-D 8C24-18045-DA ASH-1154 AT-163G		G63622	58622 77614
		8C24-18080-DB ASH-1136 8C2Z-18125-D AT-164G		G63623	58623 77623

CLASS A MOTORHOMES

04-11	Models with Workhorse W20 , W22, & W24 MotorHome Chassis with O.E.M. Number 85000 Series	W0005663 F4-BE5-F325-HO 24-153256			85124
98-11	Models with Workhorse W20 , W22, & W24 MotorHome Chassis with O.E.M. Number 85000 Series	24-153249 F4-BE5-B492-HO W0005662 W0006254 24153249 24-186629 F4-BE5-A832-MO F4-BE5-F324-HO		85125
00-03	Models with Roadmaster Chassis RM4C or used on Ambassador 83000 Series	01809924		83144
	Models with Roadmaster Chassis RM4C or used on Ambassador 85000 Series	01809923			85029
95-99	MotorHomes with Freightliner XC Chassis (22,000 to 26,000 lb GVW) 83000 Series		83160
	MotorHomes with Freightliner XC Chassis (22,000 to 26,000 lb GVW) 85000 Series		85029

APPLICATION GUIDE

Year	Fitment Notes	OEM#								
			Fleetline\ Gas SLX	Classic\ Ultra\ ProGuard\ Guardian	Max Control\ LTV Severe Duty\ Load Carrier	Steering Dampers\ Steering Stabilizer\ Cab Shock	Fleetline\ Gas SLX	Classic\ Ultra\ ProGuard\ Guardian	Max Control\ LTV Severe Duty\ Load Carrier\ HiJackers	Steering Dampers\ Steering Stabilizer\ Cab Shock

HOLIDAY RAMBLER

HOLIDAY RAMBLER



ECLIPSE

23-24	MotorHomes with Ford F53 Chassis with 16,000 lb GVW to 22,000 lb GVW	9U9Z-18124-A ASH-25822 ASH-25823 HU9Z-18124-B HU9Z-18124-C	OO	83209
		ASH-25824 9U9Z-18125-A HU9Z-18125-B	OO	83122 89406

ENDEAVOR

16-24	MotorHomes with Ford F53 Chassis with 16,000 lb GVW to 22,000 lb GVW	ASH-1229 ASH-1228 9U94-18045-AA ASH-1205 AT-620 ASH-1022 1C34-18045-AA ASH-294 9U9Z-18124-A ASH-25822 ASH-25823 1C34-18045-JA AT-766	OO	83209	
		ASH-1206 9U94-18080-AA AT-621 ASH-25824 9U9Z-18125-A ASH-1023 ASH-1230 ASH-137	OO	83122 89406
15	MotorHomes with Ford F53 Chassis with 16,000 lb GVW to 22,000 lb GVW 83000 Series	ASH-1229 ASH-1228 9U94-18045-AA ASH-1205 AT-620 ASH-1022 1C34-18045-AA ASH-294 9U9Z-18124-A ASH-25822 ASH-25823 1C34-18045-JA AT-766	OO	83209	
		ASH-1206 9U94-18080-AA AT-621 ASH-25824 9U9Z-18125-A ASH-1023 ASH-1230 ASH-137	OO	83122
	MotorHomes with Ford F53 Chassis with 16,000 lb GVW 89000 Series	ASH-1229 ASH-1228 9U94-18045-AA ASH-1205 AT-620 ASH-1022 1C34-18045-AA ASH-294 9U9Z-18124-A ASH-25822 ASH-25823 1C34-18045-JA AT-766	OO	89414
		ASH-1206 9U94-18080-AA AT-621 ASH-25824 9U9Z-18125-A ASH-1023 ASH-1230 ASH-137	OO	89406

APPLICATION GUIDE

Year	Fitment Notes	OEM#								
			Fleetline\ Gas SLX	Classic\ Ultra\ ProGuard\ Guardian	Max Control\ LTV Severe Duty\ Load Carrier	Steering Dampers\ Steering Stabilizer\ Cab Shock	Fleetline\ Gas SLX	Classic\ Ultra\ ProGuard\ Guardian	Max Control\ LTV Severe Duty\ Load Carrier\ HiJackers	Steering Dampers\ Steering Stabilizer\ Cab Shock

HOLIDAY RAMBLER

HOLIDAY RAMBLER

ENDEAVOR (cont)

00-14	MotorHomes with Ford F53 Chassis with 16,000 lb GVW to 22,000 lb GVW	ASH-1229 ASH-1228 9U94-18045-AA ASH-1205 AT-620 ASH-1022 1C34-18045-AA ASH-294 9U9Z-18124-A ASH-25822 ASH-25823 1C34-18045-JA AT-766	010	83209
		ASH-1206 9U94-18080-AA AT-621 ASH-25824 9U9Z-18125-A ASH-1023 ASH-1230 ASH-137	010	83122 89406
00-03	Models with Workhorse W22 Chassis with 8.1L Gas V8	01809925	010	85010



INVICTA

20-24	MotorHomes with Ford F53 Chassis with 24,000 lb GVW to 26,000 lb GVW	ASH-25821 ASH-1161	010	85006	
20-23	MotorHomes with Ford F53 Chassis with 24,000 lb GVW to 26,000 lb GVW	ASH-25820 ASH-1162	010	85005 89430

VACATIONER

11-24	MotorHomes with Ford F53 Chassis with 16,000 lb GVW to 22,000 lb GVW	ASH-1229 ASH-1228 9U94-18045-AA ASH-1205 AT-620 ASH-1022 1C34-18045-AA ASH-294 9U9Z-18124-A ASH-25822 ASH-25823 1C34-18045-JA AT-766	010	83209	
		ASH-1206 9U94-18080-AA AT-621 ASH-25824 9U9Z-18125-A ASH-1023 ASH-1230 ASH-137	010	83122 89406
	MotorHomes with Ford F53 Chassis with 24,000 lb GVW to 26,000 lb GVW	ASH-25821 ASH-1161	010	85006
11-23	MotorHomes with Ford F53 Chassis with 24,000 lb GVW to 26,000 lb GVW	ASH-25820 ASH-1162	010	85005 89430
09	MotorHomes with Ford F53 Chassis with 16,000 lb GVW to 22,000 lb GVW	ASH-1229 ASH-1228 9U94-18045-AA ASH-1205 AT-620 ASH-1022 1C34-18045-AA ASH-294 9U9Z-18124-A ASH-25822 ASH-25823 1C34-18045-JA AT-766	010	83209	
		ASH-1206 9U94-18080-AA AT-621 ASH-25824 9U9Z-18125-A ASH-1023 ASH-1230 ASH-137	010	83122 89406

APPLICATION GUIDE

Year	Fitment Notes	OEM#								
			Fleetline/ Gas SLX	Classic/ Ultra/ ProGuard/ Guardian	Max Control/ LTV Severe Duty/ Load Carrier	Steering Dampers/ Steering Stabilizer/ Cab Shock	Fleetline/ Gas SLX	Classic/ Ultra/ ProGuard/ Guardian	Max Control/ LTV Severe Duty/ Load Carrier/ HiJackers	Steering Dampers/ Steering Stabilizer/ Cab Shock

HOLIDAY RAMBLER

HOLIDAY RAMBLER

VACATIONER (cont)

09	MotorHomes with Ford F53 Chassis with 24,000 lb GVW to 26,000 lb GVW	ASH-25821 ASH-1161	O	85006
		ASH-25820 ASH-1162	O
00-07	MotorHomes with Ford F53 Chassis with 16,000 lb GVW to 22,000 lb GVW	ASH-1229 ASH-1228 9U94-18045-AA ASH-1205 AT-620 ASH-1022 1C34-18045-AA ASH-294 9U9Z-18124-A ASH-25822 ASH-25823 1C34-18045-JA AT-766	O	83209
		ASH-1206 9U94-18080-AA AT-621 ASH-25824 9U9Z-18125-A ASH-1023 ASH-1230 ASH-137	O
00-03	Models with Workhorse W22 Chassis with 8.1L Gas V8	01809925	O	85010

VARIOUS

	Models with Mor-Ryde Suspension Ultra Truck Shock	U0109-007	O
	Models with Neway Trailer Air Suspension 83000 Series	90044794	O

VESTA

17-18	MotorHomes with Ford E450 Chassis	8C2Z-18124-D 8C24-18045-DA ASH-1154 AT-163G	O	G63622	58622 77614
		8C24-18080-DB ASH-1136 8C2Z-18125-D AT-164G	O

IC CORPORATION

IC CORPORATION

CE SCHOOL BUS

10-23	CE Model School Buses (71 Capacity) with 9,000 to 10,000 lb Front Suspension	6127088C1 OE13402S 3578105C2 3578105C1	O	83163
	CE Model School Buses with 20,000 lb International IROS Air Suspension	6127713C2 3578858C2 6127713C1	O
20-21	CE Model School Buses with 17,000 lb - 22,000 lb rear suspension	4164142C1	O
13-18	CE Model School Buses with 6,000 to 8,000 lb Front Axles	3533356C3	O	83169
16-17	CE Model School Buses with 20,000 lb Rear Air Suspension	3601600C3	O
10-13	CE Model School Buses with 22,000 lb Rear Spring Suspension	501906C91 501906C92 OE13424S	O



INTERNATIONAL

INTERNATIONAL

4300

02-20	Models with 6,000 to 8,000 lb Front Suspension	3533356C1 3533356C2	O	83135
	Models with Hendrickson HAS - 230 or 460 Rear Air Suspension	60675-003 H60675-003 3514952C1 60675-003L 57905-001	O

APPLICATION GUIDE

Year	Fitment Notes	OEM#								
			Fleetline\ Gas SLX	Classic\ Ultra\ ProGuard\ Guardian	Max Control\ LTV Severe Duty\ Load Carrier	Steering Dampers\ Steering Stabilizer\ Cab Shock	Fleetline\ Gas SLX	Classic\ Ultra\ ProGuard\ Guardian	Max Control\ LTV Severe Duty\ Load Carrier\ HiJackers	Steering Dampers\ Steering Stabilizer\ Cab Shock

INTERNATIONAL

4300 (cont)

02-20	Models with O.E.M. Number	2509223C92 2509223C91 2509221C91	OIO	83054
02-15	Models with 12,000 lb Front axle	3533357C1 3533357C2 3533357C3	OIO	85957
02-13	Models with 22,000 lb Rear Spring Suspension	501906C91 501906C92 OE13424S	OIO	83317
08-09	Models with 9,000 to 10,000 lb Front Suspension	6127088C1 3578105C2	OIO	83163
	Models with International 40,000 lb Rear Air Suspension	3549099C2	OIO	85923 89458

INTERNATIONAL

4300LP

11-18	Models with O.E.M. Number	2509223C92 2509223C91 2509221C91	OIO	83054
13	Models with O.E.M. Number	1660846C92	OIO	83101
08-09	Models with O.E.M. Number	2509223C92 2509223C91 2509221C91	OIO	83054

4400

02-19	Models with 6,000 to 8,000 lb Front Suspension	3533356C1 3533356C2	OIO	83135
	Models with Hendrickson HAS - 230 or 460 Rear Air Suspension	60675-003 H60675-003 3514952C1 60675-003L 57905-001	OIO	85976
	Models with O.E.M. Number	2509223C92 2509223C91 2509221C91	OIO	83054
02-15	Models with 12,000 lb Front axle	3533357C1 3533357C2 3533357C3	OIO	85957
02-13	Models with 22,000 lb Rear Spring Suspension	501906C91 501906C92 OE13424S	OIO	83317
08-09	Models with 9,000 to 10,000 lb Front Suspension	6127088C1 3578105C2	OIO	83163
	Models with International 40,000 lb Rear Air Suspension	3549099C2	OIO	85923 89458

4400LP

19	Models with O.E.M. Number	2509223C92 2509223C91 2509221C91	OIO	83054
11	Models with O.E.M. Number	2509223C92 2509223C91 2509221C91	OIO	83054
03-09	Models with O.E.M. Number	2509223C92 2509223C91 2509221C91	OIO	83054



A, B, AC AND BC CONVENTIONAL

	AB-140 Models Ultra Truck Shock	OIO	G63306
	C-150 Models Ultra Truck Shock	OIO	G63306

BINDER

	Binder 83000 Series	453571C91	OIO	83216
	Binder 85000 Series	453556C91 471201C91 467983C91 467985C91	OIO	85012
	Binder 89000 Series	453556C91 471201C91 467983C91 467985C91	OIO	89413

APPLICATION GUIDE

Year	Fitment Notes	OEM#								
			Fleetline/ Gas SLX	Classic/ Ultra/ ProGuard/ Guardian	Max Control/ LTV Severe Duty/ Load Carrier	Steering Dampers/ Steering Stabilizer/ Cab Shock	Fleetline/ Gas SLX	Classic/ Ultra/ ProGuard/ Guardian	Max Control/ LTV Severe Duty/ Load Carrier/ HiJackers	Steering Dampers/ Steering Stabilizer/ Cab Shock

INTERNATIONAL CARGOSTAR



INTERNATIONAL

	CO-1600, CO-1610A & B, CO-1630A & B, CO-1700, CO-1710A & B, CO-1730A & B, CO-1750, CO-1750A & B, CO-1800, CO-1810A & B, CO-1830A & B, CO-1850, and CO-1850A & B 83000 Series	453567C91 467984C91 294334C91 308650C92 206621R92 206620R91 453570C91 3085640C92 308649C91			83216
	CO-1600, CO-1610A & B, CO-1630A & B, CO-1700, CO-1710A & B, CO-1730A & B, CO-1750, CO-1750A & B, CO-1800, CO-1810A & B, CO-1830A & B, CO-1850, and CO-1850A & B 85000 Series	467983C91 360444C91 308646C91 453564C91			85012
	CO-1600, CO-1610A & B, CO-1630A & B, CO-1700, CO-1710A & B, CO-1730A & B, CO-1750, CO-1750A & B, CO-1800, CO-1810A & B, CO-1830A & B, CO-1850, and CO-1850A & B 89000 Series	467983C91 360444C91 308646C91 453564C91			89413
	CO-1610A & B, CO-1630A & B, CO-1710A & B, CO-1730A & B, CO-1750A & B, CO-1810A & B, CO-1830A & B, COF-1810A & B - Exc. with 9000, 10800, or 12000 lb Front Axle 83000 Series	453572C91		83309
	CO-1610A & B, CO-1630A & B, CO-1710A & B, CO-1730A & B, CO-1750A & B, CO-1810A & B, CO-1830A & B, COF-1810A & B - With 9000, 10800, or 12000 lb Front Axle 83000 Series	873619C93 873619C92		83314
	CO-190, VCO-190, CO-200, DCO-200, VCO-200, CO-220, VCO-220 With Air Ride Suspension before Chassis No G-387453 85000 Series	350426C91			85734
	CO-190, COF-190, CO-1950, COF-1950 & COT-1950, VCO-190, VCOF-190 & CO-200, DCO-200, VCO-200 & CO-220, VCO-220 & VCO-190 (4 man cab) 83000 Series	204994R91		83225
	CO-190, COF-190, VCO-190, VCOF-190 & CO-200, DCO-200, VCO-200 & CO-220, VCO-220 & VCO-190 (4 man cab) 83000 Series	467372C91 467371C91 453569C91 308648C91 452566C91 453562C91 210534R92 453565C91 288921R92 288920C91 453561C91		83225
	CO-1910A & B, CO-1950A & B, COF-1910A & B, COF-1950A & B 83000 Series	453572C91		83309
		873619C92		83314
	CO-1950, COF-1950 & COT-1950 83000 Series	467372C91 467371C91 453569C91 308648C91 453565C91 288921C91 288920C91 453561C91 453566C91		83225
	CO-1950 with Air Ride Suspension Before Chassis No. G-387453 85000 Series	350426C1			85734

CV515

24	Models with 11K, 13.5K or 15.5K VARI-RATE Rear Suspension 83000 Series	4208946C1 4206863C1			83398
----	--	------------------------	--	------	------	------	------	--	-------	------	------	------

APPLICATION GUIDE

Year	Fitment Notes	OEM#								
			Fleetline\ Gas SLX	Classic\ Ultra\ ProGuard\ Guardian	Max Control\ LTV Severe Duty\ Load Carrier	Steering Dampers\ Steering Stabilizer\ Cab Shock	Fleetline\ Gas SLX	Classic\ Ultra\ ProGuard\ Guardian	Max Control\ LTV Severe Duty\ Load Carrier\ HiJackers	Steering Dampers\ Steering Stabilizer\ Cab Shock

INTERNATIONAL CV515 (cont)

INTERNATIONAL

24	Models with Taperleaf Front 83000 Series	4109582C1 4089293C1 4109583C1 4207304C1	OIO	83397						
19-22	Models with 11K, 13.5K or 15.5K VARI-RATE Rear Suspension	4208946C1 4206863C1		OIO	83398
	Models with 4 x 4 Rear	4109458C2		OIO	83243
	Models with IROS Rear	4214011C2		OIO	85670
	Models with Taperleaf Front	4109582C1 4089293C1 4109583C1 4207304C1	OIO	83397

DURASTAR

16-20	Models with 10,500 or 13,500 lb Vari-Rate Rear Spring Suspension	6127087C1 3586902C2 3586902C3		OIO	83364
	Models with 11,000 lb to 14,000 lb Front axle	6127714C1	OIO	85928
15-20	Models with 6,000 to 8,000 lb Front Suspension	6127688C1 3533356C3	OIO	83169
	Models with Hendrickson HAS - 230 or 460 Rear Air Suspension	60675-003 H60675-003 3514952C1 60675-003L 57905-001		OIO	85976
	Models with O.E.M. Number	2509223C92 2509223C91 2509221C91	OIO	83054	
16-19	Models with 20,000 lb International IROS Air Suspension	6127713C1		OIO	85656
15-19	Models with 9,000 to 10,000 lb Front Suspension	6127088C1 OE13402S 3578105C2 3578105C1	OIO	83163
16-17	Models with Vari-Rate Rear Spring Suspension	6127700C1		OIO	83395
15	Models with 12,000 lb Front axle	3533357C1 3533357C2 3533357C3	OIO	85957
13	Models with 12,000 lb Front axle	3533357C1 3533357C2 3533357C3	OIO	85957
	Models with 22,000 lb Rear Spring Suspension	501906C91 501906C92 OE13424S		OIO	83317
	Models with 6,000 to 8,000 lb Front Suspension	6127688C1 3533356C3	OIO	83169
	Models with 9,000 to 10,000 lb Front Suspension	6127088C1 OE13402S 3578105C2 3578105C1	OIO	83163
	Models with Hendrickson HAS - 230 or 460 Rear Air Suspension	60675-003 H60675-003 3514952C1 60675-003L 57905-001		OIO	85976
	Models with O.E.M. Number	2509223C92 2509223C91 2509221C91	OIO	83054	



DURASTAR - 1000 SERIES

1300 Models Ultra Truck Shock	66400 56110-T8123 56110-T8129	OIO	G63432						
-------------------------------	-------------------------------------	-----	------	--------	------	------	------	--	--	--	--	--	--

DURASTAR - 4300, 4400 SERIES

Models with 20,000 lb International IROS Air Suspension To 2015 85000 Series	3578858C1 3578858C2	OIO						
--	------------------------	-----	------	------	------	------	------	--	--	--	--	--	--

APPLICATION GUIDE

Year	Fitment Notes	OEM#								
			Fleetline/ Gas SLX	Classic/ Ultra/ ProGuard/ Guardian	Max Control/ LTV Severe Duty/ Load Carrier	Steering Dampers/ Steering Stabilizer/ Cab Shock	Fleetline/ Gas SLX	Classic/ Ultra/ ProGuard/ Guardian	Max Control/ LTV Severe Duty/ Load Carrier/ HiJackers	Steering Dampers/ Steering Stabilizer/ Cab Shock

INTERNATIONAL

DURASTAR - 4300, 4400 SERIES (cont)

	Models with International IROS Air Suspension 85000 Series	3553628C1 3553628C2 3553628C3 3553628C4	O	85927	O	85927
	Models with O.E.M. Number 85000 Series	6127690C1	O	85923	O	85923
	Models with O.E.M. Number 89000 Series	6127690C1	O	89458	O	89458
16-20	Models with 11,000 lb to 14,000 lb Front axle 85000 Series	6127714C1	O	85928	O	85928
16-19	Models with 20,000 lb International IROS Air Suspension 85000 Series	6127713C1	O	85656	O	85656
13-18	Models with 6,000 to 8,000 lb Front Suspension 83000 Series	6127688C1 3533356C3	O	83169	O	83169
10-15	Models with 12,000 lb Front axle 85000 Series	3533357C1 3533357C2 3533357C3	O	85957	O	85957
10-12	Models with 6,000 to 8,000 lb Front Suspension 83000 Series	3533356C1 3533356C2	O	83135	O	83135
	School Bus models with 6,000 to 8,000 lb Front Suspension 83000 Series	3533356C1 3533356C2	O	83135	O	83135
10-11	Models with 40,000 lb Rear Air Suspension 85000 Series	3549099C2	O	85923	O	85923
	Models with 40,000 lb Rear Air Suspension 89000 Series	3549099C2	O	89458	O	89458

INTERNATIONAL

EMV607

23	Models with 12,000 lb Parabolic Taper Leaf Springs 85000 Series	6127714C1	O	85928	O	85928
----	---	-----------	---	-------	------	------	------	---	-------	------	------	------

M800

68-71	Single System Steering Stabilizer; 1/2 & 3/4 Ton with I-Beam Axle		O	6802SE ⁸⁴							
-------	---	--	---	----------------------	--	--	--	--	--	--	--

M1100 / M1200

68-72	All		O	81318 82007	O	61500 81147 G63405	43048 ⁸ 49310 ⁷
	Single System Steering Stabilizer; 1/2 & 3/4 Ton with I-Beam Axle		O	6802SE ⁸⁴								

M1400

69	All		O	82007	O	61500 81147 G63405	43048 ⁸ 49310 ⁷
	Single System Steering Stabilizer; 1/2 & 3/4 Ton with I-Beam Axle		O	6802SE ⁸⁴								

METRO & MULTI-SHOP SERIES



73-75	Multi-Stop Models MS-1210 & 1510 Ultra Truck Shock		O	O	G63306
66-72	Metro Models M1200 with 14016 Reg. Rear Springs & with 14020 Rear Axle Code Ultra Truck Shock		O	G63306	O
	Metro Models M1200 with Axle Code 0208 & Frame Code 01000.0962 Ultra Truck Shock		O	G63306	O
	Metro Models M700, 800, 900-U, 1000, 1100, Ultra Truck Shock		O	G63306	O

7 Pair Packs, Air hose kit included.;

8 Pair Packs.;

162 84 Replacement damper for vehicles with the Gabriel Aftermarket mounting kit;

APPLICATION GUIDE

Year	Fitment Notes	OEM#								
			Fleetline\ Gas SLX	Classic\ Ultra\ ProGuard\ Guardian	Max Control\ LTV Severe Duty\ Load Carrier	Steering Dampers\ Steering Stabilizer\ Cab Shock	Fleetline\ Gas SLX	Classic\ Ultra\ ProGuard\ Guardian	Max Control\ LTV Severe Duty\ Load Carrier\ HiJackers	Steering Dampers\ Steering Stabilizer\ Cab Shock

INTERNATIONAL

INTERNATIONAL

MV

20	Models with 20,000 lb International IROS Air Suspension	6127713C2		010	85656
	Models with 9,000 to 10,000 lb Front Suspension	6127088C1	010	83163
	Models with Hendrickson HAS - 230 or 460 Rear Air Suspension	60675-003 H60675-003 3514952C1 60675-003L		010	85976

MV607

20-22	Models with 20,000 lb International IROS Air Suspension	6127713C2		010	85656
19-22	Models with 11,000 lb to 14,000 lb Taper-leaf Springs	6127714C1	010	85928
	Models with 6,000 to 8,000 lb Front Suspension	4164146C1 6127688C1	010	83169
	Models with 9,000 to 10,000 lb Front Suspension	6127088C1	010	83163
	Models with Hendrickson HAS - 230 or 460 Rear Air Suspension	60675-003 H60675-003 3514952C1 60675-003L		010	85976
	Models with International 21,000 lb Rear Air Suspension	6127666C1		010	85642

SERIES 1000 FORWARD CONTROL CHASSIS

	1654 LP Models (Low Profile Vehicle) 83000 Series	1660846C91 1660846C92		010	83101
--	---	--------------------------	--	------	------	------	------	-----	-------	------	------	------

SERIES 4000 - SHORT CONVENTIONAL MEDIUM TRK & TRAC

	4600, 4700, 4800, 4900 Models 83000 Series	586724C91	I	83456
	4600, 4700, 4800, 4900 Models 89000 Series	586724C91	I	89447
	4600, 4700, 4800, 4900 Models with 10000 lb Front Axle 83000 Series	472412C91	I	83456
	4600, 4700, 4800, 4900 Models with 10000 lb Front Axle 89000 Series	472412C91	I	89447
	F-4900 Models with Hendrickson HN - 400 Models Rear suspension 83000 Series	3515265C1 3515265C2 60680-003L 60680-003 H60680-003		010	83112
90-02	F-4900 Models with 10000 lb Front Axle 83000 Series	472412C91	I	83456
	F-4900 Models with 10000 lb Front Axle 89000 Series	472412C91	I	89447

TERRASTAR

	Models with International IROS Air Suspension 89000 Series	3892445C3		010	89458
12-18	Models with 10,500 or 13,500 lb Vari-Rate Rear Spring Suspension	6127087C1 3586902C2 3586902C3		010	83364
	Models with 6,000 to 7,000 lb Front Axle	3989717C1 3991991C1 OE 18513 3902993C1 3902993C3 OE17103	010	83135
14	4 WD Models with Rear Spring Suspension	6127096C1 3945165C1		010	83180

ISUZU

ISUZU

ADDITIONAL APPLICATIONS

85	KS22 Models (All) 83000 Series	8-97083-027-0	010	83515
----	--------------------------------	---------------	-----	-------	------	------	------	--	------	------	------	------

APPLICATION GUIDE

Year	Fitment Notes	OEM#								
			Fleetline/ Gas SLX	Classic/ Ultra/ ProGuard/ Guardian	Max Control/ LTV Severe Duty/ Load Carrier	Steering Dampers/ Steering Stabilizer/ Cab Shock	Fleetline/ Gas SLX	Classic/ Ultra/ ProGuard/ Guardian	Max Control/ LTV Severe Duty/ Load Carrier/ HiJackers	Steering Dampers/ Steering Stabilizer/ Cab Shock

ISUZU

ISUZU

ADDITIONAL APPLICATIONS (cont)

85	KS22 Models (All) 85000 Series	9-51630-666-2 9-51630-666-0			85012
	KS22 Models (All) 89000 Series	9-51630-666-2 9-51630-666-0			89413

ALL MODELS WITH

87-93	Models with O.E.M. Number 83000 Series	8-97253-623-0 8-97253-621-0 8-97253-616-0 898098-1270		83515
-------	--	--	--	-------	------	------	------	--	------	------	------	------

EVR

87-93	EVR Models	1-51630-160-0		83162
-------	------------	---------------	--	-------	------	------	------	--	------	------	------	------

FRR

00-04	All	1-51630-219-1 1-51630-219-0 51630219		83114
95-98	All	1-51630-219-1 1-51630-219-0 51630219		83114



FSR

97-02	Models with 15000, 19000, 21000 lb Multileaf Springs	8-22064232-0			85071
	Models with 19000, 21000, 23000 lb Taperleaf Springs (EXC Low Profile Veh.)	8-22064233-0			83136
	Models with FL1 Tilt Cab with 8100 lb Axle (Including Low Profile)	8-22064804-0 8-22064805-0		83136
87-96	FSR Models	1-51630-217-1		83114
		1-51630-167-0			83613
87-92	FSR Models	1-51630-160-0		83162
		51630168 1-51630-168-1		83515
86	Models with O.E.M. Number 83000 Series	1-51630-217-1		83114
		1-51630-160-0		83162
		51630168 1-51630-168-1		83515

FTR

20-24	Models with Hendrickson Comfort Air (Single Axle - 21K & 23K)	60670-018 60670-030L 60670-030 48530-E0290 60670-018L			83166
18-24	Models with Hendrickson HAS suspension	8-97517-966-1 60670-005 60670-005L 8-97517-966-0			83137
18-20	FTR Diesel Models with Std Cab	8-98321-912-1		85071
00-11	Models with Hendrickson HAS suspension	8-97517-966-1 60670-005 60670-005L 8-97517-966-0			83137
05-09	Models with O.E.M. Number	98098127 8-98232672-0 8-98098-127-0		83515
		98098059 8-98098-059-0 8-98098-059-1 8-98316-228-0			83159
97-09	Models with 19000, 21000, 23000 lb Taperleaf Springs (EXC Low Profile Veh.)	8-22064233-0			83136

APPLICATION GUIDE

Year	Fitment Notes	OEM#								
			Fleetline\ Gas SLX	Classic\ Ultra\ ProGuard\ Guardian	Max Control\ LTV Severe Duty\ Load Carrier	Steering Dampers\ Steering Stabilizer\ Cab Shock	Fleetline\ Gas SLX	Classic\ Ultra\ ProGuard\ Guardian	Max Control\ LTV Severe Duty\ Load Carrier\ HiJackers	Steering Dampers\ Steering Stabilizer\ Cab Shock

ISUZU

ISUZU

FTR (cont)

90-09	Models with 15000, 19000, 21000 lb Multileaf Springs	15174902 8-22064232-0 88982686			85071
	Models with O.E.M. Number	88982682 8-22064-806-0 8-22064-807-0 15123676		83136
88-96	Models with O.E.M. Number	1-51630-167-0			83613



FVR

	Models with Hendrickson HAS suspension 83000 Series	12474915			83122
	Models with Hendrickson HAS suspension 89000 Series	12474915			89406
10-11	Models with Hendrickson HAS suspension	8-97517-966-1 60670-005 60670-005L 8-97517-966-0			83137
00-08	Models with Hendrickson HAS suspension	8-97517-966-1 60670-005 60670-005L 8-97517-966-0			83137
97-08	Models with 19000, 21000, 23000 lb Taperleaf Springs (EXC Low Profile Veh.)	8-22064233-0			83136
	Models with O.E.M. Number	88982682 15887728 8-22064-806-0 8-22064-807-0 19152843		83136
94-08	Models with 15000, 19000, 21000 lb Multileaf Springs	8-22064232-0 88982686			85071
94-96	FVR Short & Middle Chassis	1-51630-160-0		83162
	Models with O.E.M. Number	1-51630-167-0			83613
90-92	Models with 15000, 19000, 21000 lb Multileaf Springs	8-22064232-0 88982686			85071
88-92	FVR Short & Middle Chassis	1-51630-160-0		83162
	Models with O.E.M. Number	1-51630-167-0			83613

NPR

95-20	Models with O.E.M. Number	98098059 8-97253-665-0 98098058 8-97253-651-2 8-97253-664-0 97253664 98316227 97253665 97253651 8-98098-058-0 8-98098-058-1 8-98098-059-0 8-98098-059-1 8-98316227-0 8-98316-228-0			83159
-------	---------------------------	--	--	------	------	------	------	--	-------	------	------	------

APPLICATION GUIDE

Year	Fitment Notes	OEM#								
			Fleetline/ Gas SLX	Classic/ Ultra/ ProGuard/ Guardian	Max Control/ LTV Severe Duty/ Load Carrier	Steering Dampers/ Steering Stabilizer/ Cab Shock	Fleetline/ Gas SLX	Classic/ Ultra/ ProGuard/ Guardian	Max Control/ LTV Severe Duty/ Load Carrier/ HiJackers	Steering Dampers/ Steering Stabilizer/ Cab Shock

ISUZU

ISUZU



NPR (cont)

86-20	Models with O.E.M. Number	8-97253-620-1 98098125 8-98381-012-0 97083029 94454987 98232671 8-98381-010-0 97083027 8-98232671-1 8-98232671-0 97253620 8-94454-647-1 8-97253-620-0 8-98098-125-0 8-97083-027-0 9-51630-647-1 8-97083-029-0 51630647 94454986 8-94454-986-0 8-94454-987-0	 O	83515
86-95	All	9-51630-666-2 51630666 9-51630-666-0		OO	85012 89413
84-85	Models with O.E.M. Number 83000 Series	8-97253-620-1 98098125 8-98381-012-0 97083029 94454987 98232671 8-98381-010-0 97083027 8-98232671-1 8-98232671-0 97253620 8-94454-647-1 8-97253-620-0 8-98098-125-0 8-97083-027-0 9-51630-647-1 8-97083-029-0 51630647 94454986 8-94454-986-0 8-94454-987-0	 O	83515

NPR-HD

20-23	Models with 14,000 to 15,000 lb Rear	8-98380-746-0		OO	83159
	Models with 15,000 to 16,000 lb Rear	8-98380-747-0		OO	83159
03-23	Models with O.E.M. Number	98098059 8-97253-665-0 98098058 8-98098-058-0 8-98098-058-1 8-98098-059-0 8-98098-059-1 8-98316227-0 8-98316-228-0 98316227 97253665		OO	83159
99-23	Models with O.E.M. Number	8-97253-620-1 98098125 8-98381-012-0 97083029 94454987 98232671 8-98381-010-0 97083027 8-98232671-1 8-98232671-0 97253620 8-94454-647-1 8-97253-620-0 8-98098-125-0 8-97083-027-0 9-51630-647-1 8-97083-029-0 51630647 94454986 8-94454-986-0 8-94454-987-0	 O	83515

APPLICATION GUIDE

Year	Fitment Notes	OEM#								
			Fleetline\ Gas SLX	Classic\ Ultra\ ProGuard\ Guardian	Max Control\ LTV Severe Duty\ Load Carrier	Steering Dampers\ Steering Stabilizer\ Cab Shock	Fleetline\ Gas SLX	Classic\ Ultra\ ProGuard\ Guardian	Max Control\ LTV Severe Duty\ Load Carrier\ HiJackers	Steering Dampers\ Steering Stabilizer\ Cab Shock

ISUZU

ISUZU

NPR-XD

23	Models with 14,000 to 15,000 lb GVW 83000 Series	8-98381-010-0	 O	83515	
		8-98380-746-0	 O
	Models with 15,000 to 16,000 lb GVW 83000 Series	8-98381-012-0	 O	83515
		8-98380-747-0	 O
15-22	Models with 14,000 to 15,000 lb GVW	8-98381-010-0	 O	83515	
		8-98380-746-0	 O	
	Models with 15,000 to 16,000 lb GVW	8-98381-012-0	 O	83515
		8-98380-747-0	 O



NQR

20-23	Models with 15,000 to 16,000 lb Rear	8-98380-747-0	 O
94-23	Models with O.E.M. Number	8-97253-620-1	 O	83515
		98098125										
		8-98381-012-0										
		97083029										
		94454987										
		98232671										
		8-98381-010-0										
		97083027										
		8-98232671-1										
		8-98232671-0										
		97253620										
		8-94454-647-1										
		8-97253-620-0										
8-98098-125-0												
8-97083-027-0												
9-51630-647-1												
8-97083-029-0												
51630647												
94454986												
8-94454-986-0												
8-94454-987-0												
03-19	Models with O.E.M. Number	98098059	 O
		8-97253-665-0										
		8-98098-059-0										
		8-98098-059-1										
		8-98343986-0										
		8-98316-228-0										
97253665												
98343986												
02	Diesel	8-97253-664-0	 O
95-97	Diesel	8-97253-664-0	 O

NRR

20-23	Models with 15,000 to 16,000 lb Rear	8-98380-747-0	 O
05-23	Models with O.E.M. Number	8-97253-620-1	 O	83515
		98098125										
		8-98381-012-0										
		97083029										
		94454987										
		98232671										
		8-98381-010-0										
		97083027										
		8-98232671-1										
		8-98232671-0										
		97253620										
		8-94454-647-1										
		8-97253-620-0										
8-98098-125-0												
8-97083-027-0												
9-51630-647-1												
8-97083-029-0												
51630647												
94454986												
8-94454-986-0												
8-94454-987-0												

APPLICATION GUIDE

Year	Fitment Notes	OEM#								
			Fleetline/ Gas SLX	Classic/ Ultra/ ProGuard/ Guardian	Max Control/ LTV Severe Duty/ Load Carrier	Steering Dampers/ Steering Stabilizer/ Cab Shock	Fleetline/ Gas SLX	Classic/ Ultra/ ProGuard/ Guardian	Max Control/ LTV Severe Duty/ Load Carrier/ HiJackers	Steering Dampers/ Steering Stabilizer/ Cab Shock

ISUZU

ISUZU

NRR (cont)

05-19	Models with O.E.M. Number	98098059 8-97253-665-0 8-98098-059-0 8-98098-059-1 8-98343986-0 8-98316-228-0 97253665 98343986			83159
88-94	All	1-51630-219-1 1-51630-217-1 1-51630-217-0 51630217	 O	83114
	Models with O.E.M. Number	8-97253-620-1 98098125 8-98381-012-0 97083029 94454987 98232671 8-98381-010-0 97083027 8-98232671-1 8-98232671-0 97253620 8-94454-647-1 8-97253-620-0 8-98098-125-0 8-97083-027-0 9-51630-647-1 8-97083-029-0 51630647 94454986 8-94454-986-0 8-94454-987-0	 O	83515

REACH

11-15	Models with O.E.M. Number	8-98381-010-0		83515
		8-98380-746-0	 O	 O	83159



ITASCA

ITASCA

CLASS A MOTORHOMES

	Models with Workhorse UFO Chassis with Hendrickson Softek Front Suspension 83000 Series	66153-002 F4-BE5-C832-MO		83124
	Models with Workhorse UFO Chassis with Hendrickson Softek Front Suspension 89000 Series	66153-002 F4-BE5-C832-MO	 O	89407	 O
99-15	SunCruiser Series MotorHomes with Ford F53 Chassis with 16,000 lb GVW to 22,000 lb GVW 83000 Series	ASH-1229 ASH-1228 9U94-18045-AA ASH-1205 AT-620 ASH-1022 1C34-18045-AA ASH-294 9U9Z-18124-A ASH-25822 ASH-25823 1C34-18045-JA AT-766	 O	83209
		ASH-1206 9U94-18080-AA AT-621 ASH-25824 9U9Z-18125-A ASH-1023 ASH-1230 ASH-137	 O	 O	83122

APPLICATION GUIDE

Year	Fitment Notes	OEM#								
			Fleetline\ Gas SLX	Classic\ Ultra\ ProGuard\ Guardian	Max Control\ LTV Severe Duty\ Load Carrier	Steering Dampers\ Steering Stabilizer\ Cab Shock	Fleetline\ Gas SLX	Classic\ Ultra\ ProGuard\ Guardian	Max Control\ LTV Severe Duty\ Load Carrier\ HiJackers	Steering Dampers\ Steering Stabilizer\ Cab Shock



ITASCA

ITASCA

CLASS A MOTORHOMES (cont)

99-15	SunCruiser Series MotorHomes with Ford F53 Chassis with 16,000 lb GVW to 22,000 lb GVW 89000 Series	ASH-1229 ASH-1228 9U94-18045-AA ASH-1205 AT-620 ASH-1022 1C34-18045-AA ASH-294 9U9Z-18124-A ASH-25822 ASH-25823 1C34-18045-JA AT-766	oio	89414
		ASH-1206 9U94-18080-AA AT-621 ASH-25824 9U9Z-18125-A ASH-1023 ASH-1230 ASH-137	oio	89406
05-11	SunCruiser Series MotorHomes with W20 , W22, & W24 Workhorse Chassis 85000 Series	24-186629	oio	85125
04-11	Sunova Models with W20 , W22, & W24 WorkHorse MotorHome Chassis 85000 Series	W0005663 F4-BE5-F325-HO 24-153256	oio	85124
98-11	Sunova Models with W20 , W22, & W24 WorkHorse MotorHome Chassis 85000 Series	24-153249 W0005662 W0006254 24153249 F4-BE5-A832-MO F4-BE5-F324-HO	oio	85125
04-06	Horizon Series MotorHomes with Freightliner XC Chassis ADL200 Suspension w/ 20K Rear 85000 Series	16-16873-000	oio	85029
	Horizon Series MotorHomes with Freightliner XC Chassis AS120 Front Suspension 83000 Series	16-16874-000 16-16737-000 141700131810	oio	83160
	Horizon Series MotorHomes with Freightliner XC Chassis Rear Shock with O.E.M. Number 85000 Series	141700131809 16-16736-000	oio	85029
	Horizon Series MotorHomes with Freightliner XC Chassis ZF - IFS Front Suspension with 23,000 lb GVW or Greater 85000 Series	16-18103-000 481700000493	oio	85900
02-06	Meridian Series MotorHomes with Freightliner XC Chassis ADL200 Suspension w/ 20K Rear 85000 Series	16-16873-000	oio	85029
	Meridian Series MotorHomes with Freightliner XC Chassis AS120 Front Suspension 83000 Series	16-16874-000 16-16737-000 141700131810	oio	83160
	Meridian Series MotorHomes with Freightliner XC Chassis Rear Shock with O.E.M. Number 85000 Series	141700131809 16-16736-000	oio	85029
	Meridian Series MotorHomes with Freightliner XC Chassis ZF - IFS Front Suspension with 23,000 lb GVW or Greater 85000 Series	16-18103-000 481700000493	oio	85900
06	Ellipse Series MotorHomes with Freightliner XC Chassis ADL200 Suspension w/ 20K Rear 85000 Series	16-16873-000	oio	85029
	Ellipse Series MotorHomes with Freightliner XC Chassis AS120 Front Suspension 83000 Series	16-16874-000 16-16737-000 141700131810	oio	83160
	Ellipse Series MotorHomes with Freightliner XC Chassis Rear Shock with O.E.M. Number 85000 Series	141700131809 16-16736-000	oio	85029
	Ellipse Series MotorHomes with Freightliner XC Chassis ZF - IFS Front Suspension with 23,000 lb GVW or Greater 85000 Series	16-18103-000 481700000493	oio	85900

APPLICATION GUIDE

Year	Fitment Notes	OEM#								
			Fleetline/ Gas SLX	Classic/ Ultra/ ProGuard/ Guardian	Max Control/ LTV Severe Duty/ Load Carrier	Steering Dampers/ Steering Stabilizer/ Cab Shock	Fleetline/ Gas SLX	Classic/ Ultra/ ProGuard/ Guardian	Max Control/ LTV Severe Duty/ Load Carrier/ HiJackers	Steering Dampers/ Steering Stabilizer/ Cab Shock

ITASCA

ITASCA



CLASS A MOTORHOMES (cont)

03-04	SunCruiser Series MotorHomes with W20 , W22, & W24 Workhorse Chassis 85000 Series	24-153249 F4-BE5-B492-HO W0005662 W0006254 24-186629 F4-BE5-A832-MO F4-BE5-F324-HO	O O	85125
98-02	SunCruiser Series MotorHomes with W20 , W22, & W24 Workhorse Chassis 85000 Series	24-186629	O O	85125

CLASS C MOTORHOMES

06-20	Cambria Series Motorhomes with Ford E450 Chassis LTV Severe Duty	8C2Z-18124-D 8C24-18045-DA ASH-1154 AT-163G	I O	58622
		8C24-18080-DB ASH-1136 8C2Z-18125-D AT-164G	I O	58623
	Cambria Series Motorhomes with Ford E450 Chassis Max Control	8C2Z-18124-D 8C24-18045-DA ASH-1154 AT-163G	I O	77614
		8C24-18080-DB ASH-1136 8C2Z-18125-D AT-164G	I O	77623
	Cambria Series Motorhomes with Ford E450 Chassis Ultra Truck Shock	8C2Z-18124-D 8C24-18045-DA ASH-1154 AT-163G	I O	G63622
		8C24-18080-DB ASH-1136 8C2Z-18125-D AT-164G	I O	G63623
01-20	Spirit Series Motorhomes with Ford E450 Chassis LTV Severe Duty	8C2Z-18124-D 8C24-18045-DA ASH-1154 AT-163G	I O	58622
		8C24-18080-DB ASH-1136 8C2Z-18125-D AT-164G	I O	58623
	Spirit Series Motorhomes with Ford E450 Chassis Max Control	8C2Z-18124-D 8C24-18045-DA ASH-1154 AT-163G	I O	77614
		8C24-18080-DB ASH-1136 8C2Z-18125-D AT-164G	I O	77623
	Spirit Series Motorhomes with Ford E450 Chassis Ultra Truck Shock	8C2Z-18124-D 8C24-18045-DA ASH-1154 AT-163G	I O	G63622
		8C24-18080-DB ASH-1136 8C2Z-18125-D AT-164G	I O	G63623
07-14	Impulse Series Motorhomes with Ford E450 Chassis LTV Severe Duty	8C2Z-18124-D 8C24-18045-DA ASH-1154 AT-163G	I O	58622
		8C24-18080-DB ASH-1136 8C2Z-18125-D AT-164G	I O	58623
	Impulse Series Motorhomes with Ford E450 Chassis Max Control	8C2Z-18124-D 8C24-18045-DA ASH-1154 AT-163G	I O	77614
		8C24-18080-DB ASH-1136 8C2Z-18125-D AT-164G	I O	77623

APPLICATION GUIDE

Year	Fitment Notes	OEM#								
			Fleetline\ Gas SLX	Classic\ Ultra\ ProGuard\ Guardian	Max Control\ LTV Severe Duty\ Load Carrier	Steering Dampers\ Steering Stabilizer\ Cab Shock	Fleetline\ Gas SLX	Classic\ Ultra\ ProGuard\ Guardian	Max Control\ LTV Severe Duty\ Load Carrier\ HiJackers	Steering Dampers\ Steering Stabilizer\ Cab Shock

ITASCA

ITASCA

CLASS C MOTORHOMES (cont)

07-14	Impulse Series Motorhomes with Ford E450 Chassis Ultra Truck Shock	8C2Z-18124-D 8C24-18045-DA ASH-1154 AT-163G	OI	G63622
		8C24-18080-DB ASH-1136 8C2Z-18125-D AT-164G	OI	G63623

JAYCO

JAYCO

ALANTE

16-24	MotorHomes with Ford F53 Chassis with 16,000 lb GVW to 22,000 lb GVW	ASH-1229 ASH-1228 9U94-18045-AA ASH-1205 AT-620 ASH-1022 1C34-18045-AA ASH-294 9U9Z-18124-A ASH-25822 ASH-25823 1C34-18045-JA AT-766	OI	83209
		ASH-1206 9U94-18080-AA AT-621 ASH-25824 9U9Z-18125-A ASH-1023 ASH-1230 ASH-137	OI	83122 89406

CLASS A MOTORHOMES

15-20	Alante Series MotorHomes with Ford F53 Chassis with 16,000 lb GVW to 22,000 lb GVW 89000 Series	ASH-1229 ASH-25822 ASH-25823	OI	89414
		ASH-25824	OI	89406
14-20	Precept Series MotorHomes with Ford F53 Chassis with 16,000 lb GVW to 22,000 lb GVW 89000 Series	ASH-1229 ASH-25822 ASH-25823	OI	89414
		ASH-25824	OI	89406

ESCAPADE

03-06	MotorHomes with Ford E350 or E450 Chassis	8C2Z-18124-D 8C24-18045-DA ASH-1154 AT-163G	OI	G63622	58622 77614
		8C24-18080-DB ASH-1136 8C2Z-18125-D AT-164G	OI	G63623	58623 77623



GRANITE RIDGE

02-06	MotorHomes with Ford E350 or E450 Chassis	8C2Z-18124-D 8C24-18045-DA ASH-1154 AT-163G	OI	G63622	58622 77614
		8C24-18080-DB ASH-1136 8C2Z-18125-D AT-164G	OI	G63623	58623 77623

GREYHAWK

02-24	MotorHomes with Ford E450 Chassis	8C2Z-18124-D 8C24-18045-DA ASH-1154 AT-163G	OI	G63622	58622 77614
		8C24-18080-DB ASH-1136 8C2Z-18125-D AT-164G	OI	G63623	58623 77623

APPLICATION GUIDE

Year	Fitment Notes	OEM#								
			Fleetline/ Gas SLX	Classic/ Ultra/ ProGuard/ Guardian	Max Control/ LTV Severe Duty/ Load Carrier	Steering Dampers/ Steering Stabilizer/ Cab Shock	Fleetline/ Gas SLX	Classic/ Ultra/ ProGuard/ Guardian	Max Control/ LTV Severe Duty/ Load Carrier/ HiJackers	Steering Dampers/ Steering Stabilizer/ Cab Shock

JAYCO

JAYCO

MELBOURNE

07-24	MotorHomes with Ford E350 or E450 Chassis	8C2Z-18124-D 8C24-18045-DA ASH-1154 AT-163G	 O		G63622	58622 77614				
		8C24-18080-DB ASH-1136 8C2Z-18125-D AT-164G						 O		G63623

PRECEPT

14-24	MotorHomes with Ford F53 Chassis with 16,000 lb GVW to 22,000 lb GVW	ASH-1229 ASH-1228 9U94-18045-AA ASH-1205 AT-620 ASH-1022 1C34-18045-AA ASH-294 9U9Z-18124-A ASH-25822 ASH-25823 1C34-18045-JA AT-766	 O	83209						
		ASH-1206 9U94-18080-AA AT-621 ASH-25824 9U9Z-18125-A ASH-1023 ASH-1230 ASH-137							 O	83122 89406

REDHAWK

13-24	MotorHomes with Ford E450 Chassis	8C2Z-18124-D 8C24-18045-DA ASH-1154 AT-163G	 O		G63622	58622 77614				
		8C24-18080-DB ASH-1136 8C2Z-18125-D AT-164G						 O		G63623

REDHAWK SE

18-24	MotorHomes with Ford E450 Chassis	8C2Z-18124-D 8C24-18045-DA ASH-1154 AT-163G	 O		G63622	58622 77614				
		8C24-18080-DB ASH-1136 8C2Z-18125-D AT-164G						 O		G63623

SENECA

18-24	Models with Freightliner S2RV chassis	10-13976-000	 O	85918						
		16-16764-000						 O	85724 89443	

SENECA PRESTIGE

21-24	Models with Freightliner S2RV chassis	10-13976-000	 O	85918						
21-23	Models with Freightliner S2RV chassis	16-16764-000						 O	85724 89443	



KENWORTH

KENWORTH

K270

13-24	Models with 10,000 lb to 12,000 lb Front Axle	1707378PAC BFRG 072	 T	85182						
	Models with Hendrickson HAS - 210L or HAS - 230L Rear Air Suspension	60670-008 60670-008L						 O	83123 89405	
	Models with Hendrickson HAS - 230 Rear Air Suspension	60670-005 60670-005PLUS-2 60670-005L						 O	83137	

APPLICATION GUIDE

Year	Fitment Notes	OEM#								
			Fleetline\ Gas SLX	Classic\ Ultra\ ProGuard\ Guardian	Max Control\ LTV Severe Duty\ Load Carrier	Steering Dampers\ Steering Stabilizer\ Cab Shock	Fleetline\ Gas SLX	Classic\ Ultra\ ProGuard\ Guardian	Max Control\ LTV Severe Duty\ Load Carrier\ HiJackers	Steering Dampers\ Steering Stabilizer\ Cab Shock

KENWORTH

KENWORTH

K270 (cont)

13-24	Models with Reyco 102 or 79KB Suspension (Drive Axle)	19495-01 16725-01			83126 89430
-------	---	----------------------	--	------	------	------	------	--	----------------	------	------	------

K300

93-05	All with Air Glide 100 Suspension with 8 air bags, 4 units required	K374-29 K374-32			85310 89423
	All with Air Glide 200 with 40,000 lb Suspension with 8 air bags, 4 units required	665903 70701 665944			85900
	All with Air Glide 200 with 46,000 lb Suspension with 8 air bags, 4 units required	665945 665906			85902
	K300 COE Medium Duty	665565	00	85007
	Models with 12,000 lb Taper Leaf Front Springs (5/8" Top Mounting bolt)	665617 B71-1000	00	85031
	Models with Hendrickson Rear Air Suspension	47902-19		00	83123 89405
	Models with Multiple Leaf Springs on Front Axle (3/4" Mounting bolts)	B71-1003 K374-33 K374-3	00	83312
	Models with Reyco 102 or 79KB Suspension (Drive Axle)	19495-01 16725-01		00	83126 89430
	Models with Reyco 1209 or 1212 Suspension (Steer Axle)	19495-01	00	83126
Models with Taper Leaf Springs on Front Axle (1" Mounting bolts)	B71-1002 K374-16 K374-27 K374-26	00	85001	
Models with Woodhead Shock (Stamping Number ACHB 966)	ACHB966			83136	



T170

08-22	Models with Reyco 79KB Rear Steel Spring Suspension	19495-01 16725-01			83126 89430
08-13	Models with 8,000 lb Taper Leaf Front Springs	665617	00	85031

T270

24	Models with AG210L Rear Air Suspension 85000 Series	C71-1017 C71-1011			85069
20-23	Models with Air Glide 400L (AG400L) Rear Air Suspension	C71-1017			85069
08-23	Models with AG210L Rear Air Suspension	C71-1017 C71-1011			85069 89455
	Models with Hendrickson HAS - 210L or HAS - 230L Rear Air Suspension	60670-008 60670-008L	00	00	83123 89405
	Models with Hendrickson HMX 400/460 Haulmax with 16.5" Saddle	60680-004L 60680-004 64178-001		00	83143
	Models with Reyco 102 or 79KB Suspension (Drive Axle)	19495-01 16725-01 TK19679	00	00	83126 89430
15-22	Models with 10,000 lb to 14,600 lb Taperleaf Springs and Set Back Front Axles	B71-6019	00	85989
	Models with 16,000 lb to 20,000 lb Taperleaf Springs and Set Back Front Axles	B71-6020	00	85989
08-22	Models with Hendrickson Primaax 230, 232, 460, 462, 690 and 692 Air Suspension (8-1/2" to 10" Ride Height)	60657-003 60657-003L		00	85072
10-14	Models with 10,000 lb to 12,000 lb Front Axle	B71-6005	00	85084
	Models with 13,200 lb to 14,600 lb Front Axle	B71-6006	00	85084
	Models with 8,000 lb Front Axle	B71-6004	00	85084

APPLICATION GUIDE

Year	Fitment Notes	OEM#								
			Fleetline/ Gas SLX	Classic/ Ultra/ ProGuard/ Guardian	Max Control/ LTV Severe Duty/ Load Carrier	Steering Dampers/ Steering Stabilizer/ Cab Shock	Fleetline/ Gas SLX	Classic/ Ultra/ ProGuard/ Guardian	Max Control/ LTV Severe Duty/ Load Carrier/ HiJackers	Steering Dampers/ Steering Stabilizer/ Cab Shock

KENWORTH

KENWORTH

T270 (cont)

08-14	Models with Hendrickson HAS - 400 (Standard) Rear Air Suspension	60670-005 60670-005L	O O	83137
08-10	Models with 12,000 lb Front Axle	665617	O O	85031



T280

21-24	Models with Reyco 102 or 79KB Suspension (Drive Axle)	19495-01	O O	83126 89430
24	Models with 10,000 lb to 12,000 lb Mono-leaf front springs	B71-6019	O O	85989

T300

	All with Air Glide 100 Suspension with 8 air bags, 4 units required 85000 Series	K374-29 K374-32	I T	85310
	All with Air Glide 100 Suspension with 8 air bags, 4 units required 89000 Series	K374-29 K374-32	I T	89423
	All with Air Glide 200 with 40,000 lb Suspension with 8 air bags, 4 units required 85000 Series	665903 70701 665944	I T	85900
	Models with Hendrickson Rear Air Suspension 83000 Series	60670-004	O O	83123
	Models with Hendrickson Rear Air Suspension 89000 Series	60670-004	O O	89405
	Models with Multiple Leaf Springs on Front Axle (3/4" Mounting bolts) 83000 Series	B71-1003 K374-33 K374-3	O O	83312
	Models with Multiple Leaf Springs on Front Axle (3/4" Mounting bolts) 89000 Series	B71-1003 K374-33 K374-3	O O	89409
	Models with Reyco 102 or 79KB Suspension (Drive Axle) To 2022 83000 Series	19495-01 16725-01	O O	83126
	Models with Reyco 102 or 79KB Suspension (Drive Axle) To 2022 89000 Series	19495-01 16725-01	O O	89430
	Models with Reyco 1209 or 1212 Suspension (Steer Axle) To 2022 83000 Series	19495-01	O O	83126
	Models with Reyco 1209 or 1212 Suspension (Steer Axle) To 2022 89000 Series	19495-01	O O	89430
	Models with Taper Leaf Springs on Front Axle (1" Mounting bolts) 85000 Series	B71-1002 K374-16 K374-27 K374-26	O O	85001
	Models with Taper Leaf Springs on Front Axle (1" Mounting bolts) 89000 Series	B71-1002 K374-16 K374-27 K374-26	O O	89410
	Models with Woodhead Shock (Stamping Number ACHB 966) 83000 Series	ACHB966	I T	83136
00-08	All with Air Glide 200 with 46,000 lb Suspension with 8 air bags, 4 units required	665945 665906	I T	85902
	Models with 12,000 lb Taper Leaf Front Springs (5/8" Top Mounting bolt)	665617 B71-1000	O O	85031
	Models with Hendrickson HAS - 210L or HAS - 230L Rear Air Suspension	60670-008 60670-008L	O O	83123 89405
	Models with Reyco 102 or 79KB Suspension (Drive Axle)	19495-01 16725-01	O O	83126 89430
	Models with Reyco 1209 or 1212 Suspension (Steer Axle)	19495-01	O O	83126 89430

APPLICATION GUIDE

Year	Fitment Notes	OEM#								
			Fleetline\ Gas SLX	Classic\ Ultra\ ProGuard\ Guardian	Max Control\ LTV Severe Duty\ Load Carrier	Steering Dampers\ Steering Stabilizer\ Cab Shock	Fleetline\ Gas SLX	Classic\ Ultra\ ProGuard\ Guardian	Max Control\ LTV Severe Duty\ Load Carrier\ HiJackers	Steering Dampers\ Steering Stabilizer\ Cab Shock

KING OF THE ROAD

KING OF THE ROAD

CLASS A MOTORHOMES

04-06	Genesis Series MotorHomes with Freightliner XC Chassis ADL200 Suspension w/ 20K Rear 85000 Series	16-16873-000			85029
	Genesis Series MotorHomes with Freightliner XC Chassis AS120 Front Suspension 83000 Series	16-16874-000 16-16737-000 141700131810		83160
	Genesis Series MotorHomes with Freightliner XC Chassis Rear Shock with O.E.M. Number 85000 Series	141700131809 16-16736-000			85029
	Genesis Series MotorHomes with Freightliner XC Chassis ZF - IFS Front Suspension with 23,000 lb GVW or Greater 85000 Series	16-18103-000 481700000493		85900

KRYSTAL BUS

KRYSTAL BUS

VARIOUS

	Krystal E-450 Shuttle bus To 2020 LTV Severe Duty	ASH-1154		58622	
		ASH-1136		58623	
	Krystal E-450 Shuttle bus To 2020 Max Control	ASH-1154		77614	
		ASH-1136		77623	
	Krystal E-450 Shuttle bus To 2020 Ultra Truck Shock	ASH-1154		G63622
		ASH-1136		G63623

LEISURE TRAVEL

LEISURE TRAVEL

WONDER

19-22	MotorHomes with Ford Transit-350 Chassis			G57816 ⁴⁰
-------	--	--	--	------	------	----------------------	------	------	--	------	------	------	------

LGE COACHWORKS

LGE COACHWORKS

VARIOUS

	All Shuttle buses with Ford E350 and E450 Chassis To 2020 LTV Severe Duty	ASH-1136		58623	
	All Shuttle buses with Ford E350 and E450 Chassis To 2020 Max Control	ASH-1136		77623	
	All Shuttle buses with Ford E350 and E450 Chassis To 2020 Ultra Truck Shock	ASH-1136		G63623
	All Shuttle buses with Ford E350 and E450 Chassis To 2022 LTV Severe Duty	ASH-1154		58622	
	All Shuttle buses with Ford E350 and E450 Chassis To 2022 Max Control	ASH-1154		77614	
	All Shuttle buses with Ford E350 and E450 Chassis To 2022 Ultra Truck Shock	ASH-1154		G63622



LION

LION

LION6

21-22	Models with Hendrickson Comfort Air Suspension (21K Capacity)	60670-030L 60670-030			83166
	Trucks with Hendrickson Softek Suspension (12,500 lb Capacity)	58913-010L 58913-010		85106

APPLICATION GUIDE

Year	Fitment Notes	OEM#								
			Fleetline/ Gas SLX	Classic/ Ultra/ ProGuard/ Guardian	Max Control/ LTV Severe Duty/ Load Carrier	Steering Dampers/ Steering Stabilizer/ Cab Shock	Fleetline/ Gas SLX	Classic/ Ultra/ ProGuard/ Guardian	Max Control/ LTV Severe Duty/ Load Carrier/ HiJackers	Steering Dampers/ Steering Stabilizer/ Cab Shock

MACK

MACK

MD6

24	Models with 10,000 lb Taperleaf Springs	78530771 471700015341	O	83127
	Models with O.E.M. Number	23145372	O	83066
		23159760	O	85188
23	Models with 10,000 lb Taperleaf Springs 83000 Series	78530771 471700015341	O	83127
	Models with O.E.M. Number 83000 Series	23145372	O	83066
	Models with O.E.M. Number 85000 Series	23159760	O	85188
21-22	Models with 10,000 lb Taperleaf Springs	78530771 471700015341	O	83127
	Models with O.E.M. Number	23145372	O	83066
		23159760	O	85188

MANDALAY COACH

MANDALAY COACH

CLASS A MOTORHOMES

04-06	Mandalay Series MotorHomes with Freightliner XC Chassis ADL200 Suspension w/ 20K Rear 85000 Series	16-16873-000	O	85029
	Mandalay Series MotorHomes with Freightliner XC Chassis AS120 Front Suspension 83000 Series	16-16874-000 16-16737-000 141700131810	O	83160
	Mandalay Series MotorHomes with Freightliner XC Chassis Rear Shock with O.E.M. Number 85000 Series	141700131809 16-16736-000	O	85029
	Mandalay Series MotorHomes with Freightliner XC Chassis ZF - IFS Front Suspension with 23,000 lb GVW or Greater 85000 Series	16-18103-000 481700000493	I	85900
06	Presidio & Valencia Series MotorHomes with Freightliner XC Chassis AS120 Front Suspension 83000 Series	16-16874-000 16-16737-000 141700131810	O	83160
	Presidio & Valencia Series MotorHomes with Freightliner XC Chassis Rear Shock with O.E.M. Number 85000 Series	141700131809 16-16736-000	O	85029
	Presidio & Valencia Series MotorHomes with Freightliner XC Chassis ZF - IFS Front Suspension with 23,000 lb GVW or Greater 85000 Series	16-18103-000 481700000493	I	85900

MARMON HERRINGTON

MARMON HERRINGTON

57 GLIDER

96-97	Conventional Tractors with Link Cabmate Model MARC57-B	1201-0054 1202-0054	O	83021
90-94	Conventional Tractors with Link Cabmate Model MARC57-B	1201-0054 1202-0054	O	83021

MITSUBISHI FUSO

MITSUBISHI FUSO



FE

96-04	Model with O.E.M. Number	MC114595	O	G63405
	Models with O.E.M. Number	MK433638 MA302296	I	G63610
87-04	Model with O.E.M. Number	MB161497	O	G63299

FE145

05-11	Models with O.E.M. Number	MK433638 MK302296	I	G63610
-------	---------------------------	----------------------	---	------	--------	------	------	------	------	------	------

APPLICATION GUIDE

Year	Fitment Notes	OEM#								
			Fleetline\ Gas SLX	Classic\ Ultra\ ProGuard\ Guardian	Max Control\ LTV Severe Duty\ Load Carrier	Steering Dampers\ Steering Stabilizer\ Cab Shock	Fleetline\ Gas SLX	Classic\ Ultra\ ProGuard\ Guardian	Max Control\ LTV Severe Duty\ Load Carrier\ HiJackers	Steering Dampers\ Steering Stabilizer\ Cab Shock

MITSUBISHI FUSO

MITSUBISHI FUSO

FG

98-04	Model with O.E.M. Number	MC714595				G63405
-------	--------------------------	----------	--	------	------	------	------	--	--	--------	------	------

FH

88-04	Models with O.E.M. Number	MC826268		G63610
88-96	Models with O.E.M. Number	MC809390				83103

FK

91-94	FK457 Models with O.E.M. Number	MC814614		85009
88-91	FK455 Models with O.E.M. Number	MC814614		85009

FM

86-88	Model with O.E.M. Number	MC813135		89447
	Models with O.E.M. Number	MC813135		83456
88	FM555 Models with O.E.M. Number	MC814614		85009

MONACO COACH

MONACO COACH



CLASS A MOTORHOMES

	Models with Workhorse UFO Chassis with Hendrickson Softek Front Suspension 83000 Series	66153-002 F4-BE5-C832-MO		83124
	Models with Workhorse UFO Chassis with Hendrickson Softek Front Suspension 89000 Series	66153-002 F4-BE5-C832-MO		89407
98-11	All Models with W20 & W22 Workhorse Motorhome Chassis 85000 Series	24-153249 F4-BE5-B492-HO W0005662 W0006254 24153249 24-186629 F4-BE5-A832-MO F4-BE5-F324-HO		85125
04-07	Models with Roadmaster Chassis R4R, used on Cayman 83000 Series		83144
00-03	Models with Roadmaster Chassis RM4C or used on Knight 83000 Series	01809924		83144
	Models with Workhorse W22 Chassis with 8.1L Gas Monarch, LaPalma 85000 Series	01809925		85010

LA PALMA

07-08	MotorHomes with Ford F53 Chassis with 16,000 lb GVW to 22,000 lb GVW 83000 Series	ASH-1229 ASH-1228 9U94-18045-AA ASH-1205 AT-620 ASH-1022 1C34-18045-AA ASH-294 9U9Z-18124-A ASH-25822 ASH-25823 1C34-18045-JA AT-766		83209
	MotorHomes with Ford F53 Chassis with 16,000 lb GVW to 22,000 lb GVW 89000 Series	ASH-1229 ASH-1228 9U94-18045-AA ASH-1205 AT-620 ASH-1022 1C34-18045-AA ASH-294 9U9Z-18124-A ASH-25822 ASH-25823 1C34-18045-JA AT-766		89414

APPLICATION GUIDE

Year	Fitment Notes	OEM#								
			Fleetline/ Gas SLX	Classic/ Ultra/ ProGuard/ Guardian	Max Control/ LTV Severe Duty/ Load Carrier	Steering Dampers/ Steering Stabilizer/ Cab Shock	Fleetline/ Gas SLX	Classic/ Ultra/ ProGuard/ Guardian	Max Control/ LTV Severe Duty/ Load Carrier/ HiJackers	Steering Dampers/ Steering Stabilizer/ Cab Shock

MONACO COACH

MONACO COACH



LA PALMA (cont)

01	MotorHomes with Ford F53 Chassis with 16,000 lb GVW to 22,000 lb GVW 83000 Series	ASH-1229 ASH-1228 9U94-18045-AA ASH-1205 AT-620 ASH-1022 1C34-18045-AA ASH-294 9U9Z-18124-A ASH-25822 ASH-25823 1C34-18045-JA AT-766	OIO	83209
	MotorHomes with Ford F53 Chassis with 16,000 lb GVW to 22,000 lb GVW 89000 Series	ASH-1229 ASH-1228 9U94-18045-AA ASH-1205 AT-620 ASH-1022 1C34-18045-AA ASH-294 9U9Z-18124-A ASH-25822 ASH-25823 1C34-18045-JA AT-766	OIO	89414
90-99	MotorHomes with Ford F53 Chassis with 16,000 lb GVW to 22,000 lb GVW 83000 Series	ASH-1229 ASH-1228 9U94-18045-AA ASH-1205 AT-620 ASH-1022 1C34-18045-AA ASH-294 9U9Z-18124-A ASH-25822 ASH-25823 1C34-18045-JA AT-766	OIO	83209
	MotorHomes with Ford F53 Chassis with 16,000 lb GVW to 22,000 lb GVW 89000 Series	ASH-1229 ASH-1228 9U94-18045-AA ASH-1205 AT-620 ASH-1022 1C34-18045-AA ASH-294 9U9Z-18124-A ASH-25822 ASH-25823 1C34-18045-JA AT-766	OIO	89414

MONARCH

03-05	MotorHomes with Ford F53 Chassis with 16,000 lb GVW to 22,000 lb GVW 83000 Series	ASH-1229 ASH-1228 9U94-18045-AA ASH-1205 AT-620 ASH-1022 1C34-18045-AA ASH-294 9U9Z-18124-A ASH-25822 ASH-25823 1C34-18045-JA AT-766	OIO	83209
	MotorHomes with Ford F53 Chassis with 16,000 lb GVW to 22,000 lb GVW 89000 Series	ASH-1229 ASH-1228 9U94-18045-AA ASH-1205 AT-620 ASH-1022 1C34-18045-AA ASH-294 9U9Z-18124-A ASH-25822 ASH-25823 1C34-18045-JA AT-766	OIO	89414

APPLICATION GUIDE

Year	Fitment Notes	OEM#								
			Fleetline\ Gas SLX	Classic\ Ultra\ ProGuard\ Guardian	Max Control\ LTV Severe Duty\ Load Carrier	Steering Dampers\ Steering Stabilizer\ Cab Shock	Fleetline\ Gas SLX	Classic\ Ultra\ ProGuard\ Guardian	Max Control\ LTV Severe Duty\ Load Carrier\ HiJackers	Steering Dampers\ Steering Stabilizer\ Cab Shock

MONACO COACH

MONACO COACH

MONARCH (cont)

90-99	MotorHomes with Ford F53 Chassis with 16,000 lb GVW to 22,000 lb GVW 83000 Series	ASH-1229 ASH-1228 9U94-18045-AA ASH-1205 AT-620 ASH-1022 1C34-18045-AA ASH-294 9U9Z-18124-A ASH-25822 ASH-25823 1C34-18045-JA AT-766	oio	83209
	MotorHomes with Ford F53 Chassis with 16,000 lb GVW to 22,000 lb GVW 89000 Series	ASH-1229 ASH-1228 9U94-18045-AA ASH-1205 AT-620 ASH-1022 1C34-18045-AA ASH-294 9U9Z-18124-A ASH-25822 ASH-25823 1C34-18045-JA AT-766	oio	89414

VARIOUS

95-99	MotorHomes with Freightliner XC Chassis (22,000 to 26,000 lb GVW) 83000 Series	oio	83160
	MotorHomes with Freightliner XC Chassis (22,000 to 26,000 lb GVW) 85000 Series	oio	85029



NATIONAL RV

NATIONAL RV

CLASS A MOTORHOMES

04-08	Models with Workhorse W20 , W22, & W24 MotorHome Chassis with O.E.M. Number 85000 Series	W0005663 F4-BE5-F325-HO 24-153256	oio	85124
01-08	Models with Workhorse W20 , W22, & W24 MotorHome Chassis with O.E.M. Number 85000 Series	24-153249 F4-BE5-B492-HO W0005662 W0006254 24153249 24-186629 F4-BE5-A832-MO F4-BE5-F324-HO	oio	85125
99-08	Models with Ford F53 Chassis with 16,000 lb GVW to 22,000 lb GVW 83000 Series	ASH-1229 ASH-1228 9U94-18045-AA ASH-1205 AT-620 ASH-1022 1C34-18045-AA ASH-294 9U9Z-18124-A ASH-25822 ASH-25823 1C34-18045-JA AT-766	oio	83209
		ASH-1206 9U94-18080-AA AT-621 ASH-25824 9U9Z-18125-A ASH-1023 ASH-1230 ASH-137	oio	83122

APPLICATION GUIDE

Year	Fitment Notes	OEM#								
			Fleetline/ Gas SLX	Classic/ Ultra/ ProGuard/ Guardian	Max Control/ LTV Severe Duty/ Load Carrier	Steering Dampers/ Steering Stabilizer/ Cab Shock	Fleetline/ Gas SLX	Classic/ Ultra/ ProGuard/ Guardian	Max Control/ LTV Severe Duty/ Load Carrier/ HiJackers	Steering Dampers/ Steering Stabilizer/ Cab Shock

NATIONAL RV

NATIONAL RV

CLASS A MOTORHOMES (cont)

99-08	Models with Ford F53 Chassis with 16,000 lb GVW to 22,000 lb GVW 89000 Series	ASH-1229 ASH-1228 9U94-18045-AA ASH-1205 AT-620 ASH-1022 1C34-18045-AA ASH-294 9U9Z-18124-A ASH-25822 ASH-25823 1C34-18045-JA AT-766	OO	89414
		ASH-1206 9U94-18080-AA AT-621 ASH-25824 9U9Z-18125-A ASH-1023 ASH-1230 ASH-137	OO	89406
98-00	Models with Workhorse W20 , W22, & W24 MotorHome Chassis with O.E.M. Number 85000 Series	24-153249 F4-BE5-B492-HO W0005662 W0006254 24-186629 F4-BE5-A832-MO F4-BE5-F324-HO	OO	85125

NEWMAR

NEWMAR



BAY STAR

24	3626, F53 Chassis with 16,000 lb GVW to 22,000 lb GVW	6U9Z18124D	OO	83209
----	---	------------	----	-------	------	------	------	------	------	------	------	------

CLASS A MOTORHOMES

	Ventana Series MotorHomes with Neway AS140 w/ 14,000 lb Front Suspension 85000 Series	90045455	OO	85909
13-20	Bay Star, Bay Star Sport & Canyon Star Series MotorHomes with Ford F53 Chassis with 16,000 lb GVW to 22,000 lb GVW 83000 Series	ASH-1229 ASH-25822 ASH-25823 ASH-25824	OO	83209
		ASH-1229 ASH-25822 ASH-25823 ASH-25824	OO	89414
06	Ventana Series MotorHomes with Freightliner XC Chassis AS120 Front Suspension 83000 Series	141700131809 16-16736-000	OO	83160
		16-18103-000 481700000493	T	85900
		16-16874-000 16-16737-000 141700131810	OO	83160
02-05	Kountry Star Series MotorHomes with Freightliner XC Chassis AS120 Front Suspension 83000 Series	141700131809 16-16736-000	OO	85029
		16-18103-000 481700000493	T	85900
		16-16874-000 16-16737-000 141700131810	OO	83160
02-04	Dutch Star & Moundain Aire Series MotorHomes with Freightliner XC Chassis AS120 Front Suspension 83000 Series	141700131809 16-16736-000	OO	85029
		16-18103-000 481700000493	T	85900
		16-16874-000 16-16737-000 141700131810	OO	83160

APPLICATION GUIDE

Year	Fitment Notes	OEM#								
			Fleetline\ Gas SLX	Classic\ Ultra\ ProGuard\ Guardian	Max Control\ LTV Severe Duty\ Load Carrier	Steering Dampers\ Steering Stabilizer\ Cab Shock	Fleetline\ Gas SLX	Classic\ Ultra\ ProGuard\ Guardian	Max Control\ LTV Severe Duty\ Load Carrier\ HiJackers	Steering Dampers\ Steering Stabilizer\ Cab Shock

NEWMAR

NEWMAR

CLASS A MOTORHOMES (cont)

02-04	Dutch Star & Moundain Aire Series MotorHomes with Freightliner XC Chassis Rear Shock with O.E.M. Number 85000 Series	141700131809 16-16736-000							85029			
	Dutch Star & Moundain Aire Series MotorHomes with Freightliner XC Chassis ZF - IFS Front Suspension with 23,000 lb GVW or Greater 85000 Series	16-18103-000 481700000493		85900								

NEXUS

NEXUS

16-20	Maybach Series MotorHomes with Ford F53 Chassis with 16,000 lb GVW to 22,000 lb GVW 89000 Series	ASH-1229 ASH-25822 ASH-25823		89414								
		ASH-25824							89406			

CLASS C MOTORHOMES

12-20	Viper Series MotorHomes with Ford E350 & E450 Chassis LTV Severe Duty	ASH-1136									58623	
	Viper Series MotorHomes with Ford E350 & E450 Chassis Max Control	ASH-1136									77623	
	Viper Series MotorHomes with Ford E350 & E450 Chassis Ultra Truck Shock	ASH-1136								G63623		
11-20	Phantom Series MotorHomes with Ford E350 & E450 Chassis LTV Severe Duty	ASH-1136									58623	
	Phantom Series MotorHomes with Ford E350 & E450 Chassis Max Control	ASH-1136									77623	
	Phantom Series MotorHomes with Ford E350 & E450 Chassis Ultra Truck Shock	ASH-1136								G63623		
11-12	Scenic Traveler Series MotorHomes with Ford E450 Chassis LTV Severe Duty	ASH-1154				58622						
		ASH-1136									58623	
	Scenic Traveler Series MotorHomes with Ford E450 Chassis Max Control	ASH-1154				77614						
		ASH-1136									77623	
	Scenic Traveler Series MotorHomes with Ford E450 Chassis Ultra Truck Shock	ASH-1154			G63622							
ASH-1136									G63623			





MAYBACH

17-20	MotorHomes with Ford F53 Chassis with 16,000 lb GVW to 22,000 lb GVW	ASH-1229 ASH-1228 9U94-18045-AA 1C34-18045-AA 9U9Z-18124-A ASH-25822 ASH-1022 ASH-25823 1C34-18045-JA		83209								
		9U94-18080-AA ASH-25824 9U9Z-18125-A ASH-1023 ASH-1230							83122 89406			

PHANTOM

11-24	MotorHomes with Ford E350 or E450 Chassis	8C2Z-18124-D 8C24-18045-DA ASH-1154 AT-163G			G63622	58622 77614						
-------	---	--	--	--	--------	----------------	--	--	--	--	--	--

APPLICATION GUIDE

Year	Fitment Notes	OEM#								
			 Fleetline/ Gas SLX	Classic/ Ultra/ ProGuard/ Guardian	Max Control/ LTV Severe Duty/ Load Carrier	Steering Dampers/ Steering Stabilizer/ Cab Shock	 Fleetline/ Gas SLX	Classic/ Ultra/ ProGuard/ Guardian	Max Control/ LTV Severe Duty/ Load Carrier/ HiJackers	Steering Dampers/ Steering Stabilizer/ Cab Shock

NEXUS

NEXUS

PHANTOM (cont)

11-24	MotorHomes with Ford E350 or E450 Chassis	8C2Z-18125-C 8C24-18080-DB 8C2Z-18125-B ASH-1136 8C2Z-18125-D 8C2Z-18125-A AT-164G	 O	 O	G63623	58623 77623
-------	---	--	-------	-------	-------	-------	-------	-------	-------	--------	----------------	-------

TRIUMPH

20-24	MotorHomes with Ford E350 or E450 Chassis	8C2Z-18124-D 8C24-18045-DA ASH-1154 AT-163G	 O	G63622	58622 77614	 O
		8C2Z-18125-C 8C24-18080-DB 8C2Z-18125-B ASH-1136 8C2Z-18125-D 8C2Z-18125-A AT-164G	 O	 O	G63623	58623 77623

VIPER

24	MotorHomes with Ford E350 or E450 Chassis	8C2Z-18124-D 8C24-18045-DA ASH-1154 AT-163G	 O	G63622	 O	
		8C2Z-18125-C 8C24-18080-DB 8C2Z-18125-B ASH-1136 8C2Z-18125-D 8C2Z-18125-A AT-164G	 O	 O	G63623
	29V	8C2Z18125D	 O	 O	61646
	29V, MotorHomes with Ford E350 or E450 Chassis	8C2Z18124D	 O	G63622	 O
		8C2Z-18124-D 8C24-18045-DA ASH-1154 AT-163G	 O	58622 77614	 O
		8C2Z18125D	 O	 O	G63623
8C2Z-18125-C 8C24-18080-DB 8C2Z-18125-B ASH-1136 8C2Z-18125-D 8C2Z-18125-A AT-164G		 O	 O	58623 77623	
11-23	MotorHomes with Ford E350 or E450 Chassis	8C2Z-18124-D 8C24-18045-DA ASH-1154 AT-163G	 O	G63622	58622 77614	 O	
		8C2Z-18125-C 8C24-18080-DB 8C2Z-18125-B ASH-1136 8C2Z-18125-D 8C2Z-18125-A AT-164G	 O	 O	G63623	58623 77623

PETERBILT

PETERBILT



210

08-15	Models with Reyco 102 or 79KB Suspension (Drive Axle)	19495-01 16725-01 TK19679	 O	 O	83126 89430
-------	---	---------------------------------	-------	-------	-------	-------	-------	-------	----------------	-------	-------	-------

220

13-24	Models with 12,000 lb Front Axle	1707378PAC BFRG 072	 I	85182	 O	
	Models with Hendrickson HAS - 210L or HAS - 230L Rear Air Suspension	60670-008PLUS-2 60670-008 60670-008L	 O	 O	83123 89405
	Models with Reyco 102 or 79KB Suspension (Drive Axle)	19495-01 16725-01 TK19679	 O	 O	83126 89430

APPLICATION GUIDE

Year	Fitment Notes	OEM#								
			Fleetline\ Gas SLX	Classic\ Ultra\ ProGuard\ Guardian	Max Control\ LTV Severe Duty\ Load Carrier	Steering Dampers\ Steering Stabilizer\ Cab Shock	Fleetline\ Gas SLX	Classic\ Ultra\ ProGuard\ Guardian	Max Control\ LTV Severe Duty\ Load Carrier\ HiJackers	Steering Dampers\ Steering Stabilizer\ Cab Shock

PETERBILT

PETERBILT

220 (cont)

13-22	Models with Reyco 102AR (Standard) Rear Air Suspension	12887-02 12887-01			85013 89414
13	Models with 12,000 lb Front Axle	B71-6016A B71-6016 02-02738		85012
10	Models with 12,000 lb Front Axle	B71-6016A B71-6016 02-02738		85012
	Models with Hendrickson HAS - 210L or HAS - 230L Rear Air Suspension	60670-008PLUS-2 60670-008 60670-008L			83123 89405
	Models with Reyco 102 or 79KB Suspension (Drive Axle)	19495-01 16725-01 TK19679			83126 89430
	Models with Reyco 102AR (Standard) Rear Air Suspension	12887-02 12887-01			85013 89414
07	Models with 12,000 lb Front Axle	B71-6016A B71-6016 02-02738		85012
	Models with Hendrickson HAS - 210L or HAS - 230L Rear Air Suspension	60670-008PLUS-2 60670-008 60670-008L			83123 89405
	Models with Reyco 102 or 79KB Suspension (Drive Axle)	19495-01 16725-01 TK19679			83126 89430
	Models with Reyco 102AR (Standard) Rear Air Suspension	12887-02 12887-01			85013 89414

325

08-19	Models with 12000 lb Set Back Front Axle	B71-6016A B71-6016 02-02738		85012
	Models with Reyco 102 or 79KB Suspension (Drive Axle)	19495-01 TK19679			83126 89430
08-15	Models with 8,000 lb Front Axle	B71-6004		85084

330

	Models with O.E.M. Number 85000 Series	B71-6017 02-03020		85910
--	--	----------------------	--	-------	------	------	------	--	------	------	------	------

335

05-10	Models with 12000 lb Set Back Front Axle	02-02741 B71-6016A B71-6016 02-02738		85012
	Models with Air Trac Suspension (46,000 lb)	03-07421			85311 89424
	Models with Peterbilt Low Air Leaf Suspension	03-08781 C71-1017 C71-1011			85069 89455

536

22-24	Models with 10,000 lb to 14,600 lb Taperleaf Springs and Set Back Front Axles	B71-6019		85989
	Models with Air Trac Suspension (40,000 lb)	C71-6003			85988
	Models with Peterbilt Low Air Leaf Suspension	C71-1017			85069 89455



PHOENIX

PHOENIX

CRUISER

00-23	MotorHomes with Ford E350 or E450 Chassis	8C2Z-18124-D 8C24-18045-DA ASH-1154 AT-163G		G63622	58622 77614
		8C24-18080-DB ASH-1136 8C2Z-18125-D AT-164G		G63623	58623 77623

APPLICATION GUIDE

Year	Fitment Notes	OEM#								
			Fleetline/ Gas SLX	Classic/ Ultra/ ProGuard/ Guardian	Max Control/ LTV Severe Duty/ Load Carrier	Steering Dampers/ Steering Stabilizer/ Cab Shock	Fleetline/ Gas SLX	Classic/ Ultra/ ProGuard/ Guardian	Max Control/ LTV Severe Duty/ Load Carrier/ HiJackers	Steering Dampers/ Steering Stabilizer/ Cab Shock

PHOENIX TRX

PHOENIX



20-22	MotorHomes with Ford Transit-350 Chassis			G57816 ⁶⁰		O/O		G64177
-------	--	--	--	------	----------------------	------	------	--	-----	--	--------	------	------

PIERCE MFG. INC. VARIOUS

PIERCE MFG. INC.

09-24	Models with Freightliner Chassis (M2 106 or 108SD with 8000 to 16000 lb Front Axle and Taperleaf Spring) 85000 Series	10-13760-000 10-13592-000 47170000440 471700002991 SDA471700002991		85959		O/O	
	Models with Freightliner Chassis (M2 112 or 114SD with 12000 lb to 20000 lb Front Axle) 85000 Series	10-13809-000 471700003920		85958		O/O	
03-24	Models with Freightliner M2 112 Chassis (Day Cab Models with Spring Suspensions) 83000 Series	18-47349-000 814903003483 18-60767-000			O/O		83039
02-24	Models with Freightliner Chassis (M2 106, 108SD or 114SD with Day Cab Models and Spring Suspensions) 83000 Series	18-47350-000 18-60766-000 814903003482			O/O		83040
19-23	Models with International HV Chassis with 11,000 lb to 14,000 lb Taper-leaf Springs 85000 Series	6127714C1		85928		O/O	
	Models with International HV Chassis with Hendrickson HMX 400/460 Haulmax with 16.5" Saddle 83000 Series	60680-004L 60680-004			O/O		83143
	Models with International HV Chassis with Hendrickson HMX 400/460 Haulmax with 17.5" & 18.5" Saddle 83000 Series	60680-005L HDR60680-005 60680-005			O/O		83142
	Models with International HV Chassis with Hendrickson Primaax 230/460 Air Suspension with 9" Ride Height 85000 Series	60657-003 3626571C2 60657-003L			O/O		85072
	Models with International HV Chassis with Link Cab Mate Suspension 83000 Series	1201-9008 2509223C92 2509223C91			O/O		83054
17-23	Models with Ford F-450 or F-550 Chassis (4WD and OEM number) Max Control	ASH-85927 LC3Z-18125-W ASH-866127 ASH-866139 LC3Z-18125-J HC3Z-18125-EP HC3Z-18125-X ASH-85789			O/O		77986
20-22	Models with International MV Chassis with 20,000 lb IROS Air Suspension 85000 Series	6127713C2			O/O		85656
19-22	Models with International MV Chassis with 9,000 to 10,000 lb Front Suspension 83000 Series	6127088C1		O/O	83163		O/O	
	Models with International MV Chassis with Hendrickson HAS - 230 Rear Air Suspension 85000 Series	60675-003 H60675-003 3514952C1 60675-003L			O/O		85976
03-22	Models with Freightliner M2 112 Chassis (Crew Cab Models with O.E.M. Number) 83000 Series	18-41762-000 814903003528 18-60764-000			O/O		83038
19-21	Models with International HV Chassis with 16,000 lb to 23,000 lb Parabolic Taperleaf Springs 85000 Series	3576464C2		O/O	85957		O/O	
	Models with International HV Chassis with 18,000 to 20,000 lb (Set Forward) Front Axle 85000 Series	3868265C1		O/O	85995		O/O	

APPLICATION GUIDE

Year	Fitment Notes	OEM#								
			Fleetline\ Gas SLX	Classic\ Ultra\ ProGuard\ Guardian	Max Control\ LTV Severe Duty\ Load Carrier	Steering Dampers\ Steering Stabilizer\ Cab Shock	Fleetline\ Gas SLX	Classic\ Ultra\ ProGuard\ Guardian	Max Control\ LTV Severe Duty\ Load Carrier\ HiJackers	Steering Dampers\ Steering Stabilizer\ Cab Shock

RAM

RAM

4500

12-18	Models with O.E.M. Number	05168295AB 05168284AC 6811 1104AB-001 6811 1105AC 6811 1105AC-001 6811 1104AB	OI	85649	OI
		05168296AA 6811 1107AA 6811 1107AA-001	OI	OI	85650

5500

12-18	Models with O.E.M. Number	05168295AB 05168284AC 6811 1104AB-001 6811 1105AC 6811 1105AC-001 6811 1104AB	OI	85649	OI
		05168296AA 6811 1107AA 6811 1107AA-001	OI	OI	85650

RENEGADE

RENEGADE

VALENCIA

18-24	Models with Freightliner S2RV chassis	10-13976-000	OI	85918	OI
		16-16764-000	OI	OI	85724 89443

VERACRUZ

19-23	Models with Ford F-550 Chassis (4WD and OEM number)	ASH-85927 LC3Z-18125-W ASH-866127 ASH-866139 LC3Z-18125-J HC3Z-18125-EP HC3Z-18125-X ASH-85789	OI	OI	77986
-------	---	---	----	------	------	------	------	----	------	-------	------



SHASTA RV

SHASTA RV

ALL MODELS

	MotorHomes with Ford E350 Chassis LTV Severe Duty	8C2Z-18124-D 8C24-18045-DA ASH-1154 AT-163G	OI	58622	OI
		8C24-18080-DB ASH-1136 8C2Z-18125-D AT-164G	OI	OI	58623
	MotorHomes with Ford E350 Chassis Max Control	8C2Z-18124-D 8C24-18045-DA ASH-1154 AT-163G	OI	77614	OI
		8C24-18080-DB ASH-1136 8C2Z-18125-D AT-164G	OI	OI	77623
	MotorHomes with Ford E350 Chassis Ultra Truck Shock	8C2Z-18124-D 8C24-18045-DA ASH-1154 AT-163G	OI	G63622	OI
		8C24-18080-DB ASH-1136 8C2Z-18125-D AT-164G	OI	OI	G63623
	MotorHomes with Ford E450 Chassis LTV Severe Duty	8C2Z-18124-D 8C24-18045-DA ASH-1154 AT-163G	OI	58622	OI
		8C24-18080-DB ASH-1136 8C2Z-18125-D AT-164G	OI	OI	58623

APPLICATION GUIDE

Year	Fitment Notes	OEM#								
			Fleetline/ Gas SLX	Classic/ Ultra/ ProGuard/ Guardian	Max Control/ LTV Severe Duty/ Load Carrier	Steering Dampers/ Steering Stabilizer/ Cab Shock	Fleetline/ Gas SLX	Classic/ Ultra/ ProGuard/ Guardian	Max Control/ LTV Severe Duty/ Load Carrier/ HiJackers	Steering Dampers/ Steering Stabilizer/ Cab Shock

SHASTA RV

SHASTA RV

ALL MODELS (cont)

	MotorHomes with Ford E450 Chassis Max Control	8C2Z-18124-D 8C24-18045-DA ASH-1154 AT-163G	 O	77614
		8C24-18080-DB ASH-1136 8C2Z-18125-D AT-164G	 O	77623
	MotorHomes with Ford E450 Chassis Ultra Truck Shock	8C2Z-18124-D 8C24-18045-DA ASH-1154 AT-163G	 O	G63622
		8C24-18080-DB ASH-1136 8C2Z-18125-D AT-164G	 O	G63623

SPARTAN MOTORS

SPARTAN MOTORS

CLASS A MOTORHOMES

00-12	Summit (19000 - 22000 GVW) 85000 Series	B46-1725	 O	85910
-------	---	----------	-------	-------	------	------	------	------	------	------	------

K2

95-96	Models with I Beam Front Suspension 85000 Series	B46-1731 B46-2150	 O	85909
		B46-1732 B46-2151	 O	85030
91-95	Models with I Beam Front Suspension 89000 Series	B46-1732 B46-2151	 O	89440
		B46-1594 B46-2502 0346-SS5	 O	85030
	Models with Tuthill 102 AR Air Suspension 85000 Series	B46-1594 B46-2502 0346-SS5	 O	89440
		B46-1594 B46-2502 0346-SS5	 O	89440



RV MODELS

	RV Models with Primaax Air Suspensions 85000 Series	60665-014 60665-014L	 O	85962
--	---	-------------------------	-------	------	------	------	------	------	-------	------	------

VARIOUS

	Buses with Hendrickson Softek Suspension with Drum and Disc Brakes 85000 Series	58913-009L 58913-009 471700000456	 O	85959
	Chassis With Hendrickson HTS 210 Suspension (Type C School Bus Applications) 85000 Series	60665-025 60665-025L	 O	85036
	Chassis With Hendrickson HTS 210 Suspension (Type C School Bus Applications) 89000 Series	60665-025 60665-025L	 O	89405
	Fire Truck with O.E.M. Number 85000 Series	0272-SS5	 O	85712
	Fire Truck with Ridewell Suspension RD 202 52000 85000 Series	S2607B	 O	85702
	Models with O.E.M. Number 83000 Series	59011	 O	83214
	Models with Reyco 1200 Steer Option) 85000 Series	21310-01	 O	85307
	Motorhome chassis with Ridewell Front Suspension 85000 Series	AS4025B	 O	85712
97-00	Summit MotorHome Chassis with O.E.M. Number 85000 Series	1300B46 0377-SS5 B46-1725	 O	85029
86	Fire Truck with Ridewell Front Suspension 85000 Series	AS4025B	 O	85712

APPLICATION GUIDE

Year	Fitment Notes	OEM#								
			Fleetline\ Gas SLX	Classic\ Ultra\ ProGuard\ Guardian	Max Control\ LTV Severe Duty\ Load Carrier	Steering Dampers\ Steering Stabilizer\ Cab Shock	Fleetline\ Gas SLX	Classic\ Ultra\ ProGuard\ Guardian	Max Control\ LTV Severe Duty\ Load Carrier\ HiJackers	Steering Dampers\ Steering Stabilizer\ Cab Shock

STARCRAFT BUS CO.

STARCRAFT BUS CO.

ALLSTAR XL & XLT - SERIES

15-23	Models with F-650 chassis with 13,500, 15,500 & 19,000 lb Multi-leaf Rear Springs From 07/15 85000 Series	FC4Z-18125-A ASH-24660 471700011531 FC44-18080-AB	85180
	Models with F-650 chassis with 19.5" or 22.5" Wheels (22,000 lb GVW) From 07/15 85000 Series	FC4Z-18124-B FC4Z-18124-A ASH-24659 ASH-24658 471700011530 FC44-18045-BB	85181
00-15	Models with F-650 chassis with 10,000 lb Front Suspension 83000 Series	3584116C1 3584116C2 AA-616 4C4Z-18124-QA	83175
	Models with F-650 chassis with 12,000 & 13,200 lb Front Springs 85000 Series	4C4Z-18124-JB 3584118C2 AA-617 4C4Z-18124-RA AT-812	85928
15	Models with F-650 chassis with 21,000 lb Rear Air Suspension To 2015 85000 Series	3578858C1 3578858C2 4C4Z-18125-DA	85656
04-11	Models with F-650 chassis with 22,000 lb Multi-leaf Rear Springs 83000 Series	4C4Z-18125-B 501906C92 ASH-24661	83317

E350 & E450 FORD CHASSIS MODELS

	Allstar Series Shuttle buses with Ford E350 & E450 Chassis To 2020 LTV Severe Duty	ASH-1136	58623
	Allstar Series Shuttle buses with Ford E350 & E450 Chassis To 2020 Max Control	ASH-1136	77623
	Allstar Series Shuttle buses with Ford E350 & E450 Chassis To 2020 Ultra Truck Shock	ASH-1136	G63623
	Allstar Series Shuttle buses with Ford E350 & E450 Chassis To 2022 LTV Severe Duty	ASH-1154	58622
	Allstar Series Shuttle buses with Ford E350 & E450 Chassis To 2022 Max Control	ASH-1154	77614
	Allstar Series Shuttle buses with Ford E350 & E450 Chassis To 2022 Ultra Truck Shock	ASH-1154	G63622
	MVP Series Shuttle buses with Ford E450 Chassis To 2020 LTV Severe Duty	ASH-1136	58623
	MVP Series Shuttle buses with Ford E450 Chassis To 2020 Max Control	ASH-1136	77623
	MVP Series Shuttle buses with Ford E450 Chassis To 2020 Ultra Truck Shock	ASH-1136	G63623
	MVP Series Shuttle buses with Ford E450 Chassis To 2022 LTV Severe Duty	ASH-1154	58622
	MVP Series Shuttle buses with Ford E450 Chassis To 2022 Max Control	ASH-1154	77614
	MVP Series Shuttle buses with Ford E450 Chassis To 2022 Ultra Truck Shock	ASH-1154	G63622
	Starlite Series Shuttle buses with Ford E350 & E450 Chassis To 2020 LTV Severe Duty	ASH-1136	58623
	Starlite Series Shuttle buses with Ford E350 & E450 Chassis To 2020 Max Control	ASH-1136	77623
	Starlite Series Shuttle buses with Ford E350 & E450 Chassis To 2020 Ultra Truck Shock	ASH-1136	G63623
	Starlite Series Shuttle buses with Ford E350 & E450 Chassis To 2022 LTV Severe Duty	ASH-1154	58622

APPLICATION GUIDE

Year	Fitment Notes	OEM#								
			Fleetline/ Gas SLX	Classic/ Ultra/ ProGuard/ Guardian	Max Control/ LTV Severe Duty/ Load Carrier	Steering Dampers/ Steering Stabilizer/ Cab Shock	Fleetline/ Gas SLX	Classic/ Ultra/ ProGuard/ Guardian	Max Control/ LTV Severe Duty/ Load Carrier/ HiJackers	Steering Dampers/ Steering Stabilizer/ Cab Shock

STARCRAFT BUS CO.

STARCRAFT BUS CO.

E350 & E450 FORD CHASSIS MODELS (cont)

Starlite Series Shuttle buses with Ford E350 & E450 Chassis To 2022 Max Control	ASH-1154	 O	77614
Starlite Series Shuttle buses with Ford E350 & E450 Chassis To 2022 Ultra Truck Shock	ASH-1154	 O	G63622
Starquest Series Shuttle buses with Ford E350 & E450 Chassis To 2020 LTV Severe Duty	ASH-1136	 O	58623
Starquest Series Shuttle buses with Ford E350 & E450 Chassis To 2020 Max Control	ASH-1136	 O	77623
Starquest Series Shuttle buses with Ford E350 & E450 Chassis To 2020 Ultra Truck Shock	ASH-1136	 O	G63623
Starquest Series Shuttle buses with Ford E350 & E450 Chassis To 2022 LTV Severe Duty	ASH-1154	 O	58622
Starquest Series Shuttle buses with Ford E350 & E450 Chassis To 2022 Max Control	ASH-1154	 O	77614
Starquest Series Shuttle buses with Ford E350 & E450 Chassis To 2022 Ultra Truck Shock	ASH-1154	 O	G63622
Ultra Star Series Shuttle buses with Ford E450 Chassis To 2020 LTV Severe Duty	ASH-1154	 O	58622
	ASH-1136	 O	58623
Ultra Star Series Shuttle buses with Ford E450 Chassis To 2020 Max Control	ASH-1154	 O	77614
	ASH-1136	 O	77623
Ultra Star Series Shuttle buses with Ford E450 Chassis To 2020 Ultra Truck Shock	ASH-1154	 O	G63622
	ASH-1136	 O	G63623
Xpress Series Shuttle buses with Ford E350 & E450 Chassis To 2020 LTV Severe Duty	ASH-1154	 O	58622
	ASH-1136	 O	58623
Xpress Series Shuttle buses with Ford E350 & E450 Chassis To 2020 Max Control	ASH-1154	 O	77614
	ASH-1136	 O	77623
Xpress Series Shuttle buses with Ford E350 & E450 Chassis To 2020 Ultra Truck Shock	ASH-1154	 O	G63622
	ASH-1136	 O	G63623



STERLING TRUCK

STERLING TRUCK

ACTERRA

	Models with 11000 to 12000 lb Front axle 85000 Series	6803230300	 O	85006
03-10	All Models with Freightliner TufTrac Rear Air Suspension	481700125969 16-15770-000	 O	85956
	Models with 15000 lb Rear Suspension	6803260000	 O	83120
	Models with FAS II (40,000 lb) Rear Air Suspension	16-15817-000 16-13957-000 XC45-18080-BA	 O	85724 89443
	Models with Hendrickson Front Airtek	58913-003L 471700131331 58913-003	 O	85932
01-09	Models with 10000 to 12000 lb. Taper-leaf Spring Suspension 85000 Series	10-12390-000	 O	85920
	Models with 10000 to 12000 lb. Taper-leaf Spring Suspension 89000 Series	10-12390-000	 O	89503
	Models with 6000 to 9000 lb Front axle 85000 Series	10-12388-000	 O	85920
	Models with 6000 to 9000 lb Front axle 89000 Series	10-12388-000	 O	89503

APPLICATION GUIDE

Year	Fitment Notes	OEM#								
			Fleetline\ Gas SLX	Classic\ Ultra\ ProGuard\ Guardian	Max Control\ LTV Severe Duty\ Load Carrier	Steering Dampers\ Steering Stabilizer\ Cab Shock	Fleetline\ Gas SLX	Classic\ Ultra\ ProGuard\ Guardian	Max Control\ LTV Severe Duty\ Load Carrier\ HiJackers	Steering Dampers\ Steering Stabilizer\ Cab Shock

STERLING TRUCK

STERLING TRUCK

ACTERRA 5500

01-07	Models with 15000 lb Rear Suspension	6803260000			83120
	Models with FAS II (40,000 lb) Rear Air Suspension	16-15817-000 16-13957-000 XC45-18080-BA			85724 89443
	Models with Hendrickson Front Airtek	58913-003L 471700131331 58913-003		85932

ACTERRA 6500

01-07	Models with 15000 lb Rear Suspension	6803260000			83120
	Models with FAS II (40,000 lb) Rear Air Suspension	16-15817-000 16-13957-000 XC45-18080-BA			85724 89443
	Models with Hendrickson Front Airtek	58913-003L 471700131331 58913-003		85932

ACTERRA 7500

01-07	Models with 15000 lb Rear Suspension	6803260000			83120
	Models with FAS II (40,000 lb) Rear Air Suspension	16-15817-000 16-13957-000 XC45-18080-BA			85724 89443
	Models with Hendrickson Front Airtek	58913-003L 471700131331 58913-003		85932

ACTERRA 8500

03	Models with 15000 lb Rear Suspension	6803260000			83120
	Models with FAS II (40,000 lb) Rear Air Suspension	16-15817-000 16-13957-000 XC45-18080-BA			85724 89443
	Models with Hendrickson Front Airtek	58913-003L 471700131331 58913-003		85932
01	Models with 15000 lb Rear Suspension	6803260000			83120
	Models with FAS II (40,000 lb) Rear Air Suspension	16-15817-000 16-13957-000 XC45-18080-BA			85724 89443
	Models with Hendrickson Front Airtek	58913-003L 471700131331 58913-003		85932



BULLET 45

08-10	Models with O.E.M. Number	05168295AB 05168284AC 6811 1104AB-001 6811 1105AC 6811 1105AC-001 6811 1104AB		85649
		05168296AA 6811 1107AA 6811 1107AA-001			85650

BULLET 55

08-10	Models with O.E.M. Number	05168295AB 05168284AC 6811 1104AB-001 6811 1105AC 6811 1105AC-001 6811 1104AB		85649
		05168296AA 6811 1107AA 6811 1107AA-001			85650

APPLICATION GUIDE

Year	Fitment Notes	OEM#								
			Fleetline/ Gas SLX	Classic/ Ultra/ ProGuard/ Guardian	Max Control/ LTV Severe Duty/ Load Carrier	Steering Dampers/ Steering Stabilizer/ Cab Shock	Fleetline/ Gas SLX	Classic/ Ultra/ ProGuard/ Guardian	Max Control/ LTV Severe Duty/ Load Carrier/ HiJackers	Steering Dampers/ Steering Stabilizer/ Cab Shock

THOMAS

THOMAS



TYPE A SCHOOL BUS

00-22	Minotour Type A School bus with Ford E450 Chassis LTV Severe Duty	8C2Z-18124-D 8C24-18045-DA ASH-1154 AT-163G	 O	58622
	Minotour Type A School bus with Ford E450 Chassis Max Control	8C2Z-18124-D 8C24-18045-DA ASH-1154 AT-163G	 O	77614
	Minotour Type A School bus with Ford E450 Chassis Ultra Truck Shock	8C2Z-18124-D 8C24-18045-DA ASH-1154 AT-163G	 O	G63622
92-22	Minotour Type A School bus with Ford E350 Chassis LTV Severe Duty	8C2Z-18124-D 8C24-18045-DA ASH-1154 AT-163G	 O	58622
	Minotour Type A School bus with Ford E350 Chassis Max Control	8C2Z-18124-D 8C24-18045-DA ASH-1154 AT-163G	 O	77614
	Minotour Type A School bus with Ford E350 Chassis Ultra Truck Shock	8C2Z-18124-D 8C24-18045-DA ASH-1154 AT-163G	 O	G63622
00-20	Minotour Type A School bus with Ford E450 Chassis LTV Severe Duty	8C24-18080-DB ASH-1136 8C2Z-18125-D AT-164G	 O	58623
	Minotour Type A School bus with Ford E450 Chassis Max Control	8C24-18080-DB ASH-1136 8C2Z-18125-D AT-164G	 O	77623
	Minotour Type A School bus with Ford E450 Chassis Ultra Truck Shock	8C24-18080-DB ASH-1136 8C2Z-18125-D AT-164G	 O	G63623
92-20	Minotour Type A School bus with Ford E350 Chassis LTV Severe Duty	8C24-18080-DB ASH-1136 8C2Z-18125-D AT-164G	 O	58623
	Minotour Type A School bus with Ford E350 Chassis Max Control	8C24-18080-DB ASH-1136 8C2Z-18125-D AT-164G	 O	77623
	Minotour Type A School bus with Ford E350 Chassis Ultra Truck Shock	8C24-18080-DB ASH-1136 8C2Z-18125-D AT-164G	 O	G63623

VARIOUS

Buses with Neway Tandem Air Suspension 85000 Series	61310232	 O	85000
Buses with Neway Tandem Air Suspension 89000 Series	61310232	 O	89436
Buses with O.E.M. Number 85000 Series	16-19138-000	 O	85058
Buses with O.E.M. Number 89000 Series	16-19138-000	 O	89431
Model MVP 85000 Series	61310101	 O	85736
Models with Hendrickson Comfort Air Rear Air Suspension 83000 Series	60670-006 60670-006L	 O	83147
ROC Front, SAF-T-Liner 83000 Series	61300285 GBL651442	 I	83102
SAF-T-Liner HDX Models with Hendrickson Comfort Air Rear Air Suspension 85000 Series	471700131545 60998-001 60998-003	 O	85006
SAF-T-Liner School Bus MVP-ER & MVP-EF 85000 Series	61300219 70445 61300222 61300223	 O	85014
School Bus 85000 Series	614974	 O	85304

APPLICATION GUIDE

Year	Fitment Notes	OEM#								
			Fleetline\ Gas SLX	Classic\ Ultra\ ProGuard\ Guardian	Max Control\ LTV Severe Duty\ Load Carrier	Steering Dampers\ Steering Stabilizer\ Cab Shock	Fleetline\ Gas SLX	Classic\ Ultra\ ProGuard\ Guardian	Max Control\ LTV Severe Duty\ Load Carrier\ HiJackers	Steering Dampers\ Steering Stabilizer\ Cab Shock

THOMAS

THOMAS

VARIOUS (cont)

	School Bus 85000 Series	00614966 300-0614966	oio	85307	oio	oio	oio	oio	oio	oio	oio	oio	oio
	Type C Conventional Buses (65 capacity) with FAS II Rear Air Suspension To 2017 85000 Series	16-15817-000 16-18708-000 61310434 61310478	oio	85724	oio	oio	oio	oio	oio	oio	oio	oio	oio
	Type C Conventional Buses (65 capacity) with FAS II Rear Air Suspension To 2017 89000 Series	16-15817-000 16-18708-000 61310434 61310478	oio	89443	oio	oio	oio	oio	oio	oio	oio	oio	oio
05-22	Models with Freightliner B2 Bus Chassis & 15000 lb Rear Suspension 83000 Series	6803260000	oio	83120	oio	oio	oio	oio	oio	oio	oio	oio	oio
03	Type C Conventional School buses (65 capacity) with O.E.M. Number 85000 Series	6803230300 GBL665538	oio	85006	oio	oio	oio	oio	oio	oio	oio	oio	oio

THOR MOTOR COACH

THOR MOTOR COACH

A.C.E.

11-24	MotorHomes with Ford F53 Chassis with 16,000 lb GVW to 22,000 lb GVW	ASH-1229 ASH-1228 9U94-18045-AA ASH-1205 AT-620 ASH-1022 1C34-18045-AA ASH-294 9U9Z-18124-A ASH-25822 ASH-25823 1C34-18045-JA AT-766	oio	83209	oio	oio	oio	oio	oio	oio	oio	oio	oio
		ASH-1206 9U94-18080-AA AT-621 ASH-25824 9U9Z-18125-A ASH-1023 ASH-1230 ASH-137	oio	83122 89406	oio	oio	oio	oio	oio	oio	oio	oio	oio



AXIS

14-24	MotorHomes with Ford E350 or E450 Chassis	8C2Z-18124-D 8C24-18045-DA ASH-1154 AT-163G	oio	G63622	oio	58622 77614	oio	oio	oio	oio	oio	oio	oio
		8C24-18080-DB ASH-1136 8C2Z-18125-D AT-164G	oio	G63623	oio	58623 77623	oio	oio	oio	oio	oio	oio	oio

CHALLENGER

09-24	MotorHomes with Ford F53 Chassis with 16,000 lb GVW to 22,000 lb GVW	ASH-1229 ASH-1228 9U94-18045-AA ASH-1205 AT-620 ASH-1022 1C34-18045-AA ASH-294 9U9Z-18124-A ASH-25822 ASH-25823 1C34-18045-JA AT-766	oio	83209	oio	oio	oio	oio	oio	oio	oio	oio	oio
		ASH-1206 9U94-18080-AA AT-621 ASH-25824 9U9Z-18125-A ASH-1023 ASH-1230 ASH-137	oio	83122 89406	oio	oio	oio	oio	oio	oio	oio	oio	oio

APPLICATION GUIDE

Year	Fitment Notes	OEM#								
			Fleetline/ Gas SLX	Classic/ Ultra/ ProGuard/ Guardian	Max Control/ LTV Severe Duty/ Load Carrier	Steering Dampers/ Steering Stabilizer/ Cab Shock	Fleetline/ Gas SLX	Classic/ Ultra/ ProGuard/ Guardian	Max Control/ LTV Severe Duty/ Load Carrier/ HiJackers	Steering Dampers/ Steering Stabilizer/ Cab Shock

THOR MOTOR COACH CHALLENGER (cont)

THOR MOTOR COACH

05-08	MotorHomes with Ford F53 Chassis with 16,000 lb GVW to 22,000 lb GVW 83000 Series	ASH-1229 ASH-1228 9U94-18045-AA ASH-1205 AT-620 ASH-1022 1C34-18045-AA ASH-294 9U9Z-18124-A ASH-25822 ASH-25823 1C34-18045-JA AT-766	OO	83209	
		ASH-1206 9U94-18080-AA AT-621 ASH-25824 9U9Z-18125-A ASH-1023 ASH-1230 ASH-137	83122
	MotorHomes with Ford F53 Chassis with 16,000 lb GVW to 22,000 lb GVW 89000 Series	ASH-1229 ASH-1228 9U94-18045-AA ASH-1205 AT-620 ASH-1022 1C34-18045-AA ASH-294 9U9Z-18124-A ASH-25822 ASH-25823 1C34-18045-JA AT-766	OO	89414
		ASH-1206 9U94-18080-AA AT-621 ASH-25824 9U9Z-18125-A ASH-1023 ASH-1230 ASH-137	89406

CHATEAU

11-24	MotorHomes with Ford E350 or E450 Chassis	8C2Z-18124-D 8C24-18045-DA ASH-1154 AT-163G	OO	G63622	58622 77614
		8C24-18080-DB ASH-1136 8C2Z-18125-D AT-164G	G63623	58623 77623
99-10	MotorHomes with Ford E350 or E450 Chassis Ultra Truck Shock	8C24-18080-DB ASH-1136 8C2Z-18125-D AT-164G	OO	G63623



CHATEAU CITATION

13	MotorHomes with Ford E350 or E450 Chassis Ultra Truck Shock	8C24-18080-DB ASH-1136 8C2Z-18125-D AT-164G	OO	G63623
11-12	MotorHomes with Ford E350 or E450 Chassis	8C2Z-18124-D 8C24-18045-DA ASH-1154 AT-163G	OO	G63622	58622 77614
		8C24-18080-DB ASH-1136 8C2Z-18125-D AT-164G	G63623	58623 77623
08-10	MotorHomes with Ford E350 or E450 Chassis Ultra Truck Shock	8C24-18080-DB ASH-1136 8C2Z-18125-D AT-164G	OO	G63623

CITATION

12-16	MotorHomes with Ford E350 or E450 Chassis	8C2Z-18124-D 8C24-18045-DA ASH-1154 AT-163G	OO	G63622	58622 77614
-------	---	--	----	------	--------	----------------	------	------	------	------	------

APPLICATION GUIDE

Year	Fitment Notes	OEM#								
			Fleetline\ Gas SLX	Classic\ Ultra\ ProGuard\ Guardian	Max Control\ LTV Severe Duty\ Load Carrier	Steering Dampers\ Steering Stabilizer\ Cab Shock	Fleetline\ Gas SLX	Classic\ Ultra\ ProGuard\ Guardian	Max Control\ LTV Severe Duty\ Load Carrier\ HiJackers	Steering Dampers\ Steering Stabilizer\ Cab Shock

THOR MOTOR COACH CITATION (cont)



THOR MOTOR COACH

12-16	MotorHomes with Ford E350 or E450 Chassis	8C24-18080-DB ASH-1136 8C2Z-18125-D AT-164G	oio	G63623	58623 77623
01-11	MotorHomes with Ford E350 or E450 Chassis Ultra Truck Shock	8C24-18080-DB ASH-1136 8C2Z-18125-D AT-164G	oio	G63623

CLASS A MOTORHOMES

06	Astoria Series MotorHomes with Freightliner XC Chassis ADL200 Suspension w/ 20K Rear 85000 Series	16-16873-000	oio	85029
	Astoria Series MotorHomes with Freightliner XC Chassis AS120 Front Suspension 83000 Series	16-16874-000 16-16737-000 141700131810	oio	83160
	Astoria Series MotorHomes with Freightliner XC Chassis Rear Shock with O.E.M. Number 85000 Series	141700131809 16-16736-000	oio	85029
	Astoria Series MotorHomes with Freightliner XC Chassis ZF - IFS Front Suspension with 23,000 lb GVW or Greater 85000 Series	16-18103-000 481700000493	oio	85900
	Tuscany Series MotorHomes with Freightliner XC Chassis ADL200 Suspension w/ 20K Rear 85000 Series	16-16873-000	oio	85029
	Tuscany Series MotorHomes with Freightliner XC Chassis AS120 Front Suspension 83000 Series	16-16874-000 16-16737-000 141700131810	oio	83160
	Tuscany Series MotorHomes with Freightliner XC Chassis Rear Shock with O.E.M. Number 85000 Series	141700131809 16-16736-000	oio	85029
	Tuscany Series MotorHomes with Freightliner XC Chassis ZF - IFS Front Suspension with 23,000 lb GVW or Greater 85000 Series	16-18103-000 481700000493	oio	85900
02-05	Escaper Series MotorHomes with Freightliner XC Chassis ADL200 Suspension w/ 20K Rear 85000 Series	16-16873-000	oio	85029
	Escaper Series MotorHomes with Freightliner XC Chassis AS120 Front Suspension 83000 Series	16-16874-000 16-16737-000 141700131810	oio	83160
	Escaper Series MotorHomes with Freightliner XC Chassis Rear Shock with O.E.M. Number 85000 Series	141700131809 16-16736-000	oio	85029
	Escaper Series MotorHomes with Freightliner XC Chassis ZF - IFS Front Suspension with 23,000 lb GVW or Greater 85000 Series	16-18103-000 481700000493	oio	85900
	UltraSport Series MotorHomes with Freightliner XC Chassis ADL200 Suspension w/ 20K Rear 85000 Series	16-16873-000	oio	85029
	UltraSport Series MotorHomes with Freightliner XC Chassis AS120 Front Suspension 83000 Series	16-16874-000 16-16737-000 141700131810	oio	83160
	UltraSport Series MotorHomes with Freightliner XC Chassis Rear Shock with O.E.M. Number 85000 Series	141700131809 16-16736-000	oio	85029
	UltraSport Series MotorHomes with Freightliner XC Chassis ZF - IFS Front Suspension with 23,000 lb GVW or Greater 85000 Series	16-18103-000 481700000493	oio	85900

APPLICATION GUIDE

Year	Fitment Notes	OEM#								
			Fleetline/ Gas SLX	Classic/ Ultra/ ProGuard/ Guardian	Max Control/ LTV Severe Duty/ Load Carrier	Steering Dampers/ Steering Stabilizer/ Cab Shock	Fleetline/ Gas SLX	Classic/ Ultra/ ProGuard/ Guardian	Max Control/ LTV Severe Duty/ Load Carrier/ HiJackers	Steering Dampers/ Steering Stabilizer/ Cab Shock

THOR MOTOR COACH DAZZLE

THOR MOTOR COACH

25	2JB, Left		↓	G57800 ⁴⁰
	2JB, Right		↓	G57801 ⁴⁰

ECHELON

22-24	MotorHomes with Ford E350 or E450 Chassis	8C2Z-18124-D 8C24-18045-DA ASH-1154	↓ ○	G63622	58622 77614
		8C24-18080-DB ASH-1136 8C2Z-18125-D	↓ ○	G63623	58623 77623

FOUR WINDS

11-24	MotorHomes with Ford E350 or E450 Chassis	8C2Z-18124-D 8C24-18045-DA ASH-1154 AT-163G	↓ ○	G63622	58622 77614
		8C24-18080-DB ASH-1136 8C2Z-18125-D AT-164G	↓ ○	G63623	58623 77623
24	28A, MotorHomes with Ford E350 or E450 Chassis	8C2Z-18124-D 8C24-18045-DA ASH-1154 AT-163G	↓ ○	77614
01-10	MotorHomes with Ford E350 or E450 Chassis Ultra Truck Shock	8C24-18080-DB ASH-1136 8C2Z-18125-D AT-164G	↓ ○	G63623

FOUR WINDS 282

25	All	8C2Z18124D	↓ ○	G63622
			↓ ○	61646	58623
		8C2Z18125D	↓ ○	G63623	77623
	MotorHomes with Ford E350 or E450 Chassis		↓ ○	58622
		8C2Z18124D	↓ ○	77614



FREEDOM ELITE

12-24	MotorHomes with Ford E350 or E450 Chassis	8C2Z-18124-D 8C24-18045-DA ASH-1154 AT-163G	↓ ○	G63622	58622 77614
		8C24-18080-DB ASH-1136 8C2Z-18125-D AT-164G	↓ ○	G63623	58623 77623
10-11	MotorHomes with Ford E350 or E450 Chassis Ultra Truck Shock	8C24-18080-DB ASH-1136 8C2Z-18125-D AT-164G	↓ ○	G63623

GEMINI

19-22	MotorHomes with Ford Transit-350 Chassis		↓	G57816 ⁴⁰	G64177
-------	--	--	---	------	----------------------	------	------	--------	------	------	------

APPLICATION GUIDE

Year	Fitment Notes	OEM#								
			Fleetline\ Gas SLX	Classic\ Ultra\ ProGuard\ Guardian	Max Control\ LTV Severe Duty\ Load Carrier	Steering Dampers\ Steering Stabilizer\ Cab Shock	Fleetline\ Gas SLX	Classic\ Ultra\ ProGuard\ Guardian	Max Control\ LTV Severe Duty\ Load Carrier\ HiJackers	Steering Dampers\ Steering Stabilizer\ Cab Shock

THOR MOTOR COACH HURRICANE

THOR MOTOR COACH

11-24	MotorHomes with Ford F53 Chassis with 16,000 lb GVW to 22,000 lb GVW	ASH-1229 ASH-1228 9U94-18045-AA ASH-1205 AT-620 ASH-1022 1C34-18045-AA ASH-294 9U9Z-18124-A ASH-25822 ASH-25823 1C34-18045-JA AT-766	OIO	83209	
		ASH-1206 9U94-18080-AA AT-621 ASH-25824 9U9Z-18125-A ASH-1023 ASH-1230 ASH-137	OIO	83122 89406
04-10	MotorHomes with Ford F53 Chassis with 16,000 lb GVW to 22,000 lb GVW 83000 Series	ASH-1229 ASH-1228 9U94-18045-AA ASH-1205 AT-620 ASH-1022 1C34-18045-AA ASH-294 9U9Z-18124-A ASH-25822 ASH-25823 1C34-18045-JA AT-766	OIO	83209	
		ASH-1206 9U94-18080-AA AT-621 ASH-25824 9U9Z-18125-A ASH-1023 ASH-1230 ASH-137	OIO	83122
	MotorHomes with Ford F53 Chassis with 16,000 lb GVW to 22,000 lb GVW 89000 Series	ASH-1229 ASH-1228 9U94-18045-AA ASH-1205 AT-620 ASH-1022 1C34-18045-AA ASH-294 9U9Z-18124-A ASH-25822 ASH-25823 1C34-18045-JA AT-766	OIO	89414
		ASH-1206 9U94-18080-AA AT-621 ASH-25824 9U9Z-18125-A ASH-1023 ASH-1230 ASH-137	OIO	89406



INCEPTION

22-24	Models with Freightliner S2RV chassis	10-13976-000	OIO	85918
		16-16764-000	OIO	85724 89443

INDIGO

23-24	MotorHomes with Ford F53 Chassis with 16,000 lb GVW to 22,000 lb GVW	9U94-18045-AA 9U9Z-18124-A ASH-25822 ASH-25823	OIO	83209
		9U94-18080-AA ASH-25824 9U9Z-18125-A	OIO	83122 89406

APPLICATION GUIDE

Year	Fitment Notes	OEM#								
			Fleetline/ Gas SLX	Classic/ Ultra/ ProGuard/ Guardian	Max Control/ LTV Severe Duty/ Load Carrier	Steering Dampers/ Steering Stabilizer/ Cab Shock	Fleetline/ Gas SLX	Classic/ Ultra/ ProGuard/ Guardian	Max Control/ LTV Severe Duty/ Load Carrier/ HiJackers	Steering Dampers/ Steering Stabilizer/ Cab Shock

THOR MOTOR COACH LUMINATE

THOR MOTOR COACH

23-24	MotorHomes with Ford F53 Chassis with 16,000 lb GVW to 22,000 lb GVW	9U94-18045-AA 9U9Z-18124-A ASH-25822 ASH-25823	OO	83209
		9U94-18080-AA ASH-25824 9U9Z-18125-A	OO	83122 89406

MAGNITUDE

19-23	Models with Ford F-550 Chassis (4WD and OEM number)	ASH-85927 LC3Z-18125-W ASH-866127 ASH-866139 LC3Z-18125-J HC3Z-18125-EP HC3Z-18125-X ASH-85789	OO	77986
	Models with Ford F-550 Chassis (RWD and OEM number)	ASH-25770 HC3Z-18125-ED HC3Z-18125-EE HC3Z-18125-B ASH-85857 ASH-85856	OO	77987

MIRAMAR

14-24	MotorHomes with Ford F53 Chassis with 16,000 lb GVW to 22,000 lb GVW	ASH-1229 ASH-1228 9U94-18045-AA ASH-1205 AT-620 ASH-1022 1C34-18045-AA ASH-294 9U9Z-18124-A ASH-25822 ASH-25823 1C34-18045-JA AT-766	OO	83209
		ASH-1206 9U94-18080-AA AT-621 ASH-25824 9U9Z-18125-A ASH-1023 ASH-1230 ASH-137	OO	83122 89406



OMNI

19-23	Models with Ford F-550 Chassis (4WD and OEM number)	ASH-85927 LC3Z-18125-W ASH-866127 ASH-866139 LC3Z-18125-J HC3Z-18125-EP HC3Z-18125-X ASH-85789	OO	77986
	Models with Ford F-550 Chassis (RWD and OEM number)	ASH-25770 HC3Z-18125-ED HC3Z-18125-EE HC3Z-18125-B ASH-85857 ASH-85856	OO	77987

OUTLAW

11-24	MotorHomes with Ford F53 Chassis with 24,000 lb GVW to 26,000 lb GVW	ASH-25821 ASH-1161	OO	85006
24	MotorHomes with Ford F53 Chassis with 24,000 lb GVW to 26,000 lb GVW	ASH-25820 ASH-1162	OO	89430
11-23	MotorHomes with Ford E350 or E450 Chassis	8C2Z-18124-D 8C24-18045-DA ASH-1154 AT-163G	OO	G63622	58622 77614
		8C24-18080-DB ASH-1136 8C2Z-18125-D AT-164G	OO	G63623	58623 77623

APPLICATION GUIDE

Year	Fitment Notes	OEM#								
			Fleetline\ Gas SLX	Classic\ Ultra\ ProGuard\ Guardian	Max Control\ LTV Severe Duty\ Load Carrier	Steering Dampers\ Steering Stabilizer\ Cab Shock	Fleetline\ Gas SLX	Classic\ Ultra\ ProGuard\ Guardian	Max Control\ LTV Severe Duty\ Load Carrier\ HiJackers	Steering Dampers\ Steering Stabilizer\ Cab Shock

THOR MOTOR COACH OUTLAW (cont)

THOR MOTOR COACH

11-23	MotorHomes with Ford F53 Chassis with 16,000 lb GVW to 22,000 lb GVW	ASH-1229 ASH-1228 9U94-18045-AA ASH-1205 AT-620 ASH-1022 1C34-18045-AA ASH-294 9U9Z-18124-A ASH-25822 ASH-25823 1C34-18045-JA AT-766	OIO	83209	
		ASH-1206 9U94-18080-AA AT-621 ASH-25824 9U9Z-18125-A ASH-1023 ASH-1230 ASH-137
	MotorHomes with Ford F53 Chassis with 24,000 lb GVW to 26,000 lb GVW	ASH-25820 ASH-1162
07-10	MotorHomes with Ford F53 Chassis with 16,000 lb GVW to 22,000 lb GVW 83000 Series	ASH-1229 ASH-1228 9U94-18045-AA ASH-1205 AT-620 ASH-1022 1C34-18045-AA ASH-294 9U9Z-18124-A ASH-25822 ASH-25823 1C34-18045-JA AT-766	OIO	83209	
		ASH-1206 9U94-18080-AA AT-621 ASH-25824 9U9Z-18125-A ASH-1023 ASH-1230 ASH-137
	MotorHomes with Ford F53 Chassis with 16,000 lb GVW to 22,000 lb GVW 89000 Series	ASH-1229 ASH-1228 9U94-18045-AA ASH-1205 AT-620 ASH-1022 1C34-18045-AA ASH-294 9U9Z-18124-A ASH-25822 ASH-25823 1C34-18045-JA AT-766	OIO	89414
		ASH-1206 9U94-18080-AA AT-621 ASH-25824 9U9Z-18125-A ASH-1023 ASH-1230 ASH-137



PASADENA

22-24	Models with Freightliner S2RV chassis	10-13976-000	OIO	85918
		16-16764-000	OIO

QUANTUM

16-24	MotorHomes with Ford E350 or E450 Chassis	8C2Z-18124-D 8C24-18045-DA ASH-1154 AT-163G	OIO	G63622	58622 77614
		8C24-18080-DB ASH-1136 8C2Z-18125-D AT-164G	OIO	G63623	58623 77623

APPLICATION GUIDE

Year	Fitment Notes	OEM#								
			Fleetline/ Gas SLX	Classic/ Ultra/ ProGuard/ Guardian	Max Control/ LTV Severe Duty/ Load Carrier	Steering Dampers/ Steering Stabilizer/ Cab Shock	Fleetline/ Gas SLX	Classic/ Ultra/ ProGuard/ Guardian	Max Control/ LTV Severe Duty/ Load Carrier/ HiJackers	Steering Dampers/ Steering Stabilizer/ Cab Shock

THOR MOTOR COACH RESONATE

THOR MOTOR COACH

23-24	MotorHomes with Ford F53 Chassis with 16,000 lb GVW to 22,000 lb GVW	9U94-18045-AA 9U9Z-18124-A ASH-25822 ASH-25823	OO	83209
		9U94-18080-AA ASH-25824 9U9Z-18125-A	OO	OO OO	83122 89406

SCOPE

24	18M, Left		I O	G57800 ⁴⁰
	18M, Right		I O	G57801 ⁴⁰



VEGAS

25	24.1	8C2Z18124D	I O	G63622	
			I O	77614
		8C2Z18125D	I O	OO OO	61646 G63623	77623
	24.1, MotorHomes with Ford E350 or E450 Chassis	8C2Z-18124-D 8C24-18045-DA ASH-1154 AT-163G	I O	58622	
		8C24-18080-DB ASH-1136 8C2Z-18125-D AT-164G	I O	58623
14-24	MotorHomes with Ford E350 or E450 Chassis	8C2Z-18124-D 8C24-18045-DA ASH-1154 AT-163G	I O	G63622	58622 77614	
		8C24-18080-DB ASH-1136 8C2Z-18125-D AT-164G	I O	G63623	58623 77623
24	24.1	8C2Z18125D	I O	OO OO	G63623

WINDSPORT

11-24	MotorHomes with Ford F53 Chassis with 16,000 lb GVW to 22,000 lb GVW	ASH-1229 ASH-1228 9U94-18045-AA ASH-1205 AT-620 ASH-1022 1C34-18045-AA ASH-294 9U9Z-18124-A ASH-25822 ASH-25823 1C34-18045-JA AT-766	OO	83209
		ASH-1206 9U94-18080-AA AT-621 ASH-25824 9U9Z-18125-A ASH-1023 ASH-1230 ASH-137	OO	OO OO	83122 89406
06-10	MotorHomes with Ford F53 Chassis with 16,000 lb GVW to 22,000 lb GVW 83000 Series	ASH-1229 ASH-1228 9U94-18045-AA ASH-1205 AT-620 ASH-1022 1C34-18045-AA ASH-294 9U9Z-18124-A ASH-25822 ASH-25823 1C34-18045-JA AT-766	OO	83209

APPLICATION GUIDE

Year	Fitment Notes	OEM#								
			Fleetline\ Gas SLX	Classic\ Ultra\ ProGuard\ Guardian	Max Control\ LTV Severe Duty\ Load Carrier	Steering Dampers\ Steering Stabilizer\ Cab Shock	Fleetline\ Gas SLX	Classic\ Ultra\ ProGuard\ Guardian	Max Control\ LTV Severe Duty\ Load Carrier\ HiJackers	Steering Dampers\ Steering Stabilizer\ Cab Shock

THOR MOTOR COACH WINDSPORT (cont)

THOR MOTOR COACH

06-10	MotorHomes with Ford F53 Chassis with 16,000 lb GVW to 22,000 lb GVW 83000 Series	ASH-1206 9U94-18080-AA AT-621 ASH-25824 9U9Z-18125-A ASH-1023 ASH-1230 ASH-137	00	83122	00	00	00	00	00	00	00	00	00
	MotorHomes with Ford F53 Chassis with 16,000 lb GVW to 22,000 lb GVW 89000 Series	ASH-1229 ASH-1228 9U94-18045-AA ASH-1205 AT-620 ASH-1022 1C34-18045-AA ASH-294 9U9Z-18124-A ASH-25822 ASH-25823 1C34-18045-JA AT-766	00	89414	00	00	00	00	00	00	00	00	00
	ASH-1206 9U94-18080-AA AT-621 ASH-25824 9U9Z-18125-A ASH-1023 ASH-1230 ASH-137	00	89406	00	00	00	00	00	00	00	00	00	00

TIFFIN

TIFFIN

ALLEGRO OPEN ROAD



25	34PA, F53 Chassis with 16,000 lb GVW to 22,000 lb GVW	6U9Z18124D	00	83209	00	00	00	00	00	00	00	00	00
----	---	------------	----	-------	----	----	----	----	----	----	----	----	----

TURTLETOP BUS VARIOUS

TURTLETOP BUS

06-10	Odyssey Series Shuttle buses with Ford E450 Chassis To 2020 LTV Severe Duty	ASH-1136	00	58623	00	00	00	00	00	00	00	00	00
	Odyssey Series Shuttle buses with Ford E450 Chassis To 2020 Max Control	ASH-1136	00	77623	00	00	00	00	00	00	00	00	00
	Odyssey Series Shuttle buses with Ford E450 Chassis To 2020 Ultra Truck Shock	ASH-1136	00	G63623	00	00	00	00	00	00	00	00	00
	Odyssey Series Shuttle buses with Ford E450 Chassis To 2022 LTV Severe Duty	ASH-1154	00	58622	00	00	00	00	00	00	00	00	00
	Odyssey Series Shuttle buses with Ford E450 Chassis To 2022 Max Control	ASH-1154	00	77614	00	00	00	00	00	00	00	00	00
	Odyssey Series Shuttle buses with Ford E450 Chassis To 2022 Ultra Truck Shock	ASH-1154	00	G63622	00	00	00	00	00	00	00	00	00
	Terra Transit Series Shuttle buses with Ford E350 & E450 Chassis To 2020 LTV Severe Duty	ASH-1154 ASH-1136	00	58622 58623	00	00	00	00	00	00	00	00	00
	Terra Transit Series Shuttle buses with Ford E350 & E450 Chassis To 2020 Max Control	ASH-1154 ASH-1136	00	77614 77623	00	00	00	00	00	00	00	00	00
	Terra Transit Series Shuttle buses with Ford E350 & E450 Chassis To 2020 Ultra Truck Shock	ASH-1154	00	G63622	00	00	00	00	00	00	00	00	00

APPLICATION GUIDE

Year	Fitment Notes	OEM#								
			Fleetline/ Gas SLX	Classic/ Ultra/ ProGuard/ Guardian	Max Control/ LTV Severe Duty/ Load Carrier	Steering Dampers/ Steering Stabilizer/ Cab Shock	Fleetline/ Gas SLX	Classic/ Ultra/ ProGuard/ Guardian	Max Control/ LTV Severe Duty/ Load Carrier/ HiJackers	Steering Dampers/ Steering Stabilizer/ Cab Shock

TURTLETOP BUS

TURTLETOP BUS

VARIOUS (cont)

	Terra Transit Series Shuttle buses with Ford E350 & E450 Chassis To 2020 Ultra Truck Shock	ASH-1136	I O	I O	G63623
	Vanterra Series Shuttle buses with Ford E350 Chassis To 2020 LTV Severe Duty	ASH-1154	I O	58622	I O
		ASH-1136	I O	I O	58623
	Vanterra Series Shuttle buses with Ford E350 Chassis To 2020 Max Control	ASH-1154	I O	77614	I O
		ASH-1136	I O	I O	77623
	Vanterra Series Shuttle buses with Ford E350 Chassis To 2020 Ultra Truck Shock	ASH-1154	I O	G63622	I O
		ASH-1136	I O	I O	G63623

UD

UD

1200

99-04	Models with O.E.M. Number	E61000T825 561000T825	I O	83515	I O
-------	---------------------------	--------------------------	--------	-------	------	------	------	--------	------	------	------	------

1300

05-07	Models with O.E.M. Number	E61000T825 561000T825	I O	83515	I O
-------	---------------------------	--------------------------	--------	-------	------	------	------	--------	------	------	------	------

1400

94-10	Models with O.E.M. Number	E61000T825 561000T825	I O	83515	I O
-------	---------------------------	--------------------------	--------	-------	------	------	------	--------	------	------	------	------

1800

89-94	Models with O.E.M. Number	56101-Z5008 56110-Z5008	I O	83114	I O
-------	---------------------------	----------------------------	--------	-------	------	------	------	--------	------	------	------	------

1800CS

99-04	Models with O.E.M. Number	56101-Z5008 56110-Z5008	I O	83114	I O
-------	---------------------------	----------------------------	--------	-------	------	------	------	--------	------	------	------	------

2000

89-94	Models with O.E.M. Number	56101-Z5008 56110-Z5008	I O	83114	I O
-------	---------------------------	----------------------------	--------	-------	------	------	------	--------	------	------	------	------

2600

89-13	Models with O.E.M. Number	56110-Z5014 56110-Z5017 56101-Z5014 56101-Z5017	I O	83162	I O
-------	---------------------------	--	--------	-------	------	------	------	--------	------	------	------	------

UD 18HD SERIES

99-10	Models with 22.5" Tires Ultra Truck Shock	56110-30Z02 56101-30Z02	I O	G63610	I O
-------	---	----------------------------	--------	------	--------	------	------	--------	------	------	------	------

UD 1300

	UD 1300 Models Steer Axle Ultra Truck Shock	66400 56110-T8123 56110-T8129	I O	G63432	I O
--	---	-------------------------------------	--------	------	--------	------	------	--------	------	------	------	------

UD 1800 SERIES

11-13	Models with 22.5" Tires Ultra Truck Shock	56110-30Z02 56101-30Z02	I O	G63610	I O
95-98	Models with 22.5" Tires Ultra Truck Shock	56110-30Z02 56101-30Z02	I O	G63610	I O

UD 2000 SERIES

95-13	Models with 22.5" Tires Ultra Truck Shock	56110-30Z02 56101-30Z02	I O	G63610	I O
-------	---	----------------------------	--------	------	--------	------	------	--------	------	------	------	------

APPLICATION GUIDE

Year	Fitment Notes	OEM#								
			Fleetline\ Gas SLX	Classic\ Ultra\ ProGuard\ Guardian	Max Control\ LTV Severe Duty\ Load Carrier	Steering Dampers\ Steering Stabilizer\ Cab Shock	Fleetline\ Gas SLX	Classic\ Ultra\ ProGuard\ Guardian	Max Control\ LTV Severe Duty\ Load Carrier\ HiJackers	Steering Dampers\ Steering Stabilizer\ Cab Shock

UPS TRUCK VARIOUS

UPS TRUCK

Models with O.E.M. Number 83000 Series	P117099	oio	83120	oio	oio	oio	oio	oio	oio
--	---------	-----	-------	-----	-----	-----	-----	-----	-----

WHEELED COACH IND.

WHEELED COACH IND.

Citimedic models with Ford E350 & E450 Chassis LTV Severe Duty	ASH-1136	oio	oio	oio	oio	oio	oio	oio	oio
Citimedic models with Ford E350 & E450 Chassis Max Control	ASH-1136	oio	oio	oio	oio	oio	oio	oio	oio
Citimedic models with Ford E350 & E450 Chassis To 2022 LTV Severe Duty	ASH-1154	oio	oio	oio	oio	oio	oio	oio	oio
Citimedic models with Ford E350 & E450 Chassis To 2022 Max Control	ASH-1154	oio	oio	oio	oio	oio	oio	oio	oio
Citimedic models with Ford E350 & E450 Chassis To 2022 Ultra Truck Shock	ASH-1154	oio	oio	oio	oio	oio	oio	oio	oio
Citimedic models with Ford E350 & E450 Chassis Ultra Truck Shock	ASH-1136	oio	oio	oio	oio	oio	oio	oio	oio

WINNEBAGO ACCESS

WINNEBAGO

07-13	MotorHomes with Ford E350 or E450 Chassis	8C2Z-18124-D 8C24-18045-DA ASH-1154 AT-163G	oio	oio	oio	oio	oio	oio	oio
		8C24-18080-DB ASH-1136 8C2Z-18125-D AT-164G	oio	oio	oio	oio	oio	oio	oio



ACCESS PREMIER

14	MotorHomes with Ford E350 or E450 Chassis	8C2Z-18124-D 8C24-18045-DA ASH-1154 AT-163G	oio	oio	oio	oio	oio	oio	oio
		8C24-18080-DB ASH-1136 8C2Z-18125-D AT-164G	oio	oio	oio	oio	oio	oio	oio

ADVENTURER

19-24	MotorHomes with Ford F53 Chassis with 24,000 lb GVW to 26,000 lb GVW	ASH-25821 ASH-1161	oio	oio	oio	oio	oio	oio	oio
19-23	Motorhomes with Ford F-53 Chassis with 16,000 lb GVW to 22,000 lb GVW	ASH-1206 9U94-18080-AA 9U9Z-18125-B AT-621 ASH-25825 ASH-25824 9U9Z-18125-A ASH-1023 ASH-1230 ASH-137 HU9Z-18125-B	oio	oio	oio	oio	oio	oio	oio
	MotorHomes with Ford F53 Chassis with 16,000 lb GVW to 22,000 lb GVW	ASH-1229 ASH-1228 9U94-18045-AA ASH-1205 AT-620 ASH-1022 1C34-18045-AA ASH-294 9U9Z-18124-A ASH-25822 ASH-25823 1C34-18045-JA AT-766	oio	oio	oio	oio	oio	oio	oio
	MotorHomes with Ford F53 Chassis with 24,000 lb GVW to 26,000 lb GVW	ASH-25820 ASH-1162	oio	oio	oio	oio	oio	oio	oio

APPLICATION GUIDE

Year	Fitment Notes	OEM#								
			Fleetline/ Gas SLX	Classic/ Ultra/ ProGuard/ Guardian	Max Control/ LTV Severe Duty/ Load Carrier	Steering Dampers/ Steering Stabilizer/ Cab Shock	Fleetline/ Gas SLX	Classic/ Ultra/ ProGuard/ Guardian	Max Control/ LTV Severe Duty/ Load Carrier/ HiJackers	Steering Dampers/ Steering Stabilizer/ Cab Shock

WINNEBAGO

WINNEBAGO



ADVENTURER (cont)

08-17	MotorHomes with Ford F53 Chassis with 24,000 lb GVW to 26,000 lb GVW	ASH-25821 ASH-1161	O	85006	
		ASH-25820 ASH-1162	O	85005 89430
06-17	Motorhomes with Ford F-53 Chassis with 16,000 lb GVW to 22,000 lb GVW	ASH-1206 9U94-18080-AA 9U9Z-18125-B AT-621 ASH-25825 ASH-25824 9U9Z-18125-A ASH-1023 ASH-1230 ASH-137 HU9Z-18125-B	O	83122 89406
		ASH-1229 ASH-1228 9U94-18045-AA ASH-1205 AT-620 ASH-1022 1C34-18045-AA ASH-294 9U9Z-18124-A ASH-25822 ASH-25823 1C34-18045-JA AT-766	O	83209
98-11	Models with W20 & W22 Workhorse Motorhome Chassis	24-153249 F4-BE5-B492-HO W0005662 W0006254 24-186629 F4-BE5-A832-MO F4-BE5-F324-HO	O	85125
		W0005663 F4-BE5-F325-HO 24-153256	O	85124
04-09	Models with Workhorse W22, & W24 MotorHome Chassis with O.E.M. Number	W0005663 F4-BE5-F325-HO 24-153256	O	85124
99-04	Motorhomes with Ford F-53 Chassis with 16,000 lb GVW to 22,000 lb GVW	ASH-1206 9U94-18080-AA 9U9Z-18125-B AT-621 ASH-25825 ASH-25824 9U9Z-18125-A ASH-1023 ASH-1230 ASH-137 HU9Z-18125-B	O	83122 89406
		ASH-1229 ASH-1228 9U94-18045-AA ASH-1205 AT-620 ASH-1022 1C34-18045-AA ASH-294 9U9Z-18124-A ASH-25822 ASH-25823 1C34-18045-JA AT-766	O

ASPECT

18-20	MotorHomes with Ford E350 or E450 Chassis LTV Severe Duty	8C2Z-18124-D 8C24-18045-DA ASH-1154 AT-163G	O	58622
		8C24-18080-DB ASH-1136 8C2Z-18125-D AT-164G	O	58623
	MotorHomes with Ford E350 or E450 Chassis Max Control	8C2Z-18124-D 8C24-18045-DA ASH-1154 AT-163G	O	77614
		8C24-18080-DB ASH-1136 8C2Z-18125-D AT-164G	O	77623
	MotorHomes with Ford E350 or E450 Chassis Ultra Truck Shock	8C2Z-18124-D 8C24-18045-DA ASH-1154 AT-163G	O	G63622
		8C24-18080-DB ASH-1136 8C2Z-18125-D AT-164G	O	G63623
06-17	MotorHomes with Ford E350 or E450 Chassis	8C2Z-18124-D 8C24-18045-DA ASH-1154 AT-163G	O	G63622	58622 77614

APPLICATION GUIDE

Year	Fitment Notes	OEM#								
			Fleetline\ Gas SLX	Classic\ Ultra\ ProGuard\ Guardian	Max Control\ LTV Severe Duty\ Load Carrier	Steering Dampers\ Steering Stabilizer\ Cab Shock	Fleetline\ Gas SLX	Classic\ Ultra\ ProGuard\ Guardian	Max Control\ LTV Severe Duty\ Load Carrier\ HiJackers	Steering Dampers\ Steering Stabilizer\ Cab Shock

WINNEBAGO

WINNEBAGO

ASPECT (cont)

06-17	MotorHomes with Ford E350 or E450 Chassis	8C24-18080-DB ASH-1136 8C2Z-18125-D AT-164G											
05	MotorHomes with Ford E350 or E450 Chassis	8C24-18045-DA											

CAMBRIA

18-20	MotorHomes with Ford E350 or E450 Chassis LTV Severe Duty	8C2Z-18124-D 8C24-18045-DA ASH-1154 AT-163G											
		8C24-18080-DB ASH-1136 8C2Z-18125-D AT-164G											
	MotorHomes with Ford E350 or E450 Chassis Max Control	8C2Z-18124-D 8C24-18045-DA ASH-1154 AT-163G											
		8C24-18080-DB ASH-1136 8C2Z-18125-D AT-164G											
	MotorHomes with Ford E350 or E450 Chassis Ultra Truck Shock	8C2Z-18124-D 8C24-18045-DA ASH-1154 AT-163G											
		8C24-18080-DB ASH-1136 8C2Z-18125-D AT-164G											
16-17	MotorHomes with Ford E350 or E450 Chassis	8C2Z-18124-D 8C24-18045-DA ASH-1154 AT-163G											
		8C24-18080-DB ASH-1136 8C2Z-18125-D AT-164G											
09-15	MotorHomes with Ford E350 or E450 Chassis LTV Severe Duty	8C2Z-18124-D 8C24-18045-DA ASH-1154 AT-163G											
		8C24-18080-DB ASH-1136 8C2Z-18125-D AT-164G											
	MotorHomes with Ford E350 or E450 Chassis Max Control	8C2Z-18124-D 8C24-18045-DA ASH-1154 AT-163G											
		8C24-18080-DB ASH-1136 8C2Z-18125-D AT-164G											
	MotorHomes with Ford E350 or E450 Chassis Ultra Truck Shock	8C2Z-18124-D 8C24-18045-DA ASH-1154 AT-163G											
		8C24-18080-DB ASH-1136 8C2Z-18125-D AT-164G											
05-08	MotorHomes with Ford E350 or E450 Chassis	8C2Z-18124-D 8C24-18045-DA ASH-1154 AT-163G											
		8C24-18080-DB ASH-1136 8C2Z-18125-D AT-164G											

APPLICATION GUIDE

Year	Fitment Notes	OEM#								
				Fleetline/ Gas SLX	Classic/ Ultra/ ProGuard/ Guardian	Max Control/ LTV Severe Duty/ Load Carrier	Steering Dampers/ Steering Stabilizer/ Cab Shock		Fleetline/ Gas SLX	Classic/ Ultra/ ProGuard/ Guardian

WINNEBAGO

EKKO

WINNEBAGO

21-22	MotorHomes with Ford Transit-350 Chassis			G57816 ⁶⁰		O	O	G64177
-------	--	--	--	----------------------	------	------	--	---	---	------	--------	------	------

INTENT

18-20	Motorhome Chassis with 16,000 lb GVW to 18,000 lb GVW	9U9Z-18125-B ASH-25825		O	O	83122
	Motorhome Chassis with 20,500 lb GVW to 22,000 lb GVW	ASH-1206 9U94-18080-AA AT-621 ASH-25824 9U9Z-18125-A ASH-1023 ASH-1230 ASH-137 HU9Z-18125-B		O	O	83122 89406
	MotorHomes with Ford F53 Chassis with 16,000 lb GVW to 22,000 lb GVW	ASH-1229 ASH-1228 ASH-1205 ASH-294 ASH-25822 ASH-1022 ASH-25823	O	83209

JOURNEY

02-06	MotorHomes with Freightliner XC Chassis and ADL200 Suspension w/ 20K Rear	16-16873-000 141700131809 16-16736-000		O	O	85029
	MotorHomes with Freightliner XC Chassis and AS120 Front Suspension	16-16874-000 16-16737-000 141700131810	O	83160



MINNIE

06-20	MotorHomes with Ford E350 or E450 Chassis LTV Severe Duty	8C2Z-18124-D 8C24-18045-DA ASH-1154 AT-163G	O	58622	O	O
		8C24-18080-DB ASH-1136 8C2Z-18125-D AT-164G	O	O	O	58623
	MotorHomes with Ford E350 or E450 Chassis Max Control	8C2Z-18124-D 8C24-18045-DA ASH-1154 AT-163G	O	77614	O	O
		8C24-18080-DB ASH-1136 8C2Z-18125-D AT-164G	O	O	O	77623
	MotorHomes with Ford E350 or E450 Chassis Ultra Truck Shock	8C2Z-18124-D 8C24-18045-DA ASH-1154 AT-163G	O	G63622	O	O
		8C24-18080-DB ASH-1136 8C2Z-18125-D AT-164G	O	O	O	G63623

00-05	MotorHomes with Ford E350 or E450 Chassis	8C2Z-18124-D 8C24-18045-DA ASH-1154 AT-163G	O	G63622	58622 77614	O	O
		8C24-18080-DB ASH-1136 8C2Z-18125-D AT-164G	O	O	O	G63623	58623 77623

99	MotorHomes with Ford E350 or E450 Chassis LTV Severe Duty	8C2Z-18124-D 8C24-18045-DA ASH-1154 AT-163G	O	58622	O	O
		8C24-18080-DB ASH-1136 8C2Z-18125-D AT-164G	O	O	O	58623

APPLICATION GUIDE

Year	Fitment Notes	OEM#								
			Fleetline\ Gas SLX	Classic\ Ultra\ ProGuard\ Guardian	Max Control\ LTV Severe Duty\ Load Carrier	Steering Dampers\ Steering Stabilizer\ Cab Shock	Fleetline\ Gas SLX	Classic\ Ultra\ ProGuard\ Guardian	Max Control\ LTV Severe Duty\ Load Carrier\ HiJackers	Steering Dampers\ Steering Stabilizer\ Cab Shock

WINNEBAGO

WINNEBAGO

MINNIE (cont)

99	MotorHomes with Ford E350 or E450 Chassis Max Control	8C2Z-18124-D 8C24-18045-DA ASH-1154 AT-163G												
		8C24-18080-DB ASH-1136 8C2Z-18125-D AT-164G												
	MotorHomes with Ford E350 or E450 Chassis Ultra Truck Shock	8C2Z-18124-D 8C24-18045-DA ASH-1154 AT-163G												
		8C24-18080-DB ASH-1136 8C2Z-18125-D AT-164G												



MINNIE WINNIE

14-24	MotorHomes with Ford E350 or E450 Chassis	8C2Z-18124-D 8C24-18045-DA ASH-1154 AT-163G											
		8C24-18080-DB ASH-1136 8C2Z-18125-D AT-164G											
00-06	MotorHomes with Ford E350 or E450 Chassis	8C2Z-18124-D 8C24-18045-DA ASH-1154 AT-163G											
		8C24-18080-DB ASH-1136 8C2Z-18125-D AT-164G											

OUTLOOK

19-21	MotorHomes with Ford E350 or E450 Chassis	8C2Z-18124-D 8C24-18045-DA ASH-1154 AT-163G												
		8C24-18080-DB ASH-1136 8C2Z-18125-D AT-164G												
11-18	MotorHomes with Ford E350 or E450 Chassis LTV Severe Duty	8C2Z-18124-D 8C24-18045-DA ASH-1154 AT-163G												
		8C24-18080-DB ASH-1136 8C2Z-18125-D AT-164G												
	MotorHomes with Ford E350 or E450 Chassis Max Control	8C2Z-18124-D 8C24-18045-DA ASH-1154 AT-163G												
		8C24-18080-DB ASH-1136 8C2Z-18125-D AT-164G												
06-10	MotorHomes with Ford E350 or E450 Chassis	8C2Z-18124-D 8C24-18045-DA ASH-1154 AT-163G												
		8C24-18080-DB ASH-1136 8C2Z-18125-D AT-164G												

APPLICATION GUIDE

Year	Fitment Notes	OEM#								
			Fleetline/ Gas SLX	Classic/ Ultra/ ProGuard/ Guardian	Max Control/ LTV Severe Duty/ Load Carrier	Steering Dampers/ Steering Stabilizer/ Cab Shock	Fleetline/ Gas SLX	Classic/ Ultra/ ProGuard/ Guardian	Max Control/ LTV Severe Duty/ Load Carrier/ HiJackers	Steering Dampers/ Steering Stabilizer/ Cab Shock

WINNEBAGO

WINNEBAGO



SIGHTSEER

11-17	Motorhome Chassis with 16,000 lb GVW to 18,000 lb GVW	9U9Z-18125-B ASH-25825	O O	83122 89406
	Motorhome Chassis with 20,500 lb GVW to 22,000 lb GVW	ASH-1206 9U94-18080-AA AT-621 ASH-25824 9U9Z-18125-A ASH-1023 ASH-1230 ASH-137 HU9Z-18125-B	O O	83122 89406
02-17	MotorHomes with Ford F53 Chassis with 16,000 lb GVW to 22,000 lb GVW	ASH-1229 ASH-1228 9U94-18045-AA ASH-1205 AT-620 ASH-1022 1C34-18045-AA ASH-294 9U9Z-18124-A ASH-25822 ASH-25823 1C34-18045-JA AT-766	83209	O O
08-09	Motorhome Chassis with 16,000 lb GVW to 18,000 lb GVW	9U9Z-18125-B ASH-25825	O O	83122 89406
06-09	Motorhome Chassis with 20,500 lb GVW to 22,000 lb GVW	ASH-1206 9U94-18080-AA AT-621 ASH-25824 9U9Z-18125-A ASH-1023 ASH-1230 ASH-137 HU9Z-18125-B	O O	83122 89406
02-04	Motorhome Chassis with 20,500 lb GVW to 22,000 lb GVW	ASH-1206 9U94-18080-AA AT-621 ASH-25824 9U9Z-18125-A ASH-1023 ASH-1230 ASH-137 HU9Z-18125-B	O O	83122 89406

SPIRIT

16-22	MotorHomes with Ford E350 or E450 Chassis	8C2Z-18124-D 8C24-18045-DA ASH-1154 AT-163G	O	G63622	58622 77614
		8C24-18080-DB ASH-1136 8C2Z-18125-D AT-164G	O	G63623	58623 77623
08-15	MotorHomes with Ford E350 or E450 Chassis LTV Severe Duty	8C2Z-18124-D 8C24-18045-DA ASH-1154 AT-163G	O	58622
		8C24-18080-DB ASH-1136 8C2Z-18125-D AT-164G	O	58623
	MotorHomes with Ford E350 or E450 Chassis Max Control	8C2Z-18124-D 8C24-18045-DA ASH-1154 AT-163G	O	77614
		8C24-18080-DB ASH-1136 8C2Z-18125-D AT-164G	O	77623
	MotorHomes with Ford E350 or E450 Chassis Ultra Truck Shock	8C2Z-18124-D 8C24-18045-DA ASH-1154 AT-163G	O	G63622
		8C24-18080-DB ASH-1136 8C2Z-18125-D AT-164G	O	G63623

APPLICATION GUIDE

Year	Fitment Notes	OEM#								
			Fleetline\ Gas SLX	Classic\ Ultra\ ProGuard\ Guardian	Max Control\ LTV Severe Duty\ Load Carrier	Steering Dampers\ Steering Stabilizer\ Cab Shock	Fleetline\ Gas SLX	Classic\ Ultra\ ProGuard\ Guardian	Max Control\ LTV Severe Duty\ Load Carrier\ HiJackers	Steering Dampers\ Steering Stabilizer\ Cab Shock

WINNEBAGO

WINNEBAGO

SPIRIT (cont)

00-07	MotorHomes with Ford E350 or E450 Chassis	8C2Z-18124-D 8C24-18045-DA ASH-1154 AT-163G	OIO	G63622	58622 77614
		8C24-18080-DB ASH-1136 8C2Z-18125-D AT-164G	OIO	G63623	58623 77623



SUNOVA

16-17	Motorhome Chassis with 16,000 lb GVW to 18,000 lb GVW	9U9Z-18125-B ASH-25825	OIO	83122 89406
	Motorhome Chassis with 20,500 lb GVW to 22,000 lb GVW	ASH-1206 9U94-18080-AA AT-621 ASH-25824 9U9Z-18125-A ASH-1023 ASH-1230 ASH-137 HU9Z-18125-B	OIO	83122 89406
	MotorHomes with Ford F53 Chassis with 16,000 lb GVW to 22,000 lb GVW	ASH-1229 ASH-1228 9U94-18045-AA ASH-1205 AT-620 ASH-1022 1C34-18045-AA ASH-294 9U9Z-18124-A ASH-25822 ASH-25823 1C34-18045-JA AT-766	83209	OIO
06-07	Motorhome Chassis with 20,500 lb GVW to 22,000 lb GVW	ASH-1206 9U94-18080-AA AT-621 ASH-25824 9U9Z-18125-A ASH-1023 ASH-1230 ASH-137 HU9Z-18125-B	OIO	83122 89406
02-07	MotorHomes with Ford F53 Chassis with 16,000 lb GVW to 22,000 lb GVW	ASH-1229 ASH-1228 9U94-18045-AA ASH-1205 AT-620 ASH-1022 1C34-18045-AA ASH-294 9U9Z-18124-A ASH-25822 ASH-25823 1C34-18045-JA AT-766	83209	OIO
02-04	Motorhome Chassis with 20,500 lb GVW to 22,000 lb GVW	ASH-1206 9U94-18080-AA AT-621 ASH-25824 9U9Z-18125-A ASH-1023 ASH-1230 ASH-137 HU9Z-18125-B	OIO	83122 89406

SUNSTAR

16-24	MotorHomes with Ford F53 Chassis with 24,000 lb GVW to 26,000 lb GVW	ASH-25821 ASH-1161	OIO	85006
16-22	Motorhome Chassis with 16,000 lb GVW to 18,000 lb GVW	9U9Z-18125-B ASH-25825	OIO	83122 89406
	Motorhome Chassis with 20,500 lb GVW to 22,000 lb GVW	ASH-1206 9U94-18080-AA AT-621 ASH-25824 9U9Z-18125-A ASH-1023 ASH-1230 ASH-137 HU9Z-18125-B	OIO	83122 89406

APPLICATION GUIDE

Year	Fitment Notes	OEM#								
			Fleetline/ Gas SLX	Classic/ Ultra/ ProGuard/ Guardian	Max Control/ LTV Severe Duty/ Load Carrier	Steering Dampers/ Steering Stabilizer/ Cab Shock	Fleetline/ Gas SLX	Classic/ Ultra/ ProGuard/ Guardian	Max Control/ LTV Severe Duty/ Load Carrier/ HiJackers	Steering Dampers/ Steering Stabilizer/ Cab Shock

WINNEBAGO

WINNEBAGO

SUNSTAR (cont)

16-22	MotorHomes with Ford F53 Chassis with 16,000 lb GVW to 22,000 lb GVW	ASH-1229 ASH-1228 9U94-18045-AA ASH-1205 AT-620 ASH-1022 1C34-18045-AA ASH-294 9U9Z-18124-A ASH-25822 ASH-25823 1C34-18045-JA AT-766	OO	83209
	MotorHomes with Ford F53 Chassis with 24,000 lb GVW to 26,000 lb GVW	ASH-25820 ASH-1162	OO	85005 89430
02-04	Motorhome Chassis with 20,500 lb GVW to 22,000 lb GVW	ASH-1206 9U94-18080-AA AT-621 ASH-25824 9U9Z-18125-A ASH-1023 ASH-1230 ASH-137 HU9Z-18125-B	OO	83122 89406
	MotorHomes with Ford F53 Chassis with 16,000 lb GVW to 22,000 lb GVW	ASH-1229 ASH-1228 9U94-18045-AA ASH-1205 AT-620 ASH-1022 1C34-18045-AA ASH-294 9U9Z-18124-A ASH-25822 ASH-25823 1C34-18045-JA AT-766	OO	83209

SUNSTAR LX

16-18	Motorhome Chassis with 16,000 lb GVW to 18,000 lb GVW	9U9Z-18125-B ASH-25825	OO	83122 89406
	Motorhome Chassis with 20,500 lb GVW to 22,000 lb GVW	ASH-1206 9U94-18080-AA AT-621 ASH-25824 9U9Z-18125-A ASH-1023 ASH-1230 ASH-137 HU9Z-18125-B	OO	83122 89406
	MotorHomes with Ford F53 Chassis with 16,000 lb GVW to 22,000 lb GVW	ASH-1229 ASH-1228 ASH-1205 ASH-25822 ASH-1022 ASH-25823	OO	83209

TOUR

06	MotorHomes with Freightliner XC Chassis and ADL200 Suspension w/ 20K Rear	16-16873-000 141700131809 16-16736-000	OO	85029
	MotorHomes with Freightliner XC Chassis and AS120 Front Suspension	16-16874-000 16-16737-000 141700131810	OO	83160



VECTRA

06	MotorHomes with Freightliner XC Chassis and ADL200 Suspension w/ 20K Rear	16-16873-000 141700131809 16-16736-000	OO	85029
	MotorHomes with Freightliner XC Chassis and AS120 Front Suspension	16-16874-000 16-16737-000 141700131810	OO	83160

VISTA

08-24	MotorHomes with Ford F53 Chassis with 24,000 lb GVW to 26,000 lb GVW	ASH-25821 ASH-1161	OO	85006
-------	--	-----------------------	----	-------	------	------	------	------	------	------	------	------

APPLICATION GUIDE

Year	Fitment Notes	OEM#								
			Fleetline\ Gas SLX	Classic\ Ultra\ ProGuard\ Guardian	Max Control\ LTV Severe Duty\ Load Carrier	Steering Dampers\ Steering Stabilizer\ Cab Shock	Fleetline\ Gas SLX	Classic\ Ultra\ ProGuard\ Guardian	Max Control\ LTV Severe Duty\ Load Carrier\ HiJackers	Steering Dampers\ Steering Stabilizer\ Cab Shock

WINNEBAGO

WINNEBAGO



VISTA (cont)

11-22	Motorhome Chassis with 16,000 lb GVW to 18,000 lb GVW	9U9Z-18125-B ASH-25825	oio	oio	83122 89406
	Motorhome Chassis with 20,500 lb GVW to 22,000 lb GVW	ASH-1206 9U94-18080-AA AT-621 ASH-25824 9U9Z-18125-A ASH-1023 ASH-1230 ASH-137 HU9Z-18125-B	oio	oio	83122 89406
08-22	MotorHomes with Ford F53 Chassis with 24,000 lb GVW to 26,000 lb GVW	ASH-25820 ASH-1162	oio	oio	85005 89430
07-22	MotorHomes with Ford F53 Chassis with 16,000 lb GVW to 22,000 lb GVW	ASH-1229 ASH-1228 9U94-18045-AA ASH-1205 AT-620 ASH-1022 1C34-18045-AA ASH-294 9U9Z-18124-A ASH-25822 ASH-25823 1C34-18045-JA AT-766	oio	83209	oio
08-09	Motorhome Chassis with 16,000 lb GVW to 18,000 lb GVW	9U9Z-18125-B ASH-25825	oio	oio	83122 89406
07-09	Motorhome Chassis with 20,500 lb GVW to 22,000 lb GVW	ASH-1206 9U94-18080-AA AT-621 ASH-25824 9U9Z-18125-A ASH-1023 ASH-1230 ASH-137 HU9Z-18125-B	oio	oio	83122 89406
02-04	Motorhome Chassis with 20,500 lb GVW to 22,000 lb GVW	ASH-1206 9U94-18080-AA AT-621 ASH-25824 9U9Z-18125-A ASH-1023 ASH-1230 ASH-137 HU9Z-18125-B	oio	oio	83122 89406
	MotorHomes with Ford F53 Chassis with 16,000 lb GVW to 22,000 lb GVW	ASH-1229 ASH-1228 9U94-18045-AA ASH-1205 AT-620 ASH-1022 1C34-18045-AA ASH-294 9U9Z-18124-A ASH-25822 ASH-25823 1C34-18045-JA AT-766	oio	83209	oio

VISTA LX

16-18	Motorhome Chassis with 16,000 lb GVW to 18,000 lb GVW	9U9Z-18125-B ASH-25825	oio	oio	83122 89406
	Motorhome Chassis with 20,500 lb GVW to 22,000 lb GVW	ASH-1206 9U94-18080-AA AT-621 ASH-25824 9U9Z-18125-A ASH-1023 ASH-1230 ASH-137 HU9Z-18125-B	oio	oio	83122 89406
	MotorHomes with Ford F53 Chassis with 16,000 lb GVW to 22,000 lb GVW	ASH-1229 ASH-1228 ASH-1205 ASH-25822 ASH-1022 ASH-25823	oio	83209	oio

APPLICATION GUIDE

Year	Fitment Notes	OEM#								
			Fleetline/ Gas SLX	Classic/ Ultra/ ProGuard/ Guardian	Max Control/ LTV Severe Duty/ Load Carrier	Steering Dampers/ Steering Stabilizer/ Cab Shock	Fleetline/ Gas SLX	Classic/ Ultra/ ProGuard/ Guardian	Max Control/ LTV Severe Duty/ Load Carrier/ HiJackers	Steering Dampers/ Steering Stabilizer/ Cab Shock

WORKHORSE

VARIOUS

	Models with O.E.M. Number 83000 Series	W0011635	O	83221
	Models with O.E.M. Number Ultra Truck Shock	W0011636	O	G63366
	Models with RSAS Rear Suspension 85000 Series	7805-X-1012	O	85919
	Step Van Models with O.E.M. Number Ultra Truck Shock	W0007365	O	G63866
	UFO Motorhome Chassis with Hendrickson Softek Front Suspension 83000 Series	66153-002 F4-BE5-C832-MO	O	83124
	UFO Motorhome Chassis with Hendrickson Softek Front Suspension 89000 Series	66153-002 F4-BE5-C832-MO	O	89407

WORKHORSE

W20

04-09	Models with O.E.M. Number	W0005663 F4-BE5-F325-HO 24-153256	I	85124
01-09	All	24-153249 F4-BE5-B492-HO W0005662 W0006254 24-186629 F4-BE5-A832-MO F4-BE5-F324-HO	O	85125

W22

04-09	Models with O.E.M. Number	W0005663 F4-BE5-F325-HO 24-153256	I	85124
01-09	All	24-153249 F4-BE5-B492-HO W0005662 W0006254 24-186629 F4-BE5-A832-MO F4-BE5-F324-HO	O	85125

W24

04-09	Models with O.E.M. Number	W0005663 F4-BE5-F325-HO 24-153256	I	85124
	MotorHome Chassis with O.E.M. Number	24-153249 F4-BE5-B492-HO W0005662 W0006254 24-186629 F4-BE5-A832-MO F4-BE5-F324-HO	O	85125

WORLD TRANS BUS CO.

VARIOUS

	E & G Series Commercial buses on Ford E350 or E450 Chassis LTV Severe Duty	ASH-1154	I	58622
		ASH-1136	O	58623
	E & G Series Commercial buses on Ford E350 or E450 Chassis Max Control	ASH-1154	I	77614
		ASH-1136	O	77623
	E & G Series Commercial buses on Ford E350 or E450 Chassis Ultra Truck Shock	ASH-1154	I	G63622
		ASH-1136	O	G63623

WORLD TRANS BUS CO.



XOS

ADDITIONAL O.E.M. INTERCHANGES

	Medium Duty Electric Trucks with Hendrickson Softek Suspension (10K Capacity) 85000 Series	58913-009L 58913-009	O	85959
--	--	-------------------------	---	-------	------	------	------	------	------	------	------	------

XOS

APPLICATION GUIDE

Year	Fitment Notes	OEM#								
			Fleetline\ Gas SLX	Classic\ Ultra\ ProGuard\ Guardian	Max Control\ LTV Severe Duty\ Load Carrier	Steering Dampers\ Steering Stabilizer\ Cab Shock	Fleetline\ Gas SLX	Classic\ Ultra\ ProGuard\ Guardian	Max Control\ LTV Severe Duty\ Load Carrier\ HiJackers	Steering Dampers\ Steering Stabilizer\ Cab Shock

XOS

XOS

ADDITIONAL O.E.M. INTERCHANGES (cont)

	Medium Duty Trucks With Hendrickson HTS Suspension (16K Capacity) 85000 Series	60665-025 60665-025L	O O O	85036
	Medium Duty Trucks With Hendrickson HTS Suspension (16K Capacity) 89000 Series	60665-025 60665-025L	O O O	89405

Numerical listing

Steering Dampers, Steering Stabilizer, Front Load Carrier, Rear Load Carrier, HiJackers, Ultra ReadyMount, LTV Severe Duty

Numerical listing

Shock	POP	Alternative No.	MTG Acc. Supplied
Pos.	Year	Application	

Steering Dampers

14072	A		
F	20-24	FORD F-600 SUPER DUTY All	
F	08-24	PICKUP, F-450 SUPERDUTY 4 X 4	
F	08-24	PICKUP, F-550 SUPERDUTY 4 X 4	

Steering Stabilizer

6802SE	B		141998
F	79-82	DODGE D50 RWD Single System Steering Stabilizer All models with factory frame bracket. Kit 143168 required to install to linkage.	
F	87-89	RAIDER All Single System Steering Stabilizer All models with factory frame bracket. Kit 143168 required to install to linkage.	
F	90-92	FORD F-SUPER DUTY All Single System Steering Stabilizer All models with factory frame bracket. Kit 143168 required to install to linkage.	
F	68-73	PICKUP P350 All Single System Steering Stabilizer All models with factory frame bracket. Kit 143168 required to install to linkage.	
F	68-71	INTERNATIONAL M800 All Single System Steering Stabilizer; 1/2 and 3/4 Ton I-Beam Axle All models with factory frame bracket. Kit 143168 required to install to linkage.	
F	68-72	M1100 / M1200 All Single System Steering Stabilizer; 1/2 and 3/4 Ton I-Beam Axle All models with factory frame bracket. Kit 143168 required to install to linkage.	
F	69	M1400 All Single System Steering Stabilizer; 1/2 and 3/4 Ton I-Beam Axle All models with factory frame bracket. Kit 143168 required to install to linkage.	

6828SE	D		142718
F	00-02	FORD E-450 ECONOLINE SUPER DUTY All Single System Steering Stabilizer	
F	02	E-550 ECONOLINE SUPER DUTY All Single System Steering Stabilizer	
F	03	E-550 SUPER DUTY All Single System Steering Stabilizer	
F	21-24	VAN 1 TON, ECONOLINE / CLUB WAGON / SUPERDUTY All Single System Steering Stabilizer	
F	03-19	VAN 1 TON, ECONOLINE / CLUB WAGON / SUPERDUTY All Single System Steering Stabilizer	

6854SE	C		142718
F	99-04	FORD PICKUP, F-450 SUPERDUTY 4 X 4 Single System Steering Stabilizer	
F	99-04	PICKUP, F-550 SUPERDUTY 4 X 4 Single System Steering Stabilizer	

Front Load Carrier

34076	A		140780
F	10-19	FORD VAN 1 TON, ECONOLINE / CLUB WAGON / SUPERDUTY All	

Rear Load Carrier

43048	A		
R	79-82	DODGE D50 RWD	
F	68-76	FORD PICKUP P350 All Up through 8000# GVW	
F	75-76	PICKUP P400 All Up through 8000# GVW	
R	68-72	INTERNATIONAL M1100 / M1200 All	
R	69	M1400 All	

43140	A		141150
R	66-67	FIAT 1100 All Exc. Wagon	
R	64-65	1500 All Exc. Wagon	

43167	A		
R	88-97	FORD F-SUPER DUTY All PICKUP, F-450 SUPERDUTY All	

HiJackers

49178	B		140126,141099
R	21-24	FORD VAN 1 TON, ECONOLINE / CLUB WAGON / SUPERDUTY All	
R	10-19	VAN 1 TON, ECONOLINE / CLUB WAGON / SUPERDUTY All	

Shock	POP	Alternative No.	MTG Acc. Supplied
Pos.	Year	Application	

49310	D		140788,141099
R	79-82	DODGE D50 RWD	
R	67	FIAT 124 Wagon	
R	66	124 All Wagon	
R	66-67	1100 All Wagon	
R	66-67	1500 All Wagon	
R	68-72	INTERNATIONAL M1100 / M1200 All	
R	69	M1400 All	

49311	A		141099
R	87-89	DODGE RAIDER 2.6L 4Cyl L (156)	

Ultra ReadyMount

G57800	A		
F	25	COACHMEN NOVA 20C Left THOR MOTOR COACH DAZZLE 2JB Left	
F	24	SCOPE 18M Left	

G57801	A		
F	25	COACHMEN NOVA 20C Right THOR MOTOR COACH DAZZLE 2JB Right	
F	24	SCOPE 18M Right	

G57816	D		
F	19-22	COACH HOUSE PLATINUM III All MotorHomes with Ford Transit-350 Chassis	
F	19-22	COACHMEN BEYOND All MotorHomes with Ford Transit-350 Chassis	
F	21-22	CROSS TRAIL TRANSIT All MotorHomes with Ford Transit-350 Chassis	
F	17-22	FOREST RIVER FORESTER TS All MotorHomes with Ford Transit-350 Chassis	
F	17-22	SUNSEEKER TS All MotorHomes with Ford Transit-350 Chassis	
F	19-22	LEISURE TRAVEL WONDER All MotorHomes with Ford Transit-350 Chassis	
F	20-22	PHOENIX TRX All MotorHomes with Ford Transit-350 Chassis	
F	19-22	THOR MOTOR COACH GEMINI All MotorHomes with Ford Transit-350 Chassis	
F	21-22	WINNEBAGO EKKO All MotorHomes with Ford Transit-350 Chassis	

LTV Severe Duty

58622	W		142617
F	17-24	BERKSHIRE COACH ULTRA 24	
F	17-24	ULTRA 28	
F	92-24	BLUE BIRD MICROBIRD TYPE A SCHOOL BUS	
F		CHAMPION BUS INC. AMERICAN COACH	
F		CHALLENGER	
F		CRUSADER	
F		LF TRANSPORT	
F	03-24	COACH HOUSE PLATINUM All Motorhomes with Ford E450 Chassis	
F	23-24	PLATINUM IV All Motorhomes with Ford E450 Chassis	
F		COACHMEN CATALINA	
F	20-22	CONCORD	
F	04-06	CONCORD	
F	23-24	CONCORD All MotorHomes with Ford E350 or E450 Chassis	
F	07-19	CONCORD All MotorHomes with Ford E350 or E450 Chassis	
F	04-08	FREEDOM EXPRESS	
F	09	FREEDOM EXPRESS All MotorHomes with Ford E350 or E450 Chassis	
F	03-07	FREELANDER	
F	08-24	FREELANDER All MotorHomes with Ford E350 or E450 Chassis	
F	10	LEPRECHAUN	
F	03-07	LEPRECHAUN	
F	11-24	LEPRECHAUN All MotorHomes with Ford E350 or E450 Chassis	
F	08-09	LEPRECHAUN All MotorHomes with Ford E350 or E450 Chassis	
F	98-03	PATHFINDER	
F	99-06	SANTARA	
F		COLLINS BUS CORP. VARIOUS DIAMOND COACH SHUTTLE BUSES	
F	92-09	DUTCHMEN RV CLASS C MOTORHOMES	

Shock	POP	Alternative No.	MTG Acc. Supplied
Pos.	Year	Application	

58622	W (cont)		142617
F	15-20	JAMBOREE	
F	92-17	DYNAMAX CORP ISATA 4	
F	18-20	ISATA 4 All MotorHomes with Ford E350 or E450 Chassis	
F		ELDORADO NATIONAL ADVANTAGE	
F		AEROLITE	
F		AEROTECH	
F	17	ENTEGR COACH ESTEEM	
F	18-24	ESTEEM All MotorHomes with Ford E350 or E450 Chassis	
F	17	ODYSSEY	
F	18-24	ODYSSEY All MotorHomes with Ford E350 or E450 Chassis	
F	23-24	ODYSSEY SE All MotorHomes with Ford E450 Chassis	
F		FEDERAL COACH VARIOUS FLEETWOOD JAMBOREE	
F	14-16	JAMBOREE	
F	99-07	JAMBOREE	
F	17-19	JAMBOREE All MotorHomes with Ford E350 or E450 Chassis	
F	08-13	JAMBOREE All MotorHomes with Ford E350 or E450 Chassis	
F	19-20	SURGE	
F	18	SURGE All MotorHomes with Ford E350 or E450 Chassis	
F	14-16	TIOGA	
F	99-07	TIOGA	
F	08-13	TIOGA All MotorHomes with Ford E350 or E450 Chassis	
F	00-02	FORD E-450 ECONOLINE SUPER DUTY All	
F	21-24	VAN 1 TON, ECONOLINE / CLUB WAGON / SUPERDUTY All	
F	03-19	VAN 1 TON, ECONOLINE / CLUB WAGON / SUPERDUTY All	
F		FOREST RIVER ALL AMERICAN FORESTER	
F	04-19	FORESTER All MotorHomes with Ford E350 or E450 Chassis	
F	15-18	FORESTER GTS All MotorHomes with Ford E350 or E450 Chassis	
F	03-15	LEXINGTON All MotorHomes with Ford E350 or E450 Chassis	
F	21-24	SOLERA All MotorHomes with Ford E350 or E450 Chassis	
F	10-15	SOLERA All MotorHomes with Ford E350 or E450 Chassis	
F	23	SUNSEEKER	
F	99-06	SUNSEEKER	
F	07-22	SUNSEEKER All MotorHomes with Ford E350 or E450 Chassis	
F	19-20	SUNSEEKER GTS	
F	15-18	SUNSEEKER GTS All MotorHomes with Ford E350 or E450 Chassis	
F	99-09	GEORGIE BOY MANUFACTURING CLASS C MOTORHOMES	
F		GLAVAL BUS CO. VARIOUS	
F		GOSHEN COACH VARIOUS	
F		GRECH MOTORS VARIOUS	
F	02-15	GULF STREAM BT CRUISER	
F	16-24	BT CRUISER All MotorHomes with Ford E350 or E450 Chassis	
F	99-06	CAVALIER	
F	12-15	CONQUEST	
F	93-01	CONQUEST	
F	16-24	CONQUEST All MotorHomes with Ford E350 or E450 Chassis	
F	02-11	CONQUEST All MotorHomes with Ford E350 or E450 Chassis	
F	10-11	CONQUEST SPORT All MotorHomes with Ford E350 or E450 Chassis	
F	01-02	CONQUEST SPORT All MotorHomes with Ford E350 or E450 Chassis	
F	00-11	INDEPENDENCE All MotorHomes with Ford E350 or E450 Chassis	
F	10-11	MONTAJ All MotorHomes with Ford E350 or E450 Chassis	
F	00-08	ULTRA	
F	02-04	YELLOWSTONE	
F	05-11	YELLOWSTONE All MotorHomes with Ford E350 or E450 Chassis	
F	19	HOLIDAY RAMBLER ALTERA	
F	18	ALTERA All MotorHomes with Ford E450 Chassis	
F	08	ATLANTIS	
F	06	ATLANTIS	
F	99-01	ATLANTIS	
F	09-10	ATLANTIS All MotorHomes with Ford E450 Chassis	

Numerical listing

Shock	POP	Alternative No.	MTG Acc. Supplied
Pos.	Year	Application	
58622	W	(cont)	142617
F	07	ATLANTIS All MotorHomes with Ford E450 Chassis	
F	02-05	ATLANTIS All MotorHomes with Ford E450 Chassis	
F	19	AUGUSTA All MotorHomes with Ford E450 Chassis	
F	15-16	AUGUSTA All MotorHomes with Ford E450 Chassis	
F	11	AUGUSTA All MotorHomes with Ford E450 Chassis	
F	08-09	AUGUSTA All MotorHomes with Ford E450 Chassis	
F	12-13	AUGUSTA B+ All MotorHomes with Ford E450 Chassis	
F	10	AUGUSTA B+ All MotorHomes with Ford E450 Chassis	
F	07	AUGUSTA B+ All MotorHomes with Ford E450 Chassis	
F	16	AUGUSTA LX All MotorHomes with Ford E450 Chassis	
F	07-10	AUGUSTA SPORT All MotorHomes with Ford E350 Chassis	
F	07-09	AUGUSTA TOURING SEDAN All MotorHomes with Ford E350 Chassis	
F	17-18	VESTA All MotorHomes with Ford E450 Chassis	
F	01-20	ITASCA CLASS C MOTORHOMES	
F	03-06	JAYCO ESCAPADE All MotorHomes with Ford E350 or E450 Chassis	
F	02-06	GRANITE RIDGE All MotorHomes with Ford E350 or E450 Chassis	
F	02-24	GREYHAWK All MotorHomes with Ford E450 Chassis	
F	07-24	MELBOURNE All MotorHomes with Ford E350 or E450 Chassis	
F	13-24	REDHAWK All MotorHomes with Ford E450 Chassis	
F	18-24	REDHAWK SE All MotorHomes with Ford E450 Chassis	
F		KRYSTAL BUS VARIOUS	
F		LGE COACHWORKS VARIOUS	
F	11-12	NEXUS CLASS C MOTORHOMES	
F	11-24	PHANTOM All MotorHomes with Ford E350 or E450 Chassis	
F	20-24	TRIUMPH All MotorHomes with Ford E350 or E450 Chassis	
F	24	VIPER 29V MotorHomes with Ford E350 or E450 Chassis	
F	11-23	VIPER All MotorHomes with Ford E350 or E450 Chassis	
F	00-23	PHOENIX CRUISER All MotorHomes with Ford E350 or E450 Chassis	
F		SHASTA RV ALL MODELS	
F		STARCRAFT BUS CO. E350 & E450 FORD CHASSIS MODELS	
F	92-22	THOMAS TYPE A SCHOOL BUS	
F	14-24	THOR MOTOR COACH AXIS All MotorHomes with Ford E350 or E450 Chassis	
F	11-24	CHATEAU All MotorHomes with Ford E350 or E450 Chassis	
F	11-12	CHATEAU CITATION All MotorHomes with Ford E350 or E450 Chassis	
F	12-16	CITATION All MotorHomes with Ford E350 or E450 Chassis	
F	22-24	ECHELON All MotorHomes with Ford E350 or E450 Chassis	
F	11-24	FOUR WINDS All MotorHomes with Ford E350 or E450 Chassis	
F	25	FOUR WINDS 282	
F	12-24	FREEDOM ELITE All MotorHomes with Ford E350 or E450 Chassis	
F	11-23	OUTLAW All MotorHomes with Ford E350 or E450 Chassis	
F	16-24	QUANTUM All MotorHomes with Ford E350 or E450 Chassis	
F	25	VEGAS 24.1 MotorHomes with Ford E350 or E450 Chassis	
F	14-24	VEGAS All MotorHomes with Ford E350 or E450 Chassis	
F		TURTLETOP BUS VARIOUS	
F		WHEELED COACH IND. VARIOUS	
F	07-13	WINNEBAGO ACCESS All MotorHomes with Ford E350 or E450 Chassis	
F	14	ACCESS PREMIER All MotorHomes with Ford E350 or E450 Chassis	
F	18-20	ASPECT	

LTV Severe Duty

Shock	POP	Alternative No.	MTG Acc. Supplied
Pos.	Year	Application	
58622	W	(cont)	142617
F	05-17	ASPECT All MotorHomes with E350 or E450 Chassis	
F	18-20	CAMBRIA	
F	09-15	CAMBRIA	
F	16-17	CAMBRIA All MotorHomes with Ford E350 or E450 Chassis	
F	05-08	CAMBRIA All MotorHomes with Ford E350 or E450 Chassis	
F	06-20	MINNIE	
F	99	MINNIE	
F	00-05	MINNIE All MotorHomes with Ford E350 or E450 Chassis	
F	14-24	MINNIE WINNIE All MotorHomes with Ford E350 or E450 Chassis	
F	00-06	MINNIE WINNIE All MotorHomes with Ford E350 or E450 Chassis	
F	11-18	OUTLOOK	
F	19-21	OUTLOOK All MotorHomes with Ford E350 or E450 Chassis	
F	06-10	OUTLOOK All MotorHomes with Ford E350 or E450 Chassis	
F	08-15	SPIRIT	
F	16-22	SPIRIT All MotorHomes with Ford E350 or E450 Chassis	
F	00-07	SPIRIT All MotorHomes with Ford E350 or E450 Chassis	
F		WORLD TRANS BUS CO. VARIOUS	
58623	D		142617
R	17-24	BERKSHIRE COACH ULTRA 24	
R	17-24	ULTRA 28	
R	92-24	BLUE BIRD MICROBIRD TYPE A SCHOOL BUS	
R		CHAMPION BUS INC. AMERICAN COACH	
R		CHALLENGER	
R		CRUSADER	
R		LF TRANSPORT	
R	03-24	COACH HOUSE PLATINUM All MotorHomes with Ford E450 Chassis	
R	23-24	PLATINUM IV All MotorHomes with Ford E450 Chassis	
R		COACHMEN CATALINA	
R	20-22	CONCORD	
R	04-06	CONCORD	
R	23-24	CONCORD All MotorHomes with Ford E350 or E450 Chassis	
R	07-19	CONCORD All MotorHomes with Ford E350 or E450 Chassis	
R	04-08	FREEDOM EXPRESS	
R	09	FREEDOM EXPRESS All MotorHomes with Ford E350 or E450 Chassis	
R	03-07	FREELANDER	
R	08-24	FREELANDER All MotorHomes with Ford E350 or E450 Chassis	
R	10	LEPRECHAUN	
R	03-07	LEPRECHAUN	
R	11-24	LEPRECHAUN All MotorHomes with Ford E350 or E450 Chassis	
R	08-09	LEPRECHAUN All MotorHomes with Ford E350 or E450 Chassis	
R	98-03	PATHFINDER	
R	99-06	SANTARA	
R		COLLINS BUS CORP. VARIOUS	
R		DIAMOND COACH SHUTTLE BUSES	
R	92-09	DUTCHMEN RV CLASS C MOTORHOMES	
R	15-20	JAMBOREE	
R	92-17	DYNAMAX CORP ISATA 4	
R	18-20	ISATA 4 All MotorHomes with Ford E350 or E450 Chassis	
R		ELDORADO NATIONAL	
R		ADVANTAGE	
R		AEROLITE	
R		AEROTECH	
R	17	ENTEGR COACH ESTEEM	
R	18-24	ESTEEM All MotorHomes with Ford E350 or E450 Chassis	
R	17	ODYSSEY	
R	18-24	ODYSSEY All MotorHomes with Ford E350 or E450 Chassis	
R	23-24	ODYSSEY SE All MotorHomes with Ford E450 Chassis	
R		FEDERAL COACH VARIOUS	
R	20	FLEETWOOD JAMBOREE	
R	14-16	JAMBOREE	
R	99-07	JAMBOREE	
R	17-19	JAMBOREE All MotorHomes with Ford E350 or E450 Chassis	
R	08-13	JAMBOREE All MotorHomes with Ford E350 or E450 Chassis	

Numerical listing

Shock	POP	Alternative No.	MTG Acc. Supplied
Pos.	Year	Application	
58623	D	(cont)	142617
R	19-20	SURGE	
R	18	SURGE All MotorHomes with Ford E350 or E450 Chassis	
R	14-16	TIOGA	
R	99-07	TIOGA	
R	08-13	TIOGA All MotorHomes with Ford E350 or E450 Chassis	
R	00-02	FORD E-450 ECONOLINE SUPER DUTY All	
R	21-24	VAN 1 TON, ECONOLINE / CLUB WAGON / SUPERDUTY All	
R	03-19	VAN 1 TON, ECONOLINE / CLUB WAGON / SUPERDUTY All	
R		FOREST RIVER ALL AMERICAN	
R	20	FORESTER	
R	04-19	FORESTER All MotorHomes with Ford E350 or E450 Chassis	
R	15-18	FORESTER GTS All MotorHomes with Ford E350 or E450 Chassis	
R	03-15	LEXINGTON All MotorHomes with Ford E350 or E450 Chassis	
R	21-24	SOLERA All MotorHomes with Ford E350 or E450 Chassis	
R	10-15	SOLERA All MotorHomes with Ford E350 or E450 Chassis	
R	23	SUNSEEKER	
R	99-06	SUNSEEKER	
R	07-22	SUNSEEKER All MotorHomes with Ford E350 or E450 Chassis	
R	19-20	SUNSEEKER GTS	
R	15-18	SUNSEEKER GTS All MotorHomes with Ford E350 or E450 Chassis	
R	99-09	GEORGIE BOY MANUFACTURING CLASS C MOTORHOMES	
R		GLAVAL BUS CO. VARIOUS	
R		GOSHEN COACH VARIOUS	
R		GRECH MOTORS VARIOUS	
R	02-15	GULF STREAM BT CRUISER	
R	16-24	BT CRUISER All MotorHomes with Ford E350 or E450 Chassis	
R	99-06	CAVALIER	
R	12-15	CONQUEST	
R	93-01	CONQUEST	
R	16-24	CONQUEST All MotorHomes with Ford E350 or E450 Chassis	
R	02-11	CONQUEST All MotorHomes with Ford E350 or E450 Chassis	
R	10-11	CONQUEST SPORT All MotorHomes with Ford E350 or E450 Chassis	
R	01-02	CONQUEST SPORT All MotorHomes with Ford E350 or E450 Chassis	
R	00-11	INDEPENDENCE All MotorHomes with Ford E350 or E450 Chassis	
R	10-11	MONTAJ All MotorHomes with Ford E350 or E450 Chassis	
R	00-08	ULTRA	
R	02-04	YELLOWSTONE	
R	05-11	YELLOWSTONE All MotorHomes with Ford E350 or E450 Chassis	
R	19	HOLIDAY RAMBLER ALTERA	
R	18	ALTERA All MotorHomes with Ford E450 Chassis	
R	08	ATLANTIS	
R	06	ATLANTIS	
R	99-01	ATLANTIS	
R	09-10	ATLANTIS All MotorHomes with Ford E450 Chassis	
R	07	ATLANTIS All MotorHomes with Ford E450 Chassis	
R	02-05	ATLANTIS All MotorHomes with Ford E450 Chassis	
R	19	AUGUSTA All MotorHomes with Ford E450 Chassis	
R	15-16	AUGUSTA All MotorHomes with Ford E450 Chassis	
R	11	AUGUSTA All MotorHomes with Ford E450 Chassis	
R	08-09	AUGUSTA All MotorHomes with Ford E450 Chassis	
R	12-13	AUGUSTA B+ All MotorHomes with Ford E450 Chassis	
R	10	AUGUSTA B+ All MotorHomes with Ford E450 Chassis	
R	07	AUGUSTA B+ All MotorHomes with Ford E450 Chassis	
R	16	AUGUSTA LX All MotorHomes with Ford E450 Chassis	
R	07-10	AUGUSTA SPORT All MotorHomes with Ford E350 Chassis	
R	07-09	AUGUSTA TOURING SEDAN All MotorHomes with Ford E350 Chassis	

Numerical listing

Shock	POP	Alternative No.	MTG Acc. Supplied
Pos.	Year	Application	
58623	D (cont)		142617
R	17-18	VESTA All MotorHomes with Ford E450 Chassis	
R	01-20	ITASCA CLASS C MOTORHOMES	
R	03-06	JAYCO ESCAPE All MotorHomes with Ford E350 or E450 Chassis	
R	02-06	GRANITE RIDGE All MotorHomes with Ford E350 or E450 Chassis	
R	02-24	GREYHAWK All MotorHomes with Ford E450 Chassis	
R	07-24	MELBOURNE All MotorHomes with Ford E350 or E450 Chassis	
R	13-24	REDHAWK All MotorHomes with Ford E450 Chassis	
R	18-24	REDHAWK SE All MotorHomes with Ford E450 Chassis	
R		KRYSTAL BUS VARIOUS	
R		LGE COACHWORKS VARIOUS	
R	11-20	NEXUS CLASS C MOTORHOMES	
R	11-24	PHANTOM All MotorHomes with Ford E350 or E450 Chassis	
R	20-24	TRIUMPH All MotorHomes with Ford E350 or E450 Chassis	
R	24	VIPER 29V MotorHomes with Ford E350 or E450 Chassis	
R	11-23	VIPER All MotorHomes with Ford E350 or E450 Chassis	
R	00-23	PHOENIX CRUISER All MotorHomes with Ford E350 or E450 Chassis	
R		SHASTA RV ALL MODELS	
R		STARCRAFT BUS CO. E350 & E450 FORD CHASSIS MODELS	
R	92-20	THOMAS TYPE A SCHOOL BUS	
R	14-24	THOR MOTOR COACH AXIS All MotorHomes with Ford E350 or E450 Chassis	
R	11-24	CHATEAU All MotorHomes with Ford E350 or E450 Chassis	
R	11-12	CHATEAU CITATION All MotorHomes with Ford E350 or E450 Chassis	
R	12-16	CITATION All MotorHomes with Ford E350 or E450 Chassis	
R	22-24	ECHELON All MotorHomes with Ford E350 or E450 Chassis	
R	11-24	FOUR WINDS All MotorHomes with Ford E350 or E450 Chassis	
R	25	FOUR WINDS 282	
R	12-24	FREEDOM ELITE All MotorHomes with Ford E350 or E450 Chassis	
R	11-23	OUTLAW All MotorHomes with Ford E350 or E450 Chassis	
R	16-24	QUANTUM All MotorHomes with Ford E350 or E450 Chassis	
R	25	VEGAS 24.1 MotorHomes with Ford E350 or E450 Chassis	
R	14-24	VEGAS All MotorHomes with Ford E350 or E450 Chassis	
R		TURTLETOP BUS VARIOUS	
R		WHEELED COACH IND. VARIOUS	
R	07-13	WINNEBAGO ACCESS All MotorHomes with Ford E350 or E450 Chassis	
R	14	ACCESS PREMIER All MotorHomes with Ford E350 or E450 Chassis	
R	18-20	ASPECT	
R	06-17	ASPECT All MotorHomes with Ford E350 or E450 Chassis	
R	18-20	CAMBRIA	
R	09-15	CAMBRIA	
R	16-17	CAMBRIA All MotorHomes with Ford E350 or E450 Chassis	
R	05-08	CAMBRIA All MotorHomes with Ford E350 or E450 Chassis	
R	06-20	MINNIE	
R	99	MINNIE	
R	00-05	MINNIE All MotorHomes with Ford E350 or E450 Chassis	
R	14-24	MINNIE WINNIE All MotorHomes with Ford E350 or E450 Chassis	
R	00-06	MINNIE WINNIE All MotorHomes with Ford E350 or E450 Chassis	
R	11-18	OUTLOOK	
R	19-21	OUTLOOK All MotorHomes with Ford E350 or E450 Chassis	
R	06-10	OUTLOOK All MotorHomes with Ford E350 or E450 Chassis	
R	08-15	SPIRIT	
R	16-22	SPIRIT All MotorHomes with Ford E350 or E450 Chassis	
R	00-07	SPIRIT All MotorHomes with Ford E350 or E450 Chassis	

LTV Severe Duty, ProGuard, Ultra Truck Shock

Shock	POP	Alternative No.	MTG Acc. Supplied
Pos.	Year	Application	
58623	D (cont)		142617
R		WORLD TRANS BUS CO. VARIOUS	
58638	A		
R	09-22	CHEVROLET EXPRESS 4500 All	
58809	B		
F	99-04	FORD PICKUP, F-450 SUPERDUTY All	
F	99-04	PICKUP, F-550 SUPERDUTY All	
58944	W		
F	07-12	FORD PICKUP, F-450 SUPERDUTY All	
F	10-12	PICKUP, F-550 SUPERDUTY All	
ProGuard			
61500	A		
R	79-82	DODGE D50 RWD	
F	68-76	FORD PICKUP P350 All Up through 8000# GVW	
F	75-76	PICKUP P400 All Up through 8000# GVW	
R	68-72	INTERNATIONAL M1100 / M1200 All	
R	69	M1400 All	
61506	A		141137
R	87-89	DODGE RAIDER 2.6L 4Cyl L (156), 3.59 91.1(Bore)3.86 98.0(Stroke)	
61529	W		140673
F	82	DODGE D50 4WD	
F	87-89	RAIDER All	
61554	C		
R	88-97	FORD F-SUPER DUTY All	
R	97	PICKUP, F-450 SUPERDUTY All	
61556	W		140455
F	79-82	DODGE D50 RWD	
61646	W		142617
R	00-02	FORD E-450 ECONOLINE SUPER DUTY All	
R	21-24	VAN 1 TON, ECONOLINE / CLUB WAGON / SUPERDUTY All	
R	03-19	VAN 1 TON, ECONOLINE / CLUB WAGON / SUPERDUTY All	
R	24	NEXUS VIPER 29V	
R	25	THOR MOTOR COACH FOUR WINDS 282	
R	25	VEGAS 24.1	
61655	B		
R	02	FORD E-550 ECONOLINE SUPER DUTY All	
R	03	E-550 SUPER DUTY All	
F	99-04	PICKUP, F-450 SUPERDUTY All	
F	99-04	PICKUP, F-550 SUPERDUTY All	
61685	A		143078
F	09-22	CHEVROLET EXPRESS 4500 All	
F	10-20	GMC SAVANA 4500 All	
61687	A		
R	09-22	CHEVROLET EXPRESS 4500 All	
R	10-20	GMC SAVANA 4500 All	
Ultra Truck Shock			
G63183	W		
R	63-81	CHRYSLER MOTORHOME CHASSIS	
R	73-78	DODGE TRUCK D SERIES- CONVENTIONAL CAB 4 X 2	
R	63-82	P SERIES - FORWARD CONTROL	
R	61-78	W-SERIES AND POWER WAGONS	
F	73	W-SERIES AND POWER WAGONS	
R		HOLIDAY RAMBLER VARIOUS	
G63299	W		140885
R	87-04	MINNIE WINNIE All Model with O.E.M. Number	
G63306	C		
F	64-67	FORD C & CT SERIES - TILT CAB	
F		INTERNATIONAL A, B, AC AND BC CONVENTIONAL	
R	66-75	METRO & MULTI-SHOP SERIES	
G63366	A		
R		WORKHORSE VARIOUS	

Numerical listing

Shock	POP	Alternative No.	MTG Acc. Supplied
Pos.	Year	Application	
G63405	D		140884
F	68-76	FORD PICKUP P350 All Up through 8000# GVW	
F	75-76	PICKUP P400 All Up through 8000# GVW	
R	68-72	INTERNATIONAL M1100 / M1200 All	
R	69	M1400 All	
R	96-04	MINNIE WINNIE All Model with O.E.M. Number	
R	98-04	FG All Model with O.E.M. Number	
G63409	W		
R	88-97	FORD F-SUPER DUTY All	
R	97	PICKUP, F-450 SUPERDUTY All	
G63418	W		141356
F	82	DODGE D50 4WD	
F	87-89	RAIDER All	
G63419	W		
R	82	DODGE D50 4WD	
R	98	HINO FA, FB SERIES	
G63432	W		141349,140169
F		INTERNATIONAL DURASTAR - 1000 SERIES	
F		UD UD 1300	
G63461	B		
R	99-07	FORD PICKUP, F-450 SUPERDUTY All Models with single or dual rear wheels with 165" or 201" wheel base	
R	99-07	PICKUP, F-550 SUPERDUTY All Models with single or dual rear wheels with 165" or 201" wheel base	
G63492	A		141137
R	87-89	DODGE RAIDER 2.6L 4Cyl L (156) Exc. Sport Utility	
G63604	W		
R	89	DODGE RAIDER Sport Utility, 3.0L 6Cyl V (181), 3.59 91.1(Bore)2.99 76.0(Stroke)	
G63610	C		142389
F	89-91	HINO FA14 All Models with O.E.M. Number	
F	92	FA15 All FA, FB Models Trucks with:	
F	93-97	FA1415 All (FA15)	
F	93-97	FA1415 All FA, FB Models Trucks with:	
F	93-97	FA1415 All FA1415 (FA15), FB1715 (FB15)	
F	98-04	FA1517 All FA, FB Models Trucks with:	
F	89-91	FB14 All FA, FB Models Trucks with:	
F	92	FB15 All FA, FB Models Trucks with:	
F	93-97	FB1715 All FA, FB Models Trucks with:	
F	93-97	FB1715 All FA1415 (FA15), FB1715 (FB15)	
F	98-04	FB1817 All FA, FB Models Trucks with:	
F	05-11	MINNIE WINNIE All Model with O.E.M. Number	
F	96-04	FE All Models with O.E.M. Number	
F	88-04	FH All Models with O.E.M. Number	
F	99-10	UD UD 18HD SERIES	
F	11-13	UD 1800 SERIES	
F	95-98	UD 1800 SERIES	
F	95-13	UD 2000 SERIES	
G63622	A		142617
F	17-24	BERKSHIRE COACH ULTRA 24	
F	17-24	ULTRA 28	
F	92-24	BLUE BIRD MICROBIRD TYPE A SCHOOL BUS	
F		CHAMPION BUS INC. AMERICAN COACH	
F		CHALLENGER	
F		CRUSADER	
F		LF TRANSPORT	
F	03-24	COACH HOUSE PLATINUM All Motorhomes with Ford E450 Chassis	
F	23-24	PLATINUM IV All Motorhomes with Ford E450 Chassis	
F		COACHMEN CATALINA	
F	20-22	CONCORD	
F	04-06	CONCORD	
F	23-24	CONCORD All MotorHomes with Ford E350 or E450 Chassis	

Numerical listing

Shock	POP	Alternative No.	MTG Acc. Supplied
Pos.	Year	Application	
G63622	A (cont)		142617
F	07-19	CONCORD All MotorHomes with Ford E350 or E450 Chassis	
F	04-08	FREEDOM EXPRESS	
F	09	FREEDOM EXPRESS All MotorHomes with Ford E350 or E450 Chassis	
F	03-07	FREELANDER	
F	08-24	FREELANDER All MotorHomes with Ford E350 or E450 Chassis	
F	10	LEPRECHAUN	
F	03-07	LEPRECHAUN	
F	11-24	LEPRECHAUN All MotorHomes with Ford E350 or E450 Chassis	
F	08-09	LEPRECHAUN All MotorHomes with Ford E350 or E450 Chassis	
F	98-03	PATHFINDER	
F	99-06	SANTARA	
F		COLLINS BUS CORP. VARIOUS DIAMOND COACH SHUTTLE BUSES	
F	92-09	DUTCHMEN RV CLASS C MOTORHOMES	
F	15-20	JAMBOREE	
F	92-17	DYNAMAX CORP ISATA 4	
F	18-20	ISATA 4 All MotorHomes with Ford E350 or E450 Chassis	
F		ELDORADO NATIONAL ADVANTAGE	
F		AEROLITE	
F		AEROTECH	
F	17	ENTEGRAL COACH ESTEEM	
F	18-24	ESTEEM All MotorHomes with Ford E350 or E450 Chassis	
F	17	ODYSSEY	
F	18-24	ODYSSEY All MotorHomes with Ford E350 or E450 Chassis	
F	23-24	ODYSSEY SE All MotorHomes with Ford E450 Chassis	
F		FEDERAL COACH VARIOUS FLEETWOOD JAMBOREE	
F	14-16	JAMBOREE	
F	99-07	JAMBOREE	
F	17-19	JAMBOREE All MotorHomes with Ford E350 or E450 Chassis	
F	08-13	JAMBOREE All MotorHomes with Ford E350 or E450 Chassis	
F	19-20	SURGE	
F	18	SURGE All MotorHomes with Ford E350 or E450 Chassis	
F	14-16	TIOGA	
F	99-07	TIOGA	
F	08-13	TIOGA All MotorHomes with Ford E350 or E450 Chassis	
F	00-02	FORD E-450 ECONOLINE SUPER DUTY All	
F	20-24	F-600 SUPER DUTY All Applications with OEM Number	
F	21-24	VAN 1 TON, ECONOLINE / CLUB WAGON / SUPERDUTY All	
F	03-19	VAN 1 TON, ECONOLINE / CLUB WAGON / SUPERDUTY All	
F	20	FOREST RIVER ALL AMERICAN FORESTER	
F	04-19	FORESTER All MotorHomes with Ford E350 or E450 Chassis	
F	15-18	FORESTER GTS All MotorHomes with Ford E350 or E450 Chassis	
F	03-15	LEXINGTON All MotorHomes with Ford E350 or E450 Chassis	
F	21-24	SOLERA All MotorHomes with Ford E350 or E450 Chassis	
F	10-15	SOLERA All MotorHomes with Ford E350 or E450 Chassis	
F	23	SUNSEEKER	
F	99-06	SUNSEEKER	
F	07-22	SUNSEEKER All MotorHomes with Ford E350 or E450 Chassis	
F	19-20	SUNSEEKER GTS	
F	15-18	SUNSEEKER GTS All MotorHomes with Ford E350 or E450 Chassis	
F	99-09	GEORGIE BOY MANUFACTURING CLASS C MOTORHOMES	
F		GLAVAL BUS CO. VARIOUS	
F		GOSHEN COACH VARIOUS	
F		GRECH MOTORS VARIOUS	
F	02-15	GULF STREAM BT CRUISER	
F	16-24	BT CRUISER All MotorHomes with Ford E350 or E450 Chassis	
F	99-06	CAVALIER	
F	12-15	CONQUEST	
F	93-01	CONQUEST	
F	16-24	CONQUEST All MotorHomes with Ford E350 or E450 Chassis	

Ultra Truck Shock

Shock	POP	Alternative No.	MTG Acc. Supplied
Pos.	Year	Application	
G63622	A (cont)		142617
F	02-11	CONQUEST All MotorHomes with Ford E350 or E450 Chassis	
F	10-11	CONQUEST SPORT All MotorHomes with Ford E350 or E450 Chassis	
F	01-02	CONQUEST SPORT All MotorHomes with Ford E350 or E450 Chassis	
F	00-11	INDEPENDENCE All MotorHomes with Ford E350 or E450 Chassis	
F	10-11	MONTAJ All MotorHomes with Ford E350 or E450 Chassis	
F	00-08	ULTRA	
F	02-04	YELLOWSTONE	
F	05-11	YELLOWSTONE All MotorHomes with Ford E350 or E450 Chassis	
F	19	HOLIDAY RAMBLER ALTERA	
F	18	ALTERA All MotorHomes with Ford E450 Chassis	
F	08	ATLANTIS	
F	06	ATLANTIS	
F	99-01	ATLANTIS	
F	09-10	ATLANTIS All MotorHomes with Ford E450 Chassis	
F	07	ATLANTIS All MotorHomes with Ford E450 Chassis	
F	02-05	ATLANTIS All MotorHomes with Ford E450 Chassis	
F	19	AUGUSTA All MotorHomes with Ford E450 Chassis	
F	15-16	AUGUSTA All MotorHomes with Ford E450 Chassis	
F	11	AUGUSTA All MotorHomes with Ford E450 Chassis	
F	08-09	AUGUSTA All MotorHomes with Ford E450 Chassis	
F	12-13	AUGUSTA B+ All MotorHomes with Ford E450 Chassis	
F	10	AUGUSTA B+ All MotorHomes with Ford E450 Chassis	
F	07	AUGUSTA B+ All MotorHomes with Ford E450 Chassis	
F	16	AUGUSTA LX All MotorHomes with Ford E450 Chassis	
F	07-10	AUGUSTA SPORT All MotorHomes with Ford E350 Chassis	
F	07-09	AUGUSTA TOURING SEDAN All MotorHomes with Ford E350 Chassis	
F	17-18	VESTA All MotorHomes with Ford E450 Chassis	
F	01-20	ITASCA CLASS C MOTORHOMES	
F	03-06	JAYCO ESCAPE All MotorHomes with Ford E350 or E450 Chassis	
F	02-06	GRANITE RIDGE All MotorHomes with Ford E350 or E450 Chassis	
F	02-24	GREYHAWK All MotorHomes with Ford E450 Chassis	
F	07-24	MELBOURNE All MotorHomes with Ford E350 or E450 Chassis	
F	13-24	REDHAWK All MotorHomes with Ford E450 Chassis	
F	18-24	REDHAWK SE All MotorHomes with Ford E450 Chassis	
F		KRYSTAL BUS VARIOUS	
F		LGE COACHWORKS VARIOUS	
F	11-12	NEXUS CLASS C MOTORHOMES	
F	11-24	PHANTOM All MotorHomes with Ford E350 or E450 Chassis	
F	20-24	TRIUMPH All MotorHomes with Ford E350 or E450 Chassis	
F	11-24	VIPER All MotorHomes with Ford E350 or E450 Chassis	
F	24	VIPER 29V MotorHomes with Ford E350 or E450 Chassis	
F	00-23	PHOENIX CRUISER All MotorHomes with Ford E350 or E450 Chassis	
F		SHASTA RV ALL MODELS	
F		STARCRAFT BUS CO. E350 & E450 FORD CHASSIS MODELS	
F	92-22	THOMAS TYPE A SCHOOL BUS	
F	14-24	THOR MOTOR COACH AXIS All MotorHomes with Ford E350 or E450 Chassis	
F	11-24	CHATEAU All MotorHomes with Ford E350 or E450 Chassis	
F	11-12	CHATEAU CITATION All MotorHomes with Ford E350 or E450 Chassis	
F	12-16	CITATION All MotorHomes with Ford E350 or E450 Chassis	

Numerical listing

Shock	POP	Alternative No.	MTG Acc. Supplied
Pos.	Year	Application	
G63622	A (cont)		142617
F	22-24	ECHELON All MotorHomes with Ford E350 or E450 Chassis	
F	11-24	FOUR WINDS All MotorHomes with Ford E350 or E450 Chassis	
F	25	FOUR WINDS 282	
F	12-24	FREEDOM ELITE All MotorHomes with Ford E350 or E450 Chassis	
F	11-23	OUTLAW All MotorHomes with Ford E350 or E450 Chassis	
F	16-24	QUANTUM All MotorHomes with Ford E350 or E450 Chassis	
F	25	VEGAS 24.1	
F	14-24	VEGAS All MotorHomes with Ford E350 or E450 Chassis	
F		TURTLETOP BUS VARIOUS WHEELED COACH IND. VARIOUS	
F	07-13	WINNEBAGO ACCESS All MotorHomes with Ford E350 or E450 Chassis	
F	14	ACCESS PREMIER All MotorHomes with Ford E350 or E450 Chassis	
F	18-20	ASPECT	
F	05-17	ASPECT All MotorHomes with Ford E350 or E450 Chassis	
F	18-20	CAMBRIA	
F	09-15	CAMBRIA	
F	16-17	CAMBRIA All MotorHomes with Ford E350 or E450 Chassis	
F	05-08	CAMBRIA All MotorHomes with Ford E350 or E450 Chassis	
F	06-20	MINNIE	
F	99	MINNIE	
F	00-05	MINNIE All MotorHomes with Ford E350 or E450 Chassis	
F	14-24	MINNIE WINNIE All MotorHomes with Ford E350 or E450 Chassis	
F	00-06	MINNIE WINNIE All MotorHomes with Ford E350 or E450 Chassis	
F	11-18	OUTLOOK	
F	19-21	OUTLOOK All MotorHomes with Ford E350 or E450 Chassis	
F	06-10	OUTLOOK All MotorHomes with Ford E350 or E450 Chassis	
F	08-15	SPIRIT	
F	16-22	SPIRIT All MotorHomes with Ford E350 or E450 Chassis	
F	00-07	SPIRIT All MotorHomes with Ford E350 or E450 Chassis	
F		WORLD TRANS BUS CO. VARIOUS	
G63623	A		142617
R	17-24	BERKSHIRE COACH ULTRA 24	
R	17-24	ULTRA 28	
R	92-24	BLUE BIRD MICROBIRD TYPE A SCHOOL BUS	
R		CHAMPION BUS INC. AMERICAN COACH	
R		CHALLENGER	
R		CRUSADER	
R		LF TRANSPORT	
R	03-24	COACH HOUSE PLATINUM All Motorhomes with Ford E450 Chassis	
R	23-24	PLATINUM IV All Motorhomes with Ford E450 Chassis	
R		COACHMEN CATALINA	
R	20-22	CONCORD	
R	04-06	CONCORD	
R	23-24	CONCORD All MotorHomes with Ford E350 or E450 Chassis	
R	07-19	CONCORD All MotorHomes with Ford E350 or E450 Chassis	
R	04-08	FREEDOM EXPRESS	
R	09	FREEDOM EXPRESS All MotorHomes with Ford E350 or E450 Chassis	
R	03-07	FREELANDER	
R	08-24	FREELANDER All MotorHomes with Ford E350 or E450 Chassis	
R	10	LEPRECHAUN	
R	03-07	LEPRECHAUN	
R	11-24	LEPRECHAUN All MotorHomes with Ford E350 or E450 Chassis	
R	08-09	LEPRECHAUN All MotorHomes with Ford E350 or E450 Chassis	
R	98-03	PATHFINDER	
R	99-06	SANTARA	
R		COLLINS BUS CORP. VARIOUS DIAMOND COACH SHUTTLE BUSES	
R	92-09	DUTCHMEN RV CLASS C MOTORHOMES	
R	15-20	JAMBOREE	

Numerical listing

Shock	POP	Alternative No.	MTG Acc. Supplied
Pos.	Year	Application	
G63623	A (cont)		142617
R	92-17	DYNAMAX CORP	ISATA 4
R	18-20	ISATA 4	All MotorHomes with Ford E350 or E450 Chassis
R		ELDORADO NATIONAL	
R		ADVANTAGE	
R		AEROLITE	
R		AEROTECH	
R	17	ENTEGR COACH	ESTEEM
R	18-24	ESTEEM	All MotorHomes with Ford E350 or E450 Chassis
R	17	ODYSSEY	
R	18-24	ODYSSEY	All MotorHomes with Ford E350 or E450 Chassis
R	23-24	ODYSSEY SE	All MotorHomes with Ford E450 Chassis
R		FEDERAL COACH	VARIOUS
R	20	FLEETWOOD	JAMBOREE
R	14-16	JAMBOREE	
R	99-07	JAMBOREE	
R	17-19	JAMBOREE	All MotorHomes with Ford E350 or E450 Chassis
R	08-13	JAMBOREE	All MotorHomes with Ford E350 or E450 Chassis
R	19-20	SURGE	
R	18	SURGE	All MotorHomes with Ford E350 or E450 Chassis
R	14-16	TIOGA	
R	99-07	TIOGA	
R	08-13	TIOGA	All MotorHomes with Ford E350 or E450 Chassis
R	00-02	FORD E-450	ECONOLINE SUPER DUTY All
R	21-24	VAN 1 TON, ECONOLINE / CLUB WAGON / SUPERDUTY All	
R	03-19	VAN 1 TON, ECONOLINE / CLUB WAGON / SUPERDUTY All	
R		FOREST RIVER	ALL AMERICAN
R	20	FORESTER	
R	04-19	FORESTER	All MotorHomes with Ford E350 or E450 Chassis
R	15-18	FORESTER GTS	All MotorHomes with Ford E350 or E450 Chassis
R	03-15	LEXINGTON	All MotorHomes with Ford E350 or E450 Chassis
R	21-24	SOLERA	All MotorHomes with Ford E350 or E450 Chassis
R	10-15	SOLERA	All MotorHomes with Ford E350 or E450 Chassis
R	23	SUNSEEKER	
R	99-06	SUNSEEKER	
R	07-22	SUNSEEKER	All MotorHomes with Ford E350 or E450 Chassis
R	19-20	SUNSEEKER GTS	
R	15-18	SUNSEEKER GTS	All MotorHomes with Ford E350 or E450 Chassis
R	99-09	GEORGIE BOY MANUFACTURING	CLASS C MOTORHOMES
R		GLAVAL BUS CO.	VARIOUS
R		GOSHEN COACH	VARIOUS
R		GRECH MOTORS	VARIOUS
R	02-15	GULF STREAM	BT CRUISER
R	16-24	BT CRUISER	All MotorHomes with Ford E350 or E450 Chassis
R	99-06	CAVALIER	
R	12-15	CONQUEST	
R	93-01	CONQUEST	
R	16-24	CONQUEST	All MotorHomes with Ford E350 or E450 Chassis
R	02-11	CONQUEST	All MotorHomes with Ford E350 or E450 Chassis
R	10-11	CONQUEST SPORT	All MotorHomes with Ford E350 or E450 Chassis
R	01-02	CONQUEST SPORT	All MotorHomes with Ford E350 or E450 Chassis
R	00-11	INDEPENDENCE	All MotorHomes with Ford E350 or E450 Chassis
R	10-11	MONTAJ	All MotorHomes with Ford E350 or E450 Chassis
R	00-08	ULTRA	
R	02-04	YELLOWSTONE	
R	05-11	YELLOWSTONE	All MotorHomes with Ford E350 or E450 Chassis
R	19	HOLIDAY RAMBLER	ALTERA
R	18	ALTERA	All MotorHomes with Ford E450 Chassis
R	08	ATLANTIS	
R	06	ATLANTIS	
R	99-01	ATLANTIS	
R	09-10	ATLANTIS	All MotorHomes with Ford E450 Chassis
R	07	ATLANTIS	All MotorHomes with Ford E450 Chassis

Ultra Truck Shock

Shock	POP	Alternative No.	MTG Acc. Supplied
Pos.	Year	Application	
G63623	A (cont)		142617
R	02-05	ATLANTIS	All MotorHomes with Ford E450 Chassis
R	19	AUGUSTA	All MotorHomes with Ford E450 Chassis
R	15-16	AUGUSTA	All MotorHomes with Ford E450 Chassis
R	11	AUGUSTA	All MotorHomes with Ford E450 Chassis
R	08-09	AUGUSTA	All MotorHomes with Ford E450 Chassis
R	12-13	AUGUSTA B+	All MotorHomes with Ford E450 Chassis
R	10	AUGUSTA B+	All MotorHomes with Ford E450 Chassis
R	07	AUGUSTA B+	All MotorHomes with Ford E450 Chassis
R	16	AUGUSTA LX	All MotorHomes with Ford E450 Chassis
R	07-10	AUGUSTA SPORT	All MotorHomes with Ford E350 Chassis
R	07-09	AUGUSTA TOURING SEDAN	All MotorHomes with Ford E350 Chassis
R	17-18	VESTA	All MotorHomes with Ford E450 Chassis
R	01-20	ITASCA CLASS C	MOTORHOMES
R	03-06	JAYCO ESCAPE	All MotorHomes with Ford E350 or E450 Chassis
R	02-06	GRANITE RIDGE	All MotorHomes with Ford E350 or E450 Chassis
R	02-24	GREYHAWK	All MotorHomes with Ford E450 Chassis
R	07-24	MELBOURNE	All MotorHomes with Ford E350 or E450 Chassis
R	13-24	REDHAWK	All MotorHomes with Ford E450 Chassis
R	18-24	REDHAWK SE	All MotorHomes with Ford E450 Chassis
R		KRYSTAL BUS	VARIOUS
R		LGE COACHWORKS	VARIOUS
R	11-20	NEXUS CLASS C	MOTORHOMES
R	11-24	PHANTOM	All MotorHomes with Ford E350 or E450 Chassis
R	20-24	TRIUMPH	All MotorHomes with Ford E350 or E450 Chassis
R	11-24	VIPER	All MotorHomes with Ford E350 or E450 Chassis
R	24	VIPER	29V MotorHomes with Ford E350 or E450 Chassis
R	00-23	PHOENIX CRUISER	All MotorHomes with Ford E350 or E450 Chassis
R		SHASTA RV	ALL MODELS
R		STARCRAFT BUS CO.	E350 & E450 FORD CHASSIS MODELS
R	92-20	THOMAS TYPE A	SCHOOL BUS
R	14-24	THOR MOTOR COACH	AXIS All MotorHomes with Ford E350 or E450 Chassis
R	99-10	CHATEAU	
R	11-24	CHATEAU	All MotorHomes with Ford E350 or E450 Chassis
R	13	CHATEAU CITATION	
R	08-10	CHATEAU CITATION	
R	11-12	CHATEAU CITATION	All MotorHomes with Ford E350 or E450 Chassis
R	01-11	CITATION	
R	12-16	CITATION	All MotorHomes with Ford E350 or E450 Chassis
R	22-24	ECHELON	All MotorHomes with Ford E350 or E450 Chassis
R	01-10	FOUR WINDS	
R	11-24	FOUR WINDS	All MotorHomes with Ford E350 or E450 Chassis
R	25	FOUR WINDS 282	
R	10-11	FREEDOM ELITE	
R	12-24	FREEDOM ELITE	All MotorHomes with Ford E350 or E450 Chassis
R	11-23	OUTLAW	All MotorHomes with Ford E350 or E450 Chassis
R	16-24	QUANTUM	All MotorHomes with Ford E350 or E450 Chassis
R	24-25	VEGAS	24.1
R	14-24	VEGAS	All MotorHomes with Ford E350 or E450 Chassis
R		TURTLETOP BUS	VARIOUS
R		WHEELED COACH IND.	VARIOUS
R	07-13	WINNEBAGO	ACCESS All MotorHomes with Ford E350 or E450 Chassis

Numerical listing

Shock	POP	Alternative No.	MTG Acc. Supplied
Pos.	Year	Application	
G63623	A (cont)		142617
R	14	ACCESS PREMIER	All MotorHomes with Ford E350 or E450 Chassis
R	18-20	ASPECT	
R	06-17	ASPECT	All MotorHomes with Ford E350 or E450 Chassis
R	18-20	CAMBRIA	
R	09-15	CAMBRIA	
R	16-17	CAMBRIA	All MotorHomes with Ford E350 or E450 Chassis
R	05-08	CAMBRIA	All MotorHomes with Ford E350 or E450 Chassis
R	06-20	MINNIE	
R	99	MINNIE	
R	00-05	MINNIE	All MotorHomes with Ford E350 or E450 Chassis
R	14-24	MINNIE WINNIE	All MotorHomes with Ford E350 or E450 Chassis
R	00-06	MINNIE WINNIE	All MotorHomes with Ford E350 or E450 Chassis
R	11-18	OUTLOOK	
R	19-21	OUTLOOK	All MotorHomes with Ford E350 or E450 Chassis
R	06-10	OUTLOOK	All MotorHomes with Ford E350 or E450 Chassis
R	08-15	SPIRIT	
R	16-22	SPIRIT	All MotorHomes with Ford E350 or E450 Chassis
R	00-07	SPIRIT	All MotorHomes with Ford E350 or E450 Chassis
R		WORLD TRANS BUS CO.	VARIOUS
G63692	W		
F	93-97	FORD F-SUPER DUTY	All Mfg. from 2/93
F	97	PICKUP, F-450 SUPERDUTY	All
G63809	A		
F	99-04	FORD PICKUP, F-450	SUPERDUTY All
F	99-04	PICKUP, F-550	SUPERDUTY All
G63866	A		
R		WORKHORSE	VARIOUS
G63886	A		142731
F	20-24	FORD F-600	SUPER DUTY All Applications with OEM Number
G63895	A		143276
F	09-22	CHEVROLET EXPRESS	4500 All
F	10-20	GMC SAVANA	4500 All
G63897	A		
R	09-22	CHEVROLET EXPRESS	4500 All
R	10-20	GMC SAVANA	4500 All
G63907	A		
R	79-82	DODGE D50	RWD
G63950	W		140455
F	79-82	DODGE D50	RWD
G63969	W		143146
F	05-08	FORD PICKUP, F-450	SUPERDUTY All
F	05-07	PICKUP, F-550	SUPERDUTY All
G64177	W		
R	19-22	COACH HOUSE	PLATINUM III All MotorHomes with Ford Transit-350 Chassis
R	19-22	COACHMEN	BEYOND All MotorHomes with Ford Transit-350 Chassis
R	21-22	CROSS TRAIL	TRANSIT All MotorHomes with Ford Transit-350 Chassis
R	17-22	FOREST RIVER	FORESTER TS All MotorHomes with Ford Transit-350 Chassis
R	17-22	SUNSEEKER TS	All MotorHomes with Ford Transit-350 Chassis
R	20-22	PHOENIX TRX	All MotorHomes with Ford Transit-350 Chassis
R	19-22	THOR MOTOR COACH	GEMINI All MotorHomes with Ford Transit-350 Chassis
R	21-22	WINNEBAGO	EKKO All MotorHomes with Ford Transit-350 Chassis

Numerical listing

Shock	POP	Alternative No.	MTG Acc. Supplied
Pos.	Year	Application	
Max Control			
77461	B		
R	99-04	FORD PICKUP, F-450 SUPERDUTY All	
R	99-04	PICKUP, F-550 SUPERDUTY All	
77614	A		140780
F	17-24	BERKSHIRE COACH ULTRA 24	
F	17-24	ULTRA 28	
F	92-24	BLUE BIRD MICROBIRD TYPE A SCHOOL BUS	
F		CHAMPION BUS INC. AMERICAN COACH	
F		CHALLENGER	
F		CRUSADER	
F		LF TRANSPORT	
F	03-24	COACH HOUSE PLATINUM All Motorhomes with Ford E450 Chassis	
F	23-24	PLATINUM IV All Motorhomes with Ford E450 Chassis	
F		COACHMEN CATALINA	
F	20-22	CONCORD	
F	04-06	CONCORD	
F	23-24	CONCORD All MotorHomes with Ford E350 or E450 Chassis	
F	07-19	CONCORD All MotorHomes with Ford E350 or E450 Chassis	
F	04-08	FREEDOM EXPRESS	
F	09	FREEDOM EXPRESS All MotorHomes with Ford E350 or E450 Chassis	
F	03-07	FREELANDER	
F	08-24	FREELANDER All MotorHomes with Ford E350 or E450 Chassis	
F	10	LEPRECHAUN	
F	03-07	LEPRECHAUN	
F	11-24	LEPRECHAUN All MotorHomes with Ford E350 or E450 Chassis	
F	08-09	LEPRECHAUN All MotorHomes with Ford E350 or E450 Chassis	
F	98-03	PATHFINDER	
F	99-06	SANTARA	
F		COLLINS BUS CORP. VARIOUS	
F		DIAMOND COACH SHUTTLE BUSES	
F	92-09	DUTCHMEN RV CLASS C MOTORHOMES	
F	15-20	JAMBOREE	
F	92-17	DYNAMAX CORP ISATA 4	
F	18-20	ISATA 4 All MotorHomes with Ford E350 or E450 Chassis	
F		ELDORADO NATIONAL ADVANTAGE	
F		AEROLITE	
F		AEROTECH	
F	17	ENTEGRA COACH ESTEEM	
F	18-24	ESTEEM All MotorHomes with Ford E350 or E450 Chassis	
F	17	ODYSSEY	
F	18-24	ODYSSEY All MotorHomes with Ford E350 or E450 Chassis	
F	23-24	ODYSSEY SE All MotorHomes with Ford E450 Chassis	
F		FEDERAL COACH VARIOUS	
F	20	FLEETWOOD JAMBOREE	
F	14-16	JAMBOREE	
F	99-07	JAMBOREE	
F	17-19	JAMBOREE All MotorHomes with Ford E350 or E450 Chassis	
F	08-13	JAMBOREE All MotorHomes with Ford E350 or E450 Chassis	
F	19-20	SURGE	
F	18	SURGE All MotorHomes with Ford E350 or E450 Chassis	
F	14-16	TIOGA	
F	99-07	TIOGA	
F	08-13	TIOGA All MotorHomes with Ford E350 or E450 Chassis	
F	00-02	FORD E-450 ECONOLINE SUPER DUTY All	
F	21-24	VAN 1 TON, ECONOLINE / CLUB WAGON / SUPERDUTY All	
F	03-19	VAN 1 TON, ECONOLINE / CLUB WAGON / SUPERDUTY All	
F		FOREST RIVER ALL AMERICAN FORESTER	
F	04-19	FORESTER All MotorHomes with Ford E350 or E450 Chassis	
F	15-18	FORESTER GTS All MotorHomes with Ford E350 or E450 Chassis	
F	03-15	LEXINGTON All MotorHomes with Ford E350 or E450 Chassis	
F	21-24	SOLERA All MotorHomes with Ford E350 or E450 Chassis	

Max Control

Shock	POP	Alternative No.	MTG Acc. Supplied
Pos.	Year	Application	
77614	A (cont)		140780
F	10-15	SOLERA All MotorHomes with Ford E350 or E450 Chassis	
F	23	SUNSEEKER	
F	99-06	SUNSEEKER	
F	07-22	SUNSEEKER All MotorHomes with Ford E350 or E450 Chassis	
F	19-20	SUNSEEKER GTS	
F	15-18	SUNSEEKER GTS All MotorHomes with Ford E350 or E450 Chassis	
F	99-09	GEORGIE BOY MANUFACTURING CLASS C MOTORHOMES	
F		GLAVAL BUS CO. VARIOUS	
F		GOSHEN COACH VARIOUS	
F		GRECH MOTORS VARIOUS	
F	02-15	GULF STREAM BT CRUISER	
F	16-24	BT CRUISER All MotorHomes with Ford E350 or E450 Chassis	
F	99-06	CAVALIER	
F	12-15	CONQUEST	
F	93-01	CONQUEST	
F	16-24	CONQUEST All MotorHomes with Ford E350 or E450 Chassis	
F	02-11	CONQUEST All MotorHomes with Ford E350 or E450 Chassis	
F	10-11	CONQUEST SPORT All MotorHomes with Ford E350 or E450 Chassis	
F	01-02	CONQUEST SPORT All MotorHomes with Ford E350 or E450 Chassis	
F	00-11	INDEPENDENCE All MotorHomes with Ford E350 or E450 Chassis	
F	10-11	MONTAJ All MotorHomes with Ford E350 or E450 Chassis	
F	00-08	ULTRA	
F	02-04	YELLOWSTONE	
F	05-11	YELLOWSTONE All MotorHomes with Ford E350 or E450 Chassis	
F	19	HOLIDAY RAMBLER ALTERA	
F	18	ALTERA All MotorHomes with Ford E450 Chassis	
F	08	ATLANTIS	
F	06	ATLANTIS	
F	99-01	ATLANTIS	
F	09-10	ATLANTIS All MotorHomes with Ford E450 Chassis	
F	07	ATLANTIS All MotorHomes with Ford E450 Chassis	
F	02-05	ATLANTIS All MotorHomes with Ford E450 Chassis	
F	19	AUGUSTA All MotorHomes with Ford E450 Chassis	
F	15-16	AUGUSTA All MotorHomes with Ford E450 Chassis	
F	11	AUGUSTA All MotorHomes with Ford E450 Chassis	
F	08-09	AUGUSTA All MotorHomes with Ford E450 Chassis	
F	12-13	AUGUSTA B+ All MotorHomes with Ford E450 Chassis	
F	10	AUGUSTA B+ All MotorHomes with Ford E450 Chassis	
F	07	AUGUSTA B+ All MotorHomes with Ford E450 Chassis	
F	16	AUGUSTA LX All MotorHomes with Ford E450 Chassis	
F	07-10	AUGUSTA SPORT All MotorHomes with Ford E350 Chassis	
F	07-09	AUGUSTA TOURING SEDAN All MotorHomes with Ford E350 Chassis	
F	17-18	VESTA All MotorHomes with Ford E450 Chassis	
F	01-20	ITASCO CLASS C MOTORHOMES	
F	03-06	JAYCO ESCAPE All MotorHomes with Ford E350 or E450 Chassis	
F	02-06	GRANITE RIDGE All MotorHomes with Ford E350 or E450 Chassis	
F	02-24	GREYHAWK All MotorHomes with Ford E450 Chassis	
F	07-24	MELBOURNE All MotorHomes with Ford E350 or E450 Chassis	
F	13-24	REDHAWK All MotorHomes with Ford E450 Chassis	
F	18-24	REDHAWK SE All MotorHomes with Ford E450 Chassis	
F		KRYSTAL BUS VARIOUS	
F		LGE COACHWORKS VARIOUS	
F	11-12	NEXUS CLASS C MOTORHOMES	
F	11-24	PHANTOM All MotorHomes with Ford E350 or E450 Chassis	
F	20-24	TRIUMPH All MotorHomes with Ford E350 or E450 Chassis	

Numerical listing

Shock	POP	Alternative No.	MTG Acc. Supplied
Pos.	Year	Application	
77614	A (cont)		140780
F	24	VIPER 29V MotorHomes with Ford E350 or E450 Chassis	
F	11-23	VIPER All MotorHomes with Ford E350 or E450 Chassis	
F	00-23	PHOENIX CRUISER All MotorHomes with Ford E350 or E450 Chassis	
F		SHASTA RV ALL MODELS	
F		STARCRAFT BUS CO. E350 & E450 FORD CHASSIS MODELS	
F	92-22	THOMAS TYPE A SCHOOL BUS	
F	14-24	THOR MOTOR COACH AXIS All MotorHomes with Ford E350 or E450 Chassis	
F	11-24	CHATEAU All MotorHomes with Ford E350 or E450 Chassis	
F	11-12	CHATEAU CITATION All MotorHomes with Ford E350 or E450 Chassis	
F	12-16	CITATION All MotorHomes with Ford E350 or E450 Chassis	
F	22-24	ECHELON All MotorHomes with Ford E350 or E450 Chassis	
F	11-24	FOUR WINDS All MotorHomes with Ford E350 or E450 Chassis	
F	24	FOUR WINDS 28A MotorHomes with Ford E350 or E450 Chassis	
F	25	FOUR WINDS 282	
F	12-24	FREEDOM ELITE All MotorHomes with Ford E350 or E450 Chassis	
F	11-23	OUTLAW All MotorHomes with Ford E350 or E450 Chassis	
F	16-24	QUANTUM All MotorHomes with Ford E350 or E450 Chassis	
F	25	VEGAS 24.1	
F	14-24	VEGAS All MotorHomes with Ford E350 or E450 Chassis	
F		TURTLETOP BUS VARIOUS	
F		WHEELED COACH IND. VARIOUS	
F	07-13	WINNEBAGO ACCESS All MotorHomes with Ford E350 or E450 Chassis	
F	14	ACCESS PREMIER All MotorHomes with Ford E350 or E450 Chassis	
F	18-20	ASPECT	
F	05-17	ASPECT All MotorHomes with Ford E350 or E450 Chassis	
F	18-20	CAMBRIA	
F	09-15	CAMBRIA	
F	16-17	CAMBRIA All MotorHomes with Ford E350 or E450 Chassis	
F	05-08	CAMBRIA All MotorHomes with Ford E350 or E450 Chassis	
F	06-20	MINNIE	
F	99	MINNIE	
F	00-05	MINNIE All MotorHomes with Ford E350 or E450 Chassis	
F	14-24	MINNIE WINNIE All MotorHomes with Ford E350 or E450 Chassis	
F	00-06	MINNIE WINNIE All MotorHomes with Ford E350 or E450 Chassis	
F	11-18	OUTLOOK	
F	19-21	OUTLOOK All MotorHomes with Ford E350 or E450 Chassis	
F	06-10	OUTLOOK All MotorHomes with Ford E350 or E450 Chassis	
F	08-15	SPIRIT	
F	16-22	SPIRIT All MotorHomes with Ford E350 or E450 Chassis	
F	00-07	SPIRIT All MotorHomes with Ford E350 or E450 Chassis	
F		WORLD TRANS BUS CO. VARIOUS	
77623	D		142731
R	17-24	BERKSHIRE COACH ULTRA 24	
R	17-24	ULTRA 28	
R	92-24	BLUE BIRD MICROBIRD TYPE A SCHOOL BUS	
R		CHAMPION BUS INC. AMERICAN COACH	
R		CHALLENGER	
R		CRUSADER	
R		LF TRANSPORT	
R	03-24	COACH HOUSE PLATINUM All Motorhomes with Ford E450 Chassis	
R	23-24	PLATINUM IV All Motorhomes with Ford E450 Chassis	
R		COACHMEN CATALINA	
R	20-22	CONCORD	
R	04-06	CONCORD	
R	23-24	CONCORD All MotorHomes with Ford E350 or E450 Chassis	

Numerical listing

Max Control

Numerical listing

Shock	POP	Alternative No.	MTG Acc. Supplied
Pos.	Year	Application	
77623	D (cont)		142731
R	07-19	CONCORD All MotorHomes with Ford E350 or E450 Chassis	
R	04-08	FREEDOM EXPRESS	
R	09	FREEDOM EXPRESS All MotorHomes with Ford E350 or E450 Chassis	
R	03-07	FREELANDER	
R	08-24	FREELANDER All MotorHomes with Ford E350 or E450 Chassis	
R	10	LEPRECHAUN	
R	03-07	LEPRECHAUN	
R	11-24	LEPRECHAUN All MotorHomes with Ford E350 or E450 Chassis	
R	08-09	LEPRECHAUN All MotorHomes with Ford E350 or E450 Chassis	
R	98-03	PATHFINDER	
R	99-06	SANTARA	
R		COLLINS BUS CORP. VARIOUS DIAMOND COACH SHUTTLE BUSES	
R	92-09	DUTCHMEN RV CLASS C MOTORHOMES	
R	15-20	JAMBOREE	
R	92-17	DYNAMAX CORP ISATA 4	
R	18-20	ISATA 4 All MotorHomes with Ford E350 or E450 Chassis	
R		ELDORADO NATIONAL ADVANTAGE	
R		AEROLITE	
R		AEROTECH	
R	17	ENTEGR COACH ESTEEM	
R	18-24	ESTEEM All MotorHomes with Ford E350 or E450 Chassis	
R	17	ODYSSEY	
R	18-24	ODYSSEY All MotorHomes with Ford E350 or E450 Chassis	
R	23-24	ODYSSEY SE All MotorHomes with Ford E450 Chassis	
R		FEDERAL COACH VARIOUS FLEETWOOD JAMBOREE	
R	14-16	JAMBOREE	
R	99-07	JAMBOREE	
R	17-19	JAMBOREE All MotorHomes with Ford E350 or E450 Chassis	
R	08-13	JAMBOREE All MotorHomes with Ford E350 or E450 Chassis	
R	19-20	SURGE	
R	18	SURGE All MotorHomes with Ford E350 or E450 Chassis	
R	14-16	TIOGA	
R	99-07	TIOGA	
R	08-13	TIOGA All MotorHomes with Ford E350 or E450 Chassis	
R	00-02	FORD E-450 ECONOLINE SUPER DUTY ALL	
R	00-02	E-450 ECONOLINE SUPER DUTY All Exc. Cutaway Chassis	
R	21-24	VAN 1 TON, ECONOLINE / CLUB WAGON / SUPERDUTY ALL	
R	03-19	VAN 1 TON, ECONOLINE / CLUB WAGON / SUPERDUTY ALL Exc. Cutaway Chassis	
R		FOREST RIVER ALL AMERICAN FORESTER	
R	20	FORESTER	
R	04-19	FORESTER All MotorHomes with Ford E350 or E450 Chassis	
R	15-18	FORESTER GTS All MotorHomes with Ford E350 or E450 Chassis	
R	03-15	LEXINGTON All MotorHomes with Ford E350 or E450 Chassis	
R	21-24	SOLERA All MotorHomes with Ford E350 or E450 Chassis	
R	10-15	SOLERA All MotorHomes with Ford E350 or E450 Chassis	
R	23	SUNSEEKER	
R	99-06	SUNSEEKER	
R	07-22	SUNSEEKER All MotorHomes with Ford E350 or E450 Chassis	
R	19-20	SUNSEEKER GTS	
R	15-18	SUNSEEKER GTS All MotorHomes with Ford E350 or E450 Chassis	
R	99-09	GEORGIE BOY MANUFACTURING CLASS C MOTORHOMES	
R		GLAVAL BUS CO. VARIOUS GOSHEN COACH VARIOUS GRECH MOTORS VARIOUS	
R	02-15	GULF STREAM BT CRUISER	
R	16-24	BT CRUISER All MotorHomes with Ford E350 or E450 Chassis	
R	99-06	CAVALIER	
R	12-15	CONQUEST	
R	93-01	CONQUEST	
R	16-24	CONQUEST All MotorHomes with Ford E350 or E450 Chassis	

Shock	POP	Alternative No.	MTG Acc. Supplied
Pos.	Year	Application	
77623	D (cont)		142731
R	02-11	CONQUEST All MotorHomes with Ford E350 or E450 Chassis	
R	10-11	CONQUEST SPORT All MotorHomes with Ford E350 or E450 Chassis	
R	01-02	CONQUEST SPORT All MotorHomes with Ford E350 or E450 Chassis	
R	00-11	INDEPENDENCE All MotorHomes with Ford E350 or E450 Chassis	
R	10-11	MONTAJ All MotorHomes with Ford E350 or E450 Chassis	
R	00-08	ULTRA	
R	02-04	YELLOWSTONE	
R	05-11	YELLOWSTONE All MotorHomes with Ford E350 or E450 Chassis	
R	19	HOLIDAY RAMBLER ALTERA	
R	18	ALTERA All MotorHomes with Ford E450 Chassis	
R	08	ATLANTIS	
R	06	ATLANTIS	
R	99-01	ATLANTIS	
R	09-10	ATLANTIS All MotorHomes with Ford E450 Chassis	
R	07	ATLANTIS All MotorHomes with Ford E450 Chassis	
R	02-05	ATLANTIS All MotorHomes with Ford E450 Chassis	
R	19	AUGUSTA All MotorHomes with Ford E450 Chassis	
R	15-16	AUGUSTA All MotorHomes with Ford E450 Chassis	
R	11	AUGUSTA All MotorHomes with Ford E450 Chassis	
R	08-09	AUGUSTA All MotorHomes with Ford E450 Chassis	
R	12-13	AUGUSTA B+ All MotorHomes with Ford E450 Chassis	
R	10	AUGUSTA B+ All MotorHomes with Ford E450 Chassis	
R	07	AUGUSTA B+ All MotorHomes with Ford E450 Chassis	
R	16	AUGUSTA LX All MotorHomes with Ford E450 Chassis	
R	07-10	AUGUSTA SPORT All MotorHomes with Ford E350 Chassis	
R	07-09	AUGUSTA TOURING SEDAN All MotorHomes with Ford E350 Chassis	
R	17-18	VESTA All MotorHomes with Ford E450 Chassis	
R	01-20	ITASCA CLASS C MOTORHOMES	
R	03-06	JAYCO ESCAPE All MotorHomes with Ford E350 or E450 Chassis	
R	02-06	GRANITE RIDGE All MotorHomes with Ford E350 or E450 Chassis	
R	02-24	GREYHAWK All MotorHomes with Ford E450 Chassis	
R	07-24	MELBOURNE All MotorHomes with Ford E350 or E450 Chassis	
R	13-24	REDHAWK All MotorHomes with Ford E450 Chassis	
R	18-24	REDHAWK SE All MotorHomes with Ford E450 Chassis	
R		KRYSTAL BUS VARIOUS LGE COACHWORKS VARIOUS	
R	11-20	NEXUS CLASS C MOTORHOMES	
R	11-24	PHANTOM All MotorHomes with Ford E350 or E450 Chassis	
R	20-24	TRIUMPH All MotorHomes with Ford E350 or E450 Chassis	
R	24	VIPER 29V MotorHomes with Ford E350 or E450 Chassis	
R	11-23	VIPER All MotorHomes with Ford E350 or E450 Chassis	
R	00-23	PHOENIX CRUISER All MotorHomes with Ford E350 or E450 Chassis	
R		SHASTA RV ALL MODELS STARCRAFT BUS CO. E350 & E450 FORD CHASSIS MODELS	
R	92-20	THOMAS TYPE A SCHOOL BUS	
R	14-24	THOR MOTOR COACH AXIS All MotorHomes with Ford E350 or E450 Chassis	
R	11-24	CHATEAU All MotorHomes with Ford E350 or E450 Chassis	
R	11-12	CHATEAU CITATION All MotorHomes with Ford E350 or E450 Chassis	
R	12-16	CITATION All MotorHomes with Ford E350 or E450 Chassis	

Shock	POP	Alternative No.	MTG Acc. Supplied
Pos.	Year	Application	
77623	D (cont)		142731
R	22-24	ECHELON All MotorHomes with Ford E350 or E450 Chassis	
R	11-24	FOUR WINDS All MotorHomes with Ford E350 or E450 Chassis	
R	25	FOUR WINDS 282	
R	12-24	FREEDOM ELITE All MotorHomes with Ford E350 or E450 Chassis	
R	11-23	OUTLAW All MotorHomes with Ford E350 or E450 Chassis	
R	16-24	QUANTUM All MotorHomes with Ford E350 or E450 Chassis	
R	25	VEGAS 24.1	
R	14-24	VEGAS All MotorHomes with Ford E350 or E450 Chassis	
R		TURTLETOP BUS VARIOUS WHEELED COACH IND. VARIOUS	
R	07-13	WINNEBAGO ACCESS All MotorHomes with Ford E350 or E450 Chassis	
R	14	ACCESS PREMIER All MotorHomes with Ford E350 or E450 Chassis	
R	18-20	ASPECT	
R	06-17	ASPECT All MotorHomes with Ford E350 or E450 Chassis	
R	18-20	CAMBRIA	
R	09-15	CAMBRIA	
R	16-17	CAMBRIA All MotorHomes with Ford E350 or E450 Chassis	
R	05-08	CAMBRIA All MotorHomes with Ford E350 or E450 Chassis	
R	06-20	MINNIE	
R	99	MINNIE	
R	00-05	MINNIE All MotorHomes with Ford E350 or E450 Chassis	
R	14-24	MINNIE WINNIE All MotorHomes with Ford E350 or E450 Chassis	
R	00-06	MINNIE WINNIE All MotorHomes with Ford E350 or E450 Chassis	
R	11-18	OUTLOOK	
R	19-21	OUTLOOK All MotorHomes with Ford E350 or E450 Chassis	
R	06-10	OUTLOOK All MotorHomes with Ford E350 or E450 Chassis	
R	08-15	SPIRIT	
R	16-22	SPIRIT All MotorHomes with Ford E350 or E450 Chassis	
R	00-07	SPIRIT All MotorHomes with Ford E350 or E450 Chassis	
R		WORLD TRANS BUS CO. VARIOUS	
77638	A		
R	09-22	CHEVROLET EXPRESS 4500 All	
R	10-20	GMC SAVANA 4500 All	
77809	A		
F	99-04	FORD PICKUP, F-450 SUPERDUTY All	
F	99-04	PICKUP, F-550 SUPERDUTY All	
77907	W		
R	79-82	DODGE D50 RWD	
77967	D		143146
F	20-24	FORD F-600 SUPER DUTY All Applications with OEM Number	
F	13-24	PICKUP, F-450 SUPERDUTY All	
F	05-08	PICKUP, F-450 SUPERDUTY All	
F	13-24	PICKUP, F-550 SUPERDUTY All	
F	05-07	PICKUP, F-550 SUPERDUTY All	
77968	W		
R	13-16	FORD PICKUP, F-450 SUPERDUTY 4 X 2	
R	05-07	PICKUP, F-450 SUPERDUTY 4 X 2	
R	13-16	PICKUP, F-550 SUPERDUTY 4 X 2	
R	05-07	PICKUP, F-550 SUPERDUTY 4 X 2	
77969	W		
R	13-16	FORD PICKUP, F-450 SUPERDUTY 4 X 4	
R	05-07	PICKUP, F-450 SUPERDUTY 4 X 4	
R	13-16	PICKUP, F-550 SUPERDUTY 4 X 4	
R	05-07	PICKUP, F-550 SUPERDUTY 4 X 4	
77986	W		
R	24	FORD PICKUP, F-450 SUPERDUTY 4 X 4 Models with 4WD and OEM number	
R	17-23	PICKUP, F-450 SUPERDUTY All Models with 4WD and OEM number	
R	24	PICKUP, F-550 SUPERDUTY 4 X 4 Models with 4WD and OEM number	

Numerical listing

Max Control, Guardian Shock, Classic Shock Absorbers, 83000 Series

Numerical listing

Shock	POP	Alternative No.	MTG Acc. Supplied
Pos.	Year	Application	
77986	W	(cont)	
R	17-23	PICKUP, F-550 SUPERDUTY All Models with 4WD and OEM number	
R	17-23	PIERCE MFG. INC. VARIOUS	
R	19-23	RENEGADE VERACRUZ All Models with Ford F-550 Chassis (4WD and OEM number)	
R	19-23	THOR MOTOR COACH MAGNITUDE All Models with Ford F-550 Chassis (4WD and OEM number)	
R	19-23	OMNI All Models with Ford F-550 Chassis (4WD and OEM number)	
77987	W		
R	20-24	FORD F-600 SUPER DUTY 4 X 2 Models with RWD and OEM number	
R	24	PICKUP, F-450 SUPERDUTY RWD Models with RWD and OEM number	
R	17-23	PICKUP, F-450 SUPERDUTY All Models with RWD and OEM number	
R	24	PICKUP, F-550 SUPERDUTY RWD Models with RWD and OEM number	
R	17-23	PICKUP, F-550 SUPERDUTY All Models with RWD and OEM number	
R	19-23	THOR MOTOR COACH MAGNITUDE All Models with Ford F-550 Chassis (RWD and OEM number)	
R	19-23	OMNI All Models with Ford F-550 Chassis (RWD and OEM number)	
Guardian Shock			
81147	B		
R	79-82	DODGE D50 RWD	
F	68-75	FORD PICKUP P350 All Up through 8000# GVW	
F	75-76	PICKUP P400 All Up through 8000# GVW	
R	68-72	INTERNATIONAL M1100 / M1200 All	
R	69	M1400 All	
81318	C	141137	
R	87-89	DODGE RAIDER 2.6L 4Cyl L (156), 3.59 91.1(Bore)3.86 98.0(Stroke)	
F	68-72	INTERNATIONAL M1100 / M1200 All	
81710	C		
R	88-97	FORD F-SUPER DUTY All	
81744	A	140780	
F	21-24	FORD VAN 1 TON, ECONOLINE / CLUB WAGON / SUPERDUTY All	
F	10-19	VAN 1 TON, ECONOLINE / CLUB WAGON / SUPERDUTY All	
81828	W	142617	
R	21-24	FORD VAN 1 TON, ECONOLINE / CLUB WAGON / SUPERDUTY All	
R	10-19	VAN 1 TON, ECONOLINE / CLUB WAGON / SUPERDUTY All	
Classic Shock Absorbers			
82007	B	140349	
F	68-72	INTERNATIONAL M1100 / M1200 All	
F	69	M1400 All	
82155	A	141041	
R	66-67	FIAT 1100 All Exc. Wagon	
R	64-67	1500 All Exc. Wagon	
82156	A		
R	75-76	FIAT 124 All Wagon	
R	67-74	124 Wagon Wagon	
R	66-67	1100 All Wagon	
R	64-67	1500 All Wagon	
83000 Series			
83101	D		
F	13	INTERNATIONAL 4300LP All Models with O.E.M. Number	
R		SERIES 1000 FORWARD CONTROL CHASSIS	
83102	W	145089-000 (2)	
F		THOMAS VARIOUS	
83103	W	145054 (2)	
R	88-96	MINISUBISHI FUSO FH All Models with O.E.M. Number	

Shock	POP	Alternative No.	MTG Acc. Supplied
Pos.	Year	Application	
83112	C	145128 (1)	
R		INTERNATIONAL SERIES 4000 - SHORT CONVENTIONAL MEDIUM TRK & TRAC	
83114	W	140780 (1)	
F	00-04	ISUZU FRR All	
F	95-98	FRR All	
F	86	FSR	
F	87-96	FSR All FSR Models	
F	88-94	NRR All	
F	89-94	UD 1800 All Models with O.E.M. Number	
F	99-04	1800CS All Models with O.E.M. Number	
F	89-94	2000 All Models with O.E.M. Number	
83119	W		
F		FREIGHTLINER VARIOUS	
83120	W	145089-000(1)/145143(1)	
R	05-22	FREIGHTLINER B2 All Models with 15,000 lb Rear Suspension	
R	97-08	BUS CHASSIS	
R	95-05	FL50 All Models with 15,000 lb Rear Suspension	
R	91-05	FL60 All w/ 15000 lb Rear Suspension	
R	96-99	MC CHASSIS	
R	98-20	MT45 All Models with O.E.M. Number	
R	99-11	MT55 All Models with O.E.M. Number	
R		VARIOUS	
R	03-10	STERLING TRUCK ACTERRA All Models with 15000 lb Rear Suspension	
R	01-07	ACTERRA 5500 All Models with 15000 lb Rear Suspension	
R	01-07	ACTERRA 6500 All Models with 15000 lb Rear Suspension	
R	01-07	ACTERRA 7500 All Models with 15000 lb Rear Suspension	
R	03	ACTERRA 8500 All Models with 15000 lb Rear Suspension	
R	01	ACTERRA 8500 All Models with 15000 lb Rear Suspension	
R	05-22	THOMAS VARIOUS	
R		UPS TRUCK VARIOUS	
83122	W		
R	97-09	CHEVROLET C6500 KODIAK All Models with Hendrickson Air Suspension (Stamping number 47902-13)	
R	00-01	C7500 KODIAK All Models with Hendrickson Air Suspension (Stamping number 47902-13)	
R	99	T6500 All Models with Hendrickson Air Suspension (Stamping number 47902-13)	
R	09	COACHMEN AURORA	
R	07	AURORA	
R	08	AURORA All MotorHomes with Ford F53 Chassis with 16,000 lb GVW to 22,000 lb GVW	
R	04-06	AURORA All MotorHomes with Ford F53 Chassis with 16,000 lb GVW to 22,000 lb GVW	
R	21-24	ENCORE All MotorHomes with Ford F53 Chassis with 16,000 lb GVW to 22,000 lb GVW	
R	11-16	ENCOUNTER All MotorHomes with Ford F53 Chassis with 16,000 lb GVW to 22,000 lb GVW	
R	99-07	MIRADA	
R	08-24	MIRADA All MotorHomes with Ford F53 Chassis with 16,000 lb GVW to 22,000 lb GVW	
R	04-12	PURSUIT	
R	13-24	PURSUIT All MotorHomes with Ford F53 Chassis with 16,000 lb GVW to 22,000 lb GVW	
R	12-13	DAMON DAYBREAK	
R	99	DAYBREAK	
R	99	INTRUDER	
R	12-14	OUTLAW	
R	19-20	FLEETWOOD AXON	
R	06-23	FORD F-53	
R	99-04	F-53	
R	13-24	FOREST RIVER FR3 All MotorHomes with Ford F53 Chassis with 16,000 lb GVW to 22,000 lb GVW	

Shock	POP	Alternative No.	MTG Acc. Supplied
Pos.	Year	Application	
83122	W	(cont)	
R	08-17	GEORGETOWN All MotorHomes with Ford F53 Chassis with 16,000 lb GVW to 22,000 lb GVW	
R	16-24	GEORGETOWN GT3 All MotorHomes with Ford F53 Chassis with 16,000 lb GVW to 22,000 lb GVW	
R	17-24	GEORGETOWN GT5 All MotorHomes with Ford F53 Chassis with 16,000 lb GVW to 22,000 lb GVW	
R	20-24	GEORGETOWN GT7 All MotorHomes with Ford F53 Chassis with 16,000 lb GVW to 22,000 lb GVW	
R	99-09	GEORGIE BOY MANUFACTURING CLASS A MOTORHOMES	
R	99	GMC T5500	
R	99	T6500 All Models with Hendrickson Air Suspension (Stamping number 47902-13)	
R	11-15	HOLIDAY RAMBLER ADMIRAL	
R	02-06	ADMIRAL	
R	16-24	ADMIRAL All MotorHomes with Ford F53 Chassis with 16,000 lb GVW to 22,000 lb GVW	
R	07-10	ADMIRAL All MotorHomes with Ford F53 Chassis with 16,000 lb GVW to 22,000 lb GVW	
R	00-01	ADMIRAL All MotorHomes with Ford F53 Chassis with 16,000 lb GVW to 22,000 lb GVW	
R	02-06	ADMIRAL SE All MotorHomes with Ford F53 Chassis with 16,000 lb GVW to 22,000 lb GVW	
R	07	ADMIRAL SVE All MotorHomes with Ford F53 Chassis with 16,000 lb GVW to 22,000 lb GVW	
R	16-18	ADMIRAL XE All MotorHomes with Ford F53 Chassis with 16,000 lb GVW to 22,000 lb GVW	
R	23-24	ECLIPSE All MotorHomes with Ford F53 Chassis with 16,000 lb GVW to 22,000 lb GVW	
R	15	ENDEAVOR	
R	16-24	ENDEAVOR All MotorHomes with Ford F53 Chassis with 16,000 lb GVW to 22,000 lb GVW	
R	00-14	ENDEAVOR All MotorHomes with Ford F53 Chassis with 16,000 lb GVW to 22,000 lb GVW	
R	11-24	VACATIONER All MotorHomes with Ford F53 Chassis with 16,000 lb GVW to 22,000 lb GVW	
R	09	VACATIONER All MotorHomes with Ford F53 Chassis with 16,000 lb GVW to 22,000 lb GVW	
R	00-07	VACATIONER All MotorHomes with Ford F53 Chassis with 16,000 lb GVW to 22,000 lb GVW	
R		ISUZU FVR	
R	99-15	ITASCA CLASS A MOTORHOMES	
R	16-24	JAYCO ALANTE All MotorHomes with Ford F53 Chassis with 16,000 lb GVW to 22,000 lb GVW	
R	14-24	PRECEPT All MotorHomes with Ford F53 Chassis with 16,000 lb GVW to 22,000 lb GVW	
R	99-08	NATIONAL RV CLASS A MOTORHOMES	
R	13-20	NEWMAR CLASS A MOTORHOMES	
R	17-20	NEXUS MAYBACH All MotorHomes with Ford F53 Chassis with 16,000 lb GVW to 22,000 lb GVW	
R	11-24	THOR MOTOR COACH A.C.E. All MotorHomes with Ford F53 Chassis with 16,000 lb GVW to 22,000 lb GVW	
R	05-08	CHALLENGER	
R	09-24	CHALLENGER All MotorHomes with Ford F53 Chassis with 16,000 lb GVW to 22,000 lb GVW	
R	04-10	HURRICANE	
R	11-24	HURRICANE All MotorHomes with Ford F53 Chassis with 16,000 lb GVW to 22,000 lb GVW	
R	23-24	INDIGO All MotorHomes with Ford F53 Chassis with 16,000 lb GVW to 22,000 lb GVW	
R	23-24	LUMINATE All MotorHomes with Ford F53 Chassis with 16,000 lb GVW to 22,000 lb GVW	

Numerical listing

Shock	POP	Alternative No.	MTG Acc. Supplied
Pos.	Year	Application	
83122	W	(cont)	
R	14-24	MIRAMAR	All MotorHomes with Ford F53 Chassis with 16,000 lb GVW to 22,000 lb GVW
R	07-10	OUTLAW	
R	11-23	OUTLAW	All MotorHomes with Ford F53 Chassis with 16,000 lb GVW to 22,000 lb GVW
R	23-24	RESONATE	All MotorHomes with Ford F53 Chassis with 16,000 lb GVW to 22,000 lb GVW
R	06-10	WINDSPORT	
R	11-24	WINDSPORT	All MotorHomes with Ford F53 Chassis with 16,000 lb GVW to 22,000 lb GVW
R	19-23	WINNEBAGO ADVENTURER	All Motorhomes with Ford F-53 Chassis with 16,000 lb GVW to 22,000 lb GVW
R	06-17	ADVENTURER	All Motorhomes with Ford F-53 Chassis with 16,000 lb GVW to 22,000 lb GVW
R	99-04	ADVENTURER	All Motorhomes with Ford F-53 Chassis with 16,000 lb GVW to 22,000 lb GVW
R	18-20	INTENT	All Motorhome Chassis with 16,000 lb GVW to 18,000 lb GVW
R	18-20	INTENT	All Motorhome Chassis with 20,500 lb GVW to 22,000 lb GVW
R	11-17	SIGHTSEER	All Motorhome Chassis with 16,000 lb GVW to 18,000 lb GVW
R	11-17	SIGHTSEER	All Motorhome Chassis with 20,500 lb GVW to 22,000 lb GVW
R	08-09	SIGHTSEER	All Motorhome Chassis with 16,000 lb GVW to 18,000 lb GVW
R	06-09	SIGHTSEER	All Motorhome Chassis with 20,500 lb GVW to 22,000 lb GVW
R	02-04	SIGHTSEER	All Motorhome Chassis with 20,500 lb GVW to 22,000 lb GVW
R	16-17	SUNOVA	All Motorhome Chassis with 16,000 lb GVW to 18,000 lb GVW
R	16-17	SUNOVA	All Motorhome Chassis with 20,500 lb GVW to 22,000 lb GVW
R	06-07	SUNOVA	All Motorhome Chassis with 20,500 lb GVW to 22,000 lb GVW
R	02-04	SUNOVA	All Motorhome Chassis with 20,500 lb GVW to 22,000 lb GVW
R	16-22	SUNSTAR	All Motorhome Chassis with 16,000 lb GVW to 18,000 lb GVW
R	16-22	SUNSTAR	All Motorhome Chassis with 20,500 lb GVW to 22,000 lb GVW
R	02-04	SUNSTAR	All Motorhome Chassis with 20,500 lb GVW to 22,000 lb GVW
R	16-18	SUNSTAR LX	All Motorhome Chassis with 16,000 lb GVW to 18,000 lb GVW
R	16-18	SUNSTAR LX	All Motorhome Chassis with 20,500 lb GVW to 22,000 lb GVW
R	11-22	VISTA	All Motorhome Chassis with 16,000 lb GVW to 18,000 lb GVW
R	11-22	VISTA	All Motorhome Chassis with 20,500 lb GVW to 22,000 lb GVW
R	08-09	VISTA	All Motorhome Chassis with 16,000 lb GVW to 18,000 lb GVW
R	07-09	VISTA	All Motorhome Chassis with 20,500 lb GVW to 22,000 lb GVW
R	02-04	VISTA	All Motorhome Chassis with 20,500 lb GVW to 22,000 lb GVW
R	16-18	VISTA LX	All Motorhome Chassis with 16,000 lb GVW to 18,000 lb GVW
R	16-18	VISTA LX	All Motorhome Chassis with 20,500 lb GVW to 22,000 lb GVW

Shock	POP	Alternative No.	MTG Acc. Supplied
Pos.	Year	Application	
83123	C	(cont)	
R	13-24	KENWORTH K270	All Models with Hendrickson HAS - 210L or HAS - 230L Rear Air Suspension

83000 Series

Shock	POP	Alternative No.	MTG Acc. Supplied
Pos.	Year	Application	
83123	C	(cont)	
R	93-05	K300	All Models with Hendrickson Rear Air Suspension
R	08-23	T270	All Models with Hendrickson HAS - 210L or HAS - 230L Rear Air Suspension
R	00-08	T300	All Models with Hendrickson HAS - 210L or HAS - 230L Rear Air Suspension
R	13-24	PETERBILT 220	All Models with Hendrickson HAS - 210L or HAS - 230L Rear Air Suspension
R	10	220	All Models with Hendrickson HAS - 210L or HAS - 230L Rear Air Suspension
R	07	220	All Models with Hendrickson HAS - 210L or HAS - 230L Rear Air Suspension
83124	C		
F		COACHMEN CLASS A MOTORHOMES	
R	00-10	COUNTRY COACH AFFINITY	All MotorHomes with Neway IFS
F		FOREST RIVER CLASS A MOTORHOMES	
F		GEORGIE BOY MANUFACTURING CLASS A MOTORHOMES	
F		ITASCA CLASS A MOTORHOMES	
F		MONACO COACH CLASS A MOTORHOMES	
F		WORKHORSE VARIOUS	
83126	D		
F	69-70	CHEVROLET 4, 40, 4000 & 4500 SERIES	
R	71-72	5, 50, 5000 & 5500 SERIES	
F	69-70	5, 50, 5000 & 5500 SERIES	
R	02-23	FREIGHTLINER M2 106	All Models with Reyco 79KB Rear Steel Spring Suspension
F	72-80	GMC 4500 SERIES	
R	66-72	4500 SERIES	
F	66-89	5500 SERIES	
R	66-72	5500 SERIES	
F	05-10	HINO 145	All Models with O.E.M. Number
F	05-10	165	All Models with O.E.M. Number
F	05-10	185	All Models with O.E.M. Number
R	13-24	KENWORTH K270	All Models with Reyco 102 or 79KB Suspension (Drive Axle)
R	93-05	K300	All Models with Reyco 102 or 79KB Suspension (Drive Axle)
F	93-05	K300	All Models with Reyco 1209 or 1212 Suspension (Steer Axle)
R	08-22	T170	All Models with Reyco 79KB Rear Steel Spring Suspension
R	08-23	T270	All Models with Reyco 102 or 79KB Suspension (Drive Axle)
R	21-24	T280	All Models with Reyco 102 or 79KB Suspension (Drive Axle)
F		T300	
R	00-08	T300	All Models with Reyco 102 or 79KB Suspension (Drive Axle)
R	00-08	T300	All Models with Reyco 1209 or 1212 Suspension (Steer Axle)
R	08-15	PETERBILT 210	All Models with Reyco 102 or 79KB Suspension (Drive Axle)
R	13-24	220	All Models with Reyco 102 or 79KB Suspension (Drive Axle)
R	10	220	All Models with Reyco 102 or 79KB Suspension (Drive Axle)
R	07	220	All Models with Reyco 102 or 79KB Suspension (Drive Axle)
R	08-19	325	All Models with Reyco 102 or 79KB Suspension (Drive Axle)
83127	C		
F		FREIGHTLINER VARIOUS	
R		HOLIDAY RAMBLER VARIOUS	
F	23	MACK MD6	
F	24	MD6	All Models with 10,000 lb Taperleaf Springs
F	21-22	MD6	All Models with 10,000 lb Taperleaf Springs
83134	W	145054 (1)	
R	05-21	FREIGHTLINER M2	All Models with Rear 52" Spring ,10000 lb - 15000 lb
R	05-21	M2	All Models with Rear 52" Spring ,18000 lb - 23000 lb

Numerical listing

Shock	POP	Alternative No.	MTG Acc. Supplied
Pos.	Year	Application	
83134	W	(cont)	
R	02-10	M2 100	All Models with Rear 52" Spring ,10000 lb - 15000 lb
R	02-10	M2 100	All Models with Rear 52" Spring ,18000 lb - 23000 lb
R	02-23	M2 106	All Models with Rear 52" Spring ,10000 lb - 15000 lb
R	02-23	M2 106	All Models with Rear 52" Spring ,18000 lb - 23000 lb
83135	C		
F	19-22	CHEVROLET SILVERADO 4500 HD	All Models with 7,000 to 8,000 lb Front Axle
F	19-22	SILVERADO 5500 HD	All Models with 7,000 to 8,000 lb Front Axle
F	19-22	SILVERADO 6500 HD	All Models with 7,000 to 8,000 lb Front Axle
F	14	FORD F-650	
F	02-20	INTERNATIONAL 4300	All Models with 6,000 to 8,000 lb Front Suspension
F	02-19	4400	All Models with 6,000 to 8,000 lb Front Suspension
F	10-12	DURASTAR - 4300, 4400 SERIES	
F	12-18	TERRASTAR	All Models with 6,000 to 7,000 lb Front Axle
83136	W	145054 (2)	
F		CHAMPION BUS INC. VARIOUS	
F		CHEVROLET B - SERIES - SCHOOL BUS	
F	90-96	C60 KODIAK	All Conventional Cab w/ Front Shock with O.E.M. Number
R	90-96	C60 KODIAK	All Conventional Cab w/19000, 21000, 23000 lb Taperleaf Springs (EXC Low Profile Vehicle)
F	90-02	C4500 KODIAK	
R	90-02	C4500 KODIAK	
F	03-09	C4500 KODIAK	All C Chassis - Conventional Cab
R	03-09	C4500 KODIAK	All C Chassis - Conventional Cab w/19000, 21000, 23000 lb Taperleaf Springs (EXC Low Profile Vehicle)
F	92-02	C5500 KODIAK	
R	92-02	C5500 KODIAK	
F	03-09	C5500 KODIAK	All C Chassis - Conventional Cab
R	03-09	C5500 KODIAK	All C Chassis - Conventional Cab w/19000, 21000, 23000 lb Taperleaf Springs (EXC Low Profile Vehicle)
F	90-91	C5500 KODIAK	All C Chassis - Conventional Cab
R	90-91	C5500 KODIAK	All C Chassis - Conventional Cab w/19000, 21000, 23000 lb Taperleaf Springs (EXC Low Profile Vehicle)
F	97-09	C6500 KODIAK	All Conventional Cab w/ Front Shock with O.E.M. Number
R	97-09	C6500 KODIAK	All Conventional Cab w/19000, 21000, 23000 lb Taperleaf Springs (EXC Low Profile Vehicle)
F	00-01	C7500 KODIAK	All Conventional Cab w/ Front Shock with O.E.M. Number
R	00-01	C7500 KODIAK	All Conventional Cab w/19000, 21000, 23000 lb Taperleaf Springs (EXC Low Profile Vehicle)
F		C - SERIES (C6500, C7500, C8500) KODIAK	
R	92-96	P60	All Motorhome Chassis
R	92-96	P6000	All Motorhome Chassis
F	97-09	T5500	
R	92-99	T5500	
F	03	T6500	
R	92-96	T6500	
F	04-09	T6500	All FL1 Tilt Cab with 8100 lb Axle
F	04-09	T6500	All FL2 Tilt Cab with 5000 to 11000 lb Axle
F	04-09	T6500	All FL3 Tilt Cab with 14575 lb Axle
F	97-02	T6500	All FL1 Tilt Cab with 8100 lb Axle
F	97-02	T6500	All FL2 Tilt Cab with 5000 to 11000 lb Axle
F	97-02	T6500	All FL3 Tilt Cab with 14575 lb Axle

Numerical listing

Shock	POP	Alternative No.	MTG Acc. Supplied
Pos.	Year	Application	
83136	W	(cont)	145054 (2)
R	97-99	T6500 All Tilt Cab w/19000, 21000, 23000 lb Taperleaf Springs (EXC Low Profile Veh.)	
R	92-96	VAN 1 TON, P SERIES All Motorhome Chassis	
F	90-02	GMC C4500 TOPKICK	
R	90-02	C4500 TOPKICK	
R	03-09	C4500 TOPKICK All C Chassis - Conventional Cab with 19000, 21000, 23000 lb Taperleaf Springs (EXC Low Profile Vehicle)	
F	03-09	C4500 TOPKICK All C Chassis - Conventional Cab with Front Shock with O.E.M. Number	
F	90-02	C5500 TOPKICK	
R	90-02	C5500 TOPKICK	
R	03-09	C5500 TOPKICK All C Chassis - Conventional Cab with 19000, 21000, 23000 lb Taperleaf Springs (EXC Low Profile Vehicle)	
F	03-09	C5500 TOPKICK All C Chassis - Conventional Cab with Front Shock with O.E.M. Number	
R	92-96	P - SERIES	
F	97-09	T5500	
R	92-99	T5500	
F	03	T6500	
R	92-96	T6500	
F	04-09	T6500 All FL1 Tilt Cab with 8100 lb Axle	
F	04-09	T6500 All FL2 Tilt Cab with 5000 to 11000 lb Axle	
F	04-09	T6500 All FL3 Tilt Cab with 14575 lb Axle	
F	97-02	T6500 All FL1 Tilt Cab with 8100 lb Axle	
F	97-02	T6500 All FL2 Tilt Cab with 5000 to 11000 lb Axle	
F	97-02	T6500 All FL3 Tilt Cab with 14575 lb Axle	
R	97-99	T6500 All Tilt Cab with 19000, 21000, 23000 lb Taperleaf Springs (EXC Low Profile Veh.)	
F	04-07	GULF STREAM ENDURA	
F	08	ENDURA All MotorHomes with Chevy Kodiak Chassis	
R	97-02	ISUZU FSR All Models with 19000, 21000, 23000 lb Taperleaf Springs (EXC Low Profile Veh.)	
F	97-02	FSR All Models with FL1 Tilt Cab with 8100 lb Axle (Including Low Profile)	
R	97-09	FTR All Models with 19000, 21000, 23000 lb Taperleaf Springs (EXC Low Profile Veh.)	
F	90-09	FTR All Models with O.E.M. Number	
R	97-08	FVR All Models with 19000, 21000, 23000 lb Taperleaf Springs (EXC Low Profile Veh.)	
F	97-08	FVR All Models with O.E.M. Number	
R	93-05	KENWORTH K300 All Models with Woodhead Shock (Stamping Number ACHB 966)	
R		T300	
83137	W		
R	97-09	CHEVROLET C6500 KODIAK All Models with Hendrickson Air Suspension with O.E.M. Number	
R	00-01	C7500 KODIAK All Models with Hendrickson Air Suspension with O.E.M. Number	
R	18-24	ISUZU FTR All Models with Hendrickson HAS suspension	
R	00-11	FTR All Models with Hendrickson HAS suspension	
R	10-11	FVR All Models with Hendrickson HAS suspension	
R	00-08	FVR All Models with Hendrickson HAS suspension	
R	13-24	KENWORTH K270 All Models with Hendrickson HAS - 230 Rear Air Suspension	
R	08-14	T270 All Models with Hendrickson HAS - 400 (Standard) Rear Air Suspension	
83140	D		415010-802(2)/145148(2)
F	05-10	HINO 185 All Models with O.E.M. Number	
F	05-14	238 All Models with O.E.M. Number	
F	06-14	258 All Models with O.E.M. Number	
F	05-14	268 All Models with O.E.M. Number	

83000 Series

Shock	POP	Alternative No.	MTG Acc. Supplied
Pos.	Year	Application	
83140	D	(cont)	415010-802(2)/145148(2)
F	08-14	268A All Models with O.E.M. Number	
83141	W		415010-802(2)/145148(2)
F	98-04	HINO FB1817 All FE Models Trucks with:	
F	98-04	FE SERIES	
83142	C		145128 (1)
R	05-21	FREIGHTLINER M2 All Models with Hendrickson HMX 400/460 Haulmax with 17.5" & 18.5" Saddle	
R	02-10	M2 100 All Models with Hendrickson HMX 400/460 Haulmax with 17.5" & 18.5" Saddle	
R	02-24	M2 106 All Models with Hendrickson HMX 400/460 Haulmax with 17.5" & 18.5" Saddle	
R	19-23	PIERCE MFG. INC. VARIOUS	
83143	D		145128 (1)
R	05-21	FREIGHTLINER M2 All Models with Hendrickson HMX 400/460 Haulmax with 16.5" Saddle	
R	02-10	M2 100 All Models with Hendrickson HMX 400/460 Haulmax with 16.5" Saddle	
R	02-24	M2 106 All Models with Hendrickson HMX 400/460 Haulmax with 16.5" Saddle	
R	08-23	KENWORTH T270 All Models with Hendrickson HMX 400/460 Haulmax with 16.5" Saddle	
R	19-23	PIERCE MFG. INC. VARIOUS	
83144	W		
F	00-03	HOLIDAY RAMBLER CLASS A MOTORHOMES	
F	00-07	MONACO COACH CLASS A MOTORHOMES	
83147	C		
R		THOMAS VARIOUS	
83148	D		
R	20	FORD F-650	
R		HINO ADDITIONAL APPLICATIONS	
83154	D		145089-000 (1)
R	98-23	FREIGHTLINER MT45 All Walkin Step Van Models (18 Foot) with O.E.M. Number	
R		MT55	
R	00-02	XCS CHASSIS	
83157	W		
F	99-20	FREIGHTLINER MT45 All MT45 Step Van - w/35" Front Spring	
F	99-20	MT55 All MT55 Step Van - w/35" Front Spring	
83159	W		TR0027 (4)
R	16-23	CHEVROLET LCF 3500 All	
R	18	LCF 3500HD	
R	16-17	LCF 3500HD All	
R	19-22	SILVERADO 4500 HD All Diesel Low Cab Forward models with 14,000 to 15,000 lb Rear	
R	19-22	SILVERADO 4500 HD All Diesel Low Cab Forward models with 15,000 to 16,000 lb Rear	
R	19-22	SILVERADO 5500 HD All Diesel Low Cab Forward models with 14,000 to 15,000 lb Rear	
R	19-22	SILVERADO 5500 HD All Diesel Low Cab Forward models with 15,000 to 16,000 lb Rear	
R	05-09	GMC W - SERIES (ISUZU)	
R	05-09	ISUZU FTR All Models with O.E.M. Number	
R	95-20	NPR All Models with O.E.M. Number	
R	20-23	NPR-HD All Models with 14,000 to 15,000 lb Rear	
R	20-23	NPR-HD All Models with 15,000 to 16,000 lb Rear	
R	03-23	NPR-HD All Models with O.E.M. Number	
R	23	NPR-XD	
R	15-22	NPR-XD All Models with 14,000 to 15,000 lb GVW	
R	15-22	NPR-XD All Models with 15,000 to 16,000 lb Rear	

Numerical listing

Shock	POP	Alternative No.	MTG Acc. Supplied
Pos.	Year	Application	
83159	W	(cont)	TR0027 (4)
R	20-23	NQR All Models with 15,000 to 16,000 lb Rear	
R	03-19	NQR All Models with O.E.M. Number	
R	02	NQR All Diesel	
R	95-97	NQR All Diesel	
R	20-23	NRR All Models with 15,000 to 16,000 lb Rear	
R	05-19	NRR All Models with O.E.M. Number	
R	11-15	REACH All Models with O.E.M. Number	
83160	W		
F	06	COACHMEN CROSS COUNTRY	
F	03-05	CROSS COUNTRY ELITE	
F	03-05	CROSS COUNTRY SE	
F	02-04	FOREST RIVER REFLECTION	
F	02-06	TSUNAMI	
F	93-07	FREIGHTLINER VC CHASSIS	
F		XB CHASSIS	
F		XC CHASSIS	
F	93-12	XC CHASSIS	
F	01-02	XCS CHASSIS	
F	03-06	GULF STREAM ATRIUM	
F	02-06	FRIENDSHIP	
F	02	INDEPENDENCE All MotorHomes with Freightliner XC Chassis and AS120 Front Suspension	
F	02-06	SCENIC CRUISER	
F	02-04	YELLOWSTONE	
F	95-99	HOLIDAY RAMBLER CLASS A MOTORHOMES	
F	02-06	ITASCA CLASS A MOTORHOMES	
F	04-06	KING OF THE ROAD CLASS A MOTORHOMES	
F	04-06	MANDALAY COACH CLASS A MOTORHOMES	
F	95-99	MONACO COACH VARIOUS	
F	02-06	NEWMAR CLASS A MOTORHOMES	
F	02-06	THOR MOTOR COACH CLASS A MOTORHOMES	
F	02-06	WINNEBAGO JOURNEY All MotorHomes with Freightliner XC Chassis and AS120 Front Suspension	
F	06	TOUR All MotorHomes with Freightliner XC Chassis and AS120 Front Suspension	
F	06	VECTRA All MotorHomes with Freightliner XC Chassis and AS120 Front Suspension	
83162	W		140780(1)/145116 & 406422 & 415010-802(1)
F	87-93	ISUZU EVR All EVR Models	
F	86	FSR	
F	87-92	FSR All FSR Models	
F	94-96	FVR All FVR Short & Middle Chassis	
F	88-92	FVR All FVR Short & Middle Chassis	
F	89-13	UD 2600 All Models with O.E.M. Number	
83163	B		
F	10-23	IC CORPORATION CE SCHOOL BUS All CE Model School Buses (71 Capacity) with 9,000 to 10,000 lb Front Suspension	
F	08-09	INTERNATIONAL 4300 All Models with 9,000 to 10,000 lb Front Suspension	
F	08-09	4400 All Models with 9,000 to 10,000 lb Front Suspension	
F	15-19	DURASTAR All Models with 9,000 to 10,000 lb Front Suspension	
F	13	DURASTAR All Models with 9,000 to 10,000 lb Front Suspension	
F	19-22	MV607 All Models with 9,000 to 10,000 lb Front Suspension	
F	20	MV All Models with 9,000 to 10,000 lb Front Suspension	
F	19-22	PIERCE MFG. INC. VARIOUS	
83164	W		
F		FREIGHTLINER MP 14	
F		MP 19	
F	99-20	MT45 All MT45 Step Van - w/38" Front Spring	
F	99-20	MT55 All MT55 Step Van - w/38" Front Spring	

Numerical listing

Shock	POP	Alternative No.	MTG Acc. Supplied
Pos.	Year	Application	
83166	W		
R	08-14	HINO 238	All Models with Hendrickson Comfort Air (Single Axle - 19K)
R	08-23	258	All Models with Hendrickson Comfort Air (Single Axle - 19K)
R	08-14	258ALP	All Models with Hendrickson Comfort Air (Single Axle - 19K)
R	08-23	268	All Models with Hendrickson Comfort Air (Single Axle - 19K)
R	08-14	268A	All Models with Hendrickson Comfort Air (Single Axle - 19K)
R	22-24	L6	
R	21	L6	All Models with Hendrickson Comfort Air (Single Axle - 19K)
R	21	L7	All Models with Hendrickson Comfort Air (Single Axle - 21K & 23K)
R	21	L8	All Models with Hendrickson Comfort Air (Single Axle - 21K & 23K)
R	20-24	ISUZU FTR	All Models with Hendrickson Comfort Air (Single Axle - 21K & 23K)
R	21-22	LION LION6	All Models with Hendrickson Comfort Air Suspension (21K Capacity)
83168	W		
R		HINO 268, 268A SERIES	
83169	W		
F	13-18	IC CORPORATION	CE SCHOOL BUS All CE Model School Buses with 6,000 to 8,000 lb Front Axles
F	15-20	INTERNATIONAL DURASTAR	All Models with 6,000 to 8,000 lb Front Suspension
F	13	DURASTAR	All Models with 6,000 to 8,000 lb Front Suspension
F	13-18	DURASTAR - 4300, 4400 SERIES	
F	19-22	MV607	All Models with 6,000 to 8,000 lb Front Suspension
83175	W		
F	14	FORD F-650	
F	00-15	GLAVAL BUS CO. CONCORDE II - SERIES	
F	00-15	STARCRAFT BUS CO. ALLSTAR XL & XLT - SERIES	
83180	W		
R	14	INTERNATIONAL TERRASTAR	All 4 WD Models with Rear Spring Suspension
83207	C		
F	73-80	CHEVROLET 5, 50, 5000 & 5500 SERIES	
F	73-80	GMC 5000 SERIES	
F	73-75	6000 SERIES	
83209	D		
F	09	COACHMEN AURORA	
F	07	AURORA	
F	08	AURORA	All MotorHomes with Ford F53 Chassis with 16,000 lb GVW to 22,000 lb GVW
F	04-06	AURORA	All MotorHomes with Ford F53 Chassis with 16,000 lb GVW to 22,000 lb GVW
F	21-24	ENCORE	All MotorHomes with Ford F53 Chassis with 16,000 lb GVW to 22,000 lb GVW
F	11-16	ENCOUNTER	All MotorHomes with Ford F53 Chassis with 16,000 lb GVW to 22,000 lb GVW
F	99-07	MIRADA	
F	08-24	MIRADA	All MotorHomes with Ford F53 Chassis with 16,000 lb GVW to 22,000 lb GVW
F	04-12	PURSUIT	
F	13-24	PURSUIT	All MotorHomes with Ford F53 Chassis with 16,000 lb GVW to 22,000 lb GVW
F	12-13	DAMON DAYBREAK	
F	99	DAYBREAK	
F	99	INTRUDER	
F	12-14	OUTLAW	
F	19-20	FLEETWOOD AXON	
F	06-23	FORD F-53	
F	99-04	F-53	
F	88-97	F-53	
F	05	F-53 MOTORHOME CHASSIS	
F	98	F-53 MOTORHOME CHASSIS	

83000 Series

Shock	POP	Alternative No.	MTG Acc. Supplied
Pos.	Year	Application	
83209	D (cont)		
R	73-77	W AND WT SERIES - HI TILT CAB HIGHWAY TRACTOR	
F	13-24	FOREST RIVER FR3	All MotorHomes with Ford F53 Chassis with 16,000 lb GVW to 22,000 lb GVW
F	08-17	GEORGETOWN	All MotorHomes with Ford F53 Chassis with 16,000 lb GVW to 22,000 lb GVW
F	16-24	GEORGETOWN GT3	All MotorHomes with Ford F53 Chassis with 16,000 lb GVW to 22,000 lb GVW
F	17-24	GEORGETOWN GT5	All MotorHomes with Ford F53 Chassis with 16,000 lb GVW to 22,000 lb GVW
F	20-24	GEORGETOWN GT7	All MotorHomes with Ford F53 Chassis with 16,000 lb GVW to 22,000 lb GVW
F	99-09	GEORGIE BOY MANUFACTURING CLASS A MOTORHOMES	
F	11-15	HOLIDAY RAMBLER ADMIRAL	
F	02-06	ADMIRAL	
F	16-24	ADMIRAL	All MotorHomes with Ford F53 Chassis with 16,000 lb GVW to 22,000 lb GVW
F	07-10	ADMIRAL	All MotorHomes with Ford F53 Chassis with 16,000 lb GVW to 22,000 lb GVW
F	00-01	ADMIRAL	All MotorHomes with Ford F53 Chassis with 16,000 lb GVW to 22,000 lb GVW
F	02-06	ADMIRAL SE	All MotorHomes with Ford F53 Chassis with 16,000 lb GVW to 22,000 lb GVW
F	07	ADMIRAL SVE	All MotorHomes with Ford F53 Chassis with 16,000 lb GVW to 22,000 lb GVW
F	16-18	ADMIRAL XE	All MotorHomes with Ford F53 Chassis with 16,000 lb GVW to 22,000 lb GVW
F	23-24	ECLIPSE	All MotorHomes with Ford F53 Chassis with 16,000 lb GVW to 22,000 lb GVW
F	15	ENDEAVOR	
F	16-24	ENDEAVOR	All MotorHomes with Ford F53 Chassis with 16,000 lb GVW to 22,000 lb GVW
F	00-14	ENDEAVOR	All MotorHomes with Ford F53 Chassis with 16,000 lb GVW to 22,000 lb GVW
F	11-24	VACATIONER	All MotorHomes with Ford F53 Chassis with 16,000 lb GVW to 22,000 lb GVW
F	09	VACATIONER	All MotorHomes with Ford F53 Chassis with 16,000 lb GVW to 22,000 lb GVW
F	00-07	VACATIONER	All MotorHomes with Ford F53 Chassis with 16,000 lb GVW to 22,000 lb GVW
F	99-15	ITASCA CLASS A MOTORHOMES	
F	16-24	JAYCO ALANTE	All MotorHomes with Ford F53 Chassis with 16,000 lb GVW to 22,000 lb GVW
F	14-24	PRECEPT	All MotorHomes with Ford F53 Chassis with 16,000 lb GVW to 22,000 lb GVW
F	07-08	MONACO COACH LA PALMA	
F	01	LA PALMA	
F	90-99	LA PALMA	
F	03-05	MONARCH	
F	90-99	MONARCH	
F	99-08	NATIONAL RV CLASS A MOTORHOMES	
F	24	NEWMAR BAY STAR 3626 F53	Chassis with 16,000 lb GVW to 22,000 lb GVW
F	13-20	CLASS A MOTORHOMES	
F	17-20	NEXUS MAYBACH	All MotorHomes with Ford F53 Chassis with 16,000 lb GVW to 22,000 lb GVW
F	11-24	THOR MOTOR COACH A.C.E.	All MotorHomes with Ford F53 Chassis with 16,000 lb GVW to 22,000 lb GVW
F	05-08	CHALLENGER	
F	09-24	CHALLENGER	All MotorHomes with Ford F53 Chassis with 16,000 lb GVW to 22,000 lb GVW
F	04-10	HURRICANE	

Numerical listing

Shock	POP	Alternative No.	MTG Acc. Supplied
Pos.	Year	Application	
83209	D (cont)		
F	11-24	HURRICANE	All MotorHomes with Ford F53 Chassis with 16,000 lb GVW to 22,000 lb GVW
F	23-24	INDIGO	All MotorHomes with Ford F53 Chassis with 16,000 lb GVW to 22,000 lb GVW
F	23-24	LUMINATE	All MotorHomes with Ford F53 Chassis with 16,000 lb GVW to 22,000 lb GVW
F	14-24	MIRAMAR	All MotorHomes with Ford F53 Chassis with 16,000 lb GVW to 22,000 lb GVW
F	07-10	OUTLAW	
F	11-23	OUTLAW	All MotorHomes with Ford F53 Chassis with 16,000 lb GVW to 22,000 lb GVW
F	23-24	RESONATE	All MotorHomes with Ford F53 Chassis with 16,000 lb GVW to 22,000 lb GVW
F	06-10	WINDSPORT	
F	11-24	WINDSPORT	All MotorHomes with Ford F53 Chassis with 16,000 lb GVW to 22,000 lb GVW
F	25	TIFFIN ALLEGRO OPEN ROAD 34PA	F53 Chassis with 16,000 lb GVW to 22,000 lb GVW
F	19-23	WINNEBAGO ADVENTURER	All MotorHomes with Ford F53 Chassis with 16,000 lb GVW to 22,000 lb GVW
F	92-17	ADVENTURER	All MotorHomes with Ford F53 Chassis with 16,000 lb GVW to 22,000 lb GVW
F	18-20	INTENT	All MotorHomes with Ford F53 Chassis with 16,000 lb GVW to 22,000 lb GVW
F	02-17	SIGHTSEER	All MotorHomes with Ford F53 Chassis with 16,000 lb GVW to 22,000 lb GVW
F	16-17	SUNOVA	All MotorHomes with Ford F53 Chassis with 16,000 lb GVW to 22,000 lb GVW
F	02-07	SUNOVA	All MotorHomes with Ford F53 Chassis with 16,000 lb GVW to 22,000 lb GVW
F	16-22	SUNSTAR	All MotorHomes with Ford F53 Chassis with 16,000 lb GVW to 22,000 lb GVW
F	02-04	SUNSTAR	All MotorHomes with Ford F53 Chassis with 16,000 lb GVW to 22,000 lb GVW
F	16-18	SUNSTAR LX	All MotorHomes with Ford F53 Chassis with 16,000 lb GVW to 22,000 lb GVW
F	07-22	VISTA	All MotorHomes with Ford F53 Chassis with 16,000 lb GVW to 22,000 lb GVW
F	02-04	VISTA	All MotorHomes with Ford F53 Chassis with 16,000 lb GVW to 22,000 lb GVW
F	16-18	VISTA LX	All MotorHomes with Ford F53 Chassis with 16,000 lb GVW to 22,000 lb GVW
83214	W		401754 (4)
F		SPARTAN MOTORS	VARIOUS
83215	W		401754 (4)
R	86-87	HINO FD16	All Models with O.E.M. Number
R	88-92	FD17	All Models with O.E.M. Number
R	93-97	FD2218	All (FD5H). FE5H, FF5H
R	93-97	FD2218LD	
R	93-97	FD2218LP	All Models with O.E.M. Number
R	98	FE2620	All
83216	W		140149 (1)
F	66-72	GMC 4500 SERIES	
F	66-72	5500 SERIES	
R	89-91	HINO FA14	All FA, FB Models Trucks with:
R	92	FA15	All FA, FB Models Trucks with:
R	93-97	FA1415	All (FA15)
R	93-97	FA1415	All FA, FB Models Trucks with:
R	93-97	FA1415	All FA1415 (FA15), FB1715 (FB15)
R	98-04	FA1517	All FA, FB Models Trucks with:
R	98	FA1517	All

Numerical listing

Shock	POP	Alternative No.	MTG Acc. Supplied
Pos.	Year	Application	
83216	W	(cont)	140149 (1)
R 98	FA1517	All FA1517, FA1817, FB1817	
R 98	FA1817		
R 89-91	FB14	All FA, FB Models Trucks with:	
R 92	FB15	All FA, FB Models Trucks with:	
R 93-97	FB1715	All FA, FB Models Trucks with:	
R 93-97	FB1715	All FA1415 (FA15), FB1715 (FB15)	
R 98-04	FB1817	All FA, FB Models Trucks with:	
R 98	FB1817	All	
R 98	FB1817	All FA1517, FA1817, FB1817	
F 93-97	FD2218	All (FD5H), FE5H, FF5H	
F 93-97	FD2218LP	All Models with O.E.M. Number	
F 86-87	FE16	All	
F 90-91	GC17	All GC17	
F 92	GC20	All GC20	
R	INTERNATIONAL BINDER CARGOSTAR		
83221	W		
F 67-72	CHEVROLET	4, 40, 4000 & 4500 SERIES	
R 67-68	4, 40, 4000 & 4500 SERIES		
R 76-89	5, 50, 5000 & 5500 SERIES		
F 75-80	5, 50, 5000 & 5500 SERIES		
F 68-72	5, 50, 5000 & 5500 SERIES		
R 63-69	5, 50, 5000 & 5500 SERIES		
R 83-99	C4500 KODIAK		
R 92-99	C5500 KODIAK		
R 83-89	C5500 KODIAK		
R 90-91	C5500 KODIAK	All C Chassis - Conventional Cab with 9100 to 17500 lb Rear Axle	
R 97-99	C6500 KODIAK	All Conventional Cab with 9100 to 17500 lb Rear Axle	
R 60-66	GMC	3500 & 4000 SERIES	
R 72-80	4500 SERIES		
F 66-72	4500 SERIES		
R 76-89	5000 SERIES		
F 75-80	5000 SERIES		
R 60-62	5000 SERIES		
F 66-72	5500 SERIES		
R 83-99	C - SERIES (C4500, C5500)	TOPKICK	
F	WORKHORSE VARIOUS		
83225	W		401754 (4)
R 80-85	FORD	LN600 All Models with 11000, 13000, 15000, 17000 lb Axles	
F	INTERNATIONAL CARGOSTAR		
83243	W		
R 19-21	CHEVROLET	SILVERADO 4500 HD All Models with 4 x 4 Rear	
R 19-22	SILVERADO 5500 HD	All Models with 4 x 4 Rear	
R 19-22	SILVERADO 6500 HD	All Models with 4 x 4 Rear	
R 19-22	INTERNATIONAL	CV515 All Models with 4 x 4 Rear	
83244	W		145178 (1)
R 20-21	IC CORPORATION	CE SCHOOL BUS All CE Model School Buses with 17,000 lb - 22,000 lb rear suspension	
83303	W		140702 (1)
F 72-80	GMC	4500 SERIES	
F 79-80	6000 SERIES		
83308	W		140149 (1)
F 80-86	FORD	C600 All Models with 3100 lb Spring and 7000 lb Axle	
F 80-85	LN600	All Models with 3000, 3300 lb Springs and 5000, 5500, 6000, 7000 lb Axles	
83309	W		140149 (1)
F	INTERNATIONAL CARGOSTAR		
83312	W		140149 (1)
F 80-86	FORD	C600 All Models with 4040, 5040 lb Springs and 7000, 9000, 12000 lb Axles	
F 80-85	LN600	All Models with 4400 lb Spring and 7000, 9000 lb Axles	

83000 Series, Cab Shock

Shock	POP	Alternative No.	MTG Acc. Supplied
Pos.	Year	Application	
83312	W	(cont)	140149 (1)
F 93-05	KENWORTH	K300 All Models with Multiple Leaf Springs on Front Axle (3/4" Mounting bolts)	
F	T300		
83314	W		140149 (1)
F	INTERNATIONAL CARGOSTAR		
83317	W		141083 (1)
R 14	FORD	F-650	
R 04-15	GLAVAL BUS CO.	CONCORDE II - SERIES	
R 10-13	IC CORPORATION	CE SCHOOL BUS All CE Model School Buses with 22,000 lb Rear Spring Suspension	
R 02-13	INTERNATIONAL	4300 All Models with 22,000 lb Rear Spring Suspension	
R 02-13	4400	All Models with 22,000 lb Rear Spring Suspension	
R 13	DURASTAR	All Models with 22,000 lb Rear Spring Suspension	
R 04-11	STARCRRAFT BUS CO.	ALLSTAR XL & XLT - SERIES	
83364	W		
R 16-20	INTERNATIONAL	DURASTAR All Models with 10,500 or 13,500 lb Vari-Rate Rear Spring Suspension	
R 12-18	TERRASTAR	All Models with 10,500 or 13,500 lb Vari-Rate Rear Spring Suspension	
83391	W		145177 (2)
F 15-21	HINO	258 All Models with O.E.M. Number	
F 15-20	258LP	All Models with O.E.M. Number	
F 15-22	268	All Models with O.E.M. Number	
F 22-24	L6		
F 21	L6	All Models with O.E.M. Number	
F 21	L7	All Models with O.E.M. Number	
83395	W		145054 (1)
R 16-17	INTERNATIONAL	DURASTAR All Models with Vari-Rate Rear Spring Suspension	
83397	W		
F 19-22	CHEVROLET	SILVERADO 4500 HD All Models with Taperleaf Front	
F 19-23	SILVERADO 5500 HD	All Models with Taperleaf Front	
F 19-23	SILVERADO 6500 HD	All Models with Taperleaf Front	
F 24	INTERNATIONAL	CV515	
F 19-22	CV515	All Models with Taperleaf Front	
83398	W		
R 19-22	CHEVROLET	SILVERADO 4500 HD All Models with 11K, 13.5K or 15.5K VARI-RATE Rear Suspension	
R 19-23	SILVERADO 5500 HD	All Models with 11K, 13.5K or 15.5K VARI-RATE Rear Suspension	
R 19-23	SILVERADO 6500 HD	All Models with 11K, 13.5K or 15.5K VARI-RATE Rear Suspension	
R 24	INTERNATIONAL	CV515	
R 19-22	CV515	All Models with 11K, 13.5K or 15.5K VARI-RATE Rear Suspension	
83456	D		142998 (2)
F	INTERNATIONAL SERIES 4000 - SHORT CONVENTIONAL MEDIUM TRK & TRAC		
F 90-02	SERIES 4000 - SHORT	CONVENTIONAL MEDIUM TRK & TRAC	
F 86-88	MITSUBISHI FUSO	FM All Models with O.E.M. Number	
83515	W		140885 (1)
F 16-23	CHEVROLET	LCF 3500 All	
F 18	LCF 3500HD		
F 16-17	LCF 3500HD	All	
F 19-22	SILVERADO 4500 HD	All Diesel Low Cab Forward models with 14,500 lb GVWR	
F 19-22	SILVERADO 4500 HD	All Diesel Low Cab Forward models with 16,000 lb to 19,500 lb GVWR	

Numerical listing

Shock	POP	Alternative No.	MTG Acc. Supplied
Pos.	Year	Application	
83515	W	(cont)	140885 (1)
F 19-22	SILVERADO 5500 HD	All Diesel Low Cab Forward models with 14,500 lb GVWR	
F 19-22	SILVERADO 5500 HD	All Diesel Low Cab Forward models with 16,000 lb to 19,500 lb GVWR	
F 87-10	W4500 TILTMMASTER	All Models with 11000 lb & 13000 lb Suspension	
F 88-10	W5500 TILTMMASTER	All Models with 11000 lb & 13000 lb Suspension	
F 87-96	W6500 TILTMMASTER	All Models with 11000 lb & 13000 lb Suspension	
F 92-10	GMC	W4500 FORWARD All Models with 11000 lb & 13000 lb Suspension	
F 88-10	W5500 FORWARD	All Models with 11000 lb & 13000 lb Suspension	
F 87-96	W6500 FORWARD	All Models with 11000 lb & 13000 lb Suspension	
F	W - SERIES (ISUZU)		
F 85	ISUZU	ADDITIONAL APPLICATIONS ALL MODELS WITH	
F 86	FSR		
F 87-92	FSR	All FSR Models	
F 05-09	FTR	All Models with O.E.M. Number	
F 84-85	NPR		
F 86-20	NPR	All Models with O.E.M. Number	
F 99-23	NPR-HD	All Models with O.E.M. Number	
F 23	NPR-XD		
F 15-22	NPR-XD	All Models with 14,000 to 15,000 lb GVW	
F 15-22	NPR-XD	All Models with 15,000 to 16,000 lb GVW	
F 94-23	NQR	All Models with O.E.M. Number	
F 05-23	NRR	All Models with O.E.M. Number	
F 88-94	NRR	All Models with O.E.M. Number	
F 11-15	REACH	All Models with O.E.M. Number	
F 99-04	UD	1200 All Models with O.E.M. Number	
F 05-07	1300	All Models with O.E.M. Number	
F 94-10	1400	All Models with O.E.M. Number	
83518	W		141041 (1)/TR0027 (2)
F 13-20	HINO	155 All Models with O.E.M. Number	
F 21	195		
F 12-20	195	All Models with O.E.M. Number	
83519	W		401011 (4)
R 13-20	HINO	155 All Models with O.E.M. Number	
R 21	195		
R 12-20	195	All Models with O.E.M. Number	
83613	W		141083 (2)
R 87-96	ISUZU	FSR All FSR Models	
R 88-96	FTR	All Models with O.E.M. Number	
R 94-96	FVR	All Models with O.E.M. Number	
R 88-92	FVR	All Models with O.E.M. Number	

Cab Shock

Shock	POP	Alternative No.	MTG Acc. Supplied
Pos.	Year	Application	
83006	W		
95-05	FREIGHTLINER	FL50 All Day Cab Suspensions with O.E.M. Number	
96-05	FL60	All Day Cab Suspensions with O.E.M. Number	
83021	C		
90-96	CHEVROLET	C60 KODIAK All Truck Cabs with Link Cabmate Model GMC104TK	
03-09	C4500 KODIAK	All Truck Cabs with Link Cabmate Model GMC104TK	
03-09	C5500 KODIAK	All Truck Cabs with Link Cabmate Model GMC104TK	
90-91	C5500 KODIAK	All Truck Cabs with Link Cabmate Model GMC104TK	
97-09	C6500 KODIAK	All Truck Cabs with Link Cabmate Model GMC104TK	
00-01	C7500 KODIAK	All Truck Cabs with Link Cabmate Model GMC104TK	

Numerical listing

Shock	POP	Alternative No.	MTG Acc. Supplied
Pos.	Year	Application	
83021	C	(cont)	
91-05	F	FREIGHTLINER FL60 All Trucks with Link Cabmate Models FRT153BC-A , FRT106BC or FRT106HD-A	
03-09	F	GMC C4500 TOPKICK All Truck Cabs with Link Cabmate Model GMC104TK	
03-09	F	C5500 TOPKICK All Truck Cabs with Link Cabmate Model GMC104TK	
90-96	F	C6000 TOPKICK All Truck Cabs with Link Cabmate Model GMC104TK	
03-09	F	C6500 TOPKICK All Truck Cabs with Link Cabmate Model GMC104TK	
97-01	F	C6500 TOPKICK All Truck Cabs with Link Cabmate Model GMC104TK	
90-96	F	C7000 TOPKICK All Truck Cabs with Link Cabmate Model GMC104TK	
97-09	F	C7500 TOPKICK All Truck Cabs with Link Cabmate Model GMC104TK	
96-97	F	MARMON HERRINGTON 57 GLIDER All Conventional Tractors with Link Cabmate Model MARC57-B	
90-94	F	57 GLIDER All Conventional Tractors with Link Cabmate Model MARC57-B	
83025	C		
03-09	F	GMC C4500 TOPKICK All Models with Link Cabmate Model GMT560	
03-09	F	C5500 TOPKICK All Models with Link Cabmate Model GMT560	
83038	A		
03-22	F	PIERCE MFG. INC. VARIOUS	
83039	W		
03-24	F	PIERCE MFG. INC. VARIOUS	
83040	W		
02-24	F	FREIGHTLINER M2 106 All Day Cab Models with Spring Suspensions	
02-24	F	PIERCE MFG. INC. VARIOUS	
83054	W		
02-20	F	INTERNATIONAL 4300 All Models with O.E.M. Number	
11-18	F	4300LP All Models with O.E.M. Number	
08-09	F	4300LP All Models with O.E.M. Number	
02-19	F	4400 All Models with O.E.M. Number	
19	F	4400LP All Models with O.E.M. Number	
11	F	4400LP All Models with O.E.M. Number	
03-09	F	4400LP All Models with O.E.M. Number	
15-20	F	DURASTAR All Models with O.E.M. Number	
13	F	DURASTAR All Models with O.E.M. Number	
19-23	F	PIERCE MFG. INC. VARIOUS	
83066	W		
23	F	MACK MD6	
24	F	MD6 All Models with O.E.M. Number	
21-22	F	MD6 All Models with O.E.M. Number	
85000 Series			
85000	A		
R	F	THOMAS VARIOUS	
85001	B	401754 (4)	
F	F	93-05 KENWORTH K300 All Models with Taper Leaf Springs on Front Axle (1" Mounting bolts)	
F	F	T300	
85005	C		
F	F	60-68 CHEVROLET 4, 40, 4000 & 4500 SERIES	
F	F	63-69 5, 50, 5000 & 5500 SERIES	
R	F	08-23 FORD F-53	

Cab Shock, 85000 Series

Shock	POP	Alternative No.	MTG Acc. Supplied
Pos.	Year	Application	
85005	C	(cont)	
R	F	20-24 FOREST RIVER GEORGETOWN GT7 All MotorHomes with Ford F53 Chassis with 24,000 lb GVW to 26,000 lb GVW	
F	F	FREIGHTLINER BUS CHASSIS VARIOUS	
F	F	63-66 GMC 3500 & 4000 SERIES	
F	F	63-68 5000 SERIES	
F	F	63-68 5500 SERIES	
R	F	20-23 HOLIDAY RAMBLER INVICTA All MotorHomes with Ford F53 Chassis with 24,000 lb GVW to 26,000 lb GVW	
R	F	11-23 VACATIONER All MotorHomes with Ford F53 Chassis with 24,000 lb GVW to 26,000 lb GVW	
R	F	09 VACATIONER All MotorHomes with Ford F53 Chassis with 24,000 lb GVW to 26,000 lb GVW	
R	F	11-23 THOR MOTOR COACH OUTLAW All MotorHomes with Ford F53 Chassis with 24,000 lb GVW to 26,000 lb GVW	
R	F	19-23 WINNEBAGO ADVENTURER All MotorHomes with Ford F53 Chassis with 24,000 lb GVW to 26,000 lb GVW	
R	F	08-17 ADVENTURER All MotorHomes with Ford F53 Chassis with 24,000 lb GVW to 26,000 lb GVW	
R	F	16-22 SUNSTAR All MotorHomes with Ford F53 Chassis with 24,000 lb GVW to 26,000 lb GVW	
R	F	08-22 VISTA All MotorHomes with Ford F53 Chassis with 24,000 lb GVW to 26,000 lb GVW	
85006	B		
F	F	08-23 FORD F-53	
F	F	24 F-53 MOTORHOME CHASSIS	
F	F	24 F-59 COMMERCIAL STRIPPED CHASSIS	
F	F	11-23 F-59 COMMERCIAL STRIPPED CHASSIS All MotorHomes with Ford F59 Commercial Chassis with 24,000 lb GVW to 26,000 lb GVW	
F	F	20-24 FOREST RIVER GEORGETOWN GT7 All MotorHomes with Ford F53 Chassis with 24,000 lb GVW to 26,000 lb GVW	
F	F	FREIGHTLINER BUS CHASSIS	
F	F	97-08 BUS CHASSIS	
F	F	99-04 FC70 All Models with 10,000 to 18,000 lb Suspension	
F	F	95-05 FL50 All Models with 10,000 to 18,000 lb Suspension	
F	F	91-05 FL60 All Models with 10,000 to 18,000 lb Suspension	
F	F	20-24 HOLIDAY RAMBLER INVICTA All MotorHomes with Ford F53 Chassis with 24,000 lb GVW to 26,000 lb GVW	
F	F	11-24 VACATIONER All MotorHomes with Ford F53 Chassis with 24,000 lb GVW to 26,000 lb GVW	
F	F	09 VACATIONER All MotorHomes with Ford F53 Chassis with 24,000 lb GVW to 26,000 lb GVW	
F	F	STERLING TRUCK ACTERRA	
R	F	THOMAS VARIOUS	
F	F	03 VARIOUS	
F	F	11-24 THOR MOTOR COACH OUTLAW All MotorHomes with Ford F53 Chassis with 24,000 lb GVW to 26,000 lb GVW	
F	F	19-24 WINNEBAGO ADVENTURER All MotorHomes with Ford F53 Chassis with 24,000 lb GVW to 26,000 lb GVW	
F	F	08-17 ADVENTURER All MotorHomes with Ford F53 Chassis with 24,000 lb GVW to 26,000 lb GVW	
F	F	16-24 SUNSTAR All MotorHomes with Ford F53 Chassis with 24,000 lb GVW to 26,000 lb GVW	
F	F	08-24 VISTA All MotorHomes with Ford F53 Chassis with 24,000 lb GVW to 26,000 lb GVW	
85007	W	401754 (4)	
F	F	93-05 KENWORTH K300 All K300 COE Medium Duty	

Numerical listing

Shock	POP	Alternative No.	MTG Acc. Supplied
Pos.	Year	Application	
85009	W	145054 (1)	
F	F	91-94 MITSUBISHI FUSO FK All FK457 Models with O.E.M. Number	
F	F	88-91 FK All FK455 Models with O.E.M. Number	
F	F	88 FM All FM555 Models with O.E.M. Number	
85010	W		
R	F	11-20 FORD F-53	
R	F	11-21 F-59 COMMERCIAL STRIPPED CHASSIS All F59 Commercial Chassis with 16,000 lb or 19,500 GVW	
R	F	89-97 F-59 COMMERCIAL STRIPPED CHASSIS All F59 Commercial Chassis with 16,000 lb or 19,500 GVW	
F	F	00-01 HOLIDAY RAMBLER ADMIRAL All Models with Workhorse W22 Chassis with 8.1L Gas V8	
F	F	00-03 ENDEAVOR All Models with Workhorse W22 Chassis with 8.1L Gas V8	
F	F	00-03 VACATIONER All Models with Workhorse W22 Chassis with 8.1L Gas V8	
F	F	00-03 MONACO COACH CLASS A MOTORHOMES	
85012	B	145080 (2)	
F	F	INTERNATIONAL BINDER	
R	F	CARGOSTAR	
R	F	85 ISUZU ADDITIONAL APPLICATIONS	
R	F	86-95 NPR All	
F	F	13 PETERBILT 220 All Models with 12,000 lb Front Axle	
F	F	10 220 All Models with 12,000 lb Front Axle	
F	F	07 220 All Models with 12,000 lb Front Axle	
F	F	08-19 325 All Models with 12000 lb Set Back Front Axle	
F	F	05-10 335 All Models with 12000 lb Set Back Front Axle	
85013	C		
F	F	11-20 FORD F-53	
F	F	11-21 F-59 COMMERCIAL STRIPPED CHASSIS All F59 Commercial Chassis with 16,000 lb to 22,000 GVW	
F	F	89-97 F-59 COMMERCIAL STRIPPED CHASSIS All F59 Commercial Chassis with 16,000 lb to 22,000 GVW	
R	F	13-22 PETERBILT 220 All Models with Reyco 102AR (Standard) Rear Air Suspension	
R	F	10 220 All Models with Reyco 102AR (Standard) Rear Air Suspension	
R	F	07 220 All Models with Reyco 102AR (Standard) Rear Air Suspension	
85014	D		
F	F	THOMAS VARIOUS	
85029	B		
R	F	06 COACHMEN CROSS COUNTRY	
R	F	03-05 CROSS COUNTRY ELITE	
R	F	03-05 CROSS COUNTRY SE	
F	F	00-10 COUNTRY COACH AFFINITY All MotorHomes with Neway IFS	
R	F	02-04 FOREST RIVER REFLECTION	
R	F	02-06 TSUNAMI	
R	F	03-12 FREIGHTLINER VC CHASSIS	
R	F	03-12 XC CHASSIS	
R	F	03-06 GULF STREAM ATRIUM	
R	F	02-06 FRIENDSHIP	
R	F	02 INDEPENDENCE All MotorHomes with Freightliner XC Chassis and ADL200 Suspension w/ 20K Rear	
R	F	02-06 SCENIC CRUISER	
R	F	02-04 YELLOWSTONE	
R	F	95-03 HOLIDAY RAMBLER CLASS A MOTORHOMES	
R	F	02-06 ITASCA CLASS A MOTORHOMES	
R	F	04-06 KING OF THE ROAD CLASS A MOTORHOMES	
R	F	04-06 MANDALAY COACH CLASS A MOTORHOMES	
R	F	95-99 MONACO COACH VARIOUS	
R	F	02-06 NEWMAR CLASS A MOTORHOMES	
R	F	97-00 SPARTAN MOTORS VARIOUS	

Numerical listing

Shock	POP	Alternative No.	MTG Acc. Supplied
Pos.	Year	Application	
85029	B (cont)		
R	02-06	THOR MOTOR COACH CLASS A MOTORHOMES	
R	02-06	WINNEBAGO JOURNEY All MotorHomes with Freightliner XC Chassis and ADL200 Suspension w/ 20K Rear	
R	06	TOUR All MotorHomes with Freightliner XC Chassis and ADL200 Suspension w/ 20K Rear	
R	06	VECTRA All MotorHomes with Freightliner XC Chassis and ADL200 Suspension w/ 20K Rear	
85030	C		
R	91-96	SPARTAN MOTORS K2	
85031	D	145147(1)/TR0027(2)	
F	93-05	KENWORTH K300 All Models with 12,000 lb Taper Leaf Front Springs (5/8" Top Mounting bolt)	
F	08-13	T170 All Models with 8,000 lb Taper Leaf Front Springs	
F	08-10	T270 All Models with 12,000 lb Front Axle	
F	00-08	T300 All Models with 12,000 lb Taper Leaf Front Springs (5/8" Top Mounting bolt)	
85036	D		
R		SPARTAN MOTORS VARIOUS	
R		XOS ADDITIONAL O.E.M. INTERCHANGES	
85043	W		
F		FREIGHTLINER BUS CHASSIS	
F	99-04	FC70 All Models with 6000 to 9000 lb Front axle	
F	95-05	FL50 All Models with 6000 to 9000 lb Front axle	
F	91-05	FL60 All Models with 6000 to 9000 lb Front axle	
F	00-02	XCS CHASSIS	
85058	C		
F		FREIGHTLINER MB CHASSIS	
F	98-23	MT45 All Step Van Models with O.E.M. Number	
F		MT55	
F		VARIOUS	
F		THOMAS VARIOUS	
85069	A	145089-000 (2)	
R	24	KENWORTH T270	
R	20-23	T270 All Models with Air Glide 400L (AG400L) Rear Air Suspension	
R	08-23	T270 All Models with AG210L Rear Air Suspension	
R	05-10	PETERBILT 335 All Models with Peterbilt Low Air Leaf Suspension	
R	22-24	536 All Models with Peterbilt Low Air Leaf Suspension	
85071	W	145054 (2)	
R	90-07	CHEVROLET B6	
R	90-96	C60 KODIAK All Conventional Cab w/15000, 19000, 21000 lb Multileaf Springs	
R	90-02	C4500 KODIAK	
R	03-09	C4500 KODIAK All C Chassis - Conventional Cab With 15000, 19000, 21000 lb Multileaf Springs	
R	92-02	C5500 KODIAK	
R	03-09	C5500 KODIAK All C Chassis - Conventional Cab With 15000, 19000, 21000 lb Multileaf Springs	
R	90-91	C5500 KODIAK All C Chassis - Conventional Cab With 15000, 19000, 21000 lb Multileaf Springs	
R	97-09	C6500 KODIAK All Conventional Cab w/15000, 19000, 21000 lb Multileaf Springs	
R	00-01	C7500 KODIAK All Conventional Cab w/15000, 19000, 21000 lb Multileaf Springs	
R	90-06	T5500	
R	03	T6500	
R	90-96	T6500	
R	04-06	T6500 All Tilt Cab w/15000, 19000, 21000 lb Multileaf Springs	
R	97-02	T6500 All Tilt Cab w/15000, 19000, 21000 lb Multileaf Springs	
R	90-02	GMC C4500 TOPKICK	
R	03-09	C4500 TOPKICK All C Chassis - Conventional Cab with 15000, 19000, 21000 lb Multileaf Springs	

85000 Series

Shock	POP	Alternative No.	MTG Acc. Supplied
Pos.	Year	Application	
85071	W (cont)		145054 (2)
R	90-02	C5500 TOPKICK	
R	03-09	C5500 TOPKICK All C Chassis - Conventional Cab with 15000, 19000, 21000 lb Multileaf Springs	
R	90-06	T5500	
R	03	T6500	
R	90-96	T6500	
R	04-06	T6500 All Tilt Cab with 15000, 19000, 21000 lb Multileaf Springs	
R	97-02	T6500 All Tilt Cab with 15000, 19000, 21000 lb Multileaf Springs	
R	97-02	ISUZU FSR All Models with 15000, 19000, 21000 lb Multileaf Springs	
F	18-20	FTR All FTR Diesel Models with Std Cab	
R	90-09	FTR All Models with 15000, 19000, 21000 lb Multileaf Springs	
R	94-08	FVR All Models with 15000, 19000, 21000 lb Multileaf Springs	
R	90-92	FVR All Models with 15000, 19000, 21000 lb Multileaf Springs	
85072	C		
R	08-22	KENWORTH T270 All Models with Hendrickson Primaax 230, 232, 460, 462, 690 and 692 Air Suspension (8-1/2" to 10" Ride Height)	
R	19-23	PIERCE MFG. INC. VARIOUS	
85082	W		
R	16-17	IC CORPORATION CE SCHOOL BUS All CE Model School Buses with 20,000 lb Rear Air Suspension	
85084	C		
F	10-14	KENWORTH T270 All Models with 10,000 lb to 12,000 lb Front Axle	
F	10-14	T270 All Models with 13,200 lb to 14,600 lb Front Axle	
F	10-14	T270 All Models with 8,000 lb Front Axle	
F	08-15	PETERBILT 325 All Models with 8,000 lb Front Axle	
85106	W		
F	21-22	LION LION6 All Trucks with Hendrickson Softek Suspension (12,500 lb Capacity)	
85124	W	145054 (2)	
R	04-11	DAMON CLASS A MOTORHOMES	
R	04-11	FLEETWOOD CLASS A MOTORHOMES	
R	04-11	HOLIDAY RAMBLER CLASS A MOTORHOMES	
R	04-11	ITASCA CLASS A MOTORHOMES	
R	04-08	NATIONAL RV CLASS A MOTORHOMES	
R	04-09	WINNEBAGO ADVENTURER All Models with Workhorse W22, & W24 MotorHome Chassis with O.E.M. Number	
R	04-09	WORKHORSE W20 All Models with O.E.M. Number	
R	04-09	W22 All Models with O.E.M. Number	
R	04-09	W24 All Models with O.E.M. Number	
85125	W		
F	98-11	DAMON CLASS A MOTORHOMES	
F	98-11	HOLIDAY RAMBLER CLASS A MOTORHOMES	
F	98-11	ITASCA CLASS A MOTORHOMES	
F	98-11	MONACO COACH CLASS A MOTORHOMES	
F	98-08	NATIONAL RV CLASS A MOTORHOMES	
F	98-11	WINNEBAGO ADVENTURER All Models with W20 & W22 Workhorse Motorhome Chassis	
F	01-09	WORKHORSE W20 All	
F	01-09	W22 All	
F	04-09	W24 All MotorHome Chassis with O.E.M. Number	
85180	W		
R	15-23	GLAVAL BUS CO. CONCORDE II - SERIES	
R	15-23	STARCRAFT BUS CO. ALLSTAR XL & XLT - SERIES	
85181	W		
F	15-23	GLAVAL BUS CO. CONCORDE II - SERIES	

Numerical listing

Shock	POP	Alternative No.	MTG Acc. Supplied
Pos.	Year	Application	
85181	W (cont)		
F	15-23	STARCRAFT BUS CO. ALLSTAR XL & XLT - SERIES	
85182	W	145089-200 (2)	
F	13-24	KENWORTH K270 All Models with 10,000 lb to 12,000 lb Front Axle	
F	13-24	PETERBILT 220 All Models with 12,000 lb Front Axle	
85188	D		
R	23	MACK MD6	
R	24	MD6 All Models with O.E.M. Number	
R	21-22	MD6 All Models with O.E.M. Number	
85301	W	401754 (4)	
F	66-77	FORD W AND WT SERIES - HI TILT CAB HIGHWAY TRACTOR	
85304	W	401754 (4)	
F	66-71	FORD W AND WT SERIES - HI TILT CAB HIGHWAY TRACTOR THOMAS VARIOUS	
85307	W	401754 (4)	
F	60-68	GMC 5500 SERIES	
F	60-68	6000 SERIES	
F		SPARTAN MOTORS VARIOUS	
R		THOMAS VARIOUS	
85310	B	141108 (1)	
R	93-05	KENWORTH K300 All All with Air Glide 100 Suspension with 8 air bags, 4 units required T300	
85311	A	141247 (1)	
R	05-10	PETERBILT 335 All Models with Air Trac Suspension (46,000 lb)	
85329	W	401754 (4)	
F		EMERGENCY ONE VARIOUS	
85331	C		
R	05-15	FREIGHTLINER M2 All Models with Freightliner Low Profile Rear Air Suspension (18,000 to 40,000 lb)	
R	02-10	M2 100 All Models with Freightliner Low Profile Rear Air Suspension (18,000 to 40,000 lb)	
R	02-15	M2 106 All Models with Freightliner Low Profile Rear Air Suspension (18,000 to 40,000 lb)	
R	99-24	MT55 All Models with Freightliner Low Profile Rear Air Suspension	
85335	W		
R	05-21	FREIGHTLINER M2 All Models with Rear 10000 lb - 15000 lb Low Profile AirLiner	
R	02-10	M2 100 All Models with Rear 10000 lb - 15000 lb Low Profile AirLiner	
R	02-23	M2 106 All Models with Rear 10000 lb - 15000 lb Low Profile AirLiner	
85642	A		
R	19-22	INTERNATIONAL MV607 All Models with International 21,000 lb Rear Air Suspension	
85649	W	143146 (1)	
F	12-18	RAM 4500 All Models with O.E.M. Number	
F	12-18	5500 All Models with O.E.M. Number	
F	08-10	STERLING TRUCK BULLET 45 All Models with O.E.M. Number	
F	08-10	BULLET 55 All Models with O.E.M. Number	
85650	W		
R	12-18	RAM 4500 All Models with O.E.M. Number	
R	12-18	5500 All Models with O.E.M. Number	
R	08-10	STERLING TRUCK BULLET 45 All Models with O.E.M. Number	
R	08-10	BULLET 55 All Models with O.E.M. Number	
85656	C		
R	14	FORD F-650	
R	04-15	GLAVAL BUS CO. CONCORDE II - SERIES	

Numerical listing

Shock	POP	Alternative No.	MTG Acc. Supplied
Pos.	Year	Application	
85656	C	(cont)	
R	10-23	IC CORPORATION CE SCHOOL BUS All CE Model School Buses with 20,000 lb International IROS Air Suspension	
R	16-19	INTERNATIONAL DURASTAR All Models with 20,000 lb International IROS Air Suspension	
R		DURASTAR - 4300, 4400 SERIES	
R	16-19	DURASTAR - 4300, 4400 SERIES	
R	20-22	MV607 All Models with 20,000 lb International IROS Air Suspension	
R	20	MV All Models with 20,000 lb International IROS Air Suspension	
R	20-22	PIERCE MFG. INC. VARIOUS	
R	15	STARCRAFT BUS CO. ALLSTAR XL & XLT - SERIES	
85670	W		
R	19-22	CHEVROLET SILVERADO 4500 HD All Models with IROS Rear	
R	19-22	SILVERADO 5500 HD All Models with IROS Rear	
R	19-22	SILVERADO 6500 HD All Models with IROS Rear	
R	19-22	INTERNATIONAL CV515 All Models with IROS Rear	
85702	W	401754 (4)	
R		SPARTAN MOTORS VARIOUS	
85712	C	401754 (4)	
F	00-10	COUNTRY COACH AFFINITY All MotorHomes with Ridewell Front Suspension	
F		SPARTAN MOTORS VARIOUS	
F	86	VARIOUS	
85723	W	145075 (1)	
F	00-10	COUNTRY COACH AFFINITY All MotorHomes with Gillig Chassis w/ Neway I-beam front	
85724	A		
R	13-24	DYNAMAX CORP DX3 All Models with Airliner 21,000 lb Rear Air Suspension	
R	05-07	DYNAQUEST All Models with Airliner 18,000 lb Rear Air Suspension	
R	09-14	DYNAQUEST ST All Models with Airliner 18,000 lb Rear Air Suspension	
R	09-24	DYNAQUEST XL All Models with FAS II (40,000 lb) Rear Air Suspension	
R	21-24	EUROPA All Models with Airliner 21,000 lb Rear Air Suspension	
R	22	FORCE HD All Models with Airliner 21,000 lb Rear Air Suspension	
R	15-18	FORCE HD All Models with Airliner 21,000 lb Rear Air Suspension	
R	02-04	GRAND SPORT All Models 23,000 lb Airliner Rear Air Suspension	
R	09-14	GRAND SPORT GT All Models with Freightliner Airliner Rear Air Suspension	
R	07-13	GRAND SPORT GT TOY HAULER All Models 21K or 23K Airliner Rear Air Suspension	
R	03-07	GRAND SPORT M2 All Models with Airliner 21,000 lb Rear Air Suspension	
R	07-14	GRAND SPORT ULTRA All Models 23,000 lb Airliner Rear Air Suspension	
R	20-24	ENTEGR COACH ACCOLADE All Models with Freightliner S2RV chassis	
R	21-24	ACCOLADE XL All Models with Freightliner S2RV chassis	
R	02-19	FEDERAL COACH VARIOUS	
R	05-23	FREIGHTLINER B2 All Models with FAS II (40,000 lb) Rear Air Suspension	
R	99-04	FC70 All Models with FAS II (40,000 lb) Rear Air Suspension	
R	95-05	FL50 All Models with FAS II (40,000 lb) Rear Air Suspension	
R	91-05	FL60 All Models with FAS II (40,000 lb) Rear Air Suspension	
R	05-21	M2 All Models with FAS II (40,000 lb) Rear Air Suspension	
R	02-10	M2 100 All Models with FAS II (40,000 lb) Rear Air Suspension	

85000 Series

Shock	POP	Alternative No.	MTG Acc. Supplied
Pos.	Year	Application	
85724	A	(cont)	
R	02-24	M2 106 All Models with FAS II (40,000 lb) Rear Air Suspension	
R	18-24	JAYCO SENECA All Models with Freightliner S2RV chassis	
R	21-23	SENECA PRESTIGE All Models with Freightliner S2RV chassis	
R	18-24	RENEGADE VALENCIA All Models with Freightliner S2RV chassis	
R	03-10	STERLING TRUCK ACTERRA All Models with FAS II (40,000 lb) Rear Air Suspension	
R	01-07	ACTERRA 5500 All Models with FAS II (40,000 lb) Rear Air Suspension	
R	01-07	ACTERRA 6500 All Models with FAS II (40,000 lb) Rear Air Suspension	
R	01-07	ACTERRA 7500 All Models with FAS II (40,000 lb) Rear Air Suspension	
R	03	ACTERRA 8500 All Models with FAS II (40,000 lb) Rear Air Suspension	
R	01	ACTERRA 8500 All Models with FAS II (40,000 lb) Rear Air Suspension	
R		THOMAS VARIOUS	
R	22-24	THOR MOTOR COACH INCEPTION All Models with Freightliner S2RV chassis	
R	22-24	PASADENA All Models with Freightliner S2RV chassis	
85734	W	401754 (4)	
R	00-10	COUNTRY COACH AFFINITY All MotorHomes with Ridewell Rear Suspension	
R		INTERNATIONAL CARGOSTAR	
85736	W	401754 (4)	
F		THOMAS VARIOUS	
85900	B	145054 (2)	
F	06	COACHMEN CROSS COUNTRY	
F	03-05	CROSS COUNTRY ELITE	
F	03-05	CROSS COUNTRY SE	
F	02-04	FOREST RIVER REFLECTION	
F	02-06	TSUNAMI	
F	03-07	FREIGHTLINER VC CHASSIS	
F		XC CHASSIS	
F	03-07	XC CHASSIS	
F	03-06	GULF STREAM ATRIUM	
F	02-06	FRIENDSHIP	
F	02	INDEPENDENCE All Models with Freightliner XC Chassis with ZF - IFS Front Suspension and 23,000 lb GVW or Greater	
F	02-06	SCENIC CRUISER	
F	02-04	YELLOWSTONE	
F	02-06	ITASCA CLASS A MOTORHOMES	
R	93-05	KENWORTH K300 All All with Air Glide 200 with 40,000 lb Suspension with 8 air bags, 4 units required T300	
R	04-06	KING OF THE ROAD CLASS A MOTORHOMES	
F	04-06	MANDALAY COACH CLASS A MOTORHOMES	
F	02-06	NEWMAR CLASS A MOTORHOMES	
F	02-06	THOR MOTOR COACH CLASS A MOTORHOMES	
85902	W	145054 (2)	
R	93-05	KENWORTH K300 All All with Air Glide 200 with 46,000 lb Suspension with 8 air bags, 4 units required	
R	00-08	T300 All All with Air Glide 200 with 46,000 lb Suspension with 8 air bags, 4 units required	
85909	D		
R		NEWMAR CLASS A MOTORHOMES	
F	95-96	SPARTAN MOTORS K2	
85910	W		
R		FREIGHTLINER VARIOUS	
F		PETERBILT 330	
F	00-12	SPARTAN MOTORS CLASS A MOTORHOMES	

Numerical listing

Shock	POP	Alternative No.	MTG Acc. Supplied
Pos.	Year	Application	
85918	A		
F	02-04	DYNAMAX CORP GRAND SPORT All Models with 12000 lb Taperleaf Front Suspension	
F	07-08	GRAND SPORT GT TOY HAULER All 410TH & 450TH Models with 12000 lb Taperleaf Front Suspension	
F	07-08	GRAND SPORT ULTRA All Models with 14,000 lb Taperleaf Front Suspension	
F	20-24	ENTEGR COACH ACCOLADE All Models with Freightliner S2RV chassis	
F	21-24	ACCOLADE XL All Models with Freightliner S2RV chassis	
F	05-23	FREIGHTLINER B2 All Models with 12000 lb Taperleaf Front Suspension MC CHASSIS	
F	18-24	JAYCO SENECA All Models with Freightliner S2RV chassis	
F	21-24	SENECA PRESTIGE All Models with Freightliner S2RV chassis	
F	18-24	RENEGADE VALENCIA All Models with Freightliner S2RV chassis	
F	22-24	THOR MOTOR COACH INCEPTION All Models with Freightliner S2RV chassis	
F	22-24	PASADENA All Models with Freightliner S2RV chassis	
85919	A		
R		FREIGHTLINER MB CHASSIS	
F	99-24	MT55 All MT55 Chassis with O.E.M. Number	
R		WORKHORSE VARIOUS	
85920	B		
F	05-07	DYNAMAX CORP DYNAQUEST All Models with 10000 to 12000 lb. Taper-leaf Spring Suspension	
F	07-08	GRAND SPORT GT TOY HAULER All 390TH Models with 12000 lb Taperleaf Front Suspension	
F	03-07	GRAND SPORT M2 All Models with 10000 to 12000 lb. Taper-leaf Spring Suspension	
F	02-08	FEDERAL COACH VARIOUS	
F	02-08	FREIGHTLINER M2 106 All Models with 10000 to 12000 lb. Taper-leaf Spring Suspension	
F	02-08	M2 106 All Models with 6000 to 9000 lb Front axle	
F	01-09	STERLING TRUCK ACTERRA	
85921	W	145054 (1)	
R	05-21	FREIGHTLINER M2 All Models with Rear 60" Spring ,18000 lb - 23000 lb	
R	02-10	M2 100 All Models with Rear 60" Spring ,18000 lb - 23000 lb	
R	02-23	M2 106 All Models with Rear 60" Spring ,18000 lb - 23000 lb	
85923	D		
R	08-09	INTERNATIONAL 4300 All Models with International 40,000 lb Rear Air Suspension	
R	08-09	4400 All Models with International 40,000 lb Rear Air Suspension	
R		DURASTAR - 4300, 4400 SERIES	
R	10-11	DURASTAR - 4300, 4400 SERIES	
85927	W		
R	14	FORD F-650	
R		INTERNATIONAL DURASTAR - 4300, 4400 SERIES	
85928	C		
F	14	FORD F-650	
F	00-15	GLAVAL BUS CO. CONCORDE II - SERIES	
F	16-20	INTERNATIONAL DURASTAR All Models with 11,000 lb to 14,000 lb Front axle	
F	16-20	DURASTAR - 4300, 4400 SERIES	
F	23	EMV607	
F	19-22	MV607 All Models with 11,000 lb to 14,000 lb Taper-leaf Springs	
F	19-23	PIERCE MFG. INC. VARIOUS	
F	00-15	STARCRAFT BUS CO. ALLSTAR XL & XLT - SERIES	
85932	C		
F	03-10	STERLING TRUCK ACTERRA All Models with Hendrickson Front Airtek	

Numerical listing

Shock	POP	Alternative No.	MTG Acc. Supplied
Pos.	Year	Application	
85932 C (cont)			
F	01-07	ACTERRA 5500	All Models with Hendrickson Front Airtek
F	01-07	ACTERRA 6500	All Models with Hendrickson Front Airtek
F	01-07	ACTERRA 7500	All Models with Hendrickson Front Airtek
F	03	ACTERRA 8500	All Models with Hendrickson Front Airtek
F	01	ACTERRA 8500	All Models with Hendrickson Front Airtek
85956 C			
R	05-21	FREIGHTLINER M2	All Models with Freightliner TufTrac Rear Air Suspension
R	02-10	M2 100	All Models with Freightliner TufTrac Rear Air Suspension
R	02-24	M2 106	All Models with Freightliner TufTrac Rear Air Suspension
R	03-10	STERLING TRUCK ACTERRA	All Models with Freightliner TufTrac Rear Air Suspension
85957 D			
F	02-15	INTERNATIONAL 4300	All Models with 12,000 lb Front axle
F	02-15	4400	All Models with 12,000 lb Front axle
F	15	DURASTAR	All Models with 12,000 lb Front axle
F	13	DURASTAR	All Models with 12,000 lb Front axle
F	10-15	DURASTAR - 4300, 4400 SERIES	
F	19-21	PIERCE MFG. INC.	VARIOUS
85958 A			
F	09-24	DYNAMAX CORP DYNAQUEST XL	All Models with 12000 lb to 20000 Front Axle
F	09-14	GRAND SPORT GT	All Models with 14,600 lb Taperleaf Front Suspension
F	09-13	GRAND SPORT GT TOY HAULER	All 410TH & 450TH Models with 12000 lb Taperleaf Front Suspension
F	09-14	GRAND SPORT ULTRA	All Models with 14,000 lb Taperleaf Front Suspension
F	09-24	PIERCE MFG. INC.	VARIOUS
85959 A			
F	13-24	DYNAMAX CORP DX3	All Models with 8000 to 16000 lb Front Axle and Taperleaf Spring
F	09-14	DYNAQUEST ST	All Models with 8000 to 16000 lb Front Axle and Taperleaf Spring
F	21-24	EUROPA	All Models with 8000 to 16000 lb Front Axle and Taperleaf Spring
F	19-21	FORCE HD	
F	22	FORCE HD	All Models with 8000 to 16000 lb Front Axle and Taperleaf Spring
F	15-18	FORCE HD	All Models with 8000 to 16000 lb Front Axle and Taperleaf Spring
F	09-13	GRAND SPORT GT TOY HAULER	All 390TH Models with 12000 lb Taperleaf Front Suspension
F	09-19	FEDERAL COACH	VARIOUS
F	09-24	FREIGHTLINER M2	
F	09-24	M2 106	All Models with 8000 to 16000 lb Front Axle and Taperleaf Spring
F		MC CHASSIS	
R		MC CHASSIS	
F	09-24	PIERCE MFG. INC.	VARIOUS
F		SPARTAN MOTORS	VARIOUS
F		XOS	ADDITIONAL O.E.M. INTERCHANGES
85962 W			
R		SPARTAN MOTORS	RV MODELS
85976 D			
R	14	FORD F-650	
R	02-20	INTERNATIONAL 4300	All Models with Hendrickson HAS - 230 or 460 Rear Air Suspension
R	02-19	4400	All Models with Hendrickson HAS - 230 or 460 Rear Air Suspension

85000 Series, 89000 Series

Shock	POP	Alternative No.	MTG Acc. Supplied
Pos.	Year	Application	
85976 D (cont)			
R	15-20	DURASTAR	All Models with Hendrickson HAS - 230 or 460 Rear Air Suspension
R	13	DURASTAR	All Models with Hendrickson HAS - 230 or 460 Rear Air Suspension
R	19-22	MV607	All Models with Hendrickson HAS - 230 or 460 Rear Air Suspension
R	20	MV	All Models with Hendrickson HAS - 230 or 460 Rear Air Suspension
R	19-22	PIERCE MFG. INC.	VARIOUS
85988 D 145099 (1)			
R	22-24	PETERBILT 536	All Models with Air Trac Suspension (40,000 lb)
85989 A			
F	15-22	KENWORTH T270	All Models with 10,000 lb to 14,600 lb Taperleaf Springs and Set Back Front Axles
F	15-22	T270	All Models with 16,000 lb to 20,000 lb Taperleaf Springs and Set Back Front Axles
F	24	T280	All Models with 10,000 lb to 12,000 lb Mono-leaf front springs
F	22-24	PETERBILT 536	All Models with 10,000 lb to 14,600 lb Taperleaf Springs and Set Back Front Axles
85995 W			
F	19-21	PIERCE MFG. INC.	VARIOUS
89000 Series			
89405 W			
R	13-24	KENWORTH K270	All Models with Hendrickson HAS - 210L or HAS - 230L Rear Air Suspension
R	93-05	K300	All Models with Hendrickson Rear Air Suspension
R	08-23	T270	All Models with Hendrickson HAS - 210L or HAS - 230L Rear Air Suspension
R	00-08	T300	All Models with Hendrickson HAS - 210L or HAS - 230L Rear Air Suspension
R	13-24	PETERBILT 220	All Models with Hendrickson HAS - 210L or HAS - 230L Rear Air Suspension
R	10	220	All Models with Hendrickson HAS - 210L or HAS - 230L Rear Air Suspension
R	07	220	All Models with Hendrickson HAS - 210L or HAS - 230L Rear Air Suspension
R		SPARTAN MOTORS	VARIOUS
R		XOS	ADDITIONAL O.E.M. INTERCHANGES
89406 W			
R	97-09	CHEVROLET C6500 KODIAK	All Models with Hendrickson Air Suspension (Stamping number 47902-13)
R	00-01	C7500 KODIAK	All Models with Hendrickson Air Suspension (Stamping number 47902-13)
R	99	T6500	All Models with Hendrickson Air Suspension (Stamping number 47902-13)
R	09	COACHMEN AURORA	
R	07	AURORA	
R	08	AURORA	All MotorHomes with Ford F53 Chassis with 16,000 lb GVW to 22,000 lb GVW
R	04-06	AURORA	All MotorHomes with Ford F53 Chassis with 16,000 lb GVW to 22,000 lb GVW
R	21-24	ENCORE	All MotorHomes with Ford F53 Chassis with 16,000 lb GVW to 22,000 lb GVW
R	11-16	ENCOUNTER	All MotorHomes with Ford F53 Chassis with 16,000 lb GVW to 22,000 lb GVW
R	99-07	MIRADA	
R	08-24	MIRADA	All MotorHomes with Ford F53 Chassis with 16,000 lb GVW to 22,000 lb GVW
R	04-12	PURSUIT	
R	13-24	PURSUIT	All MotorHomes with Ford F53 Chassis with 16,000 lb GVW to 22,000 lb GVW

Numerical listing

Shock	POP	Alternative No.	MTG Acc. Supplied
Pos.	Year	Application	
89406 W (cont)			
R	12-13	DAMON DAYBREAK	
R	99	DAYBREAK	
R	99	INTRUDER	
R	12-14	OUTLAW	
R	19-20	FLEETWOOD AXON	
R	06-23	FORD F-53	
R	99-04	F-53	
R	13-24	FOREST RIVER FR3	All MotorHomes with Ford F53 Chassis with 16,000 lb GVW to 22,000 lb GVW
R	08-17	GEORGETOWN	All MotorHomes with Ford F53 Chassis with 16,000 lb GVW to 22,000 lb GVW
R	16-24	GEORGETOWN GT3	All MotorHomes with Ford F53 Chassis with 16,000 lb GVW to 22,000 lb GVW
R	17-24	GEORGETOWN GT5	All MotorHomes with Ford F53 Chassis with 16,000 lb GVW to 22,000 lb GVW
R	20-24	GEORGETOWN GT7	All MotorHomes with Ford F53 Chassis with 16,000 lb GVW to 22,000 lb GVW
R	99-09	GEORGIE BOY MANUFACTURING CLASS A MOTORHOMES	
R	99	GMC T5500	
R	99	T6500	All Models with Hendrickson Air Suspension (Stamping number 47902-13)
R	11-15	HOLIDAY RAMBLER ADMIRAL	
R	02-06	ADMIRAL	
R	16-24	ADMIRAL	All MotorHomes with Ford F53 Chassis with 16,000 lb GVW to 22,000 lb GVW
R	07-10	ADMIRAL	All MotorHomes with Ford F53 Chassis with 16,000 lb GVW to 22,000 lb GVW
R	00-01	ADMIRAL	All MotorHomes with Ford F53 Chassis with 16,000 lb GVW to 22,000 lb GVW
R	02-06	ADMIRAL SE	All MotorHomes with Ford F53 Chassis with 16,000 lb GVW to 22,000 lb GVW
R	07	ADMIRAL SVE	All MotorHomes with Ford F53 Chassis with 16,000 lb GVW to 22,000 lb GVW
R	16-18	ADMIRAL XE	All MotorHomes with Ford F53 Chassis with 16,000 lb GVW to 22,000 lb GVW
R	23-24	ECLIPSE	All MotorHomes with Ford F53 Chassis with 16,000 lb GVW to 22,000 lb GVW
R	15	ENDEAVOR	
R	16-24	ENDEAVOR	All MotorHomes with Ford F53 Chassis with 16,000 lb GVW to 22,000 lb GVW
R	00-14	ENDEAVOR	All MotorHomes with Ford F53 Chassis with 16,000 lb GVW to 22,000 lb GVW
R	11-24	VACATIONER	All MotorHomes with Ford F53 Chassis with 16,000 lb GVW to 22,000 lb GVW
R	09	VACATIONER	All MotorHomes with Ford F53 Chassis with 16,000 lb GVW to 22,000 lb GVW
R	00-07	VACATIONER	All MotorHomes with Ford F53 Chassis with 16,000 lb GVW to 22,000 lb GVW
R		ISUZU FVR	
R	99-15	ITASCA CLASS A MOTORHOMES	
R	16-24	JAYCO ALANTE	All MotorHomes with Ford F53 Chassis with 16,000 lb GVW to 22,000 lb GVW
R	14-20	CLASS A MOTORHOMES	
R	14-24	PRECEPT	All MotorHomes with Ford F53 Chassis with 16,000 lb GVW to 22,000 lb GVW
R	99-08	NATIONAL RV CLASS A MOTORHOMES	
R	13-20	NEWMAR CLASS A MOTORHOMES	
R	16-20	NEXUS CLASS A MOTORHOMES	
R	17-20	MAYBACH	All MotorHomes with Ford F53 Chassis with 16,000 lb GVW to 22,000 lb GVW
R	11-24	THOR MOTOR COACH A.C.E.	All MotorHomes with Ford F53 Chassis with 16,000 lb GVW to 22,000 lb GVW
R	05-08	CHALLENGER	

Numerical listing

Shock	POP	Alternative No.	MTG Acc. Supplied
Pos.	Year	Application	
89406	W (cont)		
R	09-24	CHALLENGER	All MotorHomes with Ford F53 Chassis with 16,000 lb GVW to 22,000 lb GVW
R	04-10	HURRICANE	
R	11-24	HURRICANE	All MotorHomes with Ford F53 Chassis with 16,000 lb GVW to 22,000 lb GVW
R	23-24	INDIGO	All MotorHomes with Ford F53 Chassis with 16,000 lb GVW to 22,000 lb GVW
R	23-24	LUMINATE	All MotorHomes with Ford F53 Chassis with 16,000 lb GVW to 22,000 lb GVW
R	14-24	MIRAMAR	All MotorHomes with Ford F53 Chassis with 16,000 lb GVW to 22,000 lb GVW
R	07-10	OUTLAW	
R	11-23	OUTLAW	All MotorHomes with Ford F53 Chassis with 16,000 lb GVW to 22,000 lb GVW
R	23-24	RESONATE	All MotorHomes with Ford F53 Chassis with 16,000 lb GVW to 22,000 lb GVW
R	06-10	WINDSPORT	
R	11-24	WINDSPORT	All MotorHomes with Ford F53 Chassis with 16,000 lb GVW to 22,000 lb GVW
R	19-23	WINNEBAGO ADVENTURER	All Motorhomes with Ford F-53 Chassis with 16,000 lb GVW to 22,000 lb GVW
R	06-17	ADVENTURER	All Motorhomes with Ford F-53 Chassis with 16,000 lb GVW to 22,000 lb GVW
R	99-04	ADVENTURER	All Motorhomes with Ford F-53 Chassis with 16,000 lb GVW to 22,000 lb GVW
R	18-20	INTENT	All Motorhome Chassis with 16,000 lb GVW to 18,000 lb GVW
R	18-20	INTENT	All Motorhome Chassis with 20,500 lb GVW to 22,000 lb GVW
R	11-17	SIGHTSEER	All Motorhome Chassis with 16,000 lb GVW to 18,000 lb GVW
R	11-17	SIGHTSEER	All Motorhome Chassis with 20,500 lb GVW to 22,000 lb GVW
R	08-09	SIGHTSEER	All Motorhome Chassis with 16,000 lb GVW to 18,000 lb GVW
R	06-09	SIGHTSEER	All Motorhome Chassis with 20,500 lb GVW to 22,000 lb GVW
R	02-04	SIGHTSEER	All Motorhome Chassis with 20,500 lb GVW to 22,000 lb GVW
R	16-17	SUNOVA	All Motorhome Chassis with 16,000 lb GVW to 18,000 lb GVW
R	16-17	SUNOVA	All Motorhome Chassis with 20,500 lb GVW to 22,000 lb GVW
R	06-07	SUNOVA	All Motorhome Chassis with 20,500 lb GVW to 22,000 lb GVW
R	02-04	SUNOVA	All Motorhome Chassis with 20,500 lb GVW to 22,000 lb GVW
R	16-22	SUNSTAR	All Motorhome Chassis with 16,000 lb GVW to 18,000 lb GVW
R	16-22	SUNSTAR	All Motorhome Chassis with 20,500 lb GVW to 22,000 lb GVW
R	02-04	SUNSTAR	All Motorhome Chassis with 20,500 lb GVW to 22,000 lb GVW
R	16-18	SUNSTAR LX	All Motorhome Chassis with 16,000 lb GVW to 18,000 lb GVW
R	16-18	SUNSTAR LX	All Motorhome Chassis with 20,500 lb GVW to 22,000 lb GVW
R	11-22	VISTA	All Motorhome Chassis with 16,000 lb GVW to 18,000 lb GVW
R	11-22	VISTA	All Motorhome Chassis with 20,500 lb GVW to 22,000 lb GVW
R	08-09	VISTA	All Motorhome Chassis with 16,000 lb GVW to 18,000 lb GVW
R	07-09	VISTA	All Motorhome Chassis with 20,500 lb GVW to 22,000 lb GVW

89000 Series

Shock	POP	Alternative No.	MTG Acc. Supplied
Pos.	Year	Application	
89406	W (cont)		
R	02-04	VISTA	All Motorhome Chassis with 20,500 lb GVW to 22,000 lb GVW
R	16-18	VISTA LX	All Motorhome Chassis with 16,000 lb GVW to 18,000 lb GVW
R	16-18	VISTA LX	All Motorhome Chassis with 20,500 lb GVW to 22,000 lb GVW
89407	W		
F	73-80	CHEVROLET 5, 50, 5000 & 5500 SERIES	
F		COACHMEN CLASS A MOTORHOMES	
R	00-10	COUNTRY COACH AFFINITY	All MotorHomes with Neway IFS
F		FOREST RIVER CLASS A MOTORHOMES	
F		GEORGIE BOY MANUFACTURING CLASS A MOTORHOMES	
F	73-80	GMC 5000 SERIES	
F	73-75	6000 SERIES	
F		ITASCA CLASS A MOTORHOMES	
F		MONACO COACH CLASS A MOTORHOMES	
F		WORKHORSE VARIOUS	
89409	W 140149 (1)		
F	80-86	FORD C600	All Models with 4040, 5040 lb Springs and 7000, 9000, 12000 lb Axles
F	80-85	LN600	All Models with 4400 lb Spring and 7000, 9000 lb Axles
F	93-05	KENWORTH K300	All Models with Multiple Leaf Springs on Front Axle (3/4" Mounting bolts) T300
89410	C 401754 (4)		
F	93-05	KENWORTH K300	All Models with Taper Leaf Springs on Front Axle (1" Mounting bolts) T300
89413	W 145080 (2)		
F		INTERNATIONAL BINDER	
R		CARGOSTAR	
R	85	ISUZU ADDITIONAL APPLICATIONS	
R	86-95	NPR All	
F	13	PETERBILT 220	All Models with 12,000 lb Front Axle
F	10	220	All Models with 12,000 lb Front Axle
F	07	220	All Models with 12,000 lb Front Axle
F	08-19	325	All Models with 12000 lb Set Back Front Axle
F	05-10	335	All Models with 12000 lb Set Back Front Axle
89414	W		
F	09	COACHMEN AURORA	
F	07	AURORA	
F	08	AURORA	All MotorHomes with Ford F53 Chassis with 16,000 lb GVW to 22,000 lb GVW
F	04-06	AURORA	All MotorHomes with Ford F53 Chassis with 16,000 lb GVW to 22,000 lb GVW
F	21-24	ENCORE	All MotorHomes with Ford F53 Chassis with 16,000 lb GVW to 22,000 lb GVW
F	11-16	ENCOUNTER	All MotorHomes with Ford F53 Chassis with 16,000 lb GVW to 22,000 lb GVW
F	99-07	MIRADA	
F	08-24	MIRADA	All MotorHomes with Ford F53 Chassis with 16,000 lb GVW to 22,000 lb GVW
F	04-12	PURSUIT	
F	13-24	PURSUIT	All MotorHomes with Ford F53 Chassis with 16,000 lb GVW to 22,000 lb GVW
F	12-13	DAMON DAYBREAK	
F	99	DAYBREAK	
F	99	INTRUDER	
F	12-14	OUTLAW	
F	19-20	FLEETWOOD AXON	
F	06-23	FORD F-53	
F	99-04	F-53	
F	88-97	F-53	
F	05	F-53 MOTORHOME CHASSIS	
F	98	F-53 MOTORHOME CHASSIS	

Numerical listing

Shock	POP	Alternative No.	MTG Acc. Supplied
Pos.	Year	Application	
89414	W (cont)		
F	11-21	F-59 COMMERCIAL STRIPPED CHASSIS	All F59 Commercial Chassis with 16,000 lb to 22,000 lb GVW
F	89-97	F-59 COMMERCIAL STRIPPED CHASSIS	All F59 Commercial Chassis with 16,000 lb to 22,000 lb GVW
R	73-77	W AND WT SERIES - HI TILT CAB HIGHWAY TRACTOR	
F	13-24	FOREST RIVER FR3	All MotorHomes with Ford F53 Chassis with 16,000 lb GVW to 22,000 lb GVW
F	08-17	GEORGETOWN	All MotorHomes with Ford F53 Chassis with 16,000 lb GVW to 22,000 lb GVW
F	16-24	GEORGETOWN GT3	All MotorHomes with Ford F53 Chassis with 16,000 lb GVW to 22,000 lb GVW
F	17-24	GEORGETOWN GT5	All MotorHomes with Ford F53 Chassis with 16,000 lb GVW to 22,000 lb GVW
F	20-24	GEORGETOWN GT7	All MotorHomes with Ford F53 Chassis with 16,000 lb GVW to 22,000 lb GVW
F	99-09	GEORGIE BOY MANUFACTURING CLASS A MOTORHOMES	
F	11-15	HOLIDAY RAMBLER ADMIRAL	
F	02-06	ADMIRAL	
F	16-24	ADMIRAL	All MotorHomes with Ford F53 Chassis with 16,000 lb GVW to 22,000 lb GVW
F	07-10	ADMIRAL	All MotorHomes with Ford F53 Chassis with 16,000 lb GVW to 22,000 lb GVW
F	00-01	ADMIRAL	All MotorHomes with Ford F53 Chassis with 16,000 lb GVW to 22,000 lb GVW
F	02-06	ADMIRAL SE	All MotorHomes with Ford F53 Chassis with 16,000 lb GVW to 22,000 lb GVW
F	07	ADMIRAL SVE	All MotorHomes with Ford F53 Chassis with 16,000 lb GVW to 22,000 lb GVW
F	16-18	ADMIRAL XE	All MotorHomes with Ford F53 Chassis with 16,000 lb GVW to 22,000 lb GVW
F	23-24	ECLIPSE	All MotorHomes with Ford F53 Chassis with 16,000 lb GVW to 22,000 lb GVW
F	15	ENDEAVOR	
F	16-24	ENDEAVOR	All MotorHomes with Ford F53 Chassis with 16,000 lb GVW to 22,000 lb GVW
F	00-14	ENDEAVOR	All MotorHomes with Ford F53 Chassis with 16,000 lb GVW to 22,000 lb GVW
F	11-24	VACATIONER	All MotorHomes with Ford F53 Chassis with 16,000 lb GVW to 22,000 lb GVW
F	09	VACATIONER	All MotorHomes with Ford F53 Chassis with 16,000 lb GVW to 22,000 lb GVW
F	00-07	VACATIONER	All MotorHomes with Ford F53 Chassis with 16,000 lb GVW to 22,000 lb GVW
F	99-15	ITASCA CLASS A MOTORHOMES	
F	16-24	JAYCO ALANTE	All MotorHomes with Ford F53 Chassis with 16,000 lb GVW to 22,000 lb GVW
F	14-20	CLASS A MOTORHOMES	
F	14-24	PRECEPT	All MotorHomes with Ford F53 Chassis with 16,000 lb GVW to 22,000 lb GVW
F	07-08	MONACO COACH LA PALMA	
F	01	LA PALMA	
F	90-99	LA PALMA	
F	03-05	MONARCH	
F	90-99	MONARCH	
F	99-08	NATIONAL RV CLASS A MOTORHOMES	
F	13-20	NEWMAR CLASS A MOTORHOMES	
F	16-20	NEXUS CLASS A MOTORHOMES	
F	17-20	MAYBACH	All MotorHomes with Ford F53 Chassis with 16,000 lb GVW to 22,000 lb GVW
R	13-22	PETERBILT 220	All Models with Reyco 102AR (Standard) Rear Air Suspension

Numerical listing

Shock	POP	Alternative No.	MTG Acc. Supplied
Pos.	Year	Application	
89414	W	(cont)	
R	10	220 All Models with Reyco 102AR (Standard) Rear Air Suspension	
R	07	220 All Models with Reyco 102AR (Standard) Rear Air Suspension	
F	11-24	THOR MOTOR COACH A.C.E. All MotorHomes with Ford F53 Chassis with 16,000 lb GVW to 22,000 lb GVW	
F	05-08	CHALLENGER	
F	09-24	CHALLENGER All MotorHomes with Ford F53 Chassis with 16,000 lb GVW to 22,000 lb GVW	
F	04-10	HURRICANE	
F	11-24	HURRICANE All MotorHomes with Ford F53 Chassis with 16,000 lb GVW to 22,000 lb GVW	
F	23-24	INDIGO All MotorHomes with Ford F53 Chassis with 16,000 lb GVW to 22,000 lb GVW	
F	23-24	LUMINATE All MotorHomes with Ford F53 Chassis with 16,000 lb GVW to 22,000 lb GVW	
F	14-24	MIRAMAR All MotorHomes with Ford F53 Chassis with 16,000 lb GVW to 22,000 lb GVW	
F	07-10	OUTLAW	
F	11-23	OUTLAW All MotorHomes with Ford F53 Chassis with 16,000 lb GVW to 22,000 lb GVW	
F	23-24	RESONATE All MotorHomes with Ford F53 Chassis with 16,000 lb GVW to 22,000 lb GVW	
F	06-10	WINDSPORT	
F	11-24	WINDSPORT All MotorHomes with Ford F53 Chassis with 16,000 lb GVW to 22,000 lb GVW	
F	19-23	WINNEBAGO ADVENTURER All MotorHomes with Ford F53 Chassis with 16,000 lb GVW to 22,000 lb GVW	
F	92-17	ADVENTURER All MotorHomes with Ford F53 Chassis with 16,000 lb GVW to 22,000 lb GVW	
F	18-20	INTENT All MotorHomes with Ford F53 Chassis with 16,000 lb GVW to 22,000 lb GVW	
F	02-17	SIGHTSEER All MotorHomes with Ford F53 Chassis with 16,000 lb GVW to 22,000 lb GVW	
F	16-17	SUNOVA All MotorHomes with Ford F53 Chassis with 16,000 lb GVW to 22,000 lb GVW	
F	02-07	SUNOVA All MotorHomes with Ford F53 Chassis with 16,000 lb GVW to 22,000 lb GVW	
F	16-22	SUNSTAR All MotorHomes with Ford F53 Chassis with 16,000 lb GVW to 22,000 lb GVW	
F	02-04	SUNSTAR All MotorHomes with Ford F53 Chassis with 16,000 lb GVW to 22,000 lb GVW	
F	16-18	SUNSTAR LX All MotorHomes with Ford F53 Chassis with 16,000 lb GVW to 22,000 lb GVW	
F	07-22	VISTA All MotorHomes with Ford F53 Chassis with 16,000 lb GVW to 22,000 lb GVW	
F	02-04	VISTA All MotorHomes with Ford F53 Chassis with 16,000 lb GVW to 22,000 lb GVW	
F	16-18	VISTA LX All MotorHomes with Ford F53 Chassis with 16,000 lb GVW to 22,000 lb GVW	
89423	W	141108 (1)	
R	93-05	KENWORTH K300 All All with Air Glide 100 Suspension with 8 air bags, 4 units required	
R		T300	
89424	B	141247 (1)	
R	05-10	PETERBILT 335 All Models with Air Trac Suspension (46,000 lb)	
89430	C		
F	60-70	CHEVROLET 4, 40, 4000 & 4500 SERIES	
R	71-72	5, 50, 5000 & 5500 SERIES	
F	63-70	5, 50, 5000 & 5500 SERIES	
R	08-23	FORD F-53	
R	20-24	FOREST RIVER GEORGETOWN GT7 All MotorHomes with Ford F53 Chassis with 24,000 lb GVW to 26,000 lb GVW	

89000 Series

Shock	POP	Alternative No.	MTG Acc. Supplied
Pos.	Year	Application	
89430	C	(cont)	
F		FREIGHTLINER BUS CHASSIS	
R	02-23	M2 106 All Models with Reyco 79KB Rear Steel Spring Suspension	
F		VARIOUS	
F	63-66	GMC 3500 & 4000 SERIES	
F	72-80	4500 SERIES	
R	66-72	4500 SERIES	
F	63-68	5000 SERIES	
F	63-89	5500 SERIES	
R	66-72	5500 SERIES	
F	05-10	HINO 145 All Models with O.E.M. Number	
F	05-10	165 All Models with O.E.M. Number	
F	05-10	185 All Models with O.E.M. Number	
R	20-23	HOLIDAY RAMBLER INVICTA All MotorHomes with Ford F53 Chassis with 24,000 lb GVW to 26,000 lb GVW	
R	11-23	VACATIONER All MotorHomes with Ford F53 Chassis with 24,000 lb GVW to 26,000 lb GVW	
R	09	VACATIONER All MotorHomes with Ford F53 Chassis with 24,000 lb GVW to 26,000 lb GVW	
R	13-24	KENWORTH K270 All Models with Reyco 102 or 79KB Suspension (Drive Axle)	
R	93-05	K300 All Models with Reyco 102 or 79KB Suspension (Drive Axle)	
F	93-05	K300 All Models with Reyco 1209 or 1212 Suspension (Steer Axle)	
R	08-22	T170 All Models with Reyco 79KB Rear Steel Spring Suspension	
R	08-23	T270 All Models with Reyco 102 or 79KB Suspension (Drive Axle)	
R	21-24	T280 All Models with Reyco 102 or 79KB Suspension (Drive Axle)	
F		T300	
R		T300	
R	00-08	T300 All Models with Reyco 102 or 79KB Suspension (Drive Axle)	
R	00-08	T300 All Models with Reyco 1209 or 1212 Suspension (Steer Axle)	
R	08-15	PETERBILT 210 All Models with Reyco 102 or 79KB Suspension (Drive Axle)	
R	13-24	220 All Models with Reyco 102 or 79KB Suspension (Drive Axle)	
R	10	220 All Models with Reyco 102 or 79KB Suspension (Drive Axle)	
R	07	220 All Models with Reyco 102 or 79KB Suspension (Drive Axle)	
R	08-19	325 All Models with Reyco 102 or 79KB Suspension (Drive Axle)	
R	11-24	THOR MOTOR COACH OUTLAW All MotorHomes with Ford F53 Chassis with 24,000 lb GVW to 26,000 lb GVW	
R	19-23	WINNEBAGO ADVENTURER All MotorHomes with Ford F53 Chassis with 24,000 lb GVW to 26,000 lb GVW	
R	08-17	ADVENTURER All MotorHomes with Ford F53 Chassis with 24,000 lb GVW to 26,000 lb GVW	
R	16-22	SUNSTAR All MotorHomes with Ford F53 Chassis with 24,000 lb GVW to 26,000 lb GVW	
R	08-22	VISTA All MotorHomes with Ford F53 Chassis with 24,000 lb GVW to 26,000 lb GVW	
89431	W		
F		FREIGHTLINER MB CHASSIS	
F	98-23	MT45 All Step Van Models with O.E.M. Number	
F		MT55	
F		VARIOUS	
F		THOMAS VARIOUS	
89436	B		
R		THOMAS VARIOUS	
89440	W		
R	91-96	SPARTAN MOTORS K2	
89443	C		
R	13-24	DYNAMAX CORP DX3 All Models with Airliner 21,000 lb Rear Air Suspension	
R	05-07	DYNAQUEST All Models with Airliner 18,000 lb Rear Air Suspension	

Numerical listing

Shock	POP	Alternative No.	MTG Acc. Supplied
Pos.	Year	Application	
89443	C	(cont)	
R	09-14	DYNAQUEST ST All Models with Airliner 18,000 lb Rear Air Suspension	
R	09-24	DYNAQUEST XL All Models with FAS II (40,000 lb) Rear Air Suspension	
R	21-24	EUROPA All Models with Airliner 21,000 lb Rear Air Suspension	
R	22	FORCE HD All Models with Airliner 21,000 lb Rear Air Suspension	
R	15-18	FORCE HD All Models with Airliner 21,000 lb Rear Air Suspension	
R	02-04	GRAND SPORT All Models 23,000 lb Airliner Rear Air Suspension	
R	09-14	GRAND SPORT GT All Models with Freightliner Airliner Rear Air Suspension	
R	07-13	GRAND SPORT GT TOY HAULER All Models 21K or 23K Airliner Rear Air Suspension	
R	03-07	GRAND SPORT M2 All Models with Airliner 21,000 lb Rear Air Suspension	
R	07-14	GRAND SPORT ULTRA All Models 23,000 lb Airliner Rear Air Suspension	
R	20-24	ENTEGR COACH ACCOLADE All Models with Freightliner S2RV chassis	
R	21-24	ACCOLADE XL All Models with Freightliner S2RV chassis	
R	02-19	FEDERAL COACH VARIOUS	
R	05-23	FREIGHTLINER B2 All Models with FAS II (40,000 lb) Rear Air Suspension	
R	99-04	FC70 All Models with FAS II (40,000 lb) Rear Air Suspension	
R	95-05	FL50 All Models with FAS II (40,000 lb) Rear Air Suspension	
R	91-05	FL60 All Models with FAS II (40,000 lb) Rear Air Suspension	
R	05-21	M2 All Models with FAS II (40,000 lb) Rear Air Suspension	
R	02-10	M2 100 All Models with FAS II (40,000 lb) Rear Air Suspension	
R	02-24	M2 106 All Models with FAS II (40,000 lb) Rear Air Suspension	
R	18-24	JAYCO SENECA All Models with Freightliner S2RV chassis	
R	21-23	SENECA PRESTIGE All Models with Freightliner S2RV chassis	
R	18-24	RENEGADE VALENCIA All Models with Freightliner S2RV chassis	
R	03-10	STERLING TRUCK ACTERRA All Models with FAS II (40,000 lb) Rear Air Suspension	
R	01-07	ACTERRA 5500 All Models with FAS II (40,000 lb) Rear Air Suspension	
R	01-07	ACTERRA 6500 All Models with FAS II (40,000 lb) Rear Air Suspension	
R	01-07	ACTERRA 7500 All Models with FAS II (40,000 lb) Rear Air Suspension	
R	03	ACTERRA 8500 All Models with FAS II (40,000 lb) Rear Air Suspension	
R	01	ACTERRA 8500 All Models with FAS II (40,000 lb) Rear Air Suspension	
R		THOMAS VARIOUS	
R	22-24	THOR MOTOR COACH INCEPTION All Models with Freightliner S2RV chassis	
R	22-24	PASADENA All Models with Freightliner S2RV chassis	
89447	W	141108 (1)	
F		INTERNATIONAL SERIES 4000 - SHORT CONVENTIONAL MEDIUM TRK & TRAC	
F	90-02	SERIES 4000 - SHORT CONVENTIONAL MEDIUM TRK & TRAC	
F	86-88	MITSUBISHI FUSO FM All Model with O.E.M. Number	
89449	D		
F	02-04	DYNAMAX CORP GRAND SPORT All Models with 12000 lb Taperleaf Front Suspension	

Numerical listing

89000 Series

Numerical listing

Shock	POP	Alternative No.	MTG Acc. Supplied
Pos.	Year	Application	

Shock	POP	Alternative No.	MTG Acc. Supplied
Pos.	Year	Application	

Shock	POP	Alternative No.	MTG Acc. Supplied
Pos.	Year	Application	

89449 D (cont)

F 07-08 GRAND SPORT GT TOY HAULER All 410TH & 450TH Models with 12000 lb Taperleaf Front Suspension

F 07-08 GRAND SPORT ULTRA All Models with 14,000 lb Taperleaf Front Suspension

F 20-24 **INTEGRA COACH ACCOLADE** All Models with Freightliner S2RV chassis

F 21-24 ACCOLADE XL All Models with Freightliner S2RV chassis

F 05-23 **FREIGHTLINER B2** All Models with 12000 lb Taperleaf Front Suspension

F MC CHASSIS

F 18-24 **JAYCO SENECA** All Models with Freightliner S2RV chassis

F 21-24 SENECA PRESTIGE All Models with Freightliner S2RV chassis

F 18-24 **RENEGADE VALENCIA** All Models with Freightliner S2RV chassis

F 22-24 **THOR MOTOR COACH INCEPTION** All Models with Freightliner S2RV chassis

F 22-24 PASADENA All Models with Freightliner S2RV chassis

89453 W

F 03-10 **STERLING TRUCK ACTERRA** All Models with Hendrickson Front Airtek

F 01-07 ACTERRA 5500 All Models with Hendrickson Front Airtek

F 01-07 ACTERRA 6500 All Models with Hendrickson Front Airtek

F 01-07 ACTERRA 7500 All Models with Hendrickson Front Airtek

F 03 ACTERRA 8500 All Models with Hendrickson Front Airtek

F 01 ACTERRA 8500 All Models with Hendrickson Front Airtek

89455 C **141108 (1)**

R 08-23 **KENWORTH T270** All Models with AG210L Rear Air Suspension

R 05-10 **PETERBILT 335** All Models with Peterbilt Low Air Leaf Suspension

R 22-24 536 All Models with Peterbilt Low Air Leaf Suspension

89458 W

R 08-09 **INTERNATIONAL 4300** All Models with International 40,000 lb Rear Air Suspension

R 08-09 4400 All Models with International 40,000 lb Rear Air Suspension

R DURASTAR - 4300, 4400 SERIES

R 10-11 DURASTAR - 4300, 4400 SERIES

R TERRASTAR

89460 W

F 10-14 **KENWORTH T270** All Models with 10,000 lb to 12,000 lb Front Axle

F 10-14 T270 All Models with 13,200 lb to 14,600 lb Front Axle

F 10-14 T270 All Models with 8,000 lb Front Axle

F 08-15 **PETERBILT 325** All Models with 8,000 lb Front Axle

89503 W

F 05-07 **DYNAMAX CORP DYNAQUEST** All Models with 10000 to 12000 lb. Taper-leaf Spring Suspension

F 07-08 GRAND SPORT GT TOY HAULER All 390TH Models with 12000 lb Taperleaf Front Suspension

F 03-07 GRAND SPORT M2 All Models with 10000 to 12000 lb. Taper-leaf Spring Suspension

F 02-08 **FEDERAL COACH VARIOUS**

F 02-08 **FREIGHTLINER M2 106** All Models with 10000 to 12000 lb. Taper-leaf Spring Suspension

F 02-08 M2 106 All Models with 6000 to 9000 lb Front axle

F 01-09 **STERLING TRUCK ACTERRA**

COMPETITIVE & O.E.M. INTERCHANGE LIST
Lista de Intercambios contra Competidores y Equipo Original.
Liste dinterchange de produits compititifs & dquipement original (OEM)

ABC BUS

Abc bus	Gabriel	Upgrade	Abc bus	Gabriel	Upgrade	Abc bus	Gabriel	Upgrade	Abc bus	Gabriel	Upgrade
050134513	85732		12L-5-72	85709		12L588	85729		624313790	85708	
12J-5-10	85733		12L-5-88	85729		3166657	85700		624314040	85708	
12J510	85733		12L5114	85727		6243-13790	85708		680323	85700	
12L-5-114	85727		12L572	85709		6243-14040	85708				

ACDelco

AcDelco	Gabriel	Upgrade	AcDelco	Gabriel	Upgrade	AcDelco	Gabriel	Upgrade	AcDelco	Gabriel	Upgrade
13329507	G51982		501-92	143204		504-505	49107		507-5	89422	
13345954	G51971		503-141	G55591		504-508	49122		507-6	85314	89425
15058617	G64014		503-172	G55661		504-510	49128		507-6	89425	
18041239	G63676		503-173	G55662		504-511	49131		507-7	85301	
19165214	G63869		503-195	G55697		504-512	49135		507-8	85301	
19172143	G51728		503-196	G55698		504-516	49152		507-9	85700	
19177778	G51718		503-248	G55772		504-517	49155		508-13	85012	89413
19203623	G51746		503-278	G55820		504-518	49157		508-13	89413	
19235162	G51736		503-280	G55825		504-520	49162		508-14	83216	
19241342	G56809		503-285	G55856		504-531	49203		508-14	85012	89413
19294056	G56726		503-322	G55948		504-534	49212		508-14	89413	
19294309	G57022		503-323	G55949		504-535	43162		508-15	83216	
19294310	G56929		503-338	G55999		504-535	49213		508-16	83308	
19294314	G57051		503-340	G56700		504-537	49215		508-17	83312	89409
19294318	G57013		503-341	G56701		504-539	49218		508-17	89409	
19294319	G57014		503-353	G56718		504-547	49228		508-18	83309	
19294320	G56948		503-389	G55892		504-547	49255		508-19	83314	
19294321	G56948		503-589	G56509		504-549	49230		508-20	83207	89407
19294322	G56950		503-599	G51746		504-550	49231		508-20	89407	
19294323	G56949		503-615	G56773		504-554	49235		508-21	83214	
19294325	G56951		503-616	G56774		504-557	49304		508-23	83225	
19294330	G57048		503-637	G56809		504-562	49311		508-24	83215	
19294331	G57047		503-638	G56810		504-564	49334		508-26	83203	89436
19294350	G52013		503-662	G56886		504-579	49254		508-26	85030	89440
19294353	G52026		503-663	G56887		505-520	G55825		508-26	89436	
19307626	G51850		503-664	G52013		506-253	G55698		508-26	89440	
19324428	G57048		503-665	G52014		506-310	G52014		508-28	83207	89407
19324429	G57047		503-666	G52025		506-657	G52246		508-28	89407	
19325297	G52278		503-667	G52026		506-658	G52245		508-29	85030	89440
19325298	G52279		503-668	G52027		506-687	G52013		508-29	89440	
19359121	G52395		503-677	G51759		506-749	G52281		508-3	83400	
19359122	G52396		503-681	G52125		506-753	G52280		508-30	85005	89430
19359125	G52494		503-682	G52116		506-801	G56886		508-30	89430	
19359126	G52495		503-683	G52127		506-803	G56887		508-35	G63306	
22737716	G52395		503-684	G52128		506-806	G52395		508-39	G63347	
22737717	G52396		503-685	G51904		506-807	G52396		508-42	G63353	
22737724	G51975		503-686	G51871		507-1	85304		508-464	G63676	
501-10	143057		503-687	G51850		507-10	85711		508-47	G63350	
501-13	83318		503-688	G51891		507-11	85308	89422	508-48	G63409	
501-187	142526		503-689	G51870		507-11	89422		508-5	G63359	
501-192	142530		503-699	G52244		507-13	85704		508-5	G63360	
501-2	143058		503-700	G52278		507-16	85702		508-50	G63299	
501-209	142547		503-701	G52279		507-17	85304		508-52	G63405	
501-218	142836		503-702	G52280		507-18	85305		508-52	G63419	
501-318	142561		503-703	G52281		507-19	85700		508-56	G63605	
501-358	143073		503-705	G51949		507-2	85302	89420	508-57	83123	89405
501-386	143281		503-708	G52395		507-2	89420		508-57	89405	
501-4	143061		503-709	G52396		507-3	85307				
501-5	143059		503-710	G52494		507-4	85303	89422			
501-75	83303		503-711	G52495		507-4	89422				
501-82	142249		504-501	49255		507-5	85308	89422			

Important Note: Competitive Interchanges are to be used for stocking purposes only. Where multiple crosses are identified, please reference the applications section of this catalog. / **Remarque importante:** Les interchanges concurrentiels ne s'utilisent qu'aux fins de stocks. Dans le cas de références multiples, consulter la section des applications du catalogue. / **Nota importante:** En el caso de referencias múltiples, consultar la sección de aplicaciones del catálogo. / **Nota importante:** Se pueden usar intercambios competitivos para propósitos de almacenamiento solamente. Cuando se identifican intercambios múltiples, consulte la sección de aplicaciones de este catálogo.

COMPETITIVE & O.E.M. INTERCHANGE LIST
Lista de Intercambios contra Competidores y Equipo Original.
Liste d'interchange de produits complitifs & d'equipement original (OEM)

ACDelco... cont'd

AcDelco	Gabriel	Upgrade	AcDelco	Gabriel	Upgrade	AcDelco	Gabriel	Upgrade	AcDelco	Gabriel	Upgrade
508-59	G63183		520-168	81446		520-372	82602		530-130	G63349	
508-68	83209	89414	520-17	61517		520-378	82609		530-130	G63422	
508-68	85006		520-175	81478		520-386	82618		530-133	G63355	
508-68	89414		520-176	81482		520-39	61541		530-133	G63421	
508-71	83314		520-177	81481		520-392	61664		530-134	G63357	
508-72	G63386		520-178	81490		520-393	81869		530-147	G63403	
508-74	G63511		520-179	81494		520-394	69622		530-147	G63413	
508-78	83400		520-180	81492		520-394	81880		530-151	G63366	
508-79	G63424		520-182	81495		520-396	61675		530-156	G63421	
508-80	G63425		520-183	81496		520-398	61777		530-157	G63422	
508-82	G63410		520-184	81484		520-40	61542		530-158	G63423	
508-86	83136		520-186	81507		520-401	61687		530-159	G63424	
508-87	85071		520-187	81514		520-403	61683		530-16	69715	
508-9	85000	89436	520-188	81516		520-406	61690		530-160	G63425	
508-9	89436		520-19	61519		520-407	61684		530-161	G63426	
508-90	83136		520-194	81540		520-408	61685		530-17	69714	
509-606	14017		520-196	81548		520-409	61717		530-175	G63375	
509-607	14018		520-197	81549		520-41	61543		530-176	G63454	
509-610	14040		520-199	81553		520-410	61718		530-189	G63488	
509-611	6801SE		520-2	61501		520-42	61544		530-189	G63609	
509-612	6802SE		520-205	81559		520-426	81930		530-190	G63489	
509-613	6803SE		520-206	81560		520-427	81318		530-193	G63492	
509-626	6853SE		520-210	81582		520-428	81873		530-2	69604	
519-15	43111		520-214	81667		520-429	81920		530-20	69675	
519-2	43048		520-215	81668		520-431	81922		530-201	G63403	
519-21	43162		520-22	61522		520-432	81924		530-202	G63411	
519-22	43163		520-220	81675		520-433	81925		530-203	G63394	
519-29	43180		520-227	81713		520-5	61504		530-211	G63511	
519-3	43049		520-238	81750		520-53	61555		530-223	G63609	
519-30	43181		520-24	61524		520-58	61560		530-235	G63625	
519-31	34036		520-25	61525		520-61	61565		530-238	G63638	
519-32	34051		520-261	82003		520-65	61575		530-243	G63662	
519-36	34073		520-268	82010		520-7	61506		530-247	G63675	
519-5	43060		520-27	61528		520-85	61600		530-251	G63683	
519-5	49152		520-292	82034		520-89	61605		530-253	G63690	
520-1	61500		520-293	82035		520-9	61508		530-267	G63721	
520-100	61616		520-298	82040		520-99	61615		530-268	G63722	
520-115	61641		520-30	61531		525-16	58403		530-274	G63902	
520-116	61642		520-300	82047		525-21	58412		530-279	G63907	
520-117	61643		520-310	82060		525-25	58421		530-281	G63909	
520-132	61659		520-319	82070		525-26	58422		530-295	G63776	
520-135	61663		520-323	82075		525-27	58423		530-298	G63783	
520-138	81039		520-324	82076		525-33	58488		530-3	69606	
520-141	81095		520-326	82079		525-34	58489		530-300	G63799	
520-142	81096		520-331	82086		525-36	58609		530-301	G63803	
520-145	81113		520-332	82087		525-42	58638		530-311	G63817	
520-146	81164		520-34	61535		525-44	58662		530-312	G63818	
520-147	81147		520-343	82109		525-55	58901		530-315	69625	
520-150	81242		520-344	82110		525-59	58803		530-324	G63829	
520-152	81270		520-35	61536		525-6	58357		530-335	G63842	
520-154	81340		520-350	82118		525-66	58817		530-336	G63844	
520-157	81394		520-353	82125		525-68	58930		530-338	G63847	
520-16	61516		520-360	82138		530-1	69600		530-37	69795	
520-164	81510		520-365	82151		530-10	69676		530-387	G63866	
520-165	81082		520-37	61539		530-129	G63347		530-393	G63868	
520-168	69675		520-371	82601		530-129	G63423		530-394	G63869	

Important Note: Competitive Interchanges are to be used for stocking purposes only. Where multiple crosses are identified, please reference the applications section of this catalog. / **Remarque importante:** Les interchanges concurrentiels ne s'utilisent qu'aux fins de stocks. Dans le cas de références multiples, consulter la section des applications du catalogue. / **Nota importante:** Dans le cas de références multiples, consulter la section des applications du catalogue. / **Nota importante:** Se pueden usar intercambios competitivos para propósitos de almacenamiento solamente. Cuando se identifican intercambios múltiples, consulte la sección de aplicaciones de este catálogo.

COMPETITIVE & O.E.M. INTERCHANGE LIST
Lista de Intercambios contra Competidores y Equipo Original.
Liste d'interchange de produits compititifs & d'equipement original (OEM)

ACDelco... cont'd

ACdelco	Gabriel	Upgrade	ACdelco	Gabriel	Upgrade	ACdelco	Gabriel	Upgrade	ACdelco	Gabriel	Upgrade
530-395	G63884		540-5018	77783		88945315	G63413		901-085	143461	
530-4	69622		540-5023	77422		88945329	G63426		901-086	143462	
530-402	G63882		540-5024	77423		88945361	G63492		903-003RS	G56726	
530-403	G63879		540-5027	77454		88945403	G63625		903-004RS	G56927	
530-407	G51718		540-5032	77488		88945411	G63662		903-005RS	G56927	
530-42	69811		540-5033	77488		88945415	G63675		903-005RS	G56928	
530-423	G63872		540-5033	77489		88945417	G63678		903-012RS	G57060	
530-439	G51736		540-5040	77609		88945453	G63928		903-014RS	G56938	
530-441	G63893		540-5043	77638		88945468	G63799		903-015RS	G57022	
530-442	G63896		540-5046	77662		88945652	G55661		903-016RS	G56929	
530-443	G63897		540-5062	77783		88945653	G55662		903-020RS	G57051	
530-448	G63959		540-5063	77803		88945675	G55697		903-024RS	G57013	
530-449	G63894		540-5069	77817		88945728	G55772		903-025RS	G57014	
530-450	G63895		540-5077	77907		88945758	G55820		903-026RS	G56948	
530-454	69590		540-5078	77909		88945760	G55825		903-027RS	G56948	
530-455	G64014		540-5088	77953		88945765	G55856		903-028RS	G56950	
530-456	69587		540-514	G51904		88945818	G55999		903-029RS	G56949	
530-457	69589		550-13	85005	89430	88963960	G55892		903-031RS	G56951	
530-466	G64015		550-13	89430		88973940	G52014		903-032RS	G56924	
530-467	70031		550-73	83303		88973942	G52013		903-033RS	G56925	
530-469	G64040		550-73	85005	89430	88974638	G51736		903-035RS	G57000	
530-476	G64101		550-73	89430		88991409	G63882		903-035RS	G57023	
530-479	70059		550-75	83303		901-015	142249		903-038RS	G57048	
530-480	G51971		550-77	83221		901-016	142245		903-039RS	G57047	
530-480	G51975		560-200	G51871		901-038	142526		903-040RS	G57125	
530-481	G64140		560-201	G51871		901-039	142526		903-041RS	G57070	
530-482	G511030		560-545	69845		901-042	142530		903-041RS	G57122	
530-483	G51982		560-596	G51736		901-052	143073		903-042RS	G57069	
530-5	69624		560-681	G51971		901-053	143074		903-042RS	G57121	
530-6	69632		560-691	G51975		901-064	143058		903-043RS	G57142	
530-9	69724		560-809	G52494		901-064	143059		903-044RS	G57111	
540-127	69898		560-810	G52495		901-071	143094		903-045RS	G57110	
540-144	G64014		560-811	G52494		901-073	143425		903-048RS	G57067	
540-404	G51718		560-812	G52495		901-074	143323		903-049RS	G57068	
540-5001	75676		88875108	G56887		901-075	143316		92195485	G51916	
540-5008	77403		88945297	G63347		901-076	143061		92244058	G52281	
540-5010	77375		88945297	G63423		901-078	143063		92244059	G52280	
540-5018	77412		88945315	G63403		901-079	143064				

ACDelco Long Number

ACdelco long number	Gabriel	Upgrade	ACdelco long number	Gabriel	Upgrade	ACdelco long number	Gabriel	Upgrade	ACdelco long number	Gabriel	Upgrade
13329507	G51982		19294319	G57014		19325298	G52279		88945328	G63425	
13345954	G51971		19294320	G56948		19359120	G51975		88945329	G63426	
15058617	G64014		19294321	G56948		19359121	G52395		88945361	G63492	
18041239	G63676		19294322	G56950		19359122	G52396		88945369	G63403	
19165214	G63869		19294323	G56949		19359125	G52494		88945370	G63411	
19172143	G51728		19294325	G56951		19359126	G52495		88945403	G63625	
19177778	G51718		19294330	G57048		22737716	G52395		88945411	G63662	
19203623	G51746		19294331	G57047		22737717	G52396		88945415	G63675	
19203639	G56773		19294350	G52013		22737724	G51975		88945417	G63678	
19203640	G56774		19294351	G52014		88875107	G56886		88945419	G63683	
19235162	G51736		19294353	G52026		88875108	G56887		88945435	G63721	
19241342	G56809		19294354	G52027		88945297	G63347		88945436	G63722	
19294056	G56726		19295570	G51759		88945297	G63423		88945442	G63902	
19294309	G57022		19307626	G51850		88945302	G63357				
19294310	G56929		19324428	G57048		88945315	G63403				
19294314	G57051		19324429	G57047		88945315	G63413				
19294318	G57013		19325297	G52278		88945327	G63424				

Important Note: Competitive Interchanges are to be used for stocking purposes only. Where multiple crosses are identified, please reference the applications section of this catalog. / **Remarque importante:** Les interchanges concurrentiels ne s'utilisent qu'aux fins de stocks. Dans le cas de références multiples, consulter la section des applications du catalogue. / **Nota importante:** Dans le cas de referencias multiples, consultar la sección de aplicaciones del catálogo. / **Nota importante:** Se pueden usar intercambios competitivos para propósitos de almacenamiento solamente. Cuando se identifican intercambios múltiples, consulte la sección de aplicaciones de este catálogo.

COMPETITIVE & O.E.M. INTERCHANGE LIST
Lista de Intercambios contra Competidores y Equipo Original.
Liste d'interchange de produits complitifs & d'equipement original (OEM)

ACDelco Long Number... cont'd

ACdelco long number	Gabriel	Upgrade	ACdelco long number	Gabriel	Upgrade	ACdelco long number	Gabriel	Upgrade	ACdelco long number	Gabriel	Upgrade
88945447	G63907		88945675	G55697		88945833	G56718		88985528	G63829	
88945449	G63909		88945676	G55698		88961962	G63844		88991409	G63882	
88945453	G63928		88945728	G55772		88961964	G63847		92195485	G51916	
88945468	G63799		88945758	G55820		88963960	G55892		92244058	G52281	
88945621	G55591		88945760	G55825		88973940	G52014		92244059	G52280	
88945652	G55661		88945765	G55856		88973942	G52013				
88945653	G55662		88945818	G55999		88974638	G51736				

ACDelco Short Number

ACdelco short number	Gabriel	Upgrade	ACdelco short number	Gabriel	Upgrade	ACdelco short number	Gabriel	Upgrade	ACdelco short number	Gabriel	Upgrade
503-141	G55591		503-709	G52396		530-203	G63394		530-483	G51982	
503-172	G55661		503-710	G52494		530-211	G63511		540-144	G64014	
503-173	G55662		503-711	G52495		530-223	G63609		540-404	G51718	
503-195	G55697		505-520	G55825		530-235	G63625		540-514	G51904	
503-196	G55698		506-253	G55698		530-238	G63638		560-200	G51871	
503-248	G55772		506-310	G52014		530-243	G63662		560-201	G51871	
503-278	G55820		506-657	G52246		530-247	G63675		560-596	G51736	
503-280	G55825		506-658	G52245		530-251	G63683		560-681	G51971	
503-285	G55856		506-687	G52013		530-253	G63690		560-691	G51975	
503-322	G55948		506-749	G52281		530-267	G63721		560-809	G52494	
503-323	G55949		506-753	G52280		530-268	G63722		560-810	G52495	
503-338	G55999		506-801	G56886		530-274	G63902		560-811	G52494	
503-340	G56700		506-803	G56887		530-279	G63907		560-812	G52495	
503-341	G56701		506-806	G52395		530-281	G63909		903-003RS	G56726	
503-353	G56718		506-807	G52396		530-295	G63776		903-004RS	G56927	
503-389	G55892		508-42	G63353		530-298	G63783		903-005RS	G56927	
503-589	G56509		508-464	G63676		530-300	G63799		903-005RS	G56928	
503-599	G51746		508-5	G63359		530-301	G63803		903-012RS	G57060	
503-615	G56773		508-5	G63360		530-311	G63817		903-014RS	G56938	
503-616	G56774		508-79	G63424		530-312	G63818		903-015RS	G57022	
503-637	G56809		508-80	G63425		530-324	G63829		903-016RS	G56929	
503-638	G56810		508-82	G63410		530-335	G63842		903-020RS	G57051	
503-662	G56886		530-129	G63347		530-336	G63844		903-024RS	G57013	
503-663	G56887		530-129	G63423		530-338	G63847		903-025RS	G57014	
503-664	G52013		530-130	G63349		530-387	G63866		903-026RS	G56948	
503-665	G52014		530-130	G63422		530-393	G63868		903-027RS	G56948	
503-666	G52025		530-133	G63355		530-394	G63869		903-028RS	G56950	
503-667	G52026		530-133	G63421		530-395	G63884		903-029RS	G56949	
503-668	G52027		530-134	G63357		530-402	G63882		903-031RS	G56951	
503-677	G51759		530-147	G63403		530-403	G63879		903-032RS	G56924	
503-681	G52125		530-147	G63413		530-407	G51718		903-033RS	G56925	
503-682	G52116		530-151	G63366		530-423	G63872		903-035RS	G57000	
503-683	G52127		530-156	G63421		530-439	G51736		903-035RS	G57023	
503-684	G52128		530-157	G63422		530-441	G63893		903-038RS	G57048	
503-685	G51904		530-158	G63423		530-442	G63896		903-039RS	G57047	
503-686	G51871		530-159	G63424		530-443	G63897		903-040RS	G57125	
503-687	G51850		530-160	G63425		530-448	G63959		903-041RS	G57070	
503-688	G51891		530-161	G63426		530-449	G63894		903-041RS	G57122	
503-689	G51870		530-175	G63375		530-450	G63895		903-042RS	G57069	
503-699	G52244		530-176	G63454		530-455	G64014		903-042RS	G57121	
503-700	G52278		530-189	G63488		530-466	G64015		903-043RS	G57142	
503-701	G52279		530-189	G63609		530-469	G64040		903-044RS	G57111	
503-702	G52280		530-190	G63489		530-476	G64101		903-045RS	G57110	
503-703	G52281		530-193	G63492		530-480	G51971		903-048RS	G57067	
503-705	G51949		530-201	G63403		530-480	G51975		903-049RS	G57068	
503-708	G52395		530-202	G63411		530-481	G64140				

Important Note: Competitive Interchanges are to be used for stocking purposes only. Where multiple crosses are identified, please reference the applications section of this catalog. / **Remarque importante:** Les interchanges concurrentiels ne s'utilisent qu'aux fins de stocks. Dans le cas de références multiples, consulter la section des applications du catalogue. / **Nota importante:** Dans le cas de références multiples, consulter la section des applications du catalogue. / **Nota importante:** Se pueden usar intercambios competitivos para propósitos de almacenamiento solamente. Cuando se identifican intercambios múltiples, consulte la sección de aplicaciones de este catálogo.

COMPETITIVE & O.E.M. INTERCHANGE LIST
Lista de Intercambios contra Competidores y Equipo Original.
Liste dinterchange de produits compititifs & dquipement original (OEM)

ACF Brill Bus

Acf brill bus	Gabriel	Upgrade	Acf brill bus	Gabriel	Upgrade	Acf brill bus	Gabriel	Upgrade	Acf brill bus	Gabriel	Upgrade
610513	85307		641521	85308	89422	649648		89422	661732	83215	
631237	85308	89422	641521	89422		659129	85303	89422	661733	83225	
631237	89422		649648	85308	89422	659129		89422	995891	85307	

Advance AutoParts

Advance autoparts	Gabriel	Upgrade	Advance autoparts	Gabriel	Upgrade	Advance autoparts	Gabriel	Upgrade	Advance autoparts	Gabriel	Upgrade
139104	G57125		172450	G57128		181299	G56943		181454	G57105	
142426	G57628		172451	G57129		181321	G57017		181461	G57158	
171111	G57053		172498	G57346		181322	G57018		181462	G57157	
171126	G57447		172499	G57345		181327	G57159		181490	G57042	
171137L	G57454		172501	G57423		181327	G57160		181491	G57041	
171137R	G57453		172532	G57497		181340L	G57032		181492	G57044	
171312	G57036		172533	G57498		181340L	G57061		181493	G57043	
171352L	G57010		172568	G57456		181340R	G57033		181504	G57064	
171352R	G57010		172569	G57455		181340R	G57062		181505	G57063	
171441	G57145		172604	G57494		181341	G57022		181525	G57039	
171442	G57144		172605	G57493		181346	G57080		181572L	G56956	
171447	G57515		172608	G57474		181348L	G57027		181572R	G56957	
171448	G57516		172609	G57473		181348R	G57027		181577L	G57007	
171575	G57397		172663	G57378		181353	G57282		181577R	G57008	
171578	G56973		172664	G57377		181358	G57092		181584	G57279	
171579	G56974		172678	G57645		181358	G57118		181585	G57278	
171580	G56975		172679	G57644		181361	G57020		181593	G57046	
171933	G57006		172684	G57673		181362	G57021		181594	G57045	
172103	G57613		172685	G57674		181369	G57015		181597	G57012	
172104	G57612		172765	G57563		181369	G57212		181598	G57011	
172170	G57490		172766	G57562		181370	G57016		181615	G56934	
172171	G57489		172888	G57583		181371L	G57133		181615	G56937	
172191	G57219		172889	G57582		181371R	G57134		181616	G56936	
172191	G57399		172901	G57546		181372	G57056		181661	G57060	
172192	G57218		172902	G57545		181373L	G57067		181667	G56963	
172192	G57398		172905	G57368		181373R	G57068		181668	G56962	
172194	G57343		172906	G57367		181377L	G57083		181669	G56964	
172194	G57400		172957L	G57597		181377R	G57083		181672	G56927	
172195	G57270		172957R	G57598		181380L	G57086		181674	G57558	
172213	G57153		172962	G57677		181380R	G57087		181675	G57559	
172214	G57152		172963	G57676		181398	G57019		181678	G56931	
172242	G57342		172974	G57606		181400	G57269		181679	G56930	
172243	G57341		172975	G57605		181401	G57268		181680	G56933	
172272	G57184		172989	G57544		181404	G57089		181681	G56932	
172332	G57578		172990	G57543		181404	G57140		181685	G57051	
172333	G57577		181100	G57146		181405	G57088		181686	G56928	
172343	G57334		181101L	G57424		181405	G57139		181691L	G56991	
172344	G57333		181101R	G57425		181406	G57168		181691R	G56992	
172345	G57460		181103	G57413		181407	G57167		181920	G56935	
172346	G57459		181119L	G57220		181410	G57635		181924	G57013	
172390	G57370		181119R	G57221		181411	G57634		181925	G57014	
172391	G57369		181124	G57095		181417	G57059		181945	G56994	
172398L	G57415		181125	G57096		181426	G57031		181946	G56993	
172398R	G57414		181138	G57172		181427	G57030		181953	G56950	
172400L	G57428		181266	G56995		181433	G57050		181954	G56949	
172400R	G57429		181281	G56938		181433	G57522		182105	G57035	
172425	G57629		181291L	G56996		181434	G57049		182106	G57034	
172433	G57561		181291R	G56997		181434	G57521		182113	G57274	
172434	G57560		181292	G56998		181437	G57098		182114	G57115	
172448	G57126		181293	G57057		181438	G57097		182115	G57114	
172449	G57127		181293	G57058		181453	G57106		182123L	G57054	

Important Note: Competitive Interchanges are to be used for stocking purposes only. Where multiple crosses are identified, please reference the applications section of this catalog. / **Remarque importante:** Les interchanges concurrentiels ne s'utilisent qu'aux fins de stocks. Dans le cas de rfrences multiples, consulter la section des applications du catalogue. / **Nota importante:** Dans le cas de rfrences multiples, consulter la section des applications du catalogue. / **Nota importante:** Se pueden usar intercambios competitivos para propósitos de almacenamiento solamente. Cuando se identifican intercambios múltiples, consulte la sección de aplicaciones de este catálogo.

COMPETITIVE & O.E.M. INTERCHANGE LIST
Lista de Intercambios contra Competidores y Equipo Original.
Liste d'interchange de produits comptitifs & d'equipement original (OEM)

Advance AutoParts... cont'd

Advance autoparts	Gabriel	Upgrade	Advance autoparts	Gabriel	Upgrade	Advance autoparts	Gabriel	Upgrade	Advance autoparts	Gabriel	Upgrade
182123R	G57055		182379	G57200		282491	G57332		37149	G63783	
182130L	G57112		182392	G57161		282491	G57480		37151	G63803	
182130R	G57113		182393	G57162		282492	G57479		37152	G63675	
182138	G57271		182401	G57178		2882492	G57331		37156	G63869	
182143	G57085		182471L	G56924		32545	82032		37160	G63710	
182144	G57084		182471R	G56925		343143	82005		37161	G63847	
182174	G56951		182497L	G57416		343144	82001		37162	G63829	
182177	G57141		182497R	G57682		34504	81925		37183	G63832	
182179L	G57047		182509	G57267		34732	81821		37184	G63828	
182179R	G57048		182510	G57266		34761	81828		37187	82035	
182199	G57070		182518	G57109		34762	G63896		37197	G63506	
182199	G57122		182518	G57314		34787	G63615		37198	G63694	
182200	G57069		182526	G57198		34788	G63616		37199	69813	
182200	G57121		182527	G57197		34791	G63692		37203	G63844	
182203	G57099		182536	G57138		34828	G63510		37204	G63845	
182203	G57100		182537	G57137		34912	G63625		37206	G63958	
182205	G57077		189105	G57000		34919	G63411		37206	G64009	
182206	G57076		189105	G57023		37016	G63635		37217	69900	
182207	G57079		271102	G57646		37022	G63495		37219	G64049	
182208	G57078		271137L	G57454		37022	G63909		37220	G63905	
182209	G57111		271137R	G57453		37026	G63721		37225	G64027	
182209	G57536		271311	G57026		37029	G63419		37226	G64028	
182210	G57110		271453	G57350		37029	G63928		37231	G63720	
182210	G57535		271454	G57349		37030	81870		37237	69907	
182231	G57142		272213	G57587		37031	G63404		37241	G63842	
182236	G57372		272214	G57586		37033	G63548		37242	61717	
182237	G57373		272257	G57082		37044	G63488		37244	G63864	
182267	G57164		272258	G57081		37047	G63813		37251	G63878	
182268	G57163		272288	G57354		37047	G63902		37252	G63883	
182271	G57185		272289	G57353		37050	G63489		37253	G63875	
182281	G57149		272299	G57472		37065	G63426		372565	G57340	
182286	G57391		272300	G57471		37070	G63799		372566	G57339	
182287	G57390		272367	G57463		37073	G63492		37270	G63885	
182292	G57147		272368	G57464		37082	G63683		37270	G64029	
182295	G57131		272401	G57607		37091	G63413		37270	G64030	
182296	G57130		272408	G57071		37094	G63353		37272	70000	
182297	G57276		272408	G57072		37095	G63410		37273	G64031	
182298	G57275		272532	G57497		37095	G63414		37274	G64033	
182305	G57394		272533	G57498		37096	G63359		37275	69595	
182306	G57393		272534	G57495		37097	G63950		37276	69594	
182309	G57193		272535	G57496		37102	G63661		37279	G63889	
182310	G57192		272568	G57595		37104	G63673		37280	G64006	
182311	G57156		272569	G57594		37109	G63708		37281	G64032	
182311	G57277		272596	G57427		37112	G63689		37288	70010	
182321	G57324		272597	G57567		371130	G57466		37289	G64026	
182357	G57405		272598	G57566		371131	G57465		37290	G64042	
182358	G57404		272974	G57120		371139	G57173		37298	G64038	
182363	G57664		272975	G57119		37117	G63623		37302	G64037	
182363	G57666		281100	G57409		37121	G63490		37308	G64052	
182364	G57663		281952	G56948		37123	G63690		37313	G64056	
182364	G57665		282261	G57148		37130	G63609		37315	G64040	
182365	G57376		282275	G57205		37130	G63818		37318	G64047	
182366	G57375		282276	G57204		37134	G63715		37323	70078	
182367	G57177		282307	G57191		37135	G63722		37326	G51966	
182368	G57176		282308	G57190		37137	G63915		37907	G63511	
182378	G57201		282308	G57539		37146	G55821		39002	69996	

Important Note: Competitive Interchanges are to be used for stocking purposes only. Where multiple crosses are identified, please reference the applications section of this catalog. / **Remarque importante:** Les interchanges concurrentiels ne s'utilisent qu'aux fins de stocks. Dans le cas de références multiples, consulter la section des applications du catalogue. / **Nota importante:** Dans le cas de références multiples, consulter la section des applications du catalogue. / **Nota importante:** Se pueden usar intercambios competitivos para propósitos de almacenamiento solamente. Cuando se identifican intercambios múltiples, consulte la sección de aplicaciones de este catálogo.

COMPETITIVE & O.E.M. INTERCHANGE LIST
Lista de Intercambios contra Competidores y Equipo Original.
Liste d'interchange de produits compititifs & d'equipement original (OEM)

Advance AutoParts... cont'd

Advance autoparts	Gabriel	Upgrade	Advance autoparts	Gabriel	Upgrade	Advance autoparts	Gabriel	Upgrade	Advance autoparts	Gabriel	Upgrade
39004	69677		55S15360	G57422		5892	69811		59313	61533	
39006	69766		56000	81491		5893	69715		59313	61573	
39020	69952		56000	82075		59001	81318		59313	61629	
39027	70024		56001	81076		59002	81675		59316	61501	
39040	70040		56001	82104		59003	81147		59317	G63620	
39047	70033		56002	82090		59004	81825		59318	61552	
39051	G64046		56003	82128		59006	81394		59320	81871	
39102	69946		5601	70028		59007	81242		59321	61662	
39104	G51891		5607	70003		59011	81484		59322	61615	
39107	70034		5614	70013		59012	81482		59322	81548	
471128L	G57206		5615	70049		59013	81516		59323	61536	
471128R	G57206		5616	70045		59014	81936		59324	81937	
472526	G57550		5618	70039		59015	81549		59329	61601	
472527	G57549		5621	70036		59016	81478		59329	61679	
482401	G57607		5622	70037		59017	81676		59329	81836	
550018	69574		5626	70041		59017	82007		59330	61584	
55609	G51807		5639	70027		59024	81560		59330	81837	
55637	G51874		5751	82026		59025	81507		59331	61535	
55801	82099		5754	82138		59025	81553		59332	61590	
55801	82110		5756	82070		59026	81691		59332	61624	
55802	81492		5757	82060		59027	81583		59332	81890	
55803	81495		5759	82087		59028	81668		59333	61560	
55804	81494		5760	82609		59029	81667		59333	81904	
55809	82126		5762	82615		59031	81490		59338	61539	
55815	82601		5765	82118		59032	81710		59348	61556	
55818	81340		5766	82051		59034	81082		59353	61541	
55818	81440		5777	69585		59036	81744		59356	61575	
55818	82039		5778	69589		59037	81730		59358	61582	
55818	82155		5778	69590		59037	81917		59359	61605	
55820	81514		5779	69587		59038	81540		59359	81878	
55820	82602		5783	69592		59038	81905		59361	61608	
55831	81095		5783	69593		59038	81918		59362	G63782	
55864	69632		5784	69591		59041	81039		59363	G63781	
55867	81481		5796	69464		59042	81113		59364	61625	
55960	81446		5796	69465		59044	81164		59367	61510	
55965	69845		5799	70001		59045	81496		59368	61700	
55968	81794		5801	69625		59048	81914		59369	61699	
55984	81934		5803	69606		59049	81913		59371	81893	
55985	81935		5804	69600		59061	81920		59372	61504	
55S11351	G57037		5811	82011		59086	81541		59372	81750	
55S11352	G57038		5819	82004		59086	81713		59374	61616	
55S11373	G57363		5819	82069		59087	81582		59374	81929	
55S11374	G57364		5820	69724		59090	81726		59375	61512	
55S11493	G57337		5826	82025		5928	69757		59375	81559	
55S11494	G57338		5831	69624		59301	61529		59378	61658	
55S11663	G57222		5839	69795		59302	61531		59378	81923	
55S11664	G57223		5845	69755		59304	61506		59379	61626	
55S11861	G57335		5850	69622		59305	61509		59379	81916	
55S11862	G57336		5850	81880		59305	61555		59381	81924	
55S11903	G57564		58567	82156		59306	61500		59383	81910	
55S11904	G57565		58581	61544		59307	61508		59385	81911	
55S11973	G57517		58599	61656		59307	61593		59386	61664	
55S11974	G57518		58653	G64079		59309	61561		59386	81869	
55S15071	G57090		5867	69676		59309	61591		59387	61676	
55S15072	G57091		5868	69787		59311	61561		59387	81926	
55S15320	G57444		5892	69714		59312	61627		59398	61720	

Important Note: Competitive Interchanges are to be used for stocking purposes only. Where multiple crosses are identified, please reference the applications section of this catalog. / **Remarque importante:** Les interchanges concurrentiels ne s'utilisent qu'aux fins de stocks. Dans le cas de références multiples, consulter la section des applications du catalogue. / **Nota importante:** En el caso de referencias múltiples, consultar la sección de aplicaciones del catálogo. / **Nota importante:** Se pueden usar intercambios competitivos para propósitos de almacenamiento solamente. Cuando se identifican intercambios múltiples, consulte la sección de aplicaciones de este catálogo.

COMPETITIVE & O.E.M. INTERCHANGE LIST
Lista de Intercambios contra Competidores y Equipo Original.
Liste d'interchange de produits comptitifs & d'equipement original (OEM)

Advance AutoParts... cont'd

Advance autoparts	Gabriel	Upgrade	Advance autoparts	Gabriel	Upgrade	Advance autoparts	Gabriel	Upgrade	Advance autoparts	Gabriel	Upgrade
59400	61715		59625	61691		81407	G56640		82217	G52027	
59401	69909		59625	61692		81426	G56672		82218	G52026	
59402	61592		59626	81932		81427	G56671		82236	G56797	
5947	69725		5968	69898		81433	G56622		82237	G56798	
59501	81912		5971	69962		81434	G56621		82261	G51859	
59502	81892		5975	69901		81437	G55994		82263	G52006	
59503	61613		5980	69903		81438	G55993		82264	G52005	
59504	61612		5984	69945		81453	G56582		82267	G52009	
59505	61520		5987	69450		81454	G56581		82268	G52008	
59505	61546		5988	69863		81504	G56517		82275	G52007	
59512	61632		5989	69473		81505	G56516		82276	G52004	
59512	81091		5991	70020		81525	G56606		82295	G56887	
59517	61595		5993	69575		81565	G51267		82296	G56886	
59517	61646		5996	69420		81572	G56620		82378	G52095	
59519	61687		66415	G63918		81580	G55892		82379	G52094	
59520	61565		71111	G51758		81593	G56568		82392	G52121	
59523	61599		71128	G52131		81594	G56601		82393	G52122	
59525	61634		71138	G51860		81616	G55901		82518	G52125	
59528	61635		71139	G51861		81661	G55948		872526	G57323	
59542	61525		71141	G51864		81662	G55949		872527	G57322	
59544	61524		71321	G51722		81669	G55856		911039	G63456	
59547	81096		71322	G51724		81678	G56514		911228	G63879	
59548	81153		71327	G51727		81679	G56506		911228	G63882	
59549	61517		71332	69586		81680	G55676		911229	G63884	
59554	61521		71350	69998		81681	G55675		911259	G64016	
59560	82034		71358	G51715		81728	G56700		911261	G63870	
59561	61522		71361	G51704		81803	G55551		911262	G63867	
59562	61518		71362	G51703		81822	G56718		911267	G63888	
59567	61554		71441	G56688		81857	G55591		911277	G63890	
59571	82003		71442	G56687		81858	G55591		911277	G63891	
59574	61516		71665	G56929		81891	81891		911278	G64012	
59574	61519		71898	G51723		81897	G55820		911299	G64043	
59574	82147		72211	G56731		81951	G55999		911505	81922	
59577	61547		72212	G56730		81952	G55999		911508	G64000	
59578	81510		72257	G56837		81953	G55662		911527	G64001	
59582	61542		72258	G56836		81954	G55661		L3000063955ISG	G51738	
59583	61543		72311	G56899		81962	G55681		L30001338345ISG	G51765	
59586	61614		81100	G51815		81964	G55697		L3000569882MNR	G51728	
59588	61530		81256	G55804		81973	G55698		L3000569977MNR	G52082	
59589	61641		81281	G55825		82114	G56661		L3000569978MNR	G52081	
59591	61643		81293	G51087		82115	G56660		L3000570107MNR	G51714	
59592	61642		81340	G51700		82143	G56799		L3000570112MNR	G51842	
59592	81873		81341	G51718		82144	G56800		L3000654090ISG	G55896	
59592	81921		81348	G51477		82179	G56810		L3000654135ISG	G56758	
59596	61680		81352	G51077		82203	G56809		L3000654139ISG	G56759	
59597	61654		81371	G51739		82205	G56722		L3002569812MNR	G56965	
59598	61655		81373	G51736		82206	G56721		L4000654339ISG	81416	
5960	69675		81377	G56807		82207	G56729		L4000654464ISG	61704	
59614	61663		81404	G56540		82208	G56728				
59624	61712		81405	G56539		82209	G56774				
59624	81933		81406	G56641		82210	G56773				

Advance Mixer

Advance mixer	Gabriel	Upgrade	Advance mixer	Gabriel	Upgrade	Advance mixer	Gabriel	Upgrade	Advance mixer	Gabriel	Upgrade
12111 ADV	646155		13883	85334		14626 ADV	89414		85334	85334	
13424 ADV	83207	89407	13883 ADV	85334		23458 ADV	83112				
13424 ADV	89407		14626 ADV	83209	89414	680087	85334				

Important Note: Competitive Interchanges are to be used for stocking purposes only. Where multiple crosses are identified, please reference the applications section of this catalog. / **Remarque importante:** Les interchanges concurrentiels ne s'utilisent qu'aux fins de stocks. Dans le cas de références multiples, consulter la section des applications du catalogue. / **Nota importante:** Dans le cas de referencias multiples, consultar la sección de aplicaciones del catálogo. / **Nota importante:** Se pueden usar intercambios competitivos para propósitos de almacenamiento solamente. Cuando se identifican intercambios múltiples, consulte la sección de aplicaciones de este catálogo.

COMPETITIVE & O.E.M. INTERCHANGE LIST
Lista de Intercambios contra Competidores y Equipo Original.
Liste dinterchange de produits comptitifs & dquipement original (OEM)

Advance Mixer... cont'd

AL-KO

Al-ko	Gabriel	Upgrade	Al-ko	Gabriel	Upgrade	Al-ko	Gabriel	Upgrade	Al-ko	Gabriel	Upgrade
813000	G64079		813025	G64157		813033	G63847		813053	G63808	
813002	G64038		813026	G63817		813034	G63425		813054	G63607	
813007	G64001		813028	G51870		813035	G63403		813055	G63844	
813008	G51855		813028	G51891		813035	G63454		813057	G63882	
813009	G63886		813029	G51865		813036	G63818		813059	G64043	
813010	G63866		813030	G63347		813037	G63609		813061	G51728	
813011	G63783		813030	G63405		813038	G63489		813065	G64011	
813012	G63884		813030	G63413		813040	G63488		813070	G63778	
813013	G51864		813030	G63490		813045	G63715		813093	G56807	
813018	G63879		813030	G63907		813046	G64010		813099	G63624	
813021	G63888		813031	G63422		813048	G63829		813100	G63897	
813023	G63959		813031	G63638		813050	G63837		813107	G63918	
813024	G63803		813033	G63424		813051	G63809				

Allco Trailer

Allco trailer	Gabriel	Upgrade	Allco trailer	Gabriel	Upgrade	Allco trailer	Gabriel	Upgrade	Allco trailer	Gabriel	Upgrade
727602	83122	89406	727602	89406							

Alliance

Alliance	Gabriel	Upgrade	Alliance	Gabriel	Upgrade	Alliance	Gabriel	Upgrade	Alliance	Gabriel	Upgrade
ABP N32 G900001	85724	89443	ABP N32 G900024	85901		ABP N32 G900056	83126	89430	ABP N32 G900094	85084	89460
ABP N32 G900001	89443		ABP N32 G900025	83017		ABP N32 G900056	89430		ABP N32 G900094	89460	
ABP N32 G900002	83203	89436	ABP N32 G900027	85331		ABP N32 G900058	85936	89456	ABP N32 O900001	85724	89443
ABP N32 G900002	89436		ABP N32 G900028	85000	89436	ABP N32 G900058	89456		ABP N32 O900001	89443	
ABP N32 G900003	85918	89449	ABP N32 G900028	89436		ABP N32 G900061	85072		ABP N32 O900002	83203	89436
ABP N32 G900003	89449		ABP N32 G900030	83127		ABP N32 G900063	83031		ABP N32 O900002	89436	
ABP N32 G900004	85320	89429	ABP N32 G900031	85311	89424	ABP N32 G900068	85047	89435	ABP N32 O900003	85918	89449
ABP N32 G900004	89429		ABP N32 G900031	89424		ABP N32 G900068	89435		ABP N32 O900003	89449	
ABP N32 G900005	85001	89410	ABP N32 G900032	85066	89448	ABP N32 G900069	83147		ABP N32 O900004	85320	89429
ABP N32 G900005	89410		ABP N32 G900032	89448		ABP N32 G900071	83112		ABP N32 O900004	89429	
ABP N32 G900006	83456	89447	ABP N32 G900033	85023	89415	ABP N32 G900072	85656		ABP N32 O900005	85001	89410
ABP N32 G900006	89447		ABP N32 G900033	89415		ABP N32 G900073	85058	89431	ABP N32 O900005	89410	
ABP N32 G900007	83125		ABP N32 G900034	85310	89423	ABP N32 G900073	89431		ABP N32 O900006	83456	89447
ABP N32 G900008	83001		ABP N32 G900034	89423		ABP N32 G900074	85933	89454	ABP N32 O900006	89447	
ABP N32 G900009	85006		ABP N32 G900035	85924	89457	ABP N32 G900074	89454		ABP N32 O900007	83125	
ABP N32 G900010	85013	89414	ABP N32 G900035	89457		ABP N32 G900075	85919		ABP N32 O900008	83001	
ABP N32 G900010	89414		ABP N32 G900036	83124	89407	ABP N32 G900076	85012	89413	ABP N32 O900009	85006	
ABP N32 G900011	85323	89436	ABP N32 G900036	89407		ABP N32 G900076	89413		ABP N32 O900010	85013	89414
ABP N32 G900011	89436		ABP N32 G900037	85052		ABP N32 G900077	85958		ABP N32 O900010	89414	
ABP N32 G900012	83038		ABP N32 G900038	85069	89455	ABP N32 G900078	85088		ABP N32 O900011	85323	89436
ABP N32 G900013	85931	89458	ABP N32 G900038	89455		ABP N32 G900079	85934		ABP N32 O900011	89436	
ABP N32 G900013	89458		ABP N32 G900039	85033	89427	ABP N32 G900080	85061	89450	ABP N32 O900012	83038	
ABP N32 G900014	83009		ABP N32 G900039	89427		ABP N32 G900081	85920	89503	ABP N32 O900013	85931	89458
ABP N32 G900015	83128	89436	ABP N32 G900040	85061	89450	ABP N32 G900081	89503		ABP N32 O900013	89458	
ABP N32 G900015	89436		ABP N32 G900041	85937		ABP N32 G900082	85738		ABP N32 O900014	83009	
ABP N32 G900016	85319	89428	ABP N32 G900043	85316	89426	ABP N32 G900083	85029		ABP N32 O900015	83128	89436
ABP N32 G900016	89428		ABP N32 G900043	89426		ABP N32 G900085	83207	89407	ABP N32 O900015	89436	
ABP N32 G900017	85736		ABP N32 G900044	85954		ABP N32 G900085	89407		ABP N32 O900016	85319	89428
ABP N32 G900018	83021		ABP N32 G900046	85045		ABP N32 G900086	85064		ABP N32 O900016	89428	
ABP N32 G900019	85062	89408	ABP N32 G900047	85900		ABP N32 G900087	85030	89440	ABP N32 O900017	85736	
ABP N32 G900019	89408		ABP N32 G900049	85957		ABP N32 G900087	89440		ABP N32 O900018	83021	
ABP N32 G900020	85067	89451	ABP N32 G900050	83135		ABP N32 G900088	83035		ABP N32 O900019	85062	89408
ABP N32 G900020	89451		ABP N32 G900051	83317		ABP N32 G900089	85932	89453	ABP N32 O900019	89408	
ABP N32 G900021	85070	89459	ABP N32 G900053	85938		ABP N32 G900089	89453				
ABP N32 G900021	89459		ABP N32 G900054	85005	89430	ABP N32 G900090	85053	89442			
ABP N32 G900022	85003	89411	ABP N32 G900054	89430		ABP N32 G900090	89442				
ABP N32 G900022	89411		ABP N32 G900055	83008		ABP N32 G900091	83396				

Important Note: Competitive Interchanges are to be used for stocking purposes only. Where multiple crosses are identified, please reference the applications section of this catalog. / **Remarque importante:** Les interchanges concurrentiels ne s'utilisent qu'aux fins de stocks. Dans le cas de rferences multiples, consulter la section des applications du catalogue. / **Nota importante:** Dans le cas de rferences multiples, consulter la section des applications du catalogue. / **Nota importante:** Se pueden usar intercambios competitivos para propósitos de almacenamiento solamente. Cuando se identifican intercambios múltiples, consulte la sección de aplicaciones de este catálogo.

COMPETITIVE & O.E.M. INTERCHANGE LIST

Lista de Intercambios contra Competidores y Equipo Original.

Liste d'interchange de produits compétitifs & d'équipement original (OEM)

Alliance... cont'd

Alliance	Gabriel	Upgrade	Alliance	Gabriel	Upgrade	Alliance	Gabriel	Upgrade	Alliance	Gabriel	Upgrade
ABP N32 O900020	85067	89451	ABP N32 O900035	85924	89457	ABP N32 O900054	89430		ABP N32 O900078	85088	
ABP N32 O900020	89451		ABP N32 O900035	89457		ABP N32 O900055	83008		ABP N32 O900079	85934	
ABP N32 O900021	85070	89459	ABP N32 O900036	83124	89407	ABP N32 O900056	83126	89430	ABP N32 O900080	85061	89450
ABP N32 O900022	89459		ABP N32 O900036	89407		ABP N32 O900056	89430		ABP N32 O900081	85920	89503
ABP N32 O900022	85003	89411	ABP N32 O900037	85052		ABP N32 O900058	85936	89456	ABP N32 O900081	89503	
ABP N32 O900022	89411		ABP N32 O900038	85069	89455	ABP N32 O900058	89456		ABP N32 O900082	85738	
ABP N32 O900024	85901		ABP N32 O900038	89455		ABP N32 O900061	85072		ABP N32 O900083	85029	
ABP N32 O900025	83017		ABP N32 O900039	85033	89427	ABP N32 O900063	83031		ABP N32 O900084	85959	
ABP N32 O900027	85331		ABP N32 O900039	89427		ABP N32 O900068	85047	89435	ABP N32 O900085	83207	89407
ABP N32 O900028	85000	89436	ABP N32 O900040	85061	89450	ABP N32 O900068	89435		ABP N32 O900085	89407	
ABP N32 O900028	89436		ABP N32 O900041	85937		ABP N32 O900069	83147		ABP N32 O900086	85064	
ABP N32 O900029	646155		ABP N32 O900043	85316	89426	ABP N32 O900071	83112		ABP N32 O900087	85030	89440
ABP N32 O900030	83127		ABP N32 O900043	89426		ABP N32 O900072	85656		ABP N32 O900087	89440	
ABP N32 O900031	85311	89424	ABP N32 O900044	85954		ABP N32 O900073	85058	89431	ABP N32 O900088	83035	
ABP N32 O900031	89424		ABP N32 O900046	85045		ABP N32 O900073	89431		ABP N32 O900089	85932	89453
ABP N32 O900032	85066	89448	ABP N32 O900047	85900		ABP N32 O900074	85933	89454	ABP N32 O900089	89453	
ABP N32 O900032	89448		ABP N32 O900049	85957		ABP N32 O900074	89454		ABP N32 O900090	85053	89442
ABP N32 O900033	85023	89415	ABP N32 O900050	83135		ABP N32 O900075	85919		ABP N32 O900090	89442	
ABP N32 O900033	89415		ABP N32 O900051	83317		ABP N32 O900076	85012	89413	ABP N32 O900091	83396	
ABP N32 O900034	85310	89423	ABP N32 O900053	85938		ABP N32 O900076	89413		ABP N32 O900092	83163	
ABP N32 O900034	89423		ABP N32 O900054	85005	89430	ABP N32 O900077	85958		ABP N32 O900093	83137	

AM General

Am general	Gabriel	Upgrade	Am general	Gabriel	Upgrade	Am general	Gabriel	Upgrade	Am general	Gabriel	Upgrade
3166657	85700		5957136	85700		5979484	85302	89420	5982537	85700	
4975501	85700		5969438	85700		5979484	89420				
5565748	85700		5978712	85700		5979574	85700				

Aralmex

Aralmex	Gabriel	Upgrade	Aralmex	Gabriel	Upgrade	Aralmex	Gabriel	Upgrade	Aralmex	Gabriel	Upgrade
2AMG037	G63375		3AMG007	G63357		3AMG027	G63426		3AMG034	G63608	
3AMG001	G63355		3AMG021	G63409		3AMG029	G63488		3AMG035	G63607	
3AMG004	G63306		3AMG022	G63454		3AMG030	G63818				
3AMG005	G63359		3AMG023	G63421		3AMG031	G63360				
3AMG006	G63377		3AMG026	G63455		3AMG033	G63614				

Arvin Meritor

Arvin meritor	Gabriel	Upgrade	Arvin meritor	Gabriel	Upgrade	Arvin meritor	Gabriel	Upgrade	Arvin meritor	Gabriel	Upgrade
085009	85009		680102	85712		727619	83219		728611	85307	
085014	85014		680322	85704		727625	83225		728612	85308	89422
085321	85321		680331	85702		727628	83301		728612	89422	
654907	85000	89436	680337	85708		727630	83303		728614	85310	89423
654907	89436		680347	85732		727635	83308		728614	89423	
654958	83164		680464	85005	89430	727636	83309		728615	85311	89424
665044	83209	89414	680464	89430		727639	83312	89409	728615	89424	
665044	89414		680518	85700		727639	89409		728616	85004	
665724	85000	89436	680584	85938		727641	83314		728617	85005	89430
665724	89436		680671	85708		727645	83318		728617	89430	
665746	85000	89436	695180	85705	89447	727671	83613		728618	85006	
665746	89436		695180	89447		727672	83242		728619	85007	
665760	85045		695214	85722		728601	85001	89410	728621	85009	
665769	85052		695348	87018		728601	89410		728622	85010	
665804	85939		727600	89402		728603	85003	89411	728624	85012	89413
671091	85069	89455	727607	83207	89407	728603	89411		728624	89413	
671091	89455		727607	89407		728604	85300	89419	728625	85013	89414
671092	85012	89413	727609	83209	89414	728604	89419		728625	89414	
671092	89413		727609	89414		728606	85302	89420			
671507	87015		727614	83214		728606	89420				
671707	85323	89436	727615	83215		728608	85304				
671707	89436		727616	83216		728609	85305				

Important Note: Competitive Interchanges are to be used for stocking purposes only. Where multiple crosses are identified, please reference the applications section of this catalog. / **Remarque importante:** Les interchanges concurrentiels ne s'utilisent qu'aux fins de stocks. Dans le cas de références multiples, consulter la section des applications du catalogue. / **Nota importante:** Dans le cas de referencias multiples, consultar la sección de aplicaciones del catálogo. / **Nota importante:** Se pueden usar intercambios competitivos para propósitos de almacenamiento solamente. Cuando se identifican intercambios múltiples, consulte la sección de aplicaciones de este catálogo.

COMPETITIVE & O.E.M. INTERCHANGE LIST
Lista de Intercambios contra Competidores y Equipo Original.
Liste dinterchange de produits comptitifs & dquipement original (OEM)

Arvin Meritor... cont'd

Arvin meritor	Gabriel	Upgrade	Arvin meritor	Gabriel	Upgrade	Arvin meritor	Gabriel	Upgrade	Arvin meritor	Gabriel	Upgrade
728628	85314	89425	728632	89440		728800	85711		7805-N-1002	85329	
728628	89425		728635	85318		728806	85736		7805-S-1007	85329	
728631	85029		728639	85026		728812	85705	89447	7805N1002	85329	
728632	85030	89440	728640	85027		728812	89447		7805S1007	85329	

Aurora Parts and Service

Aurora parts and service	Gabriel	Upgrade	Aurora parts and service	Gabriel	Upgrade	Aurora parts and service	Gabriel	Upgrade	Aurora parts and service	Gabriel	Upgrade
PROSH85724	85724	89443									

Autocar LLC.

Autocar llc.	Gabriel	Upgrade	Autocar llc.	Gabriel	Upgrade	Autocar llc.	Gabriel	Upgrade	Autocar llc.	Gabriel	Upgrade
03-1106460	85005	89430	60657-003L	85072		60670005L	83137		660186	83216	
03-1106460	89430		60657003	85072		60675-003	85976		727602	83122	89406
031106460	85005	89430	60657003L	85072		60675-003L	85976		727602	89406	
031106460	89430		60665-011	85967		60675003	85976		800670	85060	
1011839	83216		60665-013	85965		60675003L	85976		800781	85314	89425
28CFG-910	83216		60665-025	85036	89405	60680-003	83112		800781	89425	
28CFG-910Z	83216		60665-025	89405		60680-003L	83112		8026658	85046	89434
28CFG910	83216		60665-025L	85036	89405	60680-004	83143		8026658	89434	
28CFG910Z	83216		60665-025L	89405		60680-004L	83143		8071524	85024	
28R010	83216		60665011	85967		60680-005	83142		849246	83216	
35901-3201	85024		60665013	85965		60680-005L	83142		A3591004-001	85072	
359013201	85024		60665025	85036	89405	60680003	83112		A3591004001	85072	
37301-3201	85027		60665025	89405		60680003L	83112		A3711405-001	85908	
37301-3202	85026		60665025L	85036	89405	60680004	83143		A3711405001	85908	
373013201	85027		60665025L	89405		60680004L	83143		A3730008-001	85086	
373013202	85026		60670-005	83137		60680005	83142		A3730008001	85086	
3946210	83103		60670-005L	83137		60680005L	83142				
60657-003	85072		60670005	83137		65458PS	85908				

AUTOMANN

Automann	Gabriel	Upgrade	Automann	Gabriel	Upgrade	Automann	Gabriel	Upgrade	Automann	Gabriel	Upgrade
A646155	646155		A83128	83128	89436	A83905	83905		A85064	85064	
A646177	646177		A83130	83130		A83906	83906		A85065	85065	
A665937	665937		A83131	83131		A83907	83907		A85066	85066	89448
A83021	83021		A83134	83134		A83908	83908		A85067	85067	89451
A83023	83023		A83135	83135		A83911	83911		A85069	85069	89455
A83024	83024		A83136	83136		A85000	85000	89436	A85070	85070	89459
A83025	83025		A83137	83137		A85001	85001	89410	A85072	85072	
A83026	83026		A83140	83140		A85003	85003	89411	A85081	85081	
A83028	83028		A83142	83142		A85005	85005	89430	A85084	85084	89460
A83029	83029		A83143	83143		A85006	85006		A85086	85086	
A83030	83030		A83144	83144		A85012	85012	89413	A85088	85088	
A83031	83031		A83147	83147		A85013	85013	89414	A85109	85109	
A83038	83038		A83150	83150		A85014	85014		A85119	85119	
A83039	83039		A83163	83163		A85023	85023	89415	A85188	85188	
A83040	83040		A83166	83166		A85026	85026		A85303	85303	89422
A83045	83045		A83169	83169		A85029	85029		A85308	85308	89422
A83048	83048		A83175	83175		A85030	85030	89440	A85310	85310	89423
A83049	83049		A83203	83203	89436	A85033	85033	89427	A85311	85311	89424
A83051	83051		A83207	83207	89407	A85036	85036	89405	A85316	85316	89426
A83053	83053		A83209	83209	89414	A85045	85045		A85319	85319	89428
A83054	83054		A83215	83215		A85046	85046	89434	A85320	85320	89429
A83066	83066		A83312	83312	89409	A85052	85052		A85323	85323	89436
A83081	83081		A83317	83317		A85055	85055	89439	A85338	85338	
A83101	83101		A83364	83364		A85058	85058	89431	A85345	85345	
A83103	83103		A83391	83391		A85060	85060				
A83112	83112		A83395	83395		A85061	85061	89450			
A83123	83123	89405	A83396	83396		A85062	85062	89408			
A83125	83125		A83456	83456	89447	A85063	85063				

Important Note: Competitive Interchanges are to be used for stocking purposes only. Where multiple crosses are identified, please reference the applications section of this catalog. / **Remarque importante:** Les interchanges concurrentiels ne s'utilisent qu'aux fins de stocks. Dans le cas de rferences multiples, consulter la section des applications du catalogue. / **Nota importante:** Dans le cas de rferences multiples, consulter la section des applications du catalogue. / **Nota importante:** Se pueden usar intercambios competitivos para propósitos de almacenamiento solamente. Cuando se identifican intercambios múltiples, consulte la sección de aplicaciones de este catálogo.

COMPETITIVE & O.E.M. INTERCHANGE LIST
Lista de Intercambios contra Competidores y Equipo Original.
Liste d'interchange de produits complitifs & d'equipement original (OEM)

AUTOMANN... cont'd

Automann	Gabriel	Upgrade	Automann	Gabriel	Upgrade	Automann	Gabriel	Upgrade	Automann	Gabriel	Upgrade
A85639	85639		A85931	85931	89458	A85976	85976		A89426		89426
A85642	85642		A85934	85934		A85977	85977		A89427		89427
A85724	85724	89443	A85936	85936	89456	A85979	85979		A89436		89436
A85738	85738		A85937	85937		A85989	85989		A89443		89443
A85739	85739		A85938	85938		A85994	85994		A89451		89451
A85900	85900		A85939	85939		A85995	85995		A89455		89455
A85909	85909		A85954	85954		A86200	86200		A89460		89460
A85918	85918	89449	A85956	85956		A89407	89407		A89503		89503
A85920	85920	89503	A85957	85957		A89408	89408		A90131		83062
A85923	85923	89458	A85958	85958		A89410	89410		A99605		85109
A85924	85924	89457	A85959	85959		A89411	89411		A99769		83081
A85927	85927		A85964	85964		A89414	89414		AG63809		G63809
A85928	85928		A85967	85967		A89423	89423				
A85929	85929		A85972	85972		A89424	89424				

Autopart International

Autopart international	Gabriel	Upgrade	Autopart international	Gabriel	Upgrade	Autopart international	Gabriel	Upgrade	Autopart international	Gabriel	Upgrade
2701-08486	G56620		2701-248145	G63892		2701-248214	70028		2701-248732		G57060
2701-08487	G56509		2701-248146	G64016		2701-248219	G63889		2701-248734		G57064
2701-08598	G56635		2701-248149	G51724		2701-248219	G64006		2701-248735		G56928
2701-08987	G56636		2701-248150	G51704		2701-248222	G51739		2701-248736		G57063
2701-08995	M56501		2701-248151	G51722		2701-248223	G63885		2701-248739		G56957
2701-204603	69813		2701-248152	G51719		2701-248223	G64029		2701-248740		G56956
2701-204605	81921		2701-248153	G51729		2701-248223	G64030		2701-248742		G56951
2701-204606	69996		2701-248154	81913		2701-248224	G56561		2701-248751		G56938
2701-204608	81730		2701-248155	G63870		2701-248225	G56759		2701-248755		G56949
2701-204608	81891		2701-248156	G63867		2701-248226	G56758		2701-248756		G56950
2701-204608	81917		2701-248156	G64157		2701-248228	G56601		2701-248757		G57010
2701-204609	69766		2701-248157	G63607		2701-248230	G56568		2701-248758		G56992
2701-204611	G63781		2701-248158	G63837		2701-248233	G56655		2701-248759		G57039
2701-204612	G63455		2701-248159	G51703		2701-248236	G51718		2701-255680		G51714
2701-204612	G63717		2701-248163	G63692		2701-248247	G56562		2701-256870		G56998
2701-204625	G52336		2701-248164	G63842		2701-248250	G51728		2701-256871		G56943
2701-204626	G52335		2701-248165	G63884		2701-248273	G52009		2701-256875		G56964
2701-204627	G56514		2701-248166	G63882		2701-248274	G52008		2701-256892		G56994
2701-204628	G56506		2701-248168	G51850		2701-248275	G52033		2701-256893		G56993
2701-204643	G56633		2701-248172	G63879		2701-248276	G52032		2701-256894		G56948
2701-204644	G56634		2701-248173	G63896		2701-248283	G56661		2701-256895		G56948
2701-204645	G56802		2701-248174	G64015		2701-248286	G56722		2701-256905		G56995
2701-204646	G56606		2701-248175	G63893		2701-248287	G56660		2701-256908		G57057
2701-204651	G56537		2701-248176	81930		2701-248288	G52014		2701-256908		G57058
2701-204652	G56538		2701-248177	G63894		2701-248295	G52098		2701-258033		G56729
2701-204653	G56672		2701-248179	G51858		2701-248300	G56721		2701-25896		G56933
2701-204654	G56671		2701-248180	G64000		2701-248301	G56680		2701-259996		G56931
2701-204657	81495		2701-248182	69907		2701-248302	G56679		2701-259997		G56930
2701-204663	81919		2701-248185	G51814		2701-248303	G56581		2701-259998		G56933
2701-204665	M55896		2701-248186	G51813		2701-248304	G56582		2701-259999		G56932
2701-233579	6828SE		2701-248190	G56807		2701-248306	G52013		2701-275042		G56991
2701-233580	6854SE		2701-248191	G63844		2701-248307	G56728		2701-276991		G56802
2701-233597	6847SE		2701-248192	G64032		2701-248309	G52107		2701-277361		70040
2701-239525	49255		2701-248197	G63864		2701-248309	G56797		2701-287484		G57051
2701-24308	G52108		2701-248202	G51715		2701-248726	G56962		2701-288156		69901
2701-24308	G56798		2701-248203	G51798		2701-248727	G56963		2701-288911		G52111
2701-248127	G51738		2701-248204	G51802		2701-248728	G56936		2701-288912		G52110
2701-248136	G63962		2701-248205	G51803		2701-248729	G56927				
2701-248137	81932		2701-248206	G63883		2701-248730	G56934				
2701-248142	81933		2701-248207	G63878		2701-248730	G56937				
2701-248144	G63958		2701-248210	G63815		2701-248731	G56935				

Important Note: Competitive Interchanges are to be used for stocking purposes only. Where multiple crosses are identified, please reference the applications section of this catalog. / **Remarque importante:** Les interchanges concurrentiels ne s'utilisent qu'aux fins de stocks. Dans le cas de références multiples, consulter la section des applications du catalogue. / **Nota importante:** Dans le cas de referencias multiples, consultar la sección de aplicaciones del catálogo. / **Nota importante:** Se pueden usar intercambios competitivos para propósitos de almacenamiento solamente. Cuando se identifican intercambios múltiples, consulte la sección de aplicaciones de este catálogo.

COMPETITIVE & O.E.M. INTERCHANGE LIST
Lista de Intercambios contra Competidores y Equipo Original.
Liste d'interchange de produits compititifs & d'equipement original (OEM)

Autopart International... cont'd

Autopart international	Gabriel	Upgrade	Autopart international	Gabriel	Upgrade	Autopart international	Gabriel	Upgrade	Autopart international	Gabriel	Upgrade
2701-289571	G64003		2701-412077	70086		2701-423383	G51937		2701-423932	G64047	
2701-289578	G57011		2701-412078	G63872		2701-423394	G51920		2701-423933	G64056	
2701-289579	G57012		2701-412081	G56839		2701-423395	G51921		2701-423937	69966	
2701-289580	G57017		2701-412084	G56598		2701-423408	G51832		2701-424130	G511004	
2701-289581	G57018		2701-412085	G52275		2701-423409	G51833		2701-424138	G64052	
2701-289582	G57022		2701-412086	G52274		2701-423413	G64037		2701-424142	G63615	
2701-289583	G57020		2701-412088	G63799		2701-423414	G64111		2701-424143	G63694	
2701-289584	G57021		2701-412093	G56773		2701-423427	G52265		2701-424152	G63971	
2701-289585	G57015		2701-412094	G56774		2701-423428	G52264		2701-424153	G64043	
2701-289586	G57016		2701-412095	G52027		2701-423454	G51911		2701-424155	G64001	
2701-289587	G57019		2701-412096	G52026		2701-423456	G52250		2701-424156	G63965	
2701-289588	G57007		2701-412097	G56820		2701-423457	G52249		2701-424157	G63866	
2701-289589	G57008		2701-412098	G56819		2701-423458	G52188		2701-424158	G63959	
2701-289591	G57013		2701-412099	G56821		2701-423459	G52187		2701-424171	G52184	
2701-289592	G57014		2701-412100	G56822		2701-423462	G51919		2701-424173	G51908	
2701-312896	70010		2701-412101	G52141		2701-423465	G51966		2701-424175	G51883	
2701-313021	G51736		2701-412102	G52140		2701-423485	G51905		2701-424182	G52185	
2701-313757	G51758		2701-412103	G52007		2701-423486	70060		2701-424183	G52168	
2701-314376	G51838		2701-412104	G52004		2701-423487	G52282		2701-424189	G52169	
2701-314377	G51716		2701-412109	G52275		2701-423488	G52283		2701-424199	G56735	
2701-314381	G51805		2701-412110	G52274		2701-423489	G51880		2701-424200	G56734	
2701-314386	G56843		2701-412115	G52095		2701-423490	G52150		2701-424201	G56733	
2701-314387	G56842		2701-412116	G52094		2701-423491	G52151		2701-424202	G56732	
2701-316357	G56641		2701-412117	G52097		2701-423493	G52153		2701-424206	G64042	
2701-316359	G56640		2701-412118	G52096		2701-423494	G52152		2701-424210	G52281	
2701-316364	G56809		2701-412127	G56894		2701-423495	G52254		2701-424211	G52280	
2701-316365	G56809		2701-412128	G56899		2701-423496	G52253		2701-424212	G52396	
2701-316366	G52006		2701-412131	G51910		2701-423497	G51878		2701-424213	G52395	
2701-316367	G52005		2701-412138	G56929		2701-423498	G51877		2701-424214	G52176	
2701-316368	70003		2701-412139	G57065		2701-423499	G51892		2701-424215	G52175	
2701-316369	G51727		2701-412140	G57066		2701-423500	G51879		2701-424216	G56778	
2701-316657	G57026		2701-412141	G57034		2701-423504	G51925		2701-424222	G52300	
2701-321054	G52164		2701-412142	G57035		2701-423505	G51926		2701-424223	G52299	
2701-321057	G52165		2701-412146	G57045		2701-423607	G57010		2701-42423	G51815	
2701-321278	G57031		2701-412147	G57046		2701-423798	70089		2701-424238	G52131	
2701-321279	G57030		2701-412150	G56680		2701-423799	G52122		2701-424239	G52118	
2701-322040	G56799		2701-412150	G56731		2701-423800	G52121		2701-424240	G52117	
2701-322041	G56800		2701-412151	G56679		2701-423804	G51766		2701-424241	G52149	
2701-335085	G51804		2701-412151	G56730		2701-423807	70041		2701-424242	G52148	
2701-335087	G51842		2701-421772	G56838		2701-423816	G52174		2701-424244	G51856	
2701-335090	G52082		2701-421773	70027		2701-423817	G52173		2701-424249	G51852	
2701-335091	G52081		2701-423311	G64087		2701-423821	G64050		2701-424251	G51847	
2701-412058	G56616		2701-423312	G63832		2701-423833	G63813		2701-424252	G51848	
2701-412058	G56688		2701-423313	G63828		2701-423835	G63909		2701-42433	G51795	
2701-412059	G56615		2701-423314	70053		2701-423883	G64048		2701-424374	G52113	
2701-412059	G56687		2701-423333	G52204		2701-423884	70036		2701-424375	G52112	
2701-412060	G51799		2701-423334	G52203		2701-423885	70036		2701-424378	G51807	
2701-412061	70013		2701-423335	G52202		2701-423886	70037		2701-424381	G56687	
2701-412062	70039		2701-423336	G52201		2701-423887	G64071		2701-424384	G511055	
2701-412063	G51783		2701-423338	G51477		2701-423896	G52155		2701-424385	G56688	
2701-412067	69450		2701-423339	G52332		2701-423919	81916		2701-424386	G52237	
2701-412068	G64027		2701-423340	G52331		2701-423921	70045		2701-424388	G52238	
2701-412069	G64026		2701-423356	G64038		2701-423922	G51097		2701-424389	69998	
2701-412070	69901		2701-423357	G51855		2701-423924	70034		2701-42456	G51904	
2701-412070	70040		2701-423359	G52103		2701-423928	G64046		2701-424576	G511054	
2701-412075	70000		2701-423360	G52104		2701-423930	69952		2701-424577	70078	

Important Note: Competitive Interchanges are to be used for stocking purposes only. Where multiple crosses are identified, please reference the applications section of this catalog. / **Remarque importante:** Les interchanges concurrentiels ne s'utilisent qu'aux fins de stocks. Dans le cas de rfrences multiples, consulter la section des applications du catalogue. / **Nota importante:** Dans le cas de rfrences multiples, consultar la section des aplicaciones du catalogue. / **Nota importante:** Se pueden usar intercambios competitivos para propósitos de almacenamiento solamente. Cuando se identifican intercambios múltiples, consulte la sección de aplicaciones de este catálogo.

COMPETITIVE & O.E.M. INTERCHANGE LIST
Lista de Intercambios contra Competidores y Equipo Original.
Liste d'interchange de produits complitifs & d'equipement original (OEM)

Autopart International... cont'd

Autopart international	Gabriel	Upgrade	Autopart international	Gabriel	Upgrade	Autopart international	Gabriel	Upgrade	Autopart international	Gabriel	Upgrade
2701-424592	G56841		2701-460106	G51961		2701-480324	G57160		2701-511828	G57083	
2701-424593	G56840		2701-460124	G52142		2701-480325	G57084		2701-511860	G52128	
2701-424656	G56836		2701-460125	G52143		2701-480326	G57085		2701-511865	G52127	
2701-424657	G56837		2701-460134	G52145		2701-482228	G52125		2701-514598	G57205	
2701-424669	G51896		2701-460135	G52144		2701-497098	G57042		2701-518672	G52440	
2701-424670	G51897		2701-460147	G52209		2701-497099	G57041		2701-518673	G52439	
2701-424672	G63873		2701-460148	G52210		2701-499609	G57103		2701-522613	G52257	
2701-424682	G63808		2701-460149	G52260		2701-499610	G57132		2701-522614	G52170	
2701-424893	G63674		2701-460150	G52261		2701-501868	G57043		2701-522615	G52171	
2701-424895	G64028		2701-460153	G56791		2701-501869	G57044		2701-524158	G57206	
2701-424957	G55772		2701-460153	G56792		2701-502744	G57112		2701-524520	G57167	
2701-425023	G52018		2701-460155	G51849		2701-502745	G57113		2701-524521	G57168	
2701-425024	G52017		2701-460156	G52161		2701-502748	G57088		2701-524525	G57097	
2701-425025	G56893		2701-460157	G52160		2701-502749	G57089		2701-524526	G57098	
2701-425026	G56892		2701-460158	G52248		2701-502750	G57142		2701-524543	G57141	
2701-425029	G52036		2701-460159	G52247		2701-502752	G57162		2701-524568	G57156	
2701-425030	G52037		2701-460166	G52130		2701-502755	G57078		2701-524587	G57030	
2701-425032	G51982		2701-460167	G52129		2701-502756	G57079		2701-524588	G57031	
2701-425041	G51920		2701-460170	G52163		2701-502757	G57099		2701-524606	G57081	
2701-425042	G51921		2701-460171	G52162		2701-502757	G57100		2701-524607	G57082	
2701-425048	G51922		2701-460180	G51860		2701-502758	G57110		2701-52546	G57139	
2701-425061	G51773		2701-460181	G51861		2701-502759	G57111		2701-52547	G57140	
2701-425102	70098		2701-460182	G51865		2701-502760	G57059		2701-527288	G52314	
2701-425231	G56997		2701-460183	G51864		2701-502761	G57114		2701-527293	G52314	
2701-425232	G56996		2701-460184	70049		2701-502762	G57115		2701-528206	G51856	
2701-42955	G51794		2701-460185	G52154		2701-502763	G57172		2701-528382	G52361	
2701-429941	G57121		2701-479132	G57049		2701-502823	G52406		2701-528383	G52360	
2701-429942	G57122		2701-479133	G57033		2701-502832	70096		2701-528400	70068	
2701-460054	70033		2701-479133	G57062		2701-502834	G52399		2701-528877	G52525	
2701-460056	70065		2701-479134	G57032		2701-502835	G52398		2701-528878	G52524	
2701-460062	70056		2701-479134	G57061		2701-502974	G51825		2701-528879	G52355	
2701-460066	69464		2701-479137	G57050		2701-502975	G51774		2701-528880	G52356	
2701-460066	81935		2701-480154	G57076		2701-502980	G52294		2701-536290	G57203	
2701-460067	70052		2701-480155	G57077		2701-502981	G52293		2701-536292	G57202	
2701-460070	G63886		2701-480158	G57053		2701-502982	G51933		2701-536646	G57163	
2701-460070	G63969		2701-480161	G57036		2701-503072	G51863		2701-536647	G57164	
2701-460071	G63969		2701-480166	G57086		2701-503789	G52352		2701-539565	G57131	
2701-460072	G63969		2701-480167	G57087		2701-503790	G52351		2701-539566	G57130	
2701-460073	G64010		2701-480168	G57092		2701-503836	G51881		2701-539572	G57178	
2701-460074	G63622		2701-480169	G57096		2701-505582	G52375		2701-539575	G57138	
2701-460075	G64079		2701-480170	G57125		2701-505603	G52349		2701-539576	G57137	
2701-460077	G63888		2701-480172	G57118		2701-507604	G52348		2701-541592	G57091	
2701-460081	70031		2701-480173	G57123		2701-507605	G52301		2701-541593	G57090	
2701-460082	G64040		2701-480174	G57124		2701-507608	G51928		2701-541594	G57106	
2701-460085	70095		2701-480175	G57095		2701-507609	G51993		2701-541595	G57105	
2701-460086	G51746		2701-480176	G57133		2701-507707	G52105		2701-541599	G57204	
2701-460086	G51806		2701-480177	G57134		2701-507708	G52106		2701-547832	G64031	
2701-460089	G52116		2701-480178	G57147		2701-507718	G51841		2701-547833	G64008	
2701-460091	G51806		2701-480312	G57054		2701-507726	G51758		2701-547834	G64033	
2701-460092	G52157		2701-480313	G57055		2701-507727	G51815		2701-54914	G57177	
2701-460093	G52156		2701-480314	G57056		2701-507739	70001		2701-54915	G57176	
2701-460094	G52159		2701-480317	G57027		2701-508495	G63815		2701-56897	G56932	
2701-460095	G52158		2701-480318	G57027		2701-511481	G52295		2701-584377	G51891	
2701-460103	G52183		2701-480321	G57157		2701-511807	G57120		2701-730414	G57852	
2701-460104	G52182		2701-480322	G57158		2701-511808	G57119		2701-730415	G57853	
2701-460105	G52374		2701-480324	G57159		2701-511827	G57083		2701-80473	G55856	

Important Note: Competitive Interchanges are to be used for stocking purposes only. Where multiple crosses are identified, please reference the applications section of this catalog. / **Remarque importante:** Les interchanges concurrentiels ne s'utilisent qu'aux fins de stocks. Dans le cas de références multiples, consulter la section des applications du catalogue. / **Nota importante:** Dans le cas de referencias multiples, consultar la sección de aplicaciones del catálogo. / **Nota importante:** Se pueden usar intercambios competitivos para propósitos de almacenamiento solamente. Cuando se identifican intercambios múltiples, consulte la sección de aplicaciones de este catálogo.

COMPETITIVE & O.E.M. INTERCHANGE LIST
Lista de Intercambios contra Competidores y Equipo Original.
Liste dinterchange de produits comptitifs & dquipement original (OEM)

Autopart International... cont'd

Autopart international	Gabriel	Upgrade	Autopart international	Gabriel	Upgrade	Autopart international	Gabriel	Upgrade	Autopart international	Gabriel	Upgrade
2701-80475	G56517		2701-80666	69863		2701-80919	81478		2702-32467	143459	
2701-80476	G56516		2701-80666	69903		2701-80934	G63419		2702-32476	143058	
2701-80477	G55994		2701-80667	G63937		2701-80934	G63492		2702-32787	143281	
2701-80478	G55993		2701-80669	69901		2701-80935	G63907		2702-32789	142230	
2701-80480	G55901		2701-80670	G63620		2701-80936	G63299		2702-32791	142135	
2701-80481	G55698		2701-80672	G63726		2701-80939	81871		2702-32847	142843	
2701-80484	M55974		2701-80673	81910		2701-80940	81870		2702-32860	142402	
2701-80496	G55999		2701-80674	G51077		2701-80941	81872		2702-32944	142329	
2701-80497	G55999		2701-80675	G63720		2701-80942	69725		2702-32954	142547	
2701-80498	G55662		2701-80676	69946		2701-80945	G63903		2702-32957	142546	
2701-80499	G55661		2701-80682	81911		2701-80947	G63845		2702-32958	142546	
2701-80508	G56591		2701-80683	81929		2701-80949	81923		2702-32973	142245	
2701-80509	G55820		2701-80684	G63425		2701-80952	G63350		2702-32996	142173	
2701-80513	G55676		2701-80685	G63810		2701-80953	81583		2702-33086	142932	
2701-80515	G55675		2701-80689	G63847		2701-80955	81924		2702-33087	142828	
2701-80538	M55848		2701-80690	69962		2701-80956	G63676		2702-425444	143305	
2701-80539	M55848		2701-80691	69898		2701-80957	G63829		2702-429309	143345	
2701-80551	G55774		2701-80691	81794		2701-80958	81873		2702-481941	143404	
2701-80551	M55877		2701-80693	81936		2701-80959	81912		2702-497209	143366	
2701-80552	G55774		2701-80696	81904		2701-80960	81833		2702-497274	143316	
2701-80552	M55877		2701-80871	81750		2701-80962	81828		2702-497281	143409	
2701-80554	M55912		2701-80872	81482		2701-80963	81928		2702-497281	143410	
2701-80558	M55913		2701-80875	81490		2701-82488	81892		2702-501865	143495	
2701-80573	G51087		2701-80875	81836		2701-82572	81923		2702-502751	G57161	
2701-80587	G56540		2701-80876	81039		2701-82573	81920		2702-502764	G57173	
2701-80588	G56539		2701-80877	81878		2701-82574	81925		2702-522616	G52258	
2701-80593	G55697		2701-80880	81905		2701-82577	81931		2702-527292	G51900	
2701-80593	M55697		2701-80880	81918		2701-82582	G63929		2702-543070	143455	
2701-80596	G51767		2701-80881	G63454		2701-82583	G55821		2702-71220	143059	
2701-80601	G56718		2701-80882	81484		2701-82584	G63809		2702-71221	143063	
2701-80601	M56718		2701-80883	G63424		2701-82585	G63410		2702-71222	143064	
2701-80609	G55551		2701-80886	81559		2701-82586	G63387		2702-71241	142249	
2701-80611	G56700		2701-80887	81560		2701-82587	81394		2702-71274	143422	
2701-80612	G56701		2701-80888	69845		2701-82588	G63366		2702-71397	142444	
2701-80613	M56708		2701-80889	81893		2701-82589	G64002		2702-71413	142625	
2701-80620	G51267		2701-80890	81914		2701-82590	G63803		2702-71414	142561	
2701-80621	G51268		2701-80891	69755		2701-82592	G63183		2702-71453	142530	
2701-80627	M55693		2701-80892	81516		2701-91981	6801SE		2702-82590	81922	
2701-80633	69945		2701-80893	81164		2702-07929	143191		2702-84088	143201	
2701-80633	81934		2701-80894	69676		2702-204186	143464		2702-90023	143058	
2701-80645	81713		2701-80896	81540		2702-22374	143191		2702-90302	142195	
2701-80646	70020		2701-80898	G63353		2702-236455	143321		2702-95592	143209	
2701-80649	69909		2701-80899	81096		2702-275057	143418		2702-95593	143204	
2701-80650	69900		2701-80900	81496		2702-30481	143244		2702-95611	143325	
2701-80652	81582		2701-80901	81082		2702-30482	143244		2702-95612	143197	
2701-80653	81837		2701-80901	81510		2702-313227	143363		2702-95617	142930	
2701-80655	81667		2701-80901	81710		2702-316354	143323		2702-95618	143315	
2701-80656	81668		2701-80903	81091		2702-322136	143344		2702-96575	143458	
2701-80657	81726		2701-80906	G63928		2702-32226	142649		2702-97311	143353	
2701-80658	81744		2701-80908	81937		2702-32228	142650		2702-98005	142651	
2701-80659	81890		2701-80908	82066		2702-32266	143367		2702-98083	143087	
2701-80661	81691		2701-80909	69625		2702-32274	142836		2702-98986	143202	
2701-80662	69465		2701-80909	81494		2702-32283	143191		2725-539606	58662	
2701-80663	G63782		2701-80910	81446		2702-32389	142746		2725-539606	58930	
2701-80664	G63707		2701-80916	G63610		2702-32395	143088		2725-539618	58803	
2701-80665	G63708		2701-80918	69787		2702-324503	143335		2725-539620	58817	

Important Note: Competitive Interchanges are to be used for stocking purposes only. Where multiple crosses are identified, please reference the applications section of this catalog. / **Remarque importante:** Les interchanges concurrentiels ne s'utilisent qu'aux fins de stocks. Dans le cas de rfrences multiples, consulter la section des applications du catalogue. / **Nota importante:** Dans le cas de rfrences multiples, consultar la section des aplicaciones du catalogue. / **Nota importante:** Se pueden usar intercambios competitivos para propósitos de almacenamiento solamente. Cuando se identifican intercambios múltiples, consulte la sección de aplicaciones de este catálogo.

COMPETITIVE & O.E.M. INTERCHANGE LIST
Lista de Intercambios contra Competidores y Equipo Original.
Liste d'interchange de produits compétitifs & d'équipement original (OEM)

AutoZone											
Autozone	Gabriel	Upgrade	Autozone	Gabriel	Upgrade	Autozone	Gabriel	Upgrade	Autozone	Gabriel	Upgrade
313 237	G52095		LS33-80372L	G57424		LS33-80971B	G57421		LS34-84421R	G57645	
313 238	G52094		LS33-80372R	G57425		LS33-80982B	G57607		LS34-84431B	G57324	
344426	81676		LS33-80382L	G57067		LS33-81011B	G57125		LS34-84441B	G56927	
61552	81870		LS33-80382R	G57068		LS33-81021B	G57147		LS34-84451B	G57060	
61559	81730		LS33-80392B	G57444		LS33-81042B	G57447		LS34-84461L	G56930	
61655	61655		LS33-80402L	G57086		LS33-81052B	G57579		LS34-84461R	G56931	
61712	61712		LS33-80402R	G57087		LS33-81102L	G57400		LS34-84521B	G56951	
82025	82025		LS33-80411B	G57282		LS33-81102R	G57401		LS34-84531L	G56948	
82040	82040		LS33-80422B	G57423		LS33-81111L	G57363		LS34-84531R	G56948	
82151	82151		LS33-80432L	G57428		LS33-81111R	G57364		LS34-84581B	G56975	
82615	82615		LS33-80432R	G57429		LS33-81121B	G57156		LS34-84591B	G56965	
G51077	G51077		LS33-80471B	G57146		LS33-81121B	G57277		LS34-84651B	G57051	
G51087	G51087		LS33-80481B	G57409		LS33-81131L	G57390		LS34-84691L	G57030	
G51267	G51267		LS33-80491B	G57118		LS33-81131R	G57391		LS34-84691R	G57031	
G51477	G51477		LS33-80491B	G57413		LS33-81141B	G57092		LS34-84701L	G57521	
G51700	G51700		LS33-80511L	G57027		LS33-81201B	G57397		LS34-84701R	G57522	
G51703	G51703		LS33-80511R	G57027		LS34-84001B	G57274		LS34-84711B	G56929	
G51704	G51704		LS33-80541B	G57646		LS34-84011L	G57190		LS34-84721L	G57047	
G51714	G51714		LS33-80552L	G57416		LS34-84011R	G57191		LS34-84721R	G57048	
G51715	G51715		LS33-80552R	G57682		LS34-84021L	G57539		LS34-84741L	G57049	
G63524	81905		LS33-80582L	G57597		LS34-84021R	G57540		LS34-84741R	G57050	
LS33-80031L	G57270		LS33-80582R	G57598		LS34-84051L	G57097		LS34-84771L	G57076	
LS33-80031R	G57270		LS33-80602L	G57451		LS34-84051R	G57098		LS34-84771R	G57077	
LS33-80061L	G57148		LS33-80602R	G57452		LS34-84071L	G57157		LS34-84791L	G57069	
LS33-80061R	G57148		LS33-80612L	G57572		LS34-84071R	G57158		LS34-84791L	G57121	
LS33-80091B	G57427		LS33-80612R	G57573		LS34-84081L	G57114		LS34-84791R	G57070	
LS33-80111L	G57207		LS33-80652B	G57675		LS34-84081R	G57115		LS34-84791R	G57122	
LS33-80111L	G57417		LS33-80681L	G57202		LS34-84091L	G57357		LS34-84821L	G57628	
LS33-80111R	G57208		LS33-80681R	G57203		LS34-84091R	G57358		LS34-84821R	G57629	
LS33-80111R	G57418		LS33-80691L	G57275		LS34-84101L	G57404		LS34-84861L	G57393	
LS33-80121L	G57455		LS33-80691R	G57276		LS34-84101R	G57405		LS34-84861R	G57394	
LS33-80121R	G57456		LS33-80701L	G57130		LS34-84121L	G57204		LS34-84931L	G57465	
LS33-80131L	G57594		LS33-80701R	G57131		LS34-84121R	G57205		LS34-84931R	G57466	
LS33-80131R	G57595		LS33-80721L	G57390		LS34-84131L	G57204		LS34-84941L	G57577	
LS33-80192B	G56998		LS33-80721R	G57391		LS34-84131R	G57205		LS34-84941R	G57578	
LS33-80202B	G57057		LS33-80741L	G57268		LS34-84161L	G57084		LS34-84961L	G57329	
LS33-80202B	G57058		LS33-80741R	G57269		LS34-84161R	G57085		LS34-84961R	G57330	
LS33-80212B	G56995		LS33-80751B	G57013		LS34-84181L	G57558		LS34-84981L	G57493	
LS33-80231L	G56993		LS33-80761B	G57006		LS34-84181R	G57559		LS34-84981R	G57494	
LS33-80231R	G56994		LS33-80771L	G57034		LS34-84191L	G57184		LS34-85001L	G57673	
LS33-80241B	G57022		LS33-80771R	G57035		LS34-84191R	G57185		LS34-85001R	G57674	
LS33-80251L	G57010		LS33-80781B	G57099		LS34-84211B	G57141		LS34-85021L	G57603	
LS33-80251R	G57010		LS33-80781B	G57100		LS34-84311L	G57345		LS34-85021R	G57604	
LS33-80261L	G57007		LS33-80801L	G57377		LS34-84311R	G57346		LS34-85121L	G57081	
LS33-80261R	G57008		LS33-80801R	G57378		LS34-84321L	G57515		LS34-85121R	G57082	
LS33-80271L	G56996		LS33-80831B	G57059		LS34-84321R	G57516		LS34-85131L	G57063	
LS33-80271R	G56997		LS33-80851B	G57680		LS34-84351L	G57369		LS34-85131R	G57064	
LS33-80282L	G57032		LS33-80861B	G57149		LS34-84351R	G57370		LS34-85141B	G56934	
LS33-80282L	G57061		LS33-80891L	G56991		LS34-84361L	G57088		LS34-85141B	G56937	
LS33-80282R	G57033		LS33-80891R	G56992		LS34-84361R	G57089		LS34-85151B	G56935	
LS33-80282R	G57062		LS33-80911B	G57039		LS34-84381B	G57142		LS34-85182L	G57414	
LS33-80301B	G57080		LS33-80922B	G57018		LS34-84391L	G57161		LS34-85182R	G57415	
LS33-80311L	G57054		LS33-80931B	G57000		LS34-84391R	G57162		LS34-85192B	G57096	
LS33-80311R	G57055		LS33-80931B	G57023		LS34-84411L	G57218		LS34-85202B	G57173	
LS33-80352B	G57159		LS33-80941B	G57053		LS34-84411R	G57219		LS34-85211L	G57339	
LS33-80352B	G57160		LS33-80952B	G57036		LS34-84421L	G57644		LS34-85211R	G57340	

Important Note: Competitive Interchanges are to be used for stocking purposes only. Where multiple crosses are identified, please reference the applications section of this catalog. / **Remarque importante:** Les interchanges concurrentiels ne s'utilisent qu'aux fins de stocks. Dans le cas de références multiples, consulter la section des applications du catalogue. / **Nota importante:** Dans le cas de referencias multiples, consultar la sección de aplicaciones del catálogo. / **Nota importante:** Se pueden usar intercambios competitivos para propósitos de almacenamiento solamente. Cuando se identifican intercambios múltiples, consulte la sección de aplicaciones de este catálogo.

COMPETITIVE & O.E.M. INTERCHANGE LIST
Lista de Intercambios contra Competidores y Equipo Original.
Liste dinterchange de produits comptitifs & equipement original (OEM)

AutoZone... cont'd

Autozone	Gabriel	Upgrade	Autozone	Gabriel	Upgrade	Autozone	Gabriel	Upgrade	Autozone	Gabriel	Upgrade
LS34-85241L	G57341		LS53-90601L	G57331		LS54-94411R	G56963		TS32-30141B	81507	
LS34-85241R	G57342		LS53-90601R	G57332		LS54-94432L	G56973		TS32-30171B	G63614	
LS34-85251L	G57341		LS53-90611L	G57479		LS54-94432R	G56974		TS32-30261B	81394	
LS34-85251R	G57342		LS53-90611R	G57480		LS54-94451L	G57011		TS32-30562B	82032	
LS34-85271L	G57041		LS53-90651L	G57197		LS54-94451R	G57012		TS32-30872B	69592	
LS34-85271R	G57042		LS53-90651L	G57322		LS54-94462L	G56924		TS32-32332B	81934	
LS34-85341L	G57459		LS53-90651R	G57198		LS54-94462R	G56925		TS32-33951B	82005	
LS34-85341R	G57460		LS53-90651R	G57323		LS54-94471B	G57271		TS32-33992B	82131	
LS34-85411L	G57222		LS53-90661L	G57564		LS54-94482L	G57078		TS32-34011B	82026	
LS34-85411R	G57223		LS53-90661R	G57565		LS54-94482R	G57079		TS32-34032B	81469	
LS34-85451L	G57495		LS53-90671L	G57266		LS54-94491L	G57664		TS32-34032B	82065	
LS34-85451R	G57496		LS53-90671R	G57267		LS54-94491R	G57663		TS32-34072B	82609	
LS34-85471L	G57359		LS53-90691B	G57071		LS54-94521L	G57473		TS32-34092B	82155	
LS34-85471R	G57360		LS53-90691B	G57072		LS54-94521R	G57474		TS32-34142B	82156	
LS53-90002L	G57167		LS53-90712B	G56943		LS54-94531L	G57137		TS32-34172B	82066	
LS53-90002R	G57168		LS53-90732B	G56964		LS54-94531R	G57138		TS32-34222B	82004	
LS53-90062L	G57634		LS53-90752B	G57056		LS54-94541L	G57481		TS32-34262B	82125	
LS53-90062R	G57635		LS53-90841L	G57549		LS54-94541R	G57482		TS32-34341B	82035	
LS53-90082B	G56928		LS53-90841R	G57550		LS54-94572L	G56924		TS32-34352B	82086	
LS53-90122L	G56949		LS53-90872B	G57075		LS54-94572R	G56925		TS32-34422B	82103	
LS53-90122R	G56950		LS53-90941B	G57040		LS54-94681L	G57562		TS33-30182B	81880	
LS53-90142B	G57014		LS54-94032L	G57483		LS54-94681R	G57563		TS33-30241B	G64027	
LS53-90161L	G57582		LS54-94032R	G57484		LS54-94691B	G57109		TS33-30252B	G64028	
LS53-90161R	G57583		LS54-94081L	G57163		LS54-94691B	G57314		TS33-30411B	81478	
LS53-90181L	G57353		LS54-94081R	G57164		LS54-94701L	G57676		TS33-30892B	81873	
LS53-90181R	G57354		LS54-94091L	G57105		LS54-94701R	G57677		TS33-30892B	81928	
LS53-90201L	G57083		LS54-94091R	G57106		LS54-94722B	G56936		TS33-30962B	69473	
LS53-90201R	G57083		LS54-94101L	G57349		LS54-94732B	G57016		TS33-30971B	81914	
LS53-90251B	G57020		LS54-94101R	G57350		LS54-94752L	G57090		TS33-31002B	81935	
LS53-90261B	G57015		LS54-94132L	G57586		LS54-94752R	G57091		TS33-31013B	81560	
LS53-90261B	G57212		LS54-94132R	G57587		LS54-94851L	G57612		TS33-31013B	81923	
LS53-90271B	G57017		LS54-94141L	G57375		LS54-94851R	G57613		TS33-31181B	82147	
LS53-90281B	G57021		LS54-94141R	G57376		LS54-94881L	G57144		TS33-31402B	81828	
LS53-90291B	G57019		LS54-94161L	G57373		LS54-94881R	G57145		TS33-31452B	61656	
LS53-90322B	G57422		LS54-94161R	G57372		LS54-94922L	G57152		TS33-31722B	69909	
LS53-90332B	G57026		LS54-94191L	G57150		LS54-94922R	G57153		TS33-31741B	81932	
LS53-90361L	G57220		LS54-94191R	G57151		LS54-94981L	G57037		TS33-31852B	81910	
LS53-90361R	G57221		LS54-94211L	G57112		LS54-94981R	G57038		TS33-31962B	69575	
LS53-90371B	G57095		LS54-94211R	G57113		LS54-95001L	G57119		TS33-32351B	81113	
LS53-90391B	G57132		LS54-94221L	G57489		LS54-95011R	G57120		TS33-32441B	G63782	
LS53-90401B	G57103		LS54-94221R	G57490		LS55-99001L	G57333		TS33-32542B	81490	
LS53-90411L	G57133		LS54-94281L	G57176		LS55-99001R	G57334		TS33-32542B	81710	
LS53-90411R	G57134		LS54-94281L	G57464		LS55-99011L	G57560		TS33-32561B	81691	
LS53-90432L	G57419		LS54-94281R	G57177		LS55-99011R	G57561		TS33-32573B	82007	
LS53-90432R	G57419		LS54-94281R	G57463		TS32-30002B	81495		TS33-32641B	81821	
LS53-90442L	G57278		LS54-94301L	G57139		TS32-30002B	82076		TS33-32813B	81484	
LS53-90442R	G57279		LS54-94301R	G57140		TS32-30012B	69587		TS33-32942B	G63781	
LS53-90512B	G56938		LS54-94321B	G57206		TS32-30022B	69590		TS33-33032B	82003	
LS53-90522L	G56932		LS54-94331B	G57206		TS32-30031B	81836		TS33-33042B	81904	
LS53-90522R	G56933		LS54-94342L	G57343		TS32-30041B	81516		TS33-33412B	61582	
LS53-90541L	G57045		LS54-94342R	G57344		TS32-30052B	81794		TS33-33581B	81675	
LS53-90541R	G57046		LS54-94351L	G57471		TS32-30072B	G64042		TS33-33702B	81540	
LS53-90561L	G57110		LS54-94351R	G57472		TS32-30082B	69589		TS33-33801B	81553	
LS53-90561L	G57535		LS54-94391L	G56956		TS32-30102B	81147		TS33-33931B	82104	
LS53-90561R	G57111		LS54-94391R	G56957		TS32-30112B	81481		TS33-33942B	82001	
LS53-90561R	G57536		LS54-94411L	G56962		TS32-30141B	61662		TS33-33981B	82090	

Important Note: Competitive Interchanges are to be used for stocking purposes only. Where multiple crosses are identified, please reference the applications section of this catalog. / **Remarque importante:** Les interchanges concurrentiels ne s'utilisent qu'aux fins de stocks. Dans le cas de références multiples, consulter la section des applications du catalogue. / **Nota importante:** Dans le cas de références multiples, consulter la section des applications du catalogue. / **Nota importante:** Se pueden usar intercambios competitivos para propósitos de almacenamiento solamente. Cuando se identifican intercambios múltiples, consulte la sección de aplicaciones de este catálogo.

COMPETITIVE & O.E.M. INTERCHANGE LIST

Lista de Intercambios contra Competidores y Equipo Original.

Liste d'interchange de produits compétitifs & d'équipement original (OEM)

AutoZone... cont'd

Autozone	Gabriel	Upgrade	Autozone	Gabriel	Upgrade	Autozone	Gabriel	Upgrade	Autozone	Gabriel	Upgrade
TS33-34021B	82099		TS34-31432B	81667		TS34-31861B	81548		TS34-32772B	81891	
TS33-34101B	82138		TS34-31441B	G63809		TS34-31872B	81549		TS34-32862B	81095	
TS33-34321B	82072		TS34-31462B	61717		TS34-31992B	61715		TS34-32911B	G64043	
TS33-34381B	82047		TS34-31481B	81893		TS34-32002B	81937		TS34-33012B	G63837	
TS33-34401B	82011		TS34-31492B	81890		TS34-32021B	81494		TS34-33271B	81582	
TS33-34441B	82010		TS34-31521B	81933		TS34-32031B	81936		TS34-33382B	81837	
TS33-34472B	81416		TS34-31532B	81913		TS34-32042B	81929		TS34-34041B	81076	
TS33-34532B	82130		TS34-31552B	G63892		TS34-32052B	81833		TS34-34061B	82087	
TS33-34641B	81153		TS34-31561B	61720		TS34-32072B	81713		TS34-34111B	82118	
TS33-34662B	82039		TS34-31611B	81916		TS34-32081B	81750		TS34-34131B	82126	
TS34-30953B	61506		TS34-31611B	81918		TS34-32102B	81164		TS34-34152B	82051	
TS34-30953B	81318		TS34-31622B	81917		TS34-32111B	81039		TS34-34192B	82060	
TS34-30953B	81440		TS34-31632B	81926		TS34-32131B	81559		TS34-34201B	82601	
TS34-31021B	81726		TS34-31641B	81869		TS34-32141B	61546		TS34-34231B	82128	
TS34-31231B	82034		TS34-31662B	81482		TS34-32152B	81510		TS34-34241B	82079	
TS34-31342B	81921		TS34-31672B	81082		TS34-32162B	61654		TS34-34281B	82070	
TS34-31342B	81931		TS34-31691B	81668		TS34-32172B	61614		TS34-34301B	82075	
TS34-31361B	81920		TS34-31702B	G64040		TS34-32202B	81492		TS34-34331B	81491	
TS34-31371B	81912		TS34-31732B	81878		TS34-32252B	81496		TS34-34391B	82109	
TS34-31382B	81892		TS34-31762B	70010		TS34-32261B	81919		TS34-34511B	82012	
TS34-31391B	81744		TS34-31772B	G63726		TS34-32321B	81096		TS34-34541B	82110	
TS34-31411B	81446		TS34-31802B	G63844		TS34-32423B	81242		TS34-34602B	82602	
TS34-31422B	81922		TS34-31822B	61704		TS34-32552B	81583		TS34-34682B	82618	
TS34-31422B	81925		TS34-31832B	81924		TS34-32632B	81825				
TS34-31422B	81930		TS34-31842B	81871		TS34-32671B	81834				

Avanti

Avanti	Gabriel	Upgrade	Avanti	Gabriel	Upgrade	Avanti	Gabriel	Upgrade	Avanti	Gabriel	Upgrade
88945169	69600		88945170	69604		88945188	69724				

Batco

Batco	Gabriel	Upgrade	Batco	Gabriel	Upgrade	Batco	Gabriel	Upgrade	Batco	Gabriel	Upgrade
1083203	83203	89436	1083225	83225		1085007	85007		1085311	85311	89424
1083203	89436		1083310	83221		1085300	85300	89419	1085311	89424	
1083204	83204		1083317	83317		1085300	89419		1087001	85734	
1083207	83207	89407	1085003	85003	89411	1085301	85301		1087006	85736	
1083207	89407		1085003	89411		1085305	85305				
1083209	83209	89414	1085005	85005	89430	1085308	85308	89422			
1083209	89414		1085005	89430		1085308	89422				

Benson Truck Bodies Inc.

Benson truck bodies inc.	Gabriel	Upgrade	Benson truck bodies inc.	Gabriel	Upgrade	Benson truck bodies inc.	Gabriel	Upgrade	Benson truck bodies inc.	Gabriel	Upgrade
90044089	83124	89407	A-20002	85000	89436	A20002	85000	89436			
90044089	89407		A-20002	89436		A20002	89436				

Bering Truck Corp.

Bering truck corp.	Gabriel	Upgrade	Bering truck corp.	Gabriel	Upgrade	Bering truck corp.	Gabriel	Upgrade	Bering truck corp.	Gabriel	Upgrade
47902-24	83137		4790224	83137							

Berkshire Coach

Berkshire coach	Gabriel	Upgrade	Berkshire coach	Gabriel	Upgrade	Berkshire coach	Gabriel	Upgrade	Berkshire coach	Gabriel	Upgrade
8C24-18045-DA	G63622		8C2418080DB	G63623		8C2Z18124D	G63622		ASH-1154	G63622	
8C24-18080-DB	G63623		8C2Z-18124-D	G63622		8C2Z18125D	G63623		ASH1136	G63623	
8C2418045DA	G63622		8C2Z-18125-D	G63623		ASH-1136	G63623		ASH1154	G63622	

Bilstein

Bilstein	Gabriel	Upgrade	Bilstein	Gabriel	Upgrade	Bilstein	Gabriel	Upgrade	Bilstein	Gabriel	Upgrade
14-186629	85125		24-153256	85124		B46-1725	85029		F4-B46-1725-H2	85029	
24-015943	85013	89414	24-186414	85029		B46-1732	85030	89440	F4-B46-1732-H1	85030	89440
24-015943	89414		B46-1594	85013	89414	B46-1732	89440				
24-017329	85030	89440	B46-1594	85030	89440	B46-2151	85007				
24-017329	89440		B46-1594	89414		F4-B46-1594-H0	85013	89414			
24-153249	85125		B46-1594	89440		F4-B46-1594-H0	89414				

Important Note: Competitive Interchanges are to be used for stocking purposes only. Where multiple crosses are identified, please reference the applications section of this catalog. / **Remarque importante:** Les interchanges concurrentiels ne s'utilisent qu'aux fins de stocks. Dans le cas de références multiples, consulter la section des applications du catalogue. / **Nota importante:** Dans le cas de referencias multiples, consultar la sección de aplicaciones del catálogo. / **Nota importante:** Se pueden usar intercambios competitivos para propósitos de almacenamiento solamente. Cuando se identifican intercambios múltiples, consulte la sección de aplicaciones de este catálogo.

COMPETITIVE & O.E.M. INTERCHANGE LIST
Lista de Intercambios contra Competidores y Equipo Original.
Liste dinterchange de produits comptitifs & dquipement original (OEM)

Bilstein... cont'd

Bilstein	Gabriel	Upgrade	Bilstein	Gabriel	Upgrade	Bilstein	Gabriel	Upgrade	Bilstein	Gabriel	Upgrade
F4-B46-1732-H1	89440		F4-BE5-B492-H0	85125		F4-BE5-F324-H0	85125		F4-BE5-F325-H0	85124	

Blue Bird

Blue bird	Gabriel	Upgrade	Blue bird	Gabriel	Upgrade	Blue bird	Gabriel	Upgrade	Blue bird	Gabriel	Upgrade
00020317	85036	89405	1962430	89407		58913007	85959		70397	85006	
00020317	89405		2021459	85012	89413	58913007L	85959		7805-M-1001	85919	
00085991	85006		2021459	89413		58913008	85959		7805-N-1002	85329	
00110808	83124	89407	23106-01	89430		58913008L	85959		7805-S-1007	85329	
00110808	89407		300-0614966	85307		58913009	85959		7805M1001	85919	
00119797	85959		300-0614974	85304		58913009L	85959		7805N1002	85329	
00119798	85106		300-0823047	85736		58913010	85106		7805S1007	85329	
0014605	85036	89405	300-0823054	85304		58913010L	85106		87001-01A	85734	
0014605	89405		300-09612284	85734		58913011	85959		8700101A	85734	
0014985	83137		300-1316546	85006		58913011L	85959		8C24-18045-DA	G63622	
0015222	85919		300-1317767	85029		59057-001	83137		8C24-18080-DB	G63623	
0020326	85976		3000614966	85307		59057-002	85036	89405	8C2418045DA	G63622	
0040015	85919		3000614974	85304		59057-002	89405		8C2418080DB	G63623	
0055008	85959		3000823047	85736		59057001	83137		8C2Z-18124-D	G63622	
0055017	85959		3000823054	85304		59057002	85036	89405	8C2Z-18125-D	G63623	
00614966	85307		30009612284	85734		59057002	89405		8C2Z18124D	G63622	
0075916	85086		3001316546	85006		59483-000	85919		8C2Z18125D	G63623	
0085990	85959		3001317767	85029		59483000	85919		90-1813	85712	
0088035	85090		303-1350628	85712		60665-004	85036	89405	90-1951-SP1	85734	
0106303	85106		3031350628	85712		60665-004	89405		90-1968	85712	
01722214	85030	89440	305-0961284	85734		60665-005	85919		90-1968	85720	
01722214	89440		3050961284	85734		60665-005L	85919		90-1968-SP1	85712	
0523047	85736		471700000428	85006		60665003	83137		90044448	85051	
060665-003	83137		471700000430	85006		60665005	85919		90044915	83127	
060665-004	85036	89405	471700000456	85959		60665005L	85919		90045083	85910	
060665-004	89405		471700000460	85090		609180	85304		901813	85712	
0823054	85304		471700000460	85959		60998-001	85006		901951SP1	85734	
1004167	85712		471700000464	85090		60998-002	85919		901968	85712	
1217934	85304		471700002919	85106		60998-002L	85919		901968SP1	85712	
1316546	85006		471700002920	85106		60998-003	85006		A-4890	85712	
1317767	85029		471700131545	85006		60998001	85006		A4890	85712	
1526417	85052		471700131550	85006		60998002	85919		AMS65109	85058	89431
1658533	85010		4759272	89447		60998002L	85919		AMS65109	89431	
1667831	85029		4760958	85086		60998003	85006		AMS65110	85005	89430
1668722	85030	89440	481700131438	85919		614958	85307		AMS65110	89430	
1668722	89440		481700131440	85919		614974	85304		AMS65119	85029	
1668730	85013	89414	58913-007	85959		65992-003	85959		ASH-1136	G63623	
1668730	89414		58913-007L	85959		65992-004	85106		ASH-1154	G63622	
1707405	85005	89430	58913-008	85959		65992003	85959		ASH1136	G63623	
1707405	89430		58913-008L	85959		65992004	85106		ASH1154	G63622	
1722222	85013	89414	58913-009	85959		671933	85919		AT-163G	G63622	
1722222	89414		58913-009L	85959		680102	85712		AT-164G	G63623	
1746163	85006		58913-010	85106		680155	85712		AT163G	G63622	
1750793	85712		58913-010L	85106		680667	89447		AT164G	G63623	
1962422	85304		58913-011	85959		680783	85304				
1962430	83207	89407	58913-011L	85959		70317	89402				

BMW

Bmw	Gabriel	Upgrade	Bmw	Gabriel	Upgrade	Bmw	Gabriel	Upgrade	Bmw	Gabriel	Upgrade
31-31-6-750-792	G52237		31-31-6-786-022	G52143		33-52-1-095-913	69863		33-52-6-782-859	70045	
31-31-6-786-021	G52142		31-33-6-752-735	143082		33-52-1-096-366	69863				

BOGE

Boge	Gabriel	Upgrade	Boge	Gabriel	Upgrade	Boge	Gabriel	Upgrade	Boge	Gabriel	Upgrade
1034	69675		1541	69632							
1534	82601		1551	82156							

Important Note: Competitive Interchanges are to be used for stocking purposes only. Where multiple crosses are identified, please reference the applications section of this catalog. / **Remarque importante:** Les interchanges concurrentiels ne s'utilisent qu'aux fins de stocks. Dans le cas de rfrences multiples, consulter la section des applications du catalogue. / **Nota importante:** En el caso de referencias multiples, consultar la sección de aplicaciones del catálogo. / **Nota importante:** Se pueden usar intercambios competitivos para propósitos de almacenamiento solamente. Cuando se identifican intercambios múltiples, consulte la sección de aplicaciones de este catálogo.

COMPETITIVE & O.E.M. INTERCHANGE LIST
Lista de Intercambios contra Competidores y Equipo Original.
Liste dinterchange de produits comptitifs & dquipement original (OEM)

BOGE... cont'd

Boge	Gabriel	Upgrade	Boge	Gabriel	Upgrade	Boge	Gabriel	Upgrade	Boge	Gabriel	Upgrade
1552	G63902		2566	G63783		32276	81713		4831	G51859	
1553	G63907		2568	G63614		32277	81495		4836	G52006	
1557	69898		2581	G63492		32289	G63511		4837	G52005	
1558	G55825		2585	G63813		32305	81507		4838	G56887	
1567	69945		2591	G63662		32504	G63909		4839	G56886	
1569	G63776		27-B42-A	69901		33-086-F	G51097		4859	G56842	
1572	69464		27-C08-F	69420		33001	6802SE		4860	G56843	
1575	69465		27-E03-A	69450		33002	6847SE		4985	G52245	
1586	69473		27-F55-A	69473		33005	6804SE		4986	G52246	
1624	G51799		27-G83-F	G51841		34-508-0	77614		4987	G51898	
1635	G51736		27-H29-A	69585		35039	61525		4990	70052	
1647	69592		27-J46-A	G51767		35039	81039		53-523-2	G63608	
1670	G51842		27-J46-A	G51910		35054	81540		83-202-5	69675	
1674	G51874		27-K42-A	70056		35059	61510		83-202-5	81494	
1675	70027		27-K42-S	70056		35059	81871		83-202-5	81582	
1680	70041		27-M10-A	70036		35063	61541		83-202-5	81750	
1683	70036		28-B48-A	G63864		35063	81583		83-203-4	82001	
1687	70003		30-E22-A	G51714		35084	81342		83-203-4	82032	
1688	69591		30-G50-A	69586		35085	61632		83-205-7	81821	
1689	69587		30-H91-A	G52154		35085	81825		83-214-1	82005	
1693	G51807		30-H92-A	G52155		35087	82065		83-215-4	69465	
1694	G51783		30-H93-A	G511054		35091	58489		83-218-2	69606	
1697	G51863		30-H94-A	G511055		35091	61544		83-218-2	81514	
1698	70089		30-J09-A	G56633		35091	77489		83-221-9	61501	
1700	G51908		30-J10-A	G56634		35091	81668		83-221-9	81478	
1746	G51874		32-D14-F	69946		35097	58422		83-222-1	69632	
1747	G511044		32-G09-A	G51740		35115	58623		83-227-1	69845	
1753	G51971		32-H73-A	G55896		35115	81242		83-227-2	69675	
2001	81394		32-K61-A	G52275		35257	58423		83-227-6	61529	
2002	81147		32-K62-A	G52274		35257	58609		83-227-6	69625	
2006	G63495		32-P80-A	G56514		35257	61531		83-227-6	77375	
22003	14004		32-P81-A	G56506		35257	77609		83-227-6	81446	
22003	14005		32-Q85-A	70078		35257	81496		83-227-6	81541	
2501	G63386		32-R16-A	G52274		35257	81516		83-227-6	81870	
2502	G63907		32-R16-A	G52275		36-302-0	69677		83-227-7	69574	
2504	G63349		32-R17-A	G52274		36-A97-A	G56802		83-227-7	69575	
2505	G63355		32-R17-A	G52275		36-A97-F	G56802		83-227-7	81495	
2506	G63414		32-T45-A	G56819		36-G33-A	G52295		83-227-8	82156	
2507	G63717		32-T46-A	G56820		36-H61-0	70040		83-227-9	61501	
2516	G63377		32-T47-A	G56821		40-A85-0	85708		83-227-9	81478	
2519	G63488		32-T48-A	G56822		4507	G56517		83-228-0	81147	
2520	G63421		32-V34-A	G52374		4510	G56516		83-228-6	81794	
2521	G63896		32-V35-A	G52375		4550	G55948		83-229-5	G55825	
2522	G63896		32001	81076		4589	G55697		83-237-0	G51087	
2525	G63662		32001	82104		4596	G56606		83-239-5	69464	
2526	G63673		32002	81270		46-A43-0	G51773		83-239-5	81935	
2527	G63424		32002	82004		4607	G51268		83-241-9	61506	
2528	G63683		32003	81491		4608	G51267		83-241-9	81318	
2529	G63423		32003	82126		4619	G56620		83-243-0	69945	
2530	G63608		32022	82130		4717	G51738		83-243-0	81934	
2541	G64042		32025	69600		4719	G56899		83-243-8	61659	
2547	G63678		32036	82125		4797	G52081		83-243-8	61777	
2548	G63607		32051	81340		4798	G52082		83-243-8	81924	
2549	G63714		32067	82128		4803	G52094		83-249-8	69473	
2551	G63772		32091	81153		4804	G52095		83-251-3	69946	
2554	G63778		32272	81446		4830	G51859		83-251-4	69725	

Important Note: Competitive Interchanges are to be used for stocking purposes only. Where multiple crosses are identified, please reference the applications section of this catalog. / **Remarque importante:** Les interchanges concurrentiels ne s'utilisent qu'aux fins de stocks. Dans le cas de références multiples, consulter la section des applications du catalogue. / **Nota importante:** Dans le cas de referencias multiples, consultar la sección de aplicaciones del catálogo. / **Nota importante:** Se pueden usar intercambios competitivos para propósitos de almacenamiento solamente. Cuando se identifican intercambios múltiples, consulte la sección de aplicaciones de este catálogo.

COMPETITIVE & O.E.M. INTERCHANGE LIST
Lista de Intercambios contra Competidores y Equipo Original.
Liste dinterchange de produits comptitifs & dquipement original (OEM)

BOGE... cont'd

Boge	Gabriel	Upgrade	Boge	Gabriel	Upgrade	Boge	Gabriel	Upgrade	Boge	Gabriel	Upgrade
83-252-8	69863		83-269-4	G51971		83-509-7	61687		83-518-4	81912	
83-253-2	G51881		83-270-8	G511142		83-509-7	81164		83-518-5	61614	
83-253-5	69450		83-271-0	G51990		83-509-7	81482		83-518-7	61612	
83-254-2	G51799		83-271-3	G51905		83-509-9	61599		83-518-7	61638	
83-254-6	69589		83-271-9	G51898		83-510-0	61642		83-518-7	81892	
83-255-3	G51736		83-272-0	70052		83-510-0	61691		83-518-7	81913	
83-255-6	G51841		83-272-3	69590		83-510-0	81873		83-518-8	61626	
83-255-8	69586		83-273-6	70207		83-510-1	61634		83-518-9	61627	
83-256-0	70086		83-501-6	61521		83-510-1	61635		83-518-9	61629	
83-256-4	70031		83-501-6	82012		83-510-1	81919		83-518-9	81918	
83-256-6	G51887		83-502-0	61500		83-510-1	81932		83-519-0	61680	
83-256-6	G51888		83-502-0	61506		83-510-4	61535		83-519-0	77809	
83-256-8	69592		83-502-0	77907		83-510-4	61615		83-519-0	77837	
83-256-8	69898		83-503-8	61524		83-510-4	81869		83-519-0	77951	
83-257-0	G51904		83-503-9	61525		83-510-4	81936		83-519-3	61536	
83-257-2	G51871		83-503-9	81039		83-510-5	61575		83-519-4	61625	
83-258-6	70039		83-505-3	61520		83-510-5	61664		83-519-5	61601	
83-258-7	70040		83-505-3	61546		83-510-5	61676		83-519-6	61658	
83-259-0	G51842		83-505-3	61561		83-510-5	61715		83-519-6	81923	
83-259-1	G51849		83-505-3	77414		83-510-5	81891		83-520-6	58817	
83-259-2	G51849		83-505-3	77455		83-510-6	61605		83-520-6	61641	
83-259-4	G51874		83-505-3	81394		83-510-6	81878		83-520-6	61663	
83-259-5	70027		83-505-3	81490		83-510-7	58622		83-520-6	77783	
83-260-1	70041		83-505-3	81553		83-510-7	58807		83-520-6	81920	
83-260-2	70060		83-505-3	81744		83-510-7	58929		83-520-6	81925	
83-260-4	70036		83-505-4	61518		83-510-7	61591		83-521-1	61710	
83-260-6	G51794		83-505-4	61530		83-510-7	77608		83-521-6	61600	
83-260-8	70003		83-505-4	61533		83-510-7	77614		83-522-2	61512	
83-260-9	69591		83-505-4	61547		83-510-7	77807		83-522-7	61552	
83-261-0	69587		83-505-4	61554		83-510-7	81744		83-523-1	61613	
83-261-4	G511092		83-505-4	61573		83-511-5	61595		83-523-1	81914	
83-261-5	G51783		83-505-4	61654		83-511-5	61646		83-523-3	61590	
83-261-8	G51863		83-505-4	61713		83-511-5	77623		83-523-4	81318	
83-261-9	70089		83-505-4	77461		83-511-5	81828		83-523-6	61662	
83-262-1	G51908		83-505-4	77525		83-511-5	81833		83-523-7	61655	
83-262-3	61504		83-505-4	81082		83-512-0	58357		83-523-8	58810	
83-262-3	81750		83-505-4	81510		83-512-0	61517		83-523-8	61656	
83-262-5	G63937		83-505-4	81710		83-512-1	58638		83-524-1	58662	
83-262-6	G63710		83-505-4	81730		83-512-1	61516		83-524-1	61600	
83-262-7	G63829		83-505-4	81905		83-512-1	61519		83-524-8	81928	
83-262-9	G63778		83-509-0	58359		83-512-1	61522		83-524-9	61692	
83-263-1	G63479		83-509-0	61523		83-512-1	61539		83-524-9	61710	
83-263-2	77494		83-509-0	81096		83-512-1	77454		87-375-R	142444	
83-263-3	G63454		83-509-0	81834		83-512-1	81484		87-393-R	142651	
83-263-4	G63679		83-509-1	58489		83-518-2	61623		87-423-A	142653	
83-263-5	81676		83-509-1	61544		83-518-2	61626		87-424-A	143191	
83-263-7	G63909		83-509-1	61555		83-518-2	77678		87-448-R	142230	
83-263-9	G63377		83-509-1	77489		83-518-2	81893		87-462-R	142852	
83-264-0	G63772		83-509-1	81668		83-518-2	81916		87-482-A	142249	
83-264-2	70038		83-509-2	61543		83-518-3	61624		88-237-A	142625	
83-267-3	G51934		83-509-2	81667		83-518-3	77607		88-243-A	142419	
83-267-4	G51934		83-509-3	61565		83-518-3	81890		88-248-A	143492	
83-268-5	70056		83-509-6	58421		83-518-4	58714		88-471-R	142932	
83-268-6	70040		83-509-6	61504		83-518-4	58808		88-472-R	142547	
83-268-7	G51874		83-509-7	58638		83-518-4	61611		88-473-R	142546	
83-268-8	G511044		83-509-7	61528		83-518-4	77714		88-597-R	143058	

Important Note: Competitive Interchanges are to be used for stocking purposes only. Where multiple crosses are identified, please reference the applications section of this catalog./ **Remarque importante:** Les interchanges concurrentiels ne s'utilisent qu'aux fins de stocks. Dans le cas de rfrences multiples, consulter la section des applications du catalogue./ **Nota importante:** Dans le cas de rfrences multiples, consulter la section des applications du catalogue./ **Nota importante:** Se pueden usar intercambios competitivos para propósitos de almacenamiento solamente. Cuando se identifican intercambios múltiples, consulte la sección de aplicaciones de este catálogo.

COMPETITIVE & O.E.M. INTERCHANGE LIST
Lista de Intercambios contra Competidores y Equipo Original.
Liste dinterchange de produits comptitifs & dquipement original (OEM)

BOGE... cont'd

Boge	Gabriel	Upgrade	Boge	Gabriel	Upgrade	Boge	Gabriel	Upgrade	Boge	Gabriel	Upgrade
88-624-A	143191		930040	61643		930085	G64012		950 003	G56620	
88-709-A	143082		930040	77803		930089	G63845		950 005	G55948	
88-716-R	143239		930040	81922		930089	G64033		950 006	G56778	
88-994-A	143087		930041	61675		930091	G63878		950 007	G56655	
89-001-0	143057		930041	61690		930091	G63883		950 010	G56581	
89-001-0	143058		930041	77953		930095	G51798		950 011	G56582	
89-018-0	143058		930041	77976		930095	G51884		950 012	G52106	
89-075-0	143058		930042	G63776		930105	61720		950 012	G52108	
930 041	58930		930042	G63868		930105	61734		950 012	G56797	
930 159	G64151		930042	G63869		930106	G64016		950 013	G52105	
930001	G63915		930043	G63907		930107	G63890		950 013	G52107	
930002	G63403		930044	G51766		930107	G63891		950 013	G56798	
930003	77675		930044	G63813		930109	G51724		950 014	G56778	
930004	77949		930045	G63492		930110	G51723		950 017	G56601	
930004	77950		930045	G64031		930113	G63879		950 018	G56568	
930006	G63353		930046	77905		930114	G63884		950 020	G51718	
930007	77847		930046	81836		930117	G63875		950 024	G56774	
930008	77683		930048	G63359		930120	G51715		950 025	G56773	
930008	77829		930048	G63661		930130	G63299		950 026	G56758	
930008	81926		930049	58944		930132	G63690		950 027	G56759	
930009	61616		930049	77673		930133	81917		950 028	G56799	
930009	81929		930049	77674		930135	69813		950 029	G56800	
930010	G51728		930049	77947		930141	G56838		950 034	G64049	
930011	G63844		930049	77967		930142	G56839		950 035	G56615	
930012	77661		930050	G63410		930143	G64037		950 036	G56616	
930012	77954		930050	G63614		930144	G51853		950 045	G52008	
930013	61716		930051	77968		930144	G51854		950 045	G52170	
930016	G63426		930051	77969		930145	G63889		950 046	G51739	
930016	G63690		930052	77817		930146	61714		950 046	G57134	
930017	G63714		930053	G63355		930147	G51838		950 047	G63885	
930018	77717		930054	G51703		930148	G51838		950 047	G64029	
930019	77772		930055	G63870		930151	G51879		950 047	G64030	
930020	77679		930056	G51704		930153	70034		950 050	G52145	
930022	77715		930057	G63867		930159	G64026		950 055	G52009	
930022	77808		930057	G64157		930160	G51848		950 055	G52171	
930023	G63409		930058	G51719		930161	G64056		950 060	G51850	
930023	G63414		930060	G51729		930162	G64063		950 061	G52144	
930024	58809		930063	G63918		930163	G64050		950 064	G56841	
930025	G63716		930065	G64027		930165	G64089		950 065	G56840	
930026	77810		930066	G64028		930166	G511004		950 068	G52188	
930028	77524		930068	G51804		930167	G51993		950 069	G52187	
930029	G63676		930068	G51805		930170	G51928		950 070	G51815	
930029	G63873		930069	G64046		930171	G51928		950 071	G52295	
930030	77423		930072	69900		930189	G63872		950 073	G52199	
930031	77422		930073	61717		930191	G64031		950 074	G52200	
930032	G63349		930073	77971		930192	G51766		950 077	G51870	
930032	G63488		930074	61560		930197	G51880		950 077	G51891	
930033	77948		930074	81904		930198	G51858		950 077	G51949	
930034	58488		930075	61718		930199	G51855		950 078	G52007	
930034	77488		930077	61704		930200	G64038		950 079	G52004	
930035	G63675		930077	69909		930203	G64008		950 080	G52149	
930037	77638		930077	70010		930204	G63966		950 081	G52148	
930038	G63902		930079	G64000		930205	70010		950 082	G52210	
930039	61506		930081	G64001		930207	G64052		950 083	G52209	
930039	81318		930083	G63965		930218	G511000		950 085	G52173	
930040	58803		930084	G56807		950 002	G55697		950 086	G52174	

Important Note: Competitive Interchanges are to be used for stocking purposes only. Where multiple crosses are identified, please reference the applications section of this catalog. / **Remarque importante:** Les interchanges concurrentiels ne s'utilisent qu'aux fins de stocks. Dans le cas de rferences multiples, consulter la section des applications du catalogue. / **Nota importante:** Dans le cas de rferences multiples, consulter la section des applications du catalogue. / **Nota importante:** Se pueden usar intercambios competitivos para propósitos de almacenamiento solamente. Cuando se identifican intercambios múltiples, consulte la sección de aplicaciones de este catálogo.

COMPETITIVE & O.E.M. INTERCHANGE LIST
Lista de Intercambios contra Competidores y Equipo Original.
Liste dinterchange de produits comptitifs & dquipement original (OEM)

BOGE... cont'd

Boge	Gabriel	Upgrade	Boge	Gabriel	Upgrade	Boge	Gabriel	Upgrade	Boge	Gabriel	Upgrade
950 088	G52300		MP122	G55698		MP8419	G56899		MP8538	G56810	
950 089	G52299		MP8122	G55698		MP8427	G51746		MP8539	G56810	
950 093	G52348		MP8169	G55910		MP8434	G52406		MP8542	G52276	
950 094	G52349		MP8172	G55856		MP8434	G56817		MP8553	G51859	
950 095	G52301		MP8215	G55856		MP8451	G56635		MP8553	G51896	
950 108	G52185		MP8225	G55697		MP8453	G56671		MP8554	G51859	
950 109	G52184		MP8226	G55681		MP8454	G56672		MP8554	G51897	
950 117	G52348		MP8241	G56606		MP8461	G51727		MP8557	G56842	
950 118	G52349		MP8259	G55892		MP8466	G52176		MP8558	G56843	
950 121	G52127		MP8264	G56517		MP8472	G56802		MP8563	G52117	
950 122	G52128		MP8265	G56516		MP8474	G56672		MP8564	G52118	
950 124	G52131		MP8273	G55949		MP8475	G56671		MP8565	G52382	
950 124	G64042		MP8274	G55948		MP8477	G52175		MP8566	G52383	
950 125	G52201		MP8294	G51267		MP8480	G55999		MP8575	G52172	
950 126	G52202		MP8295	G51268		MP8481	G55999		MP8579	G52142	
950 127	G52203		MP8305	G55901		MP8482	G55662		MP8580	G52143	
950 128	G52204		MP8308	G56620		MP8483	G55661		MP8611	G52297	
950 131	G52150		MP8321	G55896		MP8485	G56636		MP8612	G52298	
950 132	G52151		MP8338	G51097		MP8489	G51761		MP8619	G52276	
950 133	G52112		MP8365	G51740		MP8490	G51760		MP8620	G52275	
950 134	G52113		MP8374	G52165		MP8495	G52081		MP8621	G52274	
950 136	G52261		MP8375	G52164		MP8496	G52082		MP8642	G52104	
950 137	G52260		MP8390	G56622		MP8499	G52121		MP8643	G52103	
950 138	G52254		MP8391	G56621		MP8500	G52122		MP8655	G52152	
950 139	G52253		MP8392	G56792		MP8501	G52094		MP8656	G52153	
950 142	G52202		MP8402	G56722		MP8502	G52095		MP8681	G51877	
950 143	G52201		MP8403	G56721		MP8526	G52153		MP8682	G51878	
950 146	G52033		MP8404	G56729		MP8527	G52152		MP8683	G51892	
950 147	G52032		MP8405	G56728		MP8528	G52155		MP8684	G52246	
950 148	G52361		MP8406	G52013		MP8529	G52154		MP8685	G52245	
950 149	G52360		MP8406	G56660		MP8531	G56894		MP8686	G52256	
950 152	G51815		MP8407	G52014		MP8533	G52005		MP8687	G52255	
950 153	G52524		MP8407	G56661		MP8534	G52006		SK-003	143058	
950 154	G52525		MP8417	G51738		MP8536	G56887		SK-004	143059	
MP009	G55551		MP8418	G51700		MP8537	G56886		SK-006	143063	

Boystun Equipment Manufacturing

Boystun equipment manufacturing	Gabriel	Upgrade	Boystun equipment manufacturing	Gabriel	Upgrade	Boystun equipment manufacturing	Gabriel	Upgrade	Boystun equipment manufacturing	Gabriel	Upgrade
1253069B000	85005	89430	1253069B000	89430							

Brockway School Bus

Brockway school bus	Gabriel	Upgrade	Brockway school bus	Gabriel	Upgrade	Brockway school bus	Gabriel	Upgrade	Brockway school bus	Gabriel	Upgrade
14QK-281P10	85305		14QK282P1	83216		508657	85307		530873	89407	
14QK-282P1	83216		14QK282P3	83216		515231	85303	89422	532397	85307	
14QK-282P3	83216		152398	85304		515231	89422				
14QK281P10	85305		152412	83215		530873	83207	89407			

Built Rite

Built rite	Gabriel	Upgrade	Built rite	Gabriel	Upgrade	Built rite	Gabriel	Upgrade	Built rite	Gabriel	Upgrade
318-06-100	85006		70039	85303	89422	70041	85305				
31806100	85006		70039	89422							

Bull Dog

Bull dog	Gabriel	Upgrade	Bull dog	Gabriel	Upgrade	Bull dog	Gabriel	Upgrade	Bull dog	Gabriel	Upgrade
HD1113-0406	83400		HD1116-0041	85300	89419	HD1116-0046	85702		HD1116-0059	85332	
HD1114-0257	83026		HD1116-0041	89419		HD1116-0047	85304		HD1213-0651	83021	
HD1114-0258	83169		HD1116-0043	85303	89422	HD1116-0048	85711		HD1213-0652	83031	
HD1116-0033	85311	89424	HD1116-0043	89422		HD1116-0049	85729				
HD1116-0033	89424		HD1116-0044	85302	89420	HD1116-0050	85970				
HD1116-0034	85711		HD1116-0044	89420		HD1116-0051	85341				
HD1116-0036	85736		HD1116-0045	85712		HD1116-0052	85727				

Important Note: Competitive Interchanges are to be used for stocking purposes only. Where multiple crosses are identified, please reference the applications section of this catalog. / **Remarque importante:** Les interchanges concurrentiels ne s'utilisent qu'aux fins de stocks. Dans le cas de rferences multiples, consulter la section des applications du catalogue. / **Nota importante:** En el caso de rferencias multiples, consultar la seccion de aplicaciones del catalogo. / **Nota importante:** Se pueden usar intercambios competitivos para propósitos de almacenamiento solamente. Cuando se identifican intercambios múltiples, consulte la sección de aplicaciones de este catálogo.

COMPETITIVE & O.E.M. INTERCHANGE LIST
Lista de Intercambios contra Competidores y Equipo Original.
Liste dinterchange de produits comptitifs & dquipement original (OEM)

Bull Dog... cont'd

Bull dog	Gabriel	Upgrade	Bull dog	Gabriel	Upgrade	Bull dog	Gabriel	Upgrade	Bull dog	Gabriel	Upgrade
HD1213-0674	83401		HD1214-0565	83110		HD1215-0024	85918	89449	HD1215-0051	85081	
HD1213-0679	83023		HD1214-0566	83123	89405	HD1215-0024	85920	89503	HD1215-0052	85316	89426
HD1213-0680	83017		HD1214-0566	89405		HD1215-0024	89449		HD1215-0052	89426	
HD1213-0705	85006		HD1214-0567	83215		HD1215-0024	89503		HD1215-0053	85933	89454
HD1213-0707	83034		HD1214-0568	83225		HD1215-0025	85918	89449	HD1215-0053	89454	
HD1214-0496	83041		HD1214-0568	85007		HD1215-0025	85958		HD1215-0054	85909	
HD1214-0497	83054		HD1214-0569	83035		HD1215-0025	89449		HD1215-0055	85656	
HD1214-0499	85045		HD1214-0570	89430		HD1215-0026	85331		HD1215-0056	85012	89413
HD1214-0500	83128	89436	HD1214-0571	83159		HD1215-0027	85924	89457	HD1215-0056	89413	
HD1214-0500	89436		HD1214-0572	83163		HD1215-0027	89457		HD1215-0058	85053	89442
HD1214-0507	646155		HD1214-0573	83025		HD1215-0028	85003	89411	HD1215-0058	89442	
HD1214-0508	83203	89436	HD1214-0574	83103		HD1215-0028	89411		HD1215-0059	83123	89405
HD1214-0508	89436		HD1214-0576	83029		HD1215-0029	85320	89429	HD1215-0059	89405	
HD1214-0526	83613		HD1214-0579	83221		HD1215-0029	89429		HD1215-0060	85959	
HD1214-0528	83112		HD1214-0580	83209	89414	HD1215-003	85033	89427	HD1215-0061	85012	89413
HD1214-0530	83123	89405	HD1214-0580	89414		HD1215-003	89427		HD1215-0061	89413	
HD1214-0530	89405		HD1214-0593	83120		HD1215-0030	85066	89448	HD1215-0062	85910	
HD1214-0531	83130		HD1214-0595	83308		HD1215-0030	85088		HD1215-0063	83317	
HD1214-0532	83125		HD1214-0597	85066	89448	HD1215-0030	89448		HD1215-0064	85319	89428
HD1214-0533	83124	89407	HD1214-0597	89448		HD1215-0031	85069	89455	HD1215-0064	89428	
HD1214-0533	89407		HD1214-0602	83120		HD1215-0031	89455		HD1215-0065	85937	
HD1214-0534	83127		HD1214-0603	83150		HD1215-0032	85062	89408	HD1215-0066	85029	
HD1214-0534	83207	89407	HD1214-0605	85012	89413	HD1215-0032	89408		HD1215-0067	83111	
HD1214-0534	89407		HD1214-0605	89413		HD1215-0033	85311	89424	HD1215-0069	85072	
HD1214-0535	83009		HD1214-0607	83154		HD1215-0033	89424		HD1215-0071	85005	89430
HD1214-0536	83042		HD1214-0608	83303		HD1215-0034	85067	89451	HD1215-0071	89430	
HD1214-0537	83051		HD1214-0609	85310	89423	HD1215-0034	89451		HD1215-0072	85938	
HD1214-0538	83038		HD1214-0609	89423		HD1215-0036	85001	89410	HD1215-0073	85976	
HD1214-0539	83126	89430	HD1214-0610	83027		HD1215-0036	89410		HD1215-0074	85061	89450
HD1214-0539	89430		HD1214-0611	83134		HD1215-0038	85023	89415	HD1215-0075	85052	
HD1214-0540	83029		HD1214-0612	85033	89427	HD1215-0038	89415		HD1215-0076	85069	89455
HD1214-0540	83515		HD1214-0612	89427		HD1215-0039	85000	89436	HD1215-0076	89455	
HD1214-0541	83019		HD1214-0613	83022		HD1215-0039	89436		HD1215-0077	85900	
HD1214-0542	85052		HD1214-0614	83015		HD1215-0040	83128	89436	HD1215-0078	85036	89405
HD1214-0544	83001		HD1214-0636	83047		HD1215-0040	89436		HD1215-0078	89405	
HD1214-0545	83456	89447	HD1214-0637	83059		HD1215-0041	85923	89458	HD1215-0079	85919	
HD1214-0545	89447		HD1214-0639	83004		HD1215-0041	85931	89458	HD1215-0080	85954	
HD1214-0546	83008		HD1214-0640	83216		HD1215-0041	89458		HD1215-0081	83136	
HD1214-0550	83314		HD1214-0641	83216		HD1215-0042	85014		HD1215-0082	85311	89424
HD1214-0551	83126	89430	HD1214-0642	83135		HD1215-0042	85906	89407	HD1215-0082	89424	
HD1214-0551	83207	89407	HD1214-0644	83635		HD1215-0042	89407		HD1215-0083	85978	
HD1214-0551	89407		HD1214-0645	83119		HD1215-0043	85013	89414	HD1215-0084	83135	
HD1214-0551	89430		HD1214-0655	83130		HD1215-0043	89414		HD1215-0084	83163	
HD1214-0553	83045		HD1214-0656	83103		HD1215-0044	85046	89434	HD1215-0085	85310	89423
HD1214-0554	83048		HD1214-0657	83164		HD1215-0044	89434		HD1215-0085	89423	
HD1214-0556	83136		HD1214-0658	83308		HD1215-0045	85013	89414	HD1215-0086	85936	89456
HD1214-0557	83101		HD1214-0660	83107		HD1215-0045	89414		HD1215-0086	89456	
HD1214-0558	83169		HD1214-0661	83318		HD1215-0046	85045		HD1215-0088	85006	
HD1214-0559	83309		HD1215-0018	85724	89443	HD1215-0046	85939		HD1215-0089	85303	89422
HD1214-0560	83141		HD1215-0018	89443		HD1215-0047	85934		HD1215-0089	89422	
HD1214-0561	85071		HD1215-0020	85070	89459	HD1215-0048	85084	89460	HD1215-0090	85972	
HD1214-0562	83312	89409	HD1215-0020	89459		HD1215-0048	85989		HD1215-0091	85321	
HD1214-0562	89409		HD1215-0021	85901		HD1215-0048	89460		HD1215-0091	85916	89430
HD1214-0563	83215		HD1215-0022	85928		HD1215-0049	85047	89435	HD1215-0091	89430	
HD1214-0564	83312	89409	HD1215-0022	85957		HD1215-0049	89435		HD1215-0092	85916	89430
HD1214-0564	89409		HD1215-0023	85031		HD1215-0051	85026		HD1215-0092	89430	

Important Note: Competitive Interchanges are to be used for stocking purposes only. Where multiple crosses are identified, please reference the applications section of this catalog. / **Remarque importante:** Les interchanges concurrentiels ne s'utilisent qu'aux fins de stocks. Dans le cas de références multiples, consulter la section des applications du catalogue. / **Nota importante:** Dans le cas de références multiples, consulter la section des applications du catalogue. / **Nota importante:** Se pueden usar intercambios competitivos para propósitos de almacenamiento solamente. Cuando se identifican intercambios múltiples, consulte la sección de aplicaciones de este catálogo.

COMPETITIVE & O.E.M. INTERCHANGE LIST
Lista de Intercambios contra Competidores y Equipo Original.
Liste dinterchange de produits comptitifs & dquipement original (OEM)

Bull Dog... cont'd

Bull dog	Gabriel	Upgrade	Bull dog	Gabriel	Upgrade	Bull dog	Gabriel	Upgrade	Bull dog	Gabriel	Upgrade
HD1215-0093	83209	89414	HD1215-0107	89410		HD1215-0119	85954		HD1215-0147	85927	
HD1215-0093	89414		HD1215-0108	85030	89440	HD1215-0122	85090		HD1215-0148	85181	
HD1215-0094	83142		HD1215-0108	89440		HD1215-0123	83131		HD1215-0149	85700	
HD1215-0095	83175		HD1215-0109	85065		HD1215-0124	85024		HD1215-0150	85029	
HD1215-0096	85029		HD1215-0110	83122	89406	HD1215-0125	85080		HD1215-0151	85010	
HD1215-0097	85300	89419	HD1215-0110	89406		HD1215-0125	85081		HD1215-0152	83144	
HD1215-0097	89419		HD1215-0111	85043		HD1215-0126	85376		HD1215-0154	85995	
HD1215-0100	85648		HD1215-0113	85736		HD1215-0127	85082		HD1215-0156	83136	
HD1215-0102	85938		HD1215-0114	85058	89431	HD1215-0128	85054		HD1215-0157	85030	89440
HD1215-0103	85932	89453	HD1215-0114	89431		HD1215-0129	85967		HD1215-0157	89440	
HD1215-0103	89453		HD1215-0115	85058	89431	HD1215-0132	83143		HD1215-0160	85125	
HD1215-0104	85956		HD1215-0115	89431		HD1215-0133	83122	89406	HD1215-0161	85929	
HD1215-0106	85323	89436	HD1215-0116	85058	89431	HD1215-0133	89406		HD1215-0165	85338	
HD1215-0106	85738		HD1215-0116	89431		HD1215-0134	89402		HD1216-0005	87015	
HD1215-0106	89436		HD1215-0117	85910		HD1215-0135	85040		HD1294-0002	632147	
HD1215-0107	85001	89410	HD1215-0118	83160		HD1215-0136	85102		HD5115-0001	665937	

Bus & Truck Co.

Bus & truck co.	Gabriel	Upgrade	Bus & truck co.	Gabriel	Upgrade	Bus & truck co.	Gabriel	Upgrade	Bus & truck co.	Gabriel	Upgrade
680091	85303	89422	70039	85303	89422	70041	85305				
680091	89422		70039	89422							

CargoMaxx

Cargomaxx	Gabriel	Upgrade	Cargomaxx	Gabriel	Upgrade	Cargomaxx	Gabriel	Upgrade	Cargomaxx	Gabriel	Upgrade
441 - 646155	646155		441 - 83156	83169		441 - 850125113	85012	89413	441 - 85062	85062	89408
441 - 83001	83001		441 - 831635143	83163		441 - 850125113	89413		441 - 85062	89408	
441 - 83008	83008		441 - 831636422	83163		441 - 850135401	85013	89414	441 - 85066	85066	89448
441 - 83009	83009		441 - 832036634	83203	89436	441 - 850135401	89414		441 - 85066	89448	
441 - 83021	83021		441 - 832036634	89436		441 - 850135420	85013	89414	441 - 85067	85067	89451
441 - 83025	83025		441 - 832036893	83203	89436	441 - 850135420	89414		441 - 85067	89451	
441 - 83031	83031		441 - 832036893	89436		441 - 85023	85023	89415	441 - 850695468	85069	89455
441 - 83038	83038		441 - 83209	83209	89414	441 - 85023	89415		441 - 850695468	89455	
441 - 83041	83041		441 - 83209	89414		441 - 85024	85024		441 - 850695528	85069	89455
441 - 83042	83042		441 - 83215	83215		441 - 85026	85026		441 - 850695528	89455	
441 - 83048	83048		441 - 83221	83221		441 - 85029	85029		441 - 85070	85070	89459
441 - 83051	83051		441 - 83309	83309		441 - 850295451	85029		441 - 85070	89459	
441 - 83110	83110		441 - 833126668	83312	89409	441 - 85030	85030	89440	441 - 85072	85072	
441 - 83111	83111		441 - 833126668	89409		441 - 85030	89440		441 - 85084	85084	89460
441 - 83112	83112		441 - 833126811	83312	89409	441 - 85031	85031		441 - 85084	89460	
441 - 83122	83122	89406	441 - 833126811	89409		441 - 85033	85033	89427	441 - 85090	85090	
441 - 83122	89406		441 - 83317	83317		441 - 85033	89427		441 - 85119	85119	
441 - 83123	83123	89405	441 - 83456	83456	89447	441 - 850365411	85036	89405	441 - 85300	85300	89419
441 - 83123	89405		441 - 83456	89447		441 - 850365411	89405		441 - 85300	89419	
441 - 83124	83124	89407	441 - 83515	83515		441 - 850365481	85036	89405	441 - 853006861	85300	89419
441 - 83124	89407		441 - 83613	83613		441 - 850365481	89405		441 - 853006861	89419	
441 - 83125	83125		441 - 850005416	85000	89436	441 - 85045	85045		441 - 85302	85302	89420
441 - 831266833	83126	89430	441 - 850005416	89436		441 - 85046	85046	89434	441 - 85302	89420	
441 - 831266833	89430		441 - 850005419	85000	89436	441 - 85046	89434		441 - 85303	85303	89422
441 - 831266897	83126	89430	441 - 850005419	89436		441 - 85047	85047	89435	441 - 85303	89422	
441 - 831266897	89430		441 - 85001	85001	89410	441 - 85047	89435		441 - 85310	85310	89423
441 - 831266969	83126	89430	441 - 85001	89410		441 - 850525510	85052		441 - 85310	89423	
441 - 831266969	89430		441 - 85003	85003	89411	441 - 850526607	85052		441 - 853104409	85310	89423
441 - 83127	83127		441 - 85003	89411		441 - 85053	85053	89442	441 - 853104409	89423	
441 - 83128	83128	89436	441 - 85005	85005	89430	441 - 85053	89442		441 - 853114417	85311	89424
441 - 83128	89436		441 - 85005	89430		441 - 850585109	85058	89431	441 - 853114417	89424	
441 - 83130	83130		441 - 850065482	85006		441 - 850585109	89431				
441 - 83136	83136		441 - 850065505	85006		441 - 850585478	85058	89431			
441 - 83142	83142		441 - 85012	85012	89413	441 - 850585478	89431				
441 - 83143	83143		441 - 85012	89413		441 - 85061	85061	89450			

Important Note: Competitive Interchanges are to be used for stocking purposes only. Where multiple crosses are identified, please reference the applications section of this catalog. / **Remarque importante:** Les interchanges concurrentiels ne s'utilisent qu'aux fins de stocks. Dans le cas de rfrences multiples, consulter la section des applications du catalogue. / **Nota importante:** Dans le cas de rfrences multiples, consultar la section des aplicaciones du catalogue. / **Nota importante:** Se pueden usar intercambios competitivos para propósitos de almacenamiento solamente. Cuando se identifican intercambios múltiples, consulte la sección de aplicaciones de este catálogo.

COMPETITIVE & O.E.M. INTERCHANGE LIST
Lista de Intercambios contra Competidores y Equipo Original.
Liste dinterchange de produits comptitifs & dquipement original (OEM)

CargoMaxx... cont'd

Cargomaxx	Gabriel	Upgrade	Cargomaxx	Gabriel	Upgrade	Cargomaxx	Gabriel	Upgrade	Cargomaxx	Gabriel	Upgrade
441 - 853115402	85311	89424	441 - 85738	85738		441 - 85931	85931	89458	441 - 85972	85972	
441 - 853115402	89424		441 - 85900	85900		441 - 85931	89458		441 - 85976	85976	
441 - 853115444	85311	89424	441 - 85901	85901		441 - 85932	85932	89453	441 - 85978	85978	
441 - 853115444	89424		441 - 85906	85906	89407	441 - 85932	89453		441 - 87015	87015	
441 - 85316	85316	89426	441 - 85906	89407		441 - 85933	85933	89454	441-65514	89405	
441 - 85316	89426		441 - 85909	85909		441 - 85933	89454		441-83124	83124	89407
441 - 85319	85319	89428	441 - 85910	85910		441 - 85934	85934		441-85045	85045	
441 - 85319	89428		441 - 859185140	85918	89449	441 - 85936	85936	89456	441-85046	85046	89434
441 - 85320	85320	89429	441 - 859185140	89449		441 - 85936	89456		441-85061	89450	
441 - 85320	89429		441 - 859185148	85918	89449	441 - 85937	85937		441-853114417	85311	89424
441 - 85321	85321		441 - 859185148	89449		441 - 85938	85938		441-853115402	85311	89424
441 - 85323	85323	89436	441 - 85919	85919		441 - 85939	85939		441-853115444	85311	89424
441 - 85323	89436		441 - 85924	85924	89457	441 - 85954	85954		441-85323	85323	89436
441 - 85724	85724	89443	441 - 85924	89457		441 - 85956	85956		441-85933	89454	
441 - 85724	89443		441 - 85925	85648		441 - 85957	85957		441-85959	85959	
441 - 85736	85736		441 - 85926	85656		441 - 85959	85959				

Carpenter Bus

Carpenter bus	Gabriel	Upgrade	Carpenter bus	Gabriel	Upgrade	Carpenter bus	Gabriel	Upgrade	Carpenter bus	Gabriel	Upgrade
0272-SS5	85712		0272SS5	85712		63-0001	85713		630001	85713	

Carquest

Carquest	Gabriel	Upgrade	Carquest	Gabriel	Upgrade	Carquest	Gabriel	Upgrade	Carquest	Gabriel	Upgrade
MON-65158	85954		MON-65420	85013	89414	MON-65497	85933	89454			

Cascade Trailer

Cascade trailer	Gabriel	Upgrade	Cascade trailer	Gabriel	Upgrade	Cascade trailer	Gabriel	Upgrade	Cascade trailer	Gabriel	Upgrade
120-1	83125		1201	83125							

Caterpillar

Caterpillar	Gabriel	Upgrade	Caterpillar	Gabriel	Upgrade	Caterpillar	Gabriel	Upgrade	Caterpillar	Gabriel	Upgrade
060665-011	85967		60665-011L	85967		60680-004	83143		60680005	83142	
606657-003	85072		60665011	85967		60680-004L	83143		60680005L	83142	
606657-003L	85072		60670-005	83137		60680-005	83142		H60680004	83143	
606657003	85072		60670-005L	83137		60680-005L	83142		HDR60680-005	83142	
606657003L	85072		60670005	83137		60680004	83143		HDR60680005	83142	
60665-011	85967		60670005L	83137		60680004L	83143				

Challenge Cook

Challenge cook	Gabriel	Upgrade	Challenge cook	Gabriel	Upgrade	Challenge cook	Gabriel	Upgrade	Challenge cook	Gabriel	Upgrade
1540212	646155		1540459	646155		632147	632147		632155	646177	

Chalmers Suspension

Chalmers suspension	Gabriel	Upgrade	Chalmers suspension	Gabriel	Upgrade	Chalmers suspension	Gabriel	Upgrade	Chalmers suspension	Gabriel	Upgrade
21335	G63355		800781	85314	89425	K880233	85060		K880248	89425	
665174	85060		800781	89425		K880247	85060		K880642	85060	
800670	85060		K800199	85060		K880248	85314	89425			

Champion Bus Inc.

Champion bus inc.	Gabriel	Upgrade	Champion bus inc.	Gabriel	Upgrade	Champion bus inc.	Gabriel	Upgrade	Champion bus inc.	Gabriel	Upgrade
22064230	83136		8C2Z-18124-D	G63622		ASH-1154	G63622		AT163G	G63622	
8C24-18045-DA	G63622		8C2Z-18125-D	G63623		ASH1136	G63623		AT164G	G63623	
8C24-18080-DB	G63623		8C2Z18124D	G63622		ASH1154	G63622				
8C2418045DA	G63622		8C2Z18125D	G63623		AT-163G	G63622				
8C2418080DB	G63623		ASH-1136	G63623		AT-164G	G63623				

Chance Coach

Chance coach	Gabriel	Upgrade	Chance coach	Gabriel	Upgrade	Chance coach	Gabriel	Upgrade	Chance coach	Gabriel	Upgrade
2021459	85012	89413	59039	83207	89407	6892	89407		728600	89436	
2021459	89413		59039	89407		6893	83203	89436	AS789B	85014	
270-6708	85014		665017	85014		6893	89436				
2706708	85014		6892	83207	89407	728600	83203	89436			

Important Note: Competitive Interchanges are to be used for stocking purposes only. Where multiple crosses are identified, please reference the applications section of this catalog. / **Remarque importante:** Les interchanges concurrentiels ne s'utilisent qu'aux fins de stocks. Dans le cas de références multiples, consulter la section des applications du catalogue. / **Nota importante:** Dans le cas de referencias multiples, consultar la sección de aplicaciones del catálogo. / **Nota importante:** Se pueden usar intercambios competitivos para propósitos de almacenamiento solamente. Cuando se identifican intercambios múltiples, consulte la sección de aplicaciones de este catálogo.

COMPETITIVE & O.E.M. INTERCHANGE LIST
Lista de Intercambios contra Competidores y Equipo Original.
Liste d'interchange de produits comptitifs & d'equipement original (OEM)

Clark Equipment

Clark equipment	Gabriel	Upgrade	Clark equipment	Gabriel	Upgrade	Clark equipment	Gabriel	Upgrade	Clark equipment	Gabriel	Upgrade
355778	85315		5532675	85307		680042	85301				

Classic Industries Catalog

Classic industries catalog	Gabriel	Upgrade	Classic industries catalog	Gabriel	Upgrade	Classic industries catalog	Gabriel	Upgrade	Classic industries catalog	Gabriel	Upgrade
61500	61500		61608	61608		61716	61716		69952	69952	
61501	61501		61611	61611		61717	61717		69962	69962	
61504	61504		61612	61612		61718	61718		69966	69966	
61506	61506		61613	61613		61720	61720		69996	69996	
61508	61508		61614	61614		61734	61734		69998	69998	
61509	61509		61615	61615		61777	61777		70000	70000	
61510	61510		61616	61616		69420	69420		70001	70001	
61512	61512		61623	61623		69450	69450		70003	70003	
61516	61516		61624	61624		69464	69464		70010	70010	
61517	61517		61625	61625		69465	69465		70013	70013	
61518	61518		61626	61626		69473	69473		70020	70020	
61519	61519		61627	61627		69574	69574		70024	70024	
61520	61520		61629	61629		69575	69575		70027	70027	
61521	61521		61632	61632		69585	69585		70028	70028	
61522	61522		61634	61634		69586	69586		70031	70031	
61523	61523		61635	61635		69587	69587		70033	70033	
61524	61524		61638	61638		69589	69589		70034	70034	
61525	61525		61641	61641		69590	69590		70036	70036	
61528	61528		61642	61642		69591	69591		70037	70037	
61529	61529		61643	61643		69592	69592		70038	70038	
61530	61530		61646	61646		69593	69593		70039	70039	
61531	61531		61651	61651		69594	69594		70040	70040	
61533	61533		61654	61654		69595	69595		70041	70041	
61535	61535		61655	61655		69600	69600		70045	70045	
61536	61536		61656	61656		69604	69604		70049	70049	
61539	61539		61658	61658		69606	69606		70052	70052	
61541	61541		61659	61659		69622	69622		70053	70053	
61542	61542		61662	61662		69624	69624		70055	70055	
61543	61543		61663	61663		69625	69625		70056	70056	
61544	61544		61664	61664		69632	69632		70059	70059	
61546	61546		61675	61675		69675	69675		70060	70060	
61547	61547		61676	61676		69676	69676		70064	70064	
61550	61550		61679	61679		69677	69677		70065	70065	
61552	61552		61680	61680		69714	69714		70068	70068	
61554	61554		61682	61682		69715	69715		70078	70078	
61555	61555		61683	61683		69724	69724		70086	70086	
61556	61556		61684	61684		69725	69725		70089	70089	
61560	61560		61685	61685		69755	69755		70095	70095	
61561	61561		61687	61687		69757	69757		70096	70096	
61565	61565		61690	61690		69766	69766		70098	70098	
61573	61573		61691	61691		69787	69787		70102	70102	
61575	61575		61692	61692		69795	69795		70203	70203	
61582	61582		61696	61696		69811	69811		70204	70204	
61584	61584		61697	61697		69813	69813		70207	70207	
61590	61590		61699	61699		69845	69845		70208	70208	
61591	61591		61700	61700		69863	69863		70209	70209	
61592	61592		61703	61703		69898	69898		70210	70210	
61593	61593		61704	61704		69900	69900		70213	70213	
61595	61595		61710	61710		69901	69901		70231	70231	
61599	61599		61711	61711		69903	69903		81039	81039	
61600	61600		61712	61712		69907	69907				
61601	61601		61713	61713		69909	69909				
61605	61605		61714	61714		69945	69945				
61606	61606		61715	61715		69946	69946				

Important Note: Competitive Interchanges are to be used for stocking purposes only. Where multiple crosses are identified, please reference the applications section of this catalog. / **Remarque importante:** Les interchanges concurrentiels ne s'utilisent qu'aux fins de stocks. Dans le cas de rfrences multiples, consulter la section des applications du catalogue. / **Nota importante:** Dans le cas de rfrences multiples, consulter la section des applications du catalogue. / **Nota importante:** Se pueden usar intercambios competitivos para propósitos de almacenamiento solamente. Cuando se identifican intercambios múltiples, consulte la sección de aplicaciones de este catálogo.

COMPETITIVE & O.E.M. INTERCHANGE LIST
Lista de Intercambios contra Competidores y Equipo Original.
Liste dinterchange de produits comptitifs & dquipement original (OEM)

Classic Industries Catalog... cont'd

Classic industries catalog	Gabriel	Upgrade	Classic industries catalog	Gabriel	Upgrade	Classic industries catalog	Gabriel	Upgrade	Classic industries catalog	Gabriel	Upgrade
81076	81076		81828	81828		82035	82035		G511092	G511092	
81082	81082		81833	81833		82039	82039		G511122	G511122	
81091	81091		81834	81834		82040	82040		G511134	G511134	
81095	81095		81836	81836		82047	82047		G511135	G511135	
81096	81096		81837	81837		82051	82051		G511142	G511142	
81113	81113		81869	81869		82060	82060		G51267	G51267	
81147	81147		81870	81870		82065	82065		G51268	G51268	
81153	81153		81871	81871		82066	82066		G51477	G51477	
81164	81164		81872	81872		82069	82069		G51700	G51700	
81242	81242		81873	81873		82070	82070		G51703	G51703	
81270	81270		81878	81878		82072	82072		G51704	G51704	
81318	81318		81880	81880		82075	82075		G51714	G51714	
81340	81340		81890	81890		82076	82076		G51715	G51715	
81342	81342		81891	81891		82079	82079		G51716	G51716	
81394	81394		81892	81892		82086	82086		G51718	G51718	
81416	81416		81893	81893		82087	82087		G51719	G51719	
81440	81440		81904	81904		82090	82090		G51721	G51721	
81446	81446		81905	81905		82099	82099		G51722	G51722	
81469	81469		81910	81910		82103	82103		G51723	G51723	
81478	81478		81911	81911		82104	82104		G51724	G51724	
81481	81481		81912	81912		82109	82109		G51727	G51727	
81482	81482		81913	81913		82110	82110		G51728	G51728	
81484	81484		81914	81914		82118	82118		G51729	G51729	
81490	81490		81916	81916		82125	82125		G51736	G51736	
81491	81491		81917	81917		82126	82126		G51738	G51738	
81492	81492		81918	81918		82128	82128		G51739	G51739	
81494	81494		81919	81919		82130	82130		G51740	G51740	
81495	81495		81920	81920		82131	82131		G51742	G51742	
81496	81496		81921	81921		82138	82138		G51746	G51746	
81507	81507		81922	81922		82147	82147		G51758	G51758	
81510	81510		81923	81923		82151	82151		G51759	G51759	
81514	81514		81924	81924		82155	82155		G51760	G51760	
81516	81516		81925	81925		82156	82156		G51761	G51761	
81540	81540		81926	81926		82601	82601		G51765	G51765	
81541	81541		81928	81928		82602	82602		G51766	G51766	
81548	81548		81929	81929		82609	82609		G51767	G51767	
81549	81549		81930	81930		82615	82615		G51773	G51773	
81553	81553		81931	81931		82618	82618		G51774	G51774	
81559	81559		81932	81932		G44461	G44461		G51783	G51783	
81560	81560		81933	81933		G51077	G51077		G51794	G51794	
81582	81582		81934	81934		G51087	G51087		G51795	G51795	
81583	81583		81935	81935		G51097	G51097		G51798	G51798	
81667	81667		81936	81936		G511000	G511000		G51799	G51799	
81668	81668		81937	81937		G511001	G511001		G51802	G51802	
81675	81675		82001	82001		G511002	G511002		G51803	G51803	
81676	81676		82003	82003		G511003	G511003		G51804	G51804	
81691	81691		82004	82004		G511004	G511004		G51805	G51805	
81710	81710		82005	82005		G511007	G511007		G51806	G51806	
81713	81713		82007	82007		G511030	G511030		G51807	G51807	
81726	81726		82010	82010		G511037	G511037		G51812	G51812	
81730	81730		82011	82011		G511038	G511038		G51813	G51813	
81744	81744		82012	82012		G511043	G511043		G51814	G51814	
81750	81750		82025	82025		G511044	G511044		G51815	G51815	
81794	81794		82026	82026		G511054	G511054		G51825	G51825	
81821	81821		82032	82032		G511055	G511055		G51832	G51832	
81825	81825		82034	82034		G511078	G511078		G51833	G51833	

Important Note: Competitive Interchanges are to be used for stocking purposes only. Where multiple crosses are identified, please reference the applications section of this catalog. / **Remarque importante:** Les interchanges concurrentiels ne s'utilisent qu'aux fins de stocks. Dans le cas de rfrences multiples, consulter la section des applications du catalogue. / **Nota importante:** Dans le cas de rfrences multiples, consulter la section des applications du catalogue. / **Nota importante:** Se pueden usar intercambios competitivos para propósitos de almacenamiento solamente. Cuando se identifican intercambios múltiples, consulte la sección de aplicaciones de este catálogo.

COMPETITIVE & O.E.M. INTERCHANGE LIST
Lista de Intercambios contra Competidores y Equipo Original.
Liste d'interchange de produits compititifs & d'equipement original (OEM)

Classic Industries Catalog... cont'd

Classic industries catalog	Gabriel	Upgrade	Classic industries catalog	Gabriel	Upgrade	Classic industries catalog	Gabriel	Upgrade	Classic industries catalog	Gabriel	Upgrade
G51838	G51838		G51937	G51937		G52121	G52121		G52238	G52238	
G51841	G51841		G51947	G51947		G52122	G52122		G52244	G52244	
G51842	G51842		G51948	G51948		G52125	G52125		G52245	G52245	
G51847	G51847		G51949	G51949		G52127	G52127		G52246	G52246	
G51848	G51848		G51961	G51961		G52128	G52128		G52247	G52247	
G51849	G51849		G51965	G51965		G52129	G52129		G52248	G52248	
G51850	G51850		G51966	G51966		G52130	G52130		G52249	G52249	
G51852	G51852		G51971	G51971		G52131	G52131		G52250	G52250	
G51853	G51853		G51972	G51972		G52140	G52140		G52253	G52253	
G51854	G51854		G51975	G51975		G52141	G52141		G52254	G52254	
G51855	G51855		G51980	G51980		G52142	G52142		G52255	G52255	
G51856	G51856		G51982	G51982		G52143	G52143		G52256	G52256	
G51858	G51858		G51983	G51983		G52144	G52144		G52257	G52257	
G51859	G51859		G51990	G51990		G52145	G52145		G52258	G52258	
G51860	G51860		G51992	G51992		G52148	G52148		G52260	G52260	
G51861	G51861		G51993	G51993		G52149	G52149		G52261	G52261	
G51863	G51863		G51994	G51994		G52150	G52150		G52264	G52264	
G51864	G51864		G51995	G51995		G52151	G52151		G52265	G52265	
G51865	G51865		G51996	G51996		G52152	G52152		G52274	G52274	
G51870	G51870		G52004	G52004		G52153	G52153		G52275	G52275	
G51871	G51871		G52005	G52005		G52154	G52154		G52276	G52276	
G51874	G51874		G52006	G52006		G52155	G52155		G52278	G52278	
G51877	G51877		G52007	G52007		G52156	G52156		G52279	G52279	
G51878	G51878		G52008	G52008		G52157	G52157		G52280	G52280	
G51879	G51879		G52009	G52009		G52158	G52158		G52281	G52281	
G51880	G51880		G52013	G52013		G52159	G52159		G52282	G52282	
G51881	G51881		G52014	G52014		G52160	G52160		G52283	G52283	
G51883	G51883		G52017	G52017		G52161	G52161		G52293	G52293	
G51884	G51884		G52018	G52018		G52162	G52162		G52294	G52294	
G51887	G51887		G52025	G52025		G52163	G52163		G52295	G52295	
G51888	G51888		G52026	G52026		G52164	G52164		G52297	G52297	
G51891	G51891		G52027	G52027		G52165	G52165		G52298	G52298	
G51892	G51892		G52032	G52032		G52168	G52168		G52299	G52299	
G51896	G51896		G52033	G52033		G52169	G52169		G52300	G52300	
G51897	G51897		G52036	G52036		G52170	G52170		G52301	G52301	
G51898	G51898		G52037	G52037		G52171	G52171		G52314	G52314	
G51899	G51899		G52081	G52081		G52172	G52172		G52329	G52329	
G51900	G51900		G52082	G52082		G52173	G52173		G52330	G52330	
G51901	G51901		G52094	G52094		G52174	G52174		G52331	G52331	
G51904	G51904		G52095	G52095		G52175	G52175		G52332	G52332	
G51905	G51905		G52096	G52096		G52176	G52176		G52335	G52335	
G51908	G51908		G52097	G52097		G52182	G52182		G52336	G52336	
G51910	G51910		G52098	G52098		G52183	G52183		G52348	G52348	
G51911	G51911		G52103	G52103		G52184	G52184		G52349	G52349	
G51914	G51914		G52104	G52104		G52185	G52185		G52351	G52351	
G51916	G51916		G52105	G52105		G52187	G52187		G52352	G52352	
G51919	G51919		G52106	G52106		G52188	G52188		G52353	G52353	
G51920	G51920		G52107	G52107		G52199	G52199		G52354	G52354	
G51921	G51921		G52108	G52108		G52200	G52200		G52355	G52355	
G51922	G51922		G52110	G52110		G52201	G52201		G52356	G52356	
G51925	G51925		G52111	G52111		G52202	G52202		G52360	G52360	
G51926	G51926		G52112	G52112		G52203	G52203		G52361	G52361	
G51928	G51928		G52113	G52113		G52204	G52204		G52374	G52374	
G51930	G51930		G52116	G52116		G52209	G52209		G52375	G52375	
G51933	G51933		G52117	G52117		G52210	G52210		G52382	G52382	
G51934	G51934		G52118	G52118		G52237	G52237		G52383	G52383	

Important Note: Competitive Interchanges are to be used for stocking purposes only. Where multiple crosses are identified, please reference the applications section of this catalog. / **Remarque importante:** Les interchanges concurrentiels ne s'utilisent qu'aux fins de stocks. Dans le cas de rfrences multiples, consulter la section des applications du catalogue. / **Nota importante:** Dans le cas de rfrences multiples, consulter la section des applications du catalogue. / **Nota importante:** Se pueden usar intercambios competitivos para propósitos de almacenamiento solamente. Cuando se identifican intercambios múltiples, consulte la sección de aplicaciones de este catálogo.

COMPETITIVE & O.E.M. INTERCHANGE LIST
Lista de Intercambios contra Competidores y Equipo Original.
Liste dinterchange de produits comptitifs & dquipement original (OEM)

Classic Industries Catalog... cont'd

Classic industries catalog	Gabriel	Upgrade	Classic industries catalog	Gabriel	Upgrade	Classic industries catalog	Gabriel	Upgrade	Classic industries catalog	Gabriel	Upgrade
G52395	G52395		G56561	G56561		G56799	G56799		G56994	G56994	
G52396	G52396		G56562	G56562		G56800	G56800		G56995	G56995	
G52398	G52398		G56565	G56565		G56802	G56802		G56996	G56996	
G52399	G52399		G56568	G56568		G56807	G56807		G56997	G56997	
G52406	G52406		G56571	G56571		G56809	G56809		G56998	G56998	
G52410	G52410		G56581	G56581		G56810	G56810		G57000	G57000	
G52411	G52411		G56582	G56582		G56817	G56817		G57005	G57005	
G52437	G52437		G56591	G56591		G56819	G56819		G57006	G57006	
G52438	G52438		G56597	G56597		G56820	G56820		G57007	G57007	
G52439	G52439		G56598	G56598		G56821	G56821		G57008	G57008	
G52440	G52440		G56601	G56601		G56822	G56822		G57010	G57010	
G52449	G52449		G56606	G56606		G56836	G56836		G57011	G57011	
G52450	G52450		G56615	G56615		G56837	G56837		G57012	G57012	
G52494	G52494		G56616	G56616		G56838	G56838		G57013	G57013	
G52495	G52495		G56620	G56620		G56839	G56839		G57014	G57014	
G52524	G52524		G56621	G56621		G56840	G56840		G57015	G57015	
G52525	G52525		G56622	G56622		G56841	G56841		G57016	G57016	
G52906	G52906		G56633	G56633		G56842	G56842		G57017	G57017	
G52907	G52907		G56634	G56634		G56843	G56843		G57018	G57018	
G55551	G55551		G56635	G56635		G56886	G56886		G57019	G57019	
G55591	G55591		G56636	G56636		G56887	G56887		G57020	G57020	
G55661	G55661		G56637	G56637		G56892	G56892		G57021	G57021	
G55662	G55662		G56640	G56640		G56893	G56893		G57022	G57022	
G55675	G55675		G56641	G56641		G56894	G56894		G57023	G57023	
G55676	G55676		G56655	G56655		G56899	G56899		G57026	G57026	
G55681	G55681		G56660	G56660		G56924	G56924		G57027	G57027	
G55697	G55697		G56661	G56661		G56925	G56925		G57030	G57030	
G55698	G55698		G56671	G56671		G56927	G56927		G57031	G57031	
G55772	G55772		G56672	G56672		G56928	G56928		G57032	G57032	
G55774	G55774		G56679	G56679		G56929	G56929		G57033	G57033	
G55804	G55804		G56680	G56680		G56930	G56930		G57034	G57034	
G55820	G55820		G56687	G56687		G56931	G56931		G57035	G57035	
G55821	G55821		G56688	G56688		G56932	G56932		G57036	G57036	
G55825	G55825		G56700	G56700		G56933	G56933		G57037	G57037	
G55856	G55856		G56701	G56701		G56934	G56934		G57038	G57038	
G55892	G55892		G56718	G56718		G56935	G56935		G57039	G57039	
G55896	G55896		G56721	G56721		G56936	G56936		G57040	G57040	
G55901	G55901		G56722	G56722		G56937	G56937		G57041	G57041	
G55910	G55910		G56726	G56726		G56938	G56938		G57042	G57042	
G55911	G55911		G56728	G56728		G56943	G56943		G57043	G57043	
G55948	G55948		G56729	G56729		G56948	G56948		G57044	G57044	
G55949	G55949		G56730	G56730		G56949	G56949		G57045	G57045	
G55993	G55993		G56731	G56731		G56950	G56950		G57046	G57046	
G55994	G55994		G56732	G56732		G56951	G56951		G57047	G57047	
G55999	G55999		G56733	G56733		G56956	G56956		G57048	G57048	
G56506	G56506		G56734	G56734		G56957	G56957		G57049	G57049	
G56509	G56509		G56735	G56735		G56962	G56962		G57050	G57050	
G56514	G56514		G56758	G56758		G56963	G56963		G57051	G57051	
G56516	G56516		G56759	G56759		G56964	G56964		G57053	G57053	
G56517	G56517		G56773	G56773		G56965	G56965		G57054	G57054	
G56529	G56529		G56774	G56774		G56973	G56973		G57055	G57055	
G56530	G56530		G56778	G56778		G56974	G56974		G57056	G57056	
G56537	G56537		G56791	G56791		G56975	G56975		G57057	G57057	
G56538	G56538		G56792	G56792		G56991	G56991		G57058	G57058	
G56539	G56539		G56797	G56797		G56992	G56992		G57059	G57059	
G56540	G56540		G56798	G56798		G56993	G56993		G57060	G57060	

Important Note: Competitive Interchanges are to be used for stocking purposes only. Where multiple crosses are identified, please reference the applications section of this catalog. / **Remarque importante:** Les interchanges concurrentiels ne s'utilisent qu'aux fins de stocks. Dans le cas de références multiples, consulter la section des applications du catalogue. / **Nota importante:** Dans le cas de referencias multiples, consultar la sección de aplicaciones del catálogo. / **Nota importante:** Se pueden usar intercambios competitivos para propósitos de almacenamiento solamente. Cuando se identifican intercambios múltiples, consulte la sección de aplicaciones de este catálogo.

COMPETITIVE & O.E.M. INTERCHANGE LIST
Lista de Intercambios contra Competidores y Equipo Original.
Liste d'interchange de produits compititifs & d'equipement original (OEM)

Classic Industries Catalog... cont'd

Classic industries catalog	Gabriel	Upgrade	Classic industries catalog	Gabriel	Upgrade	Classic industries catalog	Gabriel	Upgrade	Classic industries catalog	Gabriel	Upgrade
G57061	G57061		G57126	G57126		G57203	G57203		G57363	G57363	
G57062	G57062		G57127	G57127		G57204	G57204		G57364	G57364	
G57063	G57063		G57128	G57128		G57205	G57205		G57367	G57367	
G57064	G57064		G57129	G57129		G57206	G57206		G57368	G57368	
G57065	G57065		G57130	G57130		G57207	G57207		G57369	G57369	
G57066	G57066		G57131	G57131		G57208	G57208		G57370	G57370	
G57067	G57067		G57132	G57132		G57212	G57212		G57372	G57372	
G57068	G57068		G57133	G57133		G57218	G57218		G57373	G57373	
G57069	G57069		G57134	G57134		G57219	G57219		G57375	G57375	
G57070	G57070		G57135	G57135		G57220	G57220		G57376	G57376	
G57071	G57071		G57136	G57136		G57221	G57221		G57377	G57377	
G57072	G57072		G57137	G57137		G57222	G57222		G57378	G57378	
G57075	G57075		G57138	G57138		G57223	G57223		G57390	G57390	
G57076	G57076		G57139	G57139		G57266	G57266		G57391	G57391	
G57077	G57077		G57140	G57140		G57267	G57267		G57393	G57393	
G57078	G57078		G57141	G57141		G57268	G57268		G57394	G57394	
G57079	G57079		G57142	G57142		G57269	G57269		G57397	G57397	
G57080	G57080		G57144	G57144		G57270	G57270		G57398	G57398	
G57081	G57081		G57145	G57145		G57271	G57271		G57399	G57399	
G57082	G57082		G57146	G57146		G57274	G57274		G57400	G57400	
G57083	G57083		G57147	G57147		G57275	G57275		G57401	G57401	
G57084	G57084		G57148	G57148		G57276	G57276		G57404	G57404	
G57085	G57085		G57149	G57149		G57277	G57277		G57405	G57405	
G57086	G57086		G57150	G57150		G57278	G57278		G57409	G57409	
G57087	G57087		G57151	G57151		G57279	G57279		G57413	G57413	
G57088	G57088		G57152	G57152		G57282	G57282		G57414	G57414	
G57089	G57089		G57153	G57153		G57314	G57314		G57415	G57415	
G57090	G57090		G57156	G57156		G57322	G57322		G57416	G57416	
G57091	G57091		G57157	G57157		G57323	G57323		G57417	G57417	
G57092	G57092		G57158	G57158		G57324	G57324		G57418	G57418	
G57095	G57095		G57159	G57159		G57329	G57329		G57419	G57419	
G57096	G57096		G57160	G57160		G57330	G57330		G57420	G57420	
G57097	G57097		G57161	G57161		G57331	G57331		G57421	G57421	
G57098	G57098		G57162	G57162		G57332	G57332		G57422	G57422	
G57099	G57099		G57163	G57163		G57333	G57333		G57423	G57423	
G57100	G57100		G57164	G57164		G57334	G57334		G57424	G57424	
G57103	G57103		G57167	G57167		G57335	G57335		G57425	G57425	
G57105	G57105		G57168	G57168		G57336	G57336		G57427	G57427	
G57106	G57106		G57172	G57172		G57337	G57337		G57428	G57428	
G57107	G57107		G57173	G57173		G57338	G57338		G57429	G57429	
G57108	G57108		G57176	G57176		G57339	G57339		G57444	G57444	
G57109	G57109		G57177	G57177		G57340	G57340		G57447	G57447	
G57110	G57110		G57178	G57178		G57341	G57341		G57449	G57449	
G57111	G57111		G57184	G57184		G57342	G57342		G57450	G57450	
G57112	G57112		G57185	G57185		G57343	G57343		G57451	G57451	
G57113	G57113		G57190	G57190		G57344	G57344		G57452	G57452	
G57114	G57114		G57191	G57191		G57345	G57345		G57453	G57453	
G57115	G57115		G57192	G57192		G57346	G57346		G57454	G57454	
G57118	G57118		G57193	G57193		G57349	G57349		G57455	G57455	
G57119	G57119		G57194	G57194		G57350	G57350		G57456	G57456	
G57120	G57120		G57195	G57195		G57353	G57353		G57459	G57459	
G57121	G57121		G57197	G57197		G57354	G57354		G57460	G57460	
G57122	G57122		G57198	G57198		G57357	G57357		G57463	G57463	
G57123	G57123		G57200	G57200		G57358	G57358		G57464	G57464	
G57124	G57124		G57201	G57201		G57359	G57359		G57465	G57465	
G57125	G57125		G57202	G57202		G57360	G57360		G57466	G57466	

Important Note: Competitive Interchanges are to be used for stocking purposes only. Where multiple crosses are identified, please reference the applications section of this catalog. / **Remarque importante:** Les interchanges concurrentiels ne s'utilisent qu'aux fins de stocks. Dans le cas de rfrences multiples, consulter la section des applications du catalogue. / **Nota importante:** Dans le cas de rfrences multiples, consulter la section des applications du catalogue. / **Nota importante:** Se pueden usar intercambios competitivos para propósitos de almacenamiento solamente. Cuando se identifican intercambios múltiples, consulte la sección de aplicaciones de este catálogo.

COMPETITIVE & O.E.M. INTERCHANGE LIST
Lista de Intercambios contra Competidores y Equipo Original.
Liste dinterchange de produits comptitifs & dquipement original (OEM)

Classic Industries Catalog... cont'd

Classic industries catalog	Gabriel	Upgrade	Classic industries catalog	Gabriel	Upgrade	Classic industries catalog	Gabriel	Upgrade	Classic industries catalog	Gabriel	Upgrade
G57471	G57471		G57583	G57583		G57709	G57709		G57790	G57790	
G57472	G57472		G57586	G57586		G57712	G57712		G57791	G57791	
G57473	G57473		G57587	G57587		G57713	G57713		G57792	G57792	
G57474	G57474		G57594	G57594		G57716	G57716		G57793	G57793	
G57479	G57479		G57595	G57595		G57717	G57717		G57794	G57794	
G57480	G57480		G57597	G57597		G57720	G57720		G57795	G57795	
G57481	G57481		G57598	G57598		G57721	G57721		G57796	G57796	
G57482	G57482		G57603	G57603		G57722	G57722		G57799	G57799	
G57483	G57483		G57604	G57604		G57723	G57723		G57800	G57800	
G57484	G57484		G57605	G57605		G57724	G57724		G57801	G57801	
G57489	G57489		G57606	G57606		G57725	G57725		G57802	G57802	
G57490	G57490		G57607	G57607		G57726	G57726		G57803	G57803	
G57493	G57493		G57612	G57612		G57727	G57727		G57804	G57804	
G57494	G57494		G57613	G57613		G57730	G57730		G57812	G57812	
G57495	G57495		G57628	G57628		G57731	G57731		G57816	G57816	
G57496	G57496		G57629	G57629		G57732	G57732		G57817	G57817	
G57497	G57497		G57634	G57634		G57733	G57733		G57818	G57818	
G57498	G57498		G57635	G57635		G57734	G57734		G57819	G57819	
G57499	G57499		G57644	G57644		G57735	G57735		G57820	G57820	
G57500	G57500		G57645	G57645		G57738	G57738		G57825	G57825	
G57515	G57515		G57646	G57646		G57739	G57739		G63183	G63183	
G57516	G57516		G57647	G57647		G57740	G57740		G63299	G63299	
G57517	G57517		G57648	G57648		G57741	G57741		G63306	G63306	
G57518	G57518		G57649	G57649		G57742	G57742		G63347	G63347	
G57521	G57521		G57658	G57658		G57743	G57743		G63349	G63349	
G57522	G57522		G57659	G57659		G57744	G57744		G63350	G63350	
G57533	G57533		G57663	G57663		G57745	G57745		G63353	G63353	
G57534	G57534		G57664	G57664		G57746	G57746		G63355	G63355	
G57535	G57535		G57665	G57665		G57747	G57747		G63357	G63357	
G57536	G57536		G57666	G57666		G57748	G57748		G63359	G63359	
G57539	G57539		G57673	G57673		G57749	G57749		G63360	G63360	
G57540	G57540		G57674	G57674		G57750	G57750		G63366	G63366	
G57541	G57541		G57675	G57675		G57751	G57751		G63375	G63375	
G57542	G57542		G57676	G57676		G57752	G57752		G63377	G63377	
G57543	G57543		G57677	G57677		G57753	G57753		G63386	G63386	
G57544	G57544		G57680	G57680		G57758	G57758		G63387	G63387	
G57545	G57545		G57682	G57682		G57759	G57759		G63394	G63394	
G57546	G57546		G57683	G57683		G57764	G57764		G63403	G63403	
G57549	G57549		G57689	G57689		G57765	G57765		G63404	G63404	
G57550	G57550		G57690	G57690		G57768	G57768		G63405	G63405	
G57558	G57558		G57691	G57691		G57769	G57769		G63409	G63409	
G57559	G57559		G57692	G57692		G57772	G57772		G63410	G63410	
G57560	G57560		G57693	G57693		G57773	G57773		G63411	G63411	
G57561	G57561		G57694	G57694		G57774	G57774		G63413	G63413	
G57562	G57562		G57695	G57695		G57775	G57775		G63414	G63414	
G57563	G57563		G57696	G57696		G57776	G57776		G63418	G63418	
G57564	G57564		G57697	G57697		G57777	G57777		G63419	G63419	
G57565	G57565		G57698	G57698		G57778	G57778		G63421	G63421	
G57566	G57566		G57699	G57699		G57779	G57779		G63422	G63422	
G57567	G57567		G57700	G57700		G57780	G57780		G63423	G63423	
G57572	G57572		G57701	G57701		G57781	G57781		G63424	G63424	
G57573	G57573		G57702	G57702		G57782	G57782		G63425	G63425	
G57577	G57577		G57703	G57703		G57783	G57783		G63426	G63426	
G57578	G57578		G57704	G57704		G57784	G57784		G63432	G63432	
G57579	G57579		G57705	G57705		G57785	G57785		G63443	G63443	
G57582	G57582		G57706	G57706		G57786	G57786		G63454	G63454	

Important Note: Competitive Interchanges are to be used for stocking purposes only. Where multiple crosses are identified, please reference the applications section of this catalog. / **Remarque importante:** Les interchanges concurrentiels ne s'utilisent qu'aux fins de stocks. Dans le cas de références multiples, consulter la section des applications du catalogue. / **Nota importante:** Dans le cas de références multiples, consulter la section des applications du catalogue. / **Nota importante:** Se pueden usar intercambios competitivos para propósitos de almacenamiento solamente. Cuando se identifican intercambios múltiples, consulte la sección de aplicaciones de este catálogo.

COMPETITIVE & O.E.M. INTERCHANGE LIST
Lista de Intercambios contra Competidores y Equipo Original.
Liste dinterchange de produits comptitifs & dquipement original (OEM)

Classic Industries Catalog... cont'd

Classic industries catalog	Gabriel	Upgrade	Classic industries catalog	Gabriel	Upgrade	Classic industries catalog	Gabriel	Upgrade	Classic industries catalog	Gabriel	Upgrade
G63455	G63455		G63707	G63707		G63875	G63875		G64012	G64012	
G63456	G63456		G63708	G63708		G63878	G63878		G64013	G64013	
G63461	G63461		G63710	G63710		G63879	G63879		G64014	G64014	
G63479	G63479		G63712	G63712		G63882	G63882		G64015	G64015	
G63488	G63488		G63714	G63714		G63883	G63883		G64016	G64016	
G63489	G63489		G63715	G63715		G63884	G63884		G64026	G64026	
G63490	G63490		G63716	G63716		G63885	G63885		G64027	G64027	
G63492	G63492		G63717	G63717		G63886	G63886		G64028	G64028	
G63494	G63494		G63720	G63720		G63888	G63888		G64029	G64029	
G63495	G63495		G63721	G63721		G63889	G63889		G64030	G64030	
G63506	G63506		G63722	G63722		G63890	G63890		G64031	G64031	
G63510	G63510		G63726	G63726		G63891	G63891		G64032	G64032	
G63511	G63511		G63772	G63772		G63892	G63892		G64033	G64033	
G63524	G63524		G63773	G63773		G63893	G63893		G64037	G64037	
G63525	G63525		G63775	G63775		G63894	G63894		G64038	G64038	
G63547	G63547		G63776	G63776		G63895	G63895		G64040	G64040	
G63548	G63548		G63778	G63778		G63896	G63896		G64042	G64042	
G63604	G63604		G63781	G63781		G63897	G63897		G64043	G64043	
G63605	G63605		G63782	G63782		G63902	G63902		G64046	G64046	
G63607	G63607		G63783	G63783		G63903	G63903		G64047	G64047	
G63608	G63608		G63799	G63799		G63904	G63904		G64048	G64048	
G63609	G63609		G63803	G63803		G63905	G63905		G64049	G64049	
G63610	G63610		G63808	G63808		G63907	G63907		G64050	G64050	
G63611	G63611		G63809	G63809		G63909	G63909		G64052	G64052	
G63614	G63614		G63810	G63810		G63915	G63915		G64056	G64056	
G63615	G63615		G63813	G63813		G63918	G63918		G64063	G64063	
G63616	G63616		G63815	G63815		G63928	G63928		G64071	G64071	
G63620	G63620		G63817	G63817		G63929	G63929		G64079	G64079	
G63622	G63622		G63818	G63818		G63937	G63937		G64080	G64080	
G63623	G63623		G63828	G63828		G63950	G63950		G64087	G64087	
G63624	G63624		G63829	G63829		G63958	G63958		G64089	G64089	
G63625	G63625		G63832	G63832		G63959	G63959		G64101	G64101	
G63635	G63635		G63837	G63837		G63961	G63961		G64104	G64104	
G63638	G63638		G63842	G63842		G63962	G63962		G64111	G64111	
G63661	G63661		G63844	G63844		G63965	G63965		G64121	G64121	
G63662	G63662		G63845	G63845		G63966	G63966		G64140	G64140	
G63671	G63671		G63847	G63847		G63967	G63967		G64143	G64143	
G63673	G63673		G63848	G63848		G63969	G63969		G64146	G64146	
G63674	G63674		G63860	G63860		G63971	G63971		G64148	G64148	
G63675	G63675		G63862	G63862		G64000	G64000		G64151	G64151	
G63676	G63676		G63864	G63864		G64001	G64001		G64157	G64157	
G63678	G63678		G63866	G63866		G64002	G64002		G64163	G64163	
G63679	G63679		G63867	G63867		G64003	G64003		G64164	G64164	
G63683	G63683		G63868	G63868		G64006	G64006		G64177	G64177	
G63689	G63689		G63869	G63869		G64008	G64008		G64186	G64186	
G63690	G63690		G63870	G63870		G64009	G64009		G64216	G64216	
G63692	G63692		G63872	G63872		G64010	G64010		G64268	G64268	
G63694	G63694		G63873	G63873		G64011	G64011		G64269	G64269	

CNH Global NV.

Cnh global nv.	Gabriel	Upgrade	Cnh global nv.	Gabriel	Upgrade	Cnh global nv.	Gabriel	Upgrade	Cnh global nv.	Gabriel	Upgrade
87019546	83022		87268250	83021							

Coach House

Coach house	Gabriel	Upgrade	Coach house	Gabriel	Upgrade	Coach house	Gabriel	Upgrade	Coach house	Gabriel	Upgrade
8C24-18045-DA	G63622		8C2Z-18124-D	G63622		ASH-1136	G63623				
8C24-18080-DB	G63623		8C2Z-18125-D	G63623		ASH-1154	G63622				
8C2418045DA	G63622		8C2Z18124D	G63622		ASH1136	G63623				
8C2418080DB	G63623		8C2Z18125D	G63623		ASH1154	G63622				

Important Note: Competitive Interchanges are to be used for stocking purposes only. Where multiple crosses are identified, please reference the applications section of this catalog./ **Remarque importante:** Les interchanges concurrentiels ne s'utilisent qu'aux fins de stocks. Dans le cas de rferences multiples, consulter la section des applications du catalogue./ **Nota importante:** Dans le cas de rferences multiples, consulter la section des applications du catalogue./ **Nota importante:** Se pueden usar intercambios competitivos para propósitos de almacenamiento solamente. Cuando se identifican intercambios múltiples, consulte la sección de aplicaciones de este catálogo.

COMPETITIVE & O.E.M. INTERCHANGE LIST
Lista de Intercambios contra Competidores y Equipo Original.
Liste dinterchange de produits comptitifs & dquipement original (OEM)

Coach House... cont'd

Coach house	Gabriel	Upgrade	Coach house	Gabriel	Upgrade	Coach house	Gabriel	Upgrade	Coach house	Gabriel	Upgrade
AT-163G	G63622		AT-164G	G63623		AT163G	G63622		AT164G	G63623	

Coachmen

Coachmen	Gabriel	Upgrade	Coachmen	Gabriel	Upgrade	Coachmen	Gabriel	Upgrade	Coachmen	Gabriel	Upgrade
141700131809	85029		8C2Z-18125-D	G63623		ASH-1229	83209	89414	ASH137	89406	
141700131810	83160		8C2Z18124D	G63622		ASH-1229	89414		ASH25822	83209	89414
16-16736-000	85029		8C2Z18125D	G63623		ASH-1230	83122	89406	ASH25822	89414	
16-16737-000	83160		9U94-18045-AA	83209	89414	ASH-1230	89406		ASH25823	83209	89414
16-16873-000	85029		9U94-18045-AA	89414		ASH-137	83122	89406	ASH25823	89414	
16-16874-000	83160		9U94-18080-AA	83122	89406	ASH-137	89406		ASH25824	83122	89406
16-18103-000	85900		9U94-18080-AA	89406		ASH-25822	83209	89414	ASH25824	89406	
1616736000	85029		9U9418045AA	83209	89414	ASH-25822	89414		ASH294	83209	89414
1616737000	83160		9U9418045AA	89414		ASH-25823	83209	89414	ASH294	89414	
1616873000	85029		9U9418080AA	83122	89406	ASH-25823	89414		AT-163G	G63622	
1616874000	83160		9U9418080AA	89406		ASH-25824	83122	89406	AT-164G	G63623	
1618103000	85900		9U9Z-18124-A	83209	89414	ASH-25824	89406		AT-620	83209	89414
1C34-18045-AA	83209	89414	9U9Z-18124-A	89414		ASH-294	83209	89414	AT-620	89414	
1C34-18045-AA	89414		9U9Z-18125-A	83122	89406	ASH-294	89414		AT-621	83122	89406
1C34-18045-JA	83209	89414	9U9Z-18125-A	89406		ASH1022	83209	89414	AT-621	89406	
1C34-18045-JA	89414		9U9Z18124A	83209	89414	ASH1022	89414		AT-766	83209	89414
1C3418045AA	83209	89414	9U9Z18124A	89414		ASH1023	83122	89406	AT-766	89414	
1C3418045AA	89414		9U9Z18125A	83122	89406	ASH1023	89406		AT163G	G63622	
1C3418045JA	83209	89414	9U9Z18125A	89406		ASH1136	G63623		AT164G	G63623	
1C3418045JA	89414		ASH-1022	83209	89414	ASH1154	G63622		AT620	83209	89414
481700000490	85900		ASH-1022	89414		ASH1205	83209	89414	AT620	89414	
481700000493	85900		ASH-1023	83122	89406	ASH1205	89414		AT621	83122	89406
66153-002	83124	89407	ASH-1023	89406		ASH1206	83122	89406	AT621	89406	
66153-002	89407		ASH-1136	G63623		ASH1206	89406		AT766	83209	89414
66153002	83124	89407	ASH-1154	G63622		ASH1228	83209	89414	AT766	89414	
66153002	89407		ASH-1205	83209	89414	ASH1228	89414		F4-BE5-C832-MO	83124	89407
8C24-18045-DA	G63622		ASH-1205	89414		ASH1229	83209	89414	F4-BE5-C832-MO	89407	
8C24-18080-DB	G63623		ASH-1206	83122	89406	ASH1229	89414		F4BE5C832MO	83124	89407
8C2418045DA	G63622		ASH-1206	89406		ASH1230	83122	89406	F4BE5C832MO	89407	
8C2418080DB	G63623		ASH-1228	83209	89414	ASH1230	89406				
8C2Z-18124-D	G63622		ASH-1228	89414		ASH137	83122	89406			

Cofap

Cofap	Gabriel	Upgrade	Cofap	Gabriel	Upgrade	Cofap	Gabriel	Upgrade	Cofap	Gabriel	Upgrade
45011	85702		45117	85918	89449	ATG-051	G63426		L-12687	83030	
45054	85301		45117	89449		ATG-084	G63608		L-12703	85071	
45056	85315		45139C-Y	85901		ATG-085	G63607		L-12713	83136	
45058	85301		8482	85026		L-12039	85065				

Collins Bus Corp.

Collins bus corp.	Gabriel	Upgrade	Collins bus corp.	Gabriel	Upgrade	Collins bus corp.	Gabriel	Upgrade	Collins bus corp.	Gabriel	Upgrade
ASH-1136	G63623		ASH-1154	G63622		ASH1136	G63623		ASH1154	G63622	

Condumex

Condumex	Gabriel	Upgrade	Condumex	Gabriel	Upgrade	Condumex	Gabriel	Upgrade	Condumex	Gabriel	Upgrade
43066	83309		53043	83215		58040	85026		58057	89447	
43139	83021		53059	85051		58041	83456	89447	58058	85031	
43145	83021		53063	83025		58041	89447		58059	85005	89430
53010	83136		53065	83136		58048	83137		58059	89430	
53018	83317		53066	83124	89407	58049	85323	89436	58061	83122	89406
53019	83456	89447	53066	89407		58049	89436		58061	85916	89430
53019	89447		58012	85314	89425	58050	85061	89450	58061	89406	
53039	85006		58012	89425		58050	89450		58061	89430	
53040	85006		58034	85013	89414	58055	85003	89411			
53041	85310	89423	58034	89414		58055	89411				
53041	89423		58038	85001	89410	58056	83137				
53042	83309		58038	89410		58057	83456	89447			

Important Note: Competitive Interchanges are to be used for stocking purposes only. Where multiple crosses are identified, please reference the applications section of this catalog. / **Remarque importante:** Les interchanges concurrentiels ne s'utilisent qu'aux fins de stocks. Dans le cas de rferences multiples, consulter la section des applications du catalogue. / **Nota importante:** Dans le cas de rferences multiples, consulter la section des applications du catalogue. / **Nota importante:** Se pueden usar intercambios competitivos para propósitos de almacenamiento solamente. Cuando se identifican intercambios múltiples, consulte la sección de aplicaciones de este catálogo.

COMPETITIVE & O.E.M. INTERCHANGE LIST
Lista de Intercambios contra Competidores y Equipo Original.
Liste dinterchange de produits comptitifs & dquipement original (OEM)

Condumex... cont'd

Condumex	Gabriel	Upgrade	Condumex	Gabriel	Upgrade	Condumex	Gabriel	Upgrade	Condumex	Gabriel	Upgrade
69500	83122	89406	69712	89414		69745	89431		78009	89422	
69500	89406		69713	85046	89434	69746	83137		78013	85323	89436
69515	83124	89407	69713	89434		69747	85003	89411	78013	89436	
69515	89407		69716	85024		69747	89411		78015	85724	89443
69669	83123	89405	69717	85310	89423	69748	85001	89410	78015	89443	
69669	89405		69717	89423		69748	89410		78016	85001	89410
69670	85051		69720	85736		69750	85314	89425	78016	89410	
69671	85006		69726	85319	89428	69750	89425		78020	85712	
69672	85043		69726	89428		69752	85316	89426	78023	85705	89447
69673	83209	89414	69728	85055	89439	69752	89426		78023	89447	
69673	89414		69728	89439		69753	85031		78025	85009	
69680	89402		69729	85314	89425	78001	85314	89425	78027	85314	89425
69685	83136		69729	89425		78001	89425		78027	89425	
69688	85302	89420	69732	85300	89419	78002	85702		78030	85316	89426
69688	89420		69732	89419		78003	85308	89422	78030	89426	
69705	83122	89406	69741	85906	89407	78003	89422		78034	85920	89503
69705	89406		69741	89407		78005	85310	89423	78034	89503	
69711	83207	89407	69743	85061	89450	78005	89423		78039	85311	89424
69711	89407		69743	89450		78007	85307		78039	89424	
69712	85013	89414	69745	85058	89431	78009	85303	89422			

Continental Trailways-Eagle Intl.

Continental trailways-eagle intl.	Gabriel	Upgrade	Continental trailways-eagle intl.	Gabriel	Upgrade	Continental trailways-eagle intl.	Gabriel	Upgrade	Continental trailways-eagle intl.	Gabriel	Upgrade
01-0100-020	85307		010100905	85303	89422	6-05-5	85307		70039	85303	89422
01-0100-905	85303	89422	010100905	89422		6055	85307		70039	89422	
01-0100-905	89422		5394467	85305		680091	85303	89422	70041	85305	
010100020	85307		5532026	85304		680091	89422				

Country Coach

Country coach	Gabriel	Upgrade	Country coach	Gabriel	Upgrade	Country coach	Gabriel	Upgrade	Country coach	Gabriel	Upgrade
10-13634-000	85918	89449	16-18708-000	89443		8C24-18045-DA	G63622		ASH-1154	G63622	
10-13634-000	89449		1618708000	85724	89443	8C24-18080-DB	G63623		ASH1136	G63623	
10-13760-000	85959		1618708000	89443		8C2418045DA	G63622		ASH1154	G63622	
10-13809-000	85958		471700000449	85918	89449	8C2418080DB	G63623		AT-163G	G63622	
1013634000	85918	89449	471700000449	89449		8C2Z-18124-D	G63622		AT-164G	G63623	
1013634000	89449		471700002809	85724	89443	8C2Z-18125-D	G63623		AT163G	G63622	
1013760000	85959		471700002809	89443		8C2Z18124D	G63622		AT164G	G63623	
1013809000	85958		471700002991	85959		8C2Z18125D	G63623		SDA471700002991	85959	
16-18708-000	85724	89443	471700003920	85958		ASH-1136	G63623				

Crane Carrier

Crane carrier	Gabriel	Upgrade	Crane carrier	Gabriel	Upgrade	Crane carrier	Gabriel	Upgrade	Crane carrier	Gabriel	Upgrade
1265157B000	85712		277A-14	85304		277A14	85304		64178-001	83143	
1310002	665937		277A-8	85303	89422	277A8	85303	89422	64178001	83143	
227A-14	85716		277A-8	89422		277A8	89422		680088	85713	
227A14	85716		277A-9	85307		277A9	85307		680091	85303	89422
277A-1	85307		277A1	85307		60680-004	83143		680091	89422	
277A-12	85304		277A12	85304		60680-004L	83143				
277A-13	85302	89420	277A13	85302	89420	60680004	83143				
277A-13	89420		277A13	89420		60680004L	83143				

Crown Coach

Crown coach	Gabriel	Upgrade	Crown coach	Gabriel	Upgrade	Crown coach	Gabriel	Upgrade	Crown coach	Gabriel	Upgrade
3188729	85303	89422	3188729	89422		5532026	85304		5532036	85734	

Cush Corporation

Cush corporation	Gabriel	Upgrade	Cush corporation	Gabriel	Upgrade	Cush corporation	Gabriel	Upgrade	Cush corporation	Gabriel	Upgrade
C0062-D	85000	89436	C0062D	89436		C0226	85064		C0228	89430	
C0062-D	89436		C0078	85000	89436	C0227	85014		C04045	85045	
C0062D	85000	89436	C0078	89436		C0228	85005	89430			

Important Note: Competitive Interchanges are to be used for stocking purposes only. Where multiple crosses are identified, please reference the applications section of this catalog. / **Remarque importante:** Les interchanges concurrentiels ne s'utilisent qu'aux fins de stocks. Dans le cas de rferences multiples, consulter la section des applications du catalogue. / **Nota importante:** Dans le cas de rferences multiples, consulter la section des applications du catalogue. / **Nota importante:** Se pueden usar intercambios competitivos para propósitos de almacenamiento solamente. Cuando se identifican intercambios múltiples, consulte la sección de aplicaciones de este catálogo.

COMPETITIVE & O.E.M. INTERCHANGE LIST

Lista de Intercambios contra Competidores y Equipo Original.

Liste d'interchange de produits compétitifs & d'équipement original (OEM)

Damon Motor Coach

Damon motor coach	Gabriel	Upgrade	Damon motor coach	Gabriel	Upgrade	Damon motor coach	Gabriel	Upgrade	Damon motor coach	Gabriel	Upgrade
1C34-18045-AA	83209	89414	9U9Z18124A	83209	89414	ASH-294	83209	89414	AT-620	83209	89414
1C34-18045-AA	89414		9U9Z18124A	89414		ASH-294	89414		AT-620	89414	
1C34-18045-JA	83209	89414	9U9Z18125A	83122	89406	ASH1022	83209	89414	AT-621	83122	89406
1C34-18045-JA	89414		9U9Z18125A	89406		ASH1022	89414		AT-621	89406	
1C3418045AA	83209	89414	ASH-1022	83209	89414	ASH1023	83122	89406	AT-766	83209	89414
1C3418045AA	89414		ASH-1022	89414		ASH1023	89406		AT-766	89414	
1C3418045JA	83209	89414	ASH-1023	83122	89406	ASH1205	83209	89414	AT620	83209	89414
1C3418045JA	89414		ASH-1023	89406		ASH1205	89414		AT620	89414	
24-153249	85125		ASH-1205	83209	89414	ASH1206	83122	89406	AT621	83122	89406
24-153256	85124		ASH-1205	89414		ASH1206	89406		AT621	89406	
24-186629	85125		ASH-1206	83122	89406	ASH1228	83209	89414	AT766	83209	89414
24153249	85125		ASH-1206	89406		ASH1228	89414		AT766	89414	
24153256	85124		ASH-1228	83209	89414	ASH1229	83209	89414	F4-BE5-A832-MO	85125	
24186629	85125		ASH-1228	89414		ASH1229	89414		F4-BE5-B492-HO	85125	
9U94-18045-AA	83209	89414	ASH-1229	83209	89414	ASH1230	83122	89406	F4-BE5-F324-HO	85125	
9U94-18045-AA	89414		ASH-1229	89414		ASH1230	89406		F4-BE5-F325-HO	85124	
9U94-18080-AA	83122	89406	ASH-1230	83122	89406	ASH137	83122	89406	F4BE5A832MO	85125	
9U94-18080-AA	89406		ASH-1230	89406		ASH137	89406		F4BE5B492HO	85125	
9U9418045AA	83209	89414	ASH-137	83122	89406	ASH25822	83209	89414	F4BE5F324HO	85125	
9U9418045AA	89414		ASH-137	89406		ASH25822	89414		F4BE5F325HO	85124	
9U9418080AA	83122	89406	ASH-25822	83209	89414	ASH25823	83209	89414	W0005662	85125	
9U9418080AA	89406		ASH-25822	89414		ASH25823	89414		W0005663	85124	
9U9Z-18124-A	83209	89414	ASH-25823	83209	89414	ASH25824	83122	89406	W0006254	85125	
9U9Z-18124-A	89414		ASH-25823	89414		ASH25824	89406				
9U9Z-18125-A	83122	89406	ASH-25824	83122	89406	ASH294	83209	89414			
9U9Z-18125-A	89406		ASH-25824	89406		ASH294	89414				

Dexter Axle

Dexter axle	Gabriel	Upgrade	Dexter axle	Gabriel	Upgrade	Dexter axle	Gabriel	Upgrade	Dexter axle	Gabriel	Upgrade
18165-01	85006		1816501	85006							

Diamond Coach

Diamond coach	Gabriel	Upgrade	Diamond coach	Gabriel	Upgrade	Diamond coach	Gabriel	Upgrade	Diamond coach	Gabriel	Upgrade
8C24-18045-DA	G63622		8C2Z-18124-D	G63622		ASH-1136	G63623		AT-163G	G63622	
8C24-18080-DB	G63623		8C2Z-18125-D	G63623		ASH-1154	G63622		AT-164G	G63623	
8C2418045DA	G63622		8C2Z18124D	G63622		ASH1136	G63623		AT163G	G63622	
8C2418080DB	G63623		8C2Z18125D	G63623		ASH1154	G63622		AT164G	G63623	

Diamond-Reo

Diamond-reo	Gabriel	Upgrade	Diamond-reo	Gabriel	Upgrade	Diamond-reo	Gabriel	Upgrade	Diamond-reo	Gabriel	Upgrade
220-55-1	83214		220-55-7	85304		220552	85304		220S510	85712	
220-55-2	85304		220-S5-10	85712		220556	83214				
220-55-6	83214		220551	83214		220557	85304				

Dina Bus

Dina bus	Gabriel	Upgrade	Dina bus	Gabriel	Upgrade	Dina bus	Gabriel	Upgrade	Dina bus	Gabriel	Upgrade
13424S	83317		152C030010	83317		39380353-6	85716		39390340-4	85716	
1520030010	83317		152E030030	85014		39390339-6	85307				

DriveTech

Drivetech	Gabriel	Upgrade	Drivetech	Gabriel	Upgrade	Drivetech	Gabriel	Upgrade	Drivetech	Gabriel	Upgrade
D234039	M55848		D334150	M55912		D341118	M55877		D343290	81935	
D234040	M55848		D334151	M55913		D341302	81893		D343388	81910	
D235058	M55921		D334170	M56502		D343127	81494		D344015	82066	
D235059	M55920		D334171	M56502		D343130	81514		D344040	81750	
D235621	M55693		D334188	M55697		D343135	81495		D344041	81482	
D235626	M55896		D334229	M55974		D343156	81491		D344042	81516	
D235627	M55892		D334294	M55901		D343157	81492		D344049	81490	
D236003	M56708		D334295	M56501		D343209	81541		D344049	81836	
D236007	M56718		D341012	82156		D343218	81880		D344051	81540	
D323247	81904		D341117	M55877		D343280	81934		D344052	82125	

Important Note: Competitive Interchanges are to be used for stocking purposes only. Where multiple crosses are identified, please reference the applications section of this catalog. / **Remarque importante:** Les interchanges concurrentiels ne s'utilisent qu'aux fins de stocks. Dans le cas de références multiples, consulter la section des applications du catalogue. / **Nota importante:** Dans le cas de referencias multiples, consultar la sección de aplicaciones del catálogo. / **Nota importante:** Se pueden usar intercambios competitivos para propósitos de almacenamiento solamente. Cuando se identifican intercambios múltiples, consulte la sección de aplicaciones de este catálogo.

COMPETITIVE & O.E.M. INTERCHANGE LIST
Lista de Intercambios contra Competidores y Equipo Original.
Liste dinterchange de produits comptitifs & dquipement original (OEM)

DriveTech... cont'd

Drivetech	Gabriel	Upgrade	Drivetech	Gabriel	Upgrade	Drivetech	Gabriel	Upgrade	Drivetech	Gabriel	Upgrade
D344077	81082		D344094	81559		D344371	81828		D344386	81921	
D344077	81510		D344096	81560		D344372	81928		D344396	81917	
D344077	81710		D344266	81726		D344374	81892		D344397	81916	
D344079	81905		D344267	81821		D344375	81913		D344398	81933	
D344079	81918		D344269	81890		D344376	81919		D344399	81932	
D344080	81878		D344299	81911		D344378	81923		D344418	81549	
D344081	81713		D344338	81924		D344379	81923		D344428	81871	
D344083	81582		D344365	81873		D344380	81920		D344430	81872	
D344085	81484		D344367	81912		D344381	81922		D344433	81794	
D344087	81484		D344368	81914		D344383	81925		D344437	81930	
D344088	81548		D344369	81833		D344385	81931				

Dura Suspension

Dura suspension	Gabriel	Upgrade	Dura suspension	Gabriel	Upgrade	Dura suspension	Gabriel	Upgrade	Dura suspension	Gabriel	Upgrade
1080099	83203	89436	59024	83204		665133	89436		A-2212	85029	
1080099	89436		59030	83203	89436	665267	85029		A2212	85029	
12866	83207	89407	59030	89436		7604-3371	83204				
12866	89407		665133	83203	89436	76043371	83204				

Dutchmen RV

Dutchmen rv	Gabriel	Upgrade	Dutchmen rv	Gabriel	Upgrade	Dutchmen rv	Gabriel	Upgrade	Dutchmen rv	Gabriel	Upgrade
8C24-18045-DA	G63622		8C2Z-18124-D	G63622		ASH-1136	G63623		AT-163G	G63622	
8C24-18080-DB	G63623		8C2Z-18125-D	G63623		ASH-1154	G63622		AT-164G	G63623	
8C2418045DA	G63622		8C2Z18124D	G63622		ASH1136	G63623		AT163G	G63622	
8C2418080DB	G63623		8C2Z18125D	G63623		ASH1154	G63622		AT164G	G63623	

Dynamax Corp.

Dynamax corp.	Gabriel	Upgrade	Dynamax corp.	Gabriel	Upgrade	Dynamax corp.	Gabriel	Upgrade	Dynamax corp.	Gabriel	Upgrade
10-12390-000	85920	89503	1013063000	89449		471700000450	85918	89449	8C2418080DB	G63623	
10-12390-000	89503		1013211000	85918	89449	471700000450	89449		8C2Z-18124-D	G63622	
10-13021-000	85918	89449	1013211000	89449		471700002808	85724	89443	8C2Z-18125-D	G63623	
10-13021-000	89449		1013634000	85918	89449	471700002808	89443		8C2Z18124D	G63622	
10-13063-000	85918	89449	1013634000	89449		471700002809	85724	89443	8C2Z18125D	G63623	
10-13063-000	89449		1013684000	85918	89449	471700002809	89443		ASH-1136	G63623	
10-13211-000	85918	89449	1013684000	89449		471700002810	85724	89443	ASH-1154	G63622	
10-13211-000	89449		1013760000	85959		471700002810	89443		ASH1136	G63623	
10-13634-000	85918	89449	1013809000	85958		471700002991	85959		ASH1154	G63622	
10-13634-000	89449		16-15817-000	85724	89443	471700003920	85958		AT-163G	G63622	
10-13684-000	85918	89449	16-15817-000	89443		471700131155	85918	89449	AT-164G	G63623	
10-13684-000	89449		16-18708-000	85724	89443	471700131155	89449		AT163G	G63622	
10-13760-000	85959		16-18708-000	89443		481700006848	85724	89443	AT164G	G63623	
10-13809-000	85958		1615817000	85724	89443	481700006848	89443		SDA471700002809	85724	89443
1012390000	85920	89503	1615817000	89443		680611	85724	89443	SDA471700002809	89443	
1012390000	89503		1618708000	85724	89443	680611	89443		SDA471700002991	85959	
1013021000	85918	89449	1618708000	89443		8C24-18045-DA	G63622		SDA471700003920	85958	
1013021000	89449		471700000449	85918	89449	8C24-18080-DB	G63623				
1013063000	85918	89449	471700000449	89449		8C2418045DA	G63622				

E-One

E-one	Gabriel	Upgrade	E-one	Gabriel	Upgrade	E-one	Gabriel	Upgrade	E-one	Gabriel	Upgrade
90-2572	85329		ASH-1154	G63622		ASH1154	G63622				
ASH-1136	G63623		ASH1136	G63623							

Eagle Motor Coach

Eagle motor coach	Gabriel	Upgrade	Eagle motor coach	Gabriel	Upgrade	Eagle motor coach	Gabriel	Upgrade	Eagle motor coach	Gabriel	Upgrade
01-0100-020	85307		014-0100-905	85308	89422	101364	85305		1540100514	89425	
01-0100-905	85303	89422	014-0100-905	89422		12J-5-10	85733		38478	85307	
01-0100-905	89422		0140100-905	85308	89422	12J510	85733		5394467	85305	
010100020	85307		0140100-905	89422		154-0100-514	85314	89425	5532026	85304	
010100905	85303	89422	0140100905	85308	89422	154-0100-514	89425		6-05-5	85307	
010100905	89422		0140100905	89422		1540100514	85314	89425	6055	85307	

Important Note: Competitive Interchanges are to be used for stocking purposes only. Where multiple crosses are identified, please reference the applications section of this catalog. / **Remarque importante:** Les interchanges concurrentiels ne s'utilisent qu'aux fins de stocks. Dans le cas de rferences multiples, consulter la section des applications du catalogue. / **Nota importante:** Dans le cas de rferences multiples, consulter la section des applications du catalogue. / **Nota importante:** Se pueden usar intercambios competitivos para propósitos de almacenamiento solamente. Cuando se identifican intercambios múltiples, consulte la sección de aplicaciones de este catálogo.

COMPETITIVE & O.E.M. INTERCHANGE LIST

Lista de Intercambios contra Competidores y Equipo Original.

Liste d'interchange de produits complitifs & d'equipement original (OEM)

Eagle Motor Coach... cont'd

Eagle motor coach	Gabriel	Upgrade	Eagle motor coach	Gabriel	Upgrade	Eagle motor coach	Gabriel	Upgrade	Eagle motor coach	Gabriel	Upgrade
680091	85303	89422	690060	85713		70039	89422				
680091	89422		70039	85303	89422	70041	85305				

East Manufacturing Corp.

East manufacturing corp.	Gabriel	Upgrade	East manufacturing corp.	Gabriel	Upgrade	East manufacturing corp.	Gabriel	Upgrade	East manufacturing corp.	Gabriel	Upgrade
517-05001-18	87015		517-05805-20	85000	89436	5170500620	89440		5170591614	83124	89407
517-05001-23	85005	89430	517-05805-20	89436		5170500914	83125		5170591614	89407	
517-05001-23	89430		517-05806-20	85029		5170501007	83214		A-20002	85000	89436
517-05006-20	85030	89440	517-05808-20	85738		5170511020	85000	89436	A-20002	89436	
517-05006-20	89440		517-05809-20	89437		5170511020	89436		A-20126	85323	89436
517-05009-14	83125		517-05916-14	83124	89407	5170551114	83128	89436	A-20126	89436	
517-05010-07	83214		517-05916-14	89407		5170551114	89436		A20002	85000	89436
517-05110-20	85000	89436	5170500118	87015		5170580520	85000	89436	A20002	89436	
517-05110-20	89436		5170500123	85005	89430	5170580520	89436		A20126	85323	89436
517-05511-14	83128	89436	5170500123	89430		5170580620	85029		A20126	89436	
517-05511-14	89436		5170500620	85030	89440	5170580820	85738				

Eldorado National

Eldorado national	Gabriel	Upgrade	Eldorado national	Gabriel	Upgrade	Eldorado national	Gabriel	Upgrade	Eldorado national	Gabriel	Upgrade
8C24-18045-DA	G63622		8C2Z-18124-D	G63622		ASH-1136	G63623		AT-163G	G63622	
8C24-18080-DB	G63623		8C2Z-18125-D	G63623		ASH-1154	G63622		AT-164G	G63623	
8C2418045DA	G63622		8C2Z18124D	G63622		ASH1136	G63623		AT163G	G63622	
8C2418080DB	G63623		8C2Z18125D	G63623		ASH1154	G63622		AT164G	G63623	

Entegra Coach

Entegra coach	Gabriel	Upgrade	Entegra coach	Gabriel	Upgrade	Entegra coach	Gabriel	Upgrade	Entegra coach	Gabriel	Upgrade
10-13976-000	85918	89449	9U94-18080-AA	89406		ASH-1230	89406		ASH1230	83122	89406
10-13976-000	89449		9U9418045AA	83209	89414	ASH-137	83122	89406	ASH1230	89406	
1013976000	85918	89449	9U9418045AA	89414		ASH-137	89406		ASH137	83122	89406
1013976000	89449		9U9418080AA	83122	89406	ASH-25820	85005	89430	ASH137	89406	
16-16764-000	85724	89443	9U9418080AA	89406		ASH-25820	89430		ASH25820	85005	89430
16-16764-000	89443		9U9Z-18124-A	83209	89414	ASH-25821	85006		ASH25820	89430	
1616764000	85724	89443	9U9Z-18124-A	89414		ASH-25822	83209	89414	ASH25821	85006	
1616764000	89443		9U9Z-18125-A	83122	89406	ASH-25822	89414		ASH25822	83209	89414
1C34-18045-AA	83209	89414	9U9Z-18125-A	89406		ASH-25823	83209	89414	ASH25822	89414	
1C34-18045-AA	89414		9U9Z18124A	83209	89414	ASH-25823	89414		ASH25823	83209	89414
1C34-18045-JA	83209	89414	9U9Z18124A	89414		ASH-25824	83122	89406	ASH25823	89414	
1C34-18045-JA	89414		9U9Z18125A	83122	89406	ASH-25824	89406		ASH25824	83122	89406
1C3418045AA	83209	89414	9U9Z18125A	89406		ASH-294	83209	89414	ASH25824	89406	
1C3418045AA	89414		ASH-1022	83209	89414	ASH-294	89414		ASH294	83209	89414
1C3418045JA	83209	89414	ASH-1022	89414		ASH1022	83209	89414	ASH294	89414	
1C3418045JA	89414		ASH-1023	83122	89406	ASH1022	89414		AT-163G	G63622	
58913-009	85959		ASH-1023	89406		ASH1023	83122	89406	AT-164G	G63623	
58913-009L	85959		ASH-1136	G63623		ASH1023	89406		AT-620	83209	89414
58913009	85959		ASH-1154	G63622		ASH1136	G63623		AT-620	89414	
58913009L	85959		ASH-1161	85006		ASH1154	G63622		AT-621	83122	89406
8C24-18045-DA	G63622		ASH-1162	85005	89430	ASH1161	85006		AT-621	89406	
8C24-18080-DB	G63623		ASH-1162	89430		ASH1162	85005	89430	AT-766	83209	89414
8C2418045DA	G63622		ASH-1205	83209	89414	ASH1162	89430		AT-766	89414	
8C2418080DB	G63623		ASH-1205	89414		ASH1205	83209	89414	AT163G	G63622	
8C2Z-18124-D	G63622		ASH-1206	83122	89406	ASH1205	89414		AT164G	G63623	
8C2Z-18125-D	G63623		ASH-1206	89406		ASH1206	83122	89406	AT620	83209	89414
8C2Z18124D	G63622		ASH-1228	83209	89414	ASH1206	89406		AT620	89414	
8C2Z18125D	G63623		ASH-1228	89414		ASH1228	83209	89414	AT621	83122	89406
9U94-18045-AA	83209	89414	ASH-1229	83209	89414	ASH1228	89414		AT621	89406	
9U94-18045-AA	89414		ASH-1229	89414		ASH1229	83209	89414	AT766	83209	89414
9U94-18080-AA	83122	89406	ASH-1230	83122	89406	ASH1229	89414		AT766	89414	

Important Note: Competitive Interchanges are to be used for stocking purposes only. Where multiple crosses are identified, please reference the applications section of this catalog. / **Remarque importante:** Les interchanges concurrentiels ne s'utilisent qu'aux fins de stocks. Dans le cas de références multiples, consulter la section des applications du catalogue. / **Nota importante:** Dans le cas de referencias multiples, consultar la sección de aplicaciones del catálogo. / **Nota importante:** Se pueden usar intercambios competitivos para propósitos de almacenamiento solamente. Cuando se identifican intercambios múltiples, consulte la sección de aplicaciones de este catálogo.

COMPETITIVE & O.E.M. INTERCHANGE LIST
Lista de Intercambios contra Competidores y Equipo Original.
Liste dinterchange de produits comptitifs & dquipement original (OEM)

Euclid

Euclid	Gabriel	Upgrade	Euclid	Gabriel	Upgrade	Euclid	Gabriel	Upgrade	Euclid	Gabriel	Upgrade
E14009	85933	89454	E83221	83221		E85007	85007		E85310	89423	
E14009	89454		E83225	83225		E85010	85010		E85311	85311	89424
E14021	85955		E83242	83242		E85012	85012	89413	E85311	89424	
E14022	85955		E83301	83301		E85012	89413		E85312	85733	
E14037	85967		E83303	83303		E85013	85013	89414	E85314	85314	89425
E14042	85965		E83308	83308		E85013	89414		E85314	89425	
E14045	83143		E83309	83309		E85014	85014		E85318	85318	
E14046	83142		E83310	83221		E85024	85024		E85700	85700	
E83200	89402		E83312	83312	89409	E85026	85026		E85702	85702	
E83203	83203	89436	E83312	89409		E85029	85029		E85704	85704	
E83203	89436		E83314	83314		E85030	85030	89440	E85705	85705	89447
E83204	83204		E83318	83318		E85030	89440		E85705	89447	
E83205	83209	89414	E83353	85740		E85300	85300	89419	E85709	85709	
E83205	89414		E83400	83400		E85300	89419		E85711	85711	
E83207	83207	89407	E83401	83401		E85302	85302	89420	E85712	85712	
E83207	89407		E85000	85000	89436	E85302	89420		E85713	85713	
E83209	83209	89414	E85000	89436		E85303	85303	89422	E87000	85711	
E83209	89414		E85001	85001	89410	E85303	89422		E87001	85734	
E83214	83214		E85001	89410		E85304	85304		E87003	85700	
E83215	83215		E85003	85003	89411	E85305	85305		E87006	85736	
E83216	83216		E85003	89411		E85307	85307		E87012	85705	89447
E83218	83122	89406	E85005	85005	89430	E85308	85308	89422	E87012	89447	
E83218	89406		E85005	89430		E85308	89422				
E83219	83219		E85006	85006		E85310	85310	89423			

FCS

Fcs	Gabriel	Upgrade	Fcs	Gabriel	Upgrade	Fcs	Gabriel	Upgrade	Fcs	Gabriel	Upgrade
1331048L	G57278		1331604R	G57106		1331631R	G57085		1331758L	G57345	
1331048R	G57279		1331604R	G57349		1331632L	G57222		1331758R	G57346	
1331060L	G57167		1331605L	G57130		1331632R	G57223		1331759L	G57515	
1331060R	G57168		1331605R	G57131		1331634L	G57333		1331759R	G57516	
1331089	G57397		1331607L	G57192		1331634R	G57334		1331762L	G57339	
1331301L	G57114		1331607R	G57193		1331642L	G57558		1331762R	G57340	
1331520L	G57203		1331612L	G57152		1331642R	G57559		1331763L	G57341	
1331520R	G57202		1331612R	G57153		1331645L	G57144		1331763R	G57342	
1331573L	G57037		1331613L	G57533		1331645R	G57145		1331767L	G57635	
1331573R	G57038		1331613R	G57534		1331646L	G57184		1331767R	G57634	
1331579L	G57275		1331617L	G57357		1331646R	G57185		1331775L	G57369	
1331579R	G57276		1331617R	G57358		1331648L	G57200		1331775R	G57370	
1331581	G57274		1331620L	G57404		1331648R	G57201		1331783L	G57193	
1331582L	G57190		1331620R	G57405		1331660L	G57150		1331783R	G57192	
1331582R	G57191		1331621L	G57444		1331660R	G57151		1331785L	G57152	
1331584L	G57110		1331621R	G57444		1331685L	G57112		1331785L	G57533	
1331584R	G57111		1331622L	G57204		1331685R	G57113		1331785R	G57153	
1331588L	G57098		1331622R	G57205		1331688L	G57583		1331785R	G57534	
1331588R	G57097		1331625L	G57666		1331688R	G57282		1331786L	G57613	
1331595L	G57119		1331625R	G57665		1331702L	G57489		1331786R	G57612	
1331595L	G57606		1331626L	G57664		1331702R	G57490		1331789L	G57176	
1331595R	G57120		1331626R	G57663		1331715L	G57560		1331789L	G57464	
1331595R	G57605		1331628L	G57372		1331715R	G57561		1331789R	G57177	
1331596L	G57157		1331628L	G57375		1331733	G57051		1331789R	G57463	
1331596R	G57158		1331628R	G57373		1331734	G57141		1331794L	G57088	
1331597L	G57163		1331628R	G57376		1331745L	G57341		1331794R	G57089	
1331597R	G57164		1331629L	G57391		1331745R	G57342		1331796L	G57139	
1331601L	G57114		1331629R	G57390		1331747L	G57460				
1331601R	G57115		1331630L	G57084		1331747R	G57459				
1331604L	G57105		1331630R	G57085		1331752L	G57460				
1331604L	G57350		1331631L	G57084		1331753L	G57460				

Important Note: Competitive Interchanges are to be used for stocking purposes only. Where multiple crosses are identified, please reference the applications section of this catalog. / **Remarque importante:** Les interchanges concurrentiels ne s'utilisent qu'aux fins de stocks. Dans le cas de rferences multiples, consulter la section des applications du catalogue. / **Nota importante:** Dans le cas de rferences multiples, consulter la section des applications du catalogue. / **Nota importante:** Se pueden usar intercambios competitivos para propósitos de almacenamiento solamente. Cuando se identifican intercambios múltiples, consulte la sección de aplicaciones de este catálogo.

COMPETITIVE & O.E.M. INTERCHANGE LIST
Lista de Intercambios contra Competidores y Equipo Original.
Liste dinterchange de produits comptitifs & dquipement original (OEM)

FCS... cont'd

Fcs	Gabriel	Upgrade	Fcs	Gabriel	Upgrade	Fcs	Gabriel	Upgrade	Fcs	Gabriel	Upgrade
1331796R	G57140		1332345	G57014		1333307R	G57628		1333435R	G57484	
1331799L	G57398		1332347L	G56924		1333319L	G57481		1333435R	G57658	
1331799R	G57399		1332347R	G56925		1333319R	G57482		1333438L	G57674	
1331802L	G57167		1332348	G57060		1333320L	G57659		1333438R	G57673	
1331802R	G57168		1332349	G57271		1333320R	G57658		1333439L	G57339	
1331803L	G57400		1332350L	G57030		1333354L	G56925		1333439R	G57340	
1331803R	G57401		1332350R	G57031		1333354R	G56924		1333440L	G57604	
1331818	G57142		1332352L	G57045		1333355L	G57393		1333440R	G57603	
1331821	G57206		1332352R	G57046		1333355R	G57394		1333443L	G57695	
1331826L	G57268		1332353	G56929		1333363L	G57582		1333443R	G57696	
1331826R	G57269		1332354	G57005		1333363L	G57583		1333444L	G57190	
1331839L	G57161		1332354	G57006		1333363R	G57583		1333444R	G57191	
1331839R	G57162		1332355L	G57034		1333365L	G57331		1333447L	G57689	
1331847L	G57126		1332355R	G57035		1333365R	G57332		1333447R	G57690	
1331847R	G57127		1332356L	G57047		1333376L	G57500		1333448L	G57152	
1331900L	G57218		1332356R	G57048		1333376R	G57499		1333448R	G57153	
1331900R	G57219		1332357L	G57049		1333377L	G57500		1333450L	G57693	
1331901L	G57343		1332357R	G57050		1333377R	G57499		1333450R	G57694	
1331901R	G57344		1332358L	G57049		1333378L	G57587		1333451L	G57699	
1331908L	G57471		1332358R	G57050		1333378R	G57586		1333451R	G57700	
1331908R	G57472		1332360L	G57078		1333379L	G57152		1333452L	G57218	
1331911L	G57645		1332360R	G57079		1333379L	G57587		1333452R	G57219	
1331911R	G57644		1332362L	G56932		1333379R	G57153		1333454L	G57712	
1331931	G57324		1332362R	G56933		1333379R	G57586		1333454R	G57713	
1332301	G56927		1332363L	G56930		1333380L	G57587		1333462L	G57697	
1332302	G56938		1332363R	G56931		1333380R	G57586		1333462R	G57698	
1332303	G57060		1332366L	G57372		1333392L	G57197		1333464L	G57645	
1332304L	G56924		1332366R	G57373		1333392R	G57198		1333464R	G57644	
1332304R	G56925		1332367L	G57076		1333393L	G57562		1333466L	G57390	
1332305L	G56930		1332367R	G57077		1333393R	G57563		1333466R	G57391	
1332305R	G56931		1332368L	G57041		1333395L	G57564		1333467L	G57549	
1332306L	G56932		1332368R	G57042		1333395R	G57565		1333467R	G57550	
1332306R	G56933		1332369L	G57043		1333402L	G57266		1333468L	G57322	
1332307	G56928		1332369R	G57044		1333402R	G57267		1333468R	G57323	
1332319L	G56956		1333270L	G57069		1333404	G57109		1333471L	G57193	
1332319R	G56957		1333270L	G57121		1333404	G57314		1333471R	G57192	
1332320	G56951		1333270R	G57070		1333406L	G57465		1333475L	G57722	
1332322L	G56962		1333270R	G57122		1333406R	G57466		1333475R	G57723	
1332322R	G56963		1333271L	G57473		1333412L	G57566		1333477L	G57496	
1332323L	G56948		1333271R	G57474		1333412R	G57567		1333477R	G57495	
1332323R	G56948		1333283L	G57473		1333414L	G57377		1333489L	G57746	
1332324L	G56949		1333283R	G57474		1333414R	G57378		1333489R	G57747	
1332324R	G56950		1333290	G57099		1333415L	G57377		1333490	G57709	
1332326L	G56924		1333290	G57100		1333415R	G57378		1333491L	G57730	
1332326R	G56925		1333291L	G57137		1333426L	G57494		1333491R	G57731	
1332327	G57060		1333291R	G57138		1333426R	G57493		1333492L	G57734	
1332328L	G56973		1333296L	G57330		1333431L	G57629		1333492R	G57735	
1332328R	G56974		1333296R	G57329		1333431R	G57628		1333494L	G57739	
1332334	G56975		1333298	G57040		1333432L	G57677		1333494R	G57738	
1332335	G56965		1333299L	G57110		1333432R	G57676		1333495	G57142	
1332338L	G56932		1333299L	G57535		1333433L	G57659		1333503L	G57803	
1332338R	G56933		1333299R	G57111		1333433R	G57658		1333503R	G57804	
1332342L	G57011		1333299R	G57536		1333434L	G57659		1333511L	G57776	
1332342R	G57012		1333305L	G57112		1333434R	G57658		1333511R	G57776	
1332343	G57051		1333305R	G57113		1333435L	G57483		1333524L	G57784	
1332344	G57013		1333307L	G57629		1333435L	G57659		1333524R	G57785	

Important Note: Competitive Interchanges are to be used for stocking purposes only. Where multiple crosses are identified, please reference the applications section of this catalog. / **Remarque importante:** Les interchanges concurrentiels ne s'utilisent qu'aux fins de stocks. Dans le cas de références multiples, consulter la section des applications du catalogue. / **Nota importante:** Dans le cas de referencias multiples, consultar la sección de aplicaciones del catálogo. / **Nota importante:** Se pueden usar intercambios competitivos para propósitos de almacenamiento solamente. Cuando se identifican intercambios múltiples, consulte la sección de aplicaciones de este catálogo.

COMPETITIVE & O.E.M. INTERCHANGE LIST
Lista de Intercambios contra Competidores y Equipo Original.
Liste dinterchange de produits comptitifs & dquipement original (OEM)

FCS... cont'd

Fcs	Gabriel	Upgrade	Fcs	Gabriel	Upgrade	Fcs	Gabriel	Upgrade	Fcs	Gabriel	Upgrade
1333529L	G57812		1335849L	G57390		1336340L	G57033		1345561	G57173	
1333529R	G57812		1335849R	G57390		1336340L	G57061		1345562	G57103	
1333548L	G57192		1335850	G57071		1336340R	G57032		1345563	G57103	
1333548R	G57193		1335875L	G57194		1336340R	G57062		1345564L	G57027	
1333549L	G57266		1335875R	G57195		1336341L	G57065		1345564R	G57027	
1333549R	G57267		1335876L	G57497		1336341R	G57066		1345565L	G57027	
1333565L	G57161		1335876R	G57498		1336342	G57026		1345565R	G57027	
1333565R	G57162		1335877L	G57724		1336343	G57080		1345566L	G57133	
1333714L	G57716		1335877R	G57725		1336347L	G57054		1345566R	G57134	
1333714R	G57717		1335883L	G57764		1336347R	G57055		1345567	G57147	
1333719L	G57543		1335883R	G57765		1336348	G57056		1345568	G57420	
1333719R	G57544		1335892L	G57726		1336349	G57080		1345682	G57646	
1333745L	G57780		1335892R	G57727		1337006L	G57774		1345683	G57447	
1333745R	G57781		1335893L	G57724		1337006R	G57775		1345685L	G57419	
1333790L	G57480		1335893R	G57725		1337023L	G57800		1345685R	G57419	
1333790R	G57479		1335896L	G57517		1337023R	G57801		1345687	G57095	
1333816L	G57780		1335896R	G57518		1345395	G57159		1345688L	G57416	
1333816R	G57781		1335897L	G57517		1345395	G57160		1345688R	G57682	
1333817L	G57076		1335897R	G57518		1345399	G57075		1345689L	G57451	
1333817R	G57077		1335924L	G57161		1345401	G57159		1345689R	G57452	
1333919L	G57852		1335924R	G57162		1345401	G57160		1345695	G57706	
1333919R	G57853		1336301L	G57063		1345403L	G57424		1345721L	G57480	
1333926L	G57782		1336301R	G57064		1345403R	G57425		1345721L	G57597	
1333926R	G57783		1336302	G56934		1345404L	G57067		1345721R	G57479	
1335383L	G57353		1336302	G56937		1345404R	G57068		1345721R	G57598	
1335383R	G57354		1336303	G56936		1345409L	G57444		1345741L	G57451	
1335527L	G57270		1336304	G56935		1345409R	G57444		1345741R	G57452	
1335527R	G57270		1336305L	G56991		1345411L	G57133		1345742L	G57572	
1335543L	G57148		1336305R	G56992		1345411R	G57134		1345742R	G57573	
1335543R	G57148		1336306	G57039		1345416L	G57086		1345750	G57447	
1335556	G57059		1336312	G56943		1345416R	G57087		1345761	G57675	
1335562L	G57135		1336313	G56964		1345417L	G57414		1345762	G57675	
1335562R	G57136		1336315	G56998		1345417R	G57415		1345763	G57703	
1335576	G57156		1336316	G57057		1345455	G57282		1345768	G57703	
1335576	G57277		1336316	G57058		1345459L	G57090		1345815	G57000	
1335582	G57083		1336318	G56995		1345459R	G57091		1345816R	G57683	
1335582L	G57083		1336322L	G56993		1345469L	G57107		1345837R	G57683	
1335582R	G57083		1336322R	G56994		1345469R	G57108		1345844	G57794	
1335604L	G57128		1336323	G57018		1345470	G57423		1345845L	G57192	
1335604R	G57129		1336324	G57022		1345471L	G57428		1345845R	G57193	
1335664	G57149		1336325L	G57010		1345471R	G57429		1345849L	G57454	
1335682L	G57363		1336325R	G57010		1345477	G57421		1345849R	G57453	
1335682R	G57364		1336326	G57020		1345484	G57178		1345880	G57683	
1335778	G57071		1336327	G57015		1345497	G57092		1345959	G57799	
1335778	G57072		1336327	G57212		1345540	G57096		1346088	G57343	
1335779L	G57081		1336328	G57016		1345541	G57703		1346088	G57344	
1335779R	G57082		1336329L	G57007		1345555	G57125		1346361L	G57133	
1335790	G57427		1336329R	G57008		1345556	G57146		1346361R	G57134	
1335795L	G57337		1336330	G57017		1345557	G57118		1355057	G57683	
1335795R	G57338		1336331	G57021		1345557	G57413		2331579L	G57275	
1335797L	G57207		1336332	G57019		1345558L	G57123		2331579R	G57276	
1335797R	G57417		1336333	G57023		1345558L	G57220		2331582L	G57190	
1335801L	G57595		1336334	G57053		1345558R	G57124		2331582R	G57191	
1335801R	G57594		1336337L	G56996		1345558R	G57221		2331590L	G57613	
1335848L	G57359		1336337R	G56997		1345559	G57095		2331590R	G57612	
1335848R	G57360		1336339	G57036		1345560	G57172		2331595L	G57119	

Important Note: Competitive Interchanges are to be used for stocking purposes only. Where multiple crosses are identified, please reference the applications section of this catalog. / **Remarque importante:** Les interchanges concurrentiels ne s'utilisent qu'aux fins de stocks. Dans le cas de rfrences multiples, consulter la section des applications du catalogue. / **Nota importante:** Dans le cas de rfrences multiples, consulter la section des applications du catalogue. / **Nota importante:** Se pueden usar intercambios competitivos para propósitos de almacenamiento solamente. Cuando se identifican intercambios múltiples, consulte la sección de aplicaciones de este catálogo.

COMPETITIVE & O.E.M. INTERCHANGE LIST
Lista de Intercambios contra Competidores y Equipo Original.
Liste dinterchange de produits comptitifs & dquipement original (OEM)

FCS... cont'd

Fcs	Gabriel	Upgrade	Fcs	Gabriel	Upgrade	Fcs	Gabriel	Upgrade	Fcs	Gabriel	Upgrade
2331595R	G57120		2333363R	G57582		2335543R	G57148		331019L	G56634	
2331604L	G57350		2333365L	G57480		2335576	G57680		331019R	G56633	
2331604R	G57349		2333365R	G57479		2335582L	G57083		331060L	G56640	
2331613L	G57533		2333376L	G57500		2335582R	G57083		331060R	G56641	
2331613R	G57534		2333376R	G57499		2335779L	G57081		331579L	G52154	
2331622L	G57204		2333378L	G57152		2335779R	G57082		331579R	G52155	
2331622R	G57205		2333378R	G57153		2335790	G57427		331587	G56802	
2331629L	G57390		2333392L	G57197		2335790R	G57427		331588L	G55993	
2331629R	G57391		2333392I	G57322		2335797L	G57418		331588R	G55994	
2331632L	G57222		2333392R	G57198		2335797R	G57417		331597L	G52008	
2331632R	G57223		2333392R	G57323		2335801L	G57455		331597R	G52009	
2331645L	G57144		2333393L	G57720		2335801R	G57456		331601L	G56661	
2331645R	G57145		2333393R	G57721		2335849L	G57449		331601R	G56660	
2331688L	G57583		2333406L	G57465		2335849R	G57450		331603L	G56615	
2331688R	G57282		2333406R	G57466		2335850	G57071		331603R	G56616	
2331747L	G57459		2333412L	G57566		2335876L	G57497		331604L	G56582	
2331747R	G57460		2333412R	G57567		2335876R	G57498		331604R	G56581	
2331762L	G57339		2333414L	G57378		2335883L	G57764		331607L	G52103	
2331762R	G57340		2333414R	G57377		2335883R	G57765		331607R	G52104	
2331785L	G57153		2333415L	G57377		2335893R	G57727		331617L	G52013	
2331785R	G57152		2333415R	G57378		2335897L	G57517		331617R	G52014	
2331794L	G57088		2333438L	G57674		2335897R	G57518		331622L	G52004	
2331794R	G57089		2333438R	G57673		2336305L	G56991		331622R	G52007	
2331796L	G57139		2333444L	G57190		2336306	G57039		331625L	G52105	
2331796R	G57140		2333444R	G57191		2336324	G57022		331625R	G52106	
2331821	G57206		2333445L	G57701		2336329L	G57007		331626L	G52107	
2331839L	G57161		2333445R	G57702		2336329R	G57008		331626R	G52108	
2331839R	G57162		2333447L	G57689		2336338	G57422		331628L	G52107	
2331852L	G57539		2333447R	G57690		2336338	G57423		331628R	G52108	
2331852R	G57540		2333450L	G57691		2336347	G57056		331630L	G56800	
2331908L	G57471		2333450R	G57692		2337006L	G57774		331631L	G56800	
2331908R	G57472		2333451L	G57697		2337006R	G57775		331631R	G56799	
2331931	G57324		2333451R	G57698		2345455	G57282		331632L	G52112	
2332304L	G56924		2333467L	G57549		2345484	G57607		331632R	G52113	
2332304R	G56925		2333467R	G57550		2345497	G57092		331633L	G52282	
2332350L	G57030		2333489L	G57746		2345540	G57096		331633R	G52283	
2332350R	G57031		2333489R	G57747		2345541	G57703		331634L	G52150	
2332352L	G57045		2333491L	G57730		2345556	G57409		331634R	G52151	
2332352R	G57046		2333491R	G57731		2345558L	G57123		331639L	G55999	
2332357L	G57049		2333492L	G57733		2345558R	G57124		331639R	G55999	
2332357R	G57050		2333492R	G57732		2345559	G57095		331644L	G56687	
2332367L	G57076		2333494L	G57738		2345561	G57173		331644R	G56688	
2332367R	G57077		2333494R	G57739		2345682	G57647		331645L	G56615	
2332368L	G57041		2333511L	G57777		2345721L	G57480		331645R	G56616	
2332368R	G57042		2333511R	G57777		2345721R	G57479		331646L	G52032	
2333296L	G57329		2333714L	G57716		2345742L	G57451		331646R	G52033	
2333296R	G57330		2333714R	G57717		2345742R	G57452		331648L	G52094	
2333319L	G57481		2333745L	G57780		2345750	G57579		331648R	G52095	
2333319R	G57482		2333745R	G57781		2345763	G57703		331660L	G56679	
2333320L	G57659		2333816L	G57780		2345763	G57703		331660R	G56680	
2333320R	G57658		2333816R	G57781		2345815	G57000		331660R	G56680	
2333354L	G56924		2333817L	G57076		2345844	G57794		331661L	G52168	
2333354R	G56925		2333817R	G57077		2345849L	G57454		331661R	G52169	
2333355L	G57393		2335527L	G57270		2345849R	G57453		331668L	G56530	
2333355R	G57394		2335527R	G57270		2345881	G57748		331668R	G56529	
2333363L	G57583		2335543L	G57148		331008L	G56538		331669L	G56530	
						331008R	G56537		331669R	G56529	

Important Note: Competitive Interchanges are to be used for stocking purposes only. Where multiple crosses are identified, please reference the applications section of this catalog. / **Remarque importante:** Les interchanges concurrentiels ne s'utilisent qu'aux fins de stocks. Dans le cas de références multiples, consulter la section des applications du catalogue. / **Nota importante:** En el caso de referencias múltiples, consultar la sección de aplicaciones del catálogo. / **Nota importante:** Se pueden usar intercambios competitivos para propósitos de almacenamiento solamente. Cuando se identifican intercambios múltiples, consulte la sección de aplicaciones de este catálogo.

COMPETITIVE & O.E.M. INTERCHANGE LIST
Lista de Intercambios contra Competidores y Equipo Original.
Liste dinterchange de produits comptitifs & dquipement original (OEM)

FCS... cont'd

Fcs	Gabriel	Upgrade	Fcs	Gabriel	Upgrade	Fcs	Gabriel	Upgrade	Fcs	Gabriel	Upgrade
331674L	G52260		332324R	G55662		3333445R	G57702		3335876L	G57497	
331674R	G52261		332334	G55892		3333467L	G57549		3335876R	G57498	
331688R	G56841		332335	G55896		3333467R	G57550		3336329L	G57007	
331692	G55681		332343	G56509		3333489L	G57744		3336329R	G57008	
331700	G56778		332349	G56817		3333489R	G57745		3336347L	G57055	
331709L	G52017		332350L	G56671		333354	G55949		3336347R	G57054	
331709R	G52018		332350R	G56672		333355L	G52156		3345484	G57607	
331713L	G52144		332352L	G56601		333355R	G52157		3345497	G57144	
331713R	G52145		332352R	G56568		3333564L	G57772		3345497	G57145	
331715L	G52249		332356	G56810		3333564R	G57773		3345559	G57095	
331715R	G52250		332357L	G56621		333356L	G52255		3345682	G57646	
331716L	G52140		332357R	G56622		333356R	G52256		3345742L	G57572	
331716R	G52141		332366L	G55993		333363L	G52351		3345742R	G57573	
331727	G55948		332366R	G55994		333363R	G52352		335027	G55820	
331733	G56509		3331582L	G57190		333365L	G52187		3355037	G57023	
331741L	G52184		3331582R	G57191		333365R	G52188		335523L	G51813	
331741R	G52185		3331595L	G57119		333379L	G56732		335523R	G51814	
331773	G52098		3331595R	G57120		333379R	G56733		335531L	G51761	
331775L	G52096		3331622L	G57204		333392L	G52127		335531R	G51760	
331775R	G52097		3331622R	G57205		333392R	G52128		335533	G51267	
331778L	G52026		3331660L	G57151		333393L	G52201		335541	G56655	
331778R	G52027		3331660R	G57150		333393R	G52202		335542L	G52110	
331783L	G52103		3331821L	G57206		333402L	G52131		335542R	G52111	
331783R	G52104		3331821R	G57206		333402R	G52131		335543L	G51859	
331789L	G52081		3332304L	G56924		333404	G52125		335543R	G51859	
331789R	G52082		3332304R	G56925		333406L	G52117		335552	G55901	
331796L	G56562		333283L	G52173		333406R	G52118		335555L	G52274	
331796R	G56561		333283R	G52174		333426L	G52382		335555R	G52275	
331802L	G52335		333290	G56809		333426R	G52383		335556	G51714	
331802R	G52336		333292	G55551		333431L	G52374		335559	G51740	
331818	G52025		333296L	G52245		333431R	G52375		335561	G51097	
331820	G56700		333296R	G52246		333435L	G52203		335576	G56899	
331821	G52131		333297	G56701		333435R	G52204		335582	G56807	
331825L	G55591		333319L	G52201		333440L	G52152		335583L	G51813	
331825R	G55591		333319R	G52202		333440R	G52153		335583R	G51814	
331845L	G52182		3333296L	G57329		333443L	G52360		335586	G56565	
331845R	G52183		3333296R	G57330		333443R	G52361		335605	G51718	
331908L	G52158		3333354L	G56924		333453L	G52209		335632L	G52314	
331908R	G52159		3333354R	G56925		333453R	G52210		335632R	G52314	
331909L	G52247		3333363L	G57583		333494L	G52331		335664	G51806	
331909R	G52248		3333363R	G57282		333494R	G52332		335666	G51806	
331931	G52116		3333392L	G57197		333504L	G52329		335779L	G56836	
332302	G55825		3333392R	G57198		333504R	G52330		335779R	G56837	
332303	G55948		3333393L	G57720		333507L	G52280		335811	G52276	
332304	G55949		3333393R	G57721		333507R	G52281		335836L	G51920	
332305L	G56506		3333406L	G57465		3335576	G57156		335836R	G51921	
332305R	G56514		3333406R	G57466		333560L	G52260		336301L	G56516	
332306L	G55675		3333412L	G57329		333560R	G52261		336301R	G56517	
332306R	G55676		3333412R	G57330		333564L	G52524		336303	G55901	
332312	G56718		3333414L	G57377		333564R	G52525		336306	G56606	
332316	G55697		3333414R	G57378		3335779L	G57081		336311L	G52005	
332317	G55698		3333415L	G57377		3335779R	G57082		336311R	G52006	
332319	G56620		3333415R	G57378		3335797L	G57208		336313	G55856	
332323L	G55999		3333444L	G57190		3335797R	G57207		336315	G55910	
332323R	G55999		3333444R	G57191		3335801L	G57455		336316	G51087	
332324L	G55661		3333445L	G57701		3335801R	G57456		336325	G51077	

Important Note: Competitive Interchanges are to be used for stocking purposes only. Where multiple crosses are identified, please reference the applications section of this catalog./ **Remarque importante:** Les interchanges concurrentiels ne s'utilisent qu'aux fins de stocks. Dans le cas de rfrences multiples, consulter la section des applications du catalogue./ **Nota importante:** Dans le cas de rfrences multiples, consulter la section des applications du catalogue./ **Nota importante:** Se pueden usar intercambios competitivos para propósitos de almacenamiento solamente. Cuando se identifican intercambios múltiples, consulte la sección de aplicaciones de este catálogo.

COMPETITIVE & O.E.M. INTERCHANGE LIST
Lista de Intercambios contra Competidores y Equipo Original.
Liste dinterchange de produits comptitifs & dquipement original (OEM)

FCS... cont'd

Fcs	Gabriel	Upgrade	Fcs	Gabriel	Upgrade	Fcs	Gabriel	Upgrade	Fcs	Gabriel	Upgrade
336329	G51728		341553	G63813		341715	70037		342509	G63810	
336330	G51722		341554	81478		341716	70013		342510	G63808	
336332	G51723		341556	81478		341952	G64047		342511	G63810	
336333	G51870		341557	G51812		341962	G51807		342512	81710	
336334	G51758		341558	G51802		341964	70049		342513	G63873	
336338	G51268		341559	G51798		341967	69575		342516	81516	
336340	G51700		341560	G51803		341974	81870		342517	G63879	
336341	G51077		341561	70041		341979	69946		342518	G63882	
336343	G51887		341562	G64027		341980	69450		342519	81482	
336348	G51738		341567	81916		342129	G63299		342527	81873	
336349	G51888		341568	81744		342390	81935		342528	81931	
341012	82156		341570	G51721		342445	81878		342529	81921	
341092	70000		341573	81582		342462	81726		342534	G63918	
341347	69863		341574	G63410		342464	82001		342536	69585	
341424	70003		341575	81713		342465	G64003		342537	G64032	
341511	81668		341576	81744		342466	81667		342540	G64003	
341512	81713		341577	81744		342467	81039		342541	69724	
341513	81541		341578	81912		342467	81496		342542	81492	
341514	81490		341579	81914		342468	81926		342542	81494	
341514	81836		341580	G63886		342470	69473		342542	81514	
341516	G63862		341581	81833		342471	69590		342543	G63776	
341517	69625		341582	81828		342472	81730		342546	69587	
341517	81446		341583	G64037		342472	81891		342547	G64015	
341517	81492		341584	81892		342472	81917		342549	81676	
341517	81494		341585	81913		342473	69591		342549	82007	
341517	81495		341586	81935		342474	69787		342550	69587	
341518	81548		341587	69592		342475	G63842		342551	G63872	
341519	81893		341588	81794		342476	81930		342554	81549	
341520	82155		341590	69962		342477	G63868		342555	81549	
341522	69863		341593	G63884		342478	81318		342556	G64012	
341523	G51807		341594	G63894		342479	81871		342557	G63844	
341524	69907		341595	81922		342480	81147		342558	81929	
341526	70020		341596	G63895		342481	G64026		342561	81923	
341527	81935		341597	81920		342484	G63937		342564	G63962	
341528	81872		341598	81925		342485	G63875		342565	81873	
341529	G51805		341599	81920		342486	81147		342567	81496	
341530	81869		341600	81904		342487	82066		342572	G63866	
341531	81922		341603	70013		342488	81910		342573	81880	
341532	G63885		341608	69420		342489	70027		342770	G64042	
341533	G63832		341613	81481		342490	G63883		342778	70010	
341534	G63860		341615	69589		342491	G63878		342779	G63959	
341535	G63860		341617	81934		342492	G64028		342780	81484	
341537	G64087		341623	70028		342493	81318		342781	81113	
341538	G64087		341624	70055		342494	81923		342785	G64071	
341539	G51805		341627	81936		342496	81821		342787	G64033	
341540	81416		341629	81691		342496	81905		342789	G64079	
341541	G63937		341635	70036		342496	81918		342790	G63886	
341542	G63889		341638	81933		342500	G63717		342791	G64050	
341543	G64006		341639	81928		342501	81082		342792	69465	
341544	G64038		341640	81932		342501	81510		342798	G63845	
341545	70060		341641	81919		342501	81710		342799	81750	
341546	G55821		341642	G63958		342502	G63809		342827	G63622	
341548	81911		341643	G64011		342505	G63717		342838	81676	
341550	G63828		341645	81096		342506	81890		342840	G64016	
341551	G63815		341649	82138		342507	G63870		342841	G63892	
341552	81507		341688	G51874		342508	G63867		342843	G64040	

Important Note: Competitive Interchanges are to be used for stocking purposes only. Where multiple crosses are identified, please reference the applications section of this catalog. / **Remarque importante:** Les interchanges concurrentiels ne s'utilisent qu'aux fins de stocks. Dans le cas de références multiples, consulter la section des applications du catalogue. / **Nota importante:** Dans le cas de références multiples, consulter la section des applications du catalogue. / **Nota importante:** Se pueden usar intercambios competitivos para propósitos de almacenamiento solamente. Cuando se identifican intercambios múltiples, consulte la sección de aplicaciones de este catálogo.

COMPETITIVE & O.E.M. INTERCHANGE LIST
Lista de Intercambios contra Competidores y Equipo Original.
Liste dinterchange de produits comptitifs & dquipement original (OEM)

FCS... cont'd

Fcs	Gabriel	Upgrade	Fcs	Gabriel	Upgrade	Fcs	Gabriel	Upgrade	Fcs	Gabriel	Upgrade
342844	70203		345556	G51815		346324	G51971		F343379	85728	
342845	G64031		345563	G51864		346341	G511030		F343380	85727	
342846	G64121		345567	G51856		346343	70086		F343381	83400	
342848	G64148		345681	G51765		346367	G63885		F343382	83613	
342856	G64040		345682	G51766		346370	G511142		F344342	85936	89456
342873	G64104		345683	G51863		346410	G511000		F344342	89456	
342875	70203		345685	G51892		346443	70207		F344343	85937	
342889	69591		345688	G51879		346449	G511038		F344344	83027	
342905	70098		345689	G51898		346452	G51990		F344345	83112	
342922	G64143		345691	G51860		347007	G64048		F344347	83062	
342944	G64186		345692	G51861		347015	G64186		F344348	83041	
342946	G64012		345694	G51865		347023	G64050		F344349	83045	
342949	G64031		345695	G51961		347037	G63888		F344350	83050	
343308	81270		345734	G51848		347072	70098		F344351	83019	
343329	82004		345742	G51898		4331622L	G57204		F344352	85729	
343330	82125		345750	G51863		4331622R	G57205		F344353	83142	
343339	82126		345764L	G511054		4331660L	G57151		F344354	83111	
344312	81076		345764R	G511055		4331660R	G57150		F344355	83143	
345315	G51794		345766	G51922		4331821L	G57206		F344356	83154	
345378	G51795		345825	G51916		4331821R	G57206		F344357	83110	
345395	G51727		345826	G51975		4333363L	G57583		F344358	85026	
345398	G51767		346017	70052		4333363R	G57282		F344360	83109	
345401	G51727		346031	G51884		4333392L	G57197		F346598	85033	89427
345402	G51910		346051	G63726		4333392R	G57198		F346598	89427	
345403	G51858		346052	82090		4333406L	G57465		F346599	85311	89424
345404	G51736		346054	70055		4333406R	G57466		F346599	89424	
345405	G51739		346056	G63815		4333489L	G57744		F346601	85319	89428
345408	G55804		346057	G51966		4333489R	G57745		F346601	89428	
345412	G51477		346066	G51971		4335790	G57427		F346603	85316	89426
345413	G51738		346087	G64056		4345497	G57118		F346603	89426	
345414	G51716		346088	G64216		5331821L	G57206		F346632	83317	
345417	G51880		346090	G51905		5331821R	G57206		F346633	85988	
345419	G51715		346091	G511134		5333392L	G57197		F346634	83515	
345430	G51883		346092	70078		5333392R	G57198		F346635	83518	
345433	G51980		346093	70068		5333406L	G57465		F346636	83395	
345434	G51794		346099	G51980		5333406R	G57466		F346637	85649	
345436	G51838		346100	G51980		5335790	G57427		F347193	85030	89440
345443	G51719		346101	G51980		6333406L	G57578		F347193	89440	
345447	G51703		346102	G511092		6333406R	G57577		F347194	83203	89436
345448	G51704		346103	G511092		DG341531	58803		F347194	89436	
345450	G51729		346104	G64111		DG342476	G63866		F347195	85053	89442
345451	G51724		346113	70086		DT341951	70040		F347195	89442	
345455	G51850		346114	70053		DT346181	G64046		F347196	85052	
345456	G51841		346128	70096		DT346207	G511001		F347197	85088	
345458L	G52036		346131	70096		DT347071	77412		F347198	85058	89431
345458R	G52037		346178	70059		F343368	85069	89455	F347198	89431	
345471	G51852		346212	70036		F343368	89455		F347199	85738	
345472	G51759		346213	G511078		F343371	85708		F347200	85072	
345474	G56598		346218	G511000		F343372	83136		F347201	85064	
345478	G51832		346239	G511044		F343373	83456	89447	F347202	85045	
345483	G51833		346240	G51905		F343373	89447		F347203	83127	
345484	G51842		346243	G511044		F343374	85722		F347204	83008	
345490	G51881		346249	G64216		F343375	85310	89423	F347205	85061	89450
345491	G51855		346253	G511092		F343375	89423		F347206	85029	
345492	G51477		346256	G64216		F343376	85900		F347207	85061	89450
345555	G51891		346258	70096		F343378	85902		F347208	85938	

Important Note: Competitive Interchanges are to be used for stocking purposes only. Where multiple crosses are identified, please reference the applications section of this catalog./ **Remarque importante:** Les interchanges concurrentiels ne s'utilisent qu'aux fins de stocks. Dans le cas de rfrences multiples, consulter la section des applications du catalogue./ **Nota importante:** Dans le cas de rfrences multiples, consulter la section des applications du catalogue./ **Nota importante:** Se pueden usar intercambios competitivos para propósitos de almacenamiento solamente. Cuando se identifican intercambios múltiples, consulte la sección de aplicaciones de este catálogo.

COMPETITIVE & O.E.M. INTERCHANGE LIST
Lista de Intercambios contra Competidores y Equipo Original.
Liste dinterchange de produits comptitifs & dquipement original (OEM)

FCS... cont'd

Fcs	Gabriel	Upgrade	Fcs	Gabriel	Upgrade	Fcs	Gabriel	Upgrade	Fcs	Gabriel	Upgrade
F347209	83124	89407	F347245	83029		F347276	89458		F347324	85338	
F347209	89407		F347246	83130		F347277	83148		F347325	83312	89409
F347210	83207	89407	F347247	83135		F347278	83017		F347325	89409	
F347210	89407		F347248	83123	89405	F347279	85014		F347326	85046	89434
F347211	85066	89448	F347248	89405		F347280	85010		F347326	89434	
F347211	89448		F347249	85084	89460	F347291	83047		F347327	83150	
F347212	83125		F347249	89460		F347292	83049		F347328	83204	
F347213	85931	89458	F347250	85300	89419	F347293	83024		F347329	85906	89407
F347213	89458		F347250	89419		F347294	83026		F347329	89407	
F347214	83048		F347251	85023	89415	F347295	83011		F347330	85337	
F347215	85067	89451	F347251	89415		F347296	83006		F347331	85916	89430
F347215	89451		F347252	83002		F347297	83053		F347331	89430	
F347216	83389	89436	F347253	83025		F347298	83044		F347332	85911	
F347216	85000	89436	F347254	83051		F347299	83081		F347333	83215	
F347216	89436		F347255	83035		F347300	85989		F347334	85055	89439
F347217	83128	89436	F347256	83028		F347302	85656		F347334	89439	
F347217	89436		F347257	83031		F347303	85060		F347335	85304	
F347218	83147		F347260	85724	89443	F347304	83163		F347335	85734	
F347219	85006		F347260	89443		F347305	85939		F347336	85321	
F347220	85954		F347261	85918	89449	F347306	85909		F347337	83309	
F347221	85924	89457	F347261	89449		F347307	85036	89405	F347339	85967	
F347221	89457		F347262	83038		F347307	89405		F347340	85308	89422
F347222	83021		F347263	85001	89410	F347308	85051		F347340	89422	
F347223	85934		F347263	89410		F347309	83122	89406	F347341	85024	
F347224	85919		F347264	85323	89436	F347309	89406		F347342	83169	
F347225	85958		F347264	89436		F347310	85031		F347343	83905	
F347226	85012	89413	F347265	85320	89429	F347311	85343		F347344	83906	
F347226	89413		F347265	89429		F347312	85712		F347345	85637	
F347227	85062	89408	F347266	85003	89411	F347313	83140		F347346	85642	
F347227	89408		F347266	89411		F347314	85301		F347347	83519	
F347231	83001		F347267	83009		F347314	85302	89420	F347348	83391	
F347232	85959		F347268	85920	89503	F347314	89420		F347349	83363	
F347233	85070	89459	F347268	89503		F347315	83126	89430	F347350	85639	
F347233	89459		F347269	85013	89414	F347315	89430		F347351	83901	
F347234	85933	89454	F347269	89414		F347316	85303	89422	F347352	83389	89436
F347234	89454		F347270	85005	89430	F347316	89422		F347352	89436	
F347235	85978		F347270	89430		F347317	83166		F347353	83364	
F347236	83137		F347271	85901		F347318	85305		F347354	85638	
F347238	85331		F347272	85932	89453	F347318	85307		F347355	85648	
F347239	85976		F347272	89453		F347319	83221		F347356	85650	
F347241	85928		F347273	85047	89435	F347319	85071		F442755	646155	
F347242	85957		F347273	89435		F347320	87015		F442790	646177	
F347243	83209	89414	F347274	85956		F347321	85007		F442791	665937	
F347243	89414		F347275	83042		F347322	85334				
F347244	85043		F347276	85923	89458	F347323	83101				

Federal Coach

Federal coach	Gabriel	Upgrade	Federal coach	Gabriel	Upgrade	Federal coach	Gabriel	Upgrade	Federal coach	Gabriel	Upgrade
10-12388-000	85920	89503	1012388000	89503		1618708000	85724	89443	471700002991	85959	
10-12388-000	89503		1012390000	85920	89503	1618708000	89443		ASH-1136	G63623	
10-12390-000	85920	89503	1012390000	89503		471700002809	85724	89443	ASH-1154	G63622	
10-12390-000	89503		1013760000	85959		471700002809	89443		ASH1136	G63623	
10-13760-000	85959		16-18708-000	85724	89443	471700002810	85724	89443	ASH1154	G63622	
1012388000	85920	89503	16-18708-000	89443		471700002810	89443		SDA471700002991	85959	

Fleetrite

Fleetrite	Gabriel	Upgrade	Fleetrite	Gabriel	Upgrade	Fleetrite	Gabriel	Upgrade	Fleetrite	Gabriel	Upgrade
AMS600101	85003	89411	AMS600102	85005	89430						
AMS600101	89411		AMS600102	89430							

Important Note: Competitive Interchanges are to be used for stocking purposes only. Where multiple crosses are identified, please reference the applications section of this catalog. / **Remarque importante:** Les interchanges concurrentiels ne s'utilisent qu'aux fins de stocks. Dans le cas de rferences multiples, consulter la section des applications du catalogue. / **Nota importante:** Dans le cas de rferences multiples, consulter la section des aplicaciones du catalogue. / **Nota importante:** Se pueden usar intercambios competitivos para propósitos de almacenamiento solamente. Cuando se identifican intercambios múltiples, consulte la sección de aplicaciones de este catálogo.

COMPETITIVE & O.E.M. INTERCHANGE LIST
Lista de Intercambios contra Competidores y Equipo Original.
Liste dinterchange de produits comptitifs & dquipement original (OEM)

Fleetrite... cont'd

Fleetrite	Gabriel	Upgrade	Fleetrite	Gabriel	Upgrade	Fleetrite	Gabriel	Upgrade	Fleetrite	Gabriel	Upgrade
AMS600103	85014		AMS600174	83125		AMS650411	85036	89405	AMS650478	85030	89440
AMS600104	85000	89436	AMS600175	83120		AMS650411	89405		AMS650478	89440	
AMS600104	89436		AMS600202	83009		AMS650412	83122	89406	AMS650479	83122	89406
AMS600106	83312	89409	AMS650101	85062	89408	AMS650412	89406		AMS650479	89406	
AMS600106	89409		AMS650101	89408		AMS650415	85046	89434	AMS650480	83109	
AMS600107	83309		AMS650102	85001	89410	AMS650415	89434		AMS650480	83111	
AMS600108	83209	89414	AMS650102	89410		AMS650416	85323	89436	AMS650481	83123	89405
AMS600108	89414		AMS650103	85320	89429	AMS650416	89436		AMS650481	89405	
AMS600110	83303		AMS650103	89429		AMS650417	85322		AMS650482	85006	
AMS600111	83301		AMS650105	85026		AMS650418	85906	89407	AMS650486	85066	89448
AMS600112	83456	89447	AMS650107	85316	89426	AMS650418	89407		AMS650486	89448	
AMS600112	89447		AMS650107	89426		AMS650419	85000	89436	AMS65107	85316	89426
AMS600113	83215		AMS650108	85030	89440	AMS650419	89436		AMS65107	89426	
AMS600114	83125		AMS650108	89440		AMS650420	85013	89414	AMS65109	85058	89431
AMS600116	83216		AMS650109	85058	89431	AMS650420	89414		AMS65109	89431	
AMS600117	83308		AMS650109	89431		AMS650421	85916	89430	AMS65144	85957	
AMS600118	83219		AMS650110	85005	89430	AMS650421	89430		AMS65146	85648	
AMS600119	83314		AMS650110	89430		AMS650426	85054		AMS65158	85954	
AMS600120	G63605		AMS650111	85006		AMS650428	85321		AMS660102	85005	89430
AMS600123	G63183		AMS650112	89402		AMS650429	85030	89440	AMS660102	89430	
AMS600125	83123	89405	AMS650113	85012	89413	AMS650429	89440		AMS660103	85014	
AMS600125	89405		AMS650113	89413		AMS650430	85712		AMS660104	85000	89436
AMS600126	83400		AMS650114	85006		AMS650431	85909		AMS660104	89436	
AMS600128	83401		AMS650115	85027		AMS650432	85910		AMS660106	83312	89409
AMS600129	83317		AMS650116	85303	89422	AMS650433	85910		AMS660106	89409	
AMS600130	83204		AMS650116	89422		AMS650434	85012	89413	AMS660107	83309	
AMS600131	83318		AMS650118	83215		AMS650434	89413		AMS660108	83209	89414
AMS600132	83215		AMS650119	85029		AMS650435	85901		AMS660108	89414	
AMS600134	83221		AMS650120	85010		AMS650436	85900		AMS660110	83303	
AMS600136	85740		AMS650121	89432		AMS650439	85732		AMS660111	83301	
AMS600139	85740		AMS650122	85063		AMS650440	85711		AMS660112	83456	89447
AMS600142	83209	89414	AMS650123	85054		AMS650441	85704		AMS660112	89447	
AMS600142	89414		AMS650124	85053	89442	AMS650442	85700		AMS660113	83215	
AMS600145	85040		AMS650124	89442		AMS650444	85311	89424	AMS660114	85006	
AMS600146	83105		AMS650128	85031		AMS650444	89424		AMS660116	83216	
AMS600147	83216		AMS650130	85061	89450	AMS650448	85700		AMS660117	83308	
AMS600148	85026		AMS650139	85918	89449	AMS650449	85702		AMS660118	85012	89413
AMS600150	85009		AMS650139	89449		AMS650451	85029		AMS660118	89413	
AMS600151	85024		AMS650400	85033	89427	AMS650452	85733		AMS660119	83314	
AMS600152	83242		AMS650400	89427		AMS650453	85043		AMS660120	G63605	
AMS600153	85003	89411	AMS650401	85013	89414	AMS650454	85713		AMS660123	G63183	
AMS600153	89411		AMS650401	89414		AMS650455	85716		AMS660125	83123	89405
AMS600155	83103		AMS650402	85311	89424	AMS650456	85376		AMS660125	89405	
AMS600156	83103		AMS650402	89424		AMS650458	85908		AMS660126	83400	
AMS600157	83221		AMS650404	85310	89423	AMS650459	85043		AMS660128	83401	
AMS600162	83103		AMS650404	89423		AMS650463	85040		AMS660129	83317	
AMS600163	83101		AMS650405	85023	89415	AMS650464	85716		AMS660130	83204	
AMS600164	83613		AMS650405	89415		AMS650466	85047	89435	AMS660131	83318	
AMS600166	85052		AMS650406	85024		AMS650466	89435		AMS660132	83215	
AMS600167	83128	89436	AMS650407	85736		AMS650468	85069	89455	AMS660134	83221	
AMS600167	89436		AMS650408	85319	89428	AMS650468	89455		AMS660136	85740	
AMS600168	83635		AMS650408	89428		AMS650471	85302	89420	AMS660142	83209	89414
AMS600169	85051		AMS650409	85003	89411	AMS650471	89420		AMS660142	89414	
AMS600172	85005	89430	AMS650409	89411		AMS650473	85329		AMS660145	85040	
AMS600172	89430		AMS650410	85300	89419	AMS650474	85712		AMS660146	83105	
AMS600173	85043		AMS650410	89419		AMS650475	85065		AMS660147	83216	

Important Note: Competitive Interchanges are to be used for stocking purposes only. Where multiple crosses are identified, please reference the applications section of this catalog. / **Remarque importante:** Les interchanges concurrentiels ne s'utilisent qu'aux fins de stocks. Dans le cas de rferences multiples, consulter la section des applications du catalogue. / **Nota importante:** Dans le cas de rferences multiples, consulter la section des applications du catalogue. / **Nota importante:** Se pueden usar intercambios competitivos para propósitos de almacenamiento solamente. Cuando se identifican intercambios múltiples, consulte la sección de aplicaciones de este catálogo.

COMPETITIVE & O.E.M. INTERCHANGE LIST
Lista de Intercambios contra Competidores y Equipo Original.
Liste dinterchange de produits comptitifs & dquipement original (OEM)

Fleetrite... cont'd

Fleetrite	Gabriel	Upgrade	Fleetrite	Gabriel	Upgrade	Fleetrite	Gabriel	Upgrade	Fleetrite	Gabriel	Upgrade
AMS660148	85026		AMS660192	85001	89410	AMS660238	83101		AMS700408	85704	
AMS660150	G63616		AMS660192	89410		AMS660244	83125		AMS700410	85314	89425
AMS660153	85003	89411	AMS660193	83001		AMS660502	646155		AMS700410	89425	
AMS660153	89411		AMS660194	83207	89407	AMS660504	632147		AMS700413	85705	89447
AMS660155	83103		AMS660194	89407		AMS700101	85308	89422	AMS700413	89447	
AMS660157	85030	89440	AMS660195	83130		AMS700101	89422		AMS700414	85723	
AMS660157	89440		AMS660196	G63610		AMS700102	85303	89422	AMS700415	85318	
AMS660160	83114		AMS660197	G63866		AMS700102	89422		AMS700416	85709	
AMS660161	G63610		AMS660198	83007		AMS700103	85302	89420	AMS700418	85003	89411
AMS660162	83103		AMS660200	83008		AMS700103	89420		AMS700418	89411	
AMS660164	83613		AMS660201	83308		AMS700104	85304		AMS700419	85708	
AMS660166	85052		AMS660202	83009		AMS700105	85314	89425	AMS700420	85733	
AMS660167	83128	89436	AMS660203	83112		AMS700105	89425		AMS700421	85712	
AMS660167	89436		AMS660205	83003		AMS700106	85301		AMS700422	85308	89422
AMS660168	83635		AMS660208	G63616		AMS700107	85307		AMS700422	89422	
AMS660169	85051		AMS660211	83110		AMS700108	85315		AMS700423	85724	89443
AMS660170	83016		AMS660212	83015		AMS700111	85320	89429	AMS700423	89443	
AMS660171	83017		AMS660213	85009		AMS700111	89429		AMS700424	85333	
AMS660172	83126	89430	AMS660214	83002		AMS700112	85722		AMS74421	85708	
AMS660172	89430		AMS660215	85059		AMS700113	85736		AMS85722	83400	
AMS660173	85043		AMS660216	83123	89405	AMS700115	85712		AMS85736	G63394	
AMS660174	83125		AMS660216	89405		AMS700116	83136		AMS85768	83209	89414
AMS660175	83120		AMS660218	83137		AMS700120	85332		AMS85768	89414	
AMS660176	83018		AMS660219	83215		AMS700121	83136		AMS85802	83216	
AMS660177	83019		AMS660220	83109		AMS700401	85700		AMS85803	G63306	
AMS660179	83162		AMS660223	85055	89439	AMS700402	85310	89423	AMS85853	G63183	
AMS660182	83004		AMS660223	89439		AMS700402	89423		AMS85895	83207	89407
AMS660183	85012	89413	AMS660224	83111		AMS700403	85702		AMS85895	89407	
AMS660183	89413		AMS660225	89402		AMS700404	85311	89424	AMS85900	G63386	
AMS660187	85071		AMS660232	83114		AMS700404	89424		AMS85901	G63387	
AMS660188	85045		AMS660233	83023		AMS700405	85300	89419	AMS85904	G63299	
AMS660189	83136		AMS660234	83013		AMS700405	89419		AMS85905	G63405	
AMS660190	83107		AMS660236	83025		AMS700406	85711		AMS85960	G63366	
AMS660191	83216		AMS660237	83005		AMS700407	85712				

Fleetwood

Fleetwood	Gabriel	Upgrade	Fleetwood	Gabriel	Upgrade	Fleetwood	Gabriel	Upgrade	Fleetwood	Gabriel	Upgrade
141700131809	85029		24153256	85124		9U9Z-18125-A	83122	89406	ASH-1229	83209	89414
141700131810	83160		481700000490	85900		9U9Z-18125-A	89406		ASH-1229	89414	
16-16736-000	85029		481700000493	85900		9U9Z18124A	83209	89414	ASH-1230	83122	89406
16-16737-000	83160		8C24-18045-DA	G63622		9U9Z18124A	89414		ASH-1230	89406	
16-16873-000	85029		8C24-18080-DB	G63623		9U9Z18125A	83122	89406	ASH-137	83122	89406
16-16874-000	83160		8C2418045DA	G63622		9U9Z18125A	89406		ASH-137	89406	
16-18103-000	85900		8C2418080DB	G63623		ASH-1022	83209	89414	ASH-25820	85005	89430
1616736000	85029		8C2Z-18124-D	G63622		ASH-1022	89414		ASH-25820	89430	
1616737000	83160		8C2Z-18125-D	G63623		ASH-1023	83122	89406	ASH-25821	85006	
1616873000	85029		8C2Z18124D	G63622		ASH-1023	89406		ASH-25822	83209	89414
1616874000	83160		8C2Z18125D	G63623		ASH-1136	G63623		ASH-25822	89414	
1618103000	85900		9U94-18045-AA	83209	89414	ASH-1154	G63622		ASH-25823	83209	89414
1C34-18045-AA	83209	89414	9U94-18045-AA	89414		ASH-1161	85006		ASH-25823	89414	
1C34-18045-AA	89414		9U94-18080-AA	83122	89406	ASH-1162	85005	89430	ASH-25824	83122	89406
1C34-18045-JA	83209	89414	9U94-18080-AA	89406		ASH-1162	89430		ASH-25824	89406	
1C34-18045-JA	89414		9U9418045AA	83209	89414	ASH-1205	83209	89414	ASH-294	83209	89414
1C3418045AA	83209	89414	9U9418045AA	89414		ASH-1205	89414		ASH-294	89414	
1C3418045AA	89414		9U9418080AA	83122	89406	ASH-1206	83122	89406			
1C3418045JA	83209	89414	9U9418080AA	89406		ASH-1206	89406				
1C3418045JA	89414		9U9Z-18124-A	83209	89414	ASH-1228	83209	89414			
24-153256	85124		9U9Z-18124-A	89414		ASH-1228	89414				

Important Note: Competitive Interchanges are to be used for stocking purposes only. Where multiple crosses are identified, please reference the applications section of this catalog. / **Remarque importante:** Les interchanges concurrentiels ne s'utilisent qu'aux fins de stocks. Dans le cas de références multiples, consulter la section des applications du catalogue. / **Nota importante:** Dans le cas de referencias multiples, consultar la sección de aplicaciones del catálogo. / **Nota importante:** Se pueden usar intercambios competitivos para propósitos de almacenamiento solamente. Cuando se identifican intercambios múltiples, consulte la sección de aplicaciones de este catálogo.

COMPETITIVE & O.E.M. INTERCHANGE LIST
Lista de Intercambios contra Competidores y Equipo Original.
Liste dinterchange de produits comptitifs & dquipement original (OEM)

Fleetwood... cont'd

Fleetwood	Gabriel	Upgrade	Fleetwood	Gabriel	Upgrade	Fleetwood	Gabriel	Upgrade	Fleetwood	Gabriel	Upgrade
ASH1022	83209	89414	ASH1228	83209	89414	ASH25823	83209	89414	AT-766	89414	
ASH1022	89414		ASH1228	89414		ASH25823	89414		AT163G	G63622	
ASH1023	83122	89406	ASH1229	83209	89414	ASH25824	83122	89406	AT164G	G63623	
ASH1023	89406		ASH1229	89414		ASH25824	89406		AT620	83209	89414
ASH1136	G63623		ASH1230	83122	89406	ASH294	83209	89414	AT620	89414	
ASH1154	G63622		ASH1230	89406		ASH294	89414		AT621	83122	89406
ASH1161	85006		ASH137	83122	89406	AT-163G	G63622		AT621	89406	
ASH1162	85005	89430	ASH137	89406		AT-164G	G63623		AT766	83209	89414
ASH1162	89430		ASH25820	85005	89430	AT-620	83209	89414	AT766	89414	
ASH1205	83209	89414	ASH25820	89430		AT-620	89414		F4-BE5-F325-HO	85124	
ASH1205	89414		ASH25821	85006		AT-621	83122	89406	F4BE5F325HO	85124	
ASH1206	83122	89406	ASH25822	83209	89414	AT-621	89406		W0005663	85124	
ASH1206	89406		ASH25822	89414		AT-766	83209	89414			

Fluidrive

Fluidrive	Gabriel	Upgrade	Fluidrive	Gabriel	Upgrade	Fluidrive	Gabriel	Upgrade	Fluidrive	Gabriel	Upgrade
2697	85712										

FLXIBLE Bus

Fixible bus	Gabriel	Upgrade	Fixible bus	Gabriel	Upgrade	Fixible bus	Gabriel	Upgrade	Fixible bus	Gabriel	Upgrade
015813	85708		6-367-12	85700		63677	85305		97-9999-02632	85711	
06-0367-00151	85700		6-367-14	85700		63678	85700		97-9999-02633	85311	89424
06-0367-00156	85702		6-367-16	85700		63679	85711		97-9999-02633	89424	
06036700151	85700		6-367-17	85700		680029	85301		97-9999-02634	85733	
06036700156	85702		6-367-2	85736		680155	85712		97-9999-02635	85732	
22012067	85700		6-367-3	85304		690029	85700		97-9999-02636	85716	
22012114	85700		6-367-6	85711		695125	85704		97220100151	85700	
22024061	85704		6-367-7	85305		74412	85704		97221000001	85704	
22025067	85704		6-367-8	85700		87-2520-00001	85704		97221000002	85704	
22025305	85704		6-367-9	85711		87-2520-00003	85704		97221000003	85704	
3166657	85700		6051	85736		87252000001	85704		97221000004	85704	
3192333	85700		60510	85734		87252000003	85704		97221000005	85704	
48-1-239	85736		60513	85304		97-2201-00151	85700		97221000006	85704	
48-1-241	85712		6052	85736		97-2210-00001	85704		97221000009	85704	
481239	85736		6053	85736		97-2210-00002	85704		97221000011	85704	
481241	85712		6054	85736		97-2210-00003	85704		97221000156	85702	
4975518	85704		6055	85307		97-2210-00004	85704		97221000157	85708	
6-05-1	85736		6056	85736		97-2210-00005	85704		97221000160	85705	89447
6-05-10	85734		6057	85736		97-2210-00006	85704		97221000160	89447	
6-05-13	85304		6058	85736		97-2210-00009	85704		97221000164	85708	
6-05-2	85736		6059	85304		97-2210-00011	85704		97221000170	85733	
6-05-3	85736		63671	85711		97-2210-00156	85702		97999900807	85307	
6-05-4	85736		636711	85711		97-2210-00157	85708	89447	97999902514	85700	
6-05-5	85307		636712	85700		97-2210-00160	85705	89447	97999902515	85702	
6-05-6	85736		636714	85700		97-2210-00160	89447		97999902632	85711	
6-05-7	85736		636716	85700		97-2210-00164	85708		97999902633	85311	89424
6-05-8	85736		636717	85700		97-2210-00170	85733		97999902633	89424	
6-05-9	85304		63672	85736		97-9999-00807	85307		97999902634	85733	
6-367-1	85711		63673	85304		97-9999-02514	85700		97999902635	85732	
6-367-11	85711		63676	85711		97-9999-02515	85702		97999902636	85716	

Flyer Industries

Flyer industries	Gabriel	Upgrade	Flyer industries	Gabriel	Upgrade	Flyer industries	Gabriel	Upgrade	Flyer industries	Gabriel	Upgrade
009863	85722		22012067	85700		3192333	85700		592-6568	85700	
015915	85711		22012114	85700		4975501	85700		5926568	85700	
15813	85708		3166657	85700		4975552	85711		5979574	85700	

Ford

Ford	Gabriel	Upgrade	Ford	Gabriel	Upgrade	Ford	Gabriel	Upgrade	Ford	Gabriel	Upgrade
1201-0012	83023		1201-1043	83025		1201-1044	83025		12010012	83023	

Important Note: Competitive Interchanges are to be used for stocking purposes only. Where multiple crosses are identified, please reference the applications section of this catalog. / **Remarque importante:** Les interchanges concurrentiels ne s'utilisent qu'aux fins de stocks. Dans le cas de rfrences multiples, consulter la section des applications du catalogue. / **Nota importante:** Dans le cas de rfrences multiples, consulter la section des applications du catalogue. / **Nota importante:** Se pueden usar intercambios competitivos para propósitos de almacenamiento solamente. Cuando se identifican intercambios múltiples, consulte la sección de aplicaciones de este catálogo.

COMPETITIVE & O.E.M. INTERCHANGE LIST
Lista de Intercambios contra Competidores y Equipo Original.
Liste dinterchange de produits comptitifs & dquipement original (OEM)

Ford... cont'd

Ford	Gabriel	Upgrade	Ford	Gabriel	Upgrade	Ford	Gabriel	Upgrade	Ford	Gabriel	Upgrade
12011043	83025		3U2Z-18124-JAA	G63614		4C4O18045DB	85927		5C3Z-18125-DA	77968	
12011044	83025		3U2Z-18124-MAA	83131		4C4O18045EA	85656		5C3Z18124JA	G63969	
1202-0012	83023		3U2Z-18124-YAA	G63809		4C4O18045GA	83175		5C3Z18125CF	77969	
1202-0032	83016		3U2Z-18125-AD	69575		4C4O18045HA	83135		5C3Z18125DA	77968	
1202-0042	83025		3U2Z-18125-CA	G63607		4C4O18045JA	85928		5L1Z 18125-A	G57016	
1202-1043	83025		3U2Z-18125-DA	G63525		4C4O18045KA	85976		5L2Z 18124-CA	G57018	
1202-1044	83025		3U2Z-18125-EA	G63524		4C4O18045LA	85976		5L2Z 18124-CB	G57019	
12020012	83023		3U2Z-18125-RA	G63623		4C4O18045MA	85656		5L3Z-18125-AA	G63867	
12020032	83016		3U2Z18124BAA	G63809		4C4O18080AA	83101		5U2Z-18V124-AA	G63714	
12020042	83025		3U2Z18124BV	G63614		4C4O18080BA	83317		5U2Z-18V124-AHA	G63622	
12021043	83025		3U2Z18124BW	G63614		4C4Z-18124-AB	83163		5U2Z-18V124-AU	G63772	
12021044	83025		3U2Z18124EA	G63772		4C4Z-18124-BB	83135		5U2Z-18V124-BA	G63716	
1605788	G64063		3U2Z18124FA	G63608		4C4Z-18124-CB	85957		5U2Z-18V124-CAA	G63809	
1C34-18045-AA	83209	89414	3U2Z18124FAA	G63809		4C4Z-18124-DC	85927		5U2Z-18V124-DB	G63455	
1C34-18045-AA	89414		3U2Z18124JAA	G63614		4C4Z-18124-EA	85656		5U2Z-18V124-GA	G63809	
1C34-18045-JA	83209	89414	3U2Z18124MAA	83131		4C4Z-18124-GB	83175		5U2Z-18V124-LA	G63929	
1C34-18045-JA	89414		3U2Z18124YAA	G63809		4C4Z-18124-HB	83135		5U2Z-18V125-AE	G63808	
1C3418045AA	83209	89414	3U2Z18125AD	69575		4C4Z-18124-JB	85928		5U2Z-18V125-AF	G63810	
1C3418045AA	89414		3U2Z18125CA	G63607		4C4Z-18124-KA	85976		5U2Z-18V125-BDA	G63623	
1C3418045JA	83209	89414	3U2Z18125DA	G63525		4C4Z-18124-LA	85976		5U2Z-18V125-BGA	G63778	
1C3418045JA	89414		3U2Z18125EA	G63524		4C4Z-18124-M	85656		5U2Z-18V125-BS	G63607	
1C44-18080-AA	83123	89405	3U2Z18125RA	G63623		4C4Z-18124-P	83135		5U2Z-18V125-BT	G63525	
1C44-18080-AA	89405		47 1700 007 203	85013	89414	4C4Z-18124-QA	83175		5U2Z-18V125-BU	G63524	
1C4418080AA	83123	89405	47 1700 007 203	89414		4C4Z-18124-RA	85928		5U2Z-18V125-F	G63676	
1C4418080AA	89405		471700007117	85010		4C4Z-18125-AB	83101		5U2Z-18V125-G	G63837	
2C44-18045-BA	83175		471700009775	85010		4C4Z-18125-B	83317		5U2Z-18V125-VG	69845	
2C4418045BA	83175		471700011530	85181		4C4Z-18125-CA	85976		5U2Z-3V651-C	6828SE	
2C4Z-18124-BA	83175		471700011531	85180		4C4Z-18125-DA	85656		5U2Z18V124AA	G63714	
2C4Z18124BA	83175		47902-13	83122	89406	4C4Z18124AB	83163		5U2Z18V124AHA	G63622	
2C7Z-18125-AA	G63837		47902-13	89406		4C4Z18124BB	83135		5U2Z18V124AU	G63772	
2C7Z-18125-CA	G63607		47902-28	85013	89414	4C4Z18124CB	85957		5U2Z18V124BA	G63716	
2C7Z18125AA	G63837		47902-28	89414		4C4Z18124DC	85927		5U2Z18V124CAA	G63809	
2C7Z18125CA	G63607		47902-8	83122	89406	4C4Z18124EA	85656		5U2Z18V124DB	G63455	
2F2Z 18124-AA	G56935		47902-8	89406		4C4Z18124GB	83175		5U2Z18V124GA	G63809	
2L1Z 18124-AD	G57015		4790213	83122	89406	4C4Z18124HB	83135		5U2Z18V124LA	G63929	
2L7Z 18125-AA	G57016		4790213	89406		4C4Z18124JB	85928		5U2Z18V125AE	G63808	
3199942	89402		4790228	85013	89414	4C4Z18124KA	85976		5U2Z18V125AF	G63810	
3553628C1	85927		4790228	89414		4C4Z18124LA	85976		5U2Z18V125BDA	G63623	
3553628C2	85927		479028	83122	89406	4C4Z18124M	85656		5U2Z18V125BGA	G63778	
3578858C1	85656		479028	89406		4C4Z18124P	83135		5U2Z18V125BS	G63607	
3578858C2	85656		4C4O-18045-AA	83163		4C4Z18124QA	83175		5U2Z18V125BT	G63525	
3584116C1	83175		4C4O-18045-BB	83135		4C4Z18124RA	85928		5U2Z18V125BU	G63524	
3584116C2	83175		4C4O-18045-CA	85957		4C4Z18125AB	83101		5U2Z18V125F	G63676	
3584117C2	83135		4C4O-18045-DB	85927		4C4Z18125B	83317		5U2Z18V125G	G63837	
3584118C2	85928		4C4O-18045-EA	85656		4C4Z18125CA	85976		60670-008	83123	89405
3919942	89402		4C4O-18045-GA	83175		4C4Z18125DA	85656		60670-008	89405	
3L2Z 18124-CA	G57017		4C4O-18045-HA	83135		4U2Z-18V124-AA	G63678		60670-008L	83123	89405
3U2Z 18124-BJ	G57080		4C4O-18045-JA	85928		4U2Z18V124AA	G63678		60670-008L	89405	
3U2Z 18124-BK	G57080		4C4O-18045-KA	85976		501906C91	83317		60670-011	83148	
3U2Z 18124-PAA	G57017		4C4O-18045-LA	85976		501906C92	83317		60670-012	83168	
3U2Z-18124-BAA	G63809		4C4O-18045-MA	85656		57241-2	83109		60670008	83123	89405
3U2Z-18124-BV	G63614		4C4O-18080-AA	83101		572412	83109		60670008	89405	
3U2Z-18124-BW	G63614		4C4O-18080-BA	83317		57365-111	85006		60670008L	83123	89405
3U2Z-18124-EA	G63772		4C4O18045AA	83163		57365111	85006		60670008L	89405	
3U2Z-18124-FA	G63608		4C4O18045BB	83135		5C3Z-18124-JA	G63969		60670011	83148	
3U2Z-18124-FAA	G63809		4C4O18045CA	85957		5C3Z-18125-CF	77969		60670012	83168	

Important Note: Competitive Interchanges are to be used for stocking purposes only. Where multiple crosses are identified, please reference the applications section of this catalog. / **Remarque importante:** Les interchanges concurrentiels ne s'utilisent qu'aux fins de stocks. Dans le cas de rferences multiples, consulter la section des applications du catalogue. / **Nota importante:** Dans le cas de rferences multiples, consulter la section des applications du catalogue. / **Nota importante:** Se pueden usar intercambios competitivos para propósitos de almacenamiento solamente. Cuando se identifican intercambios múltiples, consulte la sección de aplicaciones de este catálogo.

COMPETITIVE & O.E.M. INTERCHANGE LIST
Lista de Intercambios contra Competidores y Equipo Original.
Liste dinterchange de produits comptitifs & dquipement original (OEM)

Ford... cont'd

Ford	Gabriel	Upgrade	Ford	Gabriel	Upgrade	Ford	Gabriel	Upgrade	Ford	Gabriel	Upgrade
60675-003	85976		8A8Z 18125-E	G51996		9U9Z18124A	83209	89414	AL3Z 18125-L	G64079	
60675-003L	85976		8C24-18045-DA	G63622		9U9Z18124A	89414		AL3Z-18124-AA	G51865	
60675-014	85978		8C24-18080-DB	G63623		9U9Z18124B	83209	89414	AL3Z-18125-D	G64157	
60675003	85976		8C2418045DA	G63622		9U9Z18124B	89414		ALK3Z 18124-GA	G57103	
60675003L	85976		8C2418045DA	G63625		9U9Z18125A	83122	89406	ASH-1022	83209	89414
60675014	85978		8C2418080DB	G63623		9U9Z18125A	89406		ASH-1022	89414	
680029	85301		8C2Z 18124-B	G63622		9U9Z18125B	83122	89406	ASH-1023	83122	89406
6C2Z-18124-A	G63622		8C2Z 18124-C	G63622		9U9Z18125B	89406		ASH-1023	89406	
6C2Z-18124-B	G63929		8C2Z 18125-D	G63623		AA-494	83131		ASH-1105	85976	
6C2Z18124B	G63929		8C2Z-18124-A	G63622		AA-615	83135		ASH-1136	G63623	
6E5Z 18124-BL	G51859		8C2Z-18124-D	G63622		AA-616	83175		ASH-1154	G63622	
6E5Z-18124-BR	G51859		8C2Z-18125-A	G63623		AA-617	85928		ASH-1161	85006	
6E5Z-18125-BA	69591		8C2Z-18125-B	G63623		AA-619	85927		ASH-1162	85005	89430
6E7O-18B038-AA	83364		8C2Z-18125-C	G63623		AA-620	83101		ASH-1162	89430	
6E7O18B038AA	83364		8C2Z-18125-D	G63623		AA494	83131		ASH-1205	83209	89414
6E7Z-18124-AB	83364		8C2Z18124D	G63622		AA615	83135		ASH-1205	89414	
6E7Z18124AB	83364		8C2Z18124D	G63624		AA616	83175		ASH-1206	83122	89406
6ETZ-18125-A	83364		8C2Z18125A	G63623		AA617	85928		ASH-1206	89406	
6ETZ18125A	83364		8C2Z18125B	G63623		AA619	85927		ASH-12251	85013	89414
6L1Z 18124-DD	G57015		8C2Z18125C	G63623		AA620	83101		ASH-12251	89414	
6L1Z 18125-AA	G57016		8C2Z18125D	G63623		AE5Z 18124-A	G57427		ASH-12261	85010	
6L1Z 18125-AB	G57016		8C3Z-3E651-E	14072		AE5Z 18124-B	G57427		ASH-1228	83209	89414
6L7Z 18124-BC	G57015		8L1Z 18125-B	G57173		AE5Z 18124-C	G57427		ASH-1228	89414	
6U2Z-18V125-A	G63837		8L1Z 18125-C	G57173		AE5Z 18124-D	G57427		ASH-1229	83209	89414
6U2Z-18V125-B	G63607		8L1Z 18125-H	G57173		AE5Z 18124-E	G57427		ASH-1229	89414	
6U2Z18V125A	G63837		8L1Z 18125-J	G57173		AE5Z 18124-F	G57427		ASH-1230	83122	89406
6U2Z18V125B	G63607		90044769	83207	89407	AE5Z 18124-J	G57427		ASH-1230	89406	
70127	85006		90044769	89407		AE5Z 18124-K	G57427		ASH-137	83122	89406
70128	85006		90044770	83207	89407	AE5Z 18125-A	69591		ASH-137	89406	
7C2Z-18125-D	G63623		90044770	89407		AE5Z 18125-B	69591		ASH-23486	G63461	
7C34-18045-HB	G63969		90045099	85906	89407	AE5Z 18125-C	69591		ASH-23488	G63461	
7C34-18080-DCB	77968		90045099	89407		AE5Z 18125-G	69591		ASH-24446	83215	
7C3418045HB	G63969		90045132	85906	89407	AG1Z 18124-A	G57498		ASH-2447	83140	
7C3418080DCB	77968		90045132	85909		AG1Z 18124-B	G57497		ASH-24473	85013	89414
7C3Z 18124-NCA	G63886		90045132	89407		AG1Z 18124-C	G57498		ASH-24473	89414	
7C3Z 18124-NDA	G63886		9C3Z 18124-A	G63886		AG1Z 18124-D	G57497		ASH-24474	85010	
7C3Z 18124-NEA	G63886		9C3Z 18125-A	G63888		AG1Z 18124-E	G57498		ASH-24522	85013	89414
7C3Z 18124-PBA	G63886		9L8Z 18124-AL	G56601		AG1Z 18124-F	G57497		ASH-24522	89414	
7C3Z 18124-PCA	G63886		9L8Z 18124-AR	G56568		AG1Z 18124-G	G57497		ASH-24523	85010	
7C3Z 18125-JCA	G63888		9L8Z 18124-BL	G56601		AG1Z 18124-H	G57498		ASH-24589	85010	
7C3Z 18125-JEA	G63888		9L8Z 18124-BR	G56568		AH6Z 18124-D	G51896		ASH-24634	85013	89414
7C3Z 18125-KBA	G63888		9R3Z 18124-G	G57271		AH6Z-18124-C	G51897		ASH-24634	89414	
7C3Z 18125-KCA	G63888		9U94-18045-AA	83209	89414	AL1Z 18124-D	G51860		ASH-24658	85181	
7C3Z 18125-KDA	G63888		9U94-18045-AA	89414		AL1Z 18125-A	G57173		ASH-24659	85181	
7C3Z-18124-NJA	G63886		9U94-18080-AA	83122	89406	AL1Z 18125-D	G51861		ASH-24660	85180	
7C3Z-18125-CXA	G64010		9U94-18080-AA	89406		AL1Z 18125-F	G51861		ASH-24661	83317	
7E5Z 18124-LH	G57148		9U9418045AA	83209	89414	AL3Z 18124-BA	G51865		ASH-24662	83168	
7E5Z 18124-RH	G57148		9U9418045AA	89414		AL3Z 18124-DA	G57103		ASH-24663	83148	
7L2Z 18124-AC	G57095		9U9418080AA	83122	89406	AL3Z 18124-EA	G57103		ASH-247	G63461	
7L2Z 18124-BB	G57095		9U9418080AA	89406		AL3Z 18124-GA	G51864		ASH-25770	77987	
7L5Z-18124-A	G63772		9U9Z-18124-A	83209	89414	AL3Z 18124-RB	G51865		ASH-25820	85005	89430
7W7Z-18125-B	69574		9U9Z-18124-A	89414		AL3Z 18124-SB	G57103		ASH-25820	89430	
7W7Z18125B	69574		9U9Z-18125-A	83122	89406	AL3Z 18125-E	G64157		ASH-25821	85006	
87HU-18045-AA	85301		9U9Z-18125-A	89406		AL3Z 18125-G	G64079		ASH-25822	83209	89414
87HU18045AA	85301		9U9Z-18125-B	83122	89406	AL3Z 18125-H	G64079		ASH-25822	89414	
8A4Z 18183-C	143415		9U9Z-18125-B	89406		AL3Z 18125-K	G64157		ASH-25823	83209	89414

Important Note: Competitive Interchanges are to be used for stocking purposes only. Where multiple crosses are identified, please reference the applications section of this catalog. / **Remarque importante:** Les interchanges concurrentiels ne s'utilisent qu'aux fins de stocks. Dans le cas de rfrences multiples, consulter la section des applications du catalogue. / **Nota importante:** Dans le cas de rfrences multiples, consulter la section des applications du catalogue. / **Nota importante:** Se pueden usar intercambios competitivos para propósitos de almacenamiento solamente. Cuando se identifican intercambios múltiples, consulte la sección de aplicaciones de este catálogo.

COMPETITIVE & O.E.M. INTERCHANGE LIST
Lista de Intercambios contra Competidores y Equipo Original.
Liste dinterchange de produits comptitifs & dquipement original (OEM)

Ford... cont'd

Ford	Gabriel	Upgrade	Ford	Gabriel	Upgrade	Ford	Gabriel	Upgrade	Ford	Gabriel	Upgrade
ASH-25823	89414		ASH24663	83148		AX-310	83215		BC3Z-18125-AJ	G63888	
ASH-25824	83122	89406	ASH247	G63461		AX267A	83309		BC3Z-18125-AN	G64010	
ASH-25824	89406		ASH25820	85005	89430	AX310	83215		BC3Z-18125-AP	77969	
ASH-25838	85978		ASH25820	89430		AX85A	83219		BC3Z-18125-AQ	77969	
ASH-294	83209	89414	ASH25821	85006		B3Q-18124-A	83219		BC3Z-18125-F	61682	
ASH-294	89414		ASH25822	83209	89414	B3Q18124A	83219		BC3Z-18125-V	G63888	
ASH-397	83131		ASH25822	89414		B6TZ-18124-A	83219		BE8Z 18124-A	G52256	
ASH-722	85976		ASH25823	83209	89414	B6TZ18124A	83219		BE8Z 18124-B	G52255	
ASH-85789	77986		ASH25823	89414		B7T-18124-C	83225		BE8Z 18124-C	G52256	
ASH-85856	77987		ASH25824	83122	89406	B7T18124C	83225		BE8Z 18124-D	G52255	
ASH-85857	77987		ASH25824	89406		B7TZ-18124-B	83216		BE8Z 18125-A	70052	
ASH-85927	77986		ASH25838	85978		B7TZ-18124-C	83216		BE8Z 18125-B	70052	
ASH-866127	77986		ASH294	83209	89414	B7TZ-18124-D	83219		BK3Z-18124-A	G57816	
ASH-866139	77986		ASH294	89414		B7TZ18124B	83216		BL3Z 18124-C	G51865	
ASH1022	83209	89414	ASH397	83131		B7TZ18124C	83216		BL3Z 18124-F	G57103	
ASH1022	89414		ASH722	85976		B7TZ18124D	83219		BL3Z 18125-C	G64157	
ASH1023	83122	89406	AT-163G	G63622		B8Q-18125-A	85307		BL3Z 18125-F	G64079	
ASH1023	89406		AT-164G	G63623		B8Q18125A	85307		BT4Z 18124-C	G52351	
ASH1105	85976		AT-504G	G63679		B8QZ-18124-A	83312	89409	BT4Z 18124-D	G52352	
ASH1136	G63623		AT-610	G63461		B8QZ-18124-A	89409		BT4Z 18124-E	G52352	
ASH1154	G63622		AT-611	G63461		B8QZ18124A	83312	89409	BT4Z 18124-EC	G52351	
ASH1161	85006		AT-620	83209	89414	B8QZ18124A	89409		BU2Z-18V124-E	83107	
ASH1162	85005	89430	AT-620	89414		B8TZ-18124-A	83219		BU2Z-18V125-F	G64010	
ASH1162	89430		AT-621	83122	89406	B8TZ18124A	83219		BU2Z18V124E	83107	
ASH1205	83209	89414	AT-621	89406		B9TT-18045-C	83219		BU2Z18V125P	G63778	
ASH1205	89414		AT-696	83140		B9TT-18045-D	83219		BU9Z-18124-A	85013	89414
ASH1206	83122	89406	AT-766	83209	89414	B9TT18045C	83219		BU9Z-18124-A	89414	
ASH1206	89406		AT-766	89414		B9TT18045D	83219		BU9Z-18125-A	85010	
ASH12251	85013	89414	AT-811	83135		BC3Z 18124-AA	G63886		BU9Z18124A	85013	89414
ASH12251	89414		AT-812	85928		BC3Z 18124-B	G63622		BU9Z18124A	89414	
ASH12261	85010		AT163G	G63622		BC3Z 18124-C	G63622		BU9Z18125A	85010	
ASH1228	83209	89414	AT163G	G63623		BC3Z 18124-K	G63886		BV6Z 18125-B	G511002	
ASH1228	89414		AT164G	G63623		BC3Z 18124-M	G63886		BV6Z 18125-C	G511002	
ASH1229	83209	89414	AT504G	G63679		BC3Z 18124-N	G63886		BV6Z 18125-D	G511002	
ASH1229	89414		AT610	G63461		BC3Z 18124-R	G63886		BV6Z 18125-E	G511002	
ASH1230	83122	89406	AT611	G63461		BC3Z 18124-T	G63886		BV6Z 18125-F	G511002	
ASH1230	89406		AT620	83209	89414	BC3Z 18124-U	G63886		BV6Z 18125-G	G511002	
ASH137	83122	89406	AT620	89414		BC3Z 18124-X	G63886		C0TT-18045-A	83219	
ASH137	89406		AT621	83122	89406	BC3Z 18124-Y	G63886		C0TT-18045-D	83216	
ASH23486	G63461		AT621	89406		BC3Z 18124-Z	G63886		C0TT18045A	83219	
ASH23488	G63461		AT696	83140		BC3Z 18125-A	G64010		C0TT18045D	83216	
ASH24446	83215		AT766	83209	89414	BC3Z 18125-AE	G63888		C0TZ-18124-A	83216	
ASH2447	83140		AT766	89414		BC3Z 18125-AF	G63888		C0TZ18124A	83216	
ASH24473	85013	89414	AT811	83135		BC3Z 18125-AL	G63888		C1BZ 18124-B	G52255	
ASH24473	89414		AT812	85928		BC3Z 18125-B	G64010		C1BZ 18124-E	G52256	
ASH24474	85010		AU2Z 18124-H	G57015		BC3Z 18125-J	G63888		C1TT-18045-C	83312	89409
ASH24522	85013	89414	AU2Z 18125-E	G57016		BC3Z 18125-L	G63888		C1TT-18045-C	89409	
ASH24522	89414		AU2Z-18V124-AC	G63886		BC3Z 18125-M	G63888		C1TT-18045-E	83314	
ASH24589	85010		AU2Z-18V124-AU	G63622		BC3Z 18125-N	G63888		C1TT-18045-G	83216	
ASH24634	85013	89414	AU2Z-18V124-AY	G63714		BC3Z 18125-R	G63888		C1TT18045C	83312	89409
ASH24634	89414		AU2Z-18V124-BB	G63714		BC3Z-18124-A	G63622		C1TT18045C	89409	
ASH24658	85181		AU2Z-18V124-BH	G63716		BC3Z-18124-AB	G63886		C1TT18045E	83314	
ASH24659	85181		AU2Z-18V124-J	G63886		BC3Z-18124-AC	77967		C1TT18045G	83216	
ASH24660	85180		AU2Z-18V125-BD	G63715		BC3Z-18124-F	G63886		C1TZ-18045-C	83312	89409
ASH24661	83317		AU2Z-18V125-S	G63888		BC3Z-18124-G	G63886		C1TZ-18045-C	89409	
ASH24662	83168		AX-267A	83309		BC3Z-18125-AA	G64010		C1TZ-18124-B	83216	

Important Note: Competitive Interchanges are to be used for stocking purposes only. Where multiple crosses are identified, please reference the applications section of this catalog. / **Remarque importante:** Les interchanges concurrentiels ne s'utilisent qu'aux fins de stocks. Dans le cas de rferences multiples, consulter la section des applications du catalogue. / **Nota importante:** Dans le cas de rferences multiples, consulter la section des applications du catalogue. / **Nota importante:** Se pueden usar intercambios competitivos para propósitos de almacenamiento solamente. Cuando se identifican intercambios múltiples, consulte la sección de aplicaciones de este catálogo.

COMPETITIVE & O.E.M. INTERCHANGE LIST
Lista de Intercambios contra Competidores y Equipo Original.
Liste dinterchange de produits comptitifs & dquipement original (OEM)

Ford... cont'd

Ford	Gabriel	Upgrade	Ford	Gabriel	Upgrade	Ford	Gabriel	Upgrade	Ford	Gabriel	Upgrade
C1TZ-18124-C	83312	89409	C4TZ18124B	83308		CG1Z 18125-D	70096		D2HA-18045-F1A	85301	
C1TZ-18124-C	89409		C5TZ-18124-A	83308		CK4Z-18124-E	G57816		D2HA-18045-F1B	85301	
C1TZ-18124-D	83309		C5TZ18124A	83308		CL3Z 18124-B	G57103		D2HA-18045-F2A	85301	
C1TZ-18124-E	83312	89409	C6PF-18077-A	G63306		CL8Z 18125-A	G64047		D2HA-18045-F2B	85301	
C1TZ-18124-E	89409		C6PF-18077-DD	83216		CL8Z 18125-B	G64047		D2HA18045E1A	85304	
C1TZ-18124-F	83312	89409	C6PF-18077-DE	83219		CL8Z 18125-C	G64047		D2HA18045E1B	85304	
C1TZ-18124-F	89409		C6PF-18077-DL	83312	89409	CT4Z 18124-A	G52351		D2HA18045E2A	85304	
C1TZ-18124-N	83314		C6PF-18077-DL	89409		CT4Z 18124-B	G52352		D2HA18045E2B	85304	
C1TZ-18124-P	83312	89409	C6PF-18077-DN	83314		CT4Z 18125-A	G64111		D2HA18045EB	85301	
C1TZ-18124-P	89409		C6PF-18077-F	83225		CU9Z-18124-A	85013	89414	D2HA18045F1A	85301	
C1TZ18045C	83312	89409	C6PF18077A	G63306		CU9Z-18124-A	89414		D2HA18045F1B	85301	
C1TZ18045C	89409		C6PF18077DD	83216		CU9Z-18125-A	85010		D2HA18045F2A	85301	
C1TZ18124B	83216		C6PF18077DE	83219		CU9Z18124A	85013	89414	D2HA18045F2B	85301	
C1TZ18124C	83312	89409	C6PF18077DL	83312	89409	CU9Z18124A	89414		D2HF-18045-A	83314	
C1TZ18124C	89409		C6PF18077DL	89409		CU9Z18125A	85010		D2HF-18045-AA	83314	
C1TZ18124D	83309		C6PF18077DN	83314		CV6Z 18125-P	G511001		D2HF-18045-BA	83309	
C1TZ18124E	83312	89409	C6PF18077F	83225		CV6Z 18125-Q	G511001		D2HF-18045-CA	83308	
C1TZ18124E	89409		C6TA-18045-U	85301		D0HA-18045-D	83309		D2HF-18045-DA	83312	89409
C1TZ18124F	83312	89409	C6TA-18045-V	85301		D0HA-18045-E	83312	89409	D2HF-18045-DA	89409	
C1TZ18124F	89409		C6TA-18045-Y	85301		D0HA-18045-E	89409		D2HF-18124-AA	83314	
C1TZ18124N	83314		C6TA-18045-Z	85301		D0HA18045D	83309		D2HF18045A	83314	
C1TZ18124P	83312	89409	C6TA18045U	85301		D0HA18045E	83312	89409	D2HF18045AA	83314	
C1TZ18124P	89409		C6TA18045V	85301		D0HA18045E	89409		D2HF18045BA	83309	
C2TA-18045-A	83216		C6TA18045Y	85301		D0HZ-18124-A	83309		D2HF18045CA	83308	
C2TA-18045-B	83308		C6TA18045Z	85301		D0HZ-18124-B	83312	89409	D2HF18045DA	83312	89409
C2TA18045A	83216		C6TZ-18124-D	85301		D0HZ-18124-B	89409		D2HF18045DA	89409	
C2TA18045B	83308		C6TZ-18124-E	85301		D0HZ-18124-C	83314		D2HF18124AA	83314	
C2TZ-18124-A	83308		C6TZ-18124-H	85301		D0HZ18124A	83309		D2HT-18045-CA	83314	
C2TZ18124A	83308		C6TZ-18124-J	85301		D0HZ18124B	83312	89409	D2HT-18045-EA	83312	89409
C3TA-18045-A	83216		C6TZ18124D	85301		D0HZ18124B	89409		D2HT-18045-EA	89409	
C3TA18045A	83216		C6TZ18124E	85301		D0HZ18124C	83314		D2HT-18045-GA	83308	
C3TZ-18124-A	83308		C6TZ18124H	85301		D1TF-18045-LA	83312	89409	D2HT-18080-HA	83225	
C3TZ18124A	83308		C6TZ18124J	85301		D1TF-18045-LA	89409		D2HT18045CA	83314	
C4HZ-18124-A	83312	89409	C7HZ-18124-A	83312	89409	D1TF18045LA	83312	89409	D2HT18045EA	83312	89409
C4HZ-18124-A	89409		C7HZ-18124-A	89409		D1TF18045LA	89409		D2HT18045EA	89409	
C4HZ-18124-B	83309		C7HZ18124A	83312	89409	D1TZ-18124-D	83308		D2HT18045GA	83308	
C4HZ-18124-C	83314		C7HZ18124A	89409		D1TZ-18124-E	83216		D2HT18080HA	83225	
C4HZ-18124-D	83312	89409	C7PF-18077-A	83225		D1TZ-18124-F	83312	89409	D2HZ-18080-A	83209	89414
C4HZ-18124-D	89409		C7PF18077A	83225		D1TZ-18124-F	89409		D2HZ-18080-A	89414	
C4HZ-18124-E	83309		C7TA-18045-R	83216		D1TZ18124D	83308		D2HZ-18125-A	83209	89414
C4HZ-18124-F	83308		C7TA-18045-Z	85301		D1TZ18124E	83216		D2HZ-18125-A	89414	
C4HZ18124A	83312	89409	C7TA18045R	83216		D1TZ18124F	83312	89409	D2HZ-18125-B	83209	89414
C4HZ18124A	89409		C7TA18045Z	85301		D1TZ18124F	89409		D2HZ-18125-B	89414	
C4HZ18124B	83309		C8HA-18045-A	83312	89409	D2EF-18045-AA	83312	89409	D2HZ18080A	83209	89414
C4HZ18124C	83314		C8HA-18045-A	89409		D2EF-18045-AA	89409		D2HZ18080A	89414	
C4HZ18124D	83312	89409	C8HA18045A	83312	89409	D2EF-18124-AA	83312	89409	D2HZ18125A	83209	89414
C4HZ18124D	89409		C8HA18045A	89409		D2EF-18124-AA	89409		D2HZ18125A	89414	
C4HZ18124E	83309		C8PF-18045-CM	83216		D2EF18045AA	83312	89409	D2HZ18125B	83209	89414
C4HZ18124F	83308		C8PF18045CM	83216		D2EF18045AA	89409		D2HZ18125B	89414	
C4PF-18045-H	83216		C8TA-18045-AA	G63386		D2EF18124AA	83312	89409	D2KF-18045-AA	83312	89409
C4PF18045H	83216		C8TA18045AA	G63386		D2EF18124AA	89409		D2KF-18045-AA	89409	
C4TZ-18124-AA	83308		CA8Z 18125-A	G51996		D2HA-18045-E1A	85304		D2KF-18124-AA	83312	89409
C4TZ-18124-AB	83308		CA8Z 18125-B	G51996		D2HA-18045-E1B	85304		D2KF-18124-AA	89409	
C4TZ-18124-B	83308		CG1Z 18125-A	70096		D2HA-18045-E2A	85304		D2KF18045AA	83312	89409
C4TZ18124AA	83308		CG1Z 18125-B	70096		D2HA-18045-E2B	85304		D2KF18045AA	89409	
C4TZ18124AB	83308		CG1Z 18125-C	70096		D2HA-18045-EB	85301		D2KF18124AA	83312	89409

Important Note: Competitive Interchanges are to be used for stocking purposes only. Where multiple crosses are identified, please reference the applications section of this catalog. / **Remarque importante:** Les interchanges concurrentiels ne s'utilisent qu'aux fins de stocks. Dans le cas de références multiples, consulter la section des applications du catalogue. / **Nota importante:** En el caso de referencias múltiples, consultar la sección de aplicaciones del catálogo. / **Nota importante:** Se pueden usar intercambios competitivos para propósitos de almacenamiento solamente. Cuando se identifican intercambios múltiples, consulte la sección de aplicaciones de este catálogo.

COMPETITIVE & O.E.M. INTERCHANGE LIST
Lista de Intercambios contra Competidores y Equipo Original.
Liste dinterchange de produits comptitifs & dquipement original (OEM)

Ford... cont'd

Ford	Gabriel	Upgrade	Ford	Gabriel	Upgrade	Ford	Gabriel	Upgrade	Ford	Gabriel	Upgrade
D2KF18124AA	89409		D5TZ18124B	83308		D7HT18124BA	89409		DU9418080CA	85010	
D2TA-18045-AAA	83219		D5TZ18124C	83312	89409	D7HT18124CA	83314		DU9418080CB	85010	
D2TA-18045-ZA	83219		D5TZ18124C	89409		D7HT18124DA	83309		DU9Z-18124-A	85013	89414
D2TA18045AAA	83219		D7HA-18080-AA	83123	89405	D7HT18124EA	83312	89409	DU9Z-18124-A	89414	
D2TA18045ZA	83219		D7HA-18080-AA	89405		D7HT18124EA	89409		DU9Z-18124-B	85013	89414
D2TF-18045-AA	83312	89409	D7HA18080AA	83123	89405	D7HT18124FA	83312	89409	DU9Z-18124-B	89414	
D2TF-18045-AA	89409		D7HA18080AA	89405		D7HT18124FA	89409		DU9Z-18125-A	85010	
D2TF-18045-FA	83312	89409	D7HF-18045-FA	83312	89409	D7HT18124GA	83308		DU9Z-18125-B	85010	
D2TF-18045-FA	89409		D7HF-18045-FA	89409		D7HT18124HA	83219		DU9Z18124A	85013	89414
D2TF-18045-GA	83308		D7HF-18080-AA	83215		D7HT18124JA	83308		DU9Z18124A	89414	
D2TF-18080-HA	83225		D7HF-18125-AA	83215		D7HT18124KA	85301		DU9Z18124B	85013	89414
D2TF-18124-F	83309		D7HF18045FA	83312	89409	D7HT18125DA	83215		DU9Z18124B	89414	
D2TF18045AA	83312	89409	D7HF18045FA	89409		D7HT18125FA	83123	89405	DU9Z18125A	85010	
D2TF18045AA	89409		D7HF18080AA	83215		D7HT18125FA	89405		DU9Z18125B	85010	
D2TF18045FA	83312	89409	D7HF18125AA	83215		D7HZ-18125-A	83215		E0HT-18045-AA	83309	
D2TF18045FA	89409		D7HT-18045-BA	83312	89409	D7HZ18125A	83215		E0HT-18045-AB	83309	
D2TF18045GA	83308		D7HT-18045-BA	89409		D7KF-18045-EA	83312	89409	E0HT18045AA	83309	
D2TF18080HA	83225		D7HT-18045-CA	83314		D7KF-18045-EA	89409		E0HT18045AB	83309	
D2TF18124F	83309		D7HT-18045-DA	83309		D7KF18045EA	83312	89409	E0HZ-18124-A	83309	
D2TZ-18124-A	83308		D7HT-18045-EA	83312	89409	D7KF18045EA	89409		E0HZ18124A	83309	
D2TZ-18124-E	83312	89409	D7HT-18045-EA	89409		D7TA-18124-GA	83314		E1TA-18045-AA	83309	
D2TZ-18124-E	89409		D7HT-18045-GA	83308		D7TA18124GA	83314		E1TA18045AA	83309	
D2TZ-18124-F	83309		D7HT-18045-HA	85012	89413	D8HZ-18124-A	85301		E1TD-18045-AA	83309	
D2TZ-18124-G	83314		D7HT-18045-HA	89413		D8HZ-18125-A	83209	89414	E1TD18045AA	83309	
D2TZ-18124-H	83308		D7HT-18045-JA	83308		D8HZ-18125-A	89414		E5HT-18045-AA	85301	
D2TZ-18124-J	83312	89409	D7HT-18045-NA	85301		D8HZ-18125-B	83123	89405	E5HT-18045-DA	85301	
D2TZ-18124-J	89409		D7HT-18080-BA	83225		D8HZ-18125-B	89405		E5HT-18045-EA	85301	
D2TZ18124A	83308		D7HT-18080-CA	83225		D8HZ18124A	85301		E5HT-18080-DA	85315	
D2TZ18124E	83312	89409	D7HT-18080-DA	83215		D8HZ18125A	83209	89414	E5HT-18080-EA	85315	
D2TZ18124E	89409		D7HT-18124-BA	83312	89409	D8HZ18125A	89414		E5HT18045AA	85301	
D2TZ18124F	83309		D7HT-18124-BA	89409		D8HZ18125B	83123	89405	E5HT18045DA	85301	
D2TZ18124G	83314		D7HT-18124-CA	83314		D8HZ18125B	89405		E5HT18045EA	85301	
D2TZ18124H	83308		D7HT-18124-DA	83309		DA8Z 18125-A	G51996		E5HT18080DA	85315	
D2TZ18124J	83312	89409	D7HT-18124-EA	83312	89409	DA8Z 18125-B	G51996		E5HT18080EA	85315	
D2TZ18124J	89409		D7HT-18124-EA	89409		DB5Z 18125-E	G51980		E6HT-18080-AA	83215	
D3TA-18045-BA	83219		D7HT-18124-FA	83312	89409	DB5Z 18125-F	G51980		E6HT18080AA	83215	
D3TA18045BA	83219		D7HT-18124-FA	89409		DB5Z 18125-H	G51980		E6HZ-18124-A	85301	
D3TZ-18124-B	83219		D7HT-18124-GA	83308		DB5Z-18125-G	G51980		E6HZ-18124-D	85301	
D3TZ18124B	83219		D7HT-18124-HA	83219		DG1Z 18124-AA	G57812		E6HZ-18125-D	83215	
D4HA-18080-A	83209	89414	D7HT-18124-JA	83308		DG1Z 18125-A	70096		E6HZ-18125-E	85315	
D4HA-18080-A	89414		D7HT-18124-KA	85301		DG1Z 18125-F	70096		E6HZ-18125-F	85315	
D4HA-18080-AA	83209	89414	D7HT-18125-DA	83215		DG9Z 18124-AB	G57812		E6HZ18124A	85301	
D4HA-18080-AA	89414		D7HT-18125-FA	83123	89405	DG9Z 18124-P	G57812		E6HZ18124D	85301	
D4HA18080A	83209	89414	D7HT-18125-FA	89405		DG9Z 18124-Q	G57812		E6HZ18125D	83215	
D4HA18080A	89414		D7HT18045BA	83312	89409	DG9Z 18124-T	G57812		E6HZ18125E	85315	
D4HA18080AA	83209	89414	D7HT18045BA	89409		DG9Z 18124-Y	G57812		E6HZ18125F	85315	
D4HA18080AA	89414		D7HT18045CA	83314		DG9Z 18124-Z	G57812		E7HZ-18124-A	85301	
D4TF-18045-AA	83312	89409	D7HT18045DA	83309		DG9Z 18125-K	G51965		E7HZ18124A	85301	
D4TF-18045-AA	89409		D7HT18045EA	83312	89409	DG9Z 18125-Q	G51965		E7XZ-18124-A	G63386	
D4TF18045AA	83312	89409	D7HT18045EA	89409		DG9Z 18125-S	G51965		E7XZ-18124-C	G63511	
D4TF18045AA	89409		D7HT18045GA	83308		DG9Z 18125-T	G51965		E7XZ-18125-A	G63350	
D4TZ-18124-J	83308		D7HT18045JA	83308		DG9Z-18125-U	G51965		E7XZ-18125-B	G63387	
D4TZ18124J	83308		D7HT18045NA	85301		DU94-18045-CB	85013	89414	E7XZ-18125-C	G63409	
D5TZ-18124-B	83308		D7HT18080BA	83225		DU94-18045-CB	89414		E7XZ-18125-J	G63299	
D5TZ-18124-C	83312	89409	D7HT18080DA	83215		DU94-18080-CA	85010		E7XZ18124A	G63386	
D5TZ-18124-C	89409		D7HT18124BA	83312	89409	DU94-18080-CB	85010		E7XZ18124C	G63511	

Important Note: Competitive Interchanges are to be used for stocking purposes only. Where multiple crosses are identified, please reference the applications section of this catalog. / **Remarque importante:** Les interchanges concurrentiels ne s'utilisent qu'aux fins de stocks. Dans le cas de rferences multiples, consulter la section des applications du catalogue. / **Nota importante:** Dans le cas de rferences multiples, consulter la section des applications du catalogue. / **Nota importante:** Se pueden usar intercambios competitivos para propósitos de almacenamiento solamente. Cuando se identifican intercambios múltiples, consulte la sección de aplicaciones de este catálogo.

COMPETITIVE & O.E.M. INTERCHANGE LIST
Lista de Intercambios contra Competidores y Equipo Original.
Liste dinterchange de produits comptitifs & dquipement original (OEM)

Ford... cont'd

Ford	Gabriel	Upgrade	Ford	Gabriel	Upgrade	Ford	Gabriel	Upgrade	Ford	Gabriel	Upgrade
E7XZ18125A	G63350		F1HT18045CB	83216		F2HZ18124CA	85006		F5HZ18124AA	83314	
E7XZ18125B	G63387		F1HT18045DA	83312	89409	F2HZ18125A	85712		F5HZ18124B	83107	
E7XZ18125C	G63409		F1HT18045DA	89409		F2HZ18125AA	85712		F5HZ18124C	85063	
E7XZ18125J	G63299		F1HT18045DB	83308		F4HT-18045-AB	83314		F5HZ18124D	83125	
E9HS-18045-AA	83309		F1HT18045EA	89402		F4HT-18045-AC	83314		F5HZ18124DA	83125	
E9HS-18080-AA	85716		F1HT18045EB	89402		F4HT-18045-CB	83107		F5HZ18125A	85314	89425
E9HS18045AA	83309		F1HT18045GA	85006		F4HT-18045-DA	85063		F5HZ18125A	89425	
E9HS18080AA	85716		F1HT18045GB	85006		F4HT-18045-EA	83125		F5HZ18125AA	85314	89425
E9HZ-18124-A	83309		F1HT18045HB	85006		F4HT-18080-AA	85314	89425	F5HZ18125AA	89425	
E9HZ-18125-A	85716		F1HT18045KB	85006		F4HT-18080-AA	89425		F5HZ18125B	85001	89410
E9HZ-18125-AA	85716		F1HT18045LB	85006		F4HT-18080-AB	85314	89425	F5HZ18125B	89410	
E9HZ18124A	83309		F1HT18045NA	85040		F4HT-18080-AB	89425		F5HZ18125BA	85001	89410
E9HZ18125A	85716		F1HT18045RA	89402		F4HT-18080-BA	85001	89410	F5HZ18125BA	89410	
E9HZ18125AA	85716		F1HT18045RB	89402		F4HT-18080-BA	89410		F5HZ18125DA	85314	89425
EL3Z 18124-D	G57683		F1HZ-18124-A	83309		F4HT18045AB	83314		F5HZ18125DA	89425	
EL3Z 18124-E	G57683		F1HZ-18124-AA	83309		F4HT18045AC	83314		F5TZ-18124-B	G63608	
EL3Z 18124-F	G57683		F1HZ-18124-B	83308		F4HT18045CB	83107		F5TZ-18125-BC	G63607	
EL3Z 18124-G	G57683		F1HZ-18124-C	89402		F4HT18045DA	85063		F5TZ18124B	G63608	
EL3Z 18124-J	G57683		F1HZ-18124-D	85006		F4HT18045EA	83125		F5TZ18125BC	G63607	
EL3Z 18124-L	G57683		F1HZ-18124-E	85006		F4HT18080AA	85314	89425	F5UZ-18124-A	G63622	
F0HS-18045-AA	85006		F1HZ-18124-F	85006		F4HT18080AA	89425		F5UZ-18124-B	G63622	
F0HS18045AA	85006		F1HZ-18124-G	85006		F4HT18080AB	85314	89425	F5UZ-18125-A	G63623	
F0HT-18045-AA	85006		F1HZ-18124-H	85040		F4HT18080AB	89425		F5UZ-18125-C	G63624	
F0HT-18045-CA	85006		F1HZ-18124-J	83308		F4HT18080BA	85001	89410	F5UZ18124A	G63622	
F0HT-18080-AA	83122	89406	F1HZ-18124-K	89402		F4HT18080BA	89410		F5UZ18124B	G63622	
F0HT-18080-AA	89406		F1HZ18124A	83309		F4TA-18045-TA	G63455		F5UZ18125A	G63623	
F0HT18045AA	85006		F1HZ18124AA	83309		F4TA-18080-PA	G63461		F5UZ18125C	G63624	
F0HT18045CA	85006		F1HZ18124B	83308		F4TA18045TA	G63455		F6HT-18045-AA	85054	
F0HT18080AA	83122	89406	F1HZ18124C	89402		F4TA18080PA	G63461		F6HT-18045-AC	85054	
F0HT18080AA	89406		F1HZ18124D	85006		F4TZ-18124-D	G63414		F6HT-18045-BC	85047	89435
F0HZ-18124-A	85006		F1HZ18124E	85006		F4TZ-18124-K	G63455		F6HT-18045-BC	89435	
F0HZ-18124-B	85006		F1HZ18124F	85006		F4TZ-18125-E	G63461		F6HT-18045-CC	85055	89439
F0HZ-18125-A	83122	89406	F1HZ18124G	85006		F4TZ18124D	G63414		F6HT-18045-CC	89439	
F0HZ-18125-A	89406		F1HZ18124H	85040		F4TZ18124K	G63455		F6HT-18045-EB	85055	89439
F0HZ18124A	85006		F1HZ18124J	83308		F4TZ18125E	G63461		F6HT-18045-EB	89439	
F0HZ18124B	85006		F1HZ18124K	89402		F57Z-18125-AC	G63679		F6HT-18045-EC	85055	89439
F0HZ18125A	83122	89406	F1SC-18008-AA	69845		F57Z-18125-BB	G63679		F6HT-18045-EC	89439	
F0HZ18125A	89406		F1SC-18080-AA	69845		F57Z18125AC	G63679		F6HT-18045-GB	85030	89440
F1HT-18045-AA	83309		F1SZ-18125-B	69845		F57Z18125BB	G63679		F6HT-18045-GB	89440	
F1HT-18045-CA	83308		F2HT-18045-BA	85376		F5HZ-18124-A	83314		F6HT-18045-GC	85030	89440
F1HT-18045-CB	83216		F2HT-18045-CA	85376		F5HZ-18124-AA	83314		F6HT-18045-GC	89440	
F1HT-18045-DA	83312	89409	F2HT-18045-DA	85006		F5HZ-18124-B	83107		F6HT-18045-HB	85054	
F1HT-18045-DA	89409		F2HT-18080-DA	85712		F5HZ-18124-C	85063		F6HT-18045-HC	85054	
F1HT-18045-DB	83308		F2HT18045BA	85376		F5HZ-18124-D	83125		F6HT-18045-HC	89402	
F1HT-18045-EA	89402		F2HT18045CA	85376		F5HZ-18124-DA	83125		F6HT-18045-JB	89402	
F1HT-18045-EB	89402		F2HT18045DA	85006		F5HZ-18125-A	85314	89425	F6HT-18045-JC	89402	
F1HT-18045-GA	85006		F2HT18080DA	85712		F5HZ-18125-A	89425		F6HT-18045-KA	89402	
F1HT-18045-GB	85006		F2HZ-18124-A	85376		F5HZ-18125-AA	85314	89425	F6HT-18045-LA	85376	
F1HT-18045-HB	85006		F2HZ-18124-B	85301		F5HZ-18125-AA	89425		F6HT-18080-B	83109	
F1HT-18045-KB	85006		F2HZ-18124-C	85006		F5HZ-18125-B	85001	89410	F6HT-18080-CA	85314	89425
F1HT-18045-LB	85006		F2HZ-18124-CA	85006		F5HZ-18125-B	89410		F6HT-18080-CA	89425	
F1HT-18045-NA	85040		F2HZ-18125-A	85712		F5HZ-18125-BA	85001	89410	F6HT-18080-DA	83109	
F1HT-18045-RA	89402		F2HZ-18125-AA	85712		F5HZ-18125-BA	89410		F6HT-18080-EA	85906	89407
F1HT-18045-RB	89402		F2HZ18124A	85376		F5HZ-18125-DA	85314	89425	F6HT-18080-EA	89407	
F1HT18045AA	83309		F2HZ18124B	85301		F5HZ-18125-DA	89425		F6HT-18080-FC	85013	89414
F1HT18045CA	83308		F2HZ18124C	85006		F5HZ18124A	83314		F6HT-18080-FC	89414	

Important Note: Competitive Interchanges are to be used for stocking purposes only. Where multiple crosses are identified, please reference the applications section of this catalog. / **Remarque importante:** Les interchanges concurrentiels ne s'utilisent qu'aux fins de stocks. Dans le cas de références multiples, consulter la section des applications du catalogue. / **Nota importante:** Dans le cas de referencias multiples, consultar la sección des aplicaciones du catalogue. / **Nota importante:** Se pueden usar intercambios competitivos para propósitos de almacenamiento solamente. Cuando se identifican intercambios múltiples, consulte la sección de aplicaciones de este catálogo.

COMPETITIVE & O.E.M. INTERCHANGE LIST
Lista de Intercambios contra Competidores y Equipo Original.
Liste dinterchange de produits comptitifs & dquipement original (OEM)

Ford... cont'd

Ford	Gabriel	Upgrade	Ford	Gabriel	Upgrade	Ford	Gabriel	Upgrade	Ford	Gabriel	Upgrade
F6HT-18080-JA	85305		F6HZ-18125-D	89414		F81Z-18124-CA	89414		FC4Z18124B	85181	
F6HT-18124-JC	89402		F6HZ-18125-JA	85305		F81Z-18124-PA	85928		FC4Z18124HB	83135	
F6HT-18124-KA	89402		F6HZ-5K407-AB	83034		F81Z-18125-DC	G63461		FC4Z18125A	85180	
F6HT18045AA	85054		F6HZ18080FC	85013	89414	F81Z-18125-FA	83122	89406	FC4Z18125C	83168	
F6HT18045AC	85054		F6HZ18080FC	89414		F81Z-18125-FA	89406		FC4Z18125D	83148	
F6HT18045BC	85047	89435	F6HZ18124A	85054		F81Z-18125-ZA	83140		FC4Z18125E	85978	
F6HT18045BC	89435		F6HZ18124B	83308		F81Z18124AL	G63622		FK3Z-18124-M	G57816	
F6HT18045CC	85055	89439	F6HZ18124C	85055	89439	F81Z18124BK	G63809		FK3Z-18125-C	G64177	
F6HT18045CC	89439		F6HZ18124C	89439		F81Z18124CA	83209	89414	FK4Z-18124-N	G57816	
F6HT18045EB	85055	89439	F6HZ18124D	85055	89439	F81Z18124CA	89414		FK4Z-18125-C	G57816	
F6HT18045EB	89439		F6HZ18124D	89439		F81Z18124PA	85928		FL3Z-18125-K	G64157	
F6HT18045EC	85055	89439	F6HZ18124E	85055	89439	F81Z18125DC	G63461		GL3Z 18124-B	G57683	
F6HT18045EC	89439		F6HZ18124E	89439		F81Z18125FA	83122	89406	GL3Z 18124-C	G57683	
F6HT18045GB	85030	89440	F6HZ18124F	85055	89439	F81Z18125FA	89406		GL3Z 18124-D	G57683	
F6HT18045GB	89440		F6HZ18124F	89439		F81Z18125ZA	83140		GL3Z 18124-E	G57683	
F6HT18045GC	85030	89440	F6HZ18124G	85054		F87A-18045-AH	G63772		GL3Z-18125-E	G64079	
F6HT18045GC	89440		F6HZ18124H	85054		F87A-18045-CC	G63678		GL3Z-18125-F	G64079	
F6HT18045HB	85054		F6HZ18124J	89402		F87A-18045-JA	G63678		GU2Z-18A092-P	G57132	
F6HT18045HC	85054		F6HZ18124KA	89402		F87A-18080-AC	G63773		HC3Z-18124-B	G63622	
F6HT18045JB	89402		F6HZ18124MA	85006		F87A-18080-BC	G63773		HC3Z-18124-C	G63622	
F6HT18045JC	89402		F6HZ18125A	85314	89425	F87A18045AH	G63772		HC3Z-18124-G	G63622	
F6HT18045KA	89402		F6HZ18125A	89425		F87A18045CC	G63678		HC3Z-18124-J	77967	
F6HT18045LA	85376		F6HZ18125B	83109		F87A18045JA	G63678		HC3Z-18124-U	G63886	
F6HT18045MA	85006		F6HZ18125D	85013	89414	F87A18080AC	G63773		HC3Z-18125-B	77987	
F6HT18080B	83109		F6HZ18125D	89414		F87A18080BC	G63773		HC3Z-18125-ED	77987	
F6HT18080CA	85314	89425	F6HZ18125JA	85305		F87Z-18124-AA	G63772		HC3Z-18125-EE	77987	
F6HT18080CA	89425		F6HZ5K407AB	83034		F87Z-18124-CA	G63678		HC3Z-18125-EP	77986	
F6HT18080DA	83109		F77A-18045-AA	G63608		F87Z-18124-JA	G63678		HC3Z-18125-X	77986	
F6HT18080EA	85906	89407	F77A-18080-AA	G63679		F87Z-18125-AA	G63773		HG9Z 18124-A	G57812	
F6HT18080EA	89407		F77A-18080-BA	G63607		F87Z-18125-BA	G63773		HG9Z 18124-B	G57812	
F6HT18080FC	85013	89414	F77A18045AA	G63608		F87Z-18125-CA	G63773		HG9Z 18124-D	G57812	
F6HT18080FC	89414		F77A18080AA	G63679		F87Z-18125-RA	G63775		HG9Z 18124-F	G57812	
F6HT18080JA	85305		F77A18080BA	G63607		F87Z18124AA	G63772		HG9Z 18124-G	G57812	
F6HT18124JC	89402		F77D-18080-BA	G63679		F87Z18124CA	G63678		HG9Z 18124-H	G57812	
F6HT18124KA	89402		F77D18080BA	G63679		F87Z18124JA	G63678		HG9Z 18124-J	G57812	
F6HZ-18080-FC	85013	89414	F7C2Z-18124-BR	G63929		F87Z18125AA	G63773		HG9Z 18124-K	G57812	
F6HZ-18080-FC	89414		F7C2Z18124BR	G63929		F87Z18125BA	G63773		HG9Z 18124-L	G57812	
F6HZ-18124-A	85054		F7TA-18045-AA	G63608		F87Z18125CA	G63773		HG9Z 18124-M	G57812	
F6HZ-18124-B	83308		F7TA-18080-BA	G63607		F87Z18125RA	G63775		HG9Z 18124-N	G57812	
F6HZ-18124-C	85055	89439	F7TA18045AA	G63608		FB5Z 18125-A	G51980		HG9Z 18124-P	G57812	
F6HZ-18124-C	89439		F7TA18080BA	G63607		FB5Z 18125-B	G51980		HU9A18045AA	83209	89414
F6HZ-18124-D	85055	89439	F81A-18080-DCA	G63461		FB5Z 18125-D	G51980		HU9A18045AA	89414	
F6HZ-18124-D	89439		F81A-18080-ZC	83140		FB5Z-18125-E	G51980		HU9A18045BA	83209	89414
F6HZ-18124-E	85055	89439	F81A18080DCA	G63461		FC44-18045-AB	85181		HU9A18045BA	89414	
F6HZ-18124-E	89439		F81A18080ZC	83140		FC44-18045-BB	85181		HU9Z-18045-AA	83209	89414
F6HZ-18124-F	85055	89439	F81D-18045-CD	83209	89414	FC44-18080-AB	85180		HU9Z-18045-BA	83209	89414
F6HZ-18124-F	89439		F81D-18045-CD	89414		FC4418045BB	85181		HU9Z-18124-A	85006	
F6HZ-18124-G	85054		F81D-18080-CD	83122	89406	FC4418080AB	85180		HU9Z-18124-B	83209	89414
F6HZ-18124-H	85054		F81D-18080-CD	89406		FC4Z-18124-A	85181		HU9Z-18124-B	89414	
F6HZ-18124-J	89402		F81D18045CD	83209	89414	FC4Z-18124-B	85181		HU9Z-18124-C	83209	89414
F6HZ-18124-KA	89402		F81D18045CD	89414		FC4Z-18124-HB	83135		HU9Z-18124-C	89414	
F6HZ-18124-MA	85006		F81D18080CD	83122	89406	FC4Z-18125-A	85180		HU9Z-18125-A	85005	89430
F6HZ-18125-A	85314	89425	F81D18080CD	89406		FC4Z-18125-C	83168		HU9Z-18125-A	89430	
F6HZ-18125-A	89425		F81Z-18124-AL	G63622		FC4Z-18125-D	83148		HU9Z-18125-B	83122	89406
F6HZ-18125-B	83109		F81Z-18124-BK	G63809		FC4Z-18125-E	85978		HU9Z-18125-B	89406	
F6HZ-18125-D	85013	89414	F81Z-18124-CA	83209	89414	FC4Z18124A	85181		HU9Z-18125-C	83122	89406

Important Note: Competitive Interchanges are to be used for stocking purposes only. Where multiple crosses are identified, please reference the applications section of this catalog. / **Remarque importante:** Les interchanges concurrentiels ne s'utilisent qu'aux fins de stocks. Dans le cas de rferences multiples, consulter la section des applications du catalogue. / **Nota importante:** Dans le cas de rferences multiples, consulter la section des aplicaciones del catalogo. / **Nota importante:** Se pueden usar intercambios competitivos para propósitos de almacenamiento solamente. Cuando se identifican intercambios múltiples, consulte la sección de aplicaciones de este catálogo.

COMPETITIVE & O.E.M. INTERCHANGE LIST
Lista de Intercambios contra Competidores y Equipo Original.
Liste dinterchange de produits comptitifs & dquipement original (OEM)

Ford... cont'd

Ford	Gabriel	Upgrade	Ford	Gabriel	Upgrade	Ford	Gabriel	Upgrade	Ford	Gabriel	Upgrade
HU9Z-18125-C	89406		M7C3Z-18124-AKA	G63622		THAB-18045-B	83219		XL2418080BA	G63679	
HU9Z18124A	85006		MAA568	G63614		THAB18045A	83219		XL2418080CA	G63679	
HU9Z18124B	83209	89414	MBE8Z-18124-A	G52256		THAB18045B	83219		XL2418080EA	G63679	
HU9Z18124B	89414		MBE8Z-18124-B	G52355		TQSH-18045-A	83309		XL2Z-18124-BA	G63678	
HU9Z18124C	83209	89414	MR-AB-415	G63678		TQSH18045A	83309		XL2Z-18124-EA	G63678	
HU9Z18124C	89414		TACAA-18045-A	83216		XC35-18045-AB	83131		XL2Z-18124-JA	G63678	
HU9Z18125A	85005	89430	TACAA18045A	83216		XC35-18045-AD	83131		XL2Z-18125-BA	G63679	
HU9Z18125A	89430		TANNA-18045-A	83312	89409	XC35-18045-JA	83131		XL2Z-18125-CA	G63679	
HU9Z18125B	83122	89406	TANNA-18045-A	89409		XC3518045AB	83131		XL2Z-18125-EA	G63679	
HU9Z18125B	89406		TANNA18045A	83312	89409	XC3518045AD	83131		XL2Z18124BA	G63678	
HU9Z18125C	83122	89406	TANNA18045A	89409		XC3518045JA	83131		XL2Z18124EA	G63678	
HU9Z18125C	89406		TDBA-18045-A	83219		XC3Z-18124-JA	83131		XL2Z18124JA	G63678	
JL3Z 18124-D	G57683		TDBA-18045-B	83219		XC3Z18124JA	83131		XL2Z18125BA	G63679	
JL3Z 18124-E	G57683		TDBA18045A	83219		XC45-18045-AA	83216		XL2Z18125CA	G63679	
JL3Z 18124-F	G57683		TDBA18045B	83219		XC4518045AA	83216		XL2Z18125EA	G63679	
JL3Z-18124-B	G57683		TDBE-18045-A	83219		XL24-18045-BA	G63678		XL58-18080-AC	G63773	
JL3Z-18124-J	G57683		TDBE18045A	83219		XL24-18045-EA	G63678		XL5818080AC	G63773	
KC3Z-3E651-C	14072		TFAA-18045-B	83219		XL24-18045-JA	G63678		XL5Z-18125-AA	G63773	
LC3Z-18125-J	77986		TFAA-18045-C	83219		XL24-18080-BA	G63679		XL5Z18125AA	G63773	
LC3Z-18125-W	77986		TFAA-18080-A	85307		XL24-18080-CA	G63679		YL5Z-18124-AA	G63772	
M5L3Z-18124-HA	G51703		TFAA18045B	83219		XL24-18080-EA	G63679		YL5Z18124AA	G63772	
M5L3Z-18124-HA	G51704		TFAA18045C	83219		XL2418045BA	G63678				
M5L3Z-18125-BA	G63867		TFAA18080A	85307		XL2418045EA	G63678				
M5L3Z-18125-BA	G63870		THAB-18045-A	83219		XL2418045JA	G63678				

Forest River

Forest river	Gabriel	Upgrade	Forest river	Gabriel	Upgrade	Forest river	Gabriel	Upgrade	Forest river	Gabriel	Upgrade
141700131809	85029		8C2Z-18125-D	G63623		ASH-1206	89406		ASH1206	83122	89406
141700131810	83160		8C2Z18124D	G63622		ASH-1228	83209	89414	ASH1206	89406	
16-16736-000	85029		8C2Z18125D	G63623		ASH-1228	89414		ASH1228	83209	89414
16-16737-000	83160		9U94-18045-AA	83209	89414	ASH-1229	83209	89414	ASH1228	89414	
16-16873-000	85029		9U94-18045-AA	89414		ASH-1229	89414		ASH1229	83209	89414
16-16874-000	83160		9U94-18080-AA	83122	89406	ASH-1230	83122	89406	ASH1229	89414	
16-18103-000	85900		9U94-18080-AA	89406		ASH-1230	89406		ASH1230	83122	89406
1616736000	85029		9U9418045AA	83209	89414	ASH-137	83122	89406	ASH1230	89406	
1616737000	83160		9U9418045AA	89414		ASH-137	89406		ASH137	83122	89406
1616873000	85029		9U9418080AA	83122	89406	ASH-25820	85005	89430	ASH137	89406	
1616874000	83160		9U9418080AA	89406		ASH-25820	89430		ASH25820	85005	89430
1618103000	85900		9U9Z-18124-A	83209	89414	ASH-25821	85006		ASH25820	89430	
1C34-18045-AA	83209	89414	9U9Z-18124-A	89414		ASH-25822	83209	89414	ASH25821	85006	
1C34-18045-AA	89414		9U9Z-18125-A	83122	89406	ASH-25822	89414		ASH25822	83209	89414
1C34-18045-JA	83209	89414	9U9Z-18125-A	89406		ASH-25823	83209	89414	ASH25822	89414	
1C34-18045-JA	89414		9U9Z18124A	83209	89414	ASH-25823	89414		ASH25823	83209	89414
1C3418045AA	83209	89414	9U9Z18124A	89414		ASH-25824	83122	89406	ASH25823	89414	
1C3418045AA	89414		9U9Z18125A	83122	89406	ASH-25824	89406		ASH25824	83122	89406
1C3418045JA	83209	89414	9U9Z18125A	89406		ASH-294	83209	89414	ASH25824	89406	
1C3418045JA	89414		ASH-1022	83209	89414	ASH-294	89414		ASH294	83209	89414
481700000490	85900		ASH-1022	89414		ASH1022	83209	89414	ASH294	89414	
481700000493	85900		ASH-1023	83122	89406	ASH1022	89414		AT-163G	G63622	
66153-002	83124	89407	ASH-1023	89406		ASH1023	83122	89406	AT-164G	G63623	
66153-002	89407		ASH-1136	G63623		ASH1023	89406		AT-620	83209	89414
66153002	83124	89407	ASH-1154	G63622		ASH1136	G63623		AT-620	89414	
66153002	89407		ASH-1161	85006		ASH1154	G63622		AT-621	83122	89406
8C24-18045-DA	G63622		ASH-1162	85005	89430	ASH1161	85006		AT-621	89406	
8C24-18080-DB	G63623		ASH-1162	89430		ASH1162	85005	89430			
8C2418045DA	G63622		ASH-1205	83209	89414	ASH1162	89430				
8C2418080DB	G63623		ASH-1205	89414		ASH1205	83209	89414			
8C2Z-18124-D	G63622		ASH-1206	83122	89406	ASH1205	89414				

Important Note: Competitive Interchanges are to be used for stocking purposes only. Where multiple crosses are identified, please reference the applications section of this catalog. / **Remarque importante:** Les interchanges concurrentiels ne s'utilisent qu'aux fins de stocks. Dans le cas de rferences multiples, consulter la section des applications du catalogue. / **Nota importante:** Dans le cas de rferences multiples, consulter la section des applications du catalogue. / **Nota importante:** Se pueden usar intercambios competitivos para propósitos de almacenamiento solamente. Cuando se identifican intercambios múltiples, consulte la sección de aplicaciones de este catálogo.

COMPETITIVE & O.E.M. INTERCHANGE LIST
Lista de Intercambios contra Competidores y Equipo Original.
Liste dinterchange de produits comptitifs & dquipement original (OEM)

Forest River... cont'd

Forest river	Gabriel	Upgrade	Forest river	Gabriel	Upgrade	Forest river	Gabriel	Upgrade	Forest river	Gabriel	Upgrade
AT-766	83209	89414	AT620	83209	89414	AT766	83209	89414	F4BE5C832MO	83124	89407
AT-766	89414		AT620	89414		AT766	89414		F4BE5C832MO	89407	
AT163G	G63622		AT621	83122	89406	F4-BE5-C832-MO	83124	89407			
AT164G	G63623		AT621	89406		F4-BE5-C832-MO	89407				

Freightliner

Freightliner	Gabriel	Upgrade	Freightliner	Gabriel	Upgrade	Freightliner	Gabriel	Upgrade	Freightliner	Gabriel	Upgrade
10-12030-002	85320	89429	1012032000	85320	89429	1201-1044	83025		16-15592-000	83154	
10-12030-002	89429		1012032000	89429		12010012	83023		16-15676-000	85058	89431
10-12032-000	85320	89429	1012032001	85320	89429	12010054	83021		16-15676-000	89431	
10-12032-000	89429		1012032001	89429		12011043	83025		16-15705-000	83120	
10-12032-001	85320	89429	1012032002	85320	89429	12011044	83025		16-15755-000	85043	
10-12032-001	89429		1012032002	89429		1202-0012	83023		16-15765-000	85921	
10-12032-002	85320	89429	1012032003	85320	89429	1202-0032	83016		16-15770-000	85956	
10-12032-002	89429		1012032003	89429		1202-0042	83025		16-15805-000	83120	
10-12032-003	85320	89429	1012032004	85320	89429	1202-0043	83025		16-15817-000	85724	89443
10-12032-003	89429		1012032004	89429		1202-0044	83025		16-15817-000	89443	
10-12032-004	85320	89429	1012046000	85320	89429	1202-0054	83021		16-15934-000	83120	
10-12032-004	89429		1012046000	89429		1202-1043	83025		16-16043-000	85043	
10-12046-000	85320	89429	1012388000	85920	89503	1202-1044	83025		16-16082-000	85043	
10-12046-000	89429		1012388000	89503		12020012	83023		16-16083-000	85331	
10-12388-000	85920	89503	1012390000	85920	89503	12020032	83016		16-16093-000	83160	
10-12388-000	89503		1012390000	89503		12020042	83025		16-16262-000	83120	
10-12390-000	85920	89503	1012396000	85918	89449	12020043	83025		16-16442-000	83134	
10-12390-000	89503		1012396000	89449		12020044	83025		16-16486-000	83134	
10-12396-000	85918	89449	1012542000	85901		12020054	83021		16-16542-000	83154	
10-12396-000	89449		1012703000	85918	89449	12021043	83025		16-16577-000	85335	
10-12542-000	85901		1012703000	89449		12021044	83025		16-16736-000	85029	
10-12703-000	85918	89449	1013021000	85918	89449	1398980	83127		16-16737-000	83160	
10-12703-000	89449		1013021000	89449		141700000377	83160		16-16764-000	85724	89443
10-13021-000	85918	89449	1013051001	85005	89430	141700000378	83160		16-16764-000	89443	
10-13021-000	89449		1013051001	89430		141700131809	85029		16-16765-000	85006	
10-13051-001	85005	89430	1013063000	85918	89449	141700131810	83160		16-16826-000	85043	
10-13051-001	89430		1013063000	89449		141700131975	83160		16-16827-000	85331	
10-13063-000	85918	89449	1013205000	85918	89449	141700131980	83160		16-16836-000	83154	
10-13063-000	89449		1013205000	89449		16-11133-000	85007		16-16873-000	85029	
10-13205-000	85918	89449	1013211000	85918	89449	16-12117-000	85007		16-16874-000	83160	
10-13205-000	89449		1013211000	89449		16-13947-000	85319	89428	16-17144-000	85900	
10-13211-000	85918	89449	1013592000	85959		16-13947-000	89428		16-17211-000	85909	
10-13211-000	89449		1013634000	85918	89449	16-13957-000	85724	89443	16-17361-000	85900	
10-13592-000	85959		1013634000	89449		16-13957-000	89443		16-17684-000	85058	89431
10-13634-000	85918	89449	1013684000	85918	89449	16-14259-000	85331		16-17684-000	89431	
10-13634-000	89449		1013684000	89449		16-14577-000	85043		16-17759-000	85919	
10-13684-000	85918	89449	1013759000	85006		16-14667-000	85005	89430	16-17760-000	85331	
10-13684-000	89449		1013760000	85959		16-14667-000	89430		16-18075-000	83160	
10-13759-000	85006		1013776000	85005	89430	16-14668-000	83127		16-18076-000	83160	
10-13760-000	85959		1013776000	89430		16-14669-000	G63403		16-18094-000	85959	
10-13776-000	85005	89430	1013809000	85958		16-14759-000	85000	89436	16-18103-000	85900	
10-13776-000	89430		1013859000	85005	89430	16-14759-000	89436		16-18455-000	85918	89449
10-13809-000	85958		1013859000	89430		16-14794-000	83154		16-18455-000	89449	
10-13859-000	85005	89430	1013976000	85918	89449	16-15064-000	83154		16-18456-000	85959	
10-13859-000	89430		1013976000	89449		16-15089-000	83164		16-18705-000	85007	
10-13976-000	85918	89449	1014193000	83396		16-15394-000	83120		16-18706-000	85331	
10-13976-000	89449		1014282000	83396		16-15436-000	83154		16-18707-000	85921	
10-14193-000	83396		1014339000	83396		16-15473-000	83157				
10-14339-000	83396		1201-0012	83023		16-15474-000	83157				
1012030002	85320	89429	1201-0054	83021		16-15475-000	83164				
1012030002	89429		1201-1043	83025		16-15591-000	85043				

Important Note: Competitive Interchanges are to be used for stocking purposes only. Where multiple crosses are identified, please reference the applications section of this catalog. / **Remarque importante:** Les interchanges concurrentiels ne s'utilisent qu'aux fins de stocks. Dans le cas de rferences multiples, consulter la section des applications du catalogue. / **Nota importante:** Dans le cas de rferences multiples, consulter la section des applications du catalogue. / **Nota importante:** Se pueden usar intercambios competitivos para propósitos de almacenamiento solamente. Cuando se identifican intercambios múltiples, consulte la sección de aplicaciones de este catálogo.

COMPETITIVE & O.E.M. INTERCHANGE LIST
Lista de Intercambios contra Competidores y Equipo Original.
Liste dinterchange de produits comptitifs & dquipement original (OEM)

Freightliner... cont'd

Freightliner	Gabriel	Upgrade	Freightliner	Gabriel	Upgrade	Freightliner	Gabriel	Upgrade	Freightliner	Gabriel	Upgrade
16-18708-000	85724	89443	1616577000	85335		18-47350-000	83040		471700002726	89449	
16-18708-000	89443		1616736000	85029		18-60295-000	83006		471700002727	85959	
16-18709-000	83134		1616737000	83160		18-60764-000	83038		471700002808	85724	89443
16-18710-000	83134		1616764000	85724	89443	18-60765-000	83038		471700002808	89443	
16-18711-000	85335		1616764000	89443		18-60765-001	83047		471700002809	85724	89443
16-19138-000	85058	89431	1616765000	85006		18-60765-002	83038		471700002809	89443	
16-19138-000	89431		1616826000	85043		18-60766-000	83040		471700002990	85007	
16-20552-000	83154		1616827000	85331		18-60767-000	83039		471700002991	85959	
16-20628-000	85058	89431	1616836000	83154		18-60769-000	83009		471700002992	85331	
16-20628-000	89431		1616873000	85029		18-60772-000	83026		471700002993	85921	
16-20632-000	85919		1616874000	83160		18-60773-000	83027		471700002994	83134	
16-20716-000	85724	89443	1617144000	85900		18-67845-000	83906		471700002995	83134	
16-20716-000	89443		1617211000	85909		18-69674-000	83906		471700002996	85335	
16-22004-000	85058	89431	1617361000	85900		18-73207-000	83911		471700003000	85335	
16-22004-000	89431		1617684000	85058	89431	1829846000	83009		471700003009	85006	
1611133000	85007		1617684000	89431		1830378	83006		471700003011	85058	89431
1612117000	85007		1617759000	85919		1830378000	83001		471700003011	89431	
1613947000	85319	89428	1617760000	85331		1830378000	83006		471700003920	85958	
1613947000	89428		1618076000	83160		1832999000	83001		471700005079	85005	89430
1613957000	85724	89443	1618094000	85959		1832999001	83006		471700005079	89430	
1613957000	89443		1618103000	85900		1837813000	83044		471700006269	85932	89453
1614259000	85331		1618455000	85918	89449	1841762000	83038		471700006269	89453	
1614577000	85043		1618455000	89449		1841762001	83047		471700010991	83154	
1614667000	85005	89430	1618456000	85959		1841762002	83038		471700011302	85058	89431
1614667000	89430		1618705000	85007		1844321000	83009		471700011302	89431	
1614668000	83127		1618706000	85331		1845067000	83034		471700131155	85918	89449
1614669000	G63403		1618707000	85921		1847349000	83039		471700131155	89449	
1614759000	85000	89436	1618708000	85724	89443	1847350000	83040		471700131331	85932	89453
1614759000	89436		1618708000	89443		1860295000	83006		471700131331	89453	
1614794000	83154		1618709000	83134		1860764000	83038		471700131646	85918	89449
1615064000	83154		1618710000	83134		1860765000	83038		471700131646	89449	
1615394000	83120		1618711000	85335		1860765001	83047		471700131650	85918	89449
1615436000	83154		1619138000	85058	89431	1860765002	83038		471700131650	89449	
1615473000	83157		1619138000	89431		1860766000	83040		471700131775	85006	
1615474000	83157		1620552000	83154		1860767000	83039		471700131778	85331	
1615475000	83164		1620632000	85919		1860769000	83009		471700131780	85331	
1615591000	85043		1620716000	85724	89443	1860772000	83026		471700131974	85029	
1615592000	83154		1620716000	89443		1860773000	83027		47902-13	83122	89406
1615676000	85058	89431	16725-01	83126	89430	1867845000	83906		47902-13	89406	
1615676000	89431		16725-01	89430		1869674000	83906		4790213	83122	89406
1615705000	83120		1672501	83126	89430	1873207000	83911		4790213	89406	
1615755000	85043		1672501	89430		19495-01	83126	89430	481700000477	85900	
1615765000	85921		17455-00	89430		19495-01	89430		481700000480	85900	
1615770000	85956		18-29846-000	83009		1949501	83126	89430	481700000490	85900	
1615805000	83120		18-30378	83006		1949501	89430		481700000493	85900	
1615817000	85724	89443	18-30378-000	83001		3638112	G63183		481700006848	85724	89443
1615817000	89443		18-30378-000	83006		4036892	G63605		481700006848	89443	
1615934000	83120		18-32999-000	83001		471700000440	85959		481700006850	85724	89443
1616043000	85043		18-32999-001	83006		471700000447	85919		481700006850	89443	
1616082000	85043		18-37813-000	83044		471700000449	85918	89449	481700125969	85956	
1616083000	85331		18-41762-000	83038		471700000449	89449		481700125970	85956	
1616093000	83160		18-41762-001	83047		471700000450	89449		481700131919	85900	
1616262000	83120		18-41762-002	83038		471700000466	85959		481700131920	85900	
1616442000	83134		18-44321-000	83009		471700000470	85918	89449	535228	85302	89420
1616486000	83134		18-45067-000	83034		471700000470	89449		535228	89420	
1616542000	83154		18-47349-000	83039		471700002726	85918	89449	58913-003	85932	89453

Important Note: Competitive Interchanges are to be used for stocking purposes only. Where multiple crosses are identified, please reference the applications section of this catalog. / **Remarque importante:** Les interchanges concurrentiels ne s'utilisent qu'aux fins de stocks. Dans le cas de références multiples, consulter la section des applications du catalogue. / **Nota importante:** Dans le cas de références multiples, consulter la section des applications du catalogue. / **Nota importante:** Se pueden usar intercambios competitivos para propósitos de almacenamiento solamente. Cuando se identifican intercambios múltiples, consulte la sección de aplicaciones de este catálogo.

COMPETITIVE & O.E.M. INTERCHANGE LIST
Lista de Intercambios contra Competidores y Equipo Original.
Liste dinterchange de produits comptitifs & dquipement original (OEM)

Freightliner... cont'd

Freightliner	Gabriel	Upgrade	Freightliner	Gabriel	Upgrade	Freightliner	Gabriel	Upgrade	Freightliner	Gabriel	Upgrade
58913-003	89453		654953	89431		680442	85319	89428	90044162	89436	
58913-003L	85932	89453	654990	83038		680442	89428		90045083	85910	
58913-003L	89453		659060	85920	89503	680511	85331		A90193	83396	
58913-012	85932	89453	659060	89503		680611	85724	89443	GBL 650361	83017	
58913-012	89453		659062	83134		680611	89443		GBL 651375	83119	
58913-012L	85932	89453	659063	83134		680651	85335		GBL654725	83120	
58913-012L	89453		659079	83040		680782	85302	89420	GBL654726	83120	
58913-015	85200		659080	83039		680782	89420		GBL654727	83120	
58913003	85932	89453	659125	83047		681-323-0900	85009		GBL654728	83120	
58913003	89453		659178	83038		681-323-1100	85301		GBL654729	83120	
58913003L	85932	89453	659227	85058	89431	681-326-0400	85319	89428	GBL654730	83120	
58913003L	89453		659227	89431		681-326-0400	89428		GBL654731	83120	
58913012	85932	89453	659288	83006		681-891-02-05	83017		GBL654732	83120	
58913012	89453		659300	85005	89430	6813230900	85009		GBL654733	83120	
58913012L	85932	89453	659300	89430		6813231100	85301		GBL654734	83120	
58913012L	89453		665174	85060		6813260400	85319	89428	GBL654735	83120	
58913015	85200		665236	85007		6813260400	89428		GBL665538	85006	
60680-004	83143		665409	85009		6818910205	83017		H60680004	83143	
60680-004L	83143		665545401	89430		70029	85308	89422	HDR60680-004	83143	
60680-005	83142		671908	85918	89449	70029	89422		HDR60680-005	83142	
60680-005L	83142		671908	89449		70042	85302	89420	HDR60680004	83143	
60680004	83143		671945	85920	89503	70042	89420		HDR60680005	83142	
60680004L	83143		671945	89503		814903003482	83040		MAE 16949	83120	
60680005	83142		671946	85921		814903003483	83039		P117099	83120	
60680005L	83142		680008	85300	89419	814903003486	83047		RW24285	83119	
61300224	85918	89449	680008	89419		814903003490	83047		SDA471400003920	85958	
61300224	89449		680009	85302	89420	814903003496	83009		SDA471700000440	85959	
61300240	85918	89449	680009	89420		814903003528	83038		SDA471700002809	85724	89443
61300240	89449		680017	85302	89420	814903003530	83038		SDA471700002809	89443	
650224	83225		680017	89420		814903012666	83906		SDA471700002991	85959	
654654	85043		6803230200	85043		814903012670	83906		SDA471700003920	85958	
654739	83009		6803230300	85006		814903015188	83906		X9007009-73	83396	
654819	83001		6803260000	83120		814903015190	83906				
654831	83006		680339	85724	89443	814903018451	83911				
654953	85058	89431	680339	89443		90044162	83128	89436			

Fruehauf

Fruehauf	Gabriel	Upgrade	Fruehauf	Gabriel	Upgrade	Fruehauf	Gabriel	Upgrade	Fruehauf	Gabriel	Upgrade
144-5910	85300	89419	UCA-5431	85305		UCE-1295-901	85300	89419	UCE29831	85322	
144-5910	89419		UCA01113	85304		UCE-1295-901	89419		UCE93991	83122	89406
1445910	85300	89419	UCA5431	85305		UCE-2983-000	85322		UCE93991	89406	
1445910	89419		UCD-006216-001	83203	89436	UCE-2983-001	85322		UCF-8339-001	85321	
5116-117	83122	89406	UCD-006216-001	89436		UCE-2983-1	85322		UCF-8339-002	85321	
5116-117	89406		UCD-6216-1	83203	89436	UCE-9399-1	83122	89406	UCF8339001	85321	
5116117	83122	89406	UCD-6216-1	89436		UCE-9399-1	89406		UCF8339002	85321	
5116117	89406		UCD006216001	83203	89436	UCE12951	85300	89419	UEY 1124-001	85030	89440
5352858	85305		UCD006216001	89436		UCE12951	89419		UEY 1124-001	89440	
680117	85300	89419	UCD62161	83203	89436	UCE1295901	85300	89419	UEY 1124001	85030	89440
680117	89419		UCD62161	89436		UCE1295901	89419		UEY 1124001	89440	
680298	85321		UCE-1295-1	85300	89419	UCE2983000	85322				
UCA-01113	85304		UCE-1295-1	89419		UCE2983001	85322				

FWD Truck

Fwd truck	Gabriel	Upgrade	Fwd truck	Gabriel	Upgrade	Fwd truck	Gabriel	Upgrade	Fwd truck	Gabriel	Upgrade
450739	85302	89420	450739	89420							

GasSLX

Gasslx	Gabriel	Upgrade	Gasslx	Gabriel	Upgrade	Gasslx	Gabriel	Upgrade	Gasslx	Gabriel	Upgrade
89405	83123		89406	83122							
89405	85036		89407	83124							

Important Note: Competitive Interchanges are to be used for stocking purposes only. Where multiple crosses are identified, please reference the applications section of this catalog. / **Remarque importante:** Les interchanges concurrentiels ne s'utilisent qu'aux fins de stocks. Dans le cas de rferences multiples, consulter la section des applications du catalogue. / **Nota importante:** Dans le cas de rferences multiples, consulter la section des applications du catalogue. / **Nota importante:** Se pueden usar intercambios competitivos para propósitos de almacenamiento solamente. Cuando se identifican intercambios múltiples, consulte la sección de aplicaciones de este catálogo.

COMPETITIVE & O.E.M. INTERCHANGE LIST
Lista de Intercambios contra Competidores y Equipo Original.
Liste dinterchange de produits comptitifs & dquipement original (OEM)

GasSLX... cont'd

Gaslsx	Gabriel	Upgrade	Gaslsx	Gabriel	Upgrade	Gaslsx	Gabriel	Upgrade	Gaslsx	Gabriel	Upgrade
89407	83207		89422	85308		89435	85047		89449	85918	
89407	85906		89423	85310		89436	83128		89450	85061	
89408	85062		89424	85311		89436	83203		89451	85067	
89409	83312		89425	85314		89436	83389		89453	85932	
89410	85001		89426	85316		89436	85000		89454	85933	
89411	85003		89427	85033		89436	85323		89455	85069	
89413	85012		89428	85319		89439	85055		89456	85936	
89414	83209		89429	85320		89440	85030		89457	85924	
89414	85013		89430	83126		89442	85053		89458	85923	
89415	85023		89430	85005		89443	85724		89458	85931	
89419	85300		89430	85916		89447	83456		89459	85070	
89420	85302		89431	85058		89447	85705		89460	85084	
89422	85303		89434	85046		89448	85066		89503	85920	

GasSLX - Fleetline

Gaslsx - fleetline	Gabriel	Upgrade	Gaslsx - fleetline	Gabriel	Upgrade	Gaslsx - fleetline	Gabriel	Upgrade	Gaslsx - fleetline	Gabriel	Upgrade
83122	89406		85005	89430		85066	89448		85320	89429	
83123	89405		85012	89413		85067	89451		85323	89436	
83124	89407		85013	89414		85069	89455		85705	89447	
83126	89430		85023	89415		85070	89459		85724	89443	
83128	89436		85030	89440		85084	89460		85906	89407	
83203	89436		85033	89427		85300	89419		85916	89430	
83207	89407		85036	89405		85302	89420		85918	89449	
83209	89414		85046	89434		85303	89422		85920	89503	
83312	89409		85047	89435		85308	89422		85923	89458	
83389	89436		85053	89442		85310	89423		85924	89457	
83456	89447		85055	89439		85311	89424		85931	89458	
85000	89436		85058	89431		85314	89425		85932	89453	
85001	89410		85061	89450		85316	89426		85933	89454	
85003	89411		85062	89408		85319	89428		85936	89456	

General Motors

General motors	Gabriel	Upgrade	General motors	Gabriel	Upgrade	General motors	Gabriel	Upgrade	General motors	Gabriel	Upgrade
1-51630-168-1	83515		12474694	49213		15172340	G63842		15836875	143355	
1-51630-217-0	83114		12474719	61544		15172342	G63842		15840282	143316	
1-51630-217-1	83114		12474719	G63489		15174898	83136		15845231	61718	
1-51630-219-1	83114		12474721	43180		15174902	85071		15845231	G64015	
10363555	69589		12474721	49231		15195073	G51718		15864982	G57070	
10363583	143074		12474721	58638		15198894	G51718		15873313	49228	
10363584	143073		12474721	61565		15206892	G63842		15873314	49228	
10368516	69587		12474721	77638		15211377	49228		15887728	83136	
10379370	69590		12474721	G63638		15211378	49228		1591501	85722	
10443949	69676		12474915	83122	89406	15232939	143366		15935605	43181	
11569856	143366		12474915	89406		15260892	G63842		15935605	61600	
1201-0054	83021		12474917	83137		15294604	69589		15935611	58412	
1201-1043	83025		12477893	49213		15588554	83136		15935611	61642	
12010054	83021		12477894	49213		15642943	83136		15935611	77412	
12011043	83025		12477894	61528		15740554	83137		15935621	43181	
1202-0012	83023		15023687	49213		15786900	49228		15935625	58412	
1202-0032	83016		15098725	G51718		15786901	49228		15935625	61642	
1202-0054	83021		15098726	G51718		15789588	G51718		15935625	77412	
1202-1043	83025		15098727	G51718		15789590	G51718		15935629	61600	
12020012	83023		15123676	83136		15791315	69589		15943270	61659	
12020032	83016		15125521	G51718		15806823	G64015		15963161	83122	89406
12020054	83021		1516301681	83515		15836873	143354		15963161	89406	
12021043	83025		1516302170	83114		15836873	143355		15998555	49213	
12474692	49213		1516302171	83114		15836874	143355		18041276	69845	
12474692	61528		1516302191	83114		15836875	143354		19122332	G56773	

Important Note: Competitive Interchanges are to be used for stocking purposes only. Where multiple crosses are identified, please reference the applications section of this catalog. / **Remarque importante:** Les interchanges concurrentiels ne s'utilisent qu'aux fins de stocks. Dans le cas de rfrences multiples, consulter la section des applications du catalogue. / **Nota importante:** Dans le cas de rfrences multiples, consulter la section des applications du catalogue. / **Nota importante:** Se pueden usar intercambios competitivos para propósitos de almacenamiento solamente. Cuando se identifican intercambios múltiples, consulte la sección de aplicaciones de este catálogo.

COMPETITIVE & O.E.M. INTERCHANGE LIST
Lista de Intercambios contra Competidores y Equipo Original.
Liste d'interchange de produits complitifs & d'equipement original (OEM)

General Motors... cont'd

General motors	Gabriel	Upgrade	General motors	Gabriel	Upgrade	General motors	Gabriel	Upgrade	General motors	Gabriel	Upgrade
19122333	G56774		19294297	143323		20837766	61690		22007700	89407	
19126029	61777		19294298	143316		20837766	G63959		22007701	83126	89430
19132275	143057		19294299	143061		20862317	G64040		22007701	89430	
19132276	143058		19294301	143063		20906289	G64121		22007703	83303	
19132277	143059		19294302	143064		20908412	G64148		22007750	83207	89407
19132279	143061		19294330	G57048		20908414	G64148		22007750	89407	
19132376	143072		19294331	G57047		20908415	G64148		22007751	83303	
19132377	143073		19294349	81930		20909154	G52127		22007753	83303	
19152843	83136		19295551	81318		20909155	G52128		22012065	85304	
19152953	G57070		19295552	81873		20929418	70059		22012067	85700	
19153639	G63884		19295553	81920		20930989	G63882		22012082	85702	
19153641	G51850		19295555	81922		20930995	G63879		22012083	85711	
19158776	58930		19295556	81924		20944661	G51982		22012083GS	85711	
19158788	61675		19295557	81925		20955404	61690		22012090	85308	89422
19158789	77953		19295558	69587		20955404	G63959		22012090	89422	
19167562	81039		19295559	69589		20955406	77975		22012091	85303	89422
19167562	G63355		19299843	49228		20955406	G64101		22012091	89422	
19168179	61641		19299843	49255		20955408	77975		22012095	83126	89430
19168179	G63783		19300025	49228		20955408	G64101		22012095	89430	
19168458	61643		19300034	49228		20955413	61690		22012096	83221	
19168458	G63803		19300035	49228		20955413	G63959		22012114	85700	
19171474	143089		19300057	58803		20955414	61690		22012131	85711	
19172175	6850SE		19300057	61643		20955414	G63959		22012166	83126	89430
19172178	6853SE		19300057	77803		20955415	61690		22012166	89430	
19177785	G51718		19300057	G63803		20955415	G63959		22012169	83221	
19203623	G51746		19307628	70031		20955417	61690		22012196	83221	
19203641	61687		19324428	G57048		20955417	G63959		22017530	83303	
19208029	G52116		19324429	G57047		20955422	61690		22017531	83303	
19208306	G52127		19324431	49255		20955422	G63959		22024061	85704	
19208307	G52128		19325299	70059		20955425	61690		22025067	85704	
19235148	61683		19359124	G511030		20955425	G63959		22025305	85704	
19235151	61690		19368462	49235		20955427	G63959		22045526	85702	
19241354	61684		19368462	61675		20955486	G51870		22046430	81492	
19241355	61685		19368462	G63866		20955487	G51870		22046476	69714	
19241356	49254		19402811	83397		20955495	G51870		22046481	85702	
19241357	61717		19403619	83397		20955497	G51870		22046483	85304	
19241358	61718		19403620	83397		20955498	G51870		22046489	85303	89422
19241359	69590		19404855	83135		20955500	G51870		22046489	89422	
19257307	G63894		19407869	83397		20955506	G51870		2204683	85304	
19257308	G63893		19407870	83398		20955513	G51891		22052014	85702	
19257309	G63894		19407871	83397		20955514	G51870		22052336	85304	
19257310	G63895		19407873	83398		20956372	G63896		22064009	69715	
19257311	G63893		19408176	85670		20956377	61687		22064013	61524	
19293025	143281		20757505	G64040		20956377	G63897		22064013	G63349	
19294074	142245		20759948	49228		20956378	G63896		22064019	61524	
19294075	142249		20759949	49228		20956379	61687		22064019	G63349	
19294076	142245		20760400	G64040		20956379	G63897		22064034	69715	
19294098	142526		20765171	G51870		20956380	61687		22064099	69715	
19294099	142526		20765189	G51870		20956380	G63897		22064102	G56718	
19294102	142530		20765189	G57000		20958798	G51891		22064226	61524	
19294112	143073		20765189	G57023		20958799	G51891		22064226	G63349	
19294113	143074		20784307	G64040		20982300	G51982		22064229	69811	
19294124	143058		20808505	G64140		22002293	83126	89430	22064230	83136	
19294124	143059		20832848	G64040		22002293	89430		22064232	85071	
19294294	143094		20832849	G64040		22002295	83303		22064233	83136	
19294296	143425		20833776	G63959		22007700	83207	89407	22064417	61544	

Important Note: Competitive Interchanges are to be used for stocking purposes only. Where multiple crosses are identified, please reference the applications section of this catalog. / **Remarque importante:** Les interchanges concurrentiels ne s'utilisent qu'aux fins de stocks. Dans le cas de références multiples, consulter la section des applications du catalogue. / **Nota importante:** Dans le cas de références multiples, consulter la section des applications du catalogue. / **Nota importante:** Se pueden usar intercambios competitivos para propósitos de almacenamiento solamente. Cuando se identifican intercambios múltiples, consulte la sección de aplicaciones de este catálogo.

COMPETITIVE & O.E.M. INTERCHANGE LIST
Lista de Intercambios contra Competidores y Equipo Original.
Liste dinterchange de produits comptitifs & dquipement original (OEM)

General Motors... cont'd

General motors	Gabriel	Upgrade	General motors	Gabriel	Upgrade	General motors	Gabriel	Upgrade	General motors	Gabriel	Upgrade
22064417	G63489		22716376	143355		23124580	G63959		23338792	G57000	
22064432	83221		22716378	143354		23124581	61690		23338792	G57023	
22064445	81750		22716378	143355		23124581	G63959		23338796	G57000	
22064445	G63421		22737714	G52280		23124582	61690		23338796	G57023	
22064573	G55825		22737715	G52281		23124582	G63959		23338800	G57000	
22064619	61539		22737716	G52280		23124583	61690		23338800	G57023	
22064619	G63454		22737717	G52281		23124583	G63959		23338819	G57000	
22064635	58609		22737724	G51916		23124584	61690		23338819	G57023	
22064635	61542		22761744	69589		23124584	G63959		23338824	G57000	
22064635	77609		22761744	69590		23124585	61690		23338824	G57023	
22064635	G63609		22769872	G57060		23124585	G63959		23338831	G57000	
22064684	58609		22769873	G57060		23124591	G51949		23338831	G57023	
22064684	61542		22773347	G64140		23124594	G51949		23338839	G57000	
22064684	77609		22796281	G55949		23124595	G51949		23338839	G57023	
22064684	G63609		22796872	G55948		23124596	G51949		23338844	G57000	
22064776	G55698		22796873	G55948		23124598	G51949		23338844	G57023	
22064781	G56509		22809066	G51916		23130121	G51949		23338863	G57000	
22064804	83136		22811082	G57069		23130122	G51949		23338863	G57023	
22064805	83136		22811844	77975		23147603	G64040		23338867	G57000	
22064806	83136		22811844	G64101		23147604	G64040		23338867	G57023	
22064807	83136		22811853	G51891		23156080	G57000		23338871	G57000	
22064829	61543		22811854	G51891		23156080	G57023		23338871	G57023	
22064829	G63488		22830632	G57000		23156081	G51949		23338875	G57000	
22064830	58609		22830632	G57023		23156082	G57000		23338875	G57023	
22064830	61542		22862538	G52128		23156082	G57023		23390197	G52278	
22064830	61544		22865484	G64140		23156090	61690		23390198	G52279	
22064830	77609		22872085	G52127		23156090	G63959		23390201	G52278	
22064830	G63489		22872086	G52128		23156091	61690		23425607	G57000	
22064830	G63609		22891309	G57000		23156091	G63959		23425607	G57023	
22064845	49213		22891309	G57023		23163342	G52279		23452955	77975	
22064855	61531		22891310	G57000		23179308	G57000		23452955	G64101	
22064858	49213		22891310	G57023		23179308	G57023		23452959	G57000	
22064858	61528		22891328	61690		23183580	77975		23452959	G57023	
22065218	G63347		22891328	G63959		23183580	G64101		23455253	70059	
22065228	69724		22896271	61690		23183849	77975		25805824	G52128	
22065228	81492		22896271	G63959		23183849	G64101		25815074	143366	
22065251	85030	89440	22902421	G57109		23183850	G64101		25820699	G63842	
22065251	89440		22902430	G57109		23183864	G51949		25822945	G64040	
22165187	83136		22920115	143366		23183880	G57000		25831691	69590	
22165188	83136		22932447	70059		23183880	G57023		25856156	143366	
22165189	83136		22950375	G51982		23183892	G51949		25870984	61690	
22166442	83136		22969018	G52278		23216161	G63872		25870984	G63959	
22181548	69898		22969019	G52279		23218793	77975		25870986	61690	
22687770	143089		22986271	G63959		23218793	G64101		25870986	G63959	
22687774	143089		23106628	G51949		23269413	G55948		25870987	61690	
22687780	143089		23106629	G57000		23269413	G57060		25870987	G63959	
22695255	G63872		23106629	G57023		23269415	G55948		25870990	61690	
22696400	69587		23106631	61690		23269415	G57060		25870990	G63959	
22698911	G52026		23106631	G63959		23269416	G55949		25871019	61690	
22698912	G52027		23106632	G63959		23269417	G55949		25871019	G63959	
22707166	G56809		23106633	61690		23275425	G57000		25871023	61690	
22707167	G56809		23106633	G63959		23275425	G57023		25871023	G63959	
22712116	143354		23111833	143486		23276075	G57000		25871025	61690	
22712116	143355		23124579	61690		23276075	G57023		25871025	G63959	
22716372	G57070		23124579	G63959		23338789	G57000		25871036	61690	
22716376	143354		23124580	61690		23338789	G57023		25871036	G63959	

Important Note: Competitive Interchanges are to be used for stocking purposes only. Where multiple crosses are identified, please reference the applications section of this catalog. / **Remarque importante:** Les interchanges concurrentiels ne s'utilisent qu'aux fins de stocks. Dans le cas de rfrences multiples, consulter la section des applications du catalogue. / **Nota importante:** Dans le cas de rfrences multiples, consulter la section des applications du catalogue. / **Nota importante:** Se pueden usar intercambios competitivos para propósitos de almacenamiento solamente. Cuando se identifican intercambios múltiples, consulte la sección de aplicaciones de este catálogo.

COMPETITIVE & O.E.M. INTERCHANGE LIST
Lista de Intercambios contra Competidores y Equipo Original.
Liste d'interchange de produits complitifs & d'equipement original (OEM)

General Motors... cont'd

General motors	Gabriel	Upgrade	General motors	Gabriel	Upgrade	General motors	Gabriel	Upgrade	General motors	Gabriel	Upgrade
25871225	49235		37301-0021	85026		4975549	83216		5531435	85307	
25871225	61675		37301-3202	85026		4975550	85702		5531436	85307	
25871225	G63866		373010016	85026		4975552	85711		5531437	85307	
25871229	49235		373010021	85026		4984526	83216		5532026	85304	
25871229	61675		373013202	85026		4993599	6804SE		5532425	83207	89407
25871229	G63866		3989717C1	83135		507-16	85702		5532425	89407	
25874561	143366		4089293C1	83397		507-19	85700		5532433	83207	89407
25875709	142526		4109458C2	83243		507-3	85307		5532433	89407	
25948611	43181		4109582C1	83397		50716	85702		5532675	85307	
25978183	G64040		4109583C1	83397		50719	85700		5533699	85302	89420
25980102	G51870		4206863C1	83398		5073	85307		5533699	89420	
25984611	61600		4207304C1	83397		508-86	83136		5534430	85303	89422
25984613	58412		4208946C1	83398		50886	83136		5534430	89422	
25984613	61642		4214011C2	85670		5171068	83216		5534439	85304	
25984613	77412		42417188	G52494		5304059	85700		5534447	85303	89422
3082284	83400		42417189	G52495		5316784	85700		5534447	89422	
3166657	85700		4939852	85308	89422	5316791	83219		5544060	85302	89420
3171068	83216		4939852	89422		5316792	85305		5544060	89420	
3171069	85304		4939967	85308	89422	5316793	85305		5544112	83216	
3171462	83126	89430	4939967	89422		5316794	85700		5544581	85302	89420
3171462	89430		4940600	83209	89414	5321920	85307		5544581	89420	
3171696	85307		4940600	89414		5321929	85307		5544716	85304	
3172948	85303	89422	4940601	83216		5348631	83203	89436	5544717	85304	
3172948	89422		4940606	83126	89430	5348631	89436		5544812	83308	
3178106	85700		4940606	89430		5352857	85700		5549899	83207	89407
3178157	85700		4940614	83216		5352858	85305		5549899	89407	
3178233	85734		4940627	83203	89436	5353054	85303	89422	5549924	85700	
3178507	85700		4940627	89436		5353054	89422		5549925	85304	
3178995	85700		4940640	83216		5355798	85307		5552111	85304	
3182842	85711		4940650	83207	89407	5357955	85300	89419	5552112	85307	
3188599	85711		4940650	89407		5357955	89419		5552114	83216	
3188626	85300	89419	4940654	83216		5357956	85734		5552206	83214	
3188626	89419		4940660	83207	89407	5357959	85300	89419	5552209	83215	
3188729	85303	89422	4940660	89407		5357959	89419		5552210	85308	89422
3188729	89422		4940662	83126	89430	5361994	85734		5552210	89422	
3189265	85700		4940662	89430		5374779	85308	89422	5552244	85308	89422
3192333	85700		4963844	85307		5374779	89422		5552244	89422	
3192416	85711		4963853	83216		5374999	85307		5552285	83214	
3192657	83216		4963854	83216		5385939	85307		5552451	85308	89422
3192890	83126	89430	4974401	85700		5392387	85303	89422	5552451	89422	
3192890	89430		4975429	85300	89419	5392387	89422		5552452	85303	89422
3192891	83221		4975429	89419		5394448	85305		5552452	89422	
3192892	83221		4975467	83207	89407	5394467	85305		5552453	85301	
35901-0001	83209	89414	4975467	89407		5455798	85307		5552454	85302	89420
35901-0001	89414		4975479	83400		5513489	83216		5552454	89420	
35901-0003	85301		4975480	83400		5513716	85304		5552456	85307	
35901-0004	83219		4975494	83207	89407	5516459	85305		5552552	85303	89422
35901-0005	83219		4975494	89407		5522794	85308	89422	5552552	89422	
35901-0017	83314		4975497	83126	89430	5522794	89422		5554184	85302	89420
359010001	83209	89414	4975497	89430		5522818	85305		5554184	89420	
359010001	89414		4975501	85700		5527001	85300	89419	5554589	85307	
359010003	85301		4975510	83221		5527001	89419		5554596	85303	89422
359010004	83219		4975511	83303		5527271	85700		5554596	89422	
359010005	83219		4975516	85702		5527272	85700		5554814	85302	89420
359010017	83314		4975518	85704		5527606	85305		5554814	89420	
37301-0016	85026		4975538	85700		5531027	85301		5554959	83401	

Important Note: Competitive Interchanges are to be used for stocking purposes only. Where multiple crosses are identified, please reference the applications section of this catalog. / **Remarque importante:** Les interchanges concurrentiels ne s'utilisent qu'aux fins de stocks. Dans le cas de références multiples, consulter la section des applications du catalogue. / **Nota importante:** Dans le cas de références multiples, consulter la section des applications du catalogue. / **Nota importante:** Se pueden usar intercambios competitivos para propósitos de almacenamiento solamente. Cuando se identifican intercambios múltiples, consulte la sección de aplicaciones de este catálogo.

COMPETITIVE & O.E.M. INTERCHANGE LIST
Lista de Intercambios contra Competidores y Equipo Original.
Liste dinterchange de produits comptitifs & dquipement original (OEM)

General Motors... cont'd

General motors	Gabriel	Upgrade	General motors	Gabriel	Upgrade	General motors	Gabriel	Upgrade	General motors	Gabriel	Upgrade
5554995	85305		88945194	69725		88946142	82039		88946621	49212	
5559363	83203	89436	88945205	69795		88946143	82040		88946622	43162	
5559363	89436		88945210	69811		88946145	82047		88946624	49213	
5585939	85307		88945324	34051		88946149	82051		88946627	49215	
684280	83209	89414	88945324	81494		88946155	82060		88946635	49218	
684280	89414		88945325	69715		88946164	82070		88946635	49228	
8-51630-666-0	85012	89413	88945344	61539		88946168	82075		88946637	49255	
8-51630-666-0	89413		88945344	G63454		88946169	82076		88946638	49230	
8-94057-593-0	83114		88945846	61500		88946171	82079		88946642	49231	
8-94454-986-0	83515		88945847	61501		88946176	82086		88946647	49235	
8-94454-987-0	83515		88945854	61508		88946177	82087		88946652	49304	
8-97083-029-0	83515		88945861	61516		88946182	82099		88946654	49311	
8-97201-960-0	83515		88945867	61522		88946188	82109		88946669	49334	
8-97253-620-0	83515		88945983	81039		88946189	82110		88946670	6801SE	
8-97253664-0	83159		88945986	81095		88946195	82118		88946671	6802SE	
8-97253665-0	83159		88945987	81096		88946198	82125		88946672	6803SE	
8-98380-746-0	83159		88945990	81113		88946205	82138		88946672	6804SE	
8-98380-747-0	83159		88945991	81164		88946210	82151		88947653	69625	
8-98381-010-0	83515		88945992	81147		88946214	82155		88955457	49228	
8-98381-012-0	83515		88945995	81242		88946215	82156		88955457	49255	
84043175	G57000		88945997	81270		88946216	82601		88955458	49228	
84043175	G57023		88945999	81340		88946217	82602		88955458	49255	
84043190	G57000		88946002	81394		88946223	82609		88955460	49228	
84043190	G57023		88946009	81510		88946231	82618		88955460	49255	
84043200	G57000		88946010	81082		88946316	142249		88955461	49228	
84043200	G57023		88946013	69675		88946326	143204		88955461	49255	
84043205	G57000		88946013	81446		88946421	142526		88959113	58357	
84043205	G57023		88946020	81478		88946426	142530		88959123	58403	
84059852	G57000		88946021	81482		88946443	142547		88959128	58412	
84059852	G57023		88946022	81481		88946452	142836		88959132	58421	
84061228	G57000		88946023	81490		88946547	14017		88959133	58422	
84061228	G57023		88946024	81494		88946548	14018		88959134	58423	
84082002	G57000		88946025	81492		88946552	14040		88959140	58488	
84082002	G57023		88946027	81495		88946553	34036		88959141	58489	
84082031	G57000		88946028	81496		88946554	34051		88959143	58609	
84082031	G57023		88946029	81484		88946556	34057		88959149	58638	
84129872	G64140		88946031	81507		88946558	34073		88959151	58662	
84176631	G57000		88946032	81514		88946561	43048		88959156	58714	
84176631	G57023		88946033	81516		88946562	43049		88959162	58901	
84192068	G64140		88946039	81540		88946564	43060		88959166	58803	
84303234	G63895		88946041	81548		88946564	49152		88959173	58817	
87-2520-00003	85704		88946042	81549		88946574	43111		88961944	69464	
87252000003	85704		88946044	81553		88946580	43162		88961947	81869	
88945169	69600		88946050	81559		88946581	43163		88962978	75676	
88945170	49334		88946051	81560		88946588	43180		88962985	77403	
88945170	69604		88946055	81582		88946589	43181		88962987	77375	
88945171	69606		88946059	81667		88946592	49107		88962995	77412	
88945172	69622		88946060	81668		88946595	49122		88962995	77783	
88945173	69624		88946065	81675		88946597	49128		88963000	77422	
88945174	69632		88946072	81713		88946598	49131		88963001	77423	
88945177	69675		88946083	81750		88946599	49135		88963004	77454	
88945178	69676		88946106	82003		88946603	49152		88963009	77488	
88945184	69715		88946113	82010		88946604	49155		88963010	77488	
88945185	69714		88946129	82026		88946605	49157		88963010	77489	
88945188	69724		88946137	82034		88946607	49162		88963017	77609	
88945188	81514		88946138	82035		88946618	49203		88963020	77638	

Important Note: Competitive Interchanges are to be used for stocking purposes only. Where multiple crosses are identified, please reference the applications section of this catalog. / **Remarque importante:** Les interchanges concurrentiels ne s'utilisent qu'aux fins de stocks. Dans le cas de rfrences multiples, consulter la section des applications du catalogue. / **Nota importante:** Dans le cas de rfrences multiples, consulter la section des applications du catalogue. / **Nota importante:** Se pueden usar intercambios competitivos para propósitos de almacenamiento solamente. Cuando se identifican intercambios múltiples, consulte la sección de aplicaciones de este catálogo.

COMPETITIVE & O.E.M. INTERCHANGE LIST
Lista de Intercambios contra Competidores y Equipo Original.
Liste d'interchange de produits complitifs & d'equipement original (OEM)

General Motors... cont'd

General motors	Gabriel	Upgrade	General motors	Gabriel	Upgrade	General motors	Gabriel	Upgrade	General motors	Gabriel	Upgrade
88963023	77662		88983816	77803		898098-1250	83515		95266855	G52494	
88963039	77783		88983818	49235		898098-1270	83515		95266856	G52495	
88963040	77803		88983818	61675		8980980580	83159		95266857	G52494	
88963046	77817		88983818	G63866		8980980581	83159		95271437	G511030	
88963054	77907		88985556	142561		8980980590	83159		95271438	G511030	
88963055	77909		88986629	61555		8980981250	83515		95387906	G511030	
88963949	69622		88986629	81713		8980981270	83515		95440469	G52495	
88963949	81880		88986629	G63375		8983807460	83159		95440470	G52494	
88964326	143323		89038500	61643		8983807470	83159		95440471	G52495	
88965467	G55948		89038500	G63803		8983810100	83515		95440472	G52494	
88965469	G55949		89038591	61642		8983810120	83515		95440473	G511030	
88966763	61504		89038595	58803		9-51630-647-1	83515		96980824	G57130	
88966765	61506		89038595	61641		9-51630-666-0	85012	89413	96980825	G57131	
88966771	61517		89038595	61643		9-51630-666-0	89413		96980826	G57130	
88966773	61519		89038595	77803		9-51630-666-2	85012	89413	96980827	G57131	
88966777	61524		89038595	G63783		9-51630-666-2	89413		97-2210-00156	85702	
88966778	61525		89038595	G63803		90251921	143459		97-2210-00164	85708	
88966780	61528		89038596	61690		92195484	G51916		97-2210-00170	85733	
88966782	61531		89038596	G63959		92195485	G51916		97083027	83515	
88966786	61535		89038597	58412		92213101	143461		97083029	83515	
88966787	61536		89038597	77412		92213102	143462		97201960	83515	
88966789	61539		89038652	58803		92233769	143462		97221000156	85702	
88966791	61541		89038652	58817		92244056	G52281		97221000164	85708	
88966792	61542		89038652	61663		92244057	G52280		97221000170	85733	
88966793	61543		89038652	77803		92244058	G52281		97253616	83515	
88966794	61544		89038652	77817		92244059	G52280		97253620	83515	
88966801	61555		89038652	G63817		94033786	83114		97253621	83515	
88966805	61560		89038654	43181		94051090	83114		97253623	83515	
88966809	61600		89038654	61600		94057593	83114		97253651	83159	
88966810	61565		89040176	G57000		94454987	83515		97253664	83159	
88966813	61575		89040176	G57023		94849261	143281		97253665	83159	
88966837	61615		89040177	61643		94849262	143281		98098058	83159	
88966838	61616		89040177	G63803		94854736	143281		98098059	83159	
88966850	61641		89060253	143363		94857922	143281		98098125	83515	
88966851	61642		8940575930	83114		94857975	G55999		98098127	83515	
88966852	61643		8944549860	83515		94857976	G55999		98232671	83515	
88966862	61659		8944549870	83515		94859874	G55662		98380746	83159	
88966866	61663		8970830290	83515		94859875	G55661		98380747	83159	
88966868	61664		8972019600	83515		95015324	143239		98381010	83515	
88966869	61605		8972536200	83515		9516306471	83515		98381012	83515	
88974638	G51736		8972536640	83159		9516306660	85012	89413	SG23086	61522	
88982682	83136		8972536650	83159		9516306660	89413		U0109-014	83400	
88982684	83136		898098-0580	83159		9516306662	85012	89413	U0109014	83400	
88982686	85071		898098-0581	83159		9516306662	89413				
88983816	58803		898098-0590	83159		95266854	G52495				

General Trailer Co.

General trailer co.	Gabriel	Upgrade	General trailer co.	Gabriel	Upgrade	General trailer co.	Gabriel	Upgrade	General trailer co.	Gabriel	Upgrade
120-1	83125		1201	83125		12608	83125				

Georgie Boy Manufacturing

Georgie boy manufacturing	Gabriel	Upgrade	Georgie boy manufacturing	Gabriel	Upgrade	Georgie boy manufacturing	Gabriel	Upgrade	Georgie boy manufacturing	Gabriel	Upgrade
10-12390-000	85920	89503	10-13211-000	89449		1012390000	85920	89503	1013211000	89449	
10-12390-000	89503		10-13634-000	85918	89449	1012390000	89503		1013634000	85918	89449
10-13021-000	85918	89449	10-13634-000	89449		1013021000	85918	89449	1013634000	89449	
10-13021-000	89449		10-13684-000	85918	89449	1013021000	89449				
10-13063-000	85918	89449	10-13684-000	89449		1013063000	85918	89449			
10-13063-000	89449		10-13760-000	85959		1013063000	89449				
10-13211-000	85918	89449	10-13809-000	85958		1013211000	85918	89449			

Important Note: Competitive Interchanges are to be used for stocking purposes only. Where multiple crosses are identified, please reference the applications section of this catalog. / **Remarque importante:** Les interchanges concurrentiels ne s'utilisent qu'aux fins de stocks. Dans le cas de références multiples, consulter la section des applications du catalogue. / **Nota importante:** Dans le cas de referencias multiples, consultar la sección de aplicaciones del catálogo. / **Nota importante:** Se pueden usar intercambios competitivos para propósitos de almacenamiento solamente. Cuando se identifican intercambios múltiples, consulte la sección de aplicaciones de este catálogo.

COMPETITIVE & O.E.M. INTERCHANGE LIST
Lista de Intercambios contra Competidores y Equipo Original.
Liste dinterchange de produits comptitifs & dquipement original (OEM)

Georgie Boy Manufacturing... cont'd

Georgie boy manufacturing	Gabriel	Upgrade	Georgie boy manufacturing	Gabriel	Upgrade	Georgie boy manufacturing	Gabriel	Upgrade	Georgie boy manufacturing	Gabriel	Upgrade
1013684000	85918	89449	481700006848	85724	89443	ASH-1154	G63622		ASH24658	85181	
1013684000	89449		481700006848	89443		ASH-1161	85006		ASH24659	85181	
1013760000	85959		4C4Z-18124-JB	85928		ASH-1162	85005	89430	ASH24660	85180	
1013809000	85958		4C4Z-18124-QA	83175		ASH-1162	89430		ASH24661	83317	
141700131809	85029		4C4Z-18124-RA	85928		ASH-1205	83209	89414	ASH25820	85005	89430
141700131810	83160		4C4Z-18125-B	83317		ASH-1205	89414		ASH25820	89430	
16-15817-000	85724	89443	4C4Z-18125-DA	85656		ASH-1206	83122	89406	ASH25821	85006	
16-15817-000	89443		4C4Z18124JB	85928		ASH-1206	89406		ASH25822	83209	89414
16-16736-000	85029		4C4Z18124QA	83175		ASH-1228	83209	89414	ASH25822	89414	
16-16737-000	83160		4C4Z18124RA	85928		ASH-1228	89414		ASH25823	83209	89414
16-16873-000	85029		4C4Z18125DA	85656		ASH-1229	83209	89414	ASH25823	89414	
16-16874-000	83160		501906C92	83317		ASH-1229	89414		ASH25824	83122	89406
16-18103-000	85900		66153-002	83124	89407	ASH-1230	83122	89406	ASH25824	89406	
16-18708-000	85724	89443	66153-002	89407		ASH-1230	89406		ASH294	83209	89414
16-18708-000	89443		66153002	83124	89407	ASH-137	83122	89406	ASH294	89414	
1615817000	85724	89443	66153002	89407		ASH-137	89406		AT-163G	G63622	
1615817000	89443		680611	85724	89443	ASH-24658	85181		AT-164G	G63623	
1616736000	85029		680611	89443		ASH-24659	85181		AT-620	83209	89414
1616737000	83160		8C24-18045-DA	G63622		ASH-24660	85180		AT-620	89414	
1616873000	85029		8C24-18080-DB	G63623		ASH-25820	85005	89430	AT-621	83122	89406
1616874000	83160		8C2418045DA	G63622		ASH-25820	89430		AT-621	89406	
1618103000	85900		8C2418080DB	G63623		ASH-25821	85006		AT-766	83209	89414
1618708000	85724	89443	8C2Z-18124-D	G63622		ASH-25822	83209	89414	AT-766	89414	
1618708000	89443		8C2Z-18125-D	G63623		ASH-25822	89414		AT-812	85928	
1C34-18045-AA	83209	89414	8C2Z18124D	G63622		ASH-25823	83209	89414	AT163G	G63622	
1C34-18045-AA	89414		8C2Z18125D	G63623		ASH-25823	89414		AT164G	G63623	
1C34-18045-JA	83209	89414	9U94-18045-AA	83209	89414	ASH-25824	83122	89406	AT620	83209	89414
1C34-18045-JA	89414		9U94-18045-AA	89414		ASH-25824	89406		AT620	89414	
1C3418045AA	83209	89414	9U94-18080-AA	83122	89406	ASH-294	83209	89414	AT621	83122	89406
1C3418045AA	89414		9U94-18080-AA	89406		ASH-294	89414		AT621	89406	
1C3418045JA	83209	89414	9U9418045AA	83209	89414	ASH1022	83209	89414	AT766	83209	89414
1C3418045JA	89414		9U9418045AA	89414		ASH1022	89414		AT766	89414	
22064230	83136		9U9418080AA	83122	89406	ASH1023	83122	89406	AT812	85928	
3578858C1	85656		9U9418080AA	89406		ASH1023	89406		F4-BE5-C832-MO	83124	89407
3578858C2	85656		9U9Z-18124-A	83209	89414	ASH1136	G63623		F4-BE5-C832-MO	89407	
3584116C1	83175		9U9Z-18124-A	89414		ASH1154	G63622		F4BE5C832MO	83124	89407
3584116C2	83175		9U9Z-18125-A	83122	89406	ASH1161	85006		F4BE5C832MO	89407	
3584118C2	85928		9U9Z-18125-A	89406		ASH1162	85005	89430	FC44-18045-BB	85181	
471700000449	85918	89449	9U9Z18124A	83209	89414	ASH1162	89430		FC44-18080-AB	85180	
471700000449	89449		9U9Z18124A	89414		ASH1205	83209	89414	FC4418045BB	85181	
471700002808	85724	89443	9U9Z18125A	83122	89406	ASH1205	89414		FC4418080AB	85180	
471700002808	89443		9U9Z18125A	89406		ASH1206	83122	89406	FC4Z-18124-A	85181	
471700002809	85724	89443	AA-616	83175		ASH1206	89406		FC4Z-18124-B	85181	
471700002809	89443		AA-617	85928		ASH1228	83209	89414	FC4Z-18125-A	85180	
471700002991	85959		AA616	83175		ASH1228	89414		FC4Z18124A	85181	
471700003920	85958		AA617	85928		ASH1229	83209	89414	FC4Z18124B	85181	
471700011530	85181		ASH-1022	83209	89414	ASH1229	89414		FC4Z18125A	85180	
471700011531	85180		ASH-1022	89414		ASH1230	83122	89406	SDA471700002809	85724	89443
471700131155	85918	89449	ASH-1023	83122	89406	ASH1230	89406		SDA471700002809	89443	
471700131155	89449		ASH-1023	89406		ASH137	83122	89406	SDA471700002991	85959	
481700000493	85900		ASH-1136	G63623		ASH137	89406		SDA471700003920	85958	

Gillig Bros.

Gillig bros.	Gabriel	Upgrade	Gillig bros.	Gabriel	Upgrade	Gillig bros.	Gabriel	Upgrade	Gillig bros.	Gabriel	Upgrade
1145291N000	85916	89430	200-171	85304		53-02133-000	85318		53-14010	85318	
1145291N000	89430		200171	85304		53-13952-000	85722		53-176	85304	
1583470	85051		53-02132	85723		53-14005-000	85723		53-24685	85723	

Important Note: Competitive Interchanges are to be used for stocking purposes only. Where multiple crosses are identified, please reference the applications section of this catalog. / **Remarque importante:** Les interchanges concurrentiels ne s'utilisent qu'aux fins de stocks. Dans le cas de rfrences multiples, consulter la section des applications du catalogue. / **Nota importante:** Dans le cas de rfrences multiples, consultar la section des aplicaciones du catalogue. / **Nota importante:** Se pueden usar intercambios competitivos para propósitos de almacenamiento solamente. Cuando se identifican intercambios múltiples, consulte la sección de aplicaciones de este catálogo.

COMPETITIVE & O.E.M. INTERCHANGE LIST
Lista de Intercambios contra Competidores y Equipo Original.
Liste dinterchange de produits comptitifs & dquipement original (OEM)

Gillig Bros.... cont'd

Gillig bros.	Gabriel	Upgrade	Gillig bros.	Gabriel	Upgrade	Gillig bros.	Gabriel	Upgrade	Gillig bros.	Gabriel	Upgrade
5302132	85723		695109	85723		90-1951-SP1	85734		901951SP1	85734	
5302133000	85318		695110	85318		90-1968	85712		901968	85712	
5313952000	85722		70034	85302	89420	90-2164 SP1	85723		902164 SP1	85723	
5314005000	85723		70034	89420		90-2423	85723		902423	85723	
5314010	85318		82-01878	83122	89406	90044046	83123	89405	9051024	85916	89430
53176	85304		82-01878	89406		90044046	89405		9051024	89430	
5324685	85723		82-21542-000	85716		90044683	83122	89406	90F-1912	85318	
57113	83219		82-30159-000	85708		90044683	89406		90F1912	85318	
57131	83216		8201878	83122	89406	90044769	83207	89407	H53-02132-14005	85723	
665568	85051		8201878	89406		90044769	89407		H53-20415-006	85051	
680009	85302	89420	8221542000	85716		90044770	83207	89407	H530213214005	85723	
680009	89420		8230159000	85708		90044770	89407		H5320415006	85051	
680333	85708		90-1908	85723		901908	85723		MR6394	85723	

Glaval Bus Co.

Glaval bus co.	Gabriel	Upgrade	Glaval bus co.	Gabriel	Upgrade	Glaval bus co.	Gabriel	Upgrade	Glaval bus co.	Gabriel	Upgrade
3578858C1	85656		4C4Z-18125-DA	85656		ASH-1154	G63622		FC44-18080-AB	85180	
3578858C2	85656		4C4Z18124JB	85928		ASH-24658	85181		FC4418045BB	85181	
3584116C1	83175		4C4Z18124QA	83175		ASH-24659	85181		FC4418080AB	85180	
3584116C2	83175		4C4Z18124RA	85928		ASH-24660	85180		FC4Z-18124-A	85181	
3584118C2	85928		4C4Z18125DA	85656		ASH24658	85181		FC4Z-18124-B	85181	
471700011530	85181		501906C92	83317		ASH24659	85181		FC4Z-18125-A	85180	
471700011531	85180		AA-616	83175		ASH24660	85180		FC4Z18124A	85181	
4C4Z-18124-JB	85928		AA-617	85928		ASH24661	83317		FC4Z18124B	85181	
4C4Z-18124-QA	83175		AA616	83175		AT-812	85928		FC4Z18125A	85180	
4C4Z-18124-RA	85928		AA617	85928		AT812	85928				
4C4Z-18125-B	83317		ASH-1136	G63623		FC44-18045-BB	85181				

GMC

Gmc	Gabriel	Upgrade	Gmc	Gabriel	Upgrade	Gmc	Gabriel	Upgrade	Gmc	Gabriel	Upgrade
1-51630-217-0	83114		22012065	85304		3166657	85700		4940606	89430	
1-51630-217-1	83114		22012090	85308	89422	3171068	83216		4940614	83216	
1-51630-219-1	83114		22012090	89422		3171069	85304		4963853	83216	
1202-0012	83023		22012091	85303	89422	3171462	83126	89430	4963854	83216	
1202-0032	83016		22012091	89422		3171462	89430		4975467	83207	89407
12020012	83023		22012095	83126	89430	3178106	85700		4975467	89407	
12020032	83016		22012095	89430		3178507	85700		4975494	83207	89407
12474915	83122	89406	22012096	83221		3178995	85700		4975494	89407	
12474915	89406		22012166	83126	89430	3182842	85711		4975497	83126	89430
15123676	83136		22012166	89430		3188599	85711		4975497	89430	
1516302170	83114		22012169	83221		3189265	85700		4975510	83221	
1516302171	83114		22012196	83221		3192333	85700		4975511	83303	
1516302191	83114		22017530	83303		3192416	85711		4975552	85711	
15174898	83136		22017531	83303		3192657	83216		4984526	83216	
15174902	85071		22046483	85304		3192890	83126	89430	5304059	85700	
15588554	83136		22052336	85304		3192890	89430		5316784	85700	
15887728	83136		22064230	83136		3192891	83221		5316794	85700	
15963161	83122	89406	22064232	85071		3192892	83221		5352857	85700	
15963161	89406		22064233	83136		35901-0005	83219		5527271	85700	
19152843	83136		22064432	83221		359010005	83219		5527272	85700	
22002293	83126	89430	22064804	83136		37301-0016	85026		5544060	85302	89420
22002293	89430		22064805	83136		37301-0021	85026		5544060	89420	
22002295	83303		22064806	83136		37301-3202	85026		5549924	85700	
22007701	83126	89430	22064807	83136		373010016	85026		5552451	85308	89422
22007701	89430		22165187	83136		373010021	85026		5552451	89422	
22007750	83207	89407	22165188	83136		373013202	85026				
22007750	89407		22165189	83136		4940600	83209	89414			
22007751	83303		22166442	83136		4940600	89414				
22007753	83303		3082284	83400		4940606	83126	89430			

Important Note: Competitive Interchanges are to be used for stocking purposes only. Where multiple crosses are identified, please reference the applications section of this catalog. / **Remarque importante:** Les interchanges concurrentiels ne s'utilisent qu'aux fins de stocks. Dans le cas de rferences multiples, consulter la section des applications du catalogue. / **Nota importante:** Dans le cas de rferences multiples, consulter la section des applications du catalogue. / **Nota importante:** Se pueden usar intercambios competitivos para propósitos de almacenamiento solamente. Cuando se identifican intercambios múltiples, consulte la sección de aplicaciones de este catálogo.

COMPETITIVE & O.E.M. INTERCHANGE LIST
Lista de Intercambios contra Competidores y Equipo Original.
Liste dinterchange de produits comptitifs & dquipement original (OEM)

GMC... cont'd

Gmc	Gabriel	Upgrade	Gmc	Gabriel	Upgrade	Gmc	Gabriel	Upgrade	Gmc	Gabriel	Upgrade
5552452	85303	89422	88982686	85071		8980980580	83159		97253621	83515	
5552452	89422		8940575930	83114		8980980581	83159		97253623	83515	
5552454	85302	89420	8970830290	83515		8980980590	83159		97253651	83159	
5552454	89420		8972019600	83515		8980981250	83515		97253664	83159	
5552456	85307		8972536640	83159		8980981270	83515		97253665	83159	
8-94057-593-0	83114		8972536650	83159		94033786	83114		98098058	83159	
8-97083-029-0	83515		898098-0580	83159		94051090	83114		98098059	83159	
8-97201-960-0	83515		898098-0581	83159		94057593	83114		98098125	83515	
8-97253664-0	83159		898098-0590	83159		94454987	83515		98098127	83515	
8-97253665-0	83159		898098-1250	83515		97201960	83515				
88982682	83136		898098-1270	83515		97253616	83515				

Gold

Gold	Gabriel	Upgrade	Gold	Gabriel	Upgrade	Gold	Gabriel	Upgrade	Gold	Gabriel	Upgrade
5000736	83039		5000796	632147		5000880	85711		8160906	83147	
5000738	85071		5000797	85307		5000881	85736		8160907	85036	89405
5000740	83105		5000798	85712		8150240	83125		8160907	89405	
5000741	83136		5000799	85711		8150241	83207	89407	8160908	83019	
5000742	83308		5000800	85736		8150241	89407		8160909	83123	89405
5000743	83107		5000802	85341		8150242	83128	89436	8160909	89405	
5000744	85090		5000804	85308	89422	8150242	89436		8160910	83050	
5000745	83314		5000804	89422		8150243	83009		8160911	83041	
5000745	85013	89414	5000806	83027		8150371	83127		8160912	83001	
5000745	89414		5000807	85343		8150372	83137		8160935	83140	
5000747	83101		5000808	85916	89430	8160090	85000	89436	8160938	85062	89408
5000748	83135		5000808	89430		8160090	89436		8160938	89408	
5000749	85308	89422	5000809	83635		8160091	85006		8170098	85045	
5000749	89422		5000813	83221		8160098	83456	89447	8180050	85001	89410
5000750	83035		5000816	85956		8160098	89447		8180050	89410	
5000751	85055	89439	5000818	83120		8160099	83318		8180139	85936	89456
5000751	89439		5000822	83004		8160100	85052		8180139	89456	
5000754	83015		5000825	83225		8160101	85001	89410	8180171	85958	
5000758	85055	89439	5000826	85029		8160101	89410		8180172	85919	
5000758	89439		5000827	85908		8160102	83215		8180173	85954	
5000759	83142		5000828	83044		8160103	83312	89409	8190008	85320	89429
5000760	85934		5000830	83175		8160103	89409		8190008	89429	
5000761	85024		5000831	83024		8160111	85066	89448	8190076	85300	89419
5000762	83160		5000835	83150		8160111	89448		8190076	89419	
5000764	85957		5000839	83131		8160112	85061	89450	8190087	85738	
5000765	83216		5000840	83162		8160113	85931	89458	8190096	85729	
5000768	83401		5000844	83030		8160113	89458		8190097	85727	
5000773	85065		5000849	85054		8160114	85918	89449	9150063	83216	
5000776	85005	89430	5000850	83053		8160114	89449		9150639	83009	
5000776	89430		5000852	85376		8160115	85031		9160091	85006	
5000777	83143		5000853	83101		8160116	85012	89413	9160092	85043	
5000778	83054		5000855	83154		8160116	89413		9160093	83317	
5000781	85656		5000856	85978		8160118	85900		9160094	85003	89411
5000782	83017		5000857	85929		8160119	85902		9160094	89411	
5000783	83025		5000859	83031		8160120	85069	89455	9160095	85062	89408
5000784	85080		5000861	83025		8160120	89455		9160095	89408	
5000785	83216		5000862	83140		8160189	85937		9160096	85001	89410
5000786	83103		5000865	85910		8160195	85013	89414	9160096	89410	
5000787	85938		5000869	83216		8160195	85043		9160097	85001	89410
5000789	83110		5000870	83022		8160195	89414		9160097	89410	
5000790	83180		5000871	83164		8160522	83029				
5000791	83157		5000872	85082		8160523	83021				
5000792	83134		5000877	85722		8160848	85088				
5000793	83400		5000879	85970		8160849	83051				

Important Note: Competitive Interchanges are to be used for stocking purposes only. Where multiple crosses are identified, please reference the applications section of this catalog./ **Remarque importante:** Les interchanges concurrentiels ne s'utilisent qu'aux fins de stocks. Dans le cas de rferences multiples, consulter la section des applications du catalogue./ **Nota importante:** Dans le cas de rferences multiples, consulter la section des applications du catalogue./ **Nota importante:** Se pueden usar intercambios competitivos para propósitos de almacenamiento solamente. Cuando se identifican intercambios múltiples, consulte la sección de aplicaciones de este catálogo.

COMPETITIVE & O.E.M. INTERCHANGE LIST
Lista de Intercambios contra Competidores y Equipo Original.
Liste dinterchange de produits comptitifs & dquipement original (OEM)

Gold... cont'd

Gold	Gabriel	Upgrade	Gold	Gabriel	Upgrade	Gold	Gabriel	Upgrade	Gold	Gabriel	Upgrade
9160117	85320	89429	9160547	83001		9180137	85924	89457	9180186	89454	
9160117	89429		9160697	G63622		9180137	89457		9180187	85084	89460
9160121	85067	89451	9160761	G63461		9180138	85954		9180187	89460	
9160121	89451		9160789	G63866		9180140	85061	89450	9180188	85069	89455
9160190	85070	89459	9160820	83312	89409	9180142	85323	89436	9180188	89455	
9160190	89459		9160820	89409		9180142	89436		9180190	85072	
9160268	85058	89431	9160933	83209	89414	9180143	85918	89449	9180191	85053	89442
9160268	89431		9160933	89414		9180143	89449		9180191	89442	
9160470	83124	89407	9160934	83047		9180144	85303	89422	9180192	85026	
9160470	89407		9160936	83048		9180144	89422		9180193	85030	89440
9160488	83456	89447	9160972	83025		9180145	85067	89451	9180193	89440	
9160488	89447		9160976	83053		9180145	89451		9180194	85014	
9160493	83136		9160980	83135		9180146	85033	89427	9180195	83111	
9160498	83136		9160983	83112		9180146	89427		9180196	83122	89406
9160500	85000	89436	9170007	85918	89449	9180147	83136		9180196	89406	
9160500	89436		9170007	89449		9180148	85064		9180197	85046	89434
9160513	85029		9180126	85012	89413	9180149	85900		9180197	89434	
9160536	85005	89430	9180126	89413		9180151	85070	89459	9180198	85901	
9160536	89430		9180130	85005	89430	9180151	89459		9180199	85301	
9160538	85045		9180130	89430		9180152	85003	89411	9190007	85724	89443
9160539	83203	89436	9180131	85001	89410	9180152	89411		9190007	89443	
9160539	89436		9180131	89410		9180153	85931	89458	9450993	646155	
9160540	85052		9180134	85921		9180153	89458				
9160545	83154		9180136	83128	89436	9180184	83163				
9160546	83008		9180136	89436		9180186	85933	89454			

Goshen Coach

Goshen coach	Gabriel	Upgrade	Goshen coach	Gabriel	Upgrade	Goshen coach	Gabriel	Upgrade	Goshen coach	Gabriel	Upgrade
ASH-1136	G63623		ASH-1154	G63622		ASH1136	G63623		ASH1154	G63622	

Granning Suspension

Granning suspension	Gabriel	Upgrade	Granning suspension	Gabriel	Upgrade	Granning suspension	Gabriel	Upgrade	Granning suspension	Gabriel	Upgrade
1085	83214		17142-01	85001	89410	18164-01	89406		20960-01	83204	
12885-01	85300	89419	17142-01	89410		1816401	83122	89406	2096001	83204	
12885-01	89419		1714201	85001	89410	1816401	89406		21310-01	85307	
12885-03	85300	89419	1714201	89410		18165-01	85006		2131001	85307	
12885-03	89419		17146-01	83209	89414	1816501	85006		21497-01	85005	89430
1288501	85300	89419	17146-01	89414		18166-01	85704		21497-01	89430	
1288501	89419		1714601	83209	89414	1816601	85704		2149701	85005	89430
1288503	85300	89419	1714601	89414		18800-01	83203	89436	2149701	89430	
1288503	89419		17358-01	83126	89430	18800-01	89436		22062-01	85007	
12886-01	85334		17358-01	89430		1880001	83203	89436	2206201	85007	
1288601	85334		1735801	83126	89430	1880001	89436		23523-01	85086	
12887-01	85013	89414	1735801	89430		19495-01	83126	89430	2352301	85086	
12887-01	89414		17403-01	83122	89406	19495-01	89430		23524-01	85738	
12887-02	85013	89414	17403-01	89406		1949501	83126	89430	2352401	85738	
12887-02	89414		1740301	83122	89406	1949501	89430		23553-01	85938	
1288701	85013	89414	1740301	89406		19623-01	83123	89405	2355301	85938	
1288701	89414		17408-01	85005	89430	19623-01	89405		24392-01	85051	
1288702	85013	89414	17408-01	89430		1962301	83123	89405	2439201	85051	
1288702	89414		1740801	85005	89430	1962301	89405		2697	85712	
16230-01	85702		1740801	89430		19824-01	85006		665748	85086	
1623001	85702		17794-01	83215		1982401	85006		665813	85051	
16725-01	83126	89430	1779401	83215		20125-01	85030	89440	665830	85045	
16725-01	89430		18163-01	83207	89407	20125-01	89440		665833	85052	
1672501	83126	89430	18163-01	89407		2012501	85030	89440			
1672501	89430		1816301	83207	89407	2012501	89440				
16824-01	85006		1816301	89407		20129-01	85007				
1682401	85006		18164-01	83122	89406	2012901	85007				

Important Note: Competitive Interchanges are to be used for stocking purposes only. Where multiple crosses are identified, please reference the applications section of this catalog. / **Remarque importante:** Les interchanges concurrentiels ne s'utilisent qu'aux fins de stocks. Dans le cas de rferences multiples, consulter la section des applications du catalogue. / **Nota importante:** Dans le cas de rferences multiples, consulter la section des applications du catalogue. / **Nota importante:** Se pueden usar intercambios competitivos para propósitos de almacenamiento solamente. Cuando se identifican intercambios múltiples, consulte la sección de aplicaciones de este catálogo.

COMPETITIVE & O.E.M. INTERCHANGE LIST
Lista de Intercambios contra Competidores y Equipo Original.
Liste dinterchange de produits comptitifs & dquipement original (OEM)

Granning Suspension... cont'd

Granning suspension	Gabriel	Upgrade	Granning suspension	Gabriel	Upgrade	Granning suspension	Gabriel	Upgrade	Granning suspension	Gabriel	Upgrade
671707	85323	89436	680700	85938		70009803	85052		70213601	85052	
671707	89436		700098-01	83128	89436	701071-01	646155		702209-01	85014	
680162	85300	89419	700098-01	89436		701071-01	665937		70220901	85014	
680162	89419		700098-03	85052		702135-01	85045		704672-01	85938	
680551	85738		70009801	83128	89436	70213501	85045		70467201	85938	
680552	85938		70009801	89436		702136-01	85052		OE12425	83214	

Great Dane Trailer

Great dane trailer	Gabriel	Upgrade	Great dane trailer	Gabriel	Upgrade	Great dane trailer	Gabriel	Upgrade	Great dane trailer	Gabriel	Upgrade
18163-01	83207	89407	HENS-20001	83389	89436	HENS-24088	83389	89436	HENS23566	85000	89436
18163-01	89407		HENS-20001	89436		HENS-24088	85000	89436	HENS23566	89436	
1816301	83207	89407	HENS-20002	85000	89436	HENS-24088	89436		HENS23649	85064	
1816301	89407		HENS-20002	89436		HENS20001	83389	89436	HENS24088	83389	89436
18164-01	83122	89406	HENS-20126	85323	89436	HENS20001	89436		HENS24088	85000	89436
18164-01	89406		HENS-20126	89436		HENS20002	85000	89436	HENS24088	89436	
1816401	83122	89406	HENS-21292	85052		HENS20002	89436		MER202447	85919	
1816401	89406		HENS-23566	85000	89436	HENS20126	85323	89436	REY18165-01	85006	
18165-01	85006		HENS-23566	89436		HENS20126	89436		REY1816501	85006	
1816501	85006		HENS-23649	85064		HENS21292	85052				

Grech Motors

Grech motors	Gabriel	Upgrade	Grech motors	Gabriel	Upgrade	Grech motors	Gabriel	Upgrade	Grech motors	Gabriel	Upgrade
ASH-1136	G63623		ASH-1154	G63622							

GROB

Grob	Gabriel	Upgrade	Grob	Gabriel	Upgrade	Grob	Gabriel	Upgrade	Grob	Gabriel	Upgrade
1609001	69586		2709060	G64040		3009029	G51848		4009082	G56837	
1609003	69946		2709063	69590		3009030	G51863		4009083	G56836	
1909003	69863		2709067	G52494		3009031	G63967		4009091	G64157	
1909004	G52145		2709068	G52495		3009032	G64008		4009103	G51965	
1909005	G52144		2709069	G511030		3009033	G63966		4409002	G63862	
1909006	G64046		2709071	G64121		3009033	G63967		4409003	G64047	
1909007	G52199		2709072	77803		3009037	G511000		4709001	70003	
1909008	G52200		2709073	G52127		3009039	81926		4709002	69591	
1909009	70034		2709074	G52128		3009040	G63847		4709005	G52005	
2709001	69589		2709075	G52127		3009041	G64012		4709006	G52006	
2709001	69590		2709076	G52128		3009042	G56807		4709011	G52260	
2709008	G63882		2709077	G64015		3009062	G511038		4709012	G52261	
2709009	G51850		2709085	70204		4009001	G56839		4709014	G52256	
2709010	G63879		3009001	G63892		4009004	G51849		4709015	G52255	
2709011	G56773		3009002	G64016		4009005	G51849		4709016	70052	
2709012	G56774		3009005	G52081		4009015	G51861		4709017	G52209	
2709013	G64015		3009006	G52082		4009016	G51888		4709018	G52210	
2709019	G63875		3009007	G51842		4009018	G63867		4709019	G64056	
2709026	G63884		3009008	G52155		4009019	G63775		4709033	70207	
2709031	G56886		3009009	G52154		4009020	G51703		5009001	G51738	
2709032	G56887		3009010	70036		4009021	G63870		5009005	G51807	
2709034	G56810		3009011	G64012		4009025	G63969		5009006	G52283	
2709035	G56810		3009012	G56807		4009027	G64063		5009007	G52282	
2709036	69587		3009013	G63961		4009029	69592		5009008	70060	
2709042	G52025		3009014	G63958		4009030	G56817		5009009	G52187	
2709043	G63879		3009018	G51815		4009031	G64037		5009010	G52188	
2709044	G51870		3009019	G51947		4009032	G56841		5009011	G51879	
2709045	G63959		3009020	G51948		4009033	G56840		5009012	G56799	
2709047	G63965		3009021	G51721		4009035	G64079		5009013	G56800	
2709049	81496		3009024	77948		4009044	G52256		5009017	70010	
2709051	70039		3009025	G64042		4009045	G52255				
2709055	G51971		3009026	G52131		4009058	G511002				
2709058	G52125		3009027	G52148		4009058	G511135				
2709059	G64040		3009028	G52149		4009067	G51980				

Important Note: Competitive Interchanges are to be used for stocking purposes only. Where multiple crosses are identified, please reference the applications section of this catalog. / **Remarque importante:** Les interchanges concurrentiels ne s'utilisent qu'aux fins de stocks. Dans le cas de rfrences multiples, consulter la section des applications du catalogue. / **Nota importante:** Dans le cas de rfrences multiples, consulter la section des applications du catalogue. / **Nota importante:** Se pueden usar intercambios competitivos para propósitos de almacenamiento solamente. Cuando se identifican intercambios múltiples, consulte la sección de aplicaciones de este catálogo.

COMPETITIVE & O.E.M. INTERCHANGE LIST
Lista de Intercambios contra Competidores y Equipo Original.
Liste dinterchange de produits comptitifs & dquipement original (OEM)

GROB... cont'd

Grob	Gabriel	Upgrade	Grob	Gabriel	Upgrade	Grob	Gabriel	Upgrade	Grob	Gabriel	Upgrade
5009018	G51878		6709038	G63902		8709050	G52108		G5100	61600	
5009019	G51877		6709039	G63907		8709051	G52245		G5101	G63674	
5009020	G51892		6709040	G51766		8709052	G52246		G5104	G63424	
5009024	G52254		6709044	G52122		8709053	G51898		G5105	G63683	
5009025	G52253		6709045	G52121		8709162	G64186		G5106	G63690	
5009028	G51858		6709046	G51874		9009005	70056		G5107	G63622	
5009029	G56800		6709054	G51990		9309003	G51799		G5115	61646	
5009030	G56799		6709057	G52382		9309004	G56899		G5123	G63818	
5009039	G52112		6709058	G52383		9309011	G51993		G5124	61531	
5009052	G511092		6709059	G51802		9309012	G52301		G5127	61508	
5309003	G52439		6709060	G52171		9309016	G56899		G5130	G63799	
5309004	G52440		6709061	G52170		9609001	G52295		G5131	G63842	
5609000	G63611		6709062	G51884		9609003	G52274		G5133	G63609	
5609001	G63710		6709065	G511044		9609004	G52275		G5168	G63803	
5909000	70209		8409001	G52184		9609005	70040		G5169	G63817	
5909001	70203		8409002	G52185		9609006	G56802		G5170	G63454	
5909003	G64216		8409003	G64052		G0010	G51728		G5172	G63862	
5909006	70208		8409004	G56887		G0011	G63844		G5174	G63489	
6109001	G64089		8409005	G56886		G0067	G63860		G5182	G63678	
6109005	G64089		8409007	G56886		G1348	G51838		G5183	G63679	
6109007	G63918		8709007	G52103		G2003	82126		G5184	G63714	
6109008	G56778		8709008	G52104		G2025	69600		G5185	G63714	
6409001	G51794		8709009	G55661		G2036	82125		G5187	61613	
6409002	G56894		8709010	G55662		G2154	69465		G5188	G63772	
6409013	G51908		8709011	G55999		G2182	69604		G5189	G63773	
6409014	G52300		8709012	G55999		G2201	69676		G5190	G63622	
6409015	G52299		8709013	G51736		G2209	G55901		G5193	G63425	
6409019	G51883		8709014	G56660		G2210	G63903		G5194	G63676	
6409022	G52300		8709015	G56661		G2221	69632		G5195	G63905	
6409023	G52299		8709020	G63832		G2276	81446		G5195	G63915	
6409025	G52293		8709021	G63828		G2277	69606		G5196	G63403	
6409026	G52294		8709022	G51805		G2286	69898		G5196	G63890	
6409027	G51933		8709023	G52106		G2295	G55825		G5197	G63965	
6709000	G51715		8709024	G52106		G2370	G51087		G5200	61675	
6709001	G63883		8709025	G63689		G2395	69464		G5206	61641	
6709003	G56671		8709026	61606		G2419	G63492		G5213	61655	
6709004	G56672		8709027	G51783		G2430	69945		G5222	G63915	
6709006	G63845		8709028	G56843		G2438	G63776		G5227	61509	
6709007	G56687		8709029	G56842		G2496	G51704		G5227	81870	
6709008	G56688		8709030	G52007		G2498	69473		G5232	81744	
6709009	G51802		8709031	G52004		G3001	G63423		G5234	G63492	
6709013	G51803		8709032	G64026		G3295	G51783		G5235	G63299	
6709014	G52033		8709032	G64151		G4439	G51798		G5236	G63813	
6709015	G52032		8709036	G52204		G5013	61629		G5237	G63714	
6709016	70041		8709037	G52203		G5021	G63848		G5237	G63716	
6709019	G52094		8709038	G52202		G5034	G63366		G5238	61638	
6709020	G52095		8709039	G52201		G5053	G63414		G5239	G63414	
6709021	70027		8709040	G52204		G5054	G63888		G5837	G63837	
6709025	G52173		8709041	G52203		G5059	G63494		G5838	G63809	
6709026	G52174		8709042	G51937		G5091	G63489		GP010	G56581	
6709027	G64050		8709044	G51739		G5092	G63488		GP011	G56582	
6709033	G64033		8709045	G64006		G5092	G63896		GP019	G51718	
6709034	G51765		8709046	G52106		G5093	61675		GP026	G56758	
6709035	69594		8709047	G52105		G5096	61531		GP027	G56759	
6709036	69595		8709048	G511007		G5097	61528		GP046	G51739	
6709037	81147		8709049	G52107		G5099	61523		GP047	G63885	

Important Note: Competitive Interchanges are to be used for stocking purposes only. Where multiple crosses are identified, please reference the applications section of this catalog. / **Remarque importante:** Les interchanges concurrentiels ne s'utilisent qu'aux fins de stocks. Dans le cas de références multiples, consulter la section des applications du catalogue. / **Nota importante:** Dans le cas de références multiples, consulter la section des applications du catalogue. / **Nota importante:** Se pueden usar intercambios competitivos para propósitos de almacenamiento solamente. Cuando se identifican intercambios múltiples, consulte la sección de aplicaciones de este catálogo.

COMPETITIVE & O.E.M. INTERCHANGE LIST
Lista de Intercambios contra Competidores y Equipo Original.
Liste dinterchange de produits comptitifs & dquipement original (OEM)

GROB... cont'd

Grob	Gabriel	Upgrade	Grob	Gabriel	Upgrade	Grob	Gabriel	Upgrade	Grob	Gabriel	Upgrade
GP122	G55698		GP237	G56581		GP299	G56568		GP402	G56722	
GP169	G55910		GP237	G56582		GP300	G56601		GP403	G56721	
GP172	G55856		GP241	G56606		GP305	G55901		GP404	G56729	
GP209	G51267		GP259	G55892		GP308	G56620		GP405	G56728	
GP210	G51268		GP259	G55896		GP380	G52009		GP418	G51700	
GP215	G55856		GP264	G56517		GP381	G52008		GP461	G51727	
GP225	G55697		GP265	G56516		GP390	G56622		GP465	G51727	
GP226	14039		GP274	G55948		GP391	G56621				

Grupo A

Grupo a	Gabriel	Upgrade	Grupo a	Gabriel	Upgrade	Grupo a	Gabriel	Upgrade	Grupo a	Gabriel	Upgrade
15055	14004		43125	61520		53023	61528		53091	83159	
15067	14004		43125	81490		53023	81482		53195	G63183	
15500	6802SE		43132	61554		53024	85005	89430	53271	G63673	
15501	6804SE		43132	81710		53025	61521		53272	G63662	
15502	6804SE		43133	61554		53025	81394		53273	G63674	
15504	14071		43133	81710		53026	85005	89430	53274	G63675	
15504	6801SE		43134	G63909		53028	G63489		53275	G63661	
164023	43140		43139	83021		53029	61544		53276	81873	
164028	43049		43145	83021		53029	81668		53337	61544	
39155	49155		43154	69632		53032	81495		53337	81668	
39205	49205		43156	G63907		53035	G63488		53338	82003	
39218	49231		43158	G63183		53036	81091		53341	61521	
39569	49369		43171	82090		53037	61565		53341	81394	
43003	61524		43172	81469		53039	85006		53400	61523	
43003	81164		43236	61524		53040	85006		53400	81096	
43004	G63366		43236	81164		53041	85310	89423	53401	81091	
43014	81340		43381	61521		53041	89423		53402	G63360	
43019	81492		43381	81394		53042	83309		58003	61524	
43025	61519		43387	81076		53043	83215		58003	81164	
43025	81484		43440	82130		53044	83124	89407	58004	G63366	
43026	61550		43455	61501		53051	61520		58012	85314	89425
43026	81676		43455	81478		53051	81490		58012	89425	
43031	69724		43511	81091		53052	61530		58034	85013	89414
43040	61626		43512	81091		53052	81510		58034	89414	
43045	61501		43725	82005		53053	G63386		58035	58488	
43045	81478		43728	82001		53057	G63359		58035	61543	
43046	61500		43731	61614		53058	G63353		58035	81667	
43046	81147		43731	81821		53059	85051		58038	85001	89410
43053	81446		43734	82005		53060	81935		58038	89410	
43054	81495		43736	82001		53061	G63413		58040	85026	
43055	81494		53002	81446		53063	83025		58041	83456	89447
43057	G55825		53004	G63366		53065	83136		58041	89447	
43059	61500		53008	G63929		53066	83124	89407	58048	83137	
43059	81147		53009	G63624		53066	89407		58049	85000	89436
43060	69464		53010	83136		53068	G51850		58049	85323	89436
43066	83309		53013	85071		53069	81710		58049	89436	
43069	81710		53016	G63773		53070	61520		58050	85061	89450
43070	61520		53017	G63772		53070	81490		58050	89450	
43070	81490		53018	83317		53070	81913		58054	61530	
43098	69945		53019	83456	89447	53071	61519		58054	81510	
43119	61600		53019	89447		53071	81484		58055	85003	89411
43120	61641		53020	61521		53072	81925		58055	89411	
43121	81920		53020	81394		53073	81930		58056	83137	
43122	61600		53020	81744		53081	83159				
43122	81873		53021	G63623		53082	83515				
43124	61500		53022	61504		53083	83159				
43124	81147		53022	81750		53084	83515				

Important Note: Competitive Interchanges are to be used for stocking purposes only. Where multiple crosses are identified, please reference the applications section of this catalog./ **Remarque importante:** Les interchanges concurrentiels ne s'utilisent qu'aux fins de stocks. Dans le cas de rfrences multiples, consulter la section des applications du catalogue./ **Nota importante:** Dans le cas de rfrences multiples, consulter la section des applications du catalogue./ **Nota importante:** Se pueden usar intercambios competitivos para propósitos de almacenamiento solamente. Cuando se identifican intercambios múltiples, consulte la sección de aplicaciones de este catálogo.

COMPETITIVE & O.E.M. INTERCHANGE LIST
Lista de Intercambios contra Competidores y Equipo Original.
Liste dinterchange de produits comptitifs & dquipement original (OEM)

Grupo A... cont'd

Grupo a	Gabriel	Upgrade	Grupo a	Gabriel	Upgrade	Grupo a	Gabriel	Upgrade	Grupo a	Gabriel	Upgrade
58057	83456	89447	69080	81318		69247	70098		69510	61520	
58057	89447		69081	G63712		69248	70003		69511	G63299	
58058	85031		69084	G51815		69253	G511078		69513	61626	
58059	85005	89430	69085	G63890		69300	G63349		69515	83124	89407
58059	89430		69086	G63890		69309	58929		69515	89407	
58061	83122	89406	69088	69595		69309	61520		69516	G63423	
58061	85916	89430	69089	69594		69309	61561		69517	61528	
58061	89406		69090	G64031		69309	81490		69519	61599	
58064	85070	89459	69091	G51799		69309	81744		69520	61544	
58069	61547		69092	69813		69310	61533		69521	61543	
58069	81082		69093	69450		69310	81490		69522	G63638	
58070	61520		69098	69946		69310	81744		69523	61544	
58070	81490		69100	61593		69312	81492		69532	G63884	
58178	61500		69100	81872		69321	61500		69534	G51815	
58178	81147		69101	G55821		69321	81147		69535	G63891	
58337	58489		69104	G63889		69322	81446		69536	G51815	
58337	61544		69107	70003		69323	69606		69537	G63844	
58337	81668		69108	G64003		69323	81495		69538	61683	
58341	61521		69109	70036		69326	61500		69539	61684	
58341	81394		69110	G51805		69326	81147		69541	G63867	
58400	G63359		69114	70027		69330	81710		69544	G63622	
58401	G63353		69115	70041		69334	82156		69545	61595	
69010	69898		69116	G51783		69338	69632		69546	61591	
69011	61600		69117	G63902		69346	81091		69547	61533	
69012	61641		69119	G51738		69347	G63355		69548	61520	
69013	61641		69123	69591		69355	61523		69548	61561	
69013	81920		69124	69589		69355	81096		69548	81490	
69014	61600		69125	69590		69355	81834		69548	81744	
69014	81873		69126	69587		69357	81091		69549	58929	
69015	69464		69127	G51879		69361	61614		69549	61591	
69017	G63409		69129	G511004		69369	81147		69550	61518	
69018	G63414		69131	G51874		69370	81478		69550	61595	
69023	69473		69132	G51983		69376	81478		69550	81242	
69024	61500		69133	G51990		69379	69632		69554	61554	
69024	81478		69134	G51721		69381	61500		69555	G63714	
69025	61501		69135	69592		69381	81147		69556	G63778	
69025	81147		69136	70095		69382	81342		69557	G63662	
69031	61528		69137	G51898		69383	61632		69563	61634	
69034	69909		69146	G51971		69383	81825		69582	G63848	
69036	69900		69147	G51848		69389	69845		69583	61692	
69038	G51700		69150	G64056		69391	81916		69584	G64012	
69040	61506		69151	G63872		69392	81917		69585	61720	
69040	81318		69152	70052		69395	61520		69587	61710	
69041	61662		69153	G511030		69395	81490		69588	G63971	
69042	61662		69155	G51863		69396	61547		69590	61615	
69043	61506		69159	G63907		69396	81082		69591	61616	
69043	81318		69160	G64050		69500	83122	89406	69592	61714	
69044	69465		69164	G511007		69500	89406		69593	61654	
69045	G51736		69170	G64050		69501	61543		69594	61713	
69046	G63845		69171	G51807		69502	G63424		69601	61554	
69048	G63909		69172	G511044		69503	61544		69605	G64015	
69048	G64001		69175	69464		69504	G63425		69610	G63915	
69049	G63965		69177	G51905		69505	61506		69611	G63403	
69077	G63813		69179	G51892		69506	61523		69612	61535	
69078	G63492		69180	G511002		69507	G63353		69613	G63683	
69080	61506		69226	69945		69509	61554		69615	G63678	

Important Note: Competitive Interchanges are to be used for stocking purposes only. Where multiple crosses are identified, please reference the applications section of this catalog. / **Remarque importante:** Les interchanges concurrentiels ne s'utilisent qu'aux fins de stocks. Dans le cas de références multiples, consulter la section des applications du catalogue. / **Nota importante:** Dans le cas de références multiples, consulter la section des applications du catalogue. / **Nota importante:** Se pueden usar intercambios competitivos para propósitos de almacenamiento solamente. Cuando se identifican intercambios múltiples, consulte la sección de aplicaciones de este catálogo.

COMPETITIVE & O.E.M. INTERCHANGE LIST
Lista de Intercambios contra Competidores y Equipo Original.
Liste d'interchange de produits compititifs & d'equipement original (OEM)

Grupo A... cont'd

Grupo a	Gabriel	Upgrade	Grupo a	Gabriel	Upgrade	Grupo a	Gabriel	Upgrade	Grupo a	Gabriel	Upgrade
69616	G63607		69743	85061	89450	78023	89447		79196	G56887	
69622	61642		69743	89450		78025	85009		79201	G52185	
69623	61635		69745	85058	89431	78027	85314	89425	79202	G52184	
69651	G63488		69745	89431		78027	89425		79203	G51859	
69653	58488		69746	83137		78030	85316	89426	79204	G51859	
69654	61659		69747	85003	89411	78030	89426		79207	G56810	
69656	61512		69747	89411		78034	85920	89503	79208	G56810	
69657	61658		69748	85001	89410	78039	85311	89424	79210	G56773	
69658	61504		69748	89410		78039	89424		79211	G56774	
69660	G51728		69750	85314	89425	79053	G56606		79217	G52300	
69661	G63844		69750	89425		79059	G51268		79218	G52299	
69663	61555		69752	85316	89426	79060	G51267		79219	G52082	
69664	61565		69752	89426		79061	G56517		79220	G52081	
69666	61655		69753	85031		79062	G56516		79221	G51842	
69668	G63918		69760	85924	89457	79064	G55948		79222	G52122	
69669	83123	89405	69762	85931	89458	79065	G55949		79227	G52104	
69669	85010		69963	G55681		79070	G55892		79228	G52103	
69669	89405		72001	G63870		79077	G55896		79229	G51723	
69670	85051		72004	G64026		79078	G55949		79230	G51724	
69671	85006		72005	G51798		79092	G56568		79231	G56838	
69672	85043		72006	G64003		79093	G56601		79232	G56839	
69673	83209	89414	72007	G64063		79096	G56799		79233	G56807	
69673	89414		72008	G64052		79097	G56800		79234	G56817	
69678	G63674		72009	G64089		79098	G56660		79245	G52006	
69679	G63675		72020	G64043		79099	G56661		79246	G52005	
69680	89402		72022	G63959		79103	G56778		79249	G51761	
69685	83136		72026	G63902		79117	G56620		79250	G51760	
69688	85302	89420	72027	G51766		79128	G56672		79253	G52354	
69688	89420		72028	G64063		79129	G56671		79254	G52353	
69692	61663		72029	G64031		79132	G56778		79259L	G52245	
69693	61675		72030	G63959		79141	G51739		79259R	G52246	
69696	G63862		72033	G63614		79143	G56899		79264	G51908	
69697	G63676		72037	G64157		79148	G51097		79271	G51870	
69699	G63907		72038	G64040		79153	G52005		79276L	G52148	
69705	83122	89406	72039	G63886		79154	G52006		79276R	G52149	
69705	89406		72040	G64104		79162	G52155		79277L	G52210	
69711	83207	89407	72049	G64037		79163	G52154		79277R	G52209	
69711	89407		78001	85314	89425	79164	G56797		79278L	G52127	
69712	85013	89414	78001	89425		79165	G56798		79278R	G52128	
69712	89414		78002	85702		79166	G56582		79284L	G52494	
69713	85046	89434	78003	85308	89422	79167	G56581		79284R	G52495	
69713	89434		78003	89422		79168	G51703		79286L	G52117	
69716	85024		78005	85310	89423	79173	G52008		79286R	G52118	
69717	85310	89423	78005	89423		79174	G52009		79291L	G52173	
69717	89423		78007	85307		79175	G52095		79291R	G52174	
69720	85736		78008	85314	89425	79176	G52094		79292	G52131	
69726	85319	89428	78009	85303	89422	79179	G51704		79294L	G52152	
69726	89428		78009	89422		79184	G52188		79294R	G52153	
69728	85055	89439	78013	85323	89436	79185	G52187		79299L	G52255	
69728	89439		78013	89436		79186	G52007		79299R	G52256	
69729	85314	89425	78015	85724	89443	79187	G52004		79309	G51972	
69729	89425		78015	89443		79188	G56843		79310L	G52148	
69732	85300	89419	78016	85001	89410	79189	G56842		79310R	G52149	
69732	89419		78016	89410		79190	G56758		79311L	G52187	
69741	85906	89407	78020	85712		79191	G56759		79311R	G52188	
69741	89407		78023	85705	89447	79195	G56886		79315L	G51877	

Important Note: Competitive Interchanges are to be used for stocking purposes only. Where multiple crosses are identified, please reference the applications section of this catalog. / **Remarque importante:** Les interchanges concurrentiels ne s'utilisent qu'aux fins de stocks. Dans le cas de références multiples, consulter la section des applications du catalogue. / **Nota importante:** Dans le cas de références multiples, consulter la section des applications du catalogue. / **Nota importante:** Se pueden usar intercambios competitivos para propósitos de almacenamiento solamente. Cuando se identifican intercambios múltiples, consulte la sección de aplicaciones de este catálogo.

COMPETITIVE & O.E.M. INTERCHANGE LIST
Lista de Intercambios contra Competidores y Equipo Original.
Liste dinterchange de produits comptitifs & dquipement original (OEM)

Grupo A... cont'd

Grupo a	Gabriel	Upgrade	Grupo a	Gabriel	Upgrade	Grupo a	Gabriel	Upgrade	Grupo a	Gabriel	Upgrade
79315R	G51878		USA58077	85337		USA69601	61554		USA78066	85727	
79317	G51865		USA58080	85932	89453	USA69606	61605		USA79053	G56606	
79319	G64148		USA58081	85920	89503	USA69606	81878		USA79092	G56568	
79320	G52125		USA58082	85932	89453	USA69612	61535		USA79093	G56601	
79322	G51719		USA69011	G63662		USA69612	61664		USA79103	G56778	
79324L	G52260		USA69011	G63866		USA69613	61575		USA79117	G56620	
79324R	G52261		USA69012	G63783		USA69613	61676		USA79132	G56778	
79325	G51740		USA69012	G63803		USA69615	61623		USA79166	G56581	
79326L	G52173		USA69013	61641		USA69616	61624		USA79167	G56582	
79326R	G52174		USA69013	81920		USA69658	61504		USA79168	G51703	
79327L	G52173		USA69014	61600		USA69660	G63844		USA79179	G51704	
79327R	G52174		USA69014	81873		USA69661	G51728		USA79184	G52188	
79329L	G52410		USA69031	61528		USA69664	61565		USA79186	G52007	
79329R	G52411		USA69034	69909		USA69666	61655		USA79187	G52004	
79333L	G52127		USA69080	61506		USA69668	G63918		USA79195	G56886	
79333R	G52128		USA69080	81318		USA69689	83127		USA79196	G56887	
79334L	G52127		USA69092	69813		USA69692	61663		USA79217	G52300	
79334R	G52128		USA69115	70041		USA69693	61675		USA79218	G52299	
79335L	G52360		USA69117	61501		USA69696	G63862		USA79219	G52082	
79335R	G52361		USA69117	81478		USA69696	G64047		USA79220	G52081	
79337L	G52203		USA69131	G51874		USA69697	G63676		USA79221	G51842	
79337R	G52204		USA69133	G51990		USA69699	61500		USA79222	G52122	
79339	G51896		USA69135	69592		USA69718	85321		USA79223	G52121	
79339	G51897		USA69137	G51898		USA69749	85013	89414	USA79227	G52104	
79341L	G52148		USA69150	G64056		USA69756	85957		USA79228	G52103	
79341R	G52149		USA69391	G63772		USA69758	85061	89450	USA79229	G51723	
79343	G511000		USA69392	G63773		USA69759	83148		USA79230	G51724	
79347L	G52351		USA69517	61528		USA72001	G63870		USA79231	G56838	
79347R	G52352		USA69522	61544		USA72002	61535		USA79232	G56839	
81740	61560		USA69532	G63884		USA72003	61575		USA79233	G56807	
81740	81904		USA69538	61683		USA72004	G64026		USA79234	G56817	
85037	G55698		USA69539	61684		USA72004	G64151		USA79259L	G52245	
85039	G56517		USA69544	G63622		USA72006	G64003		USA79259R	G52246	
G63626	G63683		USA69555	61611		USA72014	83128	89436	USA79262	G56894	
G63626	G63829		USA69556	G63717		USA72015	85052		USA79263	G56894	
G69795	69795		USA69582	G63848		USA72016	83128	89436	USA79264	G51908	
TX69115	70041		USA69583	61692		USA72020	G51856		USA79271	G51949	
TX79195	G56886		USA69584	G64012		USA72023	83908		USA79277L	G52209	
TX79196	G56887		USA69585	61720		USA72035	G64042		USA79277R	G52210	
USA53094	83137		USA69586	G63892		USA78000	85302	89420	USA79284L	G52494	
USA53101	83038		USA69587	61710		USA78031	85311	89424	USA79284R	G52495	
USA53102	83906		USA69588	G63971		USA78040	85314	89425	USA79343	G511000	
USA58017	83164		USA69589	G63958		USA78051	85918	89449			
USA58072	85936	89456	USA69592	61714		USA78054	85736				
USA58073	85084	89460	USA69594	61713		USA78064	85301				

GSP

Gsp	Gabriel	Upgrade	Gsp	Gabriel	Upgrade	Gsp	Gabriel	Upgrade	Gsp	Gabriel	Upgrade
810000	G57709		810016	G57330		810222	G57142		810320	G57060	
810001	G57142		810021	G57197		810227	G57377		810322	G57051	
810004	G57051		810022	G57198		810228	G57378		810323	G56928	
810005	G57549		810025	G57130		810229	G56924		810324	G56927	
810006	G57550		810026	G57131		810230	G56925		810327	G57100	
810009	G57282		810120	G56951		810310	G57013		810328	G57099	
810010	G57060		810214	G57141		810311	G57014				
810013	G57566		810215	G56924		810314	G56950				
810014	G57567		810216	G56925		810315	G56949				
810015	G57329		810218	G56929		810316	G56938				

Important Note: Competitive Interchanges are to be used for stocking purposes only. Where multiple crosses are identified, please reference the applications section of this catalog. / **Remarque importante:** Les interchanges concurrentiels ne s'utilisent qu'aux fins de stocks. Dans le cas de rferences multiples, consulter la section des applications du catalogue. / **Nota importante:** Dans le cas de rferences multiples, consulter la section des applications du catalogue. / **Nota importante:** Se pueden usar intercambios competitivos para propósitos de almacenamiento solamente. Cuando se identifican intercambios múltiples, consulte la sección de aplicaciones de este catálogo.

COMPETITIVE & O.E.M. INTERCHANGE LIST
Lista de Intercambios contra Competidores y Equipo Original.
Liste d'interchange de produits compititifs & d'equipement original (OEM)

GSP... cont'd

Gsp	Gabriel	Upgrade	Gsp	Gabriel	Upgrade	Gsp	Gabriel	Upgrade	Gsp	Gabriel	Upgrade
810331	G57110		811347	G57148		836324	G57033		853021	G57036	
810332	G57111		812001	G57071		836324	G57062		853114	G57057	
810333	G57069		812002	G57072		836325	G57032		853114	G57058	
810333	G57121		812005	G57206		836325	G57061		853115	G57037	
810334	G57070		812006	G57206		836328	G57084		853116	G57038	
810334	G57122		812009	G57206		836329	G57085		853211	G57161	
810335	G57022		812010	G57206		836331	G57119		853212	G57162	
810338	G57047		812219	G57112		836332	G57120		853213	G57161	
810339	G57048		812220	G57113		836333	G57419		853214	G57162	
810340	G57000		812222	G57026		836334	G57207		853215	G57161	
810341	G57125		812224	G57075		836335	G57208		853216	G57162	
810353	G57109		812225	G57176		836336	G57424		853221	G57157	
810354	G57197		812226	G57177		836337	G57425		853222	G57158	
810355	G57198		812228	G57206		836338	G57200		853224	G57159	
811004	G57582		812312	G56964		836339	G57201		853224	G57160	
811005	G57583		812313	G56963		836352	G57390		853227	G57030	
811009	G57726		812314	G56962		836353	G57391		853228	G57031	
811010	G57727		812316	G57422		836354	G57222		853312	G57031	
811011	G57726		812319	G56956		836355	G57223		853313	G57030	
811012	G57727		812320	G56957		836356	G57390		853314	G57035	
811014	G57450		812323	G57053		836357	G57391		853315	G57034	
811017	G57497		812324	G57146		836358	G57333		853316	G57036	
811018	G57498		812326	G56965		836359	G57334		853318	G57118	
811116	G56936		812327	G56973		836361	G57137		853319	G57092	
811117	G56934		812328	G56974		836362	G57138		853321	G57202	
811117	G56937		812329	G56975		837001	G57393		853322	G57203	
811212	G57271		812330	G57072		837002	G57394		853323	G57163	
811310	G56935		812331	G57071		837003	G57139		853324	G57164	
811313	G57064		812332	G57147		837004	G57140		853325	G57184	
811314	G57063		812333	G57178		837211	G57268		853326	G57185	
811315	G57046		821005	G57560		837212	G57269		853330	G57037	
811316	G57045		821006	G57561		837213	G57168		853331	G57038	
811317	G57017		821009	G56991		837214	G57167		853334	G57776	
811318	G57080		821010	G56992		837216	G57059		853335	G57777	
811319	G57016		827213	G57363		837219	G57090		866006	G57459	
811320	G57015		827214	G57364		837220	G57091		866007	G57460	
811321	G57018		836116	G57012		837330	G57088		866008	G57459	
811323	G57019		836117	G57011		837331	G57089		866009	G57460	
811324	G57020		836211	G57054		837333	G57149		866016	G57459	
811325	G57021		836212	G57055		837334	G57139		866017	G57460	
811326	G57172		836219	G57086		837335	G57140		866020	G57673	
811327	G57173		836220	G57087		837341	G57343		866021	G57674	
811328	G57132		836221	G57119		837342	G57344		866022	G57675	
811329	G57103		836222	G57120		839219	G57086		866210	G57341	
811330	G57095		836310	G56943		847221	G57594		866211	G57342	
811331	G57096		836311	G56991		847222	G57595		866223	G57339	
811332	G57081		836312	G56992		853000	G57558		866224	G57340	
811333	G57082		836313	G57056		853001	G57559		869003	G57192	
811334	G57427		836314	G56995		853004	G57647		869013	G57738	
811335	G57148		836315	G56994		853005	G57144		869014	G57739	
811336	G57081		836316	G56993		853006	G57145		869017	G57204	
811337	G57082		836317	G56996		853007	G57034		869018	G57205	
811340	G57081		836318	G56997		853008	G57035		869021	G57105	
811341	G57082		836319	G56998		853009	G57493		869022	G57106	
811342	G57148		836320	G57050		853010	G57494		869023	G57375	
811346	G57148		836321	G57049		853013	G57092		869024	G57376	

Important Note: Competitive Interchanges are to be used for stocking purposes only. Where multiple crosses are identified, please reference the applications section of this catalog. / **Remarque importante:** Les interchanges concurrentiels ne s'utilisent qu'aux fins de stocks. Dans le cas de rfrences multiples, consulter la section des applications du catalogue. / **Nota importante:** Dans le cas de rfrences multiples, consulter la section des applications du catalogue. / **Nota importante:** Se pueden usar intercambios competitivos para propósitos de almacenamiento solamente. Cuando se identifican intercambios múltiples, consulte la sección de aplicaciones de este catálogo.

COMPETITIVE & O.E.M. INTERCHANGE LIST
Lista de Intercambios contra Competidores y Equipo Original.
Liste dinterchange de produits comptitifs & dquipement original (OEM)

GSP... cont'd

Gsp	Gabriel	Upgrade	Gsp	Gabriel	Upgrade	Gsp	Gabriel	Upgrade	Gsp	Gabriel	Upgrade
869025	G57078		869314	G57010		869350	G57121		882319	G57134	
869026	G57079		869315	G57065		869351	G57122		882320	G57027	
869031	G57499		869316	G57066		869368	G57330		882336	G57416	
869032	G57500		869321	G56931		872110	G57005		882337	G57682	
869033	G57329		869322	G56930		872112	G57006		882338	G57332	
869034	G57330		869324	G57098		872212	G57156		882339	G57331	
869037	G57665		869325	G57105		872310	G57039		882340	G57447	
869038	G57666		869326	G57106		875211	G57219		882341	G57465	
869049	G57648		869327	G57041		875212	G57218		882342	G57466	
869050	G57649		869328	G57042		882000	G57464		882345	G57197	
869112	G56933		869329	G57043		882001	G57463		882346	G57198	
869113	G56932		869330	G57044		882002	G57607		882347	G57564	
869213	G57404		869331	G57115		882003	G57463		882348	G57565	
869214	G57405		869332	G57114		882004	G57464		882349	G57515	
869219	G57375		869333	G57067		882005	G57607		882350	G57516	
869220	G57376		869334	G57068		882006	G57007		882351	G57393	
869221	G57097		869335	G57133		882007	G57008		882352	G57394	
869222	G57098		869336	G57134		882008	G57463		882353	G57204	
869223	G57097		869337	G57078		882009	G57464		882354	G57205	
869224	G57373		869338	G57079		882010	G57083		882367	G57658	
869229	G57663		869339	G57076		882011	G57083		882368	G57659	
869230	G57664		869340	G57077		882311	G57007		882371	G57465	
869237	G57191		869344	G57124		882312	G57008		882372	G57466	
869238	G57192		869345	G57123		882315	G57083		882377	G57275	
869310	G57027		869346	G57397		882316	G57083		882378	G57276	
869311	G56948		869347	G57353		882317	G57414		882383	G57471	
869312	G56948		869348	G57354		882318	G57415		882384	G57472	

Gulf Stream Coach

Gulf stream coach	Gabriel	Upgrade	Gulf stream coach	Gabriel	Upgrade	Gulf stream coach	Gabriel	Upgrade	Gulf stream coach	Gabriel	Upgrade
141700131809	85029		16-18103-000	85900		88982682	83136		ASH-1136	G63623	
141700131810	83160		1616736000	85029		8C24-18045-DA	G63622		ASH-1154	G63622	
15123676	83136		1616737000	83160		8C24-18080-DB	G63623		ASH1136	G63623	
15588554	83136		1616873000	85029		8C2418045DA	G63622		ASH1154	G63622	
15887728	83136		1616874000	83160		8C2418080DB	G63623		AT-163G	G63622	
16-16736-000	85029		1618103000	85900		8C2Z-18124-D	G63622		AT-164G	G63623	
16-16737-000	83160		19152843	83136		8C2Z-18125-D	G63623		AT163G	G63622	
16-16873-000	85029		22064230	83136		8C2Z18124D	G63622		AT164G	G63623	
16-16874-000	83160		481700000493	85900		8C2Z18125D	G63623				

Hardee Mfg.

Hardee mfg.	Gabriel	Upgrade	Hardee mfg.	Gabriel	Upgrade	Hardee mfg.	Gabriel	Upgrade	Hardee mfg.	Gabriel	Upgrade
8030223	83207	89407	8030223	89407		AS789B	85014				

Hausman

Hausman	Gabriel	Upgrade	Hausman	Gabriel	Upgrade	Hausman	Gabriel	Upgrade	Hausman	Gabriel	Upgrade
695110	85318		695119	85702							

Hendrickson

Hendrickson	Gabriel	Upgrade	Hendrickson	Gabriel	Upgrade	Hendrickson	Gabriel	Upgrade	Hendrickson	Gabriel	Upgrade
471700000460	85959		680463	89440		HD58913011	85959		HTSS25436	85916	89430
471700006270	85932	89453	680570	89437		HTSS20002	85000	89436	S-23362	89437	
471700006270	89453		680616	89430		HTSS23566	85000	89436	S2212HDR	85029	
60657-017	85979		98583-020	89414		HTSS24023	85738				
671779	89414		B-23362	89437		HTSS24088	83389	89436			

Hendrickson Trailer Suspension Systems

Hendrickson trailer suspension systems	Gabriel	Upgrade	Hendrickson trailer suspension systems	Gabriel	Upgrade	Hendrickson trailer suspension systems	Gabriel	Upgrade	Hendrickson trailer suspension systems	Gabriel	Upgrade
060665-014	85962		471700000456	85959		47902-11	83207	89407			
060665-018	85961		471700006269	85932	89453	47902-11	89407				
060665014	85962		471700006269	89453		47902-13	83122	89406			
12738	83225		471700131545	85006		47902-13	89406				

Important Note: Competitive Interchanges are to be used for stocking purposes only. Where multiple crosses are identified, please reference the applications section of this catalog. / **Remarque importante:** Les interchanges concurrentiels ne s'utilisent qu'aux fins de stocks. Dans le cas de rferences multiples, consulter la section des applications du catalogue. / **Nota importante:** Dans le cas de rferences multiples, consulter la section des applications du catalogue. / **Nota importante:** Se pueden usar intercambios competitivos para propósitos de almacenamiento solamente. Cuando se identifican intercambios múltiples, consulte la sección de aplicaciones de este catálogo.

COMPETITIVE & O.E.M. INTERCHANGE LIST
Lista de Intercambios contra Competidores y Equipo Original.
Liste d'interchange de produits complitifs & d'quipement original (OEM)

Hendrickson Trailer Suspension Systems... cont'd

Hendrickson trailer suspension systems	Gabriel	Upgrade	Hendrickson trailer suspension systems	Gabriel	Upgrade	Hendrickson trailer suspension systems	Gabriel	Upgrade	Hendrickson trailer suspension systems	Gabriel	Upgrade
47902-15	83137		57241-001	83111		58913008	85959		60665-011	85967	
47902-18	85030	89440	57241-002	83109		58913008L	85959		60665-013	85965	
47902-18	89440		57241-003	83112		58913009	85959		60665-014	85962	
47902-19	83123	89405	57241-004	83110		58913009L	85959		60665-018	85961	
47902-19	89405		57241-006	83111		58913011	85959		60665-018L	85961	
47902-20	85036	89405	57241-006L	83111		58913011L	85959		60665-020	85919	
47902-20	89405		57241001	83111		58913012	85932	89453	60665-025	85036	89405
47902-21	85976		57241002	83109		58913012	89453		60665-025	89405	
47902-22	85916	89430	57241003	83112		58913012L	85932	89453	60665-025L	85036	89405
47902-22	89430		57241004	83110		58913012L	89453		60665-025L	89405	
47902-24	83137		57241006	83111		58913015	85200		60665003	83137	
47902-25	83125		57241006L	83111		59048-001	83148		60665004	85036	89405
47902-26	83144		57324-1	85036	89405	59048001	83148		60665004	89405	
47902-27	83123	89405	57324-1	89405		59057-001	83137		60665004L	85036	89405
47902-27	89405		57324-11	85305		59057-002	85036	89405	60665004L	89405	
47902-28	85013	89414	57324-2	85976		59057-002	89405		60665005	85919	
47902-28	89414		57324-3	85916	89430	59057001	83137		60665005L	85919	
47902-29	83149		57324-3	89430		59057002	85036	89405	60665008	85978	
47902-3	85005	89430	57324-6	85043		59057002	89405		60665009	85043	
47902-3	89430		573241	85036	89405	59305-1	85979		60665011	85967	
47902-8	83122	89406	573241	89405		593051	85979		60665013	85965	
47902-8	89406		5732411	85305		59483-000	85919		60665014	85962	
47902-9	83123	89405	573242	85976		59483000	85919		60665018	85961	
47902-9	89405		573243	85916	89430	59851-1	85976		60665018L	85961	
4790211	83207	89407	573243	89430		598511	85976		60665020	85919	
4790211	89407		573246	85043		59852-1	85977		60665025	85036	89405
4790213	83122	89406	57905-1	85976		59852-2	85977		60665025	89405	
4790213	89406		57905-2	85006		598521	85977		60665025L	85036	89405
4790215	83137		579051	85976		598522	85977		60665025L	89405	
4790218	85030	89440	579052	85006		60657-003	85072		60670-001	83123	89405
4790218	89440		58623-1	85978		60657-003L	85072		60670-001	89405	
4790219	83123	89405	586231	85978		60657-004	85072		60670-002	83207	89407
4790219	89405		58913-003	85932	89453	60657-005	85087		60670-002	89407	
4790220	85036	89405	58913-003	89453		60657-005L	85087		60670-002L	83207	89407
4790220	89405		58913-003L	85932	89453	60657-006	85102		60670-002L	89407	
4790221	85976		58913-003L	89453		60657-007	85072		60670-003	83149	
4790222	85916	89430	58913-007	85959		60657-010	85102		60670-004	83123	89405
4790222	89430		58913-007L	85959		60657-011	85102		60670-004	89405	
4790224	83137		58913-008	85959		60657003	85072		60670-005	83137	
4790225	83125		58913-008L	85959		60657003L	85072		60670-006	83147	
4790226	83144		58913-009	85959		60657004	85072		60670-006L	83147	
4790227	83123	89405	58913-009L	85959		60657005	85087		60670-007	83144	
4790227	89405		58913-011	85959		60657005L	85087		60670-007L	83144	
4790228	85013	89414	58913-011L	85959		60657006	85102		60670-008	83123	89405
4790228	89414		58913-012	85932	89453	60657007	85072		60670-008	89405	
4790229	83149		58913-012	89453		60657010	85102		60670-008L	83123	89405
479023	85005	89430	58913-012L	85932	89453	60657011	85102		60670-008L	89405	
479023	89430		58913-012L	89453		60665-003	83137		60670-009	85013	89414
479028	83122	89406	58913-015	85200		60665-004	85036	89405	60670-009	89414	
479028	89406		58913-015L	85200		60665-004	89405		60670-010	83149	
479029	83123	89405	58913003	85932	89453	60665-004L	85036	89405	60670-011	83148	
479029	89405		58913003	89453		60665-004L	89405		60670-012	83168	
503610C2	83207	89407	58913003L	85932	89453	60665-005	85919		60670-013	83148	
503610C2	89407		58913003L	89453		60665-005L	85919		60670-014	83166	
5554596	85303	89422	58913007	85959		60665-008	85978		60670-017	83148	
5554596	89422		58913007L	85959		60665-009	85043		60670-018	83166	

Important Note: Competitive Interchanges are to be used for stocking purposes only. Where multiple crosses are identified, please reference the applications section of this catalog. / **Remarque importante:** Les interchanges concurrentiels ne s'utilisent qu'aux fins de stocks. Dans le cas de rferences multiples, consulter la section des applications du catalogue. / **Nota importante:** En el caso de rferencias mltiples, consultar la seccion de aplicaciones del catalogo. / **Nota importante:** Se pueden usar intercambios competitivos para propósitos de almacenamiento solamente. Cuando se identifican intercambios mltiples, consulte la seccion de aplicaciones de este catalogo.

COMPETITIVE & O.E.M. INTERCHANGE LIST
Lista de Intercambios contra Competidores y Equipo Original.
Liste dinterchange de produits comptitifs & dquipement original (OEM)

Hendrickson Trailer Suspension Systems... cont'd

Hendrickson trailer suspension systems	Gabriel	Upgrade	Hendrickson trailer suspension systems	Gabriel	Upgrade	Hendrickson trailer suspension systems	Gabriel	Upgrade	Hendrickson trailer suspension systems	Gabriel	Upgrade
60670-019	83166		60675003	85976		64838001	85933	89454	665532	89414	
60670-020	83148		60675003L	85976		64838001	89454		665533	85005	89430
60670-12	83168		60675004	85006		64838001L	85933	89454	665533	89430	
60670001	83123	89405	60675006	85909		64838001L	89454		665536	85000	89436
60670001	89405		60675006L	85909		64838002	85933	89454	665536	89436	
60670002	83207	89407	60675007	83122	89406	64838002	89454		665693	85064	
60670002	89407		60675007	89406		64838002L	85933	89454	665694	85052	
60670002L	83207	89407	60675009	85978		64838002L	89454		665698	85911	
60670002L	89407		60675010	85036	89405	64838003	85933	89454	665733	85045	
60670003	83149		60675010	89405		64838003	89454		665756	85000	89436
60670004	83123	89405	60675013	83123	89405	64838003L	85933	89454	665756	89436	
60670004	89405		60675013	89405		64838003L	89454		665758	85064	
60670005	83137		60675014	85978		654890	83207	89407	665759	85052	
60670006	83147		60675017	85979		654890	89407		665760	85045	
60670006L	83147		6067512	85638		654891	83149		665761	85911	
60670007	83144		606758Q	85976		654894	83123	89405	665763	85079	
60670007L	83144		60680-001	83111		654894	89405		665764	85029	
60670008	83123	89405	60680-001L	83111		654895	83137		665765	83150	
60670008	89405		60680-002	83109		654896	83147		665766	85000	89436
60670008L	83123	89405	60680-003	83112		654897	83144		665766	89436	
60670008L	89405		60680-003L	83112		654898	83123	89405	665767	85045	
60670009	85013	89414	60680-004	83143		654898	89405		665816	85072	
60670009	89414		60680-004L	83143		654899	85013	89414	665892	85072	
60670010	83149		60680-005	83142		654899	89414		671006	85036	89405
60670011	83148		60680-005L	83142		654900	83149		671006	89405	
60670012	83168		60680001	83111		654903	83111		671007	83137	
60670013	83148		60680001L	83111		654904	83109		671009	85919	
60670014	83166		60680002	83109		654905	83112		671105	85072	
60670017	83148		60680003	83112		654951	85000	89436	671603	85919	
60670018	83166		60680003L	83112		654951	89436		671606	85955	
60670019	83166		60680004	83143		659000	83148		671611	85955	
60670020	83148		60680004L	83143		659004	83123	89405	671704	85043	
6067012	83168		60680005	83142		659004	89405		671764	85967	
60675-001	85978		60680005L	83142		659024	85052		671792	85965	
60675-001L	85978		60685-001	85977		659048	83143		671798	85962	
60675-002	85979		60685001	85977		659049	83142		671948	85000	89436
60675-002L	85979		60998-001	85006		659155	83147		671948	89436	
60675-003	85976		60998-002	85919		659202	83148		680091	85303	89422
60675-003L	85976		60998-002L	85919		659292	83148		680091	89422	
60675-004	85006		60998-003	85006		65992-001	85955		680102	85712	
60675-006	85909		60998001	85006		65992-002	85955		680341	85323	89436
60675-006L	85909		60998002	85919		65992-002L	85955		680341	89436	
60675-007	83122	89406	60998002L	85919		65992-003	85959		680467	85323	89436
60675-007	89406		60998003	85006		65992001	85955		680467	89436	
60675-009	85978		64838-001	85933	89454	65992002	85955		680509	85738	
60675-010	85036	89405	64838-001	89454		65992002L	85955		680565	85738	
60675-010	89405		64838-001L	85933	89454	65992003	85959		680566	85938	
60675-013	83123	89405	64838-001L	89454		665190	85006		680568	85323	89436
60675-013	89405		64838-002	85933	89454	665246	85043		680568	89436	
60675-014	85978		64838-002	89454		665267	85029		680571	85738	
60675-017	85979		64838-002L	85933	89454	665405	85030	89440	680573	85939	
60675-12	85638		64838-002L	89454		665405	89440		680579	85939	
60675001	85978		64838-003	85933	89454	665406	85010		680600	85305	
60675001L	85978		64838-003	89454		665531	85000	89436	680614	85338	
60675002	85979		64838-003L	85933	89454	665531	89436		680617	85337	
60675002L	85979		64838-003L	89454		665532	85013	89414	680702	85323	89436

Important Note: Competitive Interchanges are to be used for stocking purposes only. Where multiple crosses are identified, please reference the applications section of this catalog. / **Remarque importante:** Les interchanges concurrentiels ne s'utilisent qu'aux fins de stocks. Dans le cas de rferences multiples, consulter la section des applications du catalogue. / **Nota importante:** Dans le cas de rferences multiples, consulter la section des applications du catalogue. / **Nota importante:** Se pueden usar intercambios competitivos para propósitos de almacenamiento solamente. Cuando se identifican intercambios múltiples, consulte la sección de aplicaciones de este catálogo.

COMPETITIVE & O.E.M. INTERCHANGE LIST
Lista de Intercambios contra Competidores y Equipo Original.
Liste dinterchange de produits comptitifs & dquipement original (OEM)

Hendrickson Trailer Suspension Systems... cont'd

Hendrickson trailer suspension systems	Gabriel	Upgrade	Hendrickson trailer suspension systems	Gabriel	Upgrade	Hendrickson trailer suspension systems	Gabriel	Upgrade	Hendrickson trailer suspension systems	Gabriel	Upgrade
680702	89436		A-2232	89430		AE76164-4	83225		B20345	85345	
680756	85323	89436	A-2240	85013	89414	AE761643	85307		B21553	85738	
680756	89436		A-2240	89414		AE761644	83225		B21699	87018	
680769	85911		A-2240-1	85043		B-20345	85345		B21832	85323	89436
680776	85338		A-2471	85006		B-21553	85738		B21832	89436	
70018	85303	89422	A-4084	85005	89430	B-21699	87018		B21936	85064	
70018	89422		A-4084	89430		B-21832	85323	89436	B21947	85052	
70021	85303	89422	A-4089	83209	89414	B-21832	89436		B21994	85938	
70021	89422		A-4089	89414		B-21936	85064		B22311	85045	
70088	85307		A-4890	85712		B-21947	85052		B22312	85939	
98583-005	83168		A-6156	85301		B-21994	85938		B22345	85911	
98583-006	83148		A10023	85000	89436	B-22311	85045		B22715	85000	89436
98583-016	83147		A10023	89436		B-22312	85939		B22715	89436	
98583-019	85323	89436	A10348	85043		B-22345	85911		B22862	85045	
98583-019	89436		A11931	85000	89436	B-22715	85000	89436	B23013	85000	89436
98583-032	85072		A11931	89436		B-22715	89436		B23013	89436	
98583005	83168		A14583	85000	89436	B-22862	85045		B23014	85738	
98583006	83148		A14583	89436		B-23013	85000	89436	B23290	83150	
98583016	83147		A1667	85000	89436	B-23013	89436		B23315	85029	
98583019	85323	89436	A1667	89436		B-23014	85738		B23316	85382	
98583019	89436		A1668	85000	89436	B-23290	83150		B23361	85911	
98583032	85072		A1668	89436		B-23315	85029		B23548	85079	
A-10023	85000	89436	A20001	83389	89436	B-23316	85382		B23566	85000	89436
A-10023	89436		A20001	89436		B-23361	85911		B23566	89436	
A-10348	85043		A20002	85000	89436	B-23548	85079		B23649	85064	
A-11931	85000	89436	A20002	89436		B-23566	85000	89436	B23650	85052	
A-11931	89436		A20126	85323	89436	B-23566	89436		B23651	85045	
A-14496	646155		A20126	89436		B-23649	85064		B23743	85938	
A-14583	85000	89436	A20345	85345		B-23650	85052		B24023	85738	
A-14583	89436		A20886	85030	89440	B-23651	85045		B24088	83389	89436
A-1667	85000	89436	A20886	89440		B-23743	85938		B24088	85000	89436
A-1667	89436		A20887	85005	89430	B-24023	85738		B24088	89436	
A-1668	85000	89436	A20887	89430		B-24088	83389	89436	B24125	85323	89436
A-1668	89436		A20889	85323	89436	B-24088	85000	89436	B24125	89436	
A-20001	83389	89436	A20889	89436		B-24088	89436		B24579	85939	
A-20001	89436		A21292	85052		B-24125	85323	89436	B25174	85029	
A-20002	85000	89436	A2160	85014		B-24125	89436		B25436	85916	89430
A-20002	89436		A2212	85029		B-24579	85939		B25436	89430	
A-20126	85323	89436	A2213	85010		B-25174	85029		B25437	85337	
A-20126	89436		A2218	85030	89440	B-25436	85916	89430	B25515	85338	
A-20345	85345		A2218	89440		B-25436	89430		B26652	85000	89436
A-20886	85030	89440	A2230	85005	89430	B-25437	85337		B26652	89436	
A-20886	89440		A2230	89430		B-25515	85338		B27058	83128	89436
A-20887	85005	89430	A2232	85005	89430	B-26652	85000	89436	B27058	89436	
A-20887	89430		A2232	89430		B-26652	89436		B27747	85911	
A-20889	85323	89436	A2240	85013	89414	B-27058	83128	89436	B29432	85323	89436
A-20889	89436		A2240	89414		B-27058	89436		B29432	89436	
A-21292	85052		A22401	85043		B-27747	85911		B29678	85911	
A-2160	85014		A2471	85006		B-29432	85323	89436	B29826	85338	
A-2212	85029		A4084	85005	89430	B-29432	89436		B33312	85338	
A-2213	85010		A4084	89430		B-29678	85911		B33313	85338	
A-2218	85030	89440	A4089	83209	89414	B-29826	85338		BE76164-2	85303	89422
A-2218	89440		A4089	89414		B-33312	85338		BE76164-2	89422	
A-2230	85005	89430	A4890	85712		B-33313	85338		BE76164-3	85307	
A-2230	89430		A6156	85301		B-33314	85939		BE76164-4	83225	
A-2232	85005	89430	AE76164-3	85307		B-33314L	85939		BE761642	85303	89422

Important Note: Competitive Interchanges are to be used for stocking purposes only. Where multiple crosses are identified, please reference the applications section of this catalog. / **Remarque importante:** Les interchanges concurrentiels ne s'utilisent qu'aux fins de stocks. Dans le cas de rferences multiples, consulter la section des applications du catalogue. / **Nota importante:** Dans le cas de rferences multiples, consulter la section des applications du catalogue. / **Nota importante:** Se pueden usar intercambios competitivos para propósitos de almacenamiento solamente. Cuando se identifican intercambios múltiples, consulte la sección de aplicaciones de este catálogo.

COMPETITIVE & O.E.M. INTERCHANGE LIST
Lista de Intercambios contra Competidores y Equipo Original.
Liste dinterchange de produits comptitifs & dquipement original (OEM)

Hendrickson Trailer Suspension Systems... cont'd

Hendrickson trailer suspension systems	Gabriel	Upgrade	Hendrickson trailer suspension systems	Gabriel	Upgrade	Hendrickson trailer suspension systems	Gabriel	Upgrade	Hendrickson trailer suspension systems	Gabriel	Upgrade
BE761642	89422		S-22345	85911		S-4089	89414		S22715	89436	
BE761643	85307		S-2240	85013	89414	S-4890	85712		S22862	85045	
BE761644	83225		S-2240	89414		S10348	85043		S23013	85000	89436
HDR 58913 015	85200		S-22715	85000	89436	S14583	85000	89436	S23013	89436	
NS500699	85005	89430	S-22715	89436		S14583	89436		S23014	85738	
NS500699	89430		S-22862	85045		S1667	85000	89436	S23290	83150	
S-10348	85043		S-23013	85000	89436	S1667	89436		S23315	85029	
S-14583	85000	89436	S-23013	89436		S1668	85000	89436	S23316	85382	
S-14583	89436		S-23014	85738		S1668	89436		S23361	85911	
S-1667	85000	89436	S-23290	83150		S20001	83389	89436	S23548	85079	
S-1667	89436		S-23315	85029		S20001	89436		S23566	85000	89436
S-1668	85000	89436	S-23316	85382		S20002	85000	89436	S23566	89436	
S-1668	89436		S-23361	85911		S20002	89436		S23649	85064	
S-20001	83389	89436	S-23548	85079		S20126	85323	89436	S23650	85052	
S-20001	89436		S-23566	85000	89436	S20126	89436		S23651	85045	
S-20002	85000	89436	S-23566	89436		S20345	85345		S23743	85938	
S-20002	89436		S-23649	85064		S20886	85030	89440	S24023	85738	
S-20126	85323	89436	S-23650	85052		S20886	89440		S24088	83389	89436
S-20126	89436		S-23651	85045		S20887	85005	89430	S24088	85000	89436
S-20345	85345		S-23743	85938		S20887	89430		S24088	89436	
S-20886	85030	89440	S-24023	85738		S20889	85323	89436	S24125	85323	89436
S-20886	89440		S-24088	83389	89436	S20889	89436		S24125	89436	
S-20887	85005	89430	S-24088	85000	89436	S21292	85052		S24579	85939	
S-20887	89430		S-24088	89436		S21553	85738		S2471	85006	
S-20889	85323	89436	S-24125	85323	89436	S2160	85014		S25436	85916	89430
S-20889	89436		S-24125	89436		S21699	87018		S25436	89430	
S-21292	85052		S-24579	85939		S21832	85323	89436	S25437	85337	
S-21553	85738		S-2471	85006		S21832	89436		S25515	85338	
S-2160	85014		S-25436	85916	89430	S21936	85064		S26652	85000	89436
S-21699	87018		S-25436	89430		S21947	85052		S26652	89436	
S-21832	85323	89436	S-25437	85337		S2212	85029		S29432	85323	89436
S-21832	89436		S-25515	85338		S2213	85010		S29432	89436	
S-21936	85064		S-26652	85000	89436	S2218	85030	89440	S29678	85911	
S-21947	85052		S-26652	89436		S2218	89440		S29826	85338	
S-2212	85029		S-29432	85323	89436	S2230	85005	89430	S33312	85338	
S-2213	85010		S-29432	89436		S2230	89430		S33313	85338	
S-2218	85030	89440	S-29678	85911		S22311	85045		S33313L	85338	
S-2218	89440		S-29826	85338		S22312	85939		S4084	85005	89430
S-2230	85005	89430	S-33312	85338		S2232	85005	89430	S4084	89430	
S-2230	89430		S-33313	85338		S2232	89430		S4089	83209	89414
S-22311	85045		S-33313L	85338		S22345	85911		S4089	89414	
S-22312	85939		S-4084	85005	89430	S2240	85013	89414	S4890	85712	
S-2232	85005	89430	S-4084	89430		S2240	89414				
S-2232	89430		S-4089	83209	89414	S22715	85000	89436			

Hendrickson Truck Suspension Systems

Hendrickson truck suspension systems	Gabriel	Upgrade	Hendrickson truck suspension systems	Gabriel	Upgrade	Hendrickson truck suspension systems	Gabriel	Upgrade	Hendrickson truck suspension systems	Gabriel	Upgrade
060665-014	85962		47902-11	89407		47902-22	85916	89430	47902-3	89430	
060665-018	85961		47902-13	83122	89406	47902-22	89430		47902-8	83122	89406
060665014	85962		47902-13	89406		47902-24	83137		47902-8	89406	
060675-016	85976		47902-15	83137		47902-25	83125		47902-9	83123	89405
060675016	85976		47902-18	85030	89440	47902-26	83144		47902-9	89405	
12738	83225		47902-18	89440		47902-27	83123	89405	4790211	83207	89407
471700000456	85959		47902-19	83123	89405	47902-27	89405		4790211	89407	
471700006269	85932	89453	47902-19	89405		47902-28	85013	89414			
471700006269	89453		47902-20	85036	89405	47902-28	89414				
471700131545	85006		47902-20	89405		47902-29	83149				
47902-11	83207	89407	47902-21	85976		47902-3	85005	89430			

Important Note: Competitive Interchanges are to be used for stocking purposes only. Where multiple crosses are identified, please reference the applications section of this catalog. / **Remarque importante:** Les interchanges concurrentiels ne s'utilisent qu'aux fins de stocks. Dans le cas de références multiples, consulter la section des applications du catalogue. / **Nota importante:** Dans le cas de referencias multiples, consultar la sección de aplicaciones del catálogo. / **Nota importante:** Se pueden usar intercambios competitivos para propósitos de almacenamiento solamente. Cuando se identifican intercambios múltiples, consulte la sección de aplicaciones de este catálogo.

COMPETITIVE & O.E.M. INTERCHANGE LIST
Lista de Intercambios contra Competidores y Equipo Original.
Liste dinterchange de produits comptitifs & dquipement original (OEM)

Hendrickson Truck Suspension Systems... cont'd

Hendrickson truck suspension systems	Gabriel	Upgrade	Hendrickson truck suspension systems	Gabriel	Upgrade	Hendrickson truck suspension systems	Gabriel	Upgrade	Hendrickson truck suspension systems	Gabriel	Upgrade
4790213	83122	89406	57905-1	85976		598522	85977		60665025L	89405	
4790213	89406		579051	85976		60657-003	85072		60670-001	83123	89405
4790215	83137		58623-1	85978		60657-003L	85072		60670-001	89405	
4790218	85030	89440	586231	85978		60657-004	85072		60670-002	83207	89407
4790218	89440		58913-003	85932	89453	60657-005	85087		60670-002	89407	
4790219	83123	89405	58913-003	89453		60657-005L	85087		60670-002L	83207	89407
4790219	89405		58913-003L	85932	89453	60657-006	85102		60670-002L	89407	
4790220	85036	89405	58913-003L	89453		60657-007	85072		60670-003	83149	
4790220	89405		58913-007	85959		60657-010	85102		60670-004	83123	89405
4790221	85976		58913-007L	85959		60657-011	85102		60670-004	89405	
4790222	85916	89430	58913-008	85959		60657003	85072		60670-005	83137	
4790222	89430		58913-008L	85959		60657003L	85072		60670-006	83147	
4790224	83137		58913-009	85959		60657004	85072		60670-006L	83147	
4790225	83125		58913-009L	85959		60657005	85087		60670-007	83144	
4790226	83144		58913-011	85959		60657005L	85087		60670-007L	83144	
4790227	83123	89405	58913-011L	85959		60657006	85102		60670-008	83123	89405
4790227	89405		58913-012	85932	89453	60657007	85072		60670-008	89405	
4790228	85013	89414	58913-012	89453		60657010	85102		60670-008L	83123	89405
4790228	89414		58913-012L	85932	89453	60657011	85102		60670-008L	89405	
4790229	83149		58913-012L	89453		60665-003	83137		60670-009	85013	89414
479023	85005	89430	58913-015	85200		60665-004	85036	89405	60670-009	89414	
479023	89430		58913-015L	85200		60665-004	89405		60670-010	83149	
479028	83122	89406	58913003	85932	89453	60665-004L	85036	89405	60670-011	83148	
479028	89406		58913003	89453		60665-004L	89405		60670-012	83168	
479029	83123	89405	58913003L	85932	89453	60665-005	85919		60670-013	83148	
479029	89405		58913003L	89453		60665-005L	85919		60670-014	83166	
503610C2	83207	89407	58913007	85959		60665-008	85978		60670-017	83148	
503610C2	89407		58913007L	85959		60665-009	85043		60670-018	83166	
5554596	85303	89422	58913008	85959		60665-011	85967		60670-019	83166	
5554596	89422		58913008L	85959		60665-013	85965		60670-020	83148	
57241-001	83111		58913009	85959		60665-014	85962		60670-12	83168	
57241-002	83109		58913009L	85959		60665-018	85961		60670001	83123	89405
57241-003	83112		58913011	85959		60665-018L	85961		60670001	89405	
57241-004	83110		58913011L	85959		60665-020	85919		60670002	83207	89407
57241-006	83111		58913012	85932	89453	60665-025	85036	89405	60670002	89407	
57241-006L	83111		58913012	89453		60665-025	89405		60670002L	83207	89407
57241001	83111		58913012L	85932	89453	60665-025L	85036	89405	60670002L	89407	
57241002	83109		58913012L	89453		60665-025L	89405		60670003	83149	
57241003	83112		58913015	85200		60665003	83137		60670004	83123	89405
57241004	83110		59048-001	83148		60665004	85036	89405	60670004	89405	
57241006	83111		59048001	83148		60665004	89405		60670005	83137	
57241006L	83111		59057-001	83137		60665004L	85036	89405	60670006	83147	
57324-1	85036	89405	59057-002	85036	89405	60665004L	89405		60670006L	83147	
57324-1	89405		59057-002	89405		60665005	85919		60670007	83144	
57324-11	85305		59057001	83137		60665005L	85919		60670007L	83144	
57324-2	85976		59057002	85036	89405	60665008	85978		60670008	83123	89405
57324-3	85916	89430	59057002	89405		60665009	85043		60670008	89405	
57324-3	89430		59305-1	85979		60665011	85967		60670008L	83123	89405
57324-6	85043		593051	85979		60665013	85965		60670008L	89405	
573241	85036	89405	59483-000	85919		60665014	85962		60670009	85013	89414
573241	89405		59483000	85919		60665018	85961		60670009	89414	
5732411	85305		59851-1	85976		60665018L	85961		60670010	83149	
573242	85976		598511	85976		60665020	85919		60670011	83148	
573243	85916	89430	59852-1	85977		60665025	85036	89405	60670012	83168	
573243	89430		59852-2	85977		60665025	89405		60670013	83148	
573246	85043		598521	85977		60665025L	85036	89405	60670014	83166	

Important Note: Competitive Interchanges are to be used for stocking purposes only. Where multiple crosses are identified, please reference the applications section of this catalog. / **Remarque importante:** Les interchanges concurrentiels ne s'utilisent qu'aux fins de stocks. Dans le cas de rferences multiples, consulter la section des applications du catalogue. / **Nota importante:** En el caso de referencias multiples, consultar la seccion de aplicaciones del catalogo. / **Nota importante:** Se pueden usar intercambios competitivos para propósitos de almacenamiento solamente. Cuando se identifican intercambios múltiples, consulte la sección de aplicaciones de este catálogo.

COMPETITIVE & O.E.M. INTERCHANGE LIST
Lista de Intercambios contra Competidores y Equipo Original.
Liste dinterchange de produits comptitifs & dquipement original (OEM)

Hendrickson Truck Suspension Systems... cont'd

Hendrickson truck suspension systems	Gabriel	Upgrade	Hendrickson truck suspension systems	Gabriel	Upgrade	Hendrickson truck suspension systems	Gabriel	Upgrade	Hendrickson truck suspension systems	Gabriel	Upgrade
60670017	83148		60680-001L	83111		64838002	85933	89454	671006	89405	
60670018	83166		60680-002	83109		64838002	89454		671007	83137	
60670019	83166		60680-003	83112		64838002L	85933	89454	671009	85919	
60670020	83148		60680-003L	83112		64838002L	89454		671105	85072	
6067012	83168		60680-004	83143		64838003	85933	89454	671603	85919	
60675-001	85978		60680-004L	83143		64838003	89454		671606	85955	
60675-001L	85978		60680-005	83142		64838003L	85933	89454	671611	85955	
60675-002	85979		60680-005L	83142		64838003L	89454		671704	85043	
60675-002L	85979		60680001	83111		654890	83207	89407	671764	85967	
60675-003	85976		60680001L	83111		654890	89407		671792	85965	
60675-003L	85976		60680002	83109		654891	83149		671798	85962	
60675-006	85909		60680003	83112		654894	83123	89405	680091	85303	89422
60675-006L	85909		60680003L	83112		654894	89405		680091	89422	
60675-007	83122	89406	60680004	83143		654895	83137		680600	85305	
60675-007	89406		60680004L	83143		654896	83147		70018	85303	89422
60675-009	85978		60680005	83142		654897	83144		70018	89422	
60675-010	85036	89405	60680005L	83142		654898	83123	89405	70021	85303	89422
60675-010	89405		60685-001	85977		654898	89405		70021	89422	
60675-013	83123	89405	60685001	85977		654899	85013	89414	70088	85307	
60675-013	89405		60998-001	85006		654899	89414		98583-005	83168	
60675-014	85978		60998-002	85919		654900	83149		98583-006	83148	
60675-017	85979		60998-002L	85919		654903	83111		98583-016	83147	
60675-12	85638		60998-003	85006		654904	83109		98583-032	85072	
60675001	85978		60998001	85006		654905	83112		98583005	83168	
60675001L	85978		60998002	85919		659000	83148		98583006	83148	
60675002	85979		60998002L	85919		659004	83123	89405	98583016	83147	
60675002L	85979		60998003	85006		659004	89405		98583032	85072	
60675003	85976		64838-001	85933	89454	659048	83143		A-14496	646155	
60675003L	85976		64838-001	89454		659049	83142		AE76164-3	85307	
60675006	85909		64838-001L	85933	89454	659155	83147		AE76164-4	83225	
60675006L	85909		64838-001L	89454		659202	83148		AE761643	85307	
60675007	83122	89406	64838-002	85933	89454	659292	83148		AE761644	83225	
60675007	89406		64838-002	89454		65992-001	85955		BE76164-2	85303	89422
60675009	85978		64838-002L	85933	89454	65992-002	85955		BE76164-2	89422	
60675010	85036	89405	64838-002L	89454		65992-002L	85955		BE76164-3	85307	
60675010	89405		64838-003	85933	89454	65992-003	85959		BE76164-4	83225	
60675013	83123	89405	64838-003	89454		65992001	85955		BE761642	85303	89422
60675013	89405		64838-003L	85933	89454	65992002	85955		BE761642	89422	
60675014	85978		64838-003L	89454		65992002L	85955		BE761643	85307	
60675017	85979		64838001	85933	89454	65992003	85959		BE761644	83225	
6067512	85638		64838001	89454		665816	85072		HDR 58913 015	85200	
606758Q	85976		64838001L	85933	89454	665892	85072				
60680-001	83111		64838001L	89454		671006	85036	89405			

Highway Product

Highway product	Gabriel	Upgrade	Highway product	Gabriel	Upgrade	Highway product	Gabriel	Upgrade	Highway product	Gabriel	Upgrade
A1-6-134	83207	89407	A1-6-135	83203	89436	A16134	83207	89407	A16135	83203	89436
A1-6-134	89407		A1-6-135	89436		A16134	89407		A16135	89436	

Hino

Hino	Gabriel	Upgrade	Hino	Gabriel	Upgrade	Hino	Gabriel	Upgrade	Hino	Gabriel	Upgrade
34802	83216		48500-1610	89422		48500-1941	83141		48500-2750	G63610	
48500-1120	85308	89422	48500-1700	85308	89422	48500-1950	G63610		48500-3710	83126	89430
48500-1120	89422		48500-1700	89422		48500-2240	85308	89422	48500-3710	89430	
48500-1140	85308	89422	48500-1730	85308	89422	48500-2240	89422		48500-3720	83140	
48500-1140	89422		48500-1730	89422		48500-2280	85308	89422			
48500-1340	85308	89422	48500-1800	83216		48500-2280	89422				
48500-1340	89422		48500-1801	83216		48500-2292	85308	89422			
48500-1610	85308	89422	48500-1940	83141		48500-2292	89422				

Important Note: Competitive Interchanges are to be used for stocking purposes only. Where multiple crosses are identified, please reference the applications section of this catalog. / **Remarque importante:** Les interchanges concurrentiels ne s'utilisent qu'aux fins de stocks. Dans le cas de rferences multiples, consulter la section des applications du catalogue. / **Nota importante:** Dans le cas de rferences multiples, consulter la section des applications du catalogue. / **Nota importante:** Se pueden usar intercambios competitivos para propósitos de almacenamiento solamente. Cuando se identifican intercambios múltiples, consulte la sección de aplicaciones de este catálogo.

COMPETITIVE & O.E.M. INTERCHANGE LIST
Lista de Intercambios contra Competidores y Equipo Original.
Liste dinterchange de produits comptitifs & dquipement original (OEM)

Hino... cont'd

Hino	Gabriel	Upgrade	Hino	Gabriel	Upgrade	Hino	Gabriel	Upgrade	Hino	Gabriel	Upgrade
48500-E0420	83391		48530-1531	89422		48531-37351	83519		60670-019L	83166	
485001120	85308	89422	48530-1770	83215		48531-37361	83519		60670-020	83148	
485001120	89422		48530-1800	85308	89422	48531-37362	83519		60670-029L	83166	
485001140	85308	89422	48530-1800	89422		4853137350	83519		60670-030	83166	
485001140	89422		48530-1812	85308	89422	4853137351	83519		60670-030L	83166	
485001340	85308	89422	48530-1812	89422		4853137361	83519		60670-031L	83166	
485001340	89422		48530-1880	83215		4853137362	83519		60670012	83168	
485001610	85308	89422	48530-1910	83216		6-031-7708-00	85308	89422	60670013	83148	
485001610	89422		48530-2000	85308	89422	6-031-7708-00	89422		60670014	83166	
485001700	85308	89422	48530-2000	89422		6-031-7708-01	85308	89422	60670014L	83166	
485001700	89422		48530-2510	83216		6-031-7708-01	89422		60670018	83166	
485001730	85308	89422	48530-E0100	83166		6-031-7708-02	85308	89422	60670018L	83166	
485001730	89422		48530-E0250	83137		6-031-7708-02	89422		60670019	83166	
485001800	83216		48530-E0290	83166		6-031-7708-03	85308	89422	60670019L	83166	
485001940	83141		48530-E0390	83166		6-031-7708-03	89422		60670020	83148	
485001941	83141		48530-EW040	83166		6-071-4800-80	85308	89422	60670029L	83166	
485002240	85308	89422	485301190	85308	89422	6-071-4800-80	89422		60670030	83166	
485002240	89422		485301190	89422		6-071-4800-81	85308	89422	60670030L	83166	
485002280	85308	89422	485301460	83215		6-071-4800-81	89422		60670031L	83166	
485002280	89422		485301531	85308	89422	6031770800	85308	89422	6071480080	85308	89422
485002292	85308	89422	485301531	89422		6031770800	89422		6071480080	89422	
485002292	89422		485301770	83215		6031770801	85308	89422	6071480081	85308	89422
485003710A	83126	89430	485301800	85308	89422	6031770801	89422		6071480081	89422	
485003710A	89430		485301800	89422		6031770802	85308	89422	66639	G63610	
485003720	83140		485301812	85308	89422	6031770802	89422		S4850-01941	83141	
48500E0420	83391		485301812	89422		6031770803	85308	89422	S4850-01950	G63610	
48511-37320	83518		485301880	83215		6031770803	89422		S4850-02750	G63610	
48511-80162	83518		485302000	85308	89422	60670-012	83168		S4850-03710	83126	89430
4851137320	83518		485302000	89422		60670-013	83148		S4850-03710	89430	
4851180162	83518		48530E0100	83166		60670-014	83166		S4850-03720	83140	
48530-1190	85308	89422	48530E0250	83137		60670-014L	83166		S485001941	83141	
48530-1190	89422		48530E0290	83166		60670-018	83166		S485003720	83140	
48530-1460	83215		48530E0390	83166		60670-018L	83166		S4853-01910	83216	
48530-1531	85308	89422	48531-37350	83519		60670-019	83166		S4853-02510	83216	

Holiday Rambler

Holiday rambler	Gabriel	Upgrade	Holiday rambler	Gabriel	Upgrade	Holiday rambler	Gabriel	Upgrade	Holiday rambler	Gabriel	Upgrade
01809923	85029		8C2418080DB	G63623		9U9Z18125A	83122	89406	ASH-1230	89406	
01809924	83144		8C2Z-18124-D	G63622		9U9Z18125A	89406		ASH-137	83122	89406
01809925	85010		8C2Z-18125-D	G63623		ASH-1022	83209	89414	ASH-137	89406	
1C34-18045-AA	83209	89414	8C2Z18124D	G63622		ASH-1022	89414		ASH-25820	85005	89430
1C34-18045-AA	89414		8C2Z18125D	G63623		ASH-1023	83122	89406	ASH-25820	89430	
1C34-18045-JA	83209	89414	90044794	83127		ASH-1023	89406		ASH-25821	85006	
1C34-18045-JA	89414		9U94-18045-AA	83209	89414	ASH-1136	G63623		ASH-25822	83209	89414
1C3418045AA	83209	89414	9U94-18045-AA	89414		ASH-1154	G63622		ASH-25822	89414	
1C3418045AA	89414		9U94-18080-AA	83122	89406	ASH-1161	85006		ASH-25823	83209	89414
1C3418045JA	83209	89414	9U94-18080-AA	89406		ASH-1162	85005	89430	ASH-25823	89414	
1C3418045JA	89414		9U9418045AA	83209	89414	ASH-1162	89430		ASH-25824	83122	89406
24-153249	85125		9U9418045AA	89414		ASH-1205	83209	89414	ASH-25824	89406	
24-153256	85124		9U9418080AA	83122	89406	ASH-1205	89414		ASH-294	83209	89414
24-186629	85125		9U9418080AA	89406		ASH-1206	83122	89406	ASH-294	89414	
24153249	85125		9U9Z-18124-A	83209	89414	ASH-1206	89406		ASH1022	83209	89414
24153256	85124		9U9Z-18124-A	89414		ASH-1228	83209	89414	ASH1022	89414	
24186629	85125		9U9Z-18125-A	83122	89406	ASH-1228	89414		ASH1023	83122	89406
8C24-18045-DA	G63622		9U9Z-18125-A	89406		ASH-1229	83209	89414	ASH1023	89406	
8C24-18080-DB	G63623		9U9Z18124A	83209	89414	ASH-1229	89414		ASH1136	G63623	
8C2418045DA	G63622		9U9Z18124A	89414		ASH-1230	83122	89406	ASH1154	G63622	

Important Note: Competitive Interchanges are to be used for stocking purposes only. Where multiple crosses are identified, please reference the applications section of this catalog. / **Remarque importante:** Les interchanges concurrentiels ne s'utilisent qu'aux fins de stocks. Dans le cas de rfrences multiples, consulter la section des applications du catalogue. / **Nota importante:** Dans le cas de rfrences multiples, consultar la section des aplicaciones du catalogue. / **Nota importante:** Se pueden usar intercambios competitivos para propósitos de almacenamiento solamente. Cuando se identifican intercambios múltiples, consulte la sección de aplicaciones de este catálogo.

COMPETITIVE & O.E.M. INTERCHANGE LIST
Lista de Intercambios contra Competidores y Equipo Original.
Liste dinterchange de produits comptitifs & dquipement original (OEM)

Holiday Rambler... cont'd

Holiday rambler	Gabriel	Upgrade	Holiday rambler	Gabriel	Upgrade	Holiday rambler	Gabriel	Upgrade	Holiday rambler	Gabriel	Upgrade
ASH1161	85006		ASH137	89406		AT-620	83209	89414	F4-BE5-A832-MO	85125	
ASH1162	85005	89430	ASH25820	85005	89430	AT-620	89414		F4-BE5-B492-HO	85125	
ASH1162	89430		ASH25820	89430		AT-621	83122	89406	F4-BE5-F324-HO	85125	
ASH1205	83209	89414	ASH25821	85006		AT-621	89406		F4-BE5-F325-HO	85124	
ASH1205	89414		ASH25822	83209	89414	AT-766	83209	89414	F4BE5A832MO	85125	
ASH1206	83122	89406	ASH25822	89414		AT-766	89414		F4BE5B492HO	85125	
ASH1206	89406		ASH25823	83209	89414	AT163G	G63622		F4BE5F324HO	85125	
ASH1228	83209	89414	ASH25823	89414		AT164G	G63623		F4BE5F325HO	85124	
ASH1228	89414		ASH25824	83122	89406	AT620	83209	89414	U0109-007	G63183	
ASH1229	83209	89414	ASH25824	89406		AT620	89414		U0109007	G63183	
ASH1229	89414		ASH294	83209	89414	AT621	83122	89406	W0005662	85125	
ASH1230	83122	89406	ASH294	89414		AT621	89406		W0005663	85124	
ASH1230	89406		AT-163G	G63622		AT766	83209	89414	W0006254	85125	
ASH137	83122	89406	AT-164G	G63623		AT766	89414				

Holland-Binkley

Holland-binkley	Gabriel	Upgrade	Holland-binkley	Gabriel	Upgrade	Holland-binkley	Gabriel	Upgrade	Holland-binkley	Gabriel	Upgrade
680298	85321		6898	83125							

Honda

Honda	Gabriel	Upgrade	Honda	Gabriel	Upgrade	Honda	Gabriel	Upgrade	Honda	Gabriel	Upgrade
51601-S3V-315	G57119		51606-S82-A03	G56991		52610-S5D-A65	G57061		52611-S5A-N06	G57061	
51601-S3V-315	G57120		51606-S84-A03	G56991		52610-S5P-A03	G57061		52611-S5A-N06	G57062	
51601-S5A-C53	G57050		51606-S87-A03	G56991		52610-S5P-C52	G57061		52611-S5D-A06	G57061	
51601-S5A-C63	G57050		51606-S9V-A02	G56759		52610-S9V-A02	G64003		52611-S5D-A06	G57062	
51601-S9V-305	G57120		51606-S9V-A06	G56759		52610-SEP-A05	G57056		52611-S5P-A02	G57061	
51601-S9V-A04	G57120		51606-SCV-A05	G52112		52610-SEP-A06	G57056		52611-S5P-A02	G57062	
51601-SST-A04	G57050		51606-SLN-A13	G52283		52610-SEP-A08	G57056		52611-S5P-A03	G57061	
51601-SST-A12	G57050		51606-STK-A03	G52187		52610-SEP-A13	G57056		52611-S5P-A03	G57062	
51602-A84-A8	G56991		51606-STX-A05	G52249		52610-SEP-A14	G57056		52611-S6M-A21	G51914	
51602-S3V-315	G57119		51606-SZA-A02	G52360		52610-SEP-A18	G57056		52611-S80-A02	G56943	
51602-S3V-315	G57120		51611-T5R-A04	G52153		52610-SLN-A04	70060		52611-S82-A02	G56943	
51602-S5A-C53	G57049		51611-TK6-A02	G52153		52610-STK-A03	G51966		52611-S84-A04	G56943	
51602-S5A-C63	G57049		51611-TK6-A11	G52153		52610-STX-A04	G64080		52611-S87-A04	G56943	
51602-S5T-A04	G57049		51611-TK6-A51	G52153		52610-SXS-A05	G57682		52611-SCV-A02	G51858	
51602-S5T-A12	G57049		51611-TK6-A71	G52153		52610-TK6-A03	G51905		52611-SEC-A02	G51847	
51602-S80-A17	G56991		51611-TX9-A03	G52153		52610-TK6-A13	G51905		52611-SEC-A04	G51847	
51602-S82-A27	G56991		51621-T5R-A04	G52152		52610-TK6-A51	G51905		52611-SEP-A04	G51738	
51602-S9V-305	G57119		51621-TK6-A02	G52152		52610-TK6-A71	G51905		52611-SEP-A06	G51738	
51602-S9V-A04	G57119		51621-TK6-A11	G52152		52610-TR0-A02	G511092		52611-SEP-A12	G51738	
51605-S3V-305	G56758		51621-TK6-A51	G52152		52610-TR0-A12	G511092		52611-SEP-A17	G51738	
51605-S3V-305	G56759		51621-TK6-A71	G52152		52610-TR0-A24	G511092		52611-SWA-A02	G57682	
51605-S3V-A11	G52141		51621-TX9-A03	G52152		52610-TR2-A03	G511092		52611-SWA-A11	G57682	
51605-S5A-C21	G57050		51802-S87-A08	G56991		52610-TR2-B04	G511092		52611-T2A-A13	G51892	
51605-S9V-A02	G56758		51920-S0X-A02	143315		52610-TR5-A01	G511092		52611-T2B-A03	G51892	
51605-S9V-A06	G56758		51920-S6M-014	143353		52610-TR5-B03	G511092		52611-T2F-A02	G51892	
51605-SCV-A04	G52113		51920-SNW-Z01	143353		52610-TR7-A02	G511092		52611-T2F-A12	G51892	
51605-SCV-A05	G52113		51920-TR0-A01	143353		52610-TR7-B03	G511092		52611-T3L-A12	G51892	
51605-SLN-A13	G52282		51920-TR0-A11	143353		52610-TR7-B14	G511092		52611-TA0-A51	G51892	
51605-STK-A03	G52188		51920-TR7-A11	143353		52610-TS8-A03	G511092		52611-TL2-A01	G51919	
51605-STX-A05	G52250		51925-S6M-014	143353		52610-TS8-B03	G511092		52620-S5A-A11	G57062	
51605-SZA-A02	G52361		52610-S3V-305	G64003		52610-TS8-B32	G511092		52620-S5A-A13	G57062	
51606-S3V-305	G56758		52610-S3V-A05	G64003		52610-TS9-A02	G511092		52620-S5A-C02	G57062	
51606-S3V-305	G56759		52610-S5A-A13	G57061		52610-TS9-B03	G511092		52620-S5D-A14	G57062	
51606-S3V-A11	G52140		52610-S5A-C02	G57061		52610-TS9-B14	G511092		52620-S5D-A65	G57062	
51606-S5A-C21	G57049		52610-S5A-C11	G57061		52611-S5A-A02	G57061		52620-S5P-C52	G57062	
51606-S80-A03	G56991		52610-S5D-A14	G57061		52611-S5A-A02	G57062		52650-S5P-A03	G57062	

Important Note: Competitive Interchanges are to be used for stocking purposes only. Where multiple crosses are identified, please reference the applications section of this catalog. / **Remarque importante:** Les interchanges concurrentiels ne s'utilisent qu'aux fins de stocks. Dans le cas de rferences multiples, consulter la section des applications du catalogue. / **Nota importante:** Dans le cas de rferences multiples, consulter la section des applications du catalogue. / **Nota importante:** Se pueden usar intercambios competitivos para propósitos de almacenamiento solamente. Cuando se identifican intercambios múltiples, consulte la sección de aplicaciones de este catálogo.

COMPETITIVE & O.E.M. INTERCHANGE LIST

Lista de Intercambios contra Competidores y Equipo Original.

Liste d'interchange de produits compititifs & d'equipement original (OEM)

Hutchens Suspension

Hutchens suspension	Gabriel	Upgrade	Hutchens suspension	Gabriel	Upgrade	Hutchens suspension	Gabriel	Upgrade	Hutchens suspension	Gabriel	Upgrade
9423-00	83203	89436	9423-00	89436		942300	83203	89436	942300	89436	

Hyundai

Hyundai	Gabriel	Upgrade	Hyundai	Gabriel	Upgrade	Hyundai	Gabriel	Upgrade	Hyundai	Gabriel	Upgrade
OK32B-28-700	69585		54650-26100	G56562		54661-3Q010	G52330		55310-2B101	G64048	
OK53A-28-700E	70000		54650-2B100	G52158		54661-3V280	G52438		55310-4D100	G64071	
54610-1G505	143409		54651-2G300	G52247		54661-3V281	G52438		55310-4D401	G64071	
54610-1G555	143410		54651-3Q010	G52329		54661-3V900	G52438		55310-4D500	G64071	
54610-26000	143087		54651-3V280	G52437		54661-3X151	G52439		55310-4Z000	G64143	
54610-2B000	143416		54651-3V281	G52437		54661-4D001	G52258		55310-4Z100	G64143	
54610-2C000	143397		54651-3V900	G52437		54661-4D101	G52258		55310-B8300	G64143	
54610-4D000	143416		54651-3X151	G52438		55300-1W200	70095		55310-FD150	70001	
54611-38610	G51714		54651-4D100	G52257		55300-2V050	70068		55311-2G300	70049	
54611-3K060	G57149		54651-4D101	G52257		55300-2V620	70068		55311-3L040	70013	
54611-3L040	G51806		54660-1E200	G52155		55300-2V820	70068		55311-3L640	70013	
54611-3L041	G51806		54660-1G100	G52155		55300-3X200	70098		55311-3Q610	70068	
54611-3L640	G51806		54660-1W030	G52354		55305-26500	69907		55311-3Q710	70068	
54650-1E200	G52154		54660-26100	G56561		55310-1E100	70036		55311-3V080	70068	
54650-1G100	G52154		54660-2B100	G52159		55310-1E150	70036		55311-4R010	70068	
54650-1W030	G52353		54661-2G300	G52248		55310-1G110	70036		Q0K52-Y3-4380Q	143458	

IC Corporation

Ic corporation	Gabriel	Upgrade	Ic corporation	Gabriel	Upgrade	Ic corporation	Gabriel	Upgrade	Ic corporation	Gabriel	Upgrade
1660846C92	83101		3578105C2	83163		3902993C1	83135		501906C92	83317	
1675455C1	85003	89411	3578858C2	85656		3902993C2	83135		537524C91	83123	89405
1675455C1	89411		3601600C3	85082		3902993C3	83135		537524C91	89405	
2018987C1	85003	89411	3604282C1	85351		472412C91	83456	89447	6127088C1	83163	
2018987C1	89411		3605735C1	83169		472412C91	89447		6127713C1	85656	
2200327C1	85332		3605735C2	83169		501553C91	85003	89411	6127713C2	85656	
3533356C3	83169		3609400C1	83317		501553C91	89411		OE13402S	83163	
3578105C1	83163		3609400C2	83317		501906C91	83317		OE13424S	83317	

Ingersoll Axles

Ingersoll axles	Gabriel	Upgrade	Ingersoll axles	Gabriel	Upgrade	Ingersoll axles	Gabriel	Upgrade	Ingersoll axles	Gabriel	Upgrade
653511-01	85323	89436	653511-03	85045		65351101	89436		65351104	85052	
653511-01	89436		653511-04	85052		65351102	85938				
653511-02	85938		65351101	85323	89436	65351103	85045				

International

International	Gabriel	Upgrade	International	Gabriel	Upgrade	International	Gabriel	Upgrade	International	Gabriel	Upgrade
1201-0012	83023		12011044	83025		1202-1212	83013		1667520C1	89431	
1201-0154	83051		12011049	83025		1202-1213	83005		1675455C1	85003	89411
1201-0254	83051		12011212	83013		12020012	83023		1675455C1	89411	
1201-1043	83025		12011213	83005		12020032	83016		1677707C1	85030	89440
1201-1044	83025		12019007	83054		12020042	83025		1677707C1	89440	
1201-1049	83025		12019008	83054		12020043	83025		1690035C1	85003	89411
1201-1212	83013		12019009	83054		12020044	83025		1690035C1	89411	
1201-1213	83005		12019010	83053		12020054	83021		2012768C1	83013	
1201-9007	83054		12019011	83053		12021043	83025		2012769C1	83005	
1201-9008	83054		12019013	83062		12021044	83025		2012769C2	83005	
1201-9009	83054		12019014	83062		12021212	83013		2015556C1	85316	89426
1201-9010	83053		12019018	83062		12021213	83005		2015556C1	89426	
1201-9011	83053		12019021	83062		1660846C91	83101		2015557C1	85030	89440
1201-9013	83062		1202-0012	83023		1660846C92	83101		2015557C1	89440	
1201-9014	83062		1202-0032	83016		1663471C1	83103		2018987C1	85003	89411
1201-9018	83062		1202-0042	83025		1663606C91	85027		2018987C1	89411	
1201-9021	83062		1202-0043	83025		1664149C1	85029		2018987C2	85003	89411
12010012	83023		1202-0044	83025		1664524C1	85935				
12010154	83051		1202-0054	83021		1664788C2	85316	89426			
12010254	83051		1202-1043	83025		1664788C2	89426				
12011043	83025		1202-1044	83025		1667520C1	85058	89431			

Important Note: Competitive Interchanges are to be used for stocking purposes only. Where multiple crosses are identified, please reference the applications section of this catalog. / **Remarque importante:** Les interchanges concurrentiels ne s'utilisent qu'aux fins de stocks. Dans le cas de rferences multiples, consulter la section des applications du catalogue. / **Nota importante:** Dans le cas de rferences multiples, consulter la section des applications du catalogue. / **Nota importante:** Se pueden usar intercambios competitivos para propósitos de almacenamiento solamente. Cuando se identifican intercambios múltiples, consulte la sección de aplicaciones de este catálogo.

COMPETITIVE & O.E.M. INTERCHANGE LIST
Lista de Intercambios contra Competidores y Equipo Original.
Liste dinterchange de produits comptitifs & dquipement original (OEM)

International... cont'd

International	Gabriel	Upgrade	International	Gabriel	Upgrade	International	Gabriel	Upgrade	International	Gabriel	Upgrade
2018987C2	89411		306444C91	85012	89413	3571711C1	85316	89426	3601600C3	85082	
2023684C1	83015		306444C91	89413		3571711C1	89426		3604282C1	85351	
2023685C1	83015		3085640C92	83216		3571713C1	85333		360444C91	85012	89413
2025790C1	83013		308646C91	85012	89413	3573265C1	85931	89458	360444C91	89413	
2029200C91	83126	89430	308646C91	89413		3573265C1	89458		3606770C1	83163	
2029200C91	85030	89440	308648C91	83225		3576464C1	85957		3606770C2	83163	
2029200C91	89430		308649C91	83216		3576464C2	85957		3606857C1	85954	
2029200C91	89440		308650C91	83216		3576465C1	85929		3606857C2	85954	
2032533C1	85316	89426	308650C92	83216		3576465C2	85929		3606857C3	85994	
2032533C1	89426		308664C91	85307		3578105C1	83163		3606859C1	85954	
2039549C1	85333		308668C91	85012	89413	3578105C2	83163		3606859C2	85954	
204994R91	83225		308668C91	89413		3578858C1	85656		3606859C3	85994	
206620R91	83216		308668C92	85012	89413	3578858C2	85656		3609178C1	85955	
206621R91	83216		308668C92	89413		3581106C1	85924	89457	3609400C1	83317	
206621R92	83216		308669C91	85012	89413	3581106C1	89457		3609400C2	83317	
208664C91	85307		308669C91	89413		3581106C2	85924	89457	3610198C1	85963	
210533R91	83225		320444C91	85012	89413	3581106C2	89457		3610199C1	85964	
210534R92	83225		320444C91	89413		3581106C3	85924	89457	3613984C1	85955	
210535R91	83225		329316C92	85012	89413	3581106C3	89457		3620395C1	85931	89458
210536R91	83225		329316C92	89413		3581107C1	85924	89457	3620395C1	89458	
210537R91	83225		3501427C1	619501		3581107C1	89457		3626571C1	85072	
210538R91	83225		350425C1	85300	89419	3581107C2	85924	89457	3626571C2	85072	
210918R91	83215		350425C1	89419		3581107C2	89457		3660548C1	85955	
210919R91	85307		350426C1	85734		3581107C3	85924	89457	3660549C1	85955	
210920R91	85308	89422	350426C91	85734		3581107C3	89457		3668566C1	85954	
210920R91	89422		3514952C1	85976		3581109C1	85924	89457	3670156C1	85954	
2200327C1	85332		3515265C1	83112		3581109C1	89457		3674348C1	85954	
2500013C1	83013		3515265C2	83112		3581109C3	85924	89457	3688614C1	85923	89458
2503529C1	83025		3533356C1	83135		3581109C3	89457		3688614C1	89458	
2507948C1	83054		3533356C2	83135		3581109C4	85924	89457	3688615C1	85931	89458
2508326C1	83021		3533356C3	83169		3581109C4	89457		3688615C1	89458	
2508327C1	83025		3533357C1	85957		3584116C1	83175		3688616C1	85923	89458
2509221C91	83054		3533357C2	85957		3584116C2	83175		3688616C1	89458	
2509222C91	83053		3533357C3	85957		3584117C1	83135		3688729C1	85931	89458
2509223C91	83054		3541456C1	85929		3584117C2	83135		3688729C1	89458	
2509223C92	83054		3544768C1	85656		3584118C1	85928		3688732C1	85931	89458
2509224C91	83053		3544768C2	85656		3584118C2	85928		3688732C1	89458	
2585145C1	83051		3549099C1	85923	89458	3584535C1	85924	89457	3737574C1	85954	
2589922C1	83051		3549099C1	89458		3584535C1	89457		3737575C1	85954	
2590915C1	83062		3549099C2	85923	89458	3584535C2	85924	89457	3737576C1	85931	89458
2590916C1	83062		3549099C2	89458		3584535C2	89457		3737576C1	89458	
2593803C91	83062		3549099C3	85923	89458	3584535C3	85924	89457	3806341C3	85995	
2595314C1	83062		3549099C3	89458		3584535C3	89457		3806341C4	85995	
2597458C91	83062		3549100C1	85656		3586883C1	85931	89458	3810581C3	85995	
2600491C91	83062		3553628C1	85927		3586883C1	89458		3810581C4	85995	
2601488C91	83062		3553628C2	85927		3586902C2	83364		3812837C1	85954	
2602021C1	83062		3553628C3	85927		3586902C3	83364		3813340C1	85964	
288920C91	83225		3553628C4	85927		3588209C1	85957		3813340C2	85964	
288921C91	83225		3557165C1	83053		3588209C2	85957		3813340C3	85964	
288921R92	83225		3557167C3	83053		3596107C1	85927		3813340C4	85964	
293009C91	85308	89422	3558089C1	85648		3596107C2	85927		3813341C1	85963	
293009C91	89422		3558089C2	85648		3596107C3	85927		3813341C2	85963	
294334C91	83216		3558089C3	85648		3596107C4	85927		3813341C3	85963	
3000070C91	83456	89447	3558989C1	85648		3596878C2	85648		3813341C4	85963	
3000070C91	89447		3558989C2	85648		3601600C1	85082		3816234C1	85929	
3000098C1	83317		3560705C2	83054		3601600C2	85082		3821760C1	85931	89458

Important Note: Competitive Interchanges are to be used for stocking purposes only. Where multiple crosses are identified, please reference the applications section of this catalog. / **Remarque importante:** Les interchanges concurrentiels ne s'utilisent qu'aux fins de stocks. Dans le cas de références multiples, consulter la section des applications du catalogue. / **Nota importante:** Dans le cas de références multiples, consulter la section des applications du catalogue. / **Nota importante:** Se pueden usar intercambios competitivos para propósitos de almacenamiento solamente. Cuando se identifican intercambios múltiples, consulte la sección de aplicaciones de este catálogo.

COMPETITIVE & O.E.M. INTERCHANGE LIST
Lista de Intercambios contra Competidores y Equipo Original.
Liste dinterchange de produits comptitifs & dquipement original (OEM)

International... cont'd

International	Gabriel	Upgrade	International	Gabriel	Upgrade	International	Gabriel	Upgrade	International	Gabriel	Upgrade
3821760C1	89458		4170820C1	619501		467372C91	83225		57905-001	85976	
383379C91	83308		4205983C1	83397		467983C91	85012	89413	57905001	85976	
384435C91	83216		4206863C1	83398		467983C91	89413		586724C91	83456	89447
3868265C1	85995		4207304C1	83397		467984C91	83216		586724C91	89447	
3885832C1	83135		4208946C1	83398		467985C91	85012	89413	596329C1	85014	
3885832C2	83135		4211080C1	85957		467985C91	89413		60657-003	85072	
3892445C3	85931	89458	4212927C1	85929		471201C91	85012	89413	60657-003L	85072	
3892445C3	89458		4212932C1	85931	89458	471201C91	89413		60657-006	85102	
3892458C1	85656		4212932C1	89458		471203C91	83308		60657-010	85102	
3892458C2	85656		4212942C1	85639		472367C91	83318		60657-011	85102	
3902993C1	83135		4213758C1	85639		472411C91	83456	89447	60657003	85072	
3902993C3	83135		4213760C1	83163		472411C91	89447		60657003L	85072	
3914952C1	85976		4214011C2	85670		472412C91	83456	89447	60657006	85102	
3945165C1	83180		426744R91	85303	89422	472412C91	89447		60657010	85102	
3977759C2	85639		426744R91	89422		472414C91	83318		60657011	85102	
3983162C1	85639		426744R92	85303	89422	474002C91	83308		60665-013	85965	
3983162C2	85639		426744R92	89422		477132C1	85303	89422	60665013	85965	
3989717C1	83135		446-51-211	85739		477132C1	89422		60670-007	83144	
3991991C1	83135		44651211	85739		47902-24	83137		60670-007L	83144	
4050340C1	85931	89458	452566C91	83225		4790224	83137		60670007	83144	
4050340C1	89458		453527C91	85311	89424	4C4Z-18124-N	85957		60670007L	83144	
4050340C2	85931	89458	453527C91	89424		4C4Z-18125-DA	85656		60675-003	85976	
4050340C2	89458		453528C91	85311	89424	4C4Z18124N	85957		60675-003L	85976	
4050443C1	85994		453528C91	89424		4C4Z18125DA	85656		60675003	85976	
4050443C2	85994		453556C91	85012	89413	501506C91	83317		60675003L	85976	
4050444C1	85994		453556C91	89413		501553C91	85003	89411	60680-003	83112	
4050444C2	85994		453561C91	83225		501553C91	89411		60680-003L	83112	
4055574C2	83907		453562C91	83225		501905C91	83301		60680-004	83143	
4060267C4	83909		453564C91	85012	89413	501906C91	83317		60680-004L	83143	
4069426C1	85642		453564C91	89413		501906C92	83317		60680-005	83142	
4069434C1	85642		453565C91	83225		503550C1	83207	89407	60680-005L	83142	
4069435C1	85642		453566C91	83225		503550C1	89407		60680003	83112	
4070336C1	85058	89431	453567C91	83216		503610C1	83207	89407	60680003L	83112	
4070336C1	89431		453568C91	83225		503610C1	89407		60680004	83143	
4070352C1	85648		453569C91	83225		503610C2	83207	89407	60680004L	83143	
4072186C1	85928		453570C91	83216		503610C2	89407		60680005	83142	
4089293C1	83397		453571C91	83216		507202C1	85030	89440	60680005L	83142	
4109458C2	83243		453572C91	83309		507202C1	89440		6127086C1	85637	
4109582C1	83397		453574C91	85307		534464C1	85734		6127087C1	83364	
4109583C1	83397		453575C91	83308		537524C91	83123	89405	6127088C1	83163	
4164142C1	83244		453576C91	85303	89422	537524C91	89405		6127096C1	83180	
4164145C1	85672		453576C91	89422		537525C91	83123	89405	6127666C1	85642	
4164146C1	83169		453576C92	85303	89422	537525C91	89405		6127688C1	83169	
4164147C1	85671		453576C92	89422		540395C91	83613		6127690C1	85923	89458
4164148C1	85003	89411	453577C91	85308	89422	540395C92	83613		6127690C1	89458	
4164148C1	89411		453577C91	89422		548532C1	83103		6127700C1	83395	
4164149C1	85923	89458	453579C91	85308	89422	56101 Z1030	85311	89424	6127704C1	85670	
4164149C1	89458		453579C91	89422		56101 Z1030	89424		6127705C1	85924	89457
4164150C1	85995		462557C91	85300	89419	56101 Z2000	85311	89424	6127705C1	89457	
4164152C1	85924	89457	462557C91	89419		56101 Z2000	89424		6127713C1	85656	
4164152C1	89457		462603C91	85705	89447	56101 Z5008	83114		6127713C2	85656	
4164155C1	85058	89431	462603C91	89447		56101 Z5011	G63610		6127714C1	85928	
4164155C1	89431		462753C91	83216		56110-T8123	G63432		65992-001	85955	
4164156C1	85924	89457	463926C91	85705	89447	56110-T8129	G63432		65992-002	85955	
4164156C1	89457		463926C91	89447		56110T8123	G63432		65992-002L	85955	
4164161C1	85929		467371C91	83225		56110T8129	G63432		65992001	85955	

Important Note: Competitive Interchanges are to be used for stocking purposes only. Where multiple crosses are identified, please reference the applications section of this catalog. / **Remarque importante:** Les interchanges concurrentiels ne s'utilisent qu'aux fins de stocks. Dans le cas de références multiples, consulter la section des applications du catalogue. / **Nota importante:** En el caso de referencias múltiples, consultar la sección de aplicaciones del catálogo. / **Nota importante:** Se pueden usar intercambios competitivos para propósitos de almacenamiento solamente. Cuando se identifican intercambios múltiples, consulte la sección de aplicaciones de este catálogo.

COMPETITIVE & O.E.M. INTERCHANGE LIST
Lista de Intercambios contra Competidores y Equipo Original.
Liste dinterchange de produits comptitifs & dquipement original (OEM)

International... cont'd

International	Gabriel	Upgrade	International	Gabriel	Upgrade	International	Gabriel	Upgrade	International	Gabriel	Upgrade
65992002	85955		874696R91	89413		AMS650402	85311	89424	H60657006	85102	
65992002L	85955		90044025	83209	89414	AMS650402	89424		H60657010	85102	
66400	G63432		90044025	89414		AMS650404	85310	89423	H60657011	85102	
6ETZ-18125-A	83364		90044626	83126	89430	AMS650404	89423		H60665013	85965	
6ETZ18125A	83364		90044626	89430		AMS650405	85023	89415	H60675-003	85976	
70334	85316	89426	AMS600102	85005	89430	AMS650405	89415		H60675003	85976	
70334	89426		AMS600102	89430		AMS650406	85024		H60680-003	83112	
790335C91	83209	89414	AMS600172	83126	89430	AMS650408	85319	89428	H60680003	83112	
790335C91	89414		AMS600172	85005	89430	AMS650408	89428		H60680004	83143	
800670	85060		AMS600172	85030	89440	AMS650420	85013	89414	HDR60680-005	83142	
873619C92	83314		AMS600172	89430		AMS650420	89414		HDR60680005	83142	
873619C93	83314		AMS600172	89440		AMS65145	85671		OE 18513	83135	
873622C91	83308		AMS650102	85001	89410	AMS66161	83053		OE13402S	83163	
874695R91	85012	89413	AMS650102	89410		H60657-003	85072		OE13424S	83317	
874695R91	89413		AMS650107	85316	89426	H60657-006	85102		OE14771	83062	
874695R92	85012	89413	AMS650107	89426		H60657-010	85102		OE17103	83135	
874695R92	89413		AMS650400	85033	89427	H60657-011	85102				
874696R91	85012	89413	AMS650400	89427		H60657003	85072				

Isuzu

Isuzu	Gabriel	Upgrade	Isuzu	Gabriel	Upgrade	Isuzu	Gabriel	Upgrade	Isuzu	Gabriel	Upgrade
1-51630-160-0	83162		8-22064-807-0	83136		8-98343986-0	83159		8982326720	83515	
1-51630-167-0	83613		8-22064232-0	85071		8-98380-746-0	83159		8982326721	83515	
1-51630-168-1	83515		8-22064233-0	83136		8-98380-747-0	83159		8983162280	83159	
1-51630-217-0	83114		8-22064804-0	83136		8-98381-010-0	83515		8983219121	85071	
1-51630-217-1	83114		8-22064805-0	83136		8-98381-012-0	83515		8983807460	83159	
1-51630-219-0	83114		8-94454-647-1	83515		8220642320	85071		8983807470	83159	
1-51630-219-1	83114		8-94454-986-0	83515		8220642330	83136		8983810100	83515	
12474915	83122	89406	8-94454-987-0	83515		8220648040	83136		8983810120	83515	
12474915	89406		8-97083-027-0	83515		8220648050	83136		9-51630-647-1	83515	
15123676	83136		8-97083-029-0	83515		8220648060	83136		9-51630-666-0	85012	89413
1516301600	83162		8-97253-616-0	83515		8220648070	83136		9-51630-666-0	89413	
1516301670	83613		8-97253-620-0	83515		88982682	83136		9-51630-666-2	85012	89413
1516301681	83515		8-97253-620-1	83515		88982686	85071		9-51630-666-2	89413	
15174902	85071		8-97253-621-0	83515		8944549870	83515		94454986	83515	
15887728	83136		8-97253-623-0	83515		8970830270	83515		94454987	83515	
19152843	83136		8-97253-651-2	83159		8970830290	83515		9516306660	85012	89413
5002465	83166		8-97253-664-0	83159		8972019600	83515		9516306660	89413	
51630168	83515		8-97253-665-0	83159		8972536160	83515		9516306662	85012	89413
51630217	83114		8-97517-966-0	83137		8972536200	83515		9516306662	89413	
51630219	83114		8-97517-966-1	83137		8972536201	83515		97083027	83515	
51630647	83515		8-98098-058-0	83159		8972536210	83515		97083029	83515	
51630666	85012	89413	8-98098-058-1	83159		8972536230	83515		97253620	83515	
51630666	89413		8-98098-059-0	83159		8975179660	83137		97253651	83159	
5872000750	83159		8-98098-059-1	83159		8975179661	83137		97253664	83159	
5872001100	83515		8-98098-125-0	83515		898098-0581	83159		97253665	83159	
60670-005	83137		8-98098-127-0	83515		898098-1250	83515		98098058	83159	
60670-005L	83137		8-98232671-0	83515		898098-1270	83515		98098059	83159	
60670005	83137		8-98232671-1	83515		8980980590	83159		98098125	83515	
60670005L	83137		8-98232672-0	83515		8980980591	83159		98098127	83515	
8-22064-233-0	83136		8-98232672-1	83515		8980981250	83515		98232671	83515	
8-22064-804-0	83136		8-98316-228-0	83159		8980981270	83515		98232672	83515	
8-22064-805-0	83136		8-98316227-0	83159		8982326710	83515		98316227	83159	
8-22064-806-0	83136		8-98321-912-1	85071		8982326711	83515		98343986	83159	

Itasca

Itasca	Gabriel	Upgrade	Itasca	Gabriel	Upgrade	Itasca	Gabriel	Upgrade	Itasca	Gabriel	Upgrade
141700131809	85029		16-16736-000	85029							
141700131810	83160		16-16737-000	83160							

Important Note: Competitive Interchanges are to be used for stocking purposes only. Where multiple crosses are identified, please reference the applications section of this catalog. / **Remarque importante:** Les interchanges concurrentiels ne s'utilisent qu'aux fins de stocks. Dans le cas de rferences multiples, consulter la section des applications du catalogue. / **Nota importante:** Dans le cas de rferences multiples, consulter la section des applications du catalogue. / **Nota importante:** Se pueden usar intercambios competitivos para propósitos de almacenamiento solamente. Cuando se identifican intercambios múltiples, consulte la sección de aplicaciones de este catálogo.

COMPETITIVE & O.E.M. INTERCHANGE LIST

Lista de Intercambios contra Competidores y Equipo Original.

Liste d'interchange de produits compititifs & d'equpement original (OEM)

Itasca... cont'd

Itasca	Gabriel	Upgrade	Itasca	Gabriel	Upgrade	Itasca	Gabriel	Upgrade	Itasca	Gabriel	Upgrade
16-16873-000	85029		8C2Z-18124-D	G63622		ASH-1229	83209	89414	AT-620	83209	89414
16-16874-000	83160		8C2Z-18125-D	G63623		ASH-1229	89414		AT-620	89414	
16-18103-000	85900		9U94-18045-AA	83209	89414	ASH-1230	83122	89406	AT-621	83122	89406
1616736000	85029		9U94-18045-AA	89414		ASH-1230	89406		AT-621	89406	
1616737000	83160		9U94-18080-AA	83122	89406	ASH-137	83122	89406	AT-766	83209	89414
1616873000	85029		9U94-18080-AA	89406		ASH-137	89406		AT-766	89414	
1616874000	83160		9U9418080AA	83122	89406	ASH-25822	83209	89414	AT621	83122	89406
1618103000	85900		9U9418080AA	89406		ASH-25822	89414		AT621	89406	
1C34-18045-AA	83209	89414	9U9Z-18124-A	83209	89414	ASH-25823	83209	89414	F4-BE5-A832-MO	85125	
1C34-18045-AA	89414		9U9Z-18124-A	89414		ASH-25823	89414		F4-BE5-B492-HO	85125	
1C34-18045-JA	83209	89414	9U9Z-18125-A	83122	89406	ASH-25824	83122	89406	F4-BE5-C832-MO	83124	89407
1C34-18045-JA	89414		9U9Z-18125-A	89406		ASH-25824	89406		F4-BE5-C832-MO	89407	
24-153249	85125		9U9Z18125A	83122	89406	ASH-294	83209	89414	F4-BE5-F324-HO	85125	
24-153256	85124		9U9Z18125A	89406		ASH-294	89414		F4-BE5-F325-HO	85124	
24-186629	85125		ASH-1022	83209	89414	ASH1023	83122	89406	F4BE5A832MO	85125	
24153249	85125		ASH-1022	89414		ASH1023	89406		F4BE5B492HO	85125	
24153256	85124		ASH-1023	83122	89406	ASH1206	83122	89406	F4BE5C832MO	83124	89407
24186629	85125		ASH-1023	89406		ASH1206	89406		F4BE5C832MO	89407	
481700000490	85900		ASH-1136	G63623		ASH1230	83122	89406	F4BE5F324HO	85125	
481700000493	85900		ASH-1154	G63622		ASH1230	89406		F4BE5F325HO	85124	
66153-002	83124	89407	ASH-1205	83209	89414	ASH137	83122	89406	W0005662	85125	
66153-002	89407		ASH-1205	89414		ASH137	89406		W0005663	85124	
66153002	83124	89407	ASH-1206	83122	89406	ASH25824	83122	89406	W0006254	85125	
66153002	89407		ASH-1206	89406		ASH25824	89406				
8C24-18045-DA	G63622		ASH-1228	83209	89414	AT-163G	G63622				
8C24-18080-DB	G63623		ASH-1228	89414		AT-164G	G63623				

Jayco RV Inc.

Jayco rv inc.	Gabriel	Upgrade	Jayco rv inc.	Gabriel	Upgrade	Jayco rv inc.	Gabriel	Upgrade	Jayco rv inc.	Gabriel	Upgrade
10-13976-000	85918	89449	16-16764-000	89443		ASH-1229	83209	89414	ASH-25823	89414	
10-13976-000	89449		1616764000	85724	89443	ASH-1229	89414		ASH-25824	83122	89406
1013976000	85918	89449	1616764000	89443		ASH-25822	83209	89414	ASH-25824	89406	
1013976000	89449		ASH-1136	G63623		ASH-25822	89414		ASH25824	83122	89406
16-16764-000	85724	89443	ASH-1154	G63622		ASH-25823	83209	89414	ASH25824	89406	

John Deere

John deere	Gabriel	Upgrade	John deere	Gabriel	Upgrade	John deere	Gabriel	Upgrade	John deere	Gabriel	Upgrade
3638112	G63183		4036892	G63605							

Kenworth

Kenworth	Gabriel	Upgrade	Kenworth	Gabriel	Upgrade	Kenworth	Gabriel	Upgrade	Kenworth	Gabriel	Upgrade
02-02736-2	85302	89420	02-02739-2	89414		0202737PLUS	85062	89408	03-04176PLUS	89422	
02-02736-2	89420		02-02739PLUS	85013	89414	0202737PLUS	89408		03-04176PLUS-2	85308	89422
02-02736PLUS	85302	89420	02-02739PLUS	89414		0202738PLUS	85012	89413	03-06084PLUS	85033	89427
02-02736PLUS	89420		02-02740-2	85036	89405	0202738PLUS	89413		03-06084PLUS	89427	
02-02736PLUS-2	85302	89420	02-02740-2	89405		0202738PLUS2	85012	89413	03-06084PLUS-2	85031	
02-02736PLUS-2	89420		02-02741-2	85012	89413	0202738PLUS2	89413		03-06084PLUS-2	85033	89427
02-02737-2	85062	89408	02-02741-2	89413		02027392	85013	89414	03-06084PLUS-2	89427	
02-02737-2	89408		02-02742-2	85062	89408	02027392	89414		03-07421PLUS	85311	89424
02-02737PLUS	85062	89408	02-02742-2	89408		0202739PLUS	85013	89414	03-07421PLUS	89424	
02-02737PLUS	89408		02-04010-2	85012	89413	0202739PLUS	89414		03-07423-2	85033	89427
02-02737PLUS-2	85062	89408	02-04010-2	89413		02027402	85036	89405	03-07423-2	89427	
02-02737PLUS-2	89408		02-0739PLUS-2	85013	89414	02027402	89405		03-07423PLUS	85033	89427
02-02738-2	85012	89413	02-0739PLUS-2	89414		02027412	85012	89413	03-07423PLUS	89427	
02-02738-2	89413		02027362	85302	89420	02027412	89413		03-07423PLUS-2	85033	89427
02-02738PLUS	85012	89413	02027362	89420		02040102	85012	89413	03-07423PLUS-2	89427	
02-02738PLUS	89413		0202736PLUS	85302	89420	02040102	89413				
02-02738PLUS-2	85012	89413	0202736PLUS	89420		020739PLUS2	85013	89414			
02-02738PLUS-2	89413		0202736PLUS2	85302	89420	020739PLUS2	89414				
02-02739-2	85013	89414	0202736PLUS2	89420		03-04176PLUS	85308	89422			

Important Note: Competitive Interchanges are to be used for stocking purposes only. Where multiple crosses are identified, please reference the applications section of this catalog. / Remarque importante: Les interchanges concurrentiels ne s'utilisent qu'aux fins de stocks. Dans le cas de rferences multiples, consulter la section des applications du catalogue. / Nota importante: Dans le cas de rferences multiples, consulter la section des applications du catalogue. / Nota importante: Se pueden usar intercambios competitivos para propósitos de almacenamiento solamente. Cuando se identifican intercambios múltiples, consulte la sección de aplicaciones de este catálogo.

COMPETITIVE & O.E.M. INTERCHANGE LIST
Lista de Intercambios contra Competidores y Equipo Original.
Liste dinterchange de produits comptitifs & dquipement original (OEM)

Kenworth... cont'd

Kenworth	Gabriel	Upgrade	Kenworth	Gabriel	Upgrade	Kenworth	Gabriel	Upgrade	Kenworth	Gabriel	Upgrade
03-08350-2	85343		1202-1043	83025		3166657	85700		60680004L	83143	
03-08781	85069	89455	1202-1046	83049		471700004420	85109		60680005	83142	
03-08781	89455		1202-1064	83024		471700004423	85109		60680005L	83142	
03-08781-2	85069	89455	1202-1065	83002		471700013186	85109		64178-001	83143	
03-08781-2	89455		1202-1164	83031		47902-13PLUS	83122	89406	64178001	83143	
0304176PLUS	85308	89422	1202-1264	83031		47902-13PLUS	89406		665092	83312	89409
0304176PLUS	89422		1202-1286	83056		47902-19	83123	89405	665092	89409	
0306084PLUS	85033	89427	1202-K065	83002		47902-19	89405		665118	83312	89409
0306084PLUS	89427		12020012	83023		47902-24	83137		665118	89409	
0306084PLUS2	85033	89427	12020032	83016		4790213PLUS	83122	89406	665174	85060	
0306084PLUS2	89427		12020042	83025		4790213PLUS	89406		665331	85740	
0307421PLUS	85311	89424	12020043	83025		4790219	83123	89405	665453	85001	89410
0307421PLUS	89424		12020044	83025		4790219	89405		665453	89410	
03074232	85033	89427	12020054	83021		4790224	83137		665565	85007	
03074232	89427		12021043	83025		60657-003	85072		665565PLUS	85007	
0307423PLUS	85033	89427	12021046	83049		60657-003L	85072		665565PLUS-2	85007	
0307423PLUS	89427		12021064	83024		60657003	85072		665565PLUS2	85007	
0307423PLUS2	85033	89427	12021065	83002		60657003L	85072		665617	85031	
0307423PLUS2	89427		12021164	83031		60665-011	85967		665617-2	85031	
03083502	85343		12021264	83031		60665-013	85965		6656172	85031	
0308781	85069	89455	12021286	83056		60665011	85967		665632	85013	89414
0308781	89455		1202K046	83049		60665013	85965		665632	89414	
03087812	85069	89455	1202K064	83024		60670-004	83123	89405	665633	85033	89427
03087812	89455		1202K065	83002		60670-004	89405		665633	89427	
10-12032-002PLUS	85320	89429	1202K164	83031		60670-005	83137		665670	85001	89410
10-12032-002PLUS	89429		1202K264	83031		60670-005L	83137		665670	89410	
10-12032-002PLUS-2	85320	89429	1202K286	83056		60670-005PLUS	83137		665680	83312	89409
10-12032-002PLUS-2	89429		16-13947-000PLUS	85319	89428	60670-005PLUS-2	83137		665680	89409	
10-12542-000PLUS	85901		16-13947-000PLUS	89428		60670-008	83123	89405	665738-2	85910	
1012032002PLUS	85320	89429	16-13947-000PLUS-2	85319	89428	60670-008	89405		665783	83123	89405
1012032002PLUS	89429		16-13947-000PLUS-2	89428		60670-008L	83123	89405	665783	89405	
1012032002PLUS2	85320	89429	16-13947-000PLUS-2	89428		60670-008L	89405		665784	83122	89406
1012032002PLUS2	89429		1613947000PLUS	85319	89428	60670-008L	89405		665784	89406	
1012542000PLUS	85901		1613947000PLUS	89428		60670-008PLUS	83123	89405	665784	89406	
11418	646177		1613947000PLUS2	85319	89428	60670-008PLUS	89405		665785	83137	
11418WAC	646177		1613947000PLUS2	89428		60670-008PLUS-2	83123	89405	665788	85000	89436
1201-0012	83023		16725-01	83126	89430	60670004	83123	89405	665788	89436	
1201-1043	83025		16725-01	89430		60670004	89405		665788-2	85000	89436
1201-1044	83025		1672501	83126	89430	60670005	83137		665788-2	89436	
1201-1046	83049		1672501	89430		60670005L	83137		665828	85067	89451
1201-1264	83031		1707378PAC	85182		60670005PLUS	83137		665828	89451	
1201-8001	83908		19495-01	83126	89430	60670008	83123	89405	665844	85069	89455
1201-8002	83081		19495-01	89430		60670008	89405		665844	89455	
12010012	83023		1949501	83126	89430	60670008	89405		665858	85070	89459
12011043	83025		1949501	89430		60670008L	83123	89405	665858	89459	
12011044	83025		2018987C1PLUS	85003	89411	60670008L	89405		665858-2	85070	89459
12011046	83049		2018987C1PLUS	89411		60670008PLUS	83123	89405	665858-2	89459	
12011264	83031		2018987C1PLUS-2	85003	89411	60670008PLUS	89405		6658582	85070	89459
12018001	83908		2018987C1PLUS-2	89411		60670008PLUS2	83123	89405	6658582	89459	
12018002	83081		2018987C1PLUS2	85003	89411	60670008PLUS2	89405		665903	85900	
1202-0012	83023		2018987C1PLUS2	89411		60675-017	85979		665906	85902	
1202-0032	83016		2027382	85012	89413	60675017	85979		665918	85900	
1202-0042	83025		2027382	89413		60680-004	83143		665926	85047	89435
1202-0043	83025		25333002	83049		60680-004L	83143		665926	89435	
1202-0044	83025		25523002	83908		60680-005	83142		665927	85901	
1202-0054	83021		25523013	83081		60680-005L	83142		665928	85062	89408
			25523024	83081		60680004	83143		665928	89408	

Important Note: Competitive Interchanges are to be used for stocking purposes only. Where multiple crosses are identified, please reference the applications section of this catalog. / **Remarque importante:** Les interchanges concurrentiels ne s'utilisent qu'aux fins de stocks. Dans le cas de rferences multiples, consulter la section des applications du catalogue. / **Nota importante:** Dans le cas de rferences multiples, consulter la section des applications du catalogue. / **Nota importante:** Se pueden usar intercambios competitivos para propósitos de almacenamiento solamente. Cuando se identifican intercambios múltiples, consulte la sección de aplicaciones de este catálogo.

COMPETITIVE & O.E.M. INTERCHANGE LIST
Lista de Intercambios contra Competidores y Equipo Original.
Liste dinterchange de produits comptitifs & dquipement original (OEM)

Kenworth... cont'd

Kenworth	Gabriel	Upgrade	Kenworth	Gabriel	Upgrade	Kenworth	Gabriel	Upgrade	Kenworth	Gabriel	Upgrade
665930	85001	89410	680303	85007		B71-6005	89460		B716018	85012	89413
665930	89410		680425	85320	89429	B71-6006	85084	89460	B716018	89413	
665931	83312	89409	680425	89429		B71-6006	89460		B716019	85989	
665931	89409		680435	85033	89427	B71-6007	85062	89408	B716020	85989	
665932	85012	89413	680435	89427		B71-6007	89408		BFRG 072	85182	
665932	89413		680473	85319	89428	B71-6008	83312	89409	C71-1002	85067	89451
665944	85900		680473	89428		B71-6008	89409		C71-1002	89451	
665944-2	85900		680475	85314	89425	B71-6010	85023	89415	C71-1002-2	85067	89451
665945	85902		680475	89425		B71-6010	89415		C71-1002-2	89451	
665945-2	85902		680476	85310	89423	B71-6011	85062	89408	C71-1002PLUS	85067	89451
665950	85902		680476	89423		B71-6011	89408		C71-1002PLUS	89451	
671052	85070	89459	680486	85310	89423	B71-6012	85119		C71-1002PLUS-2	85067	89451
671052	89459		680486	89423		B71-6013	85012	89413	C71-1002PLUS-2	89451	
671052-2	85070	89459	680586	85311	89424	B71-6013	89413		C71-1011	85069	89455
671052-2	89459		680586	89424		B71-6015	85012	89413	C71-1011	89455	
6710522	85070	89459	70701	85900		B71-6015	89413		C71-1011PLUS	85069	89455
6710522	89459		70701PLUS	85900		B71-6016	85012	89413	C71-1011PLUS	89455	
671654	85936	89456	70701PLUS-2	85900		B71-6016	89413		C71-1011PLUS-2	85069	89455
671654	89456		800670	85060		B71-6017	85910		C71-1011PLUS-2	89455	
671656	85985		8086053PLUS	85047	89435	B71-6018	85012	89413	C71-1011SPL	85069	89455
671699	85937		8086053PLUS	89435		B71-6018	89413		C71-1011SPL	89455	
671794	85067	89451	90044025PLUS	83209	89414	B71-6019	85989		C71-1013	85985	
671794	89451		90044025PLUS	89414		B71-6020	85989		C71-1014	85936	89456
671962	85936	89456	90044089	83124	89407	B711000	85031		C71-1014	89456	
671962	89456		90044089	89407		B711001	85070	89459	C71-1015	85937	
671962PLUS	85936	89456	90044089PLUS	83124	89407	B711001	89459		C71-1015 PLUS	85937	
671962PLUS	89456		90044089PLUS	89407		B711002	85001	89410	C71-1015A	85937	
671962SPL	85936	89456	90044089PLUS-2	83124	89407	B711002	89410		C71-1016	85067	89451
671962SPL	89456		90044089PLUS-2	89407		B711003	83312	89409	C71-1016	89451	
671963	85937		90045099	85906	89407	B711003	89409		C71-1017	85069	89455
671963-2	85937		90045099	89407		B716000	85959		C71-1017	89455	
675122	85001	89410	90045132	85909		B716002	85012	89413	C71-6000-2	85067	89451
675122	89410		90045605	85109		B716002	89413		C71-6000-2	89451	
680237	85303	89422	90045803	85109		B716003	85029		C71-6003	85988	
680237	89422		90045812	85109		B716004	85084	89460	C71-6004	85343	
680239	85310	89423	96027-10545	83011		B716004	89460		C71-6005	85069	89455
680239	89423		9602710545	83011		B716005	85084	89460	C71-6005	89455	
680240	85302	89420	ACHB966	83136		B716005	89460		C71-6015	85067	89451
680240	89420		B71-1000	85031		B716006	85084	89460	C71-6015	89451	
680241	85311	89424	B71-1001	85070	89459	B716006	89460		C711002	85067	89451
680241	89424		B71-1001	89459		B716007	85062	89408	C711002	89451	
680242	85308	89422	B71-1002	85001	89410	B716007	89408		C7110022	85067	89451
680242	89422		B71-1002	89410		B716008	83312	89409	C7110022	89451	
680253	85314	89425	B71-1003	83312	89409	B716008	89409		C711002PLUS	85067	89451
680253	89425		B71-1003	89409		B716010	85023	89415	C711002PLUS	89451	
680261	85062	89408	B71-6000	85959		B716010	89415		C711002PLUS2	85067	89451
680261	89408		B71-6000-2	85959		B716011	85062	89408	C711002PLUS2	89451	
680261-2	85062	89408	B71-6002	85012	89413	B716011	89408		C711011	85069	89455
680261-2	89408		B71-6002	89413		B716012	85119		C711011	89455	
680279	83209	89414	B71-6002-2	85012	89413	B716013	85012	89413	C711011PLUS	85069	89455
680279	89414		B71-6002-2	89413		B716013	89413		C711011PLUS	89455	
680280	85906	89407	B71-6003	85029		B716015	85012	89413	C711011PLUS2	85069	89455
680280	89407		B71-6003-2	85029		B716015	89413		C711011PLUS2	89455	
680281	85003	89411	B71-6004	85084	89460	B716016	85012	89413	C711011SPL	85069	89455
680281	89411		B71-6004	89460		B716016	89413		C711011SPL	89455	
680283	85740		B71-6005	85084	89460	B716017	85910		C711013	85985	

Important Note: Competitive Interchanges are to be used for stocking purposes only. Where multiple crosses are identified, please reference the applications section of this catalog. / **Remarque importante:** Les interchanges concurrentiels ne s'utilisent qu'aux fins de stocks. Dans le cas de références multiples, consulter la section des applications du catalogue. / **Nota importante:** Dans le cas de referencias multiples, consultar la sección de aplicaciones del catálogo. / **Nota importante:** Se pueden usar intercambios competitivos para propósitos de almacenamiento solamente. Cuando se identifican intercambios múltiples, consulte la sección de aplicaciones de este catálogo.

COMPETITIVE & O.E.M. INTERCHANGE LIST
Lista de Intercambios contra Competidores y Equipo Original.
Liste dinterchange de produits comptitifs & dquipement original (OEM)

Kenworth... cont'd

Kenworth	Gabriel	Upgrade	Kenworth	Gabriel	Upgrade	Kenworth	Gabriel	Upgrade	Kenworth	Gabriel	Upgrade
C711014	85936	89456	K374-28PLUS	85314	89425	K37413	85740		K37433PLUS	89409	
C711014	89456		K374-28PLUS	89425		K374131	85740		K3744	85314	89425
C711015	85937		K374-29	85310	89423	K37414	83312	89409	K3744	89425	
C711015 PLUS	85937		K374-29	89423		K37414	89409		K3745	83312	89409
C711015A	85937		K374-29-2	85310	89423	K37416	85001	89410	K3745	89409	
C711016	85067	89451	K374-29-2	89423		K37416	89410		K3747	85310	89423
C711016	89451		K374-29PLUS	85310	89423	K37426	85001	89410	K3747	89423	
C711017	85069	89455	K374-29PLUS	89423		K37426	89410		K3749	85310	89423
C711017	89455		K374-29PLUS-2	85310	89423	K374262	85001	89410	K3749	89423	
C7160002	85067	89451	K374-29PLUS-2	89423		K374262	89410		K374C31	83312	89409
C7160002	89451		K374-3	83312	89409	K37426PLUS	85001	89410	K374C31	89409	
C716003	85988		K374-3	89409		K37426PLUS	89410		K374C7	85310	89423
C716004	85343		K374-3-1	83312	89409	K37426PLUS2	85001	89410	K374C7	89423	
C716005	85069	89455	K374-3-1	89409		K37426PLUS2	89410		PP1058870	83059	
C716005	89455		K374-32	85310	89423	K37427	85001	89410	PP2582870	83012	
C716015	85067	89451	K374-32	89423		K37427	89410		R71-1004	83049	
C716015	89451		K374-32-2	85310	89423	K374272	85001	89410	R71-1005	83024	
K374-10	83215		K374-32-2	89423		K374272	89410		R71-6005	83042	
K374-10-2	83215		K374-33	83312	89409	K37428	85314	89425	R71-6007	83008	
K374-11	85001	89410	K374-33	89409		K37428	89425		R71-6008	83035	
K374-11	89410		K374-33-2	83312	89409	K374282	85314	89425	R71-6009	83081	
K374-13	85740		K374-33-2	89409		K374282	89425		R711004	83049	
K374-13-1	85740		K374-33PLUS	83312	89409	K37428PLUS	85314	89425	R711005	83024	
K374-14	83312	89409	K374-33PLUS	89409		K37428PLUS	89425		R716005	83042	
K374-14	89409		K374-33PLUS-2	83312	89409	K37429	85310	89423	R716007	83008	
K374-16	85001	89410	K374-33PLUS-2	89409		K37429	89423		R716008	83035	
K374-16	89410		K374-36	89432		K374292	85310	89423	R716009	83081	
K374-26	85001	89410	K374-4	85314	89425	K374292	89423		S-20126	85323	89436
K374-26	89410		K374-4	89425		K37429PLUS	85310	89423	S-20126	89436	
K374-26-2	85001	89410	K374-5	83312	89409	K37429PLUS	89423		S20126	85323	89436
K374-26-2	89410		K374-5	89409		K37429PLUS2	85310	89423	S20126	89436	
K374-26PLUS	85001	89410	K374-7	85310	89423	K37429PLUS2	89423		T71-1000	83031	
K374-26PLUS	89410		K374-7	89423		K3743	83312	89409	T71-1001	83031	
K374-26PLUS-2	85001	89410	K374-9	85310	89423	K3743	89409		T71-1002	83002	
K374-26PLUS-2	89410		K374-9	89423		K37431	83312	89409	T71-1003	83056	
K374-27	85001	89410	K374-C31	83312	89409	K37431	89409		T711000	83031	
K374-27	89410		K374-C31	89409		K37432	85310	89423	T711001	83031	
K374-27-2	85001	89410	K374-C7	85310	89423	K37432	89423		T711002	83002	
K374-27-2	89410		K374-C7	89423		K374322	85310	89423	T711003	83056	
K374-28	85314	89425	K37410	83215		K374322	89423		TK19679	83126	89430
K374-28	89425		K374102	83215		K37433	83312	89409	TK19679	89430	
K374-28-2	85314	89425	K37411	85001	89410	K37433	89409				
K374-28-2	89425		K37411	89410		K37433PLUS	83312	89409			

King Of The Road

King of the road	Gabriel	Upgrade	King of the road	Gabriel	Upgrade	King of the road	Gabriel	Upgrade	King of the road	Gabriel	Upgrade
141700131809	85029		16-16873-000	85029		1616737000	83160		481700000490	85900	
141700131810	83160		16-16874-000	83160		1616873000	85029		481700000493	85900	
16-16736-000	85029		16-18103-000	85900		1616874000	83160				
16-16737-000	83160		1616736000	85029		1618103000	85900				

Koni

Koni	Gabriel	Upgrade	Koni	Gabriel	Upgrade	Koni	Gabriel	Upgrade	Koni	Gabriel	Upgrade
090-2209-SP2	89410		30-1366	G63610		30-1457	G63781		30-1606	G63423	
30-1348	G63424		30-1381	G63426		30-1501	G63608		30-1607	G63422	
30-1350	G63511		30-1421	G63547		30-1502	G63679		30-1614	G63678	
30-1351	G63490		30-1422	G63548		30-1565	G63707		30-1624	G63424	
30-1365	G63611		30-1456	G63782		30-1566	G63708		30-1627	G63690	

Important Note: Competitive Interchanges are to be used for stocking purposes only. Where multiple crosses are identified, please reference the applications section of this catalog. / **Remarque importante:** Les interchanges concurrentiels ne s'utilisent qu'aux fins de stocks. Dans le cas de références multiples, consulter la section des applications du catalogue. / **Nota importante:** Dans le cas de referencias multiples, consultar la sección de aplicaciones del catálogo. / **Nota importante:** Se pueden usar intercambios competitivos para propósitos de almacenamiento solamente. Cuando se identifican intercambios múltiples, consulte la sección de aplicaciones de este catálogo.

COMPETITIVE & O.E.M. INTERCHANGE LIST
Lista de Intercambios contra Competidores y Equipo Original.
Liste dinterchange de produits comptitifs & dquipement original (OEM)

Koni... cont'd

Koni	Gabriel	Upgrade	Koni	Gabriel	Upgrade	Koni	Gabriel	Upgrade	Koni	Gabriel	Upgrade
30-1630	G63425		88-1509	85027		8805-1020	83160		90-2209	85308	89422
30-1630	G63722		88-1510	85708		8805-1022	85724	89443	90-2209	89422	
80-2516	G63421		88-1517	85040		8805-1022	89443		90-2209-SP2	85001	89410
80-2517	G63422		88-1518	85040		8805-1023	83136		90-2209-SP2	89410	
80-2633	G63423		88-1520	85040		8805-1042	G63622		90-2253-SP2	85732	
80-2634	G63422		88-1525	85040		8805-1043	G63623		90-2254	85720	
82-1952	G63347		88-1532	85708		8850-1002	G63622		90-2256	85732	
82-1954	G63355		88-1540	85051		90-1409-SP1	85722		90-2257	85716	
82-1955	G63349		88-1541	85045		90-1577-SP1	85310	89423	90-2325	85340	
82-1970	G63350		88-1558	85013	89414	90-1577-SP1	89423		90-2326	85970	
82-2158	G63357		88-1558	89414		90-1811	85301		90-2327	85341	
82-2246	G63299		88-1559-SP1	85036	89405	90-1813-SP1	85712		90-2396-SP1	85000	89436
82-2345	G63413		88-1559-SP1	89405		90-1862	85708		90-2396-SP1	85323	89436
82-2372	G63609		88-1560	85062	89408	90-1867	85053	89442	90-2396-SP1	89436	
82-2384	G63488		88-1560	89408		90-1867	89442		90-2407	85709	
8240-1029	G63386		88-1561	85012	89413	90-1868	85307		90-2434	85702	
8240-1054	G63375		88-1561	89413		90-1868-SP1	85307		90-2477	85900	
8240-1055	G63454		88-1562	85003	89411	90-1896	85302	89420	90-2478	85902	
8240-1148	G63720		88-1562	89411		90-1896	89420		90-2497S-P1	85712	
84-1168	83130		88-1616	85014		90-1897	85303	89422	90-2563	85006	
88-1385	83105		88-1639	83130		90-1897	89422		90-2572	85329	
88-1417	83312	89409	88-1641	85029		90-1898	83215		90-2573	85329	
88-1417	89409		88-1641SP3	85029		90-1907-SP1	85300	89419	90-2575	85700	
88-1419	83136		88-1642	83124	89407	90-1907-SP1	89419		90-2576	85700	
88-1422	85030	89440	88-1642	89407		90-1908-SP1	85723		90-2586	85728	
88-1422	89440		88-1644	85000	89436	90-1909-SP1	85722		90-2587	85729	
88-1457-SP1	83209	89414	88-1644	89436		90-1910	85704		90-2588	85339	
88-1457-SP1	89414		88-1646	83613		90-1912	85318		90-2589	85727	
88-1458-SP1	83122	89406	88-1647	83317		90-1922	85900		90-2816	85711	
88-1458-SP1	89406		88-1704	85030	89440	90-1943	85307		90-5055-SP2	85318	
88-1458-SP2	83122	89406	88-1704	89440		90-1951-SP1	85734		90-5180	85300	89419
88-1458-SP2	89406		88-5162	83209	89414	90-1951-SP5	85712		90-5180	89419	
88-1468	83209	89414	88-5162	89414		90-1965	85304		9005-1018	85970	
88-1468	89414		88-5163	83122	89406	90-1968	85720		9005-1019	85341	
88-1476	85740		88-5163	89406		90-1974	85311	89424	9020-1042	85708	
88-1489	85036	89405	8805-1001	85125		90-1974	89424		90F-1235	85700	
88-1489	89405		8805-1002	85124		90-2059	85722		92-1227	85722	
88-1490	83124	89407	8805-1018	83209	89414	90-2060	85722		99B-3254	85029	
88-1490	89407		8805-1018	89414		90-2102-SP1	85708				
88-1499	85001	89410	8805-1019	83122	89406	90-2148	85304				
88-1499	89410		8805-1019	89406		90-2164-SP1	85723				

Krystal Bus

Krystal bus	Gabriel	Upgrade	Krystal bus	Gabriel	Upgrade	Krystal bus	Gabriel	Upgrade	Krystal bus	Gabriel	Upgrade
ASH-1136	G63623		ASH-1154	G63622		ASH1136	G63623		ASH1154	G63622	

KYB

Kyb	Gabriel	Upgrade	Kyb	Gabriel	Upgrade	Kyb	Gabriel	Upgrade	Kyb	Gabriel	Upgrade
232027	G55772		235619	G55856		235912	G56568		331016	G51718	
234035	G55591		235624	G55994		235913	G56601		331017	G51728	
234036	G55591		235625	G55993		235920	G56817		331021	G56622	
234057	G55999		235626	G55896		235921	G56655		331022	G56621	
234058	G55999		235627	G55892		235950	G55892		331035	G56799	
234059	G55662		235630	G56635		235951	G55892		331036	G56800	
234060	G55661		235631	G56636		236001	G56700		331037	G56799	
234061	G55911		235703	G52014		236002	G56701				
234062	G55911		235704	G52013		236007	G56718				
235005	G55551		235906	G56735		331008	G56622				
235060	G55681		235907	G56734		331009	G56621				

Important Note: Competitive Interchanges are to be used for stocking purposes only. Where multiple crosses are identified, please reference the applications section of this catalog. / **Remarque importante:** Les interchanges concurrentiels ne s'utilisent qu'aux fins de stocks. Dans le cas de rferences multiples, consulter la section des applications du catalogue. / **Nota importante:** Dans le cas de rferences multiples, consulter la section des applications du catalogue. / **Nota importante:** Se pueden usar intercambios competitivos para propósitos de almacenamiento solamente. Cuando se identifican intercambios múltiples, consulte la sección de aplicaciones de este catálogo.

COMPETITIVE & O.E.M. INTERCHANGE LIST
Lista de Intercambios contra Competidores y Equipo Original.
Liste dinterchange de produits comptitifs & dquipement original (OEM)

KYB... cont'd

Kyb	Gabriel	Upgrade	Kyb	Gabriel	Upgrade	Kyb	Gabriel	Upgrade	Kyb	Gabriel	Upgrade
331038	G56800		333475	G52282		334399	G56680		334687	G52395	
331039	G52113		333490	G52161		334399	G56731		334688	G52176	
331040	G52112		333491	G52160		334400	G56679		334689	G52175	
331043	G51718		333492	G52163		334400	G56730		334692	G52352	
331046	G52113		333493	G52162		334420	G56894		334693	G52351	
331047	G52112		333500	G56641		334428	G56680		334698	G52298	
331048	G56799		333501	G56640		334429	G56679		334699	G52297	
331049	G56800		333516	G52155		334430	G52107		334700	G52006	
331050	G56799		333517	G52154		334430	G56797		334701	G52005	
331051	G56800		333602	G52095		334431	G52108		3348018	G52450	
331613	G52349		333603	G52094		334431	G56798		3348019	G52449	
331614	G52348		333604	G52095		334432	G52169		3348041	G52256	
3320043	G55911		333605	G52094		334433	G52168		3348042	G52255	
332112	G56529		333617	G52440		334440	G56671		3348056	G52256	
332113	G56530		333618	G52439		334441	G56672		3348057	G52255	
3330052	G52155		333781	G56641		334450	G56660		334812	G56606	
3330053	G52154		333782	G56640		334451	G56661		334834	G56899	
333111	G56571		3340049	G52173		334452	G52106		334842	G52275	
333111	G56637		3340050	G52174		334453	G52105		334843	G52274	
333114	G55999		3340063	G52081		334454	G52033		334945	G52238	
333115	G55999		3340064	G52082		334455	G52032		334946	G52237	
333116	G55662		3340128	G56843		334464	G52185		335030	G56616	
333117	G55661		3340129	G56842		334465	G52184		335031	G56615	
333118	G55591		3340158	G52411		334472	G56843		335032	G56616	
333119	G55591		3340159	G52410		334473	G56842		335032	G56688	
333205	G56540		3340213	G52495		334478	G55676		335033	G56615	
333206	G56539		3340214	G52494		334479	G55675		335033	G56687	
333207	G52336		3340249	G52149		334500	G56561		335035	G56688	
333208	G52335		3340250	G52148		334501	G56562		335036	G56687	
333224	G56529		334133	G55676		334502	G56820		335037	G56509	
333225	G56530		334134	G55675		334503	G56819		335040	G56581	
333236	G55999		334169	G55901		334504	G56821		335041	G56582	
333237	G55999		334188	G55697		334505	G56822		335059	G52104	
333264	G52018		334227	G55948		334506	G52159		335060	G52103	
333265	G52017		334228	G55949		334507	G52158		335061	G55948	
333274	G56633		334245	G56514		334508	G52248		335065	G52116	
333275	G56634		334246	G56506		334509	G52247		335070	G52104	
333276	G56537		334294	G55901		334611	G56802		335071	G52103	
333277	G56538		334316	G55698		334621	G52165		335072	G52128	
333316	G56893		334333	G56568		334621	G52298		335073	G52127	
333317	G56892		334334	G56601		334622	G52164		335074	G52128	
333318	G56529		334335	G56620		334622	G52297		335075	G52127	
333319	G56530		334336	G56672		334636	G52111		335082	G52294	
333331	G52283		334337	G56671		334637	G52110		335083	G52293	
333332	G52282		334364	G56758		334642	G52082		335084	G52128	
333348	G56517		334365	G56759		334643	G52081		335085	G52127	
333349	G56516		334380	G52009		334644	G56841		335094	G52127	
333350	G56633		334381	G52008		334645	G56840		335095	G52127	
333351	G56634		334384	G56735		334652	G52130		335610	G52399	
333382	G56894		334385	G56734		334653	G52129		335611	G52398	
333385	G52098		334386	G56722		334658	G52082		335623	G52406	
333417	G56887		334387	G56721		334659	G52081		3357504	G52495	
333418	G56886		334388	G56729		334673	G52131		3357505	G52494	
333461	G56809		334389	G56728		334684	G52281		3358000	G52301	
333462	G56809		334394	G56733		334685	G52280		335808	G56899	
333474	G52283		334395	G56732		334686	G52396		335809	G56778	

Important Note: Competitive Interchanges are to be used for stocking purposes only. Where multiple crosses are identified, please reference the applications section of this catalog. / **Remarque importante:** Les interchanges concurrentiels ne s'utilisent qu'aux fins de stocks. Dans le cas de références multiples, consulter la section des applications du catalogue. / **Nota importante:** Dans le cas de références multiples, consulter la section des applications du catalogue. / **Nota importante:** Se pueden usar intercambios competitivos para propósitos de almacenamiento solamente. Cuando se identifican intercambios múltiples, consulte la sección de aplicaciones de este catálogo.

COMPETITIVE & O.E.M. INTERCHANGE LIST
Lista de Intercambios contra Competidores y Equipo Original.
Liste d'interchange de produits complitifs & d'equipement original (OEM)

KYB... cont'd

Kyb	Gabriel	Upgrade	Kyb	Gabriel	Upgrade	Kyb	Gabriel	Upgrade	Kyb	Gabriel	Upgrade
335810	G56778		339115	G52245		339310	G52257		341118	G55774	
335814	G52301		339124	G52300		339311	G52171		341120	G56591	
335815	G52314		339125	G52299		339312	G52170		341125	G55804	
335816	G52314		339128	G52097		339331	G52383		341141	G55820	
335833	G52200		339129	G52096		339332	G52382		341180	G51855	
335834	G52199		339140	G52261		339344	G52131		341198	G55910	
335844	G52128		339141	G52260		339345	G52356		341202	G51087	
335845	G52127		339146	G52122		339346	G52355		341205	G51742	
335920	G56791		339147	G52121		339347	G52525		341207	G51097	
335920	G56792		339148	G55949		339348	G52524		341217	G51841	
335924	G52145		339149	G52183		339361	G52361		341244	G55825	
335925	G52144		339150	G52182		339362	G52360		341245	G56565	
338001	G52153		339155	G52210		339365	G52188		341253	G56597	
338002	G52152		339156	G52209		339366	G52187		341254	G56597	
338009	G52153		339169	G52375		339377	G52279		341266	G56598	
338010	G52152		339170	G52374		339378	G52278		341271	G51727	
338011	G56887		339185	G52103		339725	G52006		341276	G51767	
338012	G56886		339188	G52171		339726	G52005		341280	G51714	
338013	G56837		339189	G52170		340018	G51898		341299	G51740	
338014	G56836		339190	G52122		340019	G51815		341302	G63678	
338019	G52163		339191	G52121		340022	G51806		341311	G51700	
338020	G52162		339192	G56722		340024	G51806		341322	G51795	
338022	G52157		339194	G52246		340028	G51856		341326	G51722	
338023	G52156		339195	G52245		340029	G51878		341327	G51724	
338106	G52354		339196	G52174		340030	G51877		341331	G51738	
338107	G52353		339197	G52173		340031	G511003		341339	G63918	
339015	G55948		339198	G52174		340038	G51897		341340	G51739	
339025	G52104		339199	G52173		340039	G51896		341341	G51727	
339026	G52103		339204	G52265		340040	G51878		341342	G51794	
339031	G52007		339205	G52264		340041	G51877		341343	G63783	
339032	G52004		339214	G56721		340043	G63909		341343	G63893	
339037	G52250		339216	G52204		340044	G51892		341344	G51739	
339038	G52249		339217	G52203		340045	G511055		341348	G51838	
339039	G52151		339230	G52202		340046	G511054		341361	G51838	
339040	G52150		339231	G52201		340049	G51919		341362	G51716	
339043	G52104		339234	G52204		340050	G51937		341363	G51898	
339044	G52103		339235	G52203		340056	G51911		341364	G52037	
339053	G52026		339242	G52332		340063	G51738		341365	G52036	
339054	G52027		339243	G52331		340068	G51863		341366	G51814	
339057	G56773		339246	G52131		340069	G51916		341367	G51813	
339058	G56774		339247	G52118		340070	G51975		341368	G51794	
339072	G52141		339248	G52117		340071	G51860		341369	G51738	
339073	G52140		339249	G52149		340072	G51861		341373	G51883	
339080	G52300		339250	G52148		340073	G51864		341374	G51850	
339081	G52299		339251	G52148		340075	G51865		341374	G63884	
339084	G56810		339251	G52149		340084	83515		341382	G51736	
339085	G56810		339252	G52148		340085	G51739		341392	G51832	
339086	G56514		339252	G52149		340090	G51933		341393	G51833	
339087	G56506		339261	G52188		340094	G51863		341402	G51880	
339100	G52108		339262	G52187		340098	G51863		341405	G51859	
339101	G52107		339263	G52254		340115	G51972		341406	G51859	
339102	G52106		339264	G52253		340121	G51856		341419	G51723	
339102	G52108		339269	G52143		3410014	G51898		341425	G51908	
339103	G52105		339270	G52142		3410018	G51842		341440	G51477	
339103	G52107		339272	G52125		3410084	G511038		341441	G51926	
339114	G52246		339309	G52258		341117	G55774		341442	G51925	

Important Note: Competitive Interchanges are to be used for stocking purposes only. Where multiple crosses are identified, please reference the applications section of this catalog. / **Remarque importante:** Les interchanges concurrentiels ne s'utilisent qu'aux fins de stocks. Dans le cas de rfrences multiples, consulter la section des applications du catalogue. / **Nota importante:** Dans le cas de rfrences multiples, consulter la section des applications du catalogue. / **Nota importante:** Se pueden usar intercambios competitivos para propósitos de almacenamiento solamente. Cuando se identifican intercambios múltiples, consulte la sección de aplicaciones de este catálogo.

COMPETITIVE & O.E.M. INTERCHANGE LIST
Lista de Intercambios contra Competidores y Equipo Original.
Liste dinterchange de produits comptitifs & dquipement original (OEM)

KYB... cont'd

Kyb	Gabriel	Upgrade	Kyb	Gabriel	Upgrade	Kyb	Gabriel	Upgrade	Kyb	Gabriel	Upgrade
341443	G51910		341625	85000	89436	343144	82001		343454	69589	
341444	G51908		341625	89436		343147	81340		343458	70041	
341448	G51898		341626	85000	89436	343149	82155		343460	G51807	
341457	G51852		341626	89436		343156	81491		343465	70041	
341458	G51854		341627	85006		343157	69604		343471	G51783	
341459	G51853		341628	85724	89443	343157	81492		343479	G51716	
341466	G51477		341628	89443		343161	69755		343484	G64089	
341467	G51766		341629	85938		343164	69632		343487	70060	
341468	G51765		341630	85052		343208	G63902		3438002	70052	
341472	G51849		341631	646155		343208	G63909		3440012	G511044	
341473	G51849		341632	83124	89407	343209	G63903		3440013	G511078	
341474	G56838		341632	89407		343209	G63937		3440022	G51965	
341475	G56839		341633	83215		343210	G63799		3440029	77967	
341476	G51806		341654	G51842		343211	69676		3440035	G511030	
341480	G51855		341658	70027		343218	69622		3440040	G51980	
341481	G51774		341659	70027		343219	81270		3440047	G511135	
341483	G51825		341661	G51704		343240	82156		3440049	G51766	
341484	G51815		341662	G51703		343247	G63799		3440055	G511038	
341485	G51758		341664	G51719		343252	G63907		3440060	G51766	
341486	G51961		341665	G51729		343255	69863		3440067	G64177	
341489	G51758		341666	G51948		343270	70020		3440072	70213	
341492	G51879		341667	G51947		343272	69813		344008	G511030	
341493	G51870		341668	G51842		343280	69945		3440084	G64146	
341493	G51891		341681	G51916		343281	69946		3440089	G63866	
341495	G51847		341682	G51975		343284	69946		344015	G63928	
341499	G51848		341683	G51934		343290	69464		344040	G63421	
341600	G51715		341704	G51900		343291	69465		344041	G63422	
341601	G51703		3417504	G511000		343295	69450		344042	G63423	
341601	G51704		3417505	G51721		343308	69587		344043	G63813	
341602	G51703		341814	69586		343313	G63860		344043	G63902	
341603	70013		341842	G51097		343314	G63860		344043	G63909	
341604	G51267		341845	G51740		343330	82125		344044	G63492	
341605	G51719		341907	G51759		343342	G63902		344044	G63907	
341607	G51729		341924	G51881		343348	69945		344045	G63419	
341609	G51761		341952	G64047		343352	69863		344045	G63492	
341609	G51947		341966	G51759		343353	69585		344047	G63950	
341613	85062	89408	3430015	G51905		343353	70001		344049	G63414	
341613	89408		3430019	G51799		343367	G63907		344050	G63773	
341614	85001	89410	3430024	G51799		343379	G63845		344054	G63404	
341614	89410		3430041	70207		343381	70060		344055	G63299	
341615	83215		3430043	G51990		343385	69473		344055	G63689	
341617	85005	89430	3430044	G51766		343388	G63712		344066	G63359	
341617	89430		3430068	70231		343395	G63842		344067	G63347	
341618	85918	89449	343010	69787		343395	G64014		344068	G63355	
341618	89449		343127	69600		343410	G63937		344070	G63353	
341619	83136		343127	69625		343412	70003		344071	G63350	
341620	85033	89427	343127	69675		343413	69464		344072	G63349	
341620	89427		343127	81750		343419	70056		344073	G63413	
341621	85311	89424	343127	82118		343425	G63409		344074	G63183	
341621	89424		343128	69675		343426	70028		344075	G63413	
341622	85023	89415	343128	82110		343429	69464		344076	G63410	
341622	89415		343130	69724		343433	G63872		344076	G63414	
341623	85003	89411	343130	82051		343435	G64052		344078	G63409	
341623	89411		343131	69624		343442	G51783		344078	G63683	
341624	85036	89405	343135	69606		343444	G63907		344079	G63775	
341624	89405		343143	82005		343452	69420		344080	G63426	

Important Note: Competitive Interchanges are to be used for stocking purposes only. Where multiple crosses are identified, please reference the applications section of this catalog. / **Remarque importante:** Les interchanges concurrentiels ne s'utilisent qu'aux fins de stocks. Dans le cas de références multiples, consulter la section des applications du catalogue. / **Nota importante:** Dans le cas de referencias multiples, consultar la sección de aplicaciones del catálogo. / **Nota importante:** Se pueden usar intercambios competitivos para propósitos de almacenamiento solamente. Cuando se identifican intercambios múltiples, consulte la sección de aplicaciones de este catálogo.

COMPETITIVE & O.E.M. INTERCHANGE LIST
Lista de Intercambios contra Competidores y Equipo Original.
Liste d'interchange de produits compititifs & d'equipement original (OEM)

KYB... cont'd

Kyb	Gabriel	Upgrade	Kyb	Gabriel	Upgrade	Kyb	Gabriel	Upgrade	Kyb	Gabriel	Upgrade
344080	G63690		344342	G63829		344419	G63888		345023	G63828	
344081	G63375		344353	69909		344426	G63299		345024	G63864	
344081	G63915		344355	G63707		344427	G63904		345025	83515	
344082	G63454		344356	69900		344427	G63909		345030	G63394	
344084	G63490		344358	G64087		344428	G63494		345038	G63615	
344085	G63306		344359	G63720		344428	G63510		345039	G63694	
344086	G63353		344363	69591		344429	G63907		345042	G63883	
344087	G63377		344364	77980		344430	G63495		345043	G63878	
344088	G63424		344365	G63662		344430	G63611		345055	G63872	
344089	G63424		344366	G63366		344430	G63909		345055	G64140	
344089	G63683		344367	G63714		344431	G63620		345056	G64033	
344090	G63492		344368	G63716		344432	69962		345061	77949	
344090	G63928		344369	G63624		344433	69898		345062	G63971	
344091	G63511		344370	G63622		344434	69962		345067	G64031	
344092	G63490		344371	G63623		344435	G63721		345068	69595	
344093	G63905		344372	G63661		344436	G63866		345070	G63888	
344094	G63915		344373	G63674		344437	G63866		345072	G64010	
344097	G63907		344373	G63675		344438	G63869		345073	G63866	
344110	69845		344374	G63778		344439	G51798		345074	G63959	
344202	G63479		344375	G63715		344447	G63689		345075	69594	
344202	G63547		344376	G63673		344448	G63689		345080	G63622	
344222	G63782		344377	G63717		344450	G51802		345084	G63872	
344223	G63781		344378	G63403		344455	G51812		345601	83613	
344229	G63708		344378	G63890		344459	G51799		345602	85052	
344262	G63638		344378	G63891		344464	G63879		345604	85051	
344262	G63897		344379	G63403		344465	G63884		345605	85012	89413
344263	G63488		344380	G63783		344466	G63882		345605	89413	
344263	G63638		344381	G63803		344467	G63873		345606	83136	
344264	G63387		344382	G63808		344468	G63909		345607	83130	
344265	G63489		344383	G63817		344469	G63813		345608	85060	
344265	G63783		344384	G63866		344475	G63902		345609	83515	
344266	G63609		344385	G63866		344479	G51803		345611	83120	
344266	G63818		344386	G63675		344480	G51805		345613	85005	89430
344267	G63455		344387	G63692		344481	G63894		345613	89430	
344268	G63614		344388	G63929		344483	G63896		345614	83309	
344269	G63679		344396	G63525		344487	70034		345615	83314	
344272	G63386		344396	G63683		344491	G51812		345616	83125	
344273	G63638		344396	G63773		344496	G64012		345617	83203	89436
344274	G55821		344397	G63772		344500	G64048		345617	89436	
344279	G63707		344398	G63958		344501	70049		345618	83126	89430
344290	G63490		344399	G63848		344609	G51267		345618	89430	
344291	G63676		344400	G63958		344610	G51268		345620	83456	89447
344291	G63873		344400	G64009		344611	G51858		345620	89447	
344294	G64027		344402	G63783		344612	G51736		345621	85003	89411
344295	G64028		344403	G63722		344655	70068		345621	89411	
344296	70000		344404	G63844		344655	70209		345624	G64148	
344298	G63611		344406	G64087		344658	G64216		345625	G511000	
344299	G63710		344409	G63918		344660	G51721		345626	G511000	
344304	G63375		344410	G63885		344663	70210		345626	G511038	
344305	G63678		344410	G64029		344664	70213		345627	G51928	
344308	G511007		344410	G64030		344807	69586		346016	G51905	
344314	69907		344413	G63810		344808	69586		348002	70036	
344328	83159		344414	G63870		3450011	G64043		348007	70036	
344338	G63776		344415	G63867		3450014	G64121		348016	G51905	
344338	G63869		344415	G64157		345005	G63694		348018	70052	
344341	G63847		344418	G63425		345022	G63832		348019	G511092	

Important Note: Competitive Interchanges are to be used for stocking purposes only. Where multiple crosses are identified, please reference the applications section of this catalog. / **Remarque importante:** Les interchanges concurrentiels ne s'utilisent qu'aux fins de stocks. Dans le cas de références multiples, consulter la section des applications du catalogue. / **Nota importante:** Dans le cas de références multiples, consulter la section des applications du catalogue. / **Nota importante:** Se pueden usar intercambios competitivos para propósitos de almacenamiento solamente. Cuando se identifican intercambios múltiples, consulte la sección de aplicaciones de este catálogo.

COMPETITIVE & O.E.M. INTERCHANGE LIST
Lista de Intercambios contra Competidores y Equipo Original.
Liste d'interchange de produits complitifs & d'equipement original (OEM)

KYB... cont'd

Kyb	Gabriel	Upgrade	Kyb	Gabriel	Upgrade	Kyb	Gabriel	Upgrade	Kyb	Gabriel	Upgrade
348023	G51807		349109	G51799		444012	G63492		553171	G63495	
348029	G51990		349110	G64043		444024	G63492		553197	69952	
348032	G51971		349115	70078		444058	83159		553198	69966	
348038	69464		349117	G64042		444135	G63678		553209	G63495	
348060	G511037		349119	83159		444136	G63775		553239	69863	
348066	G511092		349122	G64046		444203	83515		553256	83159	
348069	70055		349123	G63958		444209	83114		553303	G63845	
348085	G511092		349124	G63967		444235	G63421		553310	69624	
349001	G63918		349125	G63776		444236	G63422		553311	77971	
349004	58944		349125	G64040		444244	G63409		553320	69600	
349005	G64032		349127	83159		444249	G63489		553333	69473	
349007	70039		349130	G64040		444250	G63488		553345	G64016	
349008	69590		349136	70059		444252	G63638		553346	G63892	
349009	G63897		349136	70204		444254	G63366		553360	G63937	
349010	G63889		349139	70089		444255	G63414		553361	G63689	
349010	G64006		349142	G64111		444256	G63455		553367	70033	
349024	G64026		349146	G63888		444269	83159		553381	70038	
349024	G64151		349147	G64121		444323	G63907		553385	70040	
349025	G64080		349151	G64104		444328	83159		553387	G63907	
349026	69592		349165	70096		445016	83515		553389	G51983	
349026	69593		349168	G51996		445054	83613		553392	G511001	
349035	70053		349183	G63886		445064	83162		5540000	77951	
349039	G64003		349184	70098		445067	85009		5540005	G63918	
349040	G511004		349185	G63885		446074	85308	89422	5540007	G64089	
349043	69587		349187	G64216		446074	89422		5540017	G64089	
349044	G64089		349191	G63894		446075	83215		5540021	G511043	
349045	G64089		349194	G511002		447001	85308	89422	5540022	77976	
349046	G63895		349194	G511134		447001	89422		554003	G63610	
349054	G63815		349199	G511122		5510000	G51860		5540041	G56802	
349054	G64038		349207	69907		5510001	G51861		554044	77726	
349060	70013		349212	G511044		5510025	G51980		554060	G63455	
349065	70086		349217	70203		551091	77678		554069	77479	
349067	G51993		349219	G511078		551093	G51477		554075	77907	
349068	G64037		349225	G64042		551104	G51739		554100	G63495	
349069	G63966		349230	G64012		551105	70003		554101	77907	
349069	G63967		349232	G63799		551121	G51891		554125	G63707	
349071	G64008		349237	G511043		551125	G51855		554127	G63708	
349073	G64042		349240	G511044		551126	G51921		554128	77726	
349075	70089		349243	70068		551127	G51920		554131	G63494	
349076	G64056		349244	70068		551130	G51921		554132	G63928	
349078	G64050		354055	G64015		551131	G51920		554152	G63776	
349080	G64063		366010	G44461		551132	G51922		554153	77489	
349083	G64063		441120	G55698		551133	G51864		554154	77638	
349085	70037		441120	G55825		551134	G51865		554156	77915	
349086	70086		441133	83515		551136	G511142		554158	G63890	
349092	G51884		441600	85310	89423	551139	G51766		554159	77915	
349093	G51874		441600	89423		551600	G51887		554160	77905	
349094	G64071		441602	85724	89443	551602	G51888		554161	77375	
349095	G51966		441602	89443		551605	G51746		554162	G63624	
349097	G64050		443078	G63902		551610	G51773		554163	77609	
349098	70095		443216	G63495		5530004	G64089		554165	G51724	
349101	G64047		443240	G63907		5530008	70089		554166	77716	
349102	70013		443259	G63907		5530013	G51874		554168	77461	
349105	70010		443363	G63845		553153	77907		554169	G63424	
349106	G511001		443477	69632		553158	G63799		554170	77525	
349108	G64079		443478	69945		553160	77479		554173	77907	

Important Note: Competitive Interchanges are to be used for stocking purposes only. Where multiple crosses are identified, please reference the applications section of this catalog. / **Remarque importante:** Les interchanges concurrentiels ne s'utilisent qu'aux fins de stocks. Dans le cas de références multiples, consulter la section des applications du catalogue. / **Nota importante:** Dans le cas de références multiples, consulter la section des applications du catalogue. / **Nota importante:** Se pueden usar intercambios competitivos para propósitos de almacenamiento solamente. Cuando se identifican intercambios múltiples, consulte la sección de aplicaciones de este catálogo.

COMPETITIVE & O.E.M. INTERCHANGE LIST
Lista de Intercambios contra Competidores y Equipo Original.
Liste dinterchange de produits comptitifs & dquipement original (OEM)

KYB... cont'd

Kyb	Gabriel	Upgrade	Kyb	Gabriel	Upgrade	Kyb	Gabriel	Upgrade	Kyb	Gabriel	Upgrade
554174	G63299		554277	G63623		555024	G63883		KG5194	G64000	
554177	77614		554280	69604		555038	77614		KG5196	77950	
554178	77608		554281	69600		555039	77623		KG5197	77829	
554180	77422		554292	69624		555050	77983		KG5401	G63299	
554182	G63690		554306	75676		555051	G64031		KG5404	G63360	
554184	77909		554312	77375		555052	69594		KG5406	G63386	
554185	G63844		554319	77817		555054	77953		KG54100	77638	
554186	77716		554320	77947		555054	77975		KG54101	77638	
554187	77715		554321	77954		555055	77976		KG54102	77661	
554188	77803		554322	77949		555056	77952		KG54103	77674	
554189	77953		554324	77638		555057	G64033		KG54103	77948	
554195	G63867		554327	G63882		555058	77953		KG54103	77980	
554198	77953		554328	G51850		555060	69595		KG54104	77662	
554199	77950		554329	G63879		555601	69575		KG5420	G63366	
554200	77829		554330	77909		555603	69574		KG5421	G63387	
554203	G63386		554331	77909		555604	G51904		KG5422	G63183	
554206	77638		554342	G63894		555609	G51871		KG54300	G63615	
554207	77661		554344	77638		555610	G64046		KG54301	G63616	
554208	77661		554347	77951		564002	G51077		KG54302	G63782	
554209	77662		554347	77967		565013	G63624		KG54303	G63781	
554210	G63353		554348	77638		565033	77638		KG54304	G63707	
554211	G63350		554350	G63889		565060	77375		KG54306	77675	
554216	77662		554353	G64015		565062	77609		KG54308	G63708	
554223	77662		554356	G63895		565068	77412		KG54309	77678	
554225	G63676		554359	77949		565090	77809		KG5431	G63511	
554228	77661		554360	77950		565091	77809		KG54310	G63676	
554229	77717		554362	77968		565101	77783		KG54311	77714	
554230	77717		554362	77969		634812	G56606		KG54313	77716	
554231	77978		554364	77981		734033	G56606		KG54314	77715	
554233	77783		554365	77973		743029	69945		KG54315	77673	
554234	77803		554367	G64038		KG4026	G63492		KG54317	G63726	
554235	77678		554369	77807		KG4159	G63892		KG54319	G64002	
554236	77614		554370	77623		KG4160	G64016		KG54320	77455	
554237	G63950		554372	G64063		KG4162	77971		KG54320	77717	
554238	77614		554373	G64079		KG4163	G63845		KG54321	77403	
554239	77607		554374	G64043		KG4503	82026		KG54322	77403	
554240	77808		554375	G64043		KG4503	82069		KG54323	77978	
554241	77808		554376	G63966		KG4507	82011		KG54325	G63776	
554242	77815		554377	G64012		KG4515	69675		KG54326	77783	
554243	77815		554378	G64040		KG4515	82110		KG54327	77803	
554244	G63611		554379	G64042		KG4530	69996		KG54328	77772	
554245	G63710		554380	83159		KG4537	69714		KG54329	77607	
554246	77783		554382	G64089		KG4539	69725		KG54330	77809	
554247	77817		554383	83159		KG4540	69677		KG54330	G63809	
554248	77953		554384	70098		KG4613A	G63909		KG54331	77837	
554249	77412		554385	70095		KG4731	70065		KG54331	G63837	
554252	G63404		554385	70102		KG4738	G63860		KG54332	77808	
554255	77909		554385	70208		KG4740	70064		KG54333	77810	
554257	77907		554386	G63862		KG4742	69952		KG54333	G63810	
554260	77414		554388	77952		KG4743	69966		KG54335	77815	
554262	77454		554389	G64121		KG4745A	G63799		KG54336	77815	
554264	G63511		554390	G64043		KG4752	G63937		KG54339	77783	
554265	G63490		554398	G63873		KG5039	G63844		KG54340	77817	
554268	77909		554402	G511002		KG5040	77803		KG54341	77662	
554270	77412		5550006	77976		KG5041	77953		KG54342	77412	
554274	77614		555023	G63878		KG5045	G63868		KG5438	77907	

Important Note: Competitive Interchanges are to be used for stocking purposes only. Where multiple crosses are identified, please reference the applications section of this catalog. / **Remarque importante:** Les interchanges concurrentiels ne s'utilisent qu'aux fins de stocks. Dans le cas de rfrences multiples, consulter la section des applications du catalogue. / **Nota importante:** Dans le cas de rfrences multiples, consulter la section des applications du catalogue. / **Nota importante:** Se pueden usar intercambios competitivos para propósitos de almacenamiento solamente. Cuando se identifican intercambios múltiples, consulte la sección de aplicaciones de este catálogo.

COMPETITIVE & O.E.M. INTERCHANGE LIST
Lista de Intercambios contra Competidores y Equipo Original.
Liste dinterchange de produits comptitifs & dquipement original (OEM)

KYB... cont'd

Kyb	Gabriel	Upgrade	Kyb	Gabriel	Upgrade	Kyb	Gabriel	Upgrade	Kyb	Gabriel	Upgrade
KG5440	77414		KG5603A	G63418		SM5091	143422		SM5442	143325	
KG5440	77905		KG5614	77909		SM5109	142329		SM5443	143404	
KG5440	G63350		KG5615	77909		SM5122	142546		SM5444	143405	
KG5444	G63904		KG5744	77847		SM5123	142547		SM5447	143354	
KG5446	G63813		KG5747	69901		SM5126	142561		SM5451	143239	
KG5446	G63909		KG5780	G63894		SM5137	143320		SM5459	143218	
KG5451	77422		KG5784	77947		SM5138	142843		SM5460	142419	
KG5452	77423		KG5785	77954		SM5140	142402		SM5461	143088	
KG5455	G63456		KG5786	77949		SM5151	143458		SM5471	143355	
KG5457	G63690		KG5787A	69757		SM5162	143367		SM5472	143194	
KG5458	77375		KG6002A	85030	89440	SM5165	143191		SM5475	143191	
KG5458	77915		KG6002A	89440		SM5168	142828		SM5476	143425	
KG5459	77454		KG6003	83309		SM5169	142930		SM5483	143089	
KG5462	77494		KG6004	85320	89429	SM5174	142836		SM5489	143418	
KG5465	77425		KG6004	89429		SM5178	143197		SM5491	143388	
KG5466	G63492		KG6005	83216		SM5179	142649		SM5492	143387	
KG5474	77479		KG6006	85012	89413	SM5180	142650		SM5513	143323	
KG5475	77726		KG6006	89413		SM5181	142651		SM5517	143419	
KG5475	G63432		KG6007	85007		SM5184	143325		SM5530	143316	
KG5476	77909		KG6008A	83122	89406	SM5193	142625		SM5531	143324	
KG5478	77489		KG6008A	89406		SM5197	142444		SM5533	143335	
KG5479	77488		KG6009A	83303		SM5198	143256		SM5535	143369	
KG5480	77609		KG6010	83308		SM5199	142932		SM5535	143468	
KG5481	G63411		KG6198	G63616		SM5203	142938		SM5537	143305	
KG5482	77412		KG6199	85012	89413	SM5211	143315		SM5539	143416	
KG5484	G63635		KG6199	89413		SM5213	143209		SM5542	143455	
KG5487	77525		KG6201	83456	89447	SM5215	143201		SM5567	143344	
KG5487	77683		KG6201	89447		SM5237	142653		SM5568	142526	
KG5487	G63525		KG6403	G63605		SM5244	143465		SM5569	143319	
KG5488	G63403		KG6406	G63183		SM5245	143466		SM5581	143564	
KG5489	77614		KG6407	G63394		SM5260	143082		SM5582	143462	
KG5489	G63614		KG6412	G63625		SM5264	143423		SM5583	143461	
KG5490	77679		KG6413	77614		SM5265	142932		SM5589	143191	
KG5491	G63604		KG6413	G63622		SM5285	143459		SM5589	143365	
KG5493	77461		KG6414	77623		SM5295	143087		SM5597	143408	
KG5493	77524		KG6415	85013	89414	SM5300	142852		SM5601	143495	
KG5494	G63620		KG6415	89414		SM5314	143464		SM5602	143318	
KG5495	77608		KG6416	83123	89405	SM5324	142546		SM5603	143391	
KG5495	G63929		KG6416	89405		SM5329	142938		SM5604	143390	
KG5496	G63624		KG9025	G51077		SM5361	143492		SM5607	142930	
KG5497	77807		KG9026	G51477		SM5366	143204		SM5608	143363	
KG5497	G63622		SB101	143057		SM5378	142444		SM5610	143460	
KG5498	77623		SB103	143058		SM5379	143380		SM5618	143342	
KG5498	G63623		SB104	143059		SM5382	143094		SM5619	143531	
KG5507	69724		SB107	143063		SM5385	142561		SM5620	143412	
KG5507	82051		SB132	143064		SM5388	143087		SM5638	143406	
KG5522	69606		SM5013	142135		SM5392	143357		SM5644	143345	
KG5534	G63610		SM5034	142195		SM5398	143073		SM5653	143366	
KG5538	77494		SM5041	142852		SM5399	143074		SM5659	142653	
KG5554	69766		SM5049	143281		SM5402	143353		SM5660	143491	
KG5562	75676		SM5057	142530		SM5403	143353		SM5661	143397	
KG5564	69715		SM5058	142230		SM5409	142937		SM5668	143477	
KG5570	69811		SM5070	142252		SM5423	143202		SM5677	143336	
KG5571	69795		SM5079	142245		SM5424	143244		SM5682	143369	
KG5572	77375		SM5091	142419		SM5425	143244		SM5683	143369	
KG5575	69962		SM5091	143394		SM5441	143398		SM5688	143305	

Important Note: Competitive Interchanges are to be used for stocking purposes only. Where multiple crosses are identified, please reference the applications section of this catalog. / **Remarque importante:** Les interchanges concurrentiels ne s'utilisent qu'aux fins de stocks. Dans le cas de rferences multiples, consulter la section des applications du catalogue. / **Nota importante:** Dans le cas de rferences multiples, consulter la section des applications du catalogue. / **Nota importante:** Se pueden usar intercambios competitivos para propósitos de almacenamiento solamente. Cuando se identifican intercambios múltiples, consulte la sección de aplicaciones de este catálogo.

COMPETITIVE & O.E.M. INTERCHANGE LIST
Lista de Intercambios contra Competidores y Equipo Original.
Liste d'interchange de produits compititifs & d'equipement original (OEM)

KYB... cont'd

Kyb	Gabriel	Upgrade	Kyb	Gabriel	Upgrade	Kyb	Gabriel	Upgrade	Kyb	Gabriel	Upgrade
SM5721	143349		SR4079	G57000		SR4139	G57190		SR4193	G57087	
SM5729	143473		SR4079	G57023		SR4140	G57080		SR4194	G57086	
SM5737	143339		SR4079	G57125		SR4141	G57096		SR4195	G57206	
SM5756	143415		SR4081	G57017		SR4142	G57076		SR4196	G57206	
SM5776	143416		SR4082	G57019		SR4143	G57077		SR4199	G57008	
SR1002	49228		SR4085	G57079		SR4144	G57664		SR4200	G57007	
SR4001	G56927		SR4086	G57078		SR4145	G57663		SR4201	G57646	
SR4002	G57060		SR4087	G57072		SR4146	G57106		SR4202	G57647	
SR4009	G56937		SR4088	G57071		SR4147	G57105		SR4203	G57413	
SR4010	G56934		SR4089	G57060		SR4148	G57212		SR4206	G57109	
SR4011	G56936		SR4090	G57051		SR4149	G57015		SR4206	G57314	
SR4016	G56935		SR4092	G56925		SR4150	G57042		SR4207	G57330	
SR4023	G57118		SR4093	G56924		SR4151	G57041		SR4208	G57329	
SR4024	G56951		SR4094	G57070		SR4152	G57350		SR4211	G57324	
SR4025	G56938		SR4095	G57069		SR4153	G57349		SR4214	G57201	
SR4027	G57064		SR4096	G57077		SR4154	G57666		SR4215	G57200	
SR4028	G57063		SR4097	G57076		SR4155	G57665		SR4216	G57177	
SR4029	G56931		SR4098	G57122		SR4156	G57035		SR4217	G57176	
SR4030	G56930		SR4099	G57122		SR4157	G57034		SR4218	G57178	
SR4033	G56934		SR4100	G57046		SR4158	G57016		SR4219	G57219	
SR4033	G56937		SR4101	G57045		SR4159	G57111		SR4220	G57218	
SR4034	G56936		SR4102	G57142		SR4159	G57536		SR4222	G57343	
SR4035	G56933		SR4105	G57046		SR4160	G57110		SR4223	G57344	
SR4036	G56932		SR4106	G57045		SR4160	G57535		SR4223	G57405	
SR4037	G56928		SR4107	G57026		SR4161	G57198		SR4224	G57404	
SR4038	G56957		SR4108	G57191		SR4162	G57197		SR4225	G57162	
SR4039	G56956		SR4109	G57190		SR4163	G57031		SR4226	G57161	
SR4040	G56997		SR4110	G57191		SR4164	G57030		SR4227	G57092	
SR4041	G56996		SR4111	G57190		SR4165	G57053		SR4228	G57334	
SR4042	G56998		SR4112	G57193		SR4166	G57053		SR4229	G57333	
SR4051	G57018		SR4113	G57192		SR4167	G57271		SR4230	G57092	
SR4052	G57039		SR4115	G57081		SR4168	G57120		SR4231	G57696	
SR4053	G56965		SR4116	49255		SR4169	G57119		SR4232	G57695	
SR4054	G57042		SR4117	G57358		SR4170	G57120		SR4233	G57332	
SR4055	G57041		SR4118	G57357		SR4171	G57103		SR4234	G57331	
SR4056	G57048		SR4119	G57134		SR4172	G57132		SR4235	G57082	
SR4057	G57047		SR4120	G57133		SR4173	G57419		SR4236	G57081	
SR4058	G57044		SR4121	G57055		SR4174	G57419		SR4241	G57391	
SR4059	G57043		SR4122	G57054		SR4175	G57206		SR4242	G57390	
SR4060	G56963		SR4123	G57354		SR4176	G57206		SR4243	G57682	
SR4061	G56962		SR4124	G57353		SR4177	G57373		SR4244	G57416	
SR4064	G56948		SR4125	G57397		SR4178	G57372		SR4245	G57739	
SR4065	G56948		SR4126	G57203		SR4179	G57085		SR4246	G57738	
SR4066	G56950		SR4127	G57202		SR4180	G57084		SR4261	G57500	
SR4067	G56949		SR4128	G57050		SR4181	G57085		SR4262	G57499	
SR4068	G57115		SR4129	G57049		SR4182	G57084		SR4267	G57713	
SR4069	G57114		SR4129	G57050		SR4183	G57330		SR4268	G57712	
SR4070	G56964		SR4130	G57134		SR4184	G57329		SR4271	G57148	
SR4071	G57012		SR4131	G57133		SR4185	G57164		SR4272	G57148	
SR4072	G57011		SR4132	G57056		SR4186	G57163		SR4275	G57394	
SR4073	G57022		SR4133	G57134		SR4187	G57208		SR4276	G57393	
SR4074	G56992		SR4134	G57133		SR4188	G57207		SR4279	G57282	
SR4075	G56991		SR4135	G57055		SR4189	G57418		SR4317	G57378	
SR4076	G56943		SR4136	G57054		SR4190	G57417		SR4318	G57377	
SR4077	G57020		SR4137	G57095		SR4191	G57087		SR4388	G57480	
SR4078	G57021		SR4138	G57191		SR4192	G57086		SR4389	G57479	

Important Note: Competitive Interchanges are to be used for stocking purposes only. Where multiple crosses are identified, please reference the applications section of this catalog. / **Remarque importante:** Les interchanges concurrentiels ne s'utilisent qu'aux fins de stocks. Dans le cas de rfrences multiples, consulter la section des applications du catalogue. / **Nota Importante:** Dans le cas de rfrences multiples, consulter la section des applications du catalogue. / **Nota Importante:** Se pueden usar intercambios competitivos para propósitos de almacenamiento solamente. Cuando se identifican intercambios mltiples, consulte la seccin de aplicaciones de este catlogo.

COMPETITIVE & O.E.M. INTERCHANGE LIST
Lista de Intercambios contra Competidores y Equipo Original.
Liste dinterchange de produits comptitifs & dquipement original (OEM)

KYB... cont'd

Kyb	Gabriel	Upgrade	Kyb	Gabriel	Upgrade	Kyb	Gabriel	Upgrade	Kyb	Gabriel	Upgrade
SR4404	G57540		SR4446	G57659		SR4491	G57340		SR4559	G57455	
SR4405	G57539		SR4447	G57658		SR4492	G57339		SR4576	G57191	
SR4408	G57567		SR4448	G57484		SR4498	G57565		SR4577	G57190	
SR4409	G57566		SR4449	G57483		SR4499	G57564		SR4580	G57370	
SR4415	G57731		SR4450	G57482		SR4500	G57276		SR4581	G57369	
SR4415	G57733		SR4451	G57481		SR4501	G57275		SR4582	G57429	
SR4416	G57730		SR4452	G57563		SR4502	G57149		SR4583	G57428	
SR4416	G57732		SR4452	G57791		SR4504	G57447		SR4589	G57453	
SR4417	G57785		SR4453	G57562		SR4504	G57579		SR4590	G57454	
SR4418	G57784		SR4453	G57790		SR4505	G57793		SR4591	G57346	
SR4419	G57725		SR4454	G57484		SR4506	G57792		SR4592	G57345	
SR4420	G57724		SR4455	G57483		SR4515	G57173		SR4593	G57423	
SR4423	G57415		SR4459	G57205		SR4516	G57794		SR4594	G57472	
SR4424	G57404		SR4460	G57204		SR4517	G57794		SR4595	G57471	
SR4424	G57414		SR4461	G57205		SR4522	G57138		SR4603	G57223	
SR4425	G57735		SR4462	G57204		SR4523	G57137		SR4604	G57222	
SR4426	G57734		SR4463	G57133		SR4524	G57138		SR4605	G57425	
SR4427	G57083		SR4464	G57134		SR4525	G57137		SR4606	G57424	
SR4428	G57083		SR4465	G57221		SR4526	G57781		SR4607	G57723	
SR4429	G57083		SR4466	G57220		SR4527	G57780		SR4608	G57722	
SR4430	G57604		SR4469	G57799		SR4528	G57134		SR7099	G57121	
SR4431	G57603		SR4470	G57786		SR4529	G57133		SR8069	G57114	
SR4432	G57598		SR4471	G57786		SR4532	G57709		SS10202	14072	
SR4433	G57597		SR4472	G57124		SR4535	G57794		SS10309	6854SE	
SR4434	G57323		SR4473	G57123		SR4536	G57794		SS10317	14040	
SR4435	G57322		SR4478	G57544		SR4545	G57023		SS10317	14071	
SR4436	G57474		SR4479	G57543		SR4546	G57023		SS10318	6853SE	
SR4437	G57473		SR4480	G57546		SR4547	G57000		SS10322	6856SE	
SR4438	G57172		SR4481	G57545		SR4548	G57147		SS10323	6847SE	
SR4439	G57677		SR4482	G57629		SR4553	G57779		SS10325	14017	
SR4440	G57676		SR4483	G57628		SR4554	G57778		SS10325	6804SE	
SR4443	G57683		SR4484	G57706		SR4555	G57466		SS11318	14074	
SR4444	G57185		SR4485	G57705		SR4556	G57465		SS15345	6802SE	
SR4445	G57184		SR4486	G57704		SR4558	G57456		SS15489	6855SE	

Leacree

Leacree	Gabriel	Upgrade	Leacree	Gabriel	Upgrade	Leacree	Gabriel	Upgrade	Leacree	Gabriel	Upgrade
201721149	G57115		30391029	69946		501711399	G57173		501713409R	G57062	
201722079	G57079		3056079	70003		501711409	G57132		501713419	G57022	
201722759	G57205		3056149	70013		501711419	G57103		501713469	G57080	
20714269	G56672		3056189	70039		501712669L	G56995		501713489L	G57027	
30323349	G63726		3056229	70037		501712669R	G56995		501713489R	G57027	
30323379	G63710		3056379	70089		501712819	G56938		501713519L	G57065	
30372049	G63845		3057889	70031		501712919L	G56996		501713519R	G57066	
30372189	69909		309112659	G64010		501712919R	G56997		501713529L	G57065	
30372389	G63815		309112679	G63888		501712929	G56998		501713529R	G57066	
30372439	G63610		309113319	G64157		501712939	G57057		501713589	G57092	
30372519	G63878		309113329	G64079		501712939	G57058		501713619	G57020	
30372529	G63883		309115069	G63866		501712999	G56943		501713629	G57021	
30372709	G63885		501000259	G57039		501713129	G57036		501713719L	G57133	
30372709	G64029		501391049	G57125		501713219	G57017		501713719R	G57134	
30372709	G64030		501711119	G57053		501713229	G57018		501713729	G57056	
30372749	G64033		501711199L	G57123		501713279	G57159		501713779L	G57083	
30372989	G64038		501711199R	G57124		501713279	G57160		501713779R	G57083	
30373159	G64040		501711249	G57095		501713409L	G57032		501713809L	G57086	
30390409	69901		501711259	G57096		501713409L	G57061		501713809R	G57087	
30390409	70040		501711389	G57172		501713409R	G57033		501713989	G57019	

Important Note: Competitive Interchanges are to be used for stocking purposes only. Where multiple crosses are identified, please reference the applications section of this catalog. / **Remarque importante:** Les interchanges concurrentiels ne s'utilisent qu'aux fins de stocks. Dans le cas de références multiples, consulter la section des applications du catalogue. / **Nota importante:** Dans le cas de referencias multiples, consultar la sección de aplicaciones del catalogo. / **Nota importante:** Se pueden usar intercambios competitivos para propósitos de almacenamiento solamente. Cuando se identifican intercambios múltiples, consulte la sección de aplicaciones de este catálogo.

COMPETITIVE & O.E.M. INTERCHANGE LIST
Lista de Intercambios contra Competidores y Equipo Original.
Liste dinterchange de produits comptitifs & dquipement original (OEM)

Leacree... cont'd

Leacree	Gabriel	Upgrade	Leacree	Gabriel	Upgrade	Leacree	Gabriel	Upgrade	Leacree	Gabriel	Upgrade
501714049	G57089		501719249	G57013		50179539	G55662		50715729	G56620	
501714059	G57088		501719259	G57014		502716629L	G56924		50715779	G51728	
501714069	G57168		501719459	G56994		502716629R	G56925		50715809	G55892	
501714079	G57167		501719469	G56993		502716789	G56931		50716169	G55901	
501714269	G57031		501719539	G56950		502716799	G56930		50716699	G55856	
501714279	G57030		501719549	G56949		502719519	G56948		50716789	G56514	
501714359	G57140		501719579	G56933		502719529	G56948		50716799	G56506	
501714369	G57139		501719589	G56932		502722579	G57082		50716809	G55676	
501714379	G57098		501721059	G57035		502722589	G57081		50716819	G55675	
501714389	G57097		501721069	G57034		503393099	G52258		50716859	G56509	
501714519	G57120		501721159	G57114		503393109	G52257		50718229	G56718	
501714529	G57119		501721309L	G57112		50711039	G51765		50719529	G55999	
501714619	G57158		501721309R	G57113		50711199	G51855		50719549	G55661	
501714629	G57157		501721439	G57085		50712819	G55825		50719649	G55697	
501714909	G57042		501721449	G57084		50712929	G55910		50719739	G55698	
501714919	G57041		501721749	G56951		50712939	G51087		50721149	G56660	
501714929	G57044		501721779	G57141		50713219	G51722		50721159	G56661	
501714939	G57043		501721799L	G57047		50713229	G51724		50721439	G56799	
501715049	G57064		501721799R	G57048		50713279	G51727		50721449	G56800	
501715059	G57063		501721859	G57050		50713409	G51700		50722059	G56722	
501715729L	G56956		501721869	G57049		50713419	G51718		50722069	G56721	
501715729R	G56957		501721999	G57070		50713489	G51477		50722079	G56729	
501715779L	G57007		501721999	G57122		50713519	G51077		50722089	G56728	
501715779R	G57008		501722009	G57069		50713529	G51077		50722199	G56820	
501715789	G56973		501722009	G57121		50713589	G51715		50722209	G56819	
501715799	G56974		501722039	G57099		50713629	G51703		50722219	G56821	
501715809	G56975		501722039	G57100		50713629	G51704		50722229	G56822	
501715929	G56965		501722059	G57077		50713719	G51739		50722639	G52006	
501715939	G57046		501722069	G57076		50713909	G51746		50722649	G52005	
501715949	G57045		501722089	G57078		50714049	G56540		50722999	G52159	
501715979	G57012		501722099	G57111		50714059	G56539		50723009	G52158	
501715989	G57011		501722109	G57110		50714069	G56641		50723059	G52157	
501716159	G56934		501722319	G57142		50714079	G56640		50723069	G52156	
501716159	G56937		501722769	G57204		50714279	G56671		50723279	G52176	
501716169	G56936		501722929	G57147		50714339	G56622		50723289	G52175	
501716619	G57060		501723119	G57156		50714349	G56621		50723929	G52122	
501716679	G56963		501723679	G57177		50714359	G56561		50723939	G52121	
501716689	G56962		501723689	G57176		50714369	G56562		50725189	G52125	
501716699	G56964		501723929	G57162		50714859	G56802		50725269	G52128	
501716859	G57051		501723939	G57161		50715049	G56517		50725279	G52127	
501716919L	G56991		501724019	G57178		50715059	G56516				
501716919R	G56992		50179519	G55999		50715259	G56606				

Leyland Truck

Leyland truck	Gabriel	Upgrade	Leyland truck	Gabriel	Upgrade	Leyland truck	Gabriel	Upgrade	Leyland truck	Gabriel	Upgrade
1456033	85311	89424	1456033	89424							

LGE Coachworks

Lge coachworks	Gabriel	Upgrade	Lge coachworks	Gabriel	Upgrade	Lge coachworks	Gabriel	Upgrade	Lge coachworks	Gabriel	Upgrade
ASH-1136	G63623		ASH-1154	G63622							

Link Manufacturing LTD.

Link manufacturing ltd.	Gabriel	Upgrade	Link manufacturing ltd.	Gabriel	Upgrade	Link manufacturing ltd.	Gabriel	Upgrade	Link manufacturing ltd.	Gabriel	Upgrade
1201-0012	83023		1201-1212	83013		1201-9013	83062		12011043	83025	
1201-0154	83051		1201-1213	83005		1201-9014	83062		12011044	83025	
1201-0254	83051		1201-9007	83054		1201-9018	83062		12011046	83049	
1201-1043	83025		1201-9008	83054		1201-9021	83062				
1201-1044	83025		1201-9009	83054		12010012	83023				
1201-1046	83049		1201-9010	83053		12010154	83051				
1201-1049	83025		1201-9011	83053		12010254	83051				

Important Note: Competitive Interchanges are to be used for stocking purposes only. Where multiple crosses are identified, please reference the applications section of this catalog. / **Remarque importante:** Les interchanges concurrentiels ne s'utilisent qu'aux fins de stocks. Dans le cas de rferences multiples, consulter la section des applications du catalogue. / **Nota importante:** Dans le cas de rferences multiples, consulter la section des applications du catalogue. / **Nota importante:** Se pueden usar intercambios competitivos para propósitos de almacenamiento solamente. Cuando se identifican intercambios múltiples, consulte la sección de aplicaciones de este catálogo.

COMPETITIVE & O.E.M. INTERCHANGE LIST
Lista de Intercambios contra Competidores y Equipo Original.
Liste d'interchange de produits comptitifs & d'equpement original (OEM)

Link Manufacturing LTD.... cont'd

Link manufacturing ltd. Gabriel Upgrade	Link manufacturing ltd. Gabriel Upgrade	Link manufacturing ltd. Gabriel Upgrade	Link manufacturing ltd. Gabriel Upgrade
12011049	83025	1202-1064	83024
12011212	83013	1202-1065	83002
12011213	83005	1202-1164	83031
12019007	83054	1202-1212	83013
12019008	83054	1202-1213	83005
12019009	83054	1202-1286	83056
12019010	83053	12020012	83023
12019011	83053	12020032	83016
12019013	83062	12020042	83025
12019014	83062	12020043	83025
12019018	83062	12020044	83025
12019021	83062	12020052	83021
1202-0012	83023	12020054	83021
1202-0032	83016	12021042	83025
1202-0042	83025	12021043	83025
1202-0043	83025	12021044	83025
1202-0044	83025	12021046	83049
1202-0052	83021	12021064	83024
1202-0054	83021	12021065	83002
1202-1042	83025	12021164	83031
1202-1043	83025	12021212	83013
1202-1044	83025	12021213	83005
1202-1046	83049	12021286	83056
1202K065	83002	1202K164	83031
1202K264	83031	1202K286	83056
1210-0001	646155	1210-0002	632147
1210-0005	85734	1210-0007	665937
1210-0009	665937	1210-0010	646155
1210-0012	646155	1210-0528	85043
12100005	85734	12100005	85734
12100528	85043	12100528	85043
14QK-3100	85739	14QK3100	85739
446-51-211	85739	44651211	85739
632129	83023	632129	83023
632155	646177	632155	646177
635705	83016	635705	83016
646168	646155	646168	646155
654669	83021	654669	83021
654799	83025	654811	83024
654833	83021	654833	83021
654847	83002	654847	83002
654849	83031	654849	83031
654867	83025	654867	83025
671093	85043	671093	85043
700115	85712	700115	85712
LG40450	83016	LG40450	83016
LG40470	83016	LG40470	83016
R71-1004	83049	R71-1004	83049
R71-1005	83024	R71-1005	83024
R711004	83049	R711004	83049
R711005	83024	R711005	83024
T71-1000	83031	T71-1000	83031
T71-1001	83031	T71-1001	83031
T71-1002	83002	T71-1002	83002
T711000	83031	T711000	83031
T711001	83031	T711001	83031
T711002	83002	T711002	83002

Lion Bus

Lion bus Gabriel Upgrade	Lion bus Gabriel Upgrade	Lion bus Gabriel Upgrade	Lion bus Gabriel Upgrade
58913-009	85959	60665-025	89405
58913-009L	85959	60665-025L	85036 89405
58913009	85959	60665-025L	89405
58913009L	85959	60665025	85036 89405
60665-025	85036 89405	60665025	89405
60665025L	85036 89405	60665025L	85036 89405
60670-018	83166	60670-018L	83166
60670018L	83166	60670-018L	83166
60670030	83166	60670-030	83166
60670030L	83166	60670030L	83166

Lodal Inc.

Lodal inc. Gabriel Upgrade	Lodal inc. Gabriel Upgrade	Lodal inc. Gabriel Upgrade	Lodal inc. Gabriel Upgrade
9960257	83122 89406	9960257	89406

Mack

Mack Gabriel Upgrade	Mack Gabriel Upgrade	Mack Gabriel Upgrade	Mack Gabriel Upgrade
1201-0012	83023	14QK-143	89407
12010012	83023	14QK-145	85307
1202-0012	83023	14QK-20001P2	85308 89422
1202-0032	83016	14QK-20001P2	89422
12020012	83023	14QK-2100	83221
12020032	83016	14QK-2100P1	83221
1252607B000	85702	14QK-2100P2	83209 89414
14-2136M	85061 89450	14QK-2100P2	89414
14-2136M	89450	14QK-2100P3	83207 89407
141700000370	85061 89450	14QK-2100P3	89407
141700000370	89450	14QK-2100P4	83207 89407
141700000373	85061 89450	14QK-2100P4	89407
141700000380	85061 89450	14QK-2100P5	83221
141700005839	85061 89450	14QK-2100P6	85036 89405
14QK-1200P4	83207 89407	14QK-2100P6	89405
14QK-1200P4	89407	14QK-2100P7	83221
14QK-140	85304	14QK-2100P8	83242
14QK-140P1	83225	14QK-2102	85304
14QK-142	85305	14QK-2105	83209 89414
14QK-142AP1	83215	14QK-2105	89414
14QK-142P1	83215	14QK-2107	83209 89414
14QK-143	83207 89407	14QK-2107	83215
14QK-2107	89414	14QK-2107	83215
14QK-2107P1	83215	14QK-2107	83215
14QK-2107P2	83215	14QK-2107	83215
14QK-2107P3	83215	14QK-2107	83215
14QK-2108	83203 89436	14QK-2108	83203 89436
14QK-2108P1	83203 89436	14QK-2108P1	83203 89436
14QK-2110	85305	14QK-2110	85305
14QK-2110P1	85305	14QK-2110P1	85305
14QK-2111	83019	14QK-2111	83019
14QK-2111-P2	83019	14QK-2111-P2	83019
14QK-2111-P4	83019	14QK-2111-P4	83019
14QK-2113	85001 89410	14QK-2113	85001 89410
14QK-2113	89410	14QK-2113	89410
14QK-2113P3	85001 89410	14QK-2113P3	85001 89410
14QK-2113P3	89410	14QK-2113P3	89410
14QK-2113P4	85007	14QK-2113P4	85007
14QK-2113P5	85001 89410	14QK-2113P5	85001 89410
14QK-2113P5	89410	14QK-2113P5	89410
14QK-2113P6	85007	14QK-2113P6	85007
14QK-2115	85305	14QK-2115	85305
14QK-2133M	85001 89410	14QK-2133M	85001 89410
14QK-2133M	89410	14QK-2133M	89410
14QK-2133M2	85001 89410	14QK-2133M2	85001 89410
14QK-2133M2	89410	14QK-2133M2	89410
14QK-2136M	85061 89450	14QK-2136M	85061 89450
14QK-282P1	83216	14QK-282P1	83216
14QK-282P3	83216	14QK-282P3	83216
14QK-288-P1	85007	14QK-288-P1	85007
14QK-29001P2	85303 89422	14QK-29001P2	85303 89422
14QK-29001P2	89422	14QK-29001P2	89422
14QK-29301P1	83207 89407	14QK-29301P1	83207 89407
14QK-29301P1	89407	14QK-29301P1	89407
14QK-29301P2	83207 89407	14QK-29301P2	83207 89407
14QK-29301P2	89407	14QK-29301P2	89407
14QK-29302	83207 89407	14QK-29302	83207 89407
14QK-29302	89407	14QK-29302	89407
14QK-29302P1	83207 89407	14QK-29302P1	83207 89407
14QK-29302P1	89407	14QK-29302P1	89407

Important Note: Competitive Interchanges are to be used for stocking purposes only. Where multiple crosses are identified, please reference the applications section of this catalog. / **Remarque importante:** Les interchanges concurrentiels ne s'utilisent qu'aux fins de stocks. Dans le cas de rferences multiples, consulter la section des applications du catalogue. / **Nota importante:** Dans le cas de rferences multiples, consulter la section des applications du catalogue. / **Nota importante:** Se pueden usar intercambios competitivos para propósitos de almacenamiento solamente. Cuando se identifican intercambios múltiples, consulte la sección de aplicaciones de este catálogo.

COMPETITIVE & O.E.M. INTERCHANGE LIST

Lista de Intercambios contra Competidores y Equipo Original.

Liste d'interchange de produits compititifs & d'equipement original (OEM)

Mack... cont'd

Mack	Gabriel	Upgrade	Mack	Gabriel	Upgrade	Mack	Gabriel	Upgrade	Mack	Gabriel	Upgrade
14QK-303M	83050		14QK-392M	85005	89430	14QK2100P2	83209	89414	14QK303M	83050	
14QK-3100	85739		14QK-392M	89430		14QK2100P2	89414		14QK3100	85739	
14QK-3101M	85066	89448	14QK-393AM	83123	89405	14QK2100P3	83207	89407	14QK3101M	85066	89448
14QK-3101M	89448		14QK-393AM	89405		14QK2100P3	89407		14QK3101M	89448	
14QK-3103M	83050		14QK-393M	85010		14QK2100P4	83207	89407	14QK3103M	83050	
14QK-3107M	85061	89450	14QK-396	85005	89430	14QK2100P4	89407		14QK3107M	85061	89450
14QK-3108	85080		14QK-396	89430		14QK2100P5	83221		14QK3108	85080	
14QK-3108M	85080		14QK-396M	85005	89430	14QK2100P6	85036	89405	14QK3108M	85080	
14QK-3114M	85061	89450	14QK-396M	89430		14QK2100P6	89405		14QK3114M	85061	89450
14QK-3115M	85972		14QK-399M	83045		14QK2100P7	83221		14QK3115M	85972	
14QK-3116M	83101		14QK-399M2	83045		14QK2100P8	83242		14QK3116M	83101	
14QK-322M	85933	89454	14QK-399M3	83045		14QK2102	85304		14QK322M	85933	89454
14QK-322M	89454		14QK-410M	83125		14QK2105	83209	89414	14QK322M	89454	
14QK-366	85036	89405	14QK-410M2	83137		14QK2105	89414		14QK366	85036	89405
14QK-366	89405		14QK-410M3	83125		14QK2107	83209	89414	14QK366	89405	
14QK-366P1	85036	89405	14QK-411	83007		14QK2107	83215		14QK366P1	85036	89405
14QK-366P1	89405		14QK-411AM	83007		14QK2107	89414		14QK366P1	89405	
14QK-366P2	85036	89405	14QK-411M	83007		14QK2107P1	83215		14QK366P2	85036	89405
14QK-366P2	89405		14QK-413M	83111		14QK2107P2	83215		14QK366P2	89405	
14QK-366P3	85036	89405	14QK-413M4	83110		14QK2107P3	83215		14QK366P3	85036	89405
14QK-366P3	89405		14QK-413M6	83111		14QK2108	83203	89436	14QK366P3	89405	
14QK-366P4	83209	89414	14QK-413M7	83111		14QK2108	89436		14QK366P4	83209	89414
14QK-366P4	89414		14QK-414M	85906	89407	14QK2108P1	83203	89436	14QK366P4	89414	
14QK-372M	83221		14QK-414M	89407		14QK2108P1	89436		14QK372M	83221	
14QK-372M2	83209	89414	14QK-414M2	85909		14QK2110	85305		14QK372M2	83209	89414
14QK-372M2	89414		14QK-415M	83112		14QK2110P1	85305		14QK372M2	89414	
14QK-372M3	83122	89406	14QK-415M7	83112		14QK2111	83019		14QK372M3	83122	89406
14QK-372M3	89406		14QK-421M	85014		14QK2111P2	83019		14QK372M3	89406	
14QK-373	83215		14QK-422M	85933	89454	14QK2111P4	83019		14QK373	83215	
14QK-374	83003		14QK-422M	89454		14QK2113	85001	89410	14QK374	83003	
14QK-375M	83123	89405	14QK-423M	85978		14QK2113	89410		14QK375M	83123	89405
14QK-375M	89405		14QK-424M	83147		14QK2113P3	85001	89410	14QK375M	89405	
14QK-376	83003		14QK-427M	85080		14QK2113P3	89410		14QK376	83003	
14QK-377M	83215		14QK-428	85080		14QK2113P4	85007		14QK377M	83215	
14QK-378	83215		14QK-428M	85080		14QK2113P5	85001	89410	14QK378	83215	
14QK-378M	83215		14QK-429M2	85072		14QK2113P5	89410		14QK378M	83215	
14QK-382	83018		14QK-431M	85061	89450	14QK2113P6	85007		14QK382	83018	
14QK-382-P2	83018		14QK-432M	83050		14QK2115	85305		14QK382P2	83018	
14QK-390	83105		14QK-434M	85014		14QK2133M	85001	89410	14QK390	83105	
14QK-391AM	83041		14QK-439M	83050		14QK2133M	89410		14QK391AM	83041	
14QK-391AM2	83041		14QK-493M	83101		14QK2133M2	85001	89410	14QK391AM2	83041	
14QK-391BM	83041		14QK-5142	83142		14QK2133M2	89410		14QK391BM	83041	
14QK-391BM2	83041		14QK1200P4	83207	89407	14QK2136M	85061	89450	14QK391BM2	83041	
14QK-391M	83041		14QK1200P4	89407		14QK282P1	83216		14QK391M	83041	
14QK-391M2	83041		14QK140	85304		14QK282P3	83216		14QK391M2	83041	
14QK-392AM	85005	89430	14QK140P1	83225		14QK288P1	85007		14QK392AM	85005	89430
14QK-392AM	89430		14QK142	85305		14QK29001P2	85303	89422	14QK392AM	89430	
14QK-392AM2	85005	89430	14QK142AP1	83215		14QK29001P2	89422		14QK392AM2	85005	89430
14QK-392AM2	89430		14QK142P1	83215		14QK29301P1	83207	89407	14QK392AM2	89430	
14QK-392AM3	85005	89430	14QK143	83207	89407	14QK29301P1	89407		14QK392AM3	85005	89430
14QK-392AM3	89430		14QK143	89407		14QK29301P2	83207	89407	14QK392AM3	89430	
14QK-392BM	85005	89430	14QK145	85307		14QK29301P2	89407		14QK392BM	85005	89430
14QK-392BM	89430		14QK20001P2	85308	89422	14QK29302	83207	89407	14QK392BM	89430	
14QK-392BM2	85321		14QK20001P2	89422		14QK29302	89407		14QK392BM2	85321	
14QK-392BM3	85005	89430	14QK2100	83221		14QK29302P1	83207	89407	14QK392BM3	85005	89430
14QK-392BM3	89430		14QK2100P1	83221		14QK29302P1	89407		14QK392BM3	89430	

Important Note: Competitive Interchanges are to be used for stocking purposes only. Where multiple crosses are identified, please reference the applications section of this catalog. / Remarque importante: Les interchanges concurrentiels ne s'utilisent qu'aux fins de stocks. Dans le cas de rfrences multiples, consulter la section des applications du catalogue. / Nota importante: Dans le cas de rfrences multiples, consultar la seccion des aplicaciones del catalogo. / Nota importante: Se pueden usar intercambios competitivos para propósitos de almacenamiento solamente. Cuando se identifican intercambios múltiples, consulte la seccion de aplicaciones de este catalogo.

COMPETITIVE & O.E.M. INTERCHANGE LIST
Lista de Intercambios contra Competidores y Equipo Original.
Liste dinterchange de produits comptitifs & dquipement original (OEM)

Mack... cont'd

Mack	Gabriel	Upgrade	Mack	Gabriel	Upgrade	Mack	Gabriel	Upgrade	Mack	Gabriel	Upgrade
14QK392M	85005	89430	20897198	85061	89450	25625635	83045		57241006	83111	
14QK392M	89430		20973993	85061	89450	25625636	83045		57241006L	83111	
14QK393AM	83123	89405	20998401	85014		25625637	83045		572414	83110	
14QK393AM	89405		21002497	85972		25625743	85005	89430	5966-90044025	83209	89414
14QK393M	85010		21010744	83101		25625743	89430		5966-90044025	89414	
14QK396	85005	89430	21154393	83050		25626048	85080		596690044025	83209	89414
14QK396	89430		21155033	83101		25626149	85080		596690044025	89414	
14QK396M	85005	89430	21345868	83066		25626196	83142		60657-007	85072	
14QK396M	89430		21345869	83066		25631922	83007		60657007	85072	
14QK399M	83045		21436094	85927		25632145	85001	89410	60670-006	83147	
14QK399M2	83045		21436096	85061	89450	25632145	89410		60670-006L	83147	
14QK399M3	83045		21462382	85088		25632147	85305		60670006	83147	
14QK410M	83125		21462384	85088		25632561	83209	89414	60670006L	83147	
14QK410M2	83137		21490486	83066		25632561	89414		60675-001	85978	
14QK410M3	83125		21979343	85065		25633154	85906	89407	60675-001L	85978	
14QK411	83007		22202559	85088		25633154	89407		60675-13	85036	89405
14QK411AM	83007		22202560	85088		4103-5000447861	83105		60675-13	89405	
14QK411M	83007		22314111	85036	89405	4103-5000546892	83105		60675001	85978	
14QK413M	83111		22314111	89405		41035000447861	83105		60675001L	85978	
14QK413M4	83110		22662254	83901		41035000546892	83105		6067513	85036	89405
14QK413M6	83111		22662259	83901		446-51-211	85739		6067513	89405	
14QK413M7	83111		23030654	83910		44651211	85739		60680-003	83112	
14QK414M	85906	89407	23145372	83066		471700000426	85014		60680-003L	83112	
14QK414M	89407		23159760	85188		471700000430	89448		60680-004	83143	
14QK414M2	85909		23159762	85188		471700000431	85066	89448	60680-004L	83143	
14QK415M	83112		23292027	85061	89450	471700000431	89448		60680-005	83142	
14QK415M7	83112		23292028	85061	89450	471700000445	85080		60680-005L	83142	
14QK421M	85014		23327756	83910		471700000451	85080		60680003	83112	
14QK422M	85933	89454	23359394	83101		471700002626	85061	89450	60680003L	83112	
14QK422M	89454		23818296	85978		471700002630	85061	89450	60680004	83143	
14QK423M	85978		24145343	85005	89430	471700002630	89450		60680004L	83143	
14QK424M	83147		24145343	89430		471700002861	85014		60680005	83142	
14QK427M	85080		25621571	83215		471700006039	85088		60680005L	83142	
14QK428	85080		25621955	85001	89410	471700008934	85065		64838-002	85933	89454
14QK428M	85080		25621955	89410		471700009646	85088		64838-002	89454	
14QK431M	85061	89450	25622221	83111		471700009647	85088		64838002	85933	89454
14QK432M	83050		25622345	83242		471700009650	85088		64838002	89454	
14QK434M	85014		25622466	85001	89410	471700015341	83127		650102	85001	89410
14QK439M	83050		25622466	89410		471700131921	85933	89454	650102	89410	
14QK493M	83101		25622612	83041		471700131921	89454		650107	85316	89426
14QK5142	83142		25622613	83041		47902-25	83125		650107	89426	
20469001	85933	89454	25623321	83215		47902-9	83123	89405	650107MT	85316	89426
20469001	89454		25624241	83112		47902-9	89405		650107MT	89426	
20469002	85933	89454	25624341	83110		4790225	83125		650400MT	85033	89427
20469002	89454		25624351	85909		479029	83123	89405	650400MT	89427	
20485632	85933	89454	25624837	83041		479029	89405		650402	85311	89424
20485632	89454		25624862	85321		4940654	83216		650402	89424	
20485633	85933	89454	25625091	83215		5533699	85302	89420	650402MT	85311	89424
20485633	89454		25625151	85036	89405	5533699	89420		650402MT	89424	
20513881	85061	89450	25625151	89405		5554184	85302	89420	650404	85310	89423
20570098	83147		25625187	83209	89414	5554184	89420		650404	89423	
20625775	85014		25625187	89414		57241-004	83110		650404MT	85310	89423
20782199	85072		25625223	83111		57241-006	83111		650404MT	89423	
20863239	85080		25625234	83125		57241-006L	83111		650405	85023	89415
20873442	83050		25625241	83112		57241-4	83110		650405	89415	
20874147	83050		25625254	83125		57241004	83110		650405MT	85023	89415

Important Note: Competitive Interchanges are to be used for stocking purposes only. Where multiple crosses are identified, please reference the applications section of this catalog. / **Remarque importante:** Les interchanges concurrentiels ne s'utilisent qu'aux fins de stocks. Dans le cas de références multiples, consulter la section des applications du catalogue. / **Nota importante:** En el caso de referencias múltiples, consultar la sección de aplicaciones de este catálogo. / **Nota importante:** Se pueden usar intercambios competitivos para propósitos de almacenamiento solamente. Cuando se identifican intercambios múltiples, consulte la sección de aplicaciones de este catálogo.

COMPETITIVE & O.E.M. INTERCHANGE LIST
Lista de Intercambios contra Competidores y Equipo Original.
Liste dinterchange de produits compititifs & dquipement original (OEM)

Mack... cont'd

Mack	Gabriel	Upgrade	Mack	Gabriel	Upgrade	Mack	Gabriel	Upgrade	Mack	Gabriel	Upgrade
650405MT	89415		651103	85036	89405	8083872	85978		SDA471700000431	89448	
650406	85024		651103	89405		90045099	85906	89407	SDA471700002861	85014	
650408	85319	89428	651151	83209	89414	90045099	89407		V10234121	83105	
650408	89428		651151	89414		H60680004	83143		V10242320	83105	
650408MT	85319	89428	70042	85302	89420	H60680005	83142				
650408MT	89428		70042	89420		SDA141700000380	85061	89450			
651012	83221		78530771	83127		SDA471700000431	85066	89448			

Maeco

Maeco	Gabriel	Upgrade	Maeco	Gabriel	Upgrade	Maeco	Gabriel	Upgrade	Maeco	Gabriel	Upgrade
1085	83214		16776	89406		70039	89422		70402	85305	
12608	83125		16777	85006		70041	85305		70642	85300	89419
12788	83216		16778	83203	89436	70042	85302	89420	70642	89419	
12866	83207	89407	16778	89436		70042	89420		70644	85334	
12866	89407		16779	83126	89430	70088	85307		70648	89414	
16385	83215		16779	89430		70123	85716		70650	89440	
1668722	85030	89440	16780	83123	89405	70127	85006		70651	85013	89414
1668722	89440		16780	89405		70128	85006		70651	89414	
16720	83107		16781	85006		70162	85716		70652	85030	89440
16767	85013	89414	16787	85030	89440	70163	85302	89420	70652	89440	
16767	89414		16787	89440		70163	89420		70663	85013	89414
16769	83221		16949	83120		70164	85716		70663	89414	
16770	83209	89414	6025	83122	89406	70300	85320	89429	70691	85007	
16770	89414		6025	89406		70300	89429		70720	85934	
16771	83126	89430	6026	83204		70312	85001	89410	70721	83125	
16771	89430		70018	85303	89422	70312	89410		74039	85303	89422
16772	83122	89406	70018	89422		70315	85063		74039	89422	
16772	89406		70021	85303	89422	70317	89402		OE10881	85711	
16773	85005	89430	70021	89422		70331	85314	89425	OE10882	85740	
16773	89430		70029	85308	89422	70331	89425		OE10883	85339	
16774	83215		70029	89422		70332	83314		OE12425	83214	
16775	83207	89407	70034	85302	89420	70334	85316	89426			
16775	89407		70034	89420		70334	89426				
16776	83122	89406	70039	85303	89422	70397	85006				

Mandalay Coach

Mandalay coach	Gabriel	Upgrade	Mandalay coach	Gabriel	Upgrade	Mandalay coach	Gabriel	Upgrade	Mandalay coach	Gabriel	Upgrade
141700131809	85029		16-16873-000	85029		1616737000	83160		481700000490	85900	
141700131810	83160		16-16874-000	83160		1616873000	85029		481700000493	85900	
16-16736-000	85029		16-18103-000	85900		1616874000	83160				
16-16737-000	83160		1616736000	85029		1618103000	85900				

Marathon

Marathon	Gabriel	Upgrade	Marathon	Gabriel	Upgrade	Marathon	Gabriel	Upgrade	Marathon	Gabriel	Upgrade
43137-MB	83009		58092-MB	85954		58101-MB	85938		58119-MB	85061	89450
53010-MB	83136		58093-MB	85033	89427	58102-MB	85012	89413	58120-MB	85918	89449
53018-MB	83317		58093-MB	89427		58102-MB	89413		58120-MB	89449	
53019-MB	83456	89447	58094-MB	85064		58103-MB	85900		58121-MB	85013	89414
53019-MB	89447		58095-MB	85066	89448	58105-MB	85088		58121-MB	89414	
53039-MB	85006		58095-MB	89448		58107-MB	85958		58122-MB	85030	89440
53101-MB	83038		58096-MB	85067	89451	58113-MB	85052		58122-MB	89440	
53106-MB	83127		58096-MB	89451		58114-MB	85934		58123-MB	85924	89457
53108-MB	85029		58097-MB	85069	89455	58115-MB	85937		58123-MB	89457	
53109-MB	83125		58097-MB	89455		58116-MB	85001	89410	72014-MB	83128	89436
58049-MB	85000	89436	58098-MB	85045		58116-MB	89410		72014-MB	89436	
58049-MB	89436		58099-MB	85062	89408	58117-MB	85931	89458	72051-MB	83008	
58064-MB	85070	89459	58099-MB	89408		58117-MB	89458		78013-MB	85323	89436
58064-MB	89459		58100-MB	85933	89454	58118-MB	85003	89411	78013-MB	89436	
58085-MB	85072		58100-MB	89454		58118-MB	89411		78015-MB	85724	89443

Important Note: Competitive Interchanges are to be used for stocking purposes only. Where multiple crosses are identified, please reference the applications section of this catalog. / **Remarque importante:** Les interchanges concurrentiels ne s'utilisent qu'aux fins de stocks. Dans le cas de références multiples, consulter la section des applications du catalogue. / **Nota importante:** Dans le cas de références multiples, consulter la section des applications du catalogue. / **Nota importante:** Se pueden usar intercambios competitivos para propósitos de almacenamiento solamente. Cuando se identifican intercambios múltiples, consulte la sección de aplicaciones de este catálogo.

COMPETITIVE & O.E.M. INTERCHANGE LIST
Lista de Intercambios contra Competidores y Equipo Original.
Liste dinterchange de produits comptitifs & dquipement original (OEM)

Marathon... cont'd

Marathon	Gabriel	Upgrade	Marathon	Gabriel	Upgrade	Marathon	Gabriel	Upgrade	Marathon	Gabriel	Upgrade
78015-MB	89443		78031-MB	89424		78077-MB	85310	89423	78078-MB	85320	89429
78031-MB	85311	89424	78076-MB	85738		78077-MB	89423		78078-MB	89429	

Marmon

Marmon	Gabriel	Upgrade	Marmon	Gabriel	Upgrade	Marmon	Gabriel	Upgrade	Marmon	Gabriel	Upgrade
1-7001	83216		37-1-1	89406		51-163-7	83123	89405	511637	89405	
1202-0054	83021		3711	83122	89406	51-163-7	89405		576451	83122	89406
12020054	83021		3711	89406		5113928	85003	89411	576451	89406	
17001	83216		51-139-28	85003	89411	5113928	89411		665147	83216	
37-1-1	83122	89406	51-139-28	89411		511637	83123	89405			

Maxpro

Maxpro	Gabriel	Upgrade	Maxpro	Gabriel	Upgrade	Maxpro	Gabriel	Upgrade	Maxpro	Gabriel	Upgrade
17E-Z10042	85061	89450									

Mazda

Mazda	Gabriel	Upgrade	Mazda	Gabriel	Upgrade	Mazda	Gabriel	Upgrade	Mazda	Gabriel	Upgrade
EG21-28-910E	G64056		EG23-28-910B	G64056		EG23-34-900A	G52209		GK2A-34-900J	G57270	
EG21-34-900A	G52209		EG23-28-910C	G64056		EG23-34-900B	G52209		N066-28-700	G56597	
EG21-34-900B	G52209		EG23-28-910D	G64056		GK2A-28-700D	69591				
EG21-34-900C	G52209		EG23-34-900	G52209		GK2A-34-700H	G57270				

Mc Neilus Truck & Man.

Mc neilus truck & man.	Gabriel	Upgrade	Mc neilus truck & man.	Gabriel	Upgrade	Mc neilus truck & man.	Gabriel	Upgrade	Mc neilus truck & man.	Gabriel	Upgrade
060670-018	83166		1429317 MTM	85919		3HR916 MTM	83207	89407	600-11599M	632147	
1139039 MTM	85334		1431085 MTM	85738		3HR916 MTM	89407		600-188206	646155	
1139046 MTM	83112		1432386 MTM	85965		40-0242	83312	89409	60670-018	83166	
1139059 MTM	83207	89407	1433009 MTM	85962		40-0242	89409		60670018	83166	
1139059 MTM	89407		1445910	85300	89419	40-4845	85304		64442AX MTM	83128	89436
1139069 MTM	83209	89414	1445910	89419		40-4951	85316	89426	64442AX MTM	89436	
1139069 MTM	89414		1468783 MTM	85345		40-4951	89426		651444	83221	
1170719	632147		1473224	646155		40-5348	85058	89431	665040	85303	89422
1202-0054	83021		1485576 MTM	85979		40-5348	89431		665040	89422	
12020054	83021		1491909 MTM	83128	89436	40-6967	85030	89440	665060	83122	89406
12405F	85734		1491909 MTM	89436		40-6967	89440		665060	89406	
12405F-1	85303	89422	1573270	83207	89407	400242	83312	89409	690049	85303	89422
12405F-1	89422		1573270	89407		400242	89409		690049	89422	
12405F1	85303	89422	1573280	83221		4036892	G63605		6HA961 MTM	83123	89405
12405F1	89422		1583470	85051		404845	85304		6HA961 MTM	89405	
12405FX1	85303	89422	1KK552 MTM	85967		404951	85316	89426	6HB390 MTM	83137	
12405FX1	89422		2034140	646177		404951	89426		6HD720 MTM	85909	
12405FX1 MTM	85303	89422	2034140 MTM	646155		405348	85058	89431	6HS773 MTM	83122	89406
12405FX1 MTM	89422		217330	85303	89422	405348	89431		6HS773 MTM	89406	
1323106 MTM	85305		217330	89422		406967	85030	89440	6KP857 MTM	85000	89436
1333575 MTM	85072		2173340	85303	89422	406967	89440		6KP857 MTM	89436	
1340975 MTM	83142		2173340	89422		4HA569 MTM	85932	89453	7HS237 MTM	83122	89406
1340976 MTM	85919		2218640	83009		4HA569 MTM	89453		7HS237 MTM	89406	
1340979 MTM	83143		2218640 MTM	83009		4KP398 MTM	85933	89454	7HS534 MTM	85906	89407
1360386 MTM	85323	89436	26228-A	83122	89406	4KP398 MTM	89454		7HS534 MTM	89407	
1360386 MTM	89436		26228-A	89406		5353054	85303	89422	8KK524 MTM	83168	
1367383 MTM	83147		26228A	83122	89406	5353054	89422		90044448	85051	
1396513 MTM	85959		26228A	89406		5361994	85734		9HB362 MTM	85976	
1398980	83127		2JD137	83119		5HA994 MTM	85916	89430	9KK464 MTM	85079	
1398980 MTM	83127		3215395 MTM	83112		5HA994 MTM	89430		MB-37737-30	646155	
1404068 MTM	85087		3638112	G63183		5HB645 MTM	83109		P117099	83120	
1410046 MTM	85919		3HR582 MTM	85013	89414	5KK247 MTM	85977		RW24285	83119	
1411765 MTM	83148		3HR582 MTM	89414		600-115994B	632147				

McQuay Norris

Mcquay norris	Gabriel	Upgrade	Mcquay norris	Gabriel	Upgrade	Mcquay norris	Gabriel	Upgrade	Mcquay norris	Gabriel	Upgrade
CB4120	143058		CB4125	143057							
CB4120	143059		CB4128	143061							

Important Note: Competitive Interchanges are to be used for stocking purposes only. Where multiple crosses are identified, please reference the applications section of this catalog. / **Remarque importante:** Les interchanges concurrentiels ne s'utilisent qu'aux fins de stocks. Dans le cas de rferences multiples, consulter la section des applications du catalogue. / **Nota importante:** Dans le cas de rferences multiples, consulter la section des aplicaciones del catalogo. / **Nota importante:** Se pueden usar intercambios competitivos para propósitos de almacenamiento solamente. Cuando se identifican intercambios múltiples, consulte la sección de aplicaciones de este catálogo.

COMPETITIVE & O.E.M. INTERCHANGE LIST
Lista de Intercambios contra Competidores y Equipo Original.
Liste dinterchange de produits comptitifs & dquipement original (OEM)

McQuay Norris... cont'd

Mcquay norris	Gabriel	Upgrade	Mcquay norris	Gabriel	Upgrade	Mcquay norris	Gabriel	Upgrade	Mcquay norris	Gabriel	Upgrade
CB4138	143057		SM7363	143325		SM7563	143418		SM7667	143462	
SM5475	143191		SM7368	143256		SM7565	143388		SM7668	143460	
SM7007	142135		SM7371	142932		SM7566	143387		SM7671	143342	
SM7049	142230		SM7372	142933		SM7569	143425		SM7672	143191	
SM7071	142245		SM7380	142938		SM7573	143385		SM7672	143365	
SM7080	143281		SM7391	143191		SM7574	143364		SM7716	143495	
SM7082	142249		SM7399	143315		SM7576	143323		SM7722	143341	
SM7086	142252		SM7402	143209		SM7580	143419		SM7723	143363	
SM7123	142329		SM7403	143204		SM7602	143408		SM7724	143461	
SM7144	142419		SM7434	143094		SM7606	143335		SM7735	143531	
SM7173	142625		SM7453	143073		SM7627	143369		SM7752	143406	
SM7236	142526		SM7454	143074		SM7627	143468		SM7760	143345	
SM7240	142530		SM7464	142937		SM7630	143316		SM7772	143491	
SM7249	143458		SM7478	143202		SM7633	143416		SM7778	143366	
SM7259	143088		SM7501	143218		SM7644	143344		SM7781	143397	
SM7289	142651		SM7510	143404		SM7646	143319		SM7782	143477	
SM7333	143367		SM7530	143396		SM7659	143394		SM7784	143409	
SM7334	143191		SM7534	143194		SM7659	143422		SM7784	143410	
SM7337	143082		SM7539	143191		SM7661	143318		SM7821	143305	
SM7343	142828		SM7541	143354		SM7662	143564				
SM7356	142836		SM7542	143355		SM7663	143391				
SM7362	143197		SM7549	143089		SM7664	143390				

Mercedes Benz

Mercedes benz	Gabriel	Upgrade	Mercedes benz	Gabriel	Upgrade	Mercedes benz	Gabriel	Upgrade	Mercedes benz	Gabriel	Upgrade
163-326-11-00	G64049		906 320 06 33	G57802		906 320 13 33	G57802		907 320 790 1	G64089	
906 320 04 33	G57802		906 320 10 33	G57802		907 320 430 1	G64089				

Meritor

Meritor	Gabriel	Upgrade	Meritor	Gabriel	Upgrade	Meritor	Gabriel	Upgrade	Meritor	Gabriel	Upgrade
14QK-3100	85739		KIT11402	86200		M83203	83203	89436	M85030	89440	
14QK3100	85739		M646155	646155		M83203	89436		M85033	85033	89427
202447	85919		M83001	83001		M83207	83207	89407	M85033	89427	
21227751	87015		M83008	83008		M83207	89407		M85036	85036	89405
446-51-211	85739		M83009	83009		M83209	83209	89414	M85036	89405	
44651211	85739		M83021	83021		M83209	89414		M85043	85043	
671020	87015		M83025	83025		M83215	83215		M85045	85045	
671506	86200		M83028	83028		M83456	83456	89447	M85046	85046	89434
671507	87015		M83029	83029		M83456	89447		M85046	89434	
671907	85919		M83038	83038		M83613	83613		M85047	85047	89435
680705	85737		M83041	83041		M85000	85000	89436	M85047	89435	
700115	85712		M83110	83110		M85000	89436		M85052	85052	
7805-F-1020	86200		M83111	83111		M85001	85001	89410	M85053	85053	89442
7805F1020	86200		M83112	83112		M85001	89410		M85053	89442	
A-3280-M-9711	85919		M83122	83122	89406	M85003	85003	89411	M85058	85058	89431
A-7805F-1020	86200		M83122	89406		M85003	89411		M85058	89431	
A-7805L-1000	85919		M83123	83123	89405	M85005	85005	89430	M85061	85061	89450
A-7805L-1026	87015		M83123	89405		M85005	89430		M85062	85062	89408
A-7805P-1030	85737		M83124	83124	89407	M85006	85006		M85062	89408	
A3280M9711	85919		M83124	89407		M85007	85007		M85064	85064	
A7805F1020	86200		M83125	83125		M85012	85012	89413	M85066	85066	89448
A7805L1000	85919		M83127	83127		M85012	89413		M85066	89448	
A7805L1026	87015		M83128	83128	89436	M85013	85013	89414	M85067	85067	89451
A7805P1030	85737		M83128	89436		M85013	89414		M85067	89451	
KIT11210	87015		M83130	83130		M85014	85014		M85069	85069	89455
KIT11375	86200		M83135	83135		M85026	85026		M85069	89455	
KIT11376	86200		M83136	83136		M85029	85029		M85070	85070	89459
KIT11389	86200		M83147	83147		M85030	85030	89440	M85070	89459	

Important Note: Competitive Interchanges are to be used for stocking purposes only. Where multiple crosses are identified, please reference the applications section of this catalog. / **Remarque importante:** Les interchanges concurrentiels ne s'utilisent qu'aux fins de stocks. Dans le cas de rferences multiples, consulter la section des applications du catalogue. / **Nota importante:** En el caso de rferences multiples, consultar la seccion de aplicaciones del catalogo. / **Nota importante:** Se pueden usar intercambios competitivos para propósitos de almacenamiento solamente. Cuando se identifican intercambios múltiples, consulte la seccion de aplicaciones de este catalogo.

COMPETITIVE & O.E.M. INTERCHANGE LIST

Lista de Intercambios contra Competidores y Equipo Original.

Liste d'interchange de produits compititifs & d'equpement original (OEM)

Meritor... cont'd

Meritor	Gabriel	Upgrade	Meritor	Gabriel	Upgrade	Meritor	Gabriel	Upgrade	Meritor	Gabriel	Upgrade
M85072	85072		M85323	89436		M85920	89503		M89408	89408	
M85300	85300	89419	M85331	85331		M85923	85923	89458	M89410	89410	
M85300	89419		M85333	85333		M85923	89458		M89411	89411	
M85301	85301		M85708	85708		M85924	85924	89457	M89413	89413	
M85303	85303	89422	M85724	85724	89443	M85924	89457		M89414	89414	
M85303	89422		M85724	89443		M85927	85927		M89423	89423	
M85305	85305		M85727	85727		M85929	85929		M89424	89424	
M85310	85310	89423	M85729	85729		M85931	85931	89458	M89427	89427	
M85310	89423		M85732	85732		M85931	89458		M89429	89429	
M85311	85311	89424	M85738	85738		M85933	85933	89454	M89430	89430	
M85311	89424		M85900	85900		M85933	89454		M89436	89436	
M85316	85316	89426	M85901	85901		M85934	85934		M89443	89443	
M85316	89426		M85902	85902		M85936	85936	89456	M89448	89448	
M85319	85319	89428	M85909	85909		M85936	89456		M89449	89449	
M85319	89428		M85918	85918	89449	M85937	85937		M89450	89450	
M85320	85320	89429	M85918	89449		M85954	85954		M89451	89451	
M85320	89429		M85919	85919		M85957	85957				
M85323	85323	89436	M85920	85920	89503	M85964	85964				

Mitsubishi

Mitsubishi	Gabriel	Upgrade	Mitsubishi	Gabriel	Upgrade	Mitsubishi	Gabriel	Upgrade	Mitsubishi	Gabriel	Upgrade
MN101519	G51838		MR491946	143394		MR554860	143088		MR961211	G51838	

Mitsubishi Fuso

Mitsubishi fuso	Gabriel	Upgrade	Mitsubishi fuso	Gabriel	Upgrade	Mitsubishi fuso	Gabriel	Upgrade	Mitsubishi fuso	Gabriel	Upgrade
MB161497	G63299		MC114595	G63405		MC813135	83456	89447	MC826268	G63610	
MC091947	83162		MC714595	G63405		MC813135	89447		MK302296	G63610	
MC091950	83162		MC809390	83103		MC814614	85009		MK433638	G63610	

Mohawk

Mohawk	Gabriel	Upgrade	Mohawk	Gabriel	Upgrade	Mohawk	Gabriel	Upgrade	Mohawk	Gabriel	Upgrade
01-0100-905	85303	89422	22012082	85702		97-9999-02320	85704		MM6886	83207	89407
01-0100-905	89422		22012114	85700		97220100011	85704		MM6886	89407	
010100905	85303	89422	4968853	83216		97999902320	85704		MM6957	83225	
010100905	89422		6-367-7	85305		MM-6886	83207	89407	MM74029	85308	89422
020273544	83203	89436	63677	85305		MM-6886	89407		MM74029	89422	
020273544	89436		680323	85700		MM-6957	83225				
050134508	85732		680485	85733		MM-74029	85308	89422			
1235233	85736		97-2201-00011	85704		MM-74029	89422				

Monaco

Monaco	Gabriel	Upgrade	Monaco	Gabriel	Upgrade	Monaco	Gabriel	Upgrade	Monaco	Gabriel	Upgrade
01809924	83144		66153002	89407		ASH-1023	83122	89406	ASH-25824	89406	
01809925	85010		9U94-18045-AA	83209	89414	ASH-1023	89406		ASH-294	83209	89414
1C34-18045-AA	83209	89414	9U94-18045-AA	89414		ASH-1205	83209	89414	ASH-294	89414	
1C34-18045-AA	89414		9U94-18080-AA	83122	89406	ASH-1205	89414		ASH1022	83209	89414
1C34-18045-JA	83209	89414	9U94-18080-AA	89406		ASH-1206	83122	89406	ASH1022	89414	
1C34-18045-JA	89414		9U9418045AA	83209	89414	ASH-1206	89406		ASH1023	83122	89406
1C3418045AA	83209	89414	9U9418045AA	89414		ASH-1228	83209	89414	ASH1023	89406	
1C3418045AA	89414		9U9418080AA	83122	89406	ASH-1228	89414		ASH1205	83209	89414
1C3418045JA	83209	89414	9U9418080AA	89406		ASH-1229	83209	89414	ASH1205	89414	
1C3418045JA	89414		9U9Z-18124-A	83209	89414	ASH-1229	89414		ASH1206	83122	89406
24-153249	85125		9U9Z-18124-A	89414		ASH-1230	83122	89406	ASH1206	89406	
24-153256	85124		9U9Z-18125-A	83122	89406	ASH-1230	89406		ASH1228	83209	89414
24-186629	85125		9U9Z-18125-A	89406		ASH-137	83122	89406	ASH1228	89414	
24153249	85125		9U9Z18124A	83209	89414	ASH-137	89406		ASH1229	83209	89414
24153256	85124		9U9Z18124A	89414		ASH-25822	83209	89414	ASH1229	89414	
24186629	85125		9U9Z18125A	83122	89406	ASH-25822	89414				
66153-002	83124	89407	9U9Z18125A	89406		ASH-25823	83209	89414			
66153-002	89407		ASH-1022	83209	89414	ASH-25823	89414				
66153002	83124	89407	ASH-1022	89414		ASH-25824	83122	89406			

Important Note: Competitive Interchanges are to be used for stocking purposes only. Where multiple crosses are identified, please reference the applications section of this catalog. / **Remarque importante:** Les interchanges concurrentiels ne s'utilisent qu'aux fins de stocks. Dans le cas de rferences multiples, consulter la section des applications du catalogue. / **Nota importante:** Dans le cas de rferences multiples, consulter la section des applications du catalogue. / **Nota importante:** Se pueden usar intercambios competitivos para propósitos de almacenamiento solamente. Cuando se identifican intercambios múltiples, consulte la sección de aplicaciones de este catálogo.

COMPETITIVE & O.E.M. INTERCHANGE LIST
Lista de Intercambios contra Competidores y Equipo Original.
Liste dinterchange de produits comptitifs & dquipement original (OEM)

Monaco... cont'd

Monaco	Gabriel	Upgrade	Monaco	Gabriel	Upgrade	Monaco	Gabriel	Upgrade	Monaco	Gabriel	Upgrade
ASH1230	83122	89406	ASH294	83209	89414	AT621	83122	89406	F4BE5A832MO	85125	
ASH1230	89406		ASH294	89414		AT621	89406		F4BE5B492HO	85125	
ASH137	83122	89406	AT-620	83209	89414	AT766	83209	89414	F4BE5C832MO	83124	89407
ASH137	89406		AT-620	89414		AT766	89414		F4BE5C832MO	89407	
ASH25822	83209	89414	AT-621	83122	89406	F4-BE5-A832-MO	85125		F4BE5F324HO	85125	
ASH25822	89414		AT-621	89406		F4-BE5-B492-HO	85125		F4BE5F325HO	85124	
ASH25823	83209	89414	AT-766	83209	89414	F4-BE5-C832-MO	83124	89407	W0005662	85125	
ASH25823	89414		AT-766	89414		F4-BE5-C832-MO	89407		W0005663	85124	
ASH25824	83122	89406	AT620	83209	89414	F4-BE5-F324-HO	85125		W0006254	85125	
ASH25824	89406		AT620	89414		F4-BE5-F325-HO	85124				

Monroe

Monroe	Gabriel	Upgrade	Monroe	Gabriel	Upgrade	Monroe	Gabriel	Upgrade	Monroe	Gabriel	Upgrade
1000	82156		171100	G57146		171347L	G57220		171452	G57119	
1085	83214		171101L	G57425		171347R	G57221		171453	G57106	
12608	83125		171101R	G57424		171348L	G57027		171454	G57105	
12788	83216		171102	G57413		171348R	G57027		171461	G57158	
12866	83207	89407	171102	G57647		171351L	G57065		171462	G57157	
12866	89407		171103	G57118		171351R	G57066		171490	G57042	
12872	83219		171111	G57053		171352L	G57010		171491	G57041	
139104	G57125		171114L	G57444		171352R	G57010		171492	G57044	
139105	G57023		171119L	G57123		171353	G57282		171493	G57043	
139112	G57000		171119R	G57124		171358	G57092		171494	G57649	
1401	58423		171124	G57095		171359	G57036		171495	G57648	
1401	61531		171125	G57096		171361	G57020		171504	G57064	
1401	81516		171126	G57447		171362	G57021		171505	G57063	
16385	83215		171128L	G57206		171369	G57015		171525	G57039	
1668722	85030	89440	171128R	G57206		171370	G57016		171572L	G56956	
1668722	89440		171130	G57466		171371L	G57133		171572R	G56957	
16720	83107		171131	G57465		171371R	G57134		171575	G57397	
16721	83125		171137L	G57454		171372	G57056		171577L	G57007	
16767	85013	89414	171137R	G57453		171373L	G57067		171577R	G57008	
16767	89414		171138	G57172		171373R	G57068		171578	G56973	
16769	83221		171139	G57173		171377L	G57083		171579	G56974	
16770	83209	89414	171140	G57132		171377R	G57083		171580	G56975	
16770	89414		171141	G57103		171380L	G57086		171581	G57364	
16771	83126	89430	171266	G56995		171380R	G57087		171582	G57363	
16771	89430		171281	G56938		171398	G57019		171584	G57279	
16772	83122	89406	171282	G57422		171400	G57269		171585	G57278	
16772	89406		171291L	G56996		171401	G57268		171592	G56965	
16773	85005	89430	171291R	G56997		171404	G57089		171593	G57046	
16773	89430		171292	G56998		171405	G57088		171594	G57045	
16774	83215		171293	G57057		171406	G57168		171597	G57012	
16775	83207	89407	171293	G57058		171407	G57167		171598	G57011	
16775	89407		171299	G56943		171417	G57059		171615	G56934	
16776	83122	89406	171312	G57036		171426	G57031		171615	G56937	
16776	89406		171313	G57026		171427	G57030		171616	G56936	
16777	85006		171313	G57075		171433	G57050		171661	G57060	
16778	83203	89436	171321	G57017		171433	G57522		171662L	G56924	
16778	89436		171322	G63679		171434	G57049		171662R	G56925	
16779	83126	89430	171327	G57159		171434	G57521		171665	G56929	
16779	89430		171327	G57160		171435	G57140		171667	G56963	
16780	83123	89405	171340L	G57032		171436	G57139		171668	G56962	
16780	89405		171340L	G57061		171437	G57098		171669	G56964	
16781	85006		171340R	G57033		171438	G57097				
16787	85030	89440	171340R	G57062		171441	G57145				
16787	89440		171341	G57022		171442	G57144				
16949	83120		171346	G57080		171451	G57120				

Important Note: Competitive Interchanges are to be used for stocking purposes only. Where multiple crosses are identified, please reference the applications section of this catalog./ **Remarque importante:** Les interchanges concurrentiels ne s'utilisent qu'aux fins de stocks. Dans le cas de rfrences multiples, consulter la section des applications du catalogue./ **Nota importante:** Dans le cas de rfrences multiples, consulter la section des applications du catalogue./ **Nota importante:** Se pueden usar intercambios competitivos para propósitos de almacenamiento solamente. Cuando se identifican intercambios múltiples, consulte la sección de aplicaciones de este catálogo.

COMPETITIVE & O.E.M. INTERCHANGE LIST
Lista de Intercambios contra Competidores y Equipo Original.
Liste d'interchange de produits complitifs & d'equipement original (OEM)

Monroe... cont'd

Monroe	Gabriel	Upgrade	Monroe	Gabriel	Upgrade	Monroe	Gabriel	Upgrade	Monroe	Gabriel	Upgrade
171670	G57060		172192	G57398		172309	G57193		172526	G57198	
171671L	G56924		172194	G57400		172310	G57192		172527	G57197	
171671R	G56925		172195	G57270		172311	G57156		172530	G57498	
171672	G56927		172199	G57070		172311	G57277		172532	G57498	
171674	G57559		172199	G57122		172332	G57466		172533	G57498	
171675	G57558		172200	G57069		172333	G57465		172536	G57138	
171678	G56931		172200	G57121		172343	G57334		172537	G57137	
171679	G56930		172203	G57099		172344	G57333		172541	G57565	
171680	G56933		172203	G57100		172345	G57460		172542	G57564	
171681	G56932		172205	G57077		172346	G57459		172546L	G57749	
171684	G57051		172206	G57076		172351	G57202		172546R	G57825	
171685	G57051		172207	G57079		172352	G57203		172562L	G57417	
171686	G56928		172208	G57078		172357	G57405		172562R	G57418	
171691L	G56991		172209	G57111		172363	G57664		172563	G57419	
171691R	G56992		172210	G57110		172364	G57663		172565	G57340	
171798	G56726		172213	G57153		172365	G57376		172566	G57339	
171920	G56935		172214	G57152		172366	G57375		172568	G57456	
171924	G57013		172219	G57219		172367	G57177		172569	G57455	
171925	G57014		172220	G57218		172368	G57176		172596	G57427	
171933	G57006		172221	G57343		172378	G57201		172597	G57330	
171945	G56994		172222	G57344		172379	G57200		172598	G57329	
171946	G56993		172231	G57142		172384	G57190		172599L	G57451	
171953	G56950		172236	G57372		172385	G57192		172599R	G57452	
171954	G56949		172237	G57373		172390	G57370		172600L	G57451	
171957	G56933		172240	G57031		172391	G57369		172600R	G57452	
171958	G56932		172241	G57030		172392	G57162		172604	G57494	
172103	G57613		172242	G57674		172393	G57161		172605	G57493	
172104	G57612		172243	G57673		172398L	G57414		172608	G57474	
172105	G57035		172248	G57071		172398R	G57415		172609	G57473	
172106	G57034		172248	G57072		172400L	G57428		172618	G57518	
172107	G57035		172257	G57082		172400R	G57429		172619	G57517	
172108	G57034		172258	G57081		172401	G57178		172620	G57694	
172113	G57274		172261	G57148		172408	G57071		172621	G57693	
172114	G57115		172267	G57164		172433	G57561		172624	G57456	
172115	G57114		172268	G57163		172434	G57560		172625	G57455	
172116	G57357		172271	G57185		172448	G57126		172626	G57378	
172117	G57358		172272	G57184		172449	G57127		172627	G57377	
172123L	G57054		172275	G57205		172450	G57128		172647	G57696	
172123R	G57055		172276	G57204		172451	G57129		172648	G57695	
172124	G57050		172278	G57142		172471L	G56924		172652L	G57683	
172125	G57049		172281	G57149		172471R	G56925		172652R	G57683	
172130L	G57112		172284	G57391		172485	G57484		172653	G57746	
172130R	G57113		172285	G57390		172486	G57483		172654	G57747	
172135	G57222		172286	G57391		172489	G57659		172663	G57378	
172136	G57223		172287	G57390		172490	G57658		172664	G57377	
172138	G57271		172292	G57147		172497L	G57416		172670	G57723	
172143	G57085		172295	G57131		172497R	G57682		172671	G57722	
172144	G57084		172296	G57130		172497R	G57691		172678	G57629	
172170	G57489		172297	G57276		172498	G57345		172679	G57628	
172171	G57490		172298	G57275		172499	G57346		172680	G57645	
172177	G57141		172299	G57472		172501	G57423		172681	G57644	
172179L	G57047		172300	G57471		172509	G57266		172686	G57340	
172179R	G57048		172305	G57394		172510	G57267		172687	G57339	
172185	G57050		172306	G57393		172518	G57109		172688	G57739	
172186	G57049		172307	G57191		172522	G57727		172689	G57738	
172191	G57399		172308	G57190		172523	G57726		172695	G57706	

Important Note: Competitive Interchanges are to be used for stocking purposes only. Where multiple crosses are identified, please reference the applications section of this catalog. / **Remarque importante:** Les interchanges concurrentiels ne s'utilisent qu'aux fins de stocks. Dans le cas de références multiples, consulter la section des applications du catalogue. / **Nota importante:** Dans le cas de références multiples, consulter la section des applications du catalogue. / **Nota importante:** Se pueden usar intercambios competitivos para propósitos de almacenamiento solamente. Cuando se identifican intercambios múltiples, consulte la sección de aplicaciones de este catálogo.

COMPETITIVE & O.E.M. INTERCHANGE LIST
Lista de Intercambios contra Competidores y Equipo Original.
Liste dinterchange de produits comptitifs & dquipement original (OEM)

Monroe... cont'd

Monroe	Gabriel	Upgrade	Monroe	Gabriel	Upgrade	Monroe	Gabriel	Upgrade	Monroe	Gabriel	Upgrade
172708	G57743		181102	G57646		181407	G57167		181686	G56928	
172709	G57742		181111	G57053		181417	G57059		181691L	G56991	
172712	G57690		181119L	G57123		181426	G57031		181691R	G56992	
172713	G57689		181119R	G57124		181427	G57030		181784	G57125	
172727	G57495		181124	G57095		181435	G57140		181920	G56935	
172728	G57496		181125	G57096		181436	G57139		181924	G57013	
172729	G57820		181126	G57447		181451	G57120		181925	G57014	
172730	G57819		181128L	G57206		181452	G57119		181945	G56994	
172741	G57193		181128R	G57206		181453	G57106		181946	G56993	
172742	G57192		181138	G57172		181454	G57105		181953	G56950	
172743	G57725		181140	G57132		181461	G57158		181954	G56949	
172744	G57724		181141	G57103		181462	G57157		181957	G56933	
172763	G57153		181266	G56995		181490	G57042		181958	G56932	
172764	G57152		181274	G56951		181491	G57041		182105	G57035	
172765	G57562		181281	G56938		181492	G57044		182106	G57034	
172766	G57563		181291L	G56996		181493	G57043		182113	G57274	
172780L	G57206		181291R	G56997		181494	G57649		182114	G57115	
172780R	G57206		181292	G56998		181495	G57648		182115	G57114	
172781	G57733		181293	G57057		181504	G57064		182123L	G57054	
172782	G57732		181293	G57058		181505	G57063		182123R	G57055	
172783	G57731		181299	G56943		181525	G57039		182130L	G57112	
172784	G57730		181312	G57036		181572L	G56956		182130R	G57113	
172901	G57546		181313	G57026		181572R	G56957		182135	G57223	
172902	G57545		181321	G57017		181577L	G57007		182136	G57222	
172903	G57060		181322	G57018		181577R	G57008		182138	G57271	
172905	G57368		181327	G57159		181578	G56973		182143	G57085	
172906	G57367		181340L	G57061		181579	G56974		182144	G57084	
172907	G57727		181340R	G57062		181580	G56975		182174	G56951	
172908	G57726		181341	G57022		181584	G57279		182177	G57141	
172919	G57748		181346	G57080		181585	G57278		182179L	G57047	
172942	G57500		181347L	G57220		181592	G56965		182179R	G57048	
172943	G57499		181347R	G57221		181593	G57045		182185	G57050	
172949	G57709		181348L	G57027		181594	G57046		182186	G57049	
172950	G57794		181348R	G57027		181597	G57012		182199	G57070	
172951	G57795		181351L	G57065		181598	G57011		182200	G57069	
172957L	G57597		181351R	G57066		181615	G56934		182203	G57099	
172957R	G57598		181352L	G57010		181615	G56937		182205	G57077	
172962	G57677		181352R	G57010		181616	G56936		182206	G57076	
172963	G57676		181353	G57282		181661	G57060		182207	G57079	
172964	G57659		181358	G57092		181662L	G56924		182208	G57078	
172965	G57658		181361	G57020		181662R	G56925		182209	G57111	
172966	G57659		181362	G57021		181665	G56929		182210	G57110	
172967	G57658		181369	G57212		181667	G56963		182215	G57533	
172974	G57606		181371L	G57133		181668	G56962		182216	G57534	
172975	G57605		181371R	G57134		181669	G56964		182219	G57219	
172980	G57376		181372	G57056		181670	G57060		182220	G57218	
172981	G57375		181373L	G57067		181671L	G56924		182221	G57343	
172985	G57853		181373R	G57068		181671R	G56925		182222	G57344	
172986	G57852		181380L	G57086		181672	G56927		182231	G57142	
172989	G57544		181380R	G57087		181674	G57559		182236	G57372	
172990	G57543		181398	G57019		181675	G57558		182237	G57373	
173032L	G57683		181400	G57269		181678	G56931		182240	G57031	
173032R	G57683		181401	G57268		181679	G56930		182241	G57030	
181100	G57146		181404	G57089		181680	G56933		182248	G57071	
181101L	G57425		181405	G57088		181681	G56932		182257	G57082	
181101R	G57424		181406	G57168		181685	G57051		182258	G57081	

Important Note: Competitive Interchanges are to be used for stocking purposes only. Where multiple crosses are identified, please reference the applications section of this catalog./ **Remarque importante:** Les interchanges concurrentiels ne s'utilisent qu'aux fins de stocks. **Dans le cas de rfrences multiples, consulter la section des applications du catalogue./ Nota importante:** Dans le cas de rfrences multiples, consulter la section des applications du catalogue./ **Nota importante:** Se pueden usar intercambios competitivos para propósitos de almacenamiento solamente. Cuando se identifican intercambios múltiples, consulte la sección de aplicaciones de este catálogo.

COMPETITIVE & O.E.M. INTERCHANGE LIST
Lista de Intercambios contra Competidores y Equipo Original.
Liste dinterchange de produits comptitifs & dquipement original (OEM)

Monroe... cont'd

Monroe	Gabriel	Upgrade	Monroe	Gabriel	Upgrade	Monroe	Gabriel	Upgrade	Monroe	Gabriel	Upgrade
182261	G57148		182597	G57329		272213	G57587		272621	G57691	
182267	G57164		182598	G57330		272214	G57586		272626	G57378	
182268	G57163		189105	G57023		272215	G57587		272627	G57377	
182271	G57185		250132	81582		272216	G57586		272638	G57812	
182272	G57184		250186	81482		272257	G57082		272679	G57704	
182275	G57205		250194	81750		272258	G57081		272684	G57673	
182276	G57204		250290	81878		272261	G57148		272685	G57674	
182281	G57149		250300	81750		272275	G57205		272686	G57340	
182284	G57391		250302	81912		272276	G57204		272687	G57339	
182285	G57390		250303	81892		272288	G57353		272712	G57690	
182286	G57391		250322	61614		272289	G57354		272713	G57689	
182287	G57390		250984	81934		272297	G57276		272730	G57819	
182292	G57147		271100	G57409		272298	G57275		272748	G57518	
182295	G57131		271102	G57646		272305	G57394		272749	G57517	
182296	G57130		271124	G57095		272306	G57393		272750	G57518	
182297	G57276		271125	G57096		272307	G57191		272751	G57517	
182298	G57275		271128L	G57206		272308	G57190		272889	G57583	
182305	G57394		271128R	G57206		272309	G57193		272919	G57748	
182306	G57393		271130	G57466		272345	G57460		272957L	G57792	
182307	G57191		271131	G57465		272346	G57459		272957R	G57793	
182308	G57190		271137L	G57454		272367	G57463		272974	G57120	
182309	G57193		271137R	G57453		272368	G57464		272975	G57119	
182310	G57192		271139	G57173		272384	G57192		281100	G57409	
182311	G57156		271311	G57026		272385	G57192		281130	G57466	
182321	G57324		271326L	G57090		272401	G57607		281131	G57465	
182351	G57203		271326R	G57091		272408	G57071		281311	G57026	
182352	G57202		271341	G57022		272412	G57635		281426	G57031	
182357	G57405		271346	G57080		272413	G57634		281427	G57030	
182358	G57404		271353	G57282		272471L	G56924		281616	G56936	
182363	G57664		271358	G57092		272471R	G56925		281662L	G56924	
182364	G57663		271371L	G57133		272483	G57482		281662R	G56925	
182365	G57376		271371R	G57134		272484	G57481		281670	G57060	
182366	G57375		271426	G57031		272489	G57484		281678	G56931	
182367	G57464		271427	G57030		272490	G57483		281679	G56930	
182368	G57463		271435	G57140		272491	G57331		281680	G56933	
182378	G57201		271436	G57139		272492	G57332		281681	G56932	
182379	G57200		271441	G57145		272501	G57423		281951	G56948	
182392	G57162		271442	G57144		272526	G57198		281952	G56948	
182393	G57161		271453	G57349		272527	G57197		282257	G57082	
182401	G57178		271454	G57350		272532	G57498		282258	G57081	
182471L	G56924		271525	G57039		272533	G57497		282261	G57148	
182471R	G56925		271575	G57397		272534	G57496		282275	G57205	
182497L	G57416		271577L	G57007		272535	G57495		282276	G57204	
182497R	G57691		271577R	G57008		272562L	G57417		282299	G57472	
182509	G57266		271616	G56936		272562R	G57418		282300	G57471	
182510	G57267		271662L	G56924		272565	G57340		282307	G57191	
182518	G57109		271662R	G56925		272566	G57339		282308	G57190	
182526	G57197		271670	G57060		272568	G57456		282491	G57480	
182527	G57198		271678	G56931		272569	G57455		282492	G57479	
182530	G57498		271679	G56930		272596	G57427		3100	G63907	
182536	G57138		271680	G56933		272597	G57330		31000	61500	
182537	G57137		271681	G56932		272598	G57329		31000	81147	
182562L	G57207		271951	G56948		272599L	G57451		31000	82156	
182562R	G57208		271952	G56948		272599R	G57452		31029	81675	
182563	G57419		272162	G57635		272604	G57494		31069	81270	
182596	G57427		272163	G57634		272605	G57493		31069	82076	

Important Note: Competitive Interchanges are to be used for stocking purposes only. Where multiple crosses are identified, please reference the applications section of this catalog. / **Remarque importante:** Les interchanges concurrentiels ne s'utilisent qu'aux fins de stocks. Dans le cas de références multiples, consulter la section des applications du catalogue. / **Nota importante:** Dans le cas de références multiples, consulter la section des applications du catalogue. / **Nota importante:** Se pueden usar intercambios competitivos para propósitos de almacenamiento solamente. Cuando se identifican intercambios múltiples, consulte la sección de aplicaciones de este catálogo.

COMPETITIVE & O.E.M. INTERCHANGE LIST
Lista de Intercambios contra Competidores y Equipo Original.
Liste d'interchange de produits compititifs & d'equipement original (OEM)

Monroe... cont'd

Monroe	Gabriel	Upgrade	Monroe	Gabriel	Upgrade	Monroe	Gabriel	Upgrade	Monroe	Gabriel	Upgrade
31089	82001		32206	61501		32250	81836		32294	61700	
31094	61506		32206	81478		32251	61584		32295	61699	
31094	81318		32206	81507		32251	81837		32296	61623	
31094	82012		32207	61550		32252	61535		32296	61626	
31125	82125		32207	81676		32252	81548		32296	81893	
31131	61632		32207	82007		32253	61590		32300	61504	
31131	81469		32211	81583		32253	61624		32300	81750	
31131	81825		32212	61539		32253	81890		32301	82003	
31163	81416		32214	61512		32254	61542		32302	61611	
31163	81440		32214	81559		32254	81726		32302	81912	
31538	82005		32215	81560		32258	61504		32303	61638	
31542	82001		32216	81491		32258	61556		32303	81892	
32022	82090		32217	61593		32258	81750		32303R	81892	
32066	61529		32217	81507		32259	61626		32304	61613	
32066	61555		32217	81553		32259	81744		32304	81914	
32066	81446		32217	81872		32260	61595		32305	61612	
32066	81541		32219	81691		32260	81833		32305	81913	
32066	81713		32220	61541		32262	81270		32306	61616	
32066	82099		32220	81583		32263	81726		32306	81929	
32067	82601		32224	61544		32264	58638		32314	81318	
32073	82131		32224	81668		32264	61565		32315	G63720	
32075	61521		32225	61543		32265	61687		32316	61560	
32075	81394		32225	81667		32266	61565		32316	81904	
32080	61518		32226	61520		32266R	61543		32317	69675	
32080	81242		32226	77414		32267	61591		32317	81713	
32103	82130		32226	81490		32267	81744		32318	61512	
32112	81095		32227	61520		32268	61646		32318	81559	
32113	61501		32227	81490		32268	81828		32319	61658	
32113	61508		32228	61554		32269	61575		32319	81923	
32113	81478		32228	81710		32269	81891		32321	61658	
32118	82128		32231	61547		32270	61582		32321	81923	
32126	81340		32231	81082		32271	81872		32322	61614	
32126	82039		32231	81710		32272	61608		32323	61614	
32127	61523		32235	61561		32273	G63782		32324	61638	
32127	81096		32235	81744		32274	G63781		32324	81892	
32127	81834		32237	61533		32275	61625		32325	61612	
32128	81091		32237	61627		32277	61599		32325	81913	
32132	61529		32237	81730		32277	81928		32326	61641	
32132	81494		32237	81917		32278	61600		32326	81920	
32132	81582		32238	61573		32278	81873		32327	61600	
32132	81750		32238	61629		32279	61634		32327	81873	
32134	81153		32238	81540		32279	81919		32327R	81873	
32143	81495		32238	81905		32280	61520		32328	58803	
32164	61519		32238	81918		32280	61613		32328	61643	
32164	81484		32239	61530		32280	81490		32328	81922	
32186	61528		32239	81510		32281	82147		32329	81921	
32186	81482		32243	61520		32283	G63510		32330	61626	
32194	61531		32243	81490		32284	G63387		32330	81916	
32194	81516		32245	61552		32285	61521		32332	61614	
32196	61535		32245	81870		32287	G63432		32333	61659	
32196	61615		32247	61510		32288	61614		32333	81924	
32196	81548		32247	81871		32288	81821		32334	G63726	
32196	81936		32249	61593		32290	61605		32335	81910	
32197	61536		32249	81872		32290	81878		32336	61593	
32197	81549		32250	61601		32292	61606		32336	81872	
32202	69755		32250	61679		32293	61500		32337	81911	

Important Note: Competitive Interchanges are to be used for stocking purposes only. Where multiple crosses are identified, please reference the applications section of this catalog. / **Remarque importante:** Les interchanges concurrentiels ne s'utilisent qu'aux fins de stocks. Dans le cas de références multiples, consulter la section des applications du catalogue. / **Nota importante:** Dans le cas de références multiples, consulter la section des applications du catalogue. / **Nota importante:** Se pueden usar intercambios competitivos para propósitos de almacenamiento solamente. Cuando se identifican intercambios múltiples, consulte la sección de aplicaciones de este catálogo.

COMPETITIVE & O.E.M. INTERCHANGE LIST
Lista de Intercambios contra Competidores y Equipo Original.
Liste d'interchange de produits comptitifs & d'equipement original (OEM)

Monroe... cont'd

Monroe	Gabriel	Upgrade	Monroe	Gabriel	Upgrade	Monroe	Gabriel	Upgrade	Monroe	Gabriel	Upgrade
32338	61664		32381	61546		33101	82010		34534	G64009	
32338	81869		32383	61509		33121	81880		34612	83017	
32339	61676		32383	81541		33122	81481		34617	83019	
32339	81926		32385	81091		33123	69675		34655	58714	
32340	61663		32386	81510		33123	81446		34655	61611	
32340	81920		32388	G64027		33127	81446		34655	G63714	
32341	61642		32389	G64028		33127	81713		34656	61638	
32341	81921		32390	81933		33128	81495		34656	G63778	
32344	61675		32390R	81933		33136	81495		34656MM	61638	
32344	81930		32391	61691		33137	81794		34657	61613	
32345	61642		32391	61692		33178	G63884		34657	G63716	
32345	61675		32391	81931		33179	G63879		34657MM	61613	
32345	81921		32392	81932		33180	61662		34658	61612	
32345	81930		32393	G63607		33181	61506		34671	61614	
32346	61623		32394	G63809		33182	61662		34672	61614	
32346	81893		32395	G63837		33183	69587		34673	61638	
32347	58803		32399	G55821		33184	61717		34673	81892	
32347	61643		32400	77949		33185	G51807		34674	81913	
32347	81922		32401	61710		33187	69900		34675	61641	
32348	58930		32401	61716		33188	69473		34675MM	61641	
32348	61675		32401	81931		33189	69590		34676	58662	
32348	81930		32402	61712		33190	G64042		34676	61600	
32350	61663		32402	61714		33191	G63844		34676MM	61600	
32350	81925		32403	81934		33192	61704		34677	58803	
32355	14039		32404	81935		33193	G64040		34677	61643	
32356	G63614		32405	61720		33194	70010		34678	61642	
32356	G63622		32406	61734		33195	69589		34678	81873	
32357	58808		32407	61715		33196	G51874		34684	58807	
32357	61654		32545	82032		33197	69575		34684	G63622	
32358	58809		32592	82032		33198	69592		34685	58808	
32358	61655		33033	61525		33274	61704		34685	61654	
32359	58810		33033	81039		33274	69909		34685	77808	
32359	61656		33049	61592		33275	81937		34685	G63808	
32360	81082		33049	81340		34501	58803		34686	58809	
32361	G63394		33049	81495		34501	61643		34686	61655	
32362	61685		33049	81937		34504	58817		34686	G63809	
32362	81668		33049	82034		34504	61663		34687	58810	
32365	61642		33049	82066		34514	G63958		34687	61656	
32365	81921		33049	82155		34515	61691		34687	61682	
32366	61635		33049	G63610		34515	61692		34687	G63810	
32366	81919		33050	82602		34516	81932		34689	61641	
32369	G63616		33053	82069		34517	G63837		34689	61663	
32370	G63692		33053	82126		34518	G63809		34690	61642	
32371	61523		33059	81076		34519	G63837		34690	81921	
32371	81096		33059	82104		34520	G63958		34692	58930	
32372	61547		33074	61516		34521	61710		34692	61675	
32372	81082		33074	81113		34521	61716		34693	61675	
32372	81507		33076	58357		34522	61712		34694	58930	
32373	61542		33076	61517		34522	61714		34694	61642	
32373	81726		33082	81492		34523	77967		34694	61675	
32375	81342		33082	81514		34523	G63969		34694	81930	
32376	81834		33084	61524		34524	77968		34721	83103	
32377	82007		33084	81164		34524	77969		34722	83400	
32379	G63411		33086	61522		34525	61680		34729	61520	
32380	G63675		33086	81496		34526	61682		34729	61546	
32381	61520		33090	82010		34530	61685		34729	G63414	

Important Note: Competitive Interchanges are to be used for stocking purposes only. Where multiple crosses are identified, please reference the applications section of this catalog. / **Remarque importante:** Les interchanges concurrentiels ne s'utilisent qu'aux fins de stocks. Dans le cas de références multiples, consulter la section des applications du catalogue. / **Nota importante:** Dans le cas de références multiples, consulter la section des applications du catalogue. / **Nota importante:** Se pueden usar intercambios competitivos para propósitos de almacenamiento solamente. Cuando se identifican intercambios múltiples, consulte la sección de aplicaciones de este catálogo.

COMPETITIVE & O.E.M. INTERCHANGE LIST
Lista de Intercambios contra Competidores y Equipo Original.
Liste dinterchange de produits comptitifs & dquipement original (OEM)

Monroe... cont'd

Monroe	Gabriel	Upgrade	Monroe	Gabriel	Upgrade	Monroe	Gabriel	Upgrade	Monroe	Gabriel	Upgrade
34729MM	61520		34796	58929		34929	58403		37035	G63607	
34730	61520		34796	61591		34929	G63403		37036	G63410	
34730	G63386		34796	G63929		34930	61530		37037	G63409	
34730MM	61520		34797	61547		34934	61528		37038	G63461	
34731	61547		34798	58609		34944	61516		37039	G63461	
34731	61554		34798	58901		34945	58421		37040	G63347	
34732	61614		34798	61542		34945	61504		37041	77662	
34732	G63455		34798	77609		34945	81750		37044	G63488	
34736	61525		34799	61542		34953	61509		37045	G63183	
34740	58423		34800	G64043		34953	81541		37047	G63813	
34740	61531		34802	83216		34953MM	61509		37047	G63902	
34740	81516		34802MM	83216		34958	61519		37048	G63492	
34741	61544		34803	61500		34959	G63432		37049	G63355	
34750	58359		34803	G63306		34960	G63366		37050	G63489	
34750	61523		34803MM	61500		34963	61547		37051	G63490	
34751	61590		34804	61623		34964	61530		37053	G63386	
34751	G63607		34804	77678		34968	61501		37055	G63455	
34756	61543		34804	81893		34968	61508		37062	G63818	
34759	61595		34807	61638		34972	G63610		37063	61555	
34759	G63624		34810	G64148		34972MM	G63610		37063	77375	
34760	58622		34811	G64121		34975	G63511		37063	81713	
34760	61591		34812	G64121		34983	58489		37064	77454	
34760	G63622		34814	G63673		34983	61544		37065	G63426	
34761	58623		34817	61525		34985	58488		37066	77915	
34761	61646		34817	G63355		34985	61543		37068	G63905	
34761	G63623		34821	61547		37011	G63414		37070	G63799	
34763	58638		34822	G63306		37013	77525		37072	61529	
34763	61565		34824	61524		37013	G63525		37073	G63419	
34763	61687		34828	G63510		37014	77524		37073	G63907	
34763MM	61565		34831	61523		37014	G63524		37073ST	G63907	
34766	61664		34839	58357		37015	G63614		37074	G63620	
34768	83209	89414	34839	61517		37015ST	G63614		37077	77909	
34768	89414		34853	61632		37016	G63635		37077ST	G63909	
34769	61676		34895	83207	89407	37018	G63614		37078	77907	
34770	61713		34895	89407		37019	58421		37080	G63624	
34771	81342		34900	61521		37019	61504		37081	61535	
34774	61512		34900	G63386		37019	81750		37081ST	G63424	
34776	61599		34901	G63387		37021	58422		37082	G63683	
34777	58662		34904	G63299		37022	G63495		37083	61535	
34777	61600		34905	61500		37022	G63611		37083	81548	
34777MM	61600		34905	G63405		37022ST	G63611		37085	G63896	
34778	61634		34905MM	61500		37024	G63610		37086	77638	
34780	81560		34906	61521		37026	G63424		37087	G63638	
34781	61642		34907	G63511		37026	G63721		37089	G63350	
34782	61635		34910	61516		37027	61536		37090	G63357	
34782	77674		34910	61522		37027	77425		37091	G63413	
34785	61512		34910	81496		37028	G63904		37093	G63359	
34786	61658		34911	61518		37029	G63419		37094	G63353	
34787	G63615		34911	G63350		37029	G63492		37095	G63410	
34788	G63616		34912	G63625		37029	G63928		37095	G63414	
34789	61658		34919	G63411		37030	77479		37096	G63359	
34790	61601		34920	58412		37031	G63404		37097	G63950	
34791	G63692		34920	61642		37032	77494		37098	G63299	
34793	61520		34927	61554		37033	G63548		37099	58423	
34793MM	61520		34927	G63409		37034	G63414		37100	G63904	
34794	61523		34928	61546		37035	77607		37102	G63661	

Important Note: Competitive Interchanges are to be used for stocking purposes only. Where multiple crosses are identified, please reference the applications section of this catalog. / **Remarque importante:** Les interchanges concurrentiels ne s'utilisent qu'aux fins de stocks. Dans le cas de rfrences multiples, consulter la section des applications du catalogue. / **Nota importante:** Dans le cas de rfrences multiples, consulter la section des applications du catalogue. / **Nota importante:** Se pueden usar intercambios competitivos para propósitos de almacenamiento solamente. Cuando se identifican intercambios múltiples, consulte la sección de aplicaciones de este catálogo.

COMPETITIVE & O.E.M. INTERCHANGE LIST
Lista de Intercambios contra Competidores y Equipo Original.
Liste d'interchange de produits complitifs & d'equipement original (OEM)

Monroe... cont'd

Monroe	Gabriel	Upgrade	Monroe	Gabriel	Upgrade	Monroe	Gabriel	Upgrade	Monroe	Gabriel	Upgrade
37103	G63413		37150	58662		37225	G64027		372889	G57582	
37103	G63662		37150	61600		37226	G64028		37289	G64026	
37104	G63673		37150	77662		372297	G57276		37289	G64151	
37104	G63674		37150	81873		37231	G63720		37290	G64042	
37105	G63662		37151	G63803		37232	G63506		37298	G64038	
37108	G63707		37151ST	G63803		37233	G63506		37301	G511007	
37108ST	G63707		37152	G63675		37234	G63694		37302	G64037	
37109	G63708		37152ST	G63675		372367	G57463		37307	G64071	
37109ST	G63708		37153	77772		372368	G57464		37308	G64052	
37110	G63676		37153	G63772		37237	69907		37309	G64080	
371102	G57647		37154	G63717		37238	G63815		37310	G511004	
37111	G63937		37155	G63676		37239	77815		37313	G64056	
37112	G63689		37156	G63776		37240	G64087		37315	G64040	
371124	G57095		37156	G63869		37241	G63842		37316	70010	
371128L	G57206		37157	77726		37242	61717		37317	G51884	
371128R	G57206		37159	G63611		37243	G63610		37318	G64047	
37113	61700		37160	G63710		37244	G63864		37320	61500	
371130	G57466		37161	G63847		37245	61662		37320	81147	
371131	G57465		37162	G63829		37246	61704		37322	70203	
371139	G57173		37163	G63783		37247	G63615		37323	70078	
37114	61699		37163	G63817		372471L	G56924		37326	G51966	
37116	G63622		37164	G63675		372471R	G56925		37327	G64111	
37117	G63623		37166	G63866		37248	G63694		37328	G64050	
37118	G63414		371662L	G56924		372489	G57659		37329	G51996	
37120	G63511		371662R	G56925		372490	G57658		37334	G64146	
37121	G63490		37171	61662		37251	G63878		37336	G511122	
37122	G63678		37172	61506		37252	G63883		37338	G64056	
37122ST	G63678		37177	77678		372526	G57550		37339	G64104	
37123	G63690		37178	58803		372527	G57549		37341	G64216	
37125	G63489		37178	61643		37253	G63875		37342	G63828	
37128	58622		37178	81922		372565	G57340		37352	G511122	
37128	58929		37181	58817		372566	G57339		37358	G511038	
37128	G63929		37181	61663		372663	G57378		37361	G64163	
37129	G63421		37181	81925		372664	G57377		37361	G64186	
37130	G63609		37183	G63832		37270	G63885		37363	G511043	
37130	G63818		37184	G63828		37270	G64029		37367	G64063	
37131	G63714		37187	82035		37270	G64030		37370	G64050	
37132	G63778		37191	G63506		37272	70000		37377	70210	
37133	77716		37191	G63615		372729	G57745		37379	70213	
37133	G63716		37197	G63506		37273	G64031		37803	G63306	
37134	G63715		37198	G63694		372730	G57744		39002	69996	
37135	G63722		37199	61651		37274	G64033		39004	69677	
371358	G57092		37199	69813		37275	69594		39006	69766	
371358	G57118		37202	61703		37276	69595		39020	69952	
37137	G63915		37203	G63844		37279	G63889		39021	69966	
37138	G63403		37204	G63845		37280	G64006		39027	70024	
37140	G63403		37206	G63958		37281	G64032		39040	70040	
37144	61614		37207	58412		37282	G51798		39042	70065	
37145	G63717		37207	61692		37283	G51803		39043	70064	
371453	G57349		37208	77947		37284	G51804		39047	70033	
371454	G57350		37217	69900		37284	G51992		39050	70033	
37146	G55821		37218	69909		37285	61711		39051	G64046	
37147	G63778		37219	G64049		37286	61696		39052	61777	
37148	G63715		37220	G63905		37287	61697		39102	69946	
37149	G63783		372215	G57659		37288	70010		39104	G51891	
37149ST	G63783		372216	G57658		372888	G57583		39105	61690	

Important Note: Competitive Interchanges are to be used for stocking purposes only. Where multiple crosses are identified, please reference the applications section of this catalog. / **Remarque importante:** Les interchanges concurrentiels ne s'utilisent qu'aux fins de stocks. Dans le cas de références multiples, consulter la section des applications du catalogue. / **Nota importante:** En el caso de referencias múltiples, consultar la sección de aplicaciones del catálogo. / **Nota importante:** Se pueden usar intercambios competitivos para propósitos de almacenamiento solamente. Cuando se identifican intercambios múltiples, consulte la sección de aplicaciones de este catálogo.

COMPETITIVE & O.E.M. INTERCHANGE LIST
Lista de Intercambios contra Competidores y Equipo Original.
Liste d'interchange de produits compititifs & d'equipement original (OEM)

Monroe... cont'd

Monroe	Gabriel	Upgrade	Monroe	Gabriel	Upgrade	Monroe	Gabriel	Upgrade	Monroe	Gabriel	Upgrade
39106	G51891		550051	43140		557011	83160		5667	G51965	
39107	70034		550061	58412		557012	83204		5668	69587	
39111	G511001		5504	G51807		557012	85029		5671	70098	
39112	G51949		551001	83125		557013	83127		5671	70102	
39112	G64101		551002	83122	89406	557014	83126	89430	5672	70095	
39113	G51746		551002	89406		557014	89430		5672	70208	
39114	70031		5511	70052		557015	83209	89414	5673	G51990	
39130	70038		5518	G51993		557015	89414		5681	70045	
39131	G51921		552001	G63959		557017	85029		5682	G511037	
39132	G51920		5521	69590		557018	83127		5683	G51983	
39133	G51922		5525	G511044		557020	83123	89405	5685	70053	
39136	G51901		5528	G51799		557020	89405		5687	70053	
39138	G51921		5529	G51799		557021	85051		5697	G51983	
39139	G51920		5530	G511078		557022	85051		5698	G511092	
400295	G56887		553002	G56778		557023	83144		5699	G511030	
400296	G56886		553003	G57802		557026	83127		571128L	G57206	
400426	G56672		5532	G511044		557027	83144		571128R	G57206	
400427	G56671		5540	70207		557028	85010		571377L	G57083	
40046	49254		555004	G63299		557031	85010		571377R	G57083	
400525	G56606		555005	G63689		557033	85900		572367	G57464	
400964	G55697		555010	77623		557038	85125		572368	G57463	
471128L	G57206		555011	83119		557039	85959		572526	G57550	
471128R	G57206		555012	G63183		5600	G51802		572527	G57549	
471311	G57075		555019	85069	89455	5601	70028		572597	G57330	
471358	G57092		555019	89455		5602	G51904		572598	G57329	
471377	G57083		555026	83124	89407	5603	G51871		572889	G57582	
471453	G57349		555026	89407		5605	70060		5751	82026	
471454	G57350		555027	83124	89407	5607	70003		5753	82039	
471662L	G56924		555027	89407		5609	G51807		5754	69600	
471662R	G56925		555028	83207	89407	5611	G51799		5754	82138	
472367	G57463		555028	89407		5612	70086		5756	82070	
472368	G57464		555029	83144		5613	69945		5757	82060	
472401	G57607		555031	77614		5614	70013		5759	82087	
472471L	G56924		555031	G63622		5615	70049		5760	82609	
472471R	G56925		555032	G63623		5616	70045		5762	82615	
472526	G57550		555033	G63386		5617	70056		5765	82118	
472527	G57549		555034	G63387		5618	70039		5766	82051	
472534	G57496		555035	G63357		5621	70036		5777	69585	
472535	G57495		555036	77403		5622	70037		5778	69590	
472597	G57330		555038	77403		5624	70055		5779	69587	
472598	G57329		555041	G63866		5626	70041		5780	69589	
472653	G57746		555043	83400		5629	70086		5783	69593	
472654	G57747		555045	G63394		5630	70052		5784	69591	
472663	G57378		557001	83209	89414	5637	70089		5795	G51812	
472664	G57377		557001	85013	89414	5639	70027		5796	69464	
481311	G57422		557001	89414		5645	G511002		5797	70086	
482401	G57607		557002	83125		5645	G511134		5799	69585	
482597	G57330		557004	G63866		5645	G511135		5799	70001	
482598	G57329		557005	83136		5646	70068		5801	69675	
550010	G63375		557006	83136		5646	70209		5802	69604	
550011	69606		557007	83122	89406	5647	70059		5802	69724	
550016	G63424		557007	85010		5647	70204		5803	81340	
550017	G63425		557007	89406		5648	70096		5803	82066	
550018	69574		557008	85029		5659	70089		5804	69600	
550018	69575		557009	85007		5662	G51982		5809	82069	
550019	G63918		557010	83144		5663	G51971		5809	82126	

Important Note: Competitive Interchanges are to be used for stocking purposes only. Where multiple crosses are identified, please reference the applications section of this catalog./ **Remarque importante:** Les interchanges concurrentiels ne s'utilisent qu'aux fins de stocks. Dans le cas de rfrences multiples, consulter la section des applications du catalogue./ **Nota importante:** Dans le cas de rfrences multiples, consulter la section des applications du catalogue./ **Nota importante:** Se pueden usar intercambios competitivos para propósitos de almacenamiento solamente. Cuando se identifican intercambios múltiples, consulte la sección de aplicaciones de este catálogo.

COMPETITIVE & O.E.M. INTERCHANGE LIST
Lista de Intercambios contra Competidores y Equipo Original.
Liste dinterchange de produits comptitifs & dquipement original (OEM)

Monroe... cont'd

Monroe	Gabriel	Upgrade	Monroe	Gabriel	Upgrade	Monroe	Gabriel	Upgrade	Monroe	Gabriel	Upgrade
5811	82011		5960	69675		65108	85030	89440	65159	89459	
5815	82601		5961	69606		65108	89440		65159M0R	85070	89459
5818	69606		5962	69632		65109	85058	89431	65159MM	85070	89459
5818	82155		5965	69845		65109	89431		65159MM	89459	
5819	82004		5966	69724		65110	85005	89430	65160	85080	
5820	69724		5967	69606		65110	89430		65161	83136	
5820	81514		5968	69898		65110M0R	85005	89430	65162	85959	
5820	82602		5969	61555		65110MM	85005	89430	65162M0R	85959	
5823	81491		5969	69675		65110MM	89430		65163	85954	
58241	34036		5969	81713		65111	85006		65164	85649	
58253	34058		5971	69962		65112	89402		65166	85090	
5826	81270		5974	69863		65113	85012	89413	65167	58944	
58263	34073		5975	69901		65113	89413		65167	G63969	
5827	G511142		5980	69903		65113M0R	85012	89413	65168	77968	
58270	34051		5981	69725		65114	85036	89405	65171	85964	
58273	34073		5981	69863		65114	89405		65172	89413	
58275	34057		5982	69903		65115	85027		65175	85084	89460
5831	69624		5984	69945		65116	85329		65175	89460	
5840	69600		5986	69465		65116MM	85329		65175M0R	85084	89460
58411	43060		5987	69450		65118	85001	89410	65176	85084	89460
5845	69755		5988	69863		65118	89410		65176	89460	
5847	69755		5989	69473		65119	85029		65177	85012	89413
5850	69622		5991	70020		65120	85010		65177	89413	
58510	43140		5993	69575		65122	85063		65179	85995	
58518	43099		5994	69575		65123	85054		65180	85639	
58523	43162		5996	69420		65124	85053	89442	65181	85650	
58567	43048		5998	69863		65124	89442		65183	85181	
58568	43140		6025	83122	89406	65128	85031		65184	85180	
58574	43049		6025	89406		65130	85061	89450	65185	85180	
58574	43060		6026	83204		65133	85935		65186	85637	
58578	43111		63618	143058		65139	85918	89449	65400	85033	89427
58592	43058		63619	143057		65139	89449		65400	89427	
58595	43085		63619	143061		65140	85918	89449	65400M0R	85033	89427
58600	43163		63620	143058		65140	89449		65400MM	85033	89427
58601	43167		63621	143059		65141	85014		65400MM	89427	
58606	43180		63628	143064		65142	83131		65401	85013	89414
58610	43181		63630	143058		65143	83163		65401	89414	
58612	43180		63631	143057		65144	85928		65402	85311	89424
58615	43181		63973	143057		65144M0R	85928		65402	89424	
58617	43171		65101	85062	89408	65145	85671		65402M0R	85311	89424
58618	43167		65101	89408		65145	85929		65404	85310	89423
58636	43181		65101M0R	85062	89408	65146	85648		65404	89423	
58637	43181		65102	85001	89410	65147	85924	89457	65404M0R	85310	89423
58654	43181		65102	89410		65147	89457		65405	85023	89415
5867	69676		65102M0R	85001	89410	65147M0R	85924	89457	65405	89415	
5867	75676		65103	85320	89429	65148	85918	89449	65405M0R	85023	89415
5868	69787		65103	89429		65148	89449		65406	85024	
5892	69714		65103M0R	85320	89429	65148M0R	85918	89449	65407	85736	
5892	69811		65103MM	85320	89429	65153	85921		65408	85319	89428
5893	69715		65103MM	89429		65155	83175		65408	89428	
5906	69625		65105	85026		65156	85005	89430	65409	85003	89411
5928	69757		65106	83124	89407	65156	89430		65409	89411	
5939	69795		65106	89407		65157	85954		65409M0R	85003	89411
5947	69725		65107	85316	89426	65158	85954		65410	85300	89419
5955	69724		65107	89426		65158M0R	85954		65410	89419	
5959	69632		65107M0R	85316	89426	65159	85070	89459	65411	85036	89405

Important Note: Competitive Interchanges are to be used for stocking purposes only. Where multiple crosses are identified, please reference the applications section of this catalog. / **Remarque importante:** Les interchanges concurrentiels ne s'utilisent qu'aux fins de stocks. Dans le cas de rferences multiples, consulter la section des applications du catalogue. / **Nota importante:** Dans le cas de rferences multiples, consulter la section des applications du catalogue. / **Nota importante:** Se pueden usar intercambios competitivos para propósitos de almacenamiento solamente. Cuando se identifican intercambios múltiples, consulte la sección de aplicaciones de este catálogo.

COMPETITIVE & O.E.M. INTERCHANGE LIST
Lista de Intercambios contra Competidores y Equipo Original.
Liste dinterchange de produits compititifs & dquipement original (OEM)

Monroe... cont'd

Monroe	Gabriel	Upgrade	Monroe	Gabriel	Upgrade	Monroe	Gabriel	Upgrade	Monroe	Gabriel	Upgrade
65411	89405		65461	85059		65501	89436		6603	83103	
65412	83122	89406	65463	85040		65502	85938		6604	83101	
65412	89406		65464	85716		65503	85919		6605	83613	
65413	83136		65465	85939		65504	85072		6607	85052	
65415	85046	89434	65466	85047	89435	65504MOR	85072		6608	83128	89436
65415	89434		65466	89435		65505	83147		6608	89436	
65416	85000	89436	65467	85054		65505M0R	83147		6609	83635	
65416	89436		65468	85069	89455	65506	83168		6610	85051	
65416MOR	85000	89436	65468	89455		65507	83143		66101	83042	
65416MM	85000	89436	65468MOR	85069	89455	65508	83142		66101MOR	83042	
65416MM	89436		65469	85708		65509	85079		66102	83059	
65417	85322		65470	85708		65510	85052		66104	83021	
65418	85906	89407	65471	85302	89420	65511	85939		66105	83044	
65418	89407		65471	89420		65511MOR	85939		66106	83016	
65419	83389	89436	65473	85329		65512	85938		66107	83048	
65419	85000	89436	65474	85712		65512MOR	85938		66108	83028	
65419	89436		65475	85065		65513	85338		66109	83048	
65419MOR	85000	89436	65476	85736		65514	89405		66111	83016	
65420	85013	89414	65477	85702		65515	83125		66112	83017	
65420	89414		65478	85058	89431	65516	85013	89414	66113	83050	
65420MOR	85013	89414	65478	89431		65516	89414		66114	83045	
65421	85916	89430	65479	83122	89406	65519	85060		66115	83045	
65421	89430		65479	89406		65521	85014		66116	83018	
65426	85054		65480	83111		65522	85082		66117	83019	
65428	85321		65481	85036	89405	65523	85937		66118	83001	
65429	85030	89440	65481	89405		65523MOR	85937		66120	85006	
65429	89440		65482	85006		65524	85936	89456	66121	83047	
65430	85712		65482MOR	85006		65524	89456		66122	83038	
65431	85909		65483	85978		65524MOR	85936	89456	66122MOR	83038	
65432	85910		65484	85976		65525	87015		66123	83004	
65433	85910		65485	85972		65526	85956		66124	83040	
65434	85012	89413	65485MM	85972		65527	85955		66125	83035	
65434	89413		65486	85066	89448	65528	85069	89455	66125MOR	83035	
65434MOR	85012	89413	65486	89448		65528	89455		66126	83051	
65435	85901		65486MOR	85066	89448	65528MOR	85069	89455	6613	83123	89405
65436	85900		65487	85927		65530	85932	89453	6613	89405	
65436MOR	85900		65488	85656		65530	89453		66131	83062	
65439	85716		65489	85331		65530MOR	85932	89453	66132	83001	
65440	85711		65490	85724	89443	65531	85334		66138	619501	
65441	85704		65490	89443		65532	85967		6614	83125	
65442	85700		65490MOR	85724	89443	65534	85343		66142	83039	
65444	85311	89424	65492	85931	89458	65535	85954		66143	83007	
65444	89424		65492	89458		65536	85965		66145	83008	
65444MOR	85311	89424	65492MOR	85931	89458	65537	85962		66147	83009	
65448	85700		65493	85934		65539	85961		66147MM	83009	
65449	85702		65494	85061	89450	65540	85959		66149	83022	
65451	85029		65494MOR	85061	89450	65541	85119		6615	83120	
65452	85733		65495	85067	89451	65541MOR	85119		66150	83003	
65453	85043		65495	89451		65542	85102		66152	83012	
65454	85030	89440	65495MOR	85067	89451	65543	85724	89443	66157	83015	
65454	89440		65497	85933	89454	65543	89443		66159	83031	
65455	85716		65497	89454		65547	85650		66159MOR	83031	
65456	85376		65498	85964		65548	85106		66160	83054	
65457	85909		65499	85963		65549	85642		66161	83054	
65458	85908		65500	85738		65552	85188		66162	83025	
65459	85043		65501	85323	89436	65554	85670		66169	83027	

Important Note: Competitive Interchanges are to be used for stocking purposes only. Where multiple crosses are identified, please reference the applications section of this catalog./ **Remarque importante:** Les interchanges concurrentiels ne s'utilisent qu'aux fins de stocks. Dans le cas de rfrences multiples, consulter la section des applications du catalogue./ **Nota importante:** En el caso de referencias multiples, consultar la seccion de aplicaciones del catalogo./ **Nota importante:** Se pueden usar intercambios competitivos para propósitos de almacenamiento solamente. Cuando se identifican intercambios mltiples, consulte la seccion de aplicaciones de este catalogo.

COMPETITIVE & O.E.M. INTERCHANGE LIST
Lista de Intercambios contra Competidores y Equipo Original.
Liste d'interchange de produits compititifs & d'equipement original (OEM)

Monroe... cont'd

Monroe	Gabriel	Upgrade	Monroe	Gabriel	Upgrade	Monroe	Gabriel	Upgrade	Monroe	Gabriel	Upgrade
66178	83023		66436	89451		66631	83140		66713	83105	
66179	83013		66438	83363		66632	83006		66714	83216	
66181	83025		66439	G64177		66633	83127		66714MM	83216	
66182	83005		66442	83150		66634	83203	89436	66715	85026	
66189	83041		66443	83150		66634	89436		66717	83515	
66189MM	83041		66445	83135		66634MOR	83203	89436	66717	85716	
66193	83034		66447	83180		66636	83127		66717MM	83515	
66196	83027		66448	85058	89431	66636MOR	83127		66719	83242	
66198	83158		66448	89431		66638	83123	89405	66720	85003	89411
66199	83048		66451	G64177		66638	89405		66720	89411	
66200	83066		66452	G64177		66639	G63610		66721	83391	
66201	83081		66453	G64089		66642	G63866		66722	83518	
66201MOR	83081		66454	83166		66643	83007		66811	83312	89409
66204	83024		66455	83166		66645	83008		66811	89409	
66209	83040		66458	83396		66646	83308		66813	83303	
66400	G63432		66486	85066	89448	66647	83009		66828	83159	
66402	83157		66486	89448		66648	83112		66829	83103	
66403	83154		66502	646155		66650	83003		66833	83126	89430
66405	83154		66502MOR	646155		66653	83515		66833	89430	
66406	85920	89503	66503	646155		66656	83110		66841	83216	
66406	89503		66504	632147		66657	83015		66841MM	83216	
66407	83134		66506	646155		66658	85009		66858	G63183	
66412	83169		66535	85062	89408	66659	83002		66860	83308	
66414	G64089		66535	89408		66660	85059		66860MM	83308	
66415	G63918		6658	85009		66661	83123	89405	66861	83309	
66418	85918	89449	66601	83114		66661	89405		66861MM	83309	
66418	89449		66602	G63610		66664	83215		66863	83314	
66419	85931	89458	66603	83103		66665	83109		66868	83219	
66419	89458		66604	83101		66666	G63671		66871	G63605	
66420	G64164		66605	83613		66668	83312	89409	66878	83221	
66422	83163		66607	85052		66668	89409		66878MOR	83221	
66422MOR	83163		66608	83128	89436	66669	83111		66883	83314	
66423	85001	89410	66608	83389	89436	66670	89402		66884	83125	
66423	89410		66608	89436		66671	83123	89405	66884MOR	83125	
66423MOR	85001	89410	66608MOR	83128	89436	66671	89405		66886	83124	89407
66424	85310	89423	66609	83635		66672	83209	89414	66886	89407	
66424	89423		66610	83130		66672	89414		66886MOR	83124	89407
66425	85920	89503	66611	83016		66675	83515		66891	83215	
66425	89503		66612	83017		66677	83114		66893	83203	89436
66426	85924	89457	66613	83123	89405	66678	83023		66893	89436	
66426	89457		66613	89405		66679	83013		66893MOR	83203	89436
66428	85033	89427	66614	83125		66680	83317		66894	83137	
66428	89427		66615	83120		66681	83025		66897	83126	89430
66429	85311	89424	66616	83018		66682	83005		66897	89430	
66429	89424		66617	83019		66683	83101		66898	83125	
66430	83309		66618	83159		66684	85007		66902	83401	
66431	85066	89448	66620	83162		66686	85014		66903	83400	
66431	89448		66623	83004		66692	83120		66913	83303	
66432	85319	89428	66624	83141		66693	83034		66921	83318	
66432	89428		66625	83162		66697	83164		66921MM	83318	
66433	85918	89449	66626	85071		66699	83113		66922	83301	
66433	89449		66627	85045		66701	83215		66923	83456	89447
66434	85069	89455	66627MOR	85045		66707	83215		66923	89447	
66434	89455		66628	83136		66710	83209	89414	66924	83244	
66435	83219		66629	83107		66710	89414		66924	83317	
66436	85067	89451	66630	83216		66710MOR	83209	89414	66924MM	83317	

Important Note: Competitive Interchanges are to be used for stocking purposes only. Where multiple crosses are identified, please reference the applications section of this catalog./ **Remarque importante:** Les interchanges concurrentiels ne s'utilisent qu'aux fins de stocks. Dans le cas de rferences multiples, consulter la section des applications du catalogue./ **Nota importante:** Dans le cas de rferences multiples, consulter la section des applications du catalogue./ **Nota importante:** Se pueden usar intercambios competitivos para propósitos de almacenamiento solamente. Cuando se identifican intercambios múltiples, consulte la sección de aplicaciones de este catálogo.

COMPETITIVE & O.E.M. INTERCHANGE LIST
Lista de Intercambios contra Competidores y Equipo Original.
Liste dinterchange de produits compititifs & dquipement original (OEM)

Monroe... cont'd

Monroe	Gabriel	Upgrade	Monroe	Gabriel	Upgrade	Monroe	Gabriel	Upgrade	Monroe	Gabriel	Upgrade
66956	83101		6902	83401		70402	85305		71331	G51740	
66957	83225		6903	83400		70642	85300	89419	71332	69586	
66966	85740		6910	G63413		70642	89419		71334	G51742	
66969	83126	89430	6911	G63350		70644	85334		71340	G51700	
66969	89430		6913	83303		70651	85013	89414	71341	G51718	
6701	83215		6916	83123	89405	70651	89414		71343	G56597	
6707	83215		6916	89405		70652	85030	89440	71346	G51887	
6710	83209	89414	6920	G63411		70652	89440		71347	G51477	
6710	89414		6921	83318		70663	85013	89414	71348	G51477	
6712	85040		6921MM	83318		70663	89414		71350	69998	
6713	83105		6922	83301		70691	85007		71351	G51077	
6714	83216		6923	83456	89447	70720	85934		71352	G51077	
6715	85026		6923	89447		70721	83125		71353	G51850	
6717	G63616		6927	G63409		71100	G51815		71356	G51841	
6718	85024		6945	G63421		71101	G51858		71358	G51715	
6719	83242		6956	83101		71102	G51766		71361	G51704	
6720	85003	89411	6957	83225		71103	G51765		71362	G51703	
6720	89411		6960	G63366		71105	G51854		71364	G51899	
6721	83103		6969	83126	89430	71106	G51853		71367	G51773	
672526	G57198		6969	89430		71109	G511055		71369	G51719	
672527	G57197		6994	83122	89406	71110	G511054		71370	G51729	
6803	G63907		6994	89406		71111	G51758		71371	G51739	
6803MM	G63907		70018	85303	89422	71112	G51881		71372	G51738	
6811	83312	89409	70018	89422		71113	G51767		71373	G51736	
6811	89409		70021	85303	89422	71115	G51825		71377	G56807	
6811MM	83312	89409	70021	89422		71119	G51855		71379	G51794	
6811MM	89409		70029	85308	89422	71120	G51849		71390	G51746	
6817	G63355		70029	89422		71124	G56838		71391	G52276	
6824	G63349		70034	85302	89420	71125	G56839		71398	G51723	
6828	83219		70034	89420		71126	G51863		71404	G56540	
6828MM	83219		70039	85303	89422	71128	G52131		71405	G56539	
6829	83103		70039	89422		71130	G52118		71406	G56641	
6833	83126	89430	70041	85305		71131	G52117		71407	G56640	
6833	89430		70042	85302	89420	71133	G56598		71417	G51714	
6839	G63357		70042	89420		71135	G52248		71424	G56633	
6841	83216		70088	85307		71136	G52247		71425	G56634	
6860	83308		70123	85716		71137	G51937		71426	G56672	
6860MM	83308		70127	85006		71138	G51860		71427	G56671	
6861	83309		70128	85006		71139	G51861		71433	G56622	
6863	83314		70162	85716		71140	G51865		71434	G56621	
6868	G63360		70163	85302	89420	71141	G51864		71435	G56561	
6878	83221		70163	89420		71142	G51738		71436	G56562	
6886	83124	89407	70164	85716		71146	G51838		71437	G55994	
6886	89407		70166	85301		71254	G56591		71438	G55993	
6891	83215		70300	85320	89429	71256	G55804		71441	G56688	
6893	83203	89436	70300	89429		71272	G51742		71442	G56687	
6893	89436		70312	85001	89410	71281	G55825		71451	G56758	
6894	83209	89414	70312	89410		71292	G55910		71452	G56759	
6894	89414		70315	85063		71293	G51087		71453	G56581	
6895	83204		70317	89402		71304	G51097		71454	G56582	
6897	83126	89430	70331	85314	89425	71307	G51729		71485	G56802	
6897	89430		70331	89425		71309	G51759		71486	G56791	
6898	83125		70332	83314		71311	G51268		71488	G56792	
6900	G63386		70334	85316	89426	71321	G51722		71494	G56680	
6901	G63387		70334	89426		71322	G51724		71495	G56679	
6901MM	G63387		70397	85006		71327	G51727		71496	G56680	

Important Note: Competitive Interchanges are to be used for stocking purposes only. Where multiple crosses are identified, please reference the applications section of this catalog. / **Remarque importante:** Les interchanges concurrentiels ne s'utilisent qu'aux fins de stocks. Dans le cas de rfrences multiples, consulter la section des applications du catalogue. / **Nota importante:** Dans le cas de rfrences multiples, consulter la section des applications du catalogue. / **Nota importante:** Se pueden usar intercambios competitivos para propósitos de almacenamiento solamente. Cuando se identifican intercambios múltiples, consulte la sección de aplicaciones de este catálogo.

COMPETITIVE & O.E.M. INTERCHANGE LIST
Lista de Intercambios contra Competidores y Equipo Original.
Liste dinterchange de produits comptitifs & dquipement original (OEM)

Monroe... cont'd

Monroe	Gabriel	Upgrade	Monroe	Gabriel	Upgrade	Monroe	Gabriel	Upgrade	Monroe	Gabriel	Upgrade
71497	G56679		72136	G52112		72269	G56841		72363	G52108	
71505	G56516		72138	G56817		72270	G56840		72364	G52105	
71525	G56606		72139	G56635		72271	G52033		72364	G52107	
71547	G56571		72140	G56636		72272	G52032		72365	G52106	
71548	G56637		72141	G56894		72275	G52007		72365	G52108	
71551	G52336		72142	G56894		72276	G52004		72366	G52105	
71553	G56529		72143	G56799		72278	G55948		72366	G52107	
71554	G56530		72144	G56800		72281	G51806		72367	G52082	
71565	G51267		72179	G56810		72288	G56843		72368	G52081	
71572	G56620		72203	G56809		72289	G56842		72371	G56893	
71573	G56616		72205	G56722		72290	G52153		72372	G56892	
71574	G56615		72206	G56721		72290	G52283		72373	G52018	
71577	G51728		72207	G56729		72291	G52152		72374	G52017	
71580	G55892		72208	G56728		72291	G52282		72378	G52095	
71581	G52238		72209	G56774		72292	G51856		72379	G52094	
71582	G52237		72210	G56773		72295	G56887		72384	G52104	
71588	G56537		72211	G56731		72296	G56886		72385	G52103	
71589	G56538		72212	G56730		72297	G52155		72390	G52097	
71592	G55896		72213	G56735		72298	G52154		72391	G52096	
71593	G56568		72214	G56734		72299	G52159		72392	G52122	
71594	G56601		72215	G56733		72300	G52158		72393	G52121	
71599	G56565		72216	G56732		72301	G52161		72394	G51795	
71632	G56701		72217	G52027		72302	G52160		72397	G51883	
71639	G55911		72218	G52026		72303	G52163		72398	G51880	
71661	G55948		72219	G56820		72304	G52162		72399	G51908	
71662	G55949		72220	G56819		72305	G52157		72400	G51852	
71669	G55856		72221	G56821		72306	G52156		72401	G51842	
71670	G55948		72222	G56822		72309	G52104		72408	G51760	
71671	G55949		72229	G52141		72310	G52103		72408	G51761	
71678	G56514		72230	G52140		72311	G56899		72408	G51947	
71679	G56506		72231	G52025		72312	G52301		72408	G51948	
71680	G55676		72236	G52108		72312	G56899		72423	G52185	
71681	G55675		72236	G56797		72313	G52143		72424	G52184	
71684	G56509		72237	G52107		72314	G52142		72433	G52250	
71685	G56509		72237	G56798		72315	G52275		72434	G52249	
71698	G55820		72240	G56672		72316	G52274		72437	G52300	
71728	G56700		72241	G56671		72321	G52116		72438	G52299	
71803	G55551		72244	G51774		72324	G51847		72443	G52261	
71822	G56718		72245	G52098		72327	G52176		72444	G52260	
71852	G55772		72248	G51760		72328	G52175		72445	G52183	
71857	G55591		72248	G51947		72331	G51863		72446	G52182	
71858	G55591		72248	G51948		72332	G52118		72471	G52244	
71875	G55774		72249	G51761		72333	G52117		72476	G52349	
71951	G55999		72250	G51814		72337	G52280		72477	G52348	
71952	G55999		72251	G51813		72338	G51916		72478	G51928	
71953	G55662		72257	G56837		72339	G52145		72480	G52298	
71954	G55661		72258	G56836		72340	G52144		72481	G52297	
71962	G55681		72261	G51859		72341	G51832		72482	G51934	
71964	G55697		72263	G52006		72342	G51833		72483	G52202	
71973	G55698		72263	G52450		72343	G52151		72484	G52201	
72114	G56660		72264	G52005		72344	G52150		72485	G52204	
72115	G56661		72264	G52449		72347	G52169		72486	G52203	
72116	G52014		72265	G52165		72348	G52168		72491	G52188	
72117	G52013		72266	G52164		72359	G52396		72492	G52187	
72122	G56655		72267	G52009		72360	G52395		72493	G52210	
72135	G52113		72268	G52008		72363	G52106		72494	G52209	

Important Note: Competitive Interchanges are to be used for stocking purposes only. Where multiple crosses are identified, please reference the applications section of this catalog. / **Remarque importante:** Les interchanges concurrentiels ne s'utilisent qu'aux fins de stocks. Dans le cas de références multiples, consulter la section des applications du catalogue. / **Nota importante:** Dans le cas de références multiples, consulter la section des applications du catalogue. / **Nota importante:** Se pueden usar intercambios competitivos para propósitos de almacenamiento solamente. Cuando se identifican intercambios múltiples, consulte la sección de aplicaciones de este catálogo.

COMPETITIVE & O.E.M. INTERCHANGE LIST
Lista de Intercambios contra Competidores y Equipo Original.
Liste dinterchange de produits comptitifs & dquipement original (OEM)

Monroe... cont'd

Monroe	Gabriel	Upgrade	Monroe	Gabriel	Upgrade	Monroe	Gabriel	Upgrade	Monroe	Gabriel	Upgrade
72497	G51879		72670	G52265		73030	G51975		74420	85003	89411
72506	G51926		72671	G52264		73045	G52188		74420	89411	
72507	G51925		72678	G52375		73046	G52187		74421	85708	
72508	G51908		72679	G52374		73074	G52410		74422	85733	
72509	G52149		72688	G52332		73075	G52411		74423	85712	
72510	G52148		72689	G52331		7315	G64040		74424	85308	89422
72511	G51848		72692	G51919		73226	G52281		74424	89422	
72518	G52125		72695	G51961		73264	G44461		74425	85724	89443
72524	G52256		72706	G52354		74001	85307		74425	89443	
72525	G52255		72707	G52353		74003	85314	89425	74426	85333	
72526	G52128		72708	G52440		74003	89425		74427	85308	89422
72527	G52127		72709	G52439		74004	85315		74427	89422	
72528	G52279		72731	G52314		74006	85304		74429	85919	
72529	G52278		72733	G52314		74012	85736		74430	85340	
72530	G52129		72734	G52314		74024	85308	89422	74431	85341	
72531	G52130		72747	G51900		74024	89422		74432	85970	
72532	G52398		72755	G52143		74025	85303	89422	74433	85331	
72533	G52399		72756	G52142		74025	89422		74434	85711	
72538	G51849		72763	G56735		74028	85302	89420	74435	85736	
72539	G51849		72764	G56734		74028	89420		74436	85334	
72540	G52406		72778	G52256		74029	85308	89422	74438	85734	
72541	G52254		72779	G52255		74029	89422		74439	85728	
72542	G52253		72780	G52131		74039	85303	89422	74439MM	85728	
72544	G52255		72888	G52352		74039	89422		74440	85729	
72545	G52256		72889	G52351		74069	85301		74441	85339	
72547	G52200		72894	G51848		74070	85716		74442	85727	
72548	G52199		72895	G51848		74073	85320	89429	74451	85711	
72549	G56899		72896	G51848		74073	89429		74452	85740	
72562	G51877		72905	G52122		74074	85722		74453	85339	
72562	G51878		72906	G52121		74075	85712		74454	85314	89425
72563	G51892		72917	G52258		74078	85027		74454	89425	
72567	G51910		72918	G52257		74079	85708		74454MM	85314	89425
72585	G52330		72920	G52261		74080	85332		74454MM	89425	
72586	G52329		72921	G52260		74081	85727		74464	85318	
72587	G52437		72922	G51901		74400	85700		74465	85708	
72588	G52438		72934	G52494		74402	85711		74466	85318	
72596	G51896		72935	G52495		74402MM	85711		74467	85723	
72596	G51897		72936	G52525		74405	85300	89419	74469	85345	
72597	G52246		72937	G52524		74405	89419		74471	85736	
72598	G52245		72950	G52082		74405MM	85300	89419	74472	85303	89422
72599	G51898		72951	G52081		74405MM	89419		74472	89422	
72604	G52383		72952	G51842		74406	85712		74473	85716	
72605	G52382		72955	G52171		74408	85702		74474	85916	89430
72606	G52171		72956	G52170		74409	85310	89423	74474	89430	
72607	G52170		72957	G51972		74409	89423		74480	85351	
72608	G52174		72974	G56758		74412	85704		75934	G52495	
72609	G52173		72975	G56759		74412MM	85704		75935	G52494	
72610	G52110		72976	G55948		74413	85700		801256	G55804	
72611	G52111		72977	G55948		74414	85723		801281	G55825	
72622	G56529		72980	G52106		74415	85318		801292	G55910	
72623	G56530		72981	G52105		74416	85705	89447	801293	G51087	
72635	G52172		72984	G511003		74416	89447		801311	G51268	
72647	G52361		72991	G51898		74417	85311	89424	801340	G51700	
72648	G52360		72997	G52174		74417	89424		801341	G51718	
72659	G52153		72998	G52173		74418	85709		801347	G51477	
72660	G52152		73029	G51916		74418MM	85709		801351	G51077	

Important Note: Competitive Interchanges are to be used for stocking purposes only. Where multiple crosses are identified, please reference the applications section of this catalog./ **Remarque importante:** Les interchanges concurrentiels ne s'utilisent qu'aux fins de stocks. Dans le cas de rfrences multiples, consulter la section des applications du catalogue./ **Nota importante:** Dans le cas de rfrences multiples, consulter la section des applications du catalogue./ **Nota importante:** Se pueden usar intercambios competitivos para propósitos de almacenamiento solamente. Cuando se identifican intercambios múltiples, consulte la sección de aplicaciones de este catálogo.

COMPETITIVE & O.E.M. INTERCHANGE LIST
Lista de Intercambios contra Competidores y Equipo Original.
Liste d'interchange de produits compétitifs & d'équipement original (OEM)

Monroe... cont'd

Monroe	Gabriel	Upgrade	Monroe	Gabriel	Upgrade	Monroe	Gabriel	Upgrade	Monroe	Gabriel	Upgrade
801352	G51077		901952	142173		904974	143244		907923	143339	
801358	G51715		901958	142249		904975	143315		907925	143325	
801377	G56807		901964	142245		904980	143227		907932	143359	
801426	G56672		901965	142135		904984	143464		907937	143360	
801427	G56671		901966	142252		904988	143194		907940	143361	
801433	G56622		901975	143277		904989	143202		907943	143406	
801434	G56621		901999	142852		904990	143094		907944	143357	
801437	G55994		902906	142444		905904	143305		907947	143345	
801438	G55993		902923	142419		905906	143239		907949	143344	
801504	G56517		902924	143492		905907	143323		907986	143366	
801505	G56516		902926	142561		905908	143355		907986	143486	
801525	G56606		902946	143320		905909	143354		907990	143425	
801565	G51267		902953	142843		905910	143316		907991	143460	
801572	G56620		902954	142402		905912	143281		907994	143495	
801580	G55892		902954	142843		905913	143385		908900	143564	
801592	G55896		902958	142329		905914	143324		908910	143491	
801616	G55901		902968	143071		905915	143341		908944	143398	
801661	G55948		902968	143074		905916	143397		908946	143349	
801662	G55949		902969	143072		905922	143364		908953	143089	
801669	G55856		902969	143073		905923	143419		908993	143474	
801678	G56514		902973	142526		905930	143408		908995	143473	
801679	G56506		902984	142625		905936	143388		909957	143201	
801680	G55676		902991	143063		905937	143387		911021	77422	
801681	G55675		9039005	142569		905944	143088		911030	G63479	
801728	G56700		903902	142828		905945	143394		911034	G63410	
801803	G55551		903903	142649		905948	143089		911035	77679	
801822	G56718		903906	142650		905953	143418		911038	77461	
801857	G55591		903910	142546		905966	143369		911039	G63456	
801858	G55591		903911	142547		905966	143468		911043	G63609	
801875	G55774		903918	143082		905969	143335		911044	58488	
801897	G51267		903924	143256		905980	143363		911044	61543	
801951	G55999		903926	142932		905983	143342		911044	81667	
801952	G55999		903928	142930		905985	143455		911050	58489	
801953	G55662		903932	143459		906914	142937		911050	61544	
801954	G55661		903954	142938		906917	143321		911050	81668	
801962	G55681		903967	142746		906918	143318		911055	77455	
801964	G55697		903968	142747		906919	143353		911080	G63624	
801973	G55698		903977	142755		906920	143353		911085	G63896	
802179	G56810		903986	143466		906927	143319		911086	G63897	
802236	G56797		903987	143465		906936	142556		911096	G63360	
802248	G51760		903991	142836		906958	143336		911099	77423	
802248	G51761		903995	143367		906959	143496		911102	77661	
802275	G52007		904900	143325		906962	143415		911103	G63662	
802276	G52004		904903	143191		906967	143477		911104	77673	
872526	G57198		904904	143191		906968	143416		911128	77608	
872527	G57197		904905	142651		906969	143410		911131	77714	
901904	142444		904909	142653		906970	143409		911132	G63778	
901908	142933		904909	143380		906977	143458		911133	G63716	
901922	142530		904912	143059		906980	143365		911134	G63715	
901933	142850		904918	143197		906980	143422		911140	77403	
901940	142230		904932	143204		906981	143531		911144	61614	
901940	142419		904935	143201		906982	143412		911145	77717	
901940	143030		904954	143218		906983	143404		911149	61641	
901940	143423		904955	143209		906990	143422		911149	81920	
901941	142251		904957	143087		906996	143390		911150	58662	
901942	142195		904973	143317		906997	143391		911150	61600	

Important Note: Competitive Interchanges are to be used for stocking purposes only. Where multiple crosses are identified, please reference the applications section of this catalog. / **Remarque importante:** Les interchanges concurrentiels ne s'utilisent qu'aux fins de stocks. Dans le cas de références multiples, consulter la section des applications du catalogue. / **Nota importante:** Dans le cas de références multiples, consulter la section des applications du catalogue. / **Nota importante:** Se pueden usar intercambios competitivos para propósitos de almacenamiento solamente. Cuando se identifican intercambios múltiples, consulte la sección de aplicaciones de este catálogo.

COMPETITIVE & O.E.M. INTERCHANGE LIST

Lista de Intercambios contra Competidores y Equipo Original.

Liste d'interchange de produits compititifs & d'equpement original (OEM)

Monroe... cont'd

Monroe	Gabriel	Upgrade	Monroe	Gabriel	Upgrade	Monroe	Gabriel	Upgrade	Monroe	Gabriel	Upgrade
911150	81873		911260	61734		911536	77981		AMS65494	85061	89450
911151	G63803		911261	G63870		911538	77973		AMS65495	85067	89451
911152	58412		911262	G63867		911539	77973		AMS65499	85963	
911152	61642		911265	61713		911540	77978		AMS65500	85738	
911152	81921		911266	77951		911545	77975		AMS65501	85323	89436
911152MM	G63675		911268	G63888		911546	77975		AMS65502	85938	
911161	77847		911270	G63885		972526	G57198		AMS65503	85919	
911163	61641		911270	G64029		972527	G57197		AMS65504	85072	
911163	81920		911270	G64030		AMS65101	85062	89408	AMS65505	83147	
911164	G63675		911273	G64031		AMS65102	85001	89410	AMS65511	85939	
911166	58930		911274	G64033		AMS65103	85320	89429	AMS65512	85938	
911166	61675		911276	69594		AMS65106	83124	89407	AMS65519	85060	
911166	81930		911277	G63890		AMS65108	85030	89440	AMS65522	85082	
911167	77953		911277	G63891		AMS65118	85001	89410	AMS65523	85937	
911168	G63675		911278	G64012		AMS65124	85053	89442	AMS65528	85069	89455
911171	G63813		911279	G63889		AMS65128	85031		AMS65530	85932	89453
911172	G63492		911298	G64038		AMS65140	85918	89449	AMS66104	83021	
911173	77807		911300	G64043		AMS65142	83131		AMS66115	83045	
911174	G63607		911302	G64079		AMS65143	83163		AMS66122	83038	
911175	G63809		911303	G64121		AMS65147	85924	89457	AMS66126	83051	
911176	77837		911304	G511000		AMS65148	85918	89449	AMS66138	619501	
911178	58803		911304	G511038		AMS65155	83175		AMS66162	83025	
911178	61643		911330	G51980		AMS65157	85954		AMS66403	83154	
911178	81922		911331	G63867		AMS65159	85070	89459	AMS66424	85310	89423
911181	G63817		911331	G64157		AMS65162	85959		AMS66445	83135	
911183	G63832		911332	G64079		AMS65179	85995		AMS66502	646155	
911184	G63828		911334	G64157		AMS65400	85033	89427	AMS66603	83103	
911186	77954		911335	G64079		AMS65402	85311	89424	AMS66605	83613	
911187	G63961		911447	G64148		AMS65404	85310	89423	AMS66607	85052	
911187	G63962		911501	77803		AMS65405	85023	89415	AMS66608	83128	89436
911188	G63848		911502	77412		AMS65409	85003	89411	AMS66613	83123	89405
911190	G63609		911503	77783		AMS65410	85300	89419	AMS66615	83120	
911192	77675		911504	77662		AMS65411	85036	89405	AMS66624	83141	
911193	61635		911505	77803		AMS65416	85000	89436	AMS66627	85045	
911194	G63808		911506	77953		AMS65419	85000	89436	AMS66628	83136	
911195	58809		911506	77975		AMS65420	85013	89414	AMS66634	83203	89436
911195	61655		911507	77817		AMS65431	85909		AMS66636	83127	
911195	77809		911508	G64000		AMS65434	85012	89413	AMS66648	83112	
911196	77810		911509	77971		AMS65435	85901		AMS66683	83101	
911198	G63673		911510	61717		AMS65436	85900		AMS66710	83209	89414
911220	G63905		911511	77609		AMS65444	85311	89424	AMS66828	83159	
911221	77949		911512	77488		AMS65451	85029		AMS66833	83126	89430
911222	77950		911513	77489		AMS65459	85043		AMS66861	83309	
911223	77948		911514	77423		AMS65468	85069	89455	AMS66878	83221	
911226	G64028		911517	77422		AMS65480	83111		AMS66884	83125	
911228	G63882		911521	77715		AMS65481	85036	89405	AMS66886	83124	89407
911229	G63884		911522	77847		AMS65482	85006		AMS66891	83215	
911230	G63879		911523	77829		AMS65483	85978		AMS66893	83203	89436
911251	G63878		911525	77683		AMS65484	85976		AMS66897	83126	89430
911252	G63883		911527	G64001		AMS65486	85066	89448	AMS66923	83456	89447
911253	G63875		911528	77983		AMS65487	85927		AMS66924	83317	
911255	61684		911529	G63813		AMS65489	85331		AMS66956	83101	
911256	61683		911530	77907		AMS65490	85724	89443	AMS66969	83126	89430
911257	G63895		911533	77976		AMS65492	85931	89458	AMS74405	85300	89419
911258	61718		911534	77980		AMS65492MM	85931	89458	AMS74439	85728	
911259	G64016		911535	G64013		AMS65493	85934		AMS74465	85708	

Important Note: Competitive Interchanges are to be used for stocking purposes only. Where multiple crosses are identified, please reference the applications section of this catalog. / **Remarque importante:** Les interchanges concurrentiels ne s'utilisent qu'aux fins de stocks. Dans le cas de références multiples, consulter la section des applications du catalogue. / **Nota importante:** Dans le cas de références multiples, consulter la section des applications du catalogue. / **Nota importante:** Se pueden usar intercambios competitivos para propósitos de almacenamiento solamente. Cuando se identifican intercambios múltiples, consulte la sección de aplicaciones de este catálogo.

COMPETITIVE & O.E.M. INTERCHANGE LIST
Lista de Intercambios contra Competidores y Equipo Original.
Liste dinterchange de produits compititifs & dquipement original (OEM)

MOOG

Moog	Gabriel	Upgrade	Moog	Gabriel	Upgrade	Moog	Gabriel	Upgrade	Moog	Gabriel	Upgrade
K160002	143354		K6440	142245		K9789	142836		ST8569R	G56925	
K160003	143355		K6515	143459		K9794	142625		ST8573	G57017	
K160004	143425		K6521	142526		K9798	143465		ST8573	G57019	
K160012	143089		K6725	142852		K9799	143466		ST8574L	G57030	
K160026	143418		K7226	142419		K9904	143281		ST8574R	G57031	
K160028	143388		K7226	143394		SSD122	6861SE		ST8578L	G57032	
K160029	143387		K7226	143422		SSD131	6856SE		ST8578R	G57033	
K160049	143385		K7372	143256		SSD56	14071		ST8579L	G57045	
K160050	143364		K7375	142932		SSD56	6801SE		ST8579R	G57046	
K160051	143321		K7380	142828		ST8511	G57013		ST8581	G56929	
K160052	143323		K7413	143423		ST8512	G57014		ST8582	G57021	
K160056	143419		K7414	143423		ST8513	G56995		ST8583	G57000	
K160089	143408		K7456	143087		ST8515L	G56932		ST8590L	G57034	
K160092	143324		K80031	142930		ST8515R	G56933		ST8590R	G57035	
K160094	143335		K80145	143357		ST8519	G57006		ST8591	G57036	
K160096	143369		K80218	143244		ST8524L	G56948		ST8592L	G57049	
K160096	143468		K80219	143244		ST8524R	G56948		ST8592R	G57050	
K160097	143317		K80902	143404		ST8525L	G56949		ST8595L	G57065	
K160098	143316		K80907	143239		ST8525R	G56950		ST8595R	G57066	
K160099	143305		K80915	143218		ST8527	G56936		ST8596L	G57011	
K160101	143416		K80917	143088		ST8528	G56935		ST8596R	G57012	
K160104	143398		K80928	143194		ST8530	G56938		ST8597L	G57047	
K160105	143455		K80931	143191		ST8532	G57057		ST8597R	G57048	
K160132	143344		K8693	142852		ST8532	G57058		ST8598	G57172	
K160135	143319		K8741	142843		ST8533L	G57010		ST8599	G57173	
K160148	143422		K8743	142402		ST8533R	G57010		ST8601L	G57069	
K160197	143495		K90222	143458		ST8538L	G56996		ST8601L	G57121	
K160198	143318		K90238	143367		ST8538R	G56997		ST8601R	G57122	
K160200	143564		K90239	142561		ST8539	G56998		ST8602	G57039	
K160201	143391		K90240	143191		ST8540	G56934		ST8602R	G57070	
K160202	143390		K90241	142651		ST8540	G56937		ST8603	G57053	
K160209	143341		K90269	143082		ST8546L	G56930		ST8604	G57132	
K160210	143363		K90289	143197		ST8546R	G56931		ST8606	G57147	
K160211	143462		K90290	143325		ST8547	G57060		ST8608L	G57133	
K160212	143461		K90301	142938		ST8548L	G56962		ST8608R	G57134	
K160214	143460		K90307	143191		ST8548T	G56963		ST8609L	G57027	
K160225	143342		K90323	143315		ST8549	G56964		ST8609R	G57027	
K160228	143191		K90326	143209		ST8550	G56927		ST8611	G57095	
K160228	143365		K90327	143204		ST8551	G56928		ST8612	G57096	
K160229	143531		K90330	143201		ST8552L	G56991		ST8615	G57118	
K160264	143406		K90462	143058		ST8552R	G56992		ST8616L	G57123	
K160271	143345		K90462	143059		ST8553	G56943		ST8616R	G57124	
K160285	143064		K90464	143061		ST8554	G56951		ST8617L	G57112	
K160288	143491		K90648	143353		ST8555L	G57063		ST8617R	G57113	
K160294	143366		K90655	142937		ST8555R	G57064		ST8618L	G57110	
K160294	143486		K90658	143202		ST8560	G57051		ST8618R	G57111	
K160297	143397		K9478	142249		ST8562	G56965		ST8620	G57080	
K160298	143477		K9492	142230		ST8563	G57018		ST8622L	G57061	
K160316	142653		K9559	143492		ST8564	G57022		ST8622R	G57062	
K160334	143473		K9583	142444		ST8565L	G57007		ST8626L	G57041	
K160369	143415		K9624	142135		ST8565R	G57008		ST8626R	G57042	
K160383	142650		K9632	142252		ST8566	G57015		ST8627L	G57043	
K160390	142649		K9692	142329		ST8567	G57016		ST8627R	G57044	
K160392	143094		K9711	142561		ST8568	G57020		ST8629L	G57114	
K16093	143321		K9775	142547		ST8568	G57103		ST8629R	G57115	
K5338	142530		K9786	142546		ST8569L	G56924		ST8631	G57142	

Important Note: Competitive Interchanges are to be used for stocking purposes only. Where multiple crosses are identified, please reference the applications section of this catalog. / **Remarque importante:** Les interchanges concurrentiels ne s'utilisent qu'aux fins de stocks. Dans le cas de références multiples, consulter la section des applications du catalogue. / **Nota importante:** Dans le cas de références multiples, consulter la section des applications du catalogue. / **Nota importante:** Se pueden usar intercambios competitivos para propósitos de almacenamiento solamente. Cuando se identifican intercambios múltiples, consulte la sección de aplicaciones de este catálogo.

COMPETITIVE & O.E.M. INTERCHANGE LIST
Lista de Intercambios contra Competidores y Equipo Original.
Liste dinterchange de produits compititifs & dquipement original (OEM)

MOOG... cont'd

Moog	Gabriel	Upgrade	Moog	Gabriel	Upgrade	Moog	Gabriel	Upgrade	Moog	Gabriel	Upgrade
ST8632L	G57054		ST8635	G57056		ST8638R	G57089		ST8640R	G57168	
ST8632R	G57055		ST8638L	G57088		ST8640L	G57167				

Mor-Ryde Suspension

Mor-ryde suspension	Gabriel	Upgrade	Mor-ryde suspension	Gabriel	Upgrade	Mor-ryde suspension	Gabriel	Upgrade	Mor-ryde suspension	Gabriel	Upgrade
U0109-006	G63866		U0109-014	83400		U0109006	G63866		U0109014	83400	
U0109-007	G63183		U0109-018	G63866		U0109007	G63183		U0109018	G63866	

Motor Coach Industries

Motor coach industries	Gabriel	Upgrade	Motor coach industries	Gabriel	Upgrade	Motor coach industries	Gabriel	Upgrade	Motor coach industries	Gabriel	Upgrade
01-205219	85727		12051023	85341		12J-5-10	85733		1498200	85740	
01205219	85727		12051101	85340		12J-5-10GS	85733		1498358	85339	
12-05-1021	85340		12051102	85970		12J-5-71	85733		1498565	85339	
12-05-1022	85970		12051103	85341		12J-5-9	85700		1509681	85339	
12-05-1023	85341		12051137	85340		12J510	85733		1516986	85711	
12-05-1101	85340		12051138	85970		12J510GS	85733		1517351	85740	
12-05-1102	85970		12051139	85341		12J571	85733		1517716	85339	
12-05-1103	85341		12051142	85340		12J59	85700		1522465	85727	
12-05-1137	85340		12051146	85340		12L-4-170	83158		19507669	85340	
12-05-1138	85970		12051147	85341		12L-5-100	85727		196013	85340	
12-05-1139	85341		12051148	85970		12L-5-114	85727		22012067	85700	
12-05-1142	85340		12051150	85711		12L-5-58	85728		22024061	85704	
12-05-1146	85340		12051165	85711		12L-5-67	85728		22045526	85702	
12-05-1147	85341		12051166	85341		12L-5-69	85700		22052014	85702	
12-05-1148	85970		12051170	85340		12L-5-70	85700		3178157	85700	
12-05-1150	85711		12051176	85728		12L-5-71	85708		63-0127GS	85303	89422
12-05-1165	85711		12051177	85729		12L-5-72	85709		63-0127GS	89422	
12-05-1166	85341		12051178	85339		12L-5-88	85729		630127GS	85303	89422
12-05-1170	85340		12051179	85727		12L-5-89	85729		630127GS	89422	
12-05-1176	85728		12051188	85970		12L-5-96	85728		6314933	85708	
12-05-1177	85729		12051194	85339		12L-5-97	85728		654789	83158	
12-05-1178	85339		12051199	85729		12L-5-98	85339		680232	85733	
12-05-1179	85727		12051228	85711		12L-5-99	85339		680322	85704	
12-05-1188	85970		12051242	85728		12L4170	83158		680323	85700	
12-05-1194	85339		12051243	85729		12L5100	85727		680333	85708	
12-05-1199	85729		12051244	85727		12L5114	85727		680369	85708	
12-05-1228	85711		12051260	85728		12L558	85728		680374	85728	
12-05-1242	85728		12051261	85729		12L567	85728		680441	85729	
12-05-1243	85729		12051262	85727		12L569	85700		680452	85339	
12-05-1244	85727		12051264	85727		12L570	85700		680462	85728	
12-05-1260	85728		12051327	85728		12L571	85708		680470	85713	
12-05-1261	85729		12051328	85729		12L572	85709		680482	85727	
12-05-1262	85727		12051329	85727		12L588	85729		680485	85733	
12-05-1264	85727		12056000	85711		12L589	85729		680544	85711	
12-05-1327	85728		12056001	85740		12L596	85728		680546	85339	
12-05-1328	85729		12056002	85339		12L597	85728		680602	85339	
12-05-1329	85727		12056033	85339		12L598	85339		680677	85728	
12-05-6000	85711		12056053	85711		12L599	85339		680680	85729	
12-05-6001	85740		12056054	85740		12T-1-13	85303	89422	680681	85727	
12-05-6002	85339		12056055	85339		12T-1-13	89422		690029	85700	
12-05-6033	85339		12056068	85727		12T113	85303	89422	695125	85704	
12-05-6053	85711		1251G	85700		12T113	89422		85729	85729	
12-05-6054	85740		1251GS	85700		12TA-01-013	85303	89422	90-2587	85339	
12-05-6055	85339		12B-5-1-G	85700		12TA-01-013	89422		97-2201-00151	85700	
12-05-6068	85727		12B-5-1-GS	85700		12TA01013	85303	89422	97-2210-00164	85708	
12-5-1-G	85700		12B51G	85700		12TA01013	89422				
12-5-1-GS	85700		12B51GS	85700		1497628	85711				
12051021	85340		12G-5-1	85700		1497835	85711				
12051022	85970		12G51	85700		1497993	85740				

Important Note: Competitive Interchanges are to be used for stocking purposes only. Where multiple crosses are identified, please reference the applications section of this catalog. / **Remarque importante:** Les interchanges concurrentiels ne s'utilisent qu'aux fins de stocks. Dans le cas de références multiples, consulter la section des applications du catalogue. / **Nota importante:** Dans le cas de referencias multiples, consultar la seccion de aplicaciones del catalogo. / **Nota importante:** Se pueden usar intercambios competitivos para propósitos de almacenamiento solamente. Cuando se identifican intercambios múltiples, consulte la sección de aplicaciones de este catálogo.

COMPETITIVE & O.E.M. INTERCHANGE LIST
Lista de Intercambios contra Competidores y Equipo Original.
Liste dinterchange de produits comptitifs & dquipement original (OEM)

Motor Coach Industries... cont'd

Motor coach industries	Gabriel	Upgrade	Motor coach industries	Gabriel	Upgrade	Motor coach industries	Gabriel	Upgrade	Motor coach industries	Gabriel	Upgrade
97-9999-02514	85700		G1011822	85702		OE10883	85339		T14-1082	85727	
97-9999-02585	85723		G1101590	85713		T12-1208	85727		T141045GS	85700	
97-9999-02634	85733		G1101590GS	85713		T121208	85727		T141048	85302	89420
97220100151	85700		G1201339	85702		T14-1045GS	85700		T141048	89420	
97221000164	85708		G5008069	85700		T14-1048	85302	89420	T141080	85728	
97999902514	85700		OE10086S	85702		T14-1048	89420		T141081	85729	
97999902585	85723		OE10881	85711		T14-1080	85728		T141082	85727	
97999902634	85733		OE10882	85740		T14-1081	85729				

Motorcraft

Motorcraft	Gabriel	Upgrade	Motorcraft	Gabriel	Upgrade	Motorcraft	Gabriel	Upgrade	Motorcraft	Gabriel	Upgrade
AA-229	G63773		ASH-1159	G64037		ASH-24492	83175		ASH-394	G63614	
AA-450	G63773		ASH-1160	G64037		ASH-24495	G63870		ASH-397	83131	
AA-456	G63772		ASH-119	G63809		ASH-245	69900		ASH-398	85928	
AA-457	G63678		ASH-120	G63837		ASH-24531	G51887		ASH-4	G63716	
AA-483	G63837		ASH-1205	83209	89414	ASH-24533	G51888		ASH-407	G63809	
AA-484	G63837		ASH-1205	89414		ASH-24538	69575		ASH-408	G63809	
AA-485	G63837		ASH-1206	83122	89406	ASH-24539	69574		ASH-487	G63867	
AA-486	G63607		ASH-1206	89406		ASH-24548	G64111		ASH-51	G63773	
AA-494	83131		ASH-121	G63607		ASH-24659	85181		ASH-678	G63717	
AA-500	G63809		ASH-122	G63614		ASH-24660	85180		ASH-684	G63623	
AA-501	G63809		ASH-12221	70052		ASH-24667	G63676		ASH-69	83175	
AA-502	G63614		ASH-12222	70052		ASH-24676	G511001		ASH-701	G51888	
AA-503	G63614		ASH-12277	69574		ASH-24741	G51860		ASH-706	G63614	
AA-504	G63614		ASH-1228	83209	89414	ASH-25	83309		ASH-707	G63614	
AA-615	83135		ASH-1228	89414		ASH-252	G63929		ASH-712	69575	
AA-616	83175		ASH-1230	83122	89406	ASH-257	G51703		ASH-759	G51729	
AA-617	85928		ASH-1230	89406		ASH-25822	83209	89414	ASH-787	G63870	
AD1002	143318		ASH-12322	G51861		ASH-25822	89414		ASH-791	G51724	
AD1043	143360		ASH-12326	G51861		ASH-25823	83209	89414	ASH-795	G63867	
AD1050	143415		ASH-12335	G51861		ASH-25823	89414		ASH-797	G63867	
AD962	143318		ASH-12336	G51861		ASH-25824	83122	89406	ASH-820	G51723	
AS-1086	G63678		ASH-1255	70096		ASH-25824	89406		ASH-824	G63929	
AS-413	G63414		ASH-1256	70096		ASH-25825	83122	89406	ASH-864	G63929	
AS-485G	G63622		ASH-132	G63614		ASH-25825	89406		ASH-967	G51719	
AS-498G	G63608		ASH-137	83122	89406	ASH-26	85006		ASHV-1	G63678	
AS-500G	G63624		ASH-137	89406		ASH-2737	G51860		ASHV-1000	G63608	
AS1020G	G63386		ASH-163	G51724		ASH-29	83314		ASHV-1000	G63614	
AS105	69606		ASH-172	G51704		ASH-294	83209	89414	ASHV-1014	69845	
AS1055G	G63490		ASH-224	G51704		ASH-294	89414		ASHV-1015	G63622	
AS200	G63350		ASH-23406	G56838		ASH-32	83125		ASHV-1025	G63623	
AS310	G63524		ASH-23407	G56839		ASH-322	77969		ASHV-1028	G63778	
AS954G	G63299		ASH-23415	G63969		ASH-324	77968		ASHV-1031	G63692	
ASH-1022	83209	89414	ASH-23454	G63614		ASH-335	G63969		ASHV-1038	69675	
ASH-1022	89414		ASH-23458	G63614		ASH-36	85716		ASHV-1039	69898	
ASH-1023	83122	89406	ASH-23460	G63714		ASH-362	G63607		ASHV-1046	G63772	
ASH-1023	89406		ASH-23465	G511001		ASH-363	G63525		ASHV-1047	G63607	
ASH-1028	69592		ASH-24397	G63716		ASH-364	G63524		ASHV-1048	G63525	
ASH-1113	69593		ASH-24401	G63809		ASH-365	G63772		ASHV-1049	G63524	
ASH-1121	G63873		ASH-24402	85928		ASH-366	G63608		ASHV-1050	G63608	
ASH-1129	14072		ASH-24407	G63867		ASH-37	85712		ASHV-1051	G63837	
ASH-1130	G63622		ASH-24408	G63717		ASH-38	85314	89425	ASHV-1056	G51722	
ASH-1131	G63622		ASH-24411	G63717		ASH-38	89425		ASHV-1056	G51723	
ASH-1132	G63622		ASH-24425	G63624		ASH-386	G63717		ASHV-12	69962	
ASH-1135	G63623		ASH-24433	G63837		ASH-387	G63809				
ASH-1136	G63623		ASH-24434	G63607		ASH-39	85001	89410			
ASH-1154	G63622		ASH-24438	6828SE		ASH-39	89410				
ASH-1155	G63623		ASH-24478	G56838		ASH-391	G63809				

Important Note: Competitive Interchanges are to be used for stocking purposes only. Where multiple crosses are identified, please reference the applications section of this catalog. / **Remarque importante:** Les interchanges concurrentiels ne s'utilisent qu'aux fins de stocks. Dans le cas de références multiples, consulter la section des applications du catalogue. / **Nota importante:** Dans le cas de referencias multiples, consultar la sección de aplicaciones del catálogo. / **Nota importante:** Se pueden usar intercambios competitivos para propósitos de almacenamiento solamente. Cuando se identifican intercambios múltiples, consulte la sección de aplicaciones de este catálogo.

COMPETITIVE & O.E.M. INTERCHANGE LIST
Lista de Intercambios contra Competidores y Equipo Original.
Liste dinterchange de produits comptitifs & dquipement original (OEM)

Motorcraft... cont'd

Motorcraft	Gabriel	Upgrade	Motorcraft	Gabriel	Upgrade	Motorcraft	Gabriel	Upgrade	Motorcraft	Gabriel	Upgrade
ASHV-13	G63676		AST-910	G52351		AX-97A	89430		CAT-895	83207	89407
ASHV-14	G63837		AST-911	G52351		CAH-001	85307		CAT-895	89407	
ASHV-3	G63714		AST-913	G52352		CAH-001	85711		CAT-900	G63386	
ASHV-4	G63716		AST-914	G52352		CAH-003	83215		CAT-901	G63387	
ASHV-6	G63809		ASTV-25	G55681		CAH-006	85304		CAT-904	G63299	
ASHV-7	69464		ASTV-31	G55901		CAH-012	85736		CAT-905	G63405	
ASHV-8	69465		AT-110	G63387		CAH-025	85007		CAT-907	G63511	
ASHV-864	G63929		AT-147	G63350		CAH-028	85302	89420	CAT-910	G63413	
ASHV-865	G63808		AT-163G	G63622		CAH-028	89420		CAT-911	G63350	
ASHV-866	G63810		AT-164G	G63623		CAH-029	85308	89422	CAT-912	G63625	
ASHV-867	G63455		AT-504G	G63679		CAH-029	89422		CAT-919	G63411	
ASHV-871	G63809		AT-506G	G63679		CAH-069	83219		CAT-920	G63675	
ASHV-879	G63455		AT-507G	G63607		CAH-069	85301		CAT-926	G63410	
ASHV-9	G63375		AT-546	G63678		CAHL-400	85303	89422	CAT-927	G63409	
ASHV-992	G63679		AT-547	G63775		CAHL-400	85700		CAT-928	G63410	
ASHV-995	G63414		AT-554	85305		CAHL-400	89422		CAT-929	G63403	
ASHV-997	G63678		AT-557	G63714		CAHL-405	85300	89419	CAT-930	G63461	
AST-115	G56517		AT-568	G63622		CAHL-405	89419		CAT-935	G63424	
AST-159	G51859		AT-579	G63809		CAHL-406	85004		CAT-936	G63425	
AST-162	G51859		AT-610	G63461		CAHL-409	85310	89423	CAT-944	G63347	
AST-177	69591		AT-611	G63461		CAHL-409	89423		CAT-945	G63421	
AST-233	G56655		AT-620	83209	89414	CAHL-417	85311	89424	CAT-948	G63909	
AST-235	G51849		AT-620	89414		CAHL-417	89424		CAT-953	G63375	
AST-236	G51849		AT-621	83122	89406	CAT-722	83400		CAT-953	G63903	
AST-260	G63929		AT-621	89406		CAT-729	G63414		CAT-955	G63454	
AST-266	G52110		AT-682	G63678		CAT-730	G63386		CAT-958	G63377	
AST-268	G52111		AT-683	G63679		CAT-731	G63409		CAT-960	G63366	
AST-284	G56836		AT-684	G63679		CAT-732	G63455		CAT-963	G63525	
AST-291	G56837		AT-685	G63679		CAT-736	G63394		CAT-964	G63456	
AST-311	G64047		AT-696	83140		CAT-740	G63423		CAT-972	G63610	
AST-369	G52129		AT-710	G63809		CAT-741	G63489		CAT-975	G63511	
AST-383	G56817		AT-713	G63614		CAT-745	G63608		CAT-976	G63490	
AST-385	G56817		AT-715	G63614		CAT-745	G63614		CAT-977	G63915	
AST-405	G52130		AT-716	G63809		CAT-750	G63359		CAT-983	G63489	
AST-422	G51897		AT-764	G63678		CAT-751	G63607		CAT-984	G63609	
AST-423	G51896		AT-765	G63772		CAT-758	G63909		CAT-984	G63818	
AST-424	G51897		AT-766	83209	89414	CAT-759	G63624		CAT-985	G63488	
AST-443	G52130		AT-766	89414		CAT-760	G63622		CAT-986	G63489	
AST-449	G56817		AT-811	83135		CAT-761	G63623		CAX-001	85307	
AST-451	G56817		AT619G	G63410		CAT-762	G63638		CAX-707	83215	
AST-472	G52399		AX-267A	83309		CAT-768	83209	89414	CAX-707	85001	89410
AST-474	G52399		AX-269A	83308		CAT-768	89414		CAX-707	89410	
AST-477	G52398		AX-269A	83312	89409	CAT-776	G63661		CAX-710	83209	89414
AST-66	G56516		AX-269A	89409		CAT-777	G63662		CAX-710	89414	
AST-867	G52352		AX-277A	83219		CAT-778	G63673		CAX-720	85003	89411
AST-867	G56841		AX-282A	85010		CAT-793	G63414		CAX-720	89411	
AST-868	G52351		AX-310	83215		CAT-802	G63419		CAX-811	83312	89409
AST-868	G56840		AX-327	G63773		CAT-803	G63306		CAX-811	89409	
AST-871	G56841		AX-332	85928		CAT-817	G63355		CAX-828	83207	89407
AST-872	G56840		AX-79A	83221		CAT-824	G63349		CAX-828	85012	89413
AST-900	G52406		AX-79A	85030	89440	CAT-828	G63494		CAX-828	89407	
AST-902	G52406		AX-79A	89440		CAT-831	G63359		CAX-828	89413	
AST-903	G52406		AX-85A	83219		CAT-832	G63353		CAX-833	83303	
AST-904	G52406		AX-97A	83122	89406	CAT-839	G63357		CAX-833	85005	89430
AST-905	G52255		AX-97A	85005	89430	CAT-853	G63183		CAX-833	89430	
AST-906	G52256		AX-97A	89406		CAT-868	G63360		CAX-841	83216	

Important Note: Competitive Interchanges are to be used for stocking purposes only. Where multiple crosses are identified, please reference the applications section of this catalog./ **Remarque importante:** Les interchanges concurrentiels ne s'utilisent qu'aux fins de stocks. Dans le cas de rfrences multiples, consulter la section des applications du catalogue./ **Nota Importante:** Dans le cas de rfrences multiples, consultar la section des aplicaciones du catalogue./ **Nota Importante:** Se pueden usar intercambios competitivos para propósitos de almacenamiento solamente. Cuando se identifican intercambios múltiples, consulte la sección de aplicaciones de este catálogo.

COMPETITIVE & O.E.M. INTERCHANGE LIST
Lista de Intercambios contra Competidores y Equipo Original.
Liste dinterchange de produits comptitifs & dquipement original (OEM)

Motorcraft... cont'd

Motorcraft	Gabriel	Upgrade	Motorcraft	Gabriel	Upgrade	Motorcraft	Gabriel	Upgrade	Motorcraft	Gabriel	Upgrade
CAX-860	83308		CAX-893	83203	89436	CAX-898	85006		CAX-957	83225	
CAX-861	83309		CAX-893	85000	89436	CAX-913	83303		CAX-969	83221	
CAX-863	83314		CAX-893	85043		CAX-916	83123	89405	CAX-969	85030	89440
CAX-878	83221		CAX-893	89436		CAX-916	85036	89405	CAX-969	89440	
CAX-886	83207	89407	CAX-894	83209	89414	CAX-916	89405		CLT-109	G63614	
CAX-886	85014		CAX-894	85005	89430	CAX-921	83318		CLT-112	G63525	
CAX-886	89407		CAX-894	85013	89414	CAX-923	83102		CLT-113	G63524	
CAX-891	83215		CAX-894	89414		CAX-923	83456	89447	CLT-114	G63635	
CAX-891	85314	89425	CAX-894	89430		CAX-923	89447		CLT-116	G63902	
CAX-891	89425		CAX-898	83125		CAX-924	83317		CLT-124	G63610	

Muncie Reclamation

Muncie reclamation	Gabriel	Upgrade	Muncie reclamation	Gabriel	Upgrade	Muncie reclamation	Gabriel	Upgrade	Muncie reclamation	Gabriel	Upgrade
665459	89447		H53-21144-004	85045		MR1763	89419		MR3306	85705	89447
665568	85051		H5320415006	85051		MR1765	85713		MR3306	89447	
665569	85045		H5321144004	85045		MR25767	85702		MR6394	85723	
680334	85709		MR1623	85700		MR2960	85702		MR6535	85708	
97-2210-00164	85708		MR1710	85713		MR2996	85704		MR6536	85722	
97221000164	85708		MR1751	85713		MR3303	85709				
H53-20415-006	85051		MR1763	85300	89419	MR3304H	85709				

NAPA

Napa	Gabriel	Upgrade	Napa	Gabriel	Upgrade	Napa	Gabriel	Upgrade	Napa	Gabriel	Upgrade
LS56924	G56924		LS57000	G57000		LS57046	G57046		LS57085	G57085	
LS56925	G56925		LS57006	G57006		LS57047	G57047		LS57086	G57086	
LS56927	G56927		LS57007	G57007		LS57048	G57048		LS57087	G57087	
LS56928	G56928		LS57008	G57008		LS57049	G57049		LS57088	G57088	
LS56929	G56929		LS57010	G57010		LS57050	G57050		LS57089	G57089	
LS56930	G56930		LS57011	G57011		LS57051	G57051		LS57090	G57090	
LS56931	G56931		LS57012	G57012		LS57053	G57053		LS57091	G57091	
LS56932	G56932		LS57013	G57013		LS57054	G57054		LS57092	G57092	
LS56933	G56933		LS57014	G57014		LS57055	G57055		LS57095	G57095	
LS56934	G56934		LS57015	G57015		LS57056	G57056		LS57096	G57096	
LS56935	G56935		LS57016	G57016		LS57057	G57057		LS57097	G57097	
LS56936	G56936		LS57017	G57017		LS57058	G57058		LS57098	G57098	
LS56937	G56937		LS57018	G57018		LS57059	G57059		LS57099	G57099	
LS56938	G56938		LS57019	G57019		LS57060	G57060		LS57100	G57100	
LS56943	G56943		LS57020	G57020		LS57061	G57061		LS57103	G57103	
LS56948	G56948		LS57021	G57021		LS57062	G57062		LS57105	G57105	
LS56949	G56949		LS57022	G57022		LS57063	G57063		LS57106	G57106	
LS56950	G56950		LS57023	G57023		LS57064	G57064		LS57107	G57107	
LS56951	G56951		LS57026	G57026		LS57065	G57065		LS57108	G57108	
LS56956	G56956		LS57027	G57027		LS57066	G57066		LS57109	G57109	
LS56957	G56957		LS57030	G57030		LS57067	G57067		LS57110	G57110	
LS56962	G56962		LS57031	G57031		LS57068	G57068		LS57111	G57111	
LS56963	G56963		LS57032	G57032		LS57069	G57069		LS57112	G57112	
LS56964	G56964		LS57033	G57033		LS57070	G57070		LS57113	G57113	
LS56965	G56965		LS57034	G57034		LS57071	G57071		LS57114	G57114	
LS56973	G56973		LS57035	G57035		LS57072	G57072		LS57115	G57115	
LS56974	G56974		LS57036	G57036		LS57075	G57075		LS57118	G57118	
LS56975	G56975		LS57037	G57037		LS57076	G57076		LS57119	G57119	
LS56991	G56991		LS57038	G57038		LS57077	G57077		LS57120	G57120	
LS56992	G56992		LS57039	G57039		LS57078	G57078		LS57121	G57121	
LS56993	G56993		LS57040	G57040		LS57079	G57079		LS57122	G57122	
LS56994	G56994		LS57041	G57041		LS57080	G57080		LS57123	G57123	
LS56995	G56995		LS57042	G57042		LS57081	G57081				
LS56996	G56996		LS57043	G57043		LS57082	G57082				
LS56997	G56997		LS57044	G57044		LS57083	G57083				
LS56998	G56998		LS57045	G57045		LS57084	G57084				

Important Note: Competitive Interchanges are to be used for stocking purposes only. Where multiple crosses are identified, please reference the applications section of this catalog. / **Remarque importante:** Les interchanges concurrentiels ne s'utilisent qu'aux fins de stocks. Dans le cas de rferences multiples, consulter la section des applications du catalogue. / **Nota importante:** Dans le cas de rferences multiples, consulter la section des applications du catalogue. / **Nota importante:** Se pueden usar intercambios competitivos para propósitos de almacenamiento solamente. Cuando se identifican intercambios múltiples, consulte la sección de aplicaciones de este catálogo.

COMPETITIVE & O.E.M. INTERCHANGE LIST
Lista de Intercambios contra Competidores y Equipo Original.
Liste dinterchange de produits comptitifs & dquipement original (OEM)

NAPA... cont'd

Napa	Gabriel	Upgrade	Napa	Gabriel	Upgrade	Napa	Gabriel	Upgrade	Napa	Gabriel	Upgrade
LS57124	G57124		LS57201	G57201		LS57359	G57359		LS57465	G57465	
LS57125	G57125		LS57202	G57202		LS57360	G57360		LS57466	G57466	
LS57126	G57126		LS57203	G57203		LS57363	G57363		LS57473	G57473	
LS57127	G57127		LS57204	G57204		LS57364	G57364		LS57474	G57474	
LS57128	G57128		LS57205	G57205		LS57367	G57367		LS57479	G57479	
LS57129	G57129		LS57206	G57206		LS57368	G57368		LS57480	G57480	
LS57130	G57130		LS57207	G57207		LS57369	G57369		LS57481	G57481	
LS57131	G57131		LS57208	G57208		LS57370	G57370		LS57482	G57482	
LS57132	G57132		LS57212	G57212		LS57372	G57372		LS57483	G57483	
LS57133	G57133		LS57218	G57218		LS57373	G57373		LS57484	G57484	
LS57134	G57134		LS57219	G57219		LS57375	G57375		LS57489	G57489	
LS57135	G57135		LS57220	G57220		LS57376	G57376		LS57490	G57490	
LS57136	G57136		LS57221	G57221		LS57377	G57377		LS57493	G57493	
LS57137	G57137		LS57222	G57222		LS57378	G57378		LS57494	G57494	
LS57138	G57138		LS57223	G57223		LS57390	G57390		LS57495	G57495	
LS57139	G57139		LS57266	G57266		LS57391	G57391		LS57496	G57496	
LS57140	G57140		LS57267	G57267		LS57393	G57393		LS57497	G57497	
LS57141	G57141		LS57268	G57268		LS57394	G57394		LS57498	G57498	
LS57142	G57142		LS57269	G57269		LS57397	G57397		LS57499	G57499	
LS57144	G57144		LS57270	G57270		LS57398	G57398		LS57500	G57500	
LS57145	G57145		LS57271	G57271		LS57399	G57399		LS57515	G57515	
LS57146	G57146		LS57274	G57274		LS57400	G57400		LS57516	G57516	
LS57147	G57147		LS57275	G57275		LS57401	G57401		LS57517	G57517	
LS57148	G57148		LS57276	G57276		LS57404	G57404		LS57518	G57518	
LS57149	G57149		LS57277	G57277		LS57405	G57405		LS57521	G57521	
LS57150	G57150		LS57278	G57278		LS57409	G57409		LS57522	G57522	
LS57151	G57151		LS57279	G57279		LS57413	G57413		LS57535	G57535	
LS57152	G57152		LS57282	G57282		LS57414	G57414		LS57536	G57536	
LS57153	G57153		LS57314	G57314		LS57415	G57415		LS57539	G57539	
LS57156	G57156		LS57322	G57322		LS57416	G57416		LS57540	G57540	
LS57157	G57157		LS57323	G57323		LS57417	G57417		LS57541	G57541	
LS57158	G57158		LS57324	G57324		LS57418	G57418		LS57542	G57542	
LS57159	G57159		LS57329	G57329		LS57419	G57419		LS57543	G57543	
LS57160	G57160		LS57330	G57330		LS57420	G57420		LS57544	G57544	
LS57161	G57161		LS57331	G57331		LS57421	G57421		LS57545	G57545	
LS57162	G57162		LS57332	G57332		LS57422	G57422		LS57546	G57546	
LS57163	G57163		LS57333	G57333		LS57423	G57423		LS57549	G57549	
LS57164	G57164		LS57334	G57334		LS57424	G57424		LS57550	G57550	
LS57167	G57167		LS57335	G57335		LS57425	G57425		LS57560	G57560	
LS57168	G57168		LS57336	G57336		LS57427	G57427		LS57561	G57561	
LS57172	G57172		LS57337	G57337		LS57428	G57428		LS57562	G57562	
LS57173	G57173		LS57338	G57338		LS57429	G57429		LS57563	G57563	
LS57176	G57176		LS57339	G57339		LS57444	G57444		LS57564	G57564	
LS57177	G57177		LS57340	G57340		LS57447	G57447		LS57565	G57565	
LS57178	G57178		LS57341	G57341		LS57449	G57449		LS57566	G57566	
LS57184	G57184		LS57342	G57342		LS57450	G57450		LS57567	G57567	
LS57185	G57185		LS57343	G57343		LS57451	G57451		LS57572	G57572	
LS57190	G57190		LS57344	G57344		LS57452	G57452		LS57573	G57573	
LS57191	G57191		LS57345	G57345		LS57453	G57453		LS57577	G57577	
LS57192	G57192		LS57346	G57346		LS57454	G57454		LS57578	G57578	
LS57193	G57193		LS57349	G57349		LS57455	G57455		LS57579	G57579	
LS57194	G57194		LS57350	G57350		LS57456	G57456		LS57582	G57582	
LS57195	G57195		LS57353	G57353		LS57459	G57459		LS57583	G57583	
LS57197	G57197		LS57354	G57354		LS57460	G57460		LS57586	G57586	
LS57198	G57198		LS57357	G57357		LS57463	G57463		LS57587	G57587	
LS57200	G57200		LS57358	G57358		LS57464	G57464		LS57594	G57594	

Important Note: Competitive Interchanges are to be used for stocking purposes only. Where multiple crosses are identified, please reference the applications section of this catalog./ **Remarque importante:** Les interchanges concurrentiels ne s'utilisent qu'aux fins de stocks. Dans le cas de rfrences multiples, consulter la section des applications du catalogue./ **Nota importante:** Dans le cas de rfrences multiples, consulter la section des applications du catalogue./ **Nota importante:** Se pueden usar intercambios competitivos para propósitos de almacenamiento solamente. Cuando se identifican intercambios múltiples, consulte la sección de aplicaciones de este catálogo.

COMPETITIVE & O.E.M. INTERCHANGE LIST
Lista de Intercambios contra Competidores y Equipo Original.
Liste dinterchange de produits comptitifs & dquipement original (OEM)

NAPA... cont'd

Napa	Gabriel	Upgrade	Napa	Gabriel	Upgrade	Napa	Gabriel	Upgrade	Napa	Gabriel	Upgrade
LS57595	G57595		SH511134	G511134		SH81394	81394		SH81905	81905	
LS57597	G57597		SH51807	G51807		SH81416	81416		SH81910	81910	
LS57598	G57598		SH51874	G51874		SH81440	81440		SH81911	81911	
LS57603	G57603		SH61506	61506		SH81446	81446		SH81912	81912	
LS57604	G57604		SH61546	61546		SH81469	81469		SH81913	81913	
LS57605	G57605		SH61582	61582		SH81478	81478		SH81914	81914	
LS57606	G57606		SH61614	61614		SH81481	81481		SH81916	81916	
LS57607	G57607		SH61654	61654		SH81482	81482		SH81917	81917	
LS57612	G57612		SH61655	61655		SH81484	81484		SH81918	81918	
LS57613	G57613		SH61656	61656		SH81490	81490		SH81919	81919	
LS57628	G57628		SH61662	61662		SH81491	81491		SH81920	81920	
LS57629	G57629		SH61704	61704		SH81492	81492		SH81921	81921	
LS57634	G57634		SH61712	61712		SH81494	81494		SH81922	81922	
LS57635	G57635		SH61715	61715		SH81495	81495		SH81923	81923	
LS57644	G57644		SH61717	61717		SH81496	81496		SH81924	81924	
LS57645	G57645		SH61720	61720		SH81507	81507		SH81925	81925	
LS57646	G57646		SH63614	G63614		SH81510	81510		SH81926	81926	
LS57648	G57648		SH63692	G63692		SH81516	81516		SH81928	81928	
LS57649	G57649		SH63720	G63720		SH81540	81540		SH81929	81929	
LS57658	G57658		SH63726	G63726		SH81548	81548		SH81930	81930	
LS57659	G57659		SH63781	G63781		SH81549	81549		SH81931	81931	
LS57663	G57663		SH63782	G63782		SH81553	81553		SH81932	81932	
LS57664	G57664		SH63809	G63809		SH81559	81559		SH81933	81933	
LS57665	G57665		SH63837	G63837		SH81560	81560		SH81934	81934	
LS57666	G57666		SH63844	G63844		SH81582	81582		SH81935	81935	
LS57673	G57673		SH63862	G63862		SH81583	81583		SH81936	81936	
LS57674	G57674		SH63879	G63879		SH81667	81667		SH81937	81937	
LS57675	G57675		SH63884	G63884		SH81668	81668		SH82001	82001	
LS57676	G57676		SH63892	G63892		SH81675	81675		SH82003	82003	
LS57677	G57677		SH64027	G64027		SH81676	81676		SH82004	82004	
LS57680	G57680		SH64028	G64028		SH81691	81691		SH82005	82005	
LS57682	G57682		SH64040	G64040		SH81710	81710		SH82007	82007	
LS57697	G57697		SH64042	G64042		SH81713	81713		SH82010	82010	
LS57698	G57698		SH64043	G64043		SH81726	81726		SH82011	82011	
LS57701	G57701		SH69473	69473		SH81730	81730		SH82012	82012	
LS57702	G57702		SH69575	69575		SH81744	81744		SH82025	82025	
LS57704	G57704		SH69587	69587		SH81750	81750		SH82026	82026	
LS57705	G57705		SH69589	69589		SH81794	81794		SH82032	82032	
LS57722	G57722		SH69590	69590		SH81821	81821		SH82034	82034	
LS57723	G57723		SH69592	69592		SH81825	81825		SH82035	82035	
LS57732	G57732		SH69909	69909		SH81828	81828		SH82039	82039	
LS57733	G57733		SH70010	70010		SH81833	81833		SH82040	82040	
LS57752	G57752		SH70102	70102		SH81834	81834		SH82047	82047	
LS57753	G57753		SH81039	81039		SH81836	81836		SH82051	82051	
LS57772	G57772		SH81076	81076		SH81837	81837		SH82060	82060	
LS57773	G57773		SH81082	81082		SH81869	81869		SH82065	82065	
LS57784	G57784		SH81091	81091		SH81870	81870		SH82066	82066	
LS57785	G57785		SH81095	81095		SH81871	81871		SH82069	82069	
LS57786	G57786		SH81096	81096		SH81873	81873		SH82070	82070	
LS57792	G57792		SH81113	81113		SH81878	81878		SH82072	82072	
LS57793	G57793		SH81147	81147		SH81880	81880		SH82075	82075	
LS57794	G57794		SH81153	81153		SH81890	81890		SH82076	82076	
LS57795	G57795		SH81164	81164		SH81891	81891		SH82079	82079	
LS57796	G57796		SH81242	81242		SH81892	81892		SH82086	82086	
LS57800	G57800		SH81318	81318		SH81893	81893		SH82087	82087	
LS57801	G57801		SH81340	81340		SH81904	81904		SH82090	82090	

Important Note: Competitive Interchanges are to be used for stocking purposes only. Where multiple crosses are identified, please reference the applications section of this catalog. / **Remarque importante:** Les interchanges concurrentiels ne s'utilisent qu'aux fins de stocks. Dans le cas de références multiples, consulter la section des applications du catalogue. / **Nota importante:** Dans le cas de referencias multiples, consultar la sección de aplicaciones del catálogo. / **Nota importante:** Se pueden usar intercambios competitivos para propósitos de almacenamiento solamente. Cuando se identifican intercambios múltiples, consulte la sección de aplicaciones de este catálogo.

COMPETITIVE & O.E.M. INTERCHANGE LIST
Lista de Intercambios contra Competidores y Equipo Original.
Liste dinterchange de produits comptitifs & dquipement original (OEM)

NAPA... cont'd

Napa	Gabriel	Upgrade	Napa	Gabriel	Upgrade	Napa	Gabriel	Upgrade	Napa	Gabriel	Upgrade
SH82099	82099		ST51728	G51728		ST55551	G55551		ST56620	G56620	
SH82103	82103		ST51736	G51736		ST55591	G55591		ST56621	G56621	
SH82104	82104		ST51738	G51738		ST55661	G55661		ST56622	G56622	
SH82109	82109		ST51739	G51739		ST55662	G55662		ST56640	G56640	
SH82110	82110		ST51758	G51758		ST55675	G55675		ST56641	G56641	
SH82118	82118		ST51760	G51760		ST55676	G55676		ST56660	G56660	
SH82125	82125		ST51761	G51761		ST55681	G55681		ST56661	G56661	
SH82126	82126		ST51765	G51765		ST55697	G55697		ST56671	G56671	
SH82128	82128		ST51815	G51815		ST55698	G55698		ST56672	G56672	
SH82130	82130		ST51842	G51842		ST55804	G55804		ST56687	G56687	
SH82131	82131		ST51859	G51859		ST55820	G55820		ST56688	G56688	
SH82138	82138		ST51860	G51860		ST55821	G55821		ST56700	G56700	
SH82147	82147		ST51861	G51861		ST55825	G55825		ST56718	G56718	
SH82151	82151		ST51864	G51864		ST55856	G55856		ST56721	G56721	
SH82155	82155		ST51870	G51870		ST55892	G55892		ST56722	G56722	
SH82156	82156		ST51877	G51877		ST55896	G55896		ST56728	G56728	
SH82601	82601		ST51878	G51878		ST55901	G55901		ST56729	G56729	
SH82602	82602		ST51891	G51891		ST55948	G55948		ST56730	G56730	
SH82609	82609		ST52004	G52004		ST55949	G55949		ST56731	G56731	
SH82615	82615		ST52005	G52005		ST55993	G55993		ST56758	G56758	
SH82618	82618		ST52006	G52006		ST55994	G55994		ST56759	G56759	
ST51077	G51077		ST52007	G52007		ST55999	G55999		ST56773	G56773	
ST51087	G51087		ST52008	G52008		ST56506	G56506		ST56774	G56774	
ST51267	G51267		ST52009	G52009		ST56509	G56509		ST56797	G56797	
ST51477	G51477		ST52013	G52013		ST56514	G56514		ST56798	G56798	
ST51700	G51700		ST52014	G52014		ST56516	G56516		ST56799	G56799	
ST51703	G51703		ST52026	G52026		ST56517	G56517		ST56800	G56800	
ST51704	G51704		ST52027	G52027		ST56539	G56539		ST56807	G56807	
ST51714	G51714		ST52081	G52081		ST56540	G56540		ST56809	G56809	
ST51715	G51715		ST52082	G52082		ST56561	G56561		ST56810	G56810	
ST51716	G51716		ST52094	G52094		ST56562	G56562		ST56836	G56836	
ST51718	G51718		ST52095	G52095		ST56568	G56568		ST56837	G56837	
ST51722	G51722		ST52121	G52121		ST56581	G56581		ST56886	G56886	
ST51723	G51723		ST52122	G52122		ST56582	G56582		ST56887	G56887	
ST51724	G51724		ST52125	G52125		ST56601	G56601		ST56899	G56899	
ST51727	G51727		ST52131	G52131		ST56606	G56606				

National RV Inc.

National rv inc.	Gabriel	Upgrade	National rv inc.	Gabriel	Upgrade	National rv inc.	Gabriel	Upgrade	National rv inc.	Gabriel	Upgrade
1C34-18045-AA	83209	89414	9U9Z-18125-A	89406		ASH-25822	83209	89414	AT-620	89414	
1C34-18045-AA	89414		9U9Z18125A	83122	89406	ASH-25822	89414		AT-621	83122	89406
1C34-18045-JA	83209	89414	9U9Z18125A	89406		ASH-25823	83209	89414	AT-621	89406	
1C34-18045-JA	89414		ASH-1022	83209	89414	ASH-25823	89414		AT-766	83209	89414
24-153249	85125		ASH-1022	89414		ASH-25824	83122	89406	AT-766	89414	
24-153256	85124		ASH-1023	83122	89406	ASH-25824	89406		AT621	83122	89406
24-186629	85125		ASH-1023	89406		ASH-294	83209	89414	AT621	89406	
24153249	85125		ASH-1205	83209	89414	ASH-294	89414		C800853	83207	89407
24153256	85124		ASH-1205	89414		ASH1023	83122	89406	C800853	89407	
24186629	85125		ASH-1206	83122	89406	ASH1023	89406		F4-BE5-A832-MO	85125	
9U94-18045-AA	83209	89414	ASH-1206	89406		ASH1206	83122	89406	F4-BE5-B492-HO	85125	
9U94-18045-AA	89414		ASH-1228	83209	89414	ASH1206	89406		F4-BE5-F324-HO	85125	
9U94-18080-AA	83122	89406	ASH-1228	89414		ASH1230	83122	89406	F4-BE5-F325-HO	85124	
9U94-18080-AA	89406		ASH-1229	83209	89414	ASH1230	89406		F4BE5A832MO	85125	
9U9418080AA	83122	89406	ASH-1229	89414		ASH137	83122	89406	F4BE5B492HO	85125	
9U9418080AA	89406		ASH-1230	83122	89406	ASH137	89406				
9U9Z-18124-A	83209	89414	ASH-1230	89406		ASH25824	83122	89406			
9U9Z-18124-A	89414		ASH-137	83122	89406	ASH25824	89406				
9U9Z-18125-A	83122	89406	ASH-137	89406		AT-620	83209	89414			

Important Note: Competitive Interchanges are to be used for stocking purposes only. Where multiple crosses are identified, please reference the applications section of this catalog. / **Remarque importante:** Les interchanges concurrentiels ne s'utilisent qu'aux fins de stocks. Dans le cas de rfrences multiples, consulter la section des applications du catalogue. / **Nota importante:** Dans le cas de rfrences multiples, consulte la section des aplicaciones del catalogo. / **Nota importante:** Se pueden usar intercambios competitivos para propósitos de almacenamiento solamente. Cuando se identifican intercambios múltiples, consulte la sección de aplicaciones de este catálogo.

COMPETITIVE & O.E.M. INTERCHANGE LIST

Lista de Intercambios contra Competidores y Equipo Original.

Liste d'interchange de produits compétitifs & d'équipement original (OEM)

National RV Inc.... cont'd

National rv inc.	Gabriel	Upgrade	National rv inc.	Gabriel	Upgrade	National rv inc.	Gabriel	Upgrade	National rv inc.	Gabriel	Upgrade
F4BE5F324HO	85125		W0005662	85125		W0006254	85125				
F4BE5F325HO	85124		W0005663	85124							

Neoplan Bus

Neoplan bus	Gabriel	Upgrade	Neoplan bus	Gabriel	Upgrade	Neoplan bus	Gabriel	Upgrade	Neoplan bus	Gabriel	Upgrade
24-1700-106-149	83216		AA1002002	85705	89447	AC1002003	85705	89447	DZ1002002	85705	89447
24-1700-999-362	85009		AA1002002	89447		AC1002003	89447		DZ1002002	89447	
241700106149	83216		AA1002003	85705	89447	BN1002002	85009		GJ1002003	85705	89447
241700999362	85009		AA1002003	89447		BT1002011	83216		GJ1002003	89447	
25-1700-101-426	85705	89447	AA1802002	85705	89447	CI 1002003	85705	89447	MM1002002	85705	89447
25-1700-101-426	89447		AA1802002	89447		CI 1002003	89447		MM1002002	89447	
251700101426	85705	89447	AC1002002	85705	89447	CL1002003	85705	89447	MM1002003	85705	89447
251700101426	89447		AC1002002	89447		CL1002003	89447		MM1002003	89447	
680307	85705	89447	AC1002002GS	85705	89447	DT1802002	85705	89447			
680307	89447		AC1002002GS	89447		DT1802002	89447				

New Flyer

New flyer	Gabriel	Upgrade	New flyer	Gabriel	Upgrade	New flyer	Gabriel	Upgrade	New flyer	Gabriel	Upgrade
009863	85722		152959	85708		68037840B	85720		69536140Y	87016	
015813	85708		6322882	85713		68050440X	85716		69536640Y	85732	
015915	85711		68027440Y	85716		68050640Y	85732		97-2210-00164	85708	
016415	85722		680346	85722		680671	85708		97221000164	85708	
064845	85711		680352	85711		690102	85711				

Newmar Corp.

Newmar corp.	Gabriel	Upgrade	Newmar corp.	Gabriel	Upgrade	Newmar corp.	Gabriel	Upgrade	Newmar corp.	Gabriel	Upgrade
141700131809	85029		1616736000	85029		90045455	85909		ASH-25823	89414	
141700131810	83160		1616737000	83160		ASH-1229	83209	89414	ASH-25824	83122	89406
16-16736-000	85029		1616874000	83160		ASH-1229	89414		ASH-25824	89406	
16-16737-000	83160		1618103000	85900		ASH-25822	83209	89414	ASH25824	83122	89406
16-16874-000	83160		481700000490	85900		ASH-25822	89414		ASH25824	89406	
16-18103-000	85900		481700000493	85900		ASH-25823	83209	89414			

Nexus RV

Nexus rv	Gabriel	Upgrade	Nexus rv	Gabriel	Upgrade	Nexus rv	Gabriel	Upgrade	Nexus rv	Gabriel	Upgrade
ASH-1136	G63623		ASH-25822	83209	89414	ASH-25824	83122	89406	ASH25824	89406	
ASH-1154	G63622		ASH-25822	89414		ASH-25824	89406				
ASH-1229	83209	89414	ASH-25823	83209	89414	ASH1154	G63622				
ASH-1229	89414		ASH-25823	89414		ASH25824	83122	89406			

Nissan

Nissan	Gabriel	Upgrade	Nissan	Gabriel	Upgrade	Nissan	Gabriel	Upgrade	Nissan	Gabriel	Upgrade
54302-4W925	G56688		54303-8J025	G56671		56110-1Z626	G63813		56110-8Z625	G63813	
54302-4W926	G56688		54303-8J026	G56671		56110-1Z627	G63813		56110-8Z825	G63813	
54302-4W985	G56616		54303-8J127	G56671		56110-1Z628	G63813		56110-8Z826	G63813	
54302-5Z025	G52033		54303-9PB0A	G52524		56110-30Z02	G63610		56110-8Z828	G63813	
54302-5Z026	G52033		54303-CA025	G52008		56110-3S526	G63909		56110-9Z325	G63813	
54302-7Y426	G56672		54303-CA125	G52008		56110-3S527	G63813		56110-9Z425	G63813	
54302-8J025	G56672		54303-CB125	G52008		56110-4S125	G63813		56110-CD027	G51814	
54302-8J026	G57030		54303-EJ026	G57031		56110-7S026	G51715		56110-CD028	G51813	
54302-8J127	G56672		54303-ZB125	G56671		56110-7S125	G51715		56110-EA025	G51765	
54302-9PB0A	G52525		54322-4U01A	142937		56110-7S126	G51715		56110-EA026	G51765	
54302-CA025	G52009		54322-CG00A	142937		56110-7S225	G51715		56110-EA027	G51765	
54302-CA125	G52009		56100-ZP02A	G51766		56110-7S226	G51715		56110-EA028	G51765	
54302-CB125	G52009		56101-30Z02	G63610		56110-7S325	G51715		56110-EA525	G51765	
54302-ZB125	G56672		56101-Z5008	83114		56110-7S326	G51715		56110-EA526	G51765	
54303-4W925	G56687		56101-Z5014	83162		56110-7Z025	G63813		56110-EA825	G51766	
54303-4W926	G56687		56101-Z5017	83162		56110-7Z225	G63813		56110-EB025	G51766	
54303-4W985	G56615		56101Z5008	83114		56110-8Z425	G63813				
54303-5Z025	G52032		56101Z5014	83162		56110-8Z426	G63813				
54303-5Z026	G52032		56101Z5017	83162		56110-8Z427	G63813				
54303-7Y426	G56671		56110-01G27	G63909		56110-8Z428	G63813				

Important Note: Competitive Interchanges are to be used for stocking purposes only. Where multiple crosses are identified, please reference the applications section of this catalog. / **Remarque importante:** Les interchanges concurrentiels ne s'utilisent qu'aux fins de stocks. Dans le cas de références multiples, consulter la section des applications du catalogue. / **Nota importante:** Dans le cas de referencias multiples, consultar la sección de aplicaciones del catálogo. / **Nota importante:** Se pueden usar intercambios competitivos para propósitos de almacenamiento solamente. Cuando se identifican intercambios múltiples, consulte la sección de aplicaciones de este catálogo.

COMPETITIVE & O.E.M. INTERCHANGE LIST
Lista de Intercambios contra Competidores y Equipo Original.
Liste dinterchange de produits comptitifs & dquipement original (OEM)

Nissan... cont'd

Nissan	Gabriel	Upgrade	Nissan	Gabriel	Upgrade	Nissan	Gabriel	Upgrade	Nissan	Gabriel	Upgrade
56110-EG025	G51925		56200-ZC00A	G63875		E4302-JA12A	G52122		E4303-JB12A	G52121	
56110-F400A	G63902		56200-ZP025	G64031		E4302-JB12A	G52122		E4303-JB12B	G52121	
56110-T8123	G63432		56200-ZR00A	G63878		E4302-JB12B	G52122		E4303-JM00A	G52173	
56110-T8129	G63432		56200-ZV50A	G63875		E4302-JM00A	G52174		E4303-ZB02B	G57031	
56110-Z5008	83114		56200-ZV60A	G63875		E4302-ZB02B	G57030		E4303-ZB03A	G57031	
56110-Z5011	G63610		56200-ZZ90A	G63875		E4302-ZB03B	G57030		E4303-ZB03B	G56671	
56110-Z5014	83162		56210-10G27	G63907		E4302-ZB70A	G57030		E4303-ZB70A	G57031	
56110-Z5017	83162		56210-31U25	G51087		E4302-ZJ60A	G52095		E4303-ZJ60A	G52094	
56110-ZC00A	G51715		56210-31U27	G51087		E4302-ZM70A	G52033		E4303-ZM70A	G52032	
56110-ZC025	G51715		56210-43U27	G51087		E4302-ZX00A	G52122		E4303-ZX00A	G52121	
56110-ZC085	G51715		56210-5Y025	G51727		E4302-ZX10A	G52122		E4303-ZX10A	G52121	
56110-ZP025	G51766		56210-5Y026	G51727		E43021-AA0B	G52171		E4C02-1AA0J-NW	G52171	
56110T8123	G63432		56210-5Z025	G51803		E43021-AA0C	G52171		E4C02-4W92J-NW	G56616	
56110T8129	G63432		56210-5Z026	G51803		E43021-AA0D	G52171		E4C02-7Y42J-NW	G56672	
56110Z5008	83114		56210-6Y325	G51727		E43021-AA0F	G52171		E4C02-CA02J-NW	G52009	
56110Z5014	83162		56210-6Y425	G51727		E43021-AA1A	G52171		E4C02-ET81J-NW	G52095	
56110Z5017	83162		56210-7Y027	G51802		E43021-AA1B	G52171		E4C02-JA02J-NW	G52122	
56111-EG025	G51926		56210-7Y427	G51802		E43021-AA1C	G52171		E4C02-JM00J-NW	G52174	
56200-0B027	G63299		56210-CA025	G51798		E4303-1AA0B	G52170		E4C02-ZM70J-NW	G52033	
56200-0B028	G63299		56210-CA026	G51798		E4303-1AA0C	G52170		E4C03-1AA0J-NW	G52170	
56200-1B026	G63299		56210-CB025	G51798		E4303-1AA0D	G52170		E4C03-4W92J-NW	G56615	
56200-1W225	G63712		56210-CB026	G51798		E4303-1AA0F	G52170		E4C03-7Y42J-NW	G56671	
56200-1Z625	61506		56210-CB825	G51798		E4303-1AA1A	G52170		E4C03-CA02J-NW	G52008	
56200-1Z626	61506		56210-Z6003	85308	89422	E4303-1AA1B	G52170		E4C03-ET81J-NW	G52094	
56200-2Z325	G63299		56210-Z6003	89422		E4303-1AA1C	G52170		E4C03-JA02J-NW	G52121	
56200-6B025	G63299		56210Z6003	85308	89422	E4303-1JA0B	G52355		E4C03-JM00J-NW	G52173	
56200-7B025	G63299		56210Z6003	89422		E4303-1JA0B	G52356		E4C03-ZM70J-NW	G52032	
56200-7B085	G63299		56217-61L10	142547		E4303-1JA0C	G52356		E6110-4KH4A	G51766	
56200-7S023	G63875		56218-61L10	142547		E4303-1JA0J-NW	G52355		E6110-9FE0A	G51715	
56200-7S225	G63883		66400	G63432		E4303-3KA0A	G52524		E6110-9FE0B	G51715	
56200-7S226	G63883		E4302-1JA0C	G52355		E4303-3NA0C	G52524		E6110-9FE1B	G51715	
56200-7S325	G63878		E4302-1JA0J-NW	G52356		E4303-3NF1A	G52524		E6110-9FE4A	G51715	
56200-7S326	G63878		E4302-3KA0A	G52525		E4303-3W485	G56615		E6110-9FE4B	G51715	
56200-7Z025	61506		E4302-3W485	G56616		E4303-4BA1C	G52411		E6110-9FG0A	G51715	
56200-7Z225	61506		E4302-4BA1C	G52410		E4303-4BF1C	G52411		E6110-CD02J-NW	G51814	
56200-7Z285	61506		E4302-4BF1C	G52410		E4303-4W92J-NW	G56687		E6110-EB025	G51766	
56200-8Z425	61506		E4302-4W92J-NW	G56688		E4303-7Y01B	G56671		E6110-ZL10A	G51765	
56200-8Z625	61506		E4302-7Y01B	G56672		E4303-9DA0A	G52382		E6110-ZL40A	G51766	
56200-8Z825	61506		E4302-9DA0A	G52383		E4303-9DA0J-NW	G52382		E6110-ZL60A	G51766	
56200-8Z826	61506		E4302-9DA0J-NW	G52383		E4303-9DC0A	G52382		E6110-ZL60J	G51766	
56200-8Z827	61506		E4302-9DC0A	G52383		E4303-9DF0C	G52382		E6110-ZP02A	G51766	
56200-9FF0B	G63883		E4302-9DF0C	G52383		E4303-9N00D	G52382		E6110-ZP90A	G51766	
56200-9FG0A	G63878		E4302-9N20D	G52383		E4303-9N20D	G52382		E6110-ZQ00C	G51715	
56200-9FG0B	G63878		E4302-9PB0A	G52525		E4303-9PB0A	G52524		E6110-ZQ20C	G51715	
56200-9Z825	61506		E4302-9PB0B	G52525		E4303-CB00J	G52008		E6110-ZR00A	G51715	
56200-EA025	69594		E4302-CB00J	G52009		E4303-CB025	G52008		E6110-ZR00B	G51715	
56200-EA026	69594		E4302-CB025	G52009		E4303-CB10A	G52008		E6110-ZR01B	G51715	
56200-EA027	69594		E4302-CB10A	G52009		E4303-ET00B	G52094		E6110-ZR40A	G51715	
56200-EA285	69595		E4302-ET00B	G52095		E4303-ET02B	G52094		E6110-ZR40B	G51715	
56200-EA286	69595		E4302-ET02B	G52095		E4303-ET81A	G52094		E6110-ZR50A	G51715	
56200-EA287	69595		E4302-ET81A	G52095		E4303-ET81B	G52094		E6110-ZR51A	G51715	
56200-EA525	G64033		E4302-ET81B	G52095		E4303-ET82B	G52094		E6110-ZS30A	G51765	
56200-EA585	G64033		E4302-ET82B	G52095		E4303-JA01B	G52121		E6110-ZS60A	G51765	
56200-EB025	G64031		E4302-JA01B	G52122		E4303-JA02A	G52121		E6110-ZZ50A	G51715	
56200-EB085	G64031		E4302-JA02A	G52122		E4303-JA11A	G52121		E6110-ZZ50B	G51715	
56200-F400A	G63907		E4302-JA11A	G52122		E4303-JA12A	G52121		E6110-ZZ51A	G51715	

Important Note: Competitive Interchanges are to be used for stocking purposes only. Where multiple crosses are identified, please reference the applications section of this catalog./ **Remarque importante:** Les interchanges concurrentiels ne s'utilisent qu'aux fins de stocks. Dans le cas de rferences multiples, consulter la section des applications du catalogue./ **Nota importante:** Dans le cas de rferences multiples, consultar la section des aplicaciones du catalogue./ **Nota importante:** Se pueden usar intercambios competitivos para propósitos de almacenamiento solamente. Cuando se identifican intercambios múltiples, consulte la sección de aplicaciones de este catálogo.

COMPETITIVE & O.E.M. INTERCHANGE LIST
Lista de Intercambios contra Competidores y Equipo Original.
Liste dinterchange de produits comptitifs & dquipement original (OEM)

Nissan... cont'd

Nissan	Gabriel	Upgrade	Nissan	Gabriel	Upgrade	Nissan	Gabriel	Upgrade	Nissan	Gabriel	Upgrade
E6110-ZZ51B	G51715		E6200-ZR40B	G63878		E6210-9AM0A	G511044		E6A10-EG00D	G51926	
E6200-0W025	G63712		E6200-ZR50A	G63878		E6210-9AN0A	G511044		E6A11-EG00D	G51925	
E6200-1PA0D	G64164		E6200-ZR51A	G63878		E6210-9KN0A	G51990		E6B00-0W02J-NW	G63712	
E6200-1PA1A	G64164		E6200-ZS61B	G64033		E6210-9LE0B	G51990		E6B00-1B02J-NW	G63299	
E6200-1PB0A	G64164		E6200-ZV90B	70041		E6210-9MB0A	G51990		E6B00-1Z62J-NW	G63492	
E6200-2W525	G63845		E6200-ZV9XB	70041		E6210-9N60B	70089		E6B00-4W02J-NW	G63845	
E6200-4W000	G63845		E6210-1AA0B	G51884		E6210-9N60J-NW	70089		E6B00-7S22J-NW	G63883	
E6200-4W025	G63845		E6210-1AA0C	G51884		E6210-9NF0A	G511043		E6B00-7S32J-NW	G63878	
E6200-9FF0A	G63883		E6210-1AA1A	G51884		E6210-CB800	G51798		E6B00-EA02J-NW	69595	
E6200-9FF0B	G63883		E6210-1HKXB	G51990		E6210-EM30C	70041		E6B00-EA28J-NW	69594	
E6200-9FG0A	G63878		E6210-1TZ0A	G51884		E6210-JA00D	G51874		E6B00-EB02J-NW	G64031	
E6200-9FG0B	G63878		E6210-1TZ0B	G51884		E6210-JA01A	G51874		E6B00-ZC01J-NW	G63875	
E6200-9FG1A	G63878		E6210-3AN0C	G51990		E6210-JA11A	G51874		E6B10-10G2J-NW	G63907	
E6200-ET000	70027		E6210-3JA0B	G511043		E6210-JA12D	G51874		E6B10-1AA1J-NW	G51884	
E6200-ET80A	70027		E6210-3JV0B	G511043		E6210-JA80B	G51874		E6B10-31U2J-NW	G51087	
E6200-ET81B	70027		E6210-3KA0A	G511043		E6210-JM01A	G64050		E6B10-6Y42J-NW	G51727	
E6200-EZ71B	G63878		E6210-3LM0B	G64146		E6210-ZM70A	G51803		E6B10-7Y02J-NW	G51802	
E6200-EZ81A	G63878		E6210-3LNOA	G64146		E6210-ZX00A	G51874		E6B10-CA02J-NW	G51798	
E6200-ZJ60A	70027		E6210-3LNOJ-NW	G64146		E6210-ZX10A	G51874		E6B10-EL00A	70041	
E6200-ZL02A	G64031		E6210-3SH0C	G511044		E6A10-01G2J-NW	G63909		E6B10-JA01J-NW	G51874	
E6200-ZL10A	G64033		E6210-3TA1B	G51874		E6A10-1Z62J-NW	G63813		E6B10-JM01J-NW	G64050	
E6200-ZL40A	G64031		E6210-4AF0A	G511044		E6A10-7S32J-NW	G51715		E6B10-ZM70J-NW	G51803	
E6200-ZL60A	G64031		E6210-4BA0C	G64050		E6A10-CD02J-NW	G51813		E6B1M-EL00J-NW	70041	
E6200-ZN90A	70041		E6210-4BA1C	G64050		E6A10-CD70A	G51814		E6B20-EA52J-NW	G64033	
E6200-ZP50A	G64031		E6210-5AA0C	G51884		E6A10-CD70B	G51813		E6B20-ET00J-NW	70027	
E6200-ZR00B	G63883		E6210-5HA0B	G64050		E6A10-EA02J-NW	G51765				
E6200-ZR40A	G63878		E6210-5Y025	G51727		E6A10-EA82J-NW	G51766				

Nova Bus

Nova bus	Gabriel	Upgrade	Nova bus	Gabriel	Upgrade	Nova bus	Gabriel	Upgrade	Nova bus	Gabriel	Upgrade
12J-5-10	85733		680323	85700		97220100151	85700		G1203223	85702	
12J510	85733		680326	85700		97999902514	85700		G5008070	85700	
22045526	85702		680470	85713		G1011822	85702		N22212	85700	
22052014	85702		97-2201-00151	85700		G1101590	85713		OE 10086S	85702	
680232	85733		97-9999-02514	85700		G1201339	85702				

O'Reilly

O'reilly	Gabriel	Upgrade	O'reilly	Gabriel	Upgrade	O'reilly	Gabriel	Upgrade	O'reilly	Gabriel	Upgrade
181674	G57559		20751	81147		31542	82001		32143	82040	
181675	G57558		20766	81744		32022	82090		32164	61519	
20400	81870		20778	81730		32066	61509		32164	81484	
20407	81548		20778	81917		32066	61529		32186	81482	
20408	81890		20779	81540		32066	61555		32194	61531	
20418	81726		20779	81905		32066	81446		32196	61615	
20433	81928		20779	81918		32066	82110		32197	81549	
20444	81878		20801	81541		32067	82601		32206	61501	
20452	81750		20801	81713		32073	82131		32206	61662	
20701	81516		20801	82099		32075	61521		32207	82007	
20704	81242		20802	81492		32080	61518		32212	61539	
20711	81113		20851	81318		32103	82130		32215	81560	
20713	81164		23073	81394		32112	81095		32217	61508	
20718	81039		31000	61506		32113	81507		32217	61593	
20719	81496		31000	82156		32118	82128		32217	81553	
20721	81478		31029	81675		32126	81340		32219	81691	
20722	81676		31094	61500		32126	81440		32220	61541	
20744	81668		31125	82125		32126	82039				
20745	81667		31131	61632		32126	82155				
20747	81490		31131	81469		32132	81494				
20748	81710		31538	82005		32132	81582				

Important Note: Competitive Interchanges are to be used for stocking purposes only. Where multiple crosses are identified, please reference the applications section of this catalog. / **Remarque importante:** Les interchanges concurrentiels ne s'utilisent qu'aux fins de stocks. Dans le cas de rferences multiples, consulter la section des applications du catalogue. / **Nota importante:** Dans le cas de rferences multiples, consulter la section des applications du catalogue. / **Nota importante:** Se pueden usar intercambios competitivos para propósitos de almacenamiento solamente. Cuando se identifican intercambios múltiples, consulte la sección de aplicaciones de este catálogo.

COMPETITIVE & O.E.M. INTERCHANGE LIST
Lista de Intercambios contra Competidores y Equipo Original.
Liste dinterchange de produits comptitifs & dquipement original (OEM)

O'Reilly... cont'd

O'reilly	Gabriel	Upgrade	O'reilly	Gabriel	Upgrade	O'reilly	Gabriel	Upgrade	O'reilly	Gabriel	Upgrade
32220	81583		32304	81914		32DG1101	G57178		33BW1101	G57363	
32224	61544		32305	61612		32FD1100	G57427		33BW1104	G57363	
32225	61543		32305	81913		32FD1101	G57148		33BW1105	G57364	
322268	61646		32306	61616		32GM1106	G57282		33CH1102	G57026	
32227	61520		32316	61560		32HN1100	G57032		33CH1103	G57071	
32228	61554		32316	81904		32HN1100	G57062		33CH1103	G57072	
32231	81082		32318	61512		32HN1103	G57033		33CH1105	G56964	
32235	61561		32318	81559		32HN1103	G57061		33CH1106	G56965	
32237	61533		32321	61658		32HN1105	G57424		33CH1109	G56963	
32237	61627		32321	81923		32HN1106	G57425		33CH1110	G56962	
32238	61573		32322	61614		32HN1107	G56996		33CH1111	G57206	
32238	61629		32325	61530		32HN1108	G56997		33CH1112	G57206	
32245	61552		32326	61641		32HN1109	G56998		33CH1113	G57466	
32247	81871		32326	81920		32HN1161	G56994		33CH1114	G57465	
32250	61601		32326	81921		32HN1162	G56993		33CH1124	G57466	
32250	61679		32328	61643		32HN1163	G56995		33CH1124	G57578	
32250	81836		32329	61642		32JP1106	G57607		33CH1125	G57465	
32251	61584		32330	61626		32MZ1100	G57270		33CH1125	G57577	
32251	81837		32330	81916		32MZ1101	G57456		33CH4111	G57206	
32252	61535		32333	81924		32MZ1101	G57595		33DG1102	G57146	
32253	61590		32335	81910		32MZ1102	G57455		33DG1103	G57053	
32253	61624		32337	81911		32MZ1102	G57594		33DG1104	G57147	
32258	61556		32338	61664		32NS1100	G57057		33DG1105	G57266	
32259	61591		32338	81869		32NS1100	G57058		33DG1106	G57267	
32262	81872		32339	61676		32SB1100	G57423		33DG1111	G57071	
32263	61542		32339	81926		32TY1100	G57134		33FD1102	G57080	
32265	61687		32350	61663		32TY1101	G57133		33FD1103	G57095	
32266	61565		32350	81925		32TY1102	G57010		33FD1104	G57064	
32268	61595		32357	61654		32TY1103	G57066		33FD1105	G57063	
32268	81828		32358	61655		32TY1104	G57065		33FD1106	G57019	
32269	61575		32359	61656		32TY1105	G57010		33FD1108	G57021	
32269	81891		32362	61685		32TY1106	G57027		33FD1109	G57103	
32270	61582		32366	61635		32TY1107	G57027		33FD1110	G57020	
32272	61608		32376	81834		33033	61525		33FD1111	G57132	
32273	G63782		32385	81091		33049	81495		33FD1112	G57018	
32274	G63781		32385	81153		33050	81514		33FD1113	G57017	
32275	61625		32386	61546		33050	82602		33FD1114	G57015	
32277	61599		32386	81510		33053	82126		33FD1114	G57212	
32279	61634		32390	81933		33059	81076		33FD1115	G57096	
32279	81919		32391	61691		33059	82104		33FD1116	G57172	
32281	82147		32391	61692		33074	61516		33FD1117	G57082	
32286	82034		32391	81931		33076	61517		33FD1118	G57081	
32288	81821		32392	81932		33084	61524		33FD1119	G57046	
32290	61605		32401	61710		33086	61522		33FD1120	G57045	
32292	61606		32402	61712		33095	69632		33FD1121	G57271	
32293	61510		32402	61714		33101	82010		33FD1147	G57080	
32294	61547		32402	61716		33122	81481		33FD1148	G57583	
32294	61700		32403	81934		33134	69845		33FD1149	G57582	
32294	69675		32404	81935		33137	81794		33GM1100	G57131	
32295	61699		32405	61720		33185	G51807		33GM1101	G57130	
32296	81893		32407	61715		33192	61704		33GM1102	G57022	
32300	61504		32592	82032		33196	G51874		33GM1103	G57013	
32301	82003		32CH1100	G57075		33274	69909		33GM1104	G57014	
32302	81912		32CH1101	G57026		33275	61592		33GM1108	G56928	
32303	81892		32CH1126	G57465		33275	81937		33GM1109	G57047	
32304	61613		32DG1100	G57409		33BW1100	G57364		33GM1110	G57000	

Important Note: Competitive Interchanges are to be used for stocking purposes only. Where multiple crosses are identified, please reference the applications section of this catalog. / **Remarque importante:** Les interchanges concurrentiels ne s'utilisent qu'aux fins de stocks. Dans le cas de rfrences multiples, consulter la section des applications du catalogue. / **Nota importante:** Dans le cas de rfrences multiples, consulter la section des applications du catalogue. / **Nota importante:** Se pueden usar intercambios competitivos para propósitos de almacenamiento solamente. Cuando se identifican intercambios múltiples, consulte la sección de aplicaciones de este catálogo.

COMPETITIVE & O.E.M. INTERCHANGE LIST
Lista de Intercambios contra Competidores y Equipo Original.
Liste d'interchange de produits comptitifs & d'equipement original (OEM)

O'Reilly... cont'd

O'reilly	Gabriel	Upgrade	O'reilly	Gabriel	Upgrade	O'reilly	Gabriel	Upgrade	O'reilly	Gabriel	Upgrade
33GM1110	G57023		33HY1104	G57168		33SB1106	G57460		33VO1100	G57338	
33GM1111	G57378		33HY1105	G57167		33SB1107	G57459		33VO1101	G57337	
33GM1112	G57377		33HY1106	G57269		33SB1109	G57629		33VO1102	G57335	
33GM1113	G57099		33HY1107	G57268		33SB1109	G57705		33VO1102	G57336	
33GM1113	G57100		33HY1108	G57279		33SB1110	G57628		33VW1100	G57156	
33GM1114	G57070		33HY1109	G57219		33SB1110	G57704		33VW1100	G57277	
33GM1114	G57122		33HY1110	G57218		33SB1140	G57673		33VW1101	G57039	
33GM1115	G57069		33HY1111	G57278		33SB1141	G57674		33VW1103	G57006	
33GM1115	G57121		33HY1112	G57140		33SC1100	G57370		33VW1104	G57206	
33GM1116	G57125		33HY1113	G57139		33SC1101	G57369		33VW1105	G57206	
33GM1118	G57111		33HY1118	G57343		33SC1102	G57429		34759	81833	
33GM1118	G57536		33HY1119	G57344		33SC1103	G57428		34762	G63896	
33GM1119	G57110		33HY1120	G57759		33SZ1100	G57126		34787	G63615	
33GM1119	G57535		33HY1121	G57059		33SZ1101	G57127		34788	G63616	
33GM1120	G57109		33HY1122	G57758		33SZ1102	G57128		34791	G63692	
33GM1120	G57314		33HY1127	G57399		33SZ1103	G57129		34828	G63510	
33GM1136	G57048		33HY1128	G57398		33TY1108	G57124		34831	81096	
33GM1138	G57108		33HY1129	G57401		33TY1108	G57453		34912	G63625	
33GM1139	G57107		33HY1130	G57400		33TY1109	G57123		34919	G63411	
33GM1141	G57198		33JP1100	G57007		33TY1110	G57221		34BK1102	G57274	
33GM1142	G57197		33JP1101	G57008		33TY1111	G57220		34CH1113	G57113	
33GM1147	G57198		33JP1102	G57083		33TY1112	G57068		34CH1114	G57112	
33GM1147	G57323		33JP1103	G57083		33TY1113	G57067		34CH1119	G56957	
33GM1148	G57197		33JP1104	G57463		33TY1114	G57405		34CH1120	G56956	
33GM1148	G57322		33JP1105	G57464		33TY1116	G56948		34CH1121	G56975	
33GM1149	G57051		33JP1107	G57765		33TY1117	G56948		34CH1122	G56973	
33HN1110	G57208		33JP1108	G57764		33TY1118	G56950		34CH1122	G56974	
33HN1110	G57418		33KA1108	G57690		33TY1119	G56949		34DG1107	G56975	
33HN1111	G57207		33KA1109	G57689		33TY1120	G57404		34DG1109	G57177	
33HN1111	G57417		33KA1110	G57276		33TY1121	G57106		34DG1110	G57176	
33HN1112	G57391		33KA1111	G57275		33TY1122	G57105		34FD1122	G56935	
33HN1113	G57390		33LX1100	G57421		33TY1153	G56933		34FD1123	G56936	
33HN1114	G57087		33LX1101	G57420		33TY1154	G56932		34FD1124	G56934	
33HN1115	G57086		33NS1101	G57118		33TY1163	G57454		34FD1124	G56937	
33HN1116	G56992		33NS1101	G57413		33TY1164	G57452		34FD1125	G57016	
33HN1117	G56991		33NS1101	G57647		33TY1165	G57451		34FD1126	G57173	
33HN1118	G57055		33NS1102	G57092		33TY1166	G57376		34FD1135	G57518	
33HN1119	G57054		33NS1103	G57159		33TY1167	G57375		34FD1136	G57517	
33HN1120	G57598		33NS1103	G57160		33TY1168	G57330		34FD1164	G57496	
33HN1121	G57597		33NS1104	G57202		33TY1169	G57329		34FD1165	G57495	
33HN1122	G57056		33NS1105	G57203		33TY1170	G57330		34GM1121	G56924	
33HN1123	G56943		33NS1106	G57036		33TY1171	G57329		34GM1122	G56925	
33HN1124	G57331		33NS1107	G57035		33TY1174	G57330		34GM1123	G56938	
33HN1124	G57480		33NS1108	G57034		33TY1174	G57567		34GM1124	G56927	
33HN1125	G57419		33NS1109	G57201		33TY1175	G57329		34GM1125	G56951	
33HN1126	G57332		33NS1110	G57200		33TY1175	G57566		34GM1126	G57060	
33HN1126	G57479		33NS1111	G57474		33TY1182	G57193		34GM1127	G57324	
33HN1147	G57696		33NS1112	G57473		33TY1184	G57353		34GM1128	G57051	
33HN1148	G57695		33NS1137	G57092		33TY1185	G57354		34GM1129	G56925	
33HN1151	G57682		33NS1154	G57035		33TY1192	G57573		34GM1130	G56924	
33HN1151	G57691		33NS1155	G57034		33TY1193	G57572		34GM1131	G57060	
33HN1152	G57416		33NS1158	G57646		33TY1202	G57544		34GM1133	G57060	
33HN1164	G57604		33NS1158	G57647		33TY1203	G57543		34GM1134	G56925	
33HN1165	G57603		33NS1159	G57145		33TY1209	G57397		34GM1135	G56924	
33HY1100	G57059		33NS1160	G57144		33TY1216	G57587		34GM1136	G56925	
33HY1101	G57149		33SB1104	G57706		33TY1217	G57586		34GM1137	G56924	

Important Note: Competitive Interchanges are to be used for stocking purposes only. Where multiple crosses are identified, please reference the applications section of this catalog. / **Remarque importante:** Les interchanges concurrentiels ne s'utilisent qu'aux fins de stocks. Dans le cas de références multiples, consulter la section des applications du catalogue. / **Nota importante:** Dans le cas de referencias multiples, consultar la sección de aplicaciones del catálogo. / **Nota importante:** Se pueden usar intercambios competitivos para propósitos de almacenamiento solamente. Cuando se identifican intercambios múltiples, consulte la sección de aplicaciones de este catálogo.

COMPETITIVE & O.E.M. INTERCHANGE LIST
Lista de Intercambios contra Competidores y Equipo Original.
Liste dinterchange de produits comptitifs & dquipement original (OEM)

O'Reilly... cont'd

O'reilly	Gabriel	Upgrade	O'reilly	Gabriel	Upgrade	O'reilly	Gabriel	Upgrade	O'reilly	Gabriel	Upgrade
34GM1140	G56929		34PC1101	G57142		34TY1179	G57732		37184	G63828	
34HN1127	G57050		34SB1115	G57516		34TY1188	G57649		37187	82035	
34HN1128	G57049		34SB1116	G57515		34TY1189	G57648		37197	G63506	
34HN1129	G57415		34SB1117	G57340		34TY1198	G57484		37198	G63694	
34HN1130	G57414		34SB1118	G57339		34TY1199	G57483		37199	69813	
34HN1131	G57085		34SB1119	G57345		34TY1222	G57482		37203	G63844	
34HN1132	G57084		34SB1120	G57346		34TY1223	G57481		37204	G63845	
34HN1133	G57223		34SB1125	G57342		34TY1228	G57153		37206	G63958	
34HN1134	G57222		34SB1126	G57341		34TY1229	G57152		37217	69900	
34HN1135	G57119		34SB1127	G57340		37016	G63635		37219	G64049	
34HN1135	G57606		34SB1128	G57339		37022	G63495		37220	G63905	
34HN1136	G57120		34TY1123	G57191		37022	G63909		37225	G64027	
34HN1136	G57605		34TY1123	G57540		37026	G63721		37226	G64028	
34HN1137	G57334		34TY1124	G57191		37029	G63419		37231	G63720	
34HN1138	G57333		34TY1125	G57190		37029	G63928		37237	69907	
34HN1139	G57522		34TY1125	G57539		37031	G63404		37241	G63842	
34HN1140	G57521		34TY1126	G57098		37033	G63548		37242	61717	
34HN1141	G57012		34TY1127	G57097		37044	G63488		37244	G63864	
34HN1142	G57011		34TY1128	G57077		37047	G63813		37251	G63878	
34HN1153	G57138		34TY1129	G57076		37047	G63902		37252	G63883	
34HN1154	G57137		34TY1130	G57372		37050	G63489		37253	G63875	
34HY1114	G57089		34TY1131	G57373		37065	G63426		37270	G63885	
34HY1115	G57088		34TY1132	G56933		37070	G63799		37270	G64029	
34HY1116	G57394		34TY1133	G56932		37073	G63492		37270	G64030	
34HY1117	G57393		34TY1134	G57044		37073	G63866		37272	70000	
34KA1116	G57489		34TY1135	G57043		37074	G63620		37273	G64031	
34KA1117	G57490		34TY1136	G57193		37082	G63683		37274	G64033	
34KA1118	G57091		34TY1137	G57192		37091	G63413		37275	69595	
34KA1119	G57090		34TY1138	G56930		37094	G63353		37276	69594	
34LX1102	G57150		34TY1139	G56931		37095	G63410		37279	G63889	
34LX1105	G57151		34TY1140	G57042		37095	G63414		37280	G64006	
34NS1113	G57158		34TY1141	G57041		37096	G63359		37281	G64032	
34NS1114	G57157		34TY1142	G57079		37097	G63950		37288	70010	
34NS1116	G57031		34TY1143	G57078		37100	G63904		37289	G64026	
34NS1117	G57030		34TY1144	G57190		37102	G63661		37290	G64042	
34NS1118	G57185		34TY1145	G57115		37104	G63673		37298	G64038	
34NS1119	G57184		34TY1146	G57114		37109	G63708		37302	G64037	
34NS1120	G57164		34TY1147	G56931		37111	G63937		37308	G64052	
34NS1121	G57163		34TY1148	G56930		37112	G63689		37313	G64056	
34NS1126	G57031		34TY1149	G57357		37117	G63623		37315	G64040	
34NS1127	G57030		34TY1150	G57358		37121	G63490		37318	G64047	
34NS1133	G57162		34TY1157	G57500		37123	G63690		37323	70078	
34NS1133	G57368		34TY1158	G57499		37129	G63421		37326	G51966	
34NS1134	G57161		34TY1159	G52007		37130	G63609		37328	G64050	
34NS1134	G57367		34TY1159	G57204		37130	G63818		39002	69996	
34NS1135	G57031		34TY1160	G52004		37134	G63715		39004	69677	
34NS1136	G57030		34TY1160	G57205		37135	G63722		39006	69766	
34NS1144	G57494		34TY1161	G57664		37137	G63915		39020	69952	
34NS1145	G57493		34TY1161	G57666		37149	G63783		39027	70024	
34NS1148	G57546		34TY1162	G57663		37151	G63803		39040	70040	
34NS1149	G57545		34TY1162	G57665		37152	G63675		39047	70033	
34NS1161	G57773		34TY1172	G56731		37156	G63869		39051	G64046	
34NS1162	G57772		34TY1173	G56730		37160	G63710		39102	69946	
34NS1163	G57775		34TY1176	G57349		37161	G63847		39107	70034	
34NS1164	G57774		34TY1177	G57350		37162	G63829		39114	70031	
34PC1100	G57141		34TY1178	G57733		37183	G63832		39130	70038	

Important Note: Competitive Interchanges are to be used for stocking purposes only. Where multiple crosses are identified, please reference the applications section of this catalog./ **Remarque importante:** Les interchanges concurrentiels ne s'utilisent qu'aux fins de stocks. Dans le cas de rfrences multiples, consulter la section des applications du catalogue./ **Nota importante:** Dans le cas de rfrences multiples, consulter la section des applications du catalogue./ **Nota importante:** Se pueden usar intercambios competitivos para propósitos de almacenamiento solamente. Cuando se identifican intercambios múltiples, consulte la sección de aplicaciones de este catálogo.

COMPETITIVE & O.E.M. INTERCHANGE LIST
Lista de Intercambios contra Competidores y Equipo Original.
Liste dinterchange de produits comptitifs & dquipement original (OEM)

O'Reilly... cont'd

O'reilly	Gabriel	Upgrade	O'reilly	Gabriel	Upgrade	O'reilly	Gabriel	Upgrade	O'reilly	Gabriel	Upgrade
40040	81873		5867	69676		72209	G56774		801952	G55999	
40044	81922		5868	69787		72210	G56773		801953	G55662	
40047	G51891		5892	69714		72257	G56837		801953	G55999	
40210	81930		5892	69811		72258	G56836		801954	G55661	
550018	69574		5893	69715		72261	G51859		801962	G55681	
5601	70028		5928	69757		72263	G52006		801964	G55697	
5607	70003		5947	69725		72264	G52005		801973	G55698	
5614	70013		5968	69898		72312	G56899		802116	G52014	
5615	70049		5971	69962		72562	G51877		802117	G52013	
5616	70045		5975	69901		72562	G51878		802143	G56799	
5618	70039		5980	69903		801100	G51815		802144	G56800	
5621	70036		5984	69945		801256	G55804		802179	G56810	
5622	70037		5987	69450		801281	G55825		802205	G56722	
5626	70041		5988	69863		801293	G51087		802206	G56721	
5639	70027		5989	69473		801341	G51718		802207	G56729	
5751	82026		5991	70020		801352	G51077		802208	G56728	
5754	82138		5993	69575		801371	G51739		802236	G56797	
5756	82070		5996	69420		801372	G51738		802237	G56798	
5757	82060		66417	G63918		801377	G56807		802248	G51760	
5760	82609		71103	G51765		801426	G56672		802248	G51761	
5762	82615		71128	G52131		801427	G56671		802267	G52009	
5765	82118		71138	G51860		801433	G56621		802268	G52008	
5766	82051		71139	G51861		801434	G56622		802295	G56887	
5777	69585		71141	G51864		801437	G55994		802296	G56886	
5778	69589		71321	G51722		801438	G55993		802367	G52082	
5778	69590		71322	G51724		801451	G56758		802368	G52081	
5779	69587		71327	G51727		801452	G56759		802378	G52095	
5783	69592		71332	69586		801504	G56517		802379	G52094	
5783	69593		71348	G51477		801505	G56516		802392	G52122	
5784	69591		71350	69998		801525	G56606		802393	G52121	
5796	69464		71361	G51704		801565	G51267		802401	G51842	
5796	69465		71362	G51703		801572	G56620		802518	G52125	
5799	70001		71373	G51736		801580	G55892		82196	81936	
5801	69625		71398	G51723		801592	G55896		82306	81929	
5803	69606		71404	G56540		801593	G56568		911039	G63456	
5804	69600		71405	G56539		801594	G56601		911228	G63879	
5811	82011		71417	G51714		801616	G55901		911228	G63882	
5819	82004		71435	G56562		801661	G55948		911229	G63884	
5819	82069		71436	G56561		801662	G55949		911259	G64016	
5820	69724		71441	G56688		801669	G55856		911261	G63870	
5823	81491		71442	G56687		801678	G56514		911262	G63867	
5826	82025		71453	G56581		801679	G56506		911267	G63888	
5831	69624		71454	G56582		801680	G55676		911277	G63890	
5839	69795		71577	G51728		801681	G55675		911277	G63891	
5845	69755		71685	G56509		801728	G56700		911278	G64012	
5850	69622		72114	G56660		801803	G55551		911299	G64043	
5850	81880		72115	G56661		801822	G56718		911508	G64000	
58653	G64079		72203	G56809		801857	G55591		911527	G64001	

Orion Bus Industries

Orion bus industries	Gabriel	Upgrade	Orion bus industries	Gabriel	Upgrade	Orion bus industries	Gabriel	Upgrade	Orion bus industries	Gabriel	Upgrade
010134501-4	85307		0102345034	85308	89422	020273541	89436		020273544	89436	
0101345014	85307		0102345034	89422		020273541-4	85000	89436	0501345-11	85732	
010134508-4	85732		020117503-4	85720		020273541-4	89436		050134501-4	85716	
0101345084	85732		0201175034	85720		0202735414	85000	89436	0501345014	85716	
010234503-4	85308	89422	020117504	85720		0202735414	89436		0501345024	85732	
010234503-4	89422		020273541	83203	89436	020273544	83203	89436	050134506-4	85732	

Important Note: Competitive Interchanges are to be used for stocking purposes only. Where multiple crosses are identified, please reference the applications section of this catalog. / **Remarque importante:** Les interchanges concurrentiels ne s'utilisent qu'aux fins de stocks. Dans le cas de références multiples, consulter la section des applications du catalogue. / **Nota importante:** Dans le cas de referencias multiples, consultar la sección de aplicaciones del catálogo. / **Nota importante:** Se pueden usar intercambios competitivos para propósitos de almacenamiento solamente. Cuando se identifican intercambios múltiples, consulte la sección de aplicaciones de este catálogo.

COMPETITIVE & O.E.M. INTERCHANGE LIST
Lista de Intercambios contra Competidores y Equipo Original.
Liste dinterchange de produits comptitifs & dquipement original (OEM)

Orion Bus Industries... cont'd

Orion bus industries	Gabriel	Upgrade	Orion bus industries	Gabriel	Upgrade	Orion bus industries	Gabriel	Upgrade	Orion bus industries	Gabriel	Upgrade
0501345064	85732		060131507	87016		680274	85716		695440	85729	
050134508	85732		060131508	87016		680352	85711		97-9999-02635	85732	
050134509	85732		070131502	87016		680378	85720		97-9999-02636	85716	
050134510	85732		070131506	87016		680504	85716		97999902635	85732	
050134511	85732		070231514	85729		680506	85732		97999902636	85716	
050134513	85732		070231527	85729		690102	85711		A-4890	85712	
050230501	85716		20117501	85720		695327	85732		A4890	85712	
050231501-4	85716		20117504	85720		695343	85732		OB020570	85711	
0502315014	85716		20117505	85720		695347	85732		OB020764	85716	
050231502-4	85716		6430645	85729		695366	85732		OB3166657	85700	
0502315024	85716		680091	85303	89422	695389	87016				
050231505	85716		680091	89422		695420	85729				
050231507	85716		680102	85712		695421	87016				

Oshkosh Motors

Oshkosh motors	Gabriel	Upgrade	Oshkosh motors	Gabriel	Upgrade	Oshkosh motors	Gabriel	Upgrade	Oshkosh motors	Gabriel	Upgrade
060670-018	83166		1583470	85051		40-4951	89426		5353054	89422	
1202-0054	83021		1745500	89430		40-5348	85058	89431	5361994	85734	
12020054	83021		2034140	646177		40-5348	89431		60670-018	83166	
12405F	85734		2173340	85303	89422	40-6967	85030	89440	60670018	83166	
12405F-1	85303	89422	2173340	89422		40-6967	89440		651444	83221	
12405F-1	89422		2218640	83009		400242	83312	89409	665040	85303	89422
12405F1	85303	89422	26228-A	83122	89406	400242	89409		665040	89422	
12405F1	89422		26228-A	89406		4036892	G63605		665060	83122	89406
12405FX1	85303	89422	26228A	83122	89406	404845	85304		665060	89406	
12405FX1	89422		26228A	89406		404951	85316	89426	690049	85303	89422
1398980	83127		2JD137	83119		404951	89426		690049	89422	
1445910	85300	89419	3638112	G63183		405348	85058	89431	90044448	85051	
1445910	89419		40-0242	83312	89409	405348	89431		P117099	83120	
1573270	83207	89407	40-0242	89409		406967	85030	89440	RW24285	83119	
1573270	89407		40-4845	85304		406967	89440				
1573280	83221		40-4951	85316	89426	5353054	85303	89422			

Osterlund Truck

Osterlund truck	Gabriel	Upgrade	Osterlund truck	Gabriel	Upgrade	Osterlund truck	Gabriel	Upgrade	Osterlund truck	Gabriel	Upgrade
220-S5-10	85712		59011	83214		680117	89419				
220S510	85712		680117	85300	89419						

Ottawa Truck

Ottawa truck	Gabriel	Upgrade	Ottawa truck	Gabriel	Upgrade	Ottawa truck	Gabriel	Upgrade	Ottawa truck	Gabriel	Upgrade
53540451	85300	89419	680117	85300	89419	90013787	89423		9007342	89422	
53540451	89419		680117	89419		90027577	85720				
59011	83214		90013787	85310	89423	9007342	85303	89422			

PACCAR

Paccar	Gabriel	Upgrade	Paccar	Gabriel	Upgrade	Paccar	Gabriel	Upgrade	Paccar	Gabriel	Upgrade
03-04176PLUS-2	85308	89422	665633	85033	89427	671656-2	85985				
08849AE	85989		665633	89427		C71-1014PLUS	85936	89456			

Pacific Truck & Trailer

Pacific truck & trailer	Gabriel	Upgrade	Pacific truck & trailer	Gabriel	Upgrade	Pacific truck & trailer	Gabriel	Upgrade	Pacific truck & trailer	Gabriel	Upgrade
507202C1	85030	89440	507202C1	89440							

Page Suspension

Page suspension	Gabriel	Upgrade	Page suspension	Gabriel	Upgrade	Page suspension	Gabriel	Upgrade	Page suspension	Gabriel	Upgrade
1080099	83203	89436	1081933	83204		665133	89436		A-2212	85029	
1080099	89436		665133	83203	89436	665267	85029		A2212	85029	

PAI Corp.

Pai corp.	Gabriel	Upgrade	Pai corp.	Gabriel	Upgrade	Pai corp.	Gabriel	Upgrade	Pai corp.	Gabriel	Upgrade
HSA-5067	85305		HSA-5095	83215		HSA5080	83221				
HSA-5080	83221		HSA5067	85305		HSA5095	83215				

Important Note: Competitive Interchanges are to be used for stocking purposes only. Where multiple crosses are identified, please reference the applications section of this catalog. / **Remarque importante:** Les interchanges concurrentiels ne s'utilisent qu'aux fins de stocks. Dans le cas de références multiples, consulter la section des applications du catalogue. / **Nota importante:** Dans le cas de referencias multiples, consultar la sección de aplicaciones del catálogo. / **Nota importante:** Se pueden usar intercambios competitivos para propósitos de almacenamiento solamente. Cuando se identifican intercambios múltiples, consulte la sección de aplicaciones de este catálogo.

COMPETITIVE & O.E.M. INTERCHANGE LIST
Lista de Intercambios contra Competidores y Equipo Original.
Liste dinterchange de produits comptitifs & dquipement original (OEM)

Peerless Trailer

Peerless trailer	Gabriel	Upgrade	Peerless trailer	Gabriel	Upgrade	Peerless trailer	Gabriel	Upgrade	Peerless trailer	Gabriel	Upgrade
120-1	83125		1201	83125		72-61	83125		7261	83125	

Peterbilt

Peterbilt	Gabriel	Upgrade	Peterbilt	Gabriel	Upgrade	Peterbilt	Gabriel	Upgrade	Peterbilt	Gabriel	Upgrade
02-00376	85302	89420	02-02741-2	89413		0202739	89414		03-07423	85033	89427
02-00376	89420		02-02742	85062	89408	02027392	85013	89414	03-07423	89427	
02-00495	85302	89420	02-02742	89408		02027392	89414		03-07423-2	85033	89427
02-00495	89420		02-02742-2	85062	89408	0202739PLUS	85013	89414	03-07423-2	89427	
02-01759	83312	89409	02-02742-2	89408		0202739PLUS	89414		03-07423PLUS	85033	89427
02-01759	89409		02-03020	85910		0202740	85036	89405	03-07423PLUS	89427	
02-01787	85062	89408	02-04010	85012	89413	0202740	89405		03-07423PLUS-2	85033	89427
02-01787	89408		02-04010	89413		02027402	85036	89405	03-07423PLUS-2	89427	
02-01890	85012	89413	02-04010-2	85012	89413	02027402	89405		03-07424	85311	89424
02-01890	89413		02-04010-2	89413		0202741	85012	89413	03-07424	89424	
02-02061	85013	89414	02-0739PLUS-2	85013	89414	0202741	89413		03-07424PLUS	85311	89424
02-02061	89414		02-0739PLUS-2	89414		02027412	85012	89413	03-07424PLUS	89424	
02-02142	85036	89405	0200376	85302	89420	02027412	89413		03-08350	85343	
02-02142	89405		0200376	89420		0202742	85062	89408	03-08350-2	85343	
02-02225	85012	89413	0200495	85302	89420	0202742	89408		03-08781	85069	89455
02-02225	89413		0200495	89420		02027422	85062	89408	03-08781	89455	
02-02736	85302	89420	0201759	83312	89409	02027422	89408		03-08781-2	85069	89455
02-02736	89420		0201759	89409		0203020	85910		03-08781-2	89455	
02-02736-2	85302	89420	0201787	85062	89408	0204010	85012	89413	0301635	85308	89422
02-02736-2	89420		0201787	89408		0204010	89413		0301635	89422	
02-02736PLUS	85302	89420	0201890	85012	89413	02040102	85012	89413	0304176	85308	89422
02-02736PLUS	89420		0201890	89413		02040102	89413		0304176	89422	
02-02736PLUS-2	85302	89420	0202061	85013	89414	020739PLUS2	85013	89414	0304176PLUS	85308	89422
02-02736PLUS-2	89420		0202061	89414		020739PLUS2	89414		0304176PLUS	89422	
02-02737	85062	89408	0202142	85036	89405	03-01635	85308	89422	0304629	85311	89424
02-02737	89408		0202142	89405		03-01635	89422		0304629	89424	
02-02737-2	85062	89408	0202225	85012	89413	03-04176	85308	89422	0305106	85033	89427
02-02737-2	89408		0202225	89413		03-04176	89422		0305106	89427	
02-02737PLUS	85062	89408	0202736	85302	89420	03-04176PLUS	85308	89422	0305384	85033	89427
02-02737PLUS	89408		0202736	89420		03-04176PLUS	89422		0305384	89427	
02-02737PLUS-2	85062	89408	02027362	85302	89420	03-04176PLUS-2	85308	89422	0306084	85033	89427
02-02737PLUS-2	89408		02027362	89420		03-04629	85311	89424	0306084	89427	
02-02738	85012	89413	0202736PLUS	85302	89420	03-04629	89424		0306084PLUS	85033	89427
02-02738	89413		0202736PLUS	89420		03-05106	85033	89427	0306084PLUS	89427	
02-02738-2	85012	89413	0202736PLUS2	85302	89420	03-05106	89427		0306084PLUS2	85033	89427
02-02738-2	89413		0202736PLUS2	89420		03-05384	85033	89427	0306084PLUS2	89427	
02-02738PLUS	85012	89413	0202737	85062	89408	03-05384	89427		0307281	85311	89424
02-02738PLUS	89413		0202737	89408		03-06084	85033	89427	0307281	89424	
02-02738PLUS-2	85012	89413	02027372	85062	89408	03-06084	89427		0307421	85311	89424
02-02738PLUS-2	89413		02027372	89408		03-06084PLUS	85033	89427	0307421	89424	
02-02739	85013	89414	0202737PLUS	85062	89408	03-06084PLUS	89427		0307421PLUS	85311	89424
02-02739	89414		0202737PLUS	89408		03-06084PLUS-2	85033	89427	0307421PLUS	89424	
02-02739-2	85013	89414	0202737PLUS2	85062	89408	03-06084PLUS-2	89427		0307421PLUS2	85311	89424
02-02739-2	89414		0202737PLUS2	89408		03-07281	85311	89424	0307421PLUS2	89424	
02-02739PLUS	85013	89414	0202738	85012	89413	03-07281	89424		0307421SPL	85311	89424
02-02739PLUS	89414		0202738	89413		03-07421	85311	89424	0307421SPL	89424	
02-02740	85036	89405	02027382	85012	89413	03-07421	89424		0307423	85033	89427
02-02740	89405		02027382	89413		03-07421PLUS	85311	89424	0307423	89427	
02-02740-2	85036	89405	0202738PLUS	85012	89413	03-07421PLUS	89424		03074232	85033	89427
02-02740-2	89405		0202738PLUS	89413		03-07421PLUS-2	85311	89424	03074232	89427	
02-02741	85012	89413	0202738PLUS2	85012	89413	03-07421PLUS-2	89424		0307423PLUS	85033	89427
02-02741	89413		0202738PLUS2	89413		03-07421SPL	85311	89424	0307423PLUS	89427	
02-02741-2	85012	89413	0202739	85013	89414	03-07421SPL	89424		0307423PLUS2	85033	89427

Important Note: Competitive Interchanges are to be used for stocking purposes only. Where multiple crosses are identified, please reference the applications section of this catalog. / **Remarque importante:** Les interchanges concurrentiels ne s'utilisent qu'aux fins de stocks. Dans le cas de références multiples, consulter la section des applications du catalogue. / **Nota importante:** Dans le cas de referencias multiples, consultar la sección de aplicaciones del catálogo. / **Nota importante:** Se pueden usar intercambios competitivos para propósitos de almacenamiento solamente. Cuando se identifican intercambios múltiples, consulte la sección de aplicaciones de este catálogo.

COMPETITIVE & O.E.M. INTERCHANGE LIST
Lista de Intercambios contra Competidores y Equipo Original.
Liste dinterchange de produits comptitifs & dquipement original (OEM)

Peterbilt... cont'd

Peterbilt	Gabriel	Upgrade	Peterbilt	Gabriel	Upgrade	Peterbilt	Gabriel	Upgrade	Peterbilt	Gabriel	Upgrade
0307423PLUS2	89427		1613947000PLUS2	89428		60670-008PLUS-2	89405		665784	83122	89406
0307424	85311	89424	16725-01	83126	89430	60670005PLUS	83137		665784	89406	
0307424	89424		16725-01	89430		60670008	83123	89405	665785	83137	
0307424PLUS	85311	89424	1672501	83126	89430	60670008L	89405		665788	85000	89436
0307424PLUS	89424		1672501	89430		60670008L	83123	89405	665788	89436	
0308350	85343		1707378PAC	85182		60670008L	89405		665788-2	85000	89436
03083502	85343		19495-01	83126	89430	60670008PLUS	83123	89405	665788-2	89436	
0308781	85069	89455	19495-01	89430		60670008PLUS	89405		665826	85069	89455
0308781	89455		1949501	83126	89430	60680-003	83112		665826	89455	
03087812	85069	89455	1949501	89430		60680-003L	83112		665844	85069	89455
03087812	89455		20-16755	83042		60680-004	83143		665844	89455	
10-12032-002PLUS	85320	89429	2016755	83042		60680-004L	83143		665858	85070	89459
10-12032-002PLUS	89429		2018987C1PLUS	85003	89411	60680-005	83142		665858	89459	
10-12032-002PLUS-2	85320	89429	2018987C1PLUS	89411		60680-005L	83142		665858-2	85070	89459
10-12032-002PLUS-2	89429		2018987C1PLUS-2	85003	89411	60680003	83112		665858-2	89459	
10-12542-000PLUS	85901		2018987C1PLUS-2	89411		60680003L	83112		6658582	85070	89459
1012032002PLUS	85320	89429	2018987C1PLUS2	85003	89411	60680004	83143		6658582	89459	
1012032002PLUS	89429		2018987C1PLUS2	89411		60680004L	83143		665876	85959	
1012032002PLUS2	85320	89429	23-08233	85308	89422	60680005	83142		665918	85900	
1012032002PLUS2	89429		23-08233	89422		60680005L	83142		665926	85047	89435
1012032002PLUS2	89429		23-10393	85308	89422	654782	83008		665926	89435	
1012542000PLUS	85901		23-10393	89422		654812	83042		665927	85901	
11418	646177		23-12262	85012	89413	654919	83035		665928	85062	89408
11418WAC	646177		23-12262	89413		665133	83203	89436	665928	89408	
1201-0012	83023		2308233	85308	89422	665133	89436		665930	85001	89410
1201-0054	83021		2308233	89422		665174	85060		665930	89410	
1201-8001	83908		2310393	85308	89422	665565PLUS	85007		665931	83312	89409
1201-8002	83081		2310393	89422		665565PLUS-2	85007		665931	89409	
1201-8006	83081		2312262	85012	89413	665565PLUS2	85007		665932	85012	89413
12010012	83023		2312262	89413		665617	85031		665932	89413	
12010054	83021		25523002	83908		665617-2	85031		665945	85902	
12018001	83908		25523024	83081		6656172	85031		665945-2	85902	
12018002	83081		29-02455	83008		665632	85013	89414	665950	85902	
12018006	83081		29-06005	83035		665632	89414		671052	85070	89459
1202-0012	83023		29-06032	83035		665633	85033	89427	671052	89459	
1202-0032	83016		2902455	83008		665633	89427		671052-2	85070	89459
1202-0054	83021		2906005	83035		665655	85062	89408	671052-2	89459	
1202-1044	83025		2906032	83035		665655	89408		6710522	85070	89459
12020012	83023		471700004420	85109		665656	85012	89413	6710522	89459	
12020032	83016		471700004423	85109		665656	89413		671091	85069	89455
12020054	83021		471700013186	85109		665657	85013	89414	671091	89455	
12021044	83025		47902-13PLUS	83122	89406	665657	89414		671092	85012	89413
12887-01	85013	89414	47902-13PLUS	89406		665658	85036	89405	671092	89413	
12887-01	89414		47902-13PLUS-2	83122	89406	665658	89405		671654	85936	89456
12887-02	85013	89414	47902-13PLUS-2	89406		665660	85033	89427	671654	89456	
12887-02	89414		4790213PLUS	83122	89406	665660	89427		671699	85937	
1288701	85013	89414	4790213PLUS	89406		665662	85012	89413	671794	85067	89451
1288701	89414		60670-005PLUS	83137		665662	89413		671794	89451	
1288702	85013	89414	60670-005PLUS-2	83137		665738	85910		671962PLUS	85936	89456
1288702	89414		60670-008	83123	89405	665738-2	85910		671962PLUS	89456	
16-13947-000PLUS	85319	89428	60670-008	89405		665752	85067	89451	671962SPL	85936	89456
16-13947-000PLUS	89428		60670-008L	83123	89405	665752	89451		671962SPL	89456	
16-13947-000PLUS-2	85319	89428	60670-008L	89405		665762	85012	89413	671963	85937	
16-13947-000PLUS-2	89428		60670-008PLUS	83123	89405	665762	89413		680026	85302	89420
1613947000PLUS	85319	89428	60670-008PLUS	89405		665783	83123	89405	680026	89420	
1613947000PLUS	89428		60670-008PLUS-2	83123	89405	665783	89405		680027	85308	89422
1613947000PLUS2	85319	89428									

Important Note: Competitive Interchanges are to be used for stocking purposes only. Where multiple crosses are identified, please reference the applications section of this catalog. / **Remarque importante:** Les interchanges concurrentiels ne s'utilisent qu'aux fins de stocks. Dans le cas de rfrences multiples, consulter la section des applications du catalogue. / **Nota importante:** Dans le cas de rfrences multiples, consulter la section des applications du catalogue. / **Nota importante:** Se pueden usar intercambios competitivos para propósitos de almacenamiento solamente. Cuando se identifican intercambios múltiples, consulte la sección de aplicaciones de este catálogo.

COMPETITIVE & O.E.M. INTERCHANGE LIST
Lista de Intercambios contra Competidores y Equipo Original.
Liste d'interchange de produits complitifs & d'equipement original (OEM)

Peterbilt... cont'd

Peterbilt	Gabriel	Upgrade	Peterbilt	Gabriel	Upgrade	Peterbilt	Gabriel	Upgrade	Peterbilt	Gabriel	Upgrade
680027	89422		90044089PLUS-2	89407		B711001	89459		C71-1011PLUS-2	89455	
680185	85308	89422	90045132	85909		B711002	85001	89410	C71-1011SPL	85069	89455
680185	89422		90045605	85109		B711002	89410		C71-1011SPL	89455	
680237	85303	89422	90045803	85109		B711003	83312	89409	C71-1013	85985	
680237	89422		90045812	85109		B711003	89409		C71-1014	85936	89456
680239	85310	89423	96027-1054	83011		B716000	85959		C71-1014	89456	
680239	89423		960271054	83011		B716002	85012	89413	C71-1016	85067	89451
680240	85302	89420	ACHB966	83136		B716002	89413		C71-1016	89451	
680240	89420		B71-1000	85031		B7160022	85012	89413	C71-1017	85069	89455
680241	85311	89424	B71-1001	85070	89459	B7160022	89413		C71-1017	89455	
680241	89424		B71-1001	89459		B716003	85029		C71-6000	85067	89451
680242	85308	89422	B71-1002	85001	89410	B716004	85084	89460	C71-6000	89451	
680242	89422		B71-1002	89410		B716004	89460		C71-6000-2	85067	89451
680253	85314	89425	B71-1003	83312	89409	B716005	85084	89460	C71-6000-2	89451	
680253	89425		B71-1003	89409		B716005	89460		C71-6002	85311	89424
680261	85062	89408	B71-6000	85959		B716006	85084	89460	C71-6002	89424	
680261	89408		B71-6000-2	85959		B716006	89460		C71-6003	85988	
680261-2	85062	89408	B71-6002	85012	89413	B716007	85062	89408	C71-6004	85343	
680261-2	89408		B71-6002	89413		B716007	89408		C71-6005	85069	89455
6802612	85062	89408	B71-6002-2	85012	89413	B716008	83312	89409	C71-6005	89455	
6802612	89408		B71-6002-2	89413		B716008	89409		C71-6015	85067	89451
680279	83209	89414	B71-6003	85029		B716009	83219		C71-6015	89451	
680279	89414		B71-6003-2	85029		B716009	85062	89408	C711002	85067	89451
680280	85906	89407	B71-6004	85084	89460	B716009	89408		C711002	89451	
680280	89407		B71-6004	89460		B716010	85023	89415	C7110022	85067	89451
680281	85003	89411	B71-6005	85084	89460	B716010	89415		C7110022	89451	
680281	89411		B71-6005	89460		B716011	85062	89408	C711002PLUS	85067	89451
680303	85007		B71-6006	85084	89460	B716011	89408		C711002PLUS	89451	
680348	85012	89413	B71-6006	89460		B716012	85119		C711002PLUS2	85067	89451
680348	89413		B71-6007	85062	89408	B716013	85012	89413	C711002PLUS2	89451	
680425	85320	89429	B71-6007	89408		B716013	89413		C711011	85069	89455
680425	89429		B71-6008	83312	89409	B716015	85012	89413	C711011	89455	
680435	85033	89427	B71-6008	89409		B716015	89413		C711011PLUS	85069	89455
680435	89427		B71-6009	83219		B716016	85012	89413	C711011PLUS	89455	
680457	85302	89420	B71-6009	85062	89408	B716016	89413		C711011PLUS2	85069	89455
680457	89420		B71-6009	89408		B716016A	85012	89413	C711011PLUS2	89455	
680459	85311	89424	B71-6010	85023	89415	B716016A	89413		C711011SPL	85069	89455
680459	89424		B71-6010	89415		B716017	85910		C711011SPL	89455	
680473	85319	89428	B71-6011	85062	89408	B716018	85012	89413	C711013	85985	
680473	89428		B71-6011	89408		B716018	89413		C711014	85936	89456
680586	85311	89424	B71-6012	85119		B716019	85989		C711014	89456	
680586	89424		B71-6013	85012	89413	B716020	85989		C711016	85067	89451
70701PLUS	85900		B71-6013	89413		BFRG 072	85182		C711016	89451	
800670	85060		B71-6015	85012	89413	C71-1002	85067	89451	C711017	85069	89455
8086053PLUS	85047	89435	B71-6015	89413		C71-1002	89451		C711017	89455	
8086053PLUS	89435		B71-6016	85012	89413	C71-1002-2	85067	89451	C716000	85067	89451
85013A0C	85013	89414	B71-6016	89413		C71-1002-2	89451		C716000	89451	
85013A0C	89414		B71-6016A	85012	89413	C71-1002PLUS	85067	89451	C7160002	85067	89451
85013ac0	85013	89414	B71-6016A	89413		C71-1002PLUS	89451		C7160002	89451	
85013ac0	89414		B71-6017	85910		C71-1002PLUS-2	85067	89451	C716002	85311	89424
90044011	85004		B71-6018	85012	89413	C71-1002PLUS-2	89451		C716002	89424	
90044025PLUS	83209	89414	B71-6018	89413		C71-1011	85069	89455	C716003	85988	
90044025PLUS	89414		B71-6019	85989		C71-1011	89455		C716004	85343	
90044089PLUS	83124	89407	B71-6020	85989		C71-1011PLUS	85069	89455	C716005	85069	89455
90044089PLUS	89407		B711000	85031		C71-1011PLUS	89455		C716005	89455	
90044089PLUS-2	83124	89407	B711001	85070	89459	C71-1011PLUS-2	85069	89455	C716015	85067	89451

Important Note: Competitive Interchanges are to be used for stocking purposes only. Where multiple crosses are identified, please reference the applications section of this catalog. / **Remarque importante:** Les interchanges concurrentiels ne s'utilisent qu'aux fins de stocks. Dans le cas de références multiples, consulter la section des applications du catalogue. / **Nota importante:** Dans le cas de referencias multiples, consultar la sección de aplicaciones del catálogo. / **Nota importante:** Se pueden usar intercambios competitivos para propósitos de almacenamiento solamente. Cuando se identifican intercambios múltiples, consulte la sección de aplicaciones de este catálogo.

COMPETITIVE & O.E.M. INTERCHANGE LIST

Lista de Intercambios contra Competidores y Equipo Original.

Liste dinterchange de produits compititifs & dquipement original (OEM)

Peterbilt... cont'd

Peterbilt	Gabriel	Upgrade	Peterbilt	Gabriel	Upgrade	Peterbilt	Gabriel	Upgrade	Peterbilt	Gabriel	Upgrade
C716015	89451		K374-33-2	83312	89409	K374272	89410		R71-6007	83008	
K374-10-2	83215		K374-33-2	89409		K37428PLUS	85314	89425	R71-6008	83035	
K374-26PLUS	85001	89410	K374-33PLUS	83312	89409	K37428PLUS	89425		R71-6009	83081	
K374-26PLUS	89410		K374-33PLUS	89409		K37429PLUS	85310	89423	R711004	83049	
K374-26PLUS-2	85001	89410	K374-33PLUS-2	83312	89409	K37429PLUS	89423		R711005	83024	
K374-26PLUS-2	89410		K374-33PLUS-2	89409		K37433PLUS	83312	89409	R716005	83042	
K374-27-2	85001	89410	K374102	83215		K37433PLUS	89409		R716007	83008	
K374-27-2	89410		K37426PLUS	85001	89410	PP1058870	83059		R716008	83035	
K374-28PLUS	85314	89425	K37426PLUS	89410		PP2582870	83012		R716009	83081	
K374-28PLUS	89425		K37426PLUS2	85001	89410	R71-1004	83049		TK19679	83126	89430
K374-29PLUS	85310	89423	K37426PLUS2	89410		R71-1005	83024		TK19679	89430	
K374-29PLUS	89423		K374272	85001	89410	R71-6005	83042				

Phoenix Cruiser RV

Phoenix cruiser rv	Gabriel	Upgrade	Phoenix cruiser rv	Gabriel	Upgrade	Phoenix cruiser rv	Gabriel	Upgrade	Phoenix cruiser rv	Gabriel	Upgrade
ASH-1136	G63623		ASH-1154	G63622							

Pierce Manufacturing Inc.

Pierce manufacturing inc.	Gabriel	Upgrade	Pierce manufacturing inc.	Gabriel	Upgrade	Pierce manufacturing inc.	Gabriel	Upgrade	Pierce manufacturing inc.	Gabriel	Upgrade
060665-013	85965		2034140	646177		405348	85058	89431	60680005L	83142	
060665-013L	85965		2509223C91	83054		405348	89431		6127088C1	83163	
060665013	85965		2509223C92	83054		406967	85030	89440	6127713C2	85656	
10-13592-000	85959		3514952C1	85976		406967	89440		6127714C1	85928	
10-13760-000	85959		3576464C2	85957		47170000440	85959		680401	85307	
10-13809-000	85958		3626571C2	85072		471700002991	85959		814903003482	83040	
1013760000	85959		3868265C1	85995		471700003920	85958		814903003483	83039	
1013809000	85958		40-0242	83312	89409	60657-003	85072		814903003528	83038	
1201-9008	83054		40-0242	89409		60657-003L	85072		9HE302	85919	
12019008	83054		40-3089	83312	89409	60657003	85072		ASH-85789	77986	
1445910	85300	89419	40-3089	89409		60657003L	85072		ASH-85927	77986	
1445910	89419		40-3135	85030	89440	60665-013	85965		ASH-866127	77986	
18-41762-000	83038		40-3135	89440		60665-013L	85965		ASH-866139	77986	
18-47349-000	83039		40-4845	85304		60665013	85965		H60657003	85072	
18-47350-000	83040		40-4951	85316	89426	60675-003	85976		H60675-003	85976	
18-60764-000	83038		40-4951	89426		60675-003L	85976		H60675003	85976	
18-60766-000	83040		40-5348	85058	89431	60675003	85976		HC3Z-18125-EP	77986	
18-60767-000	83039		40-5348	89431		60675003L	85976		HC3Z-18125-X	77986	
1841762000	83038		40-6967	85030	89440	60680-004	83143		HDR60680-005	83142	
1847349000	83039		40-6967	89440		60680-004L	83143		HDR60680005	83142	
1847350000	83040		400242	83312	89409	60680-005	83142		LC3Z-18125-J	77986	
1860764000	83038		400242	89409		60680-005L	83142		LC3Z-18125-W	77986	
1860766000	83040		404845	85304		60680004	83143		SD-15165	85304	
1860767000	83039		404951	85316	89426	60680004L	83143		SDA471700002991	85959	
1943267	85962		404951	89426		60680005	83142				

Powerhouse Coach Inc.

Powerhouse coach inc.	Gabriel	Upgrade	Powerhouse coach inc.	Gabriel	Upgrade	Powerhouse coach inc.	Gabriel	Upgrade	Powerhouse coach inc.	Gabriel	Upgrade
141700005838	85061	89450	20551628	89448		47170000443	89448		64838-003	89454	
20433424	85061	89450	20973993	85061	89450	471700003830	85933	89454	64838-003L	85933	89454
20485632	85933	89454	21137330	85933	89454	471700003830	89454		64838-003L	89454	
20485632	89454		21137330	89454		471700003832	85933	89454	64838003	85933	89454
20485633	85933	89454	21436086	85061	89450	471700003832	89454		64838003	89454	
20485633	89454		21462380	85088		471700006040	85088		64838003L	85933	89454
20551628	85066	89448	47170000443	85066	89448	64838-003	85933	89454	64838003L	89454	

Prevost

Prevost	Gabriel	Upgrade	Prevost	Gabriel	Upgrade	Prevost	Gabriel	Upgrade	Prevost	Gabriel	Upgrade
01-0100-905	85303	89422	010100905	89422		12L589	85729		12T113	85303	89422
01-0100-905	89422		0822045526	85702		12T-1-13	85303	89422	12T113	89422	
010100905	85303	89422	12L-5-89	85729		12T-1-13	89422		19501288	85729	

Important Note: Competitive Interchanges are to be used for stocking purposes only. Where multiple crosses are identified, please reference the applications section of this catalog. / **Remarque importante:** Les interchanges concurrentiels ne s'utilisent qu'aux fins de stocks. Dans le cas de références multiples, consulter la section des applications du catalogue. / **Nota importante:** Dans le cas de références multiples, consulter la section des applications du catalogue. / **Nota importante:** Se pueden usar intercambios competitivos para propósitos de almacenamiento solamente. Cuando se identifican intercambios múltiples, consulte la sección de aplicaciones de este catálogo.

COMPETITIVE & O.E.M. INTERCHANGE LIST
Lista de Intercambios contra Competidores y Equipo Original.
Liste dinterchange de produits comptitifs & dquipement original (OEM)

Prevost... cont'd

Prevost	Gabriel	Upgrade	Prevost	Gabriel	Upgrade	Prevost	Gabriel	Upgrade	Prevost	Gabriel	Upgrade
19501289	85728		481700000210	85329		630103	85329		680422	85329	
19501547	85740		481700000210	85713		630127	85736		680492	85713	
19501669	85339		481700999376	85329		630134	85329		690060	85713	
19502711	85702		481700999380	85329		630161	85736		74939852	85308	89422
19506846	85339		481700999386	85736		630234	85329		74939852	89422	
19507669	85340		481700999390	85736		630236	85329		G1011822	85702	
196013	85340		52001	85708		630252	85329		G5008070	85700	
196533	85708		63-1013	85329		630253	85713		N22212	85700	
3166657	85700		630001	85713		631013	85329				
481700000207	85329		630080	85713		650407	85736				
481700000209	85713		630091	85736		680323	85700				

ProPar

ProPar	Gabriel	Upgrade	ProPar	Gabriel	Upgrade	ProPar	Gabriel	Upgrade	ProPar	Gabriel	Upgrade
PROSH846155	646155		PROSH85005	85005	89430	PROSH85069	85069	89455	PROSH85323	89436	
PROSH83027	83027		PROSH85005	89430		PROSH85069	89455		PROSH85338	85338	
PROSH83042	83042		PROSH85006	85006		PROSH85070	85070	89459	PROSH85919	85919	
PROSH83122	83122	89406	PROSH85012	85012	89413	PROSH85070	89459		PROSH85923	85923	89458
PROSH83122	89406		PROSH85012	89413		PROSH85310	85310	89423	PROSH85923	89458	
PROSH83125	83125		PROSH85030	85030	89440	PROSH85310	89423		PROSH85924	85924	89457
PROSH83127	83127		PROSH85030	89440		PROSH85311	85311	89424	PROSH85924	89457	
PROSH83128	83128	89436	PROSH85045	85045		PROSH85311	89424		PROSH85932	85932	89453
PROSH83128	89436		PROSH85052	85052		PROSH85316	85316	89426	PROSH85932	89453	
PROSH83130	83130		PROSH85053	85053	89442	PROSH85316	89426		PROSH85936	85936	89456
PROSH85000	85000	89436	PROSH85053	89442		PROSH85321	85321		PROSH85936	89456	
PROSH85000	89436		PROSH85062	85062	89408	PROSH85322	85322		PROSH85954	85954	
PROSH85003	89411		PROSH85062	89408		PROSH85323	85323	89436	PROSH89437	89437	

PRT

Prt	Gabriel	Upgrade	Prt	Gabriel	Upgrade	Prt	Gabriel	Upgrade	Prt	Gabriel	Upgrade
920728	G57853		920729	G57852							

PRT (ADD)

Prt (add)	Gabriel	Upgrade	Prt (add)	Gabriel	Upgrade	Prt (add)	Gabriel	Upgrade	Prt (add)	Gabriel	Upgrade
141251	G52174		170215	89503		170740	81076		172372	81935	
170129	85303	89422	170217	83163		170996	81270		172373	69473	
170129	85320	89429	170221	85921		171295	83137		172404	69606	
170129	89422		170222	83175		171376	81924		172404	81495	
170129	89429		170225	83136		171384	81096		172405	61717	
170130	85001	89410	170228	G63969		171430	82126		172412	G51077	
170130	89410		170237	83136		172127	61651		172413	69589	
170132	85724	89443	170243	85069	89455	172127	69813		172436	G64052	
170132	89443		170243	89455		172131	61606		172452	61690	
170133	85060		170245	83122	89406	172131	G51077		172453	G63872	
170133	85959		170245	89406		172174	69585		172461	70027	
170139	85003	89411	170246	83123	89405	172174	70001		172480	G51807	
170139	89411		170246	89405		172193	61560		172704	69606	
170140	85014		170247	85006		172193	81904		172704	81495	
170146	83207	89407	170248	83137		172289	81495		173001	61506	
170146	89407		170248	85976		172293	G63845		173001	81318	
170148	83456	89447	170249	85927		172321	69587		173070	82156	
170148	89447		170257	G64177		172331	61592		173098	61508	
170198	81744		170262	83159		172331	81937		173098	81507	
170207	81510		170263	85071		172358	61651		173099	81494	
170211	85058	89431	170264	83515		172358	69813		173170	61605	
170211	89431		170296	69755		172359	61651		173170	81878	
170213	85054		170335	G63717		172359	69813				
170215	85918	89449	170366	61529		172371	69676				
170215	85920	89503	170464	81492		172371	81481				
170215	89449		170469	G63809		172372	69464				

Important Note: Competitive Interchanges are to be used for stocking purposes only. Where multiple crosses are identified, please reference the applications section of this catalog. / **Remarque importante:** Les interchanges concurrentiels ne s'utilisent qu'aux fins de stocks. Dans le cas de rferences multiples, consulter la section des applications du catalogue. / **Nota importante:** Dans le cas de rferences multiples, consulter la section des applications du catalogue. / **Nota importante:** Se pueden usar intercambios competitivos para propósitos de almacenamiento solamente. Cuando se identifican intercambios múltiples, consulte la sección de aplicaciones de este catálogo.

COMPETITIVE & O.E.M. INTERCHANGE LIST
Lista de Intercambios contra Competidores y Equipo Original.
Liste d'interchange de produits compititifs & d'equipement original (OEM)

PRT (ADD)... cont'd

Prt (add)	Gabriel	Upgrade	Prt (add)	Gabriel	Upgrade	Prt (add)	Gabriel	Upgrade	Prt (add)	Gabriel	Upgrade
173176	61506		173617	61546		173698	61691		173824	81930	
173176	81318		173618	61625		173698	61692		173825	61714	
173196	G63720		173619	61664		173698	81921		173826	61641	
173228	61500		173619	81869		173698	81930		173826	61663	
173293	81446		173620	61676		173698	81931		173826	81920	
173296	82125		173620	81926		173700	69898		173826	81925	
173328	70000		173621	61635		173700	81794		173827	G63870	
173436	61659		173621	61714		173701	61615		173828	G63867	
173436	61777		173622	61599		173701	81936		173828	G64157	
173436	81924		173622	81928		173704	61614		173830	61700	
173471	69591		173623	61638		173705	61658		173831	G51850	
173493	G64111		173623	81892		173705	81923		173831	G63879	
173504	61544		173624	61613		173708	61500		173831	G63882	
173504	61555		173624	81914		173708	81147		173832	61565	
173504	61685		173625	61641		173725	61679		173833	G63889	
173504	81668		173625	81920		173727	61593		173839	61643	
173504	81713		173626	61654		173727	81872		173839	61683	
173505	61543		173627	61656		173728	81911		173839	81922	
173505	61565		173627	61682		173729	61616		173840	G63844	
173505	81667		173628	61626		173729	81929		173841	61684	
173506	61601		173628	81916		173730	69675		173841	61685	
173506	81836		173650	G64027		173730	81446		173842	G64032	
173509	61504		173651	G64028		173731	61510		173843	G51812	
173509	61601		173655	61528		173731	81871		173851	G63873	
173509	81516		173655	81482		173733	69962		173857	G63918	
173509	81750		173656	61662		173735	61565		173858	61704	
173509	81836		173680	81091		173735	61687		173859	61680	
173510	61512		173681	81484		173736	61522		173860	61685	
173510	61542		173682	81691		173736	81496		173862	61777	
173510	61555		173684	81559		173738	81091		173863	61654	
173510	81559		173686	G63387		173739	81164		173886	61662	
173510	81713		173687	81744		173741	61629		173887	69587	
173510	81726		173688	61704		173741	81918		173888	81507	
173523	61535		173688	69909		173766	69962		173889	G64026	
173523	81548		173690	61591		173769	61634		173890	G64048	
173542	61536		173690	81744		173769	81919		173892	61711	
173542	81549		173691	61595		173800	81932		173893	70060	
173564	69900		173691	81833		173802	61692		173894	61687	
173575	61655		173692	61703		173802	61710		173895	81676	
173579	61623		173693	61658		173802	61716		173896	G64037	
173579	81893		173693	81923		173803	G63884		173898	69592	
173581	61591		173694	61643		173804	G63879		173898	69593	
173581	81744		173694	81922		173804	G63882		173899	G64087	
173582	61646		173695	81930		173806	G63885		173900	70039	
173582	81828		173696	61641		173806	G64029		173901	61696	
173583	61626		173696	61663		173806	G64030		173901	61697	
173583	61627		173696	81920		173813	G64087		173903	61655	
173583	81917		173696	81921		173814	G64006		173904	G64080	
173584	61542		173696	81922		173815	61612		173912	69591	
173584	61555		173696	81925		173815	81913		173913	82602	
173584	81726		173697	61642		173816	G51802		173924	G511001	
173585	61611		173697	61675		173817	G51814		173928	G64040	
173585	81912		173697	81921		173821	G63918		173932	G64079	
173586	61600		173697	81930		173823	61712		173933	61713	
173586	81873		173698	61642		173823	81933		173934	G64071	
173616	81496		173698	61675		173824	61675		173935	G51980	

Important Note: Competitive Interchanges are to be used for stocking purposes only. Where multiple crosses are identified, please reference the applications section of this catalog. / **Remarque importante:** Les interchanges concurrentiels ne s'utilisent qu'aux fins de stocks. Dans le cas de rfrences multiples, consulter la section des applications du catalogue. / **Nota importante:** Dans le cas de rfrences multiples, consulter la section des applications du catalogue. / **Nota importante:** Se pueden usar intercambios competitivos para propósitos de almacenamiento solamente. Cuando se identifican intercambios múltiples, consulte la sección de aplicaciones de este catálogo.

COMPETITIVE & O.E.M. INTERCHANGE LIST
Lista de Intercambios contra Competidores y Equipo Original.
Liste d'interchange de produits comptitifs & d'equipement original (OEM)

PRT (ADD)... cont'd

Prt (add)	Gabriel	Upgrade	Prt (add)	Gabriel	Upgrade	Prt (add)	Gabriel	Upgrade	Prt (add)	Gabriel	Upgrade
173935	G64042		175458	61675		194580	G51904		372387	G51759	
173936	G51812		175458	81930		343162	G51804		373111	G51714	
173937	G64050		177083	61605		349058	G51077		373123	G55825	
173938	G64104		177083	81878		349076	G51887		373124	G51767	
173939	G64043		177085	61675		349122	G64046		373139	G51881	
173941	70078		177085	81930		370018	G64148		373142	G51700	
173942	69590		190008	70095		370087	G51920		373150	G55821	
173943	G64111		190008	70102		370088	G51921		373162	G51804	
173944	G64121		192404	69606		370100	70041		373192	G56597	
173945	G64042		192404	81495		370126	G51879		373193	G51738	
173946	70010		192409	61734		370439	69966		373194	69907	
173961	G64163		192411	61720		370480	G51738		373195	G51858	
173962	70203		193206	61608		370504	G511043		373198	G51739	
173985	82128		193208	G63707		370523	G51848		373201	G51799	
174044	G63306		193574	69901		370716	70052		373201	G56899	
174072	61531		193575	61655		370796	70065		373202	G51983	
174072	81516		193576	G63726		370797	G51937		373204	G51850	
174072	81750		193577	61565		370816	82011		373206	G51798	
174088	81484		193577	61687		371019	69946		373207	G51803	
174244	61523		193580	61624		371090	69450		373213	G51783	
174244	81096		193580	81890		371176	81934		373223	G51842	
174283	61643		193581	61591		371231	G51965		373227	G51736	
174283	81922		193581	81744		371305	G511092		373231	G56598	
174303	61523		193582	61646		372046	G56591		373238	G51805	
174303	81096		193582	81828		372060	69945		373242	G51716	
174315	81710		193583	81891		372095	69945		373244	G511004	
174340	81582		193598	70098		372095	81934		373247	G51849	
174386	G64033		193598	70208		372161	G51727		373248	G64038	
174408	G63404		193655	61528		372184	G51795		373250	G51721	
174441	61642		193655	81482		372221	69863		373251	G51883	
174441	81921		193657	61539		372236	70040		373253	G52037	
174442	81922		193695	61675		372237	70020		373254	G52036	
174546	61715		193695	81930		372288	70036		373255	70045	
174575	61638		193697	61675		372291	70003		373256	70013	
174575	81892		193698	81921		372294	G51794		373257	G51880	
174576	61612		193702	G63782		372295	G51794		373259	G51854	
174576	81913		193703	G63781		372298	69586		373260	G51853	
175075	81039		193706	G63809		372304	70028		373269	G51879	
175093	81730		193707	G63815		372313	70055		373271	70034	
175357	61642		193724	81318		372316	70036		373276	70037	
175357	81921		193805	G63815		372320	G51971		373278	G51898	
175366	G63832		193818	G63837		372333	70041		373280	70086	
175367	G63828		193819	61663		372336	G51807		373284	G51898	
175404	G63864		193820	G64000		372337	G51838		373288	70089	
175407	G63883		193834	G63607		372340	G51908		373289	G51898	
175408	G63878		194267	61642		372345	G51727		373297	G51993	
175409	61718		194267	81921		372349	69465		373301	G51832	
175441	61710		194432	81667		372350	G51910		373303	G51966	
175442	G63875		194506	61676		372351	G51908		373305	G51833	
175448	61682		194506	81926		372360	70056		373307	70037	
175449	61713		194510	69575		372361	G51852		373308	G51847	
175450	81744		194511	G63625		372362	G51841		373312	G64056	
175452	61690		194539	69574		372364	70052		373313	70089	
175454	69595		194539	69575		372366	G51905		373314	G51884	
175456	69594		194564	81869		372370	70055		373315	G511055	
175457	G64031		194574	69575		372382	70056		373316	G511054	

Important Note: Competitive Interchanges are to be used for stocking purposes only. Where multiple crosses are identified, please reference the applications section of this catalog. / **Remarque importante:** Les interchanges concurrentiels ne s'utilisent qu'aux fins de stocks. Dans le cas de références multiples, consulter la section des applications du catalogue. / **Nota importante:** Dans le cas de références multiples, consulter la section des applications du catalogue. / **Nota importante:** Se pueden usar intercambios competitivos para propósitos de almacenamiento solamente. Cuando se identifican intercambios múltiples, consulte la sección de aplicaciones de este catálogo.

COMPETITIVE & O.E.M. INTERCHANGE LIST
Lista de Intercambios contra Competidores y Equipo Original.
Liste dinterchange de produits comptitifs & dquipement original (OEM)

PRT (ADD)... cont'd

Prt (add)	Gabriel	Upgrade	Prt (add)	Gabriel	Upgrade	Prt (add)	Gabriel	Upgrade	Prt (add)	Gabriel	Upgrade
373317	G51848		390107	70052		473402	G56894		474133	G52165	
373318	G51863		392226	70033		473403	G52098		474133	G52298	
373319	70059		392226	70038		473407	G51814		474134	G52164	
373319	70204		392352	G51746		473408	G51813		474134	G52297	
373320	70053		392383	G511001		473439	G56529		474135	G55676	
373330	G51799		392393	G511001		473440	G56530		474136	G55675	
373333	G51825		393171	G51477		473453	G51815		474177	G56517	
373348	G51856		393338	G51922		473454	G51806		474178	G56516	
373352	69420		394058	G51077		473465	G51878		474209	G52106	
373358	G511002		394075	G51887		473466	G51877		474210	G52105	
373358	G511134		394076	G51888		473485	70068		474215	G52265	
373367	G511122		394091	G51477		473485	70209		474215	G56821	
373368	G511122		414649	G56735		473671	G56893		474216	G52264	
373373	G51933		414909	G56733		473672	G56892		474216	G56822	
373374	G64049		470110	G55910		473685	G51714		474241	G52106	
373376	G51961		470401	G52248		473719	G55999		474242	G52105	
373380	G51898		470402	G52247		473720	G55999		474243	G56841	
373382	G51972		470405	G52163		473761	G56887		474244	G56840	
373385	G511044		470406	G52162		473762	G56886		474247	G52246	
373386	G64216		470407	G52332		473817	G52018		474248	G52245	
373804	G51850		470408	G52331		473818	G52017		474249	G52122	
374067	G51704		470409	G52204		473821	G56529		474250	G52121	
374070	G51719		470410	G52203		473822	G56530		474251	G52174	
374070	G51860		470411	G52118		473851	G51926		474252	G52173	
374071	G51729		470412	G52117		473852	G51925		474257	G52171	
374074	G51723		470427	G52131		473859	G52095		474258	G52170	
374078	G51703		470455	G51774		473860	G52094		474261	G52246	
374085	G51849		470465	G52183		473863	G52283		474262	G52245	
374086	G51849		470466	G52182		473864	G52282		474274	G52131	
374090	G51477		470467	G52103		473879	G51859		474283	G52202	
374091	G51477		470468	G52104		473880	G51859		474284	G52201	
374110	G56838		470470	G52103		473885	G51806		474305	G52238	
374111	G56839		470475	G52210		473897	70049		474306	G52237	
374112	G51937		470476	G52209		473899	G51718		474311	G56633	
374113	G51855		470489	G52176		473901	G51911		474312	G56634	
374116	69998		470490	G52175		473909	G51897		474317	G52300	
374117	G51742		470767	G52103		473910	G51896		474318	G52299	
374126	G51861		471045	G51097		473911	G51892		474319	G55772	
374128	G51900		471055	G55999		473911	G51919		474321	G51267	
374130	G51916		471056	G55999		473913	G51097		474323	G55856	
374130	G51975		471288	G55772		473915	G51815		474354	G55896	
375007	69998		471385	G52161		473919	G52153		474363	G52261	
375022	G51724		471386	G52160		473920	G52152		474364	G52260	
375023	G51722		472057	G56540		473925	G56887		474368	G51728	
375024	G51715		472058	G56539		473926	G56886		474381	G55892	
375027	G51928		472079	G52354		473935	G51980		474385	G52108	
375028	G51870		472080	G52353		473944	G64121		474386	G52107	
375028	G51891		472101	G51859		474008	G52025		474397	G55901	
375028	G51949		472102	G51859		474008	G55948		474399	G55901	
375030	G51765		472119	G511003		474015	G52244		474403	G55698	
375031	G51766		473003	G56514		474015	G55949		474407	G56620	
375032	G51860		473004	G56506		474103	G52027		474409	G52275	
375033	G51861		473073	G56662		474103	G52128		474410	G52274	
375034	G51864		473074	G56661		474104	G52026		474416	G56655	
375037	G51865		473206	G51806		474104	G52127		474431	G52188	
375038	G51865		473340	G51268		474121	G56802		474432	G52187	

Important Note: Competitive Interchanges are to be used for stocking purposes only. Where multiple crosses are identified, please reference the applications section of this catalog./ **Remarque importante:** Les interchanges concurrentiels ne s'utilisent qu'aux fins de stocks. Dans le cas de rfrences multiples, consulter la section des applications du catalogue./ **Nota importante:** Dans le cas de rfrences multiples, consulter la section des applications du catalogue./ **Nota importante:** Se pueden usar intercambios competitivos para propósitos de almacenamiento solamente. Cuando se identifican intercambios múltiples, consulte la sección de aplicaciones de este catálogo.

COMPETITIVE & O.E.M. INTERCHANGE LIST
Lista de Intercambios contra Competidores y Equipo Original.
Liste dinterchange de produits comptitifs & dquipement original (OEM)

PRT (ADD)... cont'd

Prt (add)	Gabriel	Upgrade	Prt (add)	Gabriel	Upgrade	Prt (add)	Gabriel	Upgrade	Prt (add)	Gabriel	Upgrade
474433	G52155		474885	G55993		475107	G56700		475916	G52127	
474433	G52188		474886	G55994		475123	G56616		476007	G56778	
474434	G52154		474887	G56635		475123	G56688		476517	G52157	
474462	G56817		474888	G56636		475124	G56615		476518	G52156	
474468	G51267		474907	G56680		475124	G56687		476555	G52143	
474480	G51097		474907	G56731		475139	G56791		476556	G52142	
474482	G51740		474908	G56679		475139	G56792		476557	G52128	
474485	G56581		474908	G56730		475149	G52145		476558	G52127	
474486	G56582		474909	G56733		475150	G52144		476565	G52125	
474513	G52006		474910	G56732		475211	G56561		476615	G52149	
474514	G52005		474910	G56734		475212	G56562		476616	G52148	
474517	G52155		474917	G56672		475215	G56821		476617	G52294	
474518	G52154		474918	G56671		475216	G56822		476618	G52293	
474545	G56758		474923	G56722		475217	G51799		476619	G52254	
474546	G56759		474924	G56721		475217	G56899		476620	G52253	
474547	G56660		474929	G52033		475219	G51799		476621	70096	
474548	G56661		474930	G52032		475219	G56899		476623	G56837	
474553	G56894		474931	G52111		475239	G56688		476624	G56516	
474557	G56820		474932	G52110		475240	G56687		476624	G56836	
474558	G56819		474933	G56843		475267	G52159		476625	70096	
474577	G52009		474934	G56842		475268	G52158		476665	G52375	
474578	G52008		474937	G52157		475277	G52113		476666	G52374	
474579	G56581		474938	G52156		475278	G52112		476733	G52258	
474580	G56582		474939	G52185		475279	G52250		476734	G52257	
474583	G52014		474940	G52184		475280	G52249		476739	G52361	
474584	G52013		474941	G52082		475281	G55948		476740	G52360	
474587	G56735		474942	G52081		475283	G56509		476743	G52525	
474588	G56734		474947	G52007		475287	G52169		476744	G52524	
474588	G56735		474948	G52004		475288	G52168		476745	G52356	
474607	G51760		474955	G52104		475289	G52151		476746	G52355	
474608	G51761		474956	G52103		475290	G52150		476751	G52330	
474617	G52108		474963	G52104		475297	G52200		476752	G52329	
474617	G56797		474964	G52103		475298	G52199		476755	G52128	
474618	G52107		474969	G56810		475303	G52025		476756	G52127	
474618	G56798		474970	G56810		475303	G55948		476757	G52399	
474621	G51097		474981	G52274		475305	G52130		476758	G52398	
474635	G56729		474982	G52275		475306	G52129		476761	G52383	
474636	G56728		474989	G52097		475309	G52281		476762	G52382	
474650	G56734		474990	G52096		475310	G52280		476767	G52406	
474653	G56773		474991	G56809		475311	G52244		476793	G52301	
474654	G56774		474992	G56809		475315	G52113		476821	G52440	
474659	G52141		475033	G52314		475316	G52112		476822	G52439	
474660	G52140		475034	G52314		475321	G56799		476851	G52349	
474704	G51758		475071	G56537		475322	G56800		476852	G52348	
474705	G51758		475071	G56538		475323	G56791		477103	G52256	
474729	G55697		475071	G56633		475323	G56792		477104	G52255	
474743	G56622		475072	G56538		475327	G56799		477213	G51738	
474744	G56621		475072	G56634		475328	G56800		477701	G51738	
474772	G56802		475077	G55681		475331	G56778		478281	G52330	
474776	G56606		475078	G56509		475347	G52116		478282	G52329	
474805	G56641		475084	G56807		475697	G511000		478289	G56758	
474806	G56640		475091	G56616		475725	G52352		478290	G56759	
474850	G52237		475091	G56688		475725	G56841		478313	G52006	
474851	G52238		475092	G56615		475726	G52351		478314	G52005	
474863	G56568		475092	G56687		475726	G56840		478323	G52396	
474864	G56601		475097	G56726		475915	G52128		478324	G52395	

Important Note: Competitive Interchanges are to be used for stocking purposes only. Where multiple crosses are identified, please reference the applications section of this catalog. / **Remarque importante:** Les interchanges concurrentiels ne s'utilisent qu'aux fins de stocks. Dans le cas de rferences multiples, consulter la section des applications du catalogue. / **Nota importante:** Dans le cas de rferences multiples, consulter la section des applications du catalogue. / **Nota importante:** Se pueden usar intercambios competitivos para propósitos de almacenamiento solamente. Cuando se identifican intercambios múltiples, consulte la sección de aplicaciones de este catálogo.

COMPETITIVE & O.E.M. INTERCHANGE LIST
Lista de Intercambios contra Competidores y Equipo Original.
Liste dinterchange de produits comptitifs & dquipement original (OEM)

PRT (ADD)... cont'd

Prt (add)	Gabriel	Upgrade	Prt (add)	Gabriel	Upgrade	Prt (add)	Gabriel	Upgrade	Prt (add)	Gabriel	Upgrade
478479	G52330		710420	G57683		713391	G57573		810426	G57658	
478480	G52329		710423	G57573		713392	G57572		810473	G57191	
478587	G52383		710424	G57572		713397	G57598		810474	G57190	
478588	G52382		710475	G57080		713398	G57597		811021	G56726	
478675	G51947		710761	G57173		714004	G57019		811045L	G57135	
478675	G51948		710771	G57706		714009	G57124		811045R	G57136	
492117	70031		710787	G57683		714009	G57221		811046L	G56991	
493923	G51921		710788	G57683		714010	G57123		811046R	G56992	
493924	G51920		710793	G57415		714010	G57220		812057	G57089	
496629	G51871		710794	G57414		714058L	G57065		812058	G57088	
583052	6850SE		710797	G57453		714058R	G57066		812102	G57148	
583053	6847SE		710798	G57454		714067	G57020		813003	G56931	
583059	6847SE		710863	G57703		714068	G57021		813004	G56930	
583060	6853SE		710864	G57794		714071	G57016		813073	G56950	
584027	6856SE		710871	G57453		714075	G57080		813074	G56949	
710002	G57118		710872	G57454		714078	G57021		813258L	G56993	
710077	G57026		710875	G57134		714087	G57015		813258R	G56994	
710077	G57075		710876	G57133		714087	G57212		813331	G57022	
710078	G57103		710877	G57683		714088	G57095		813338	G57014	
710079	G57087		710878	G57683		714089	G57096		813453	G57146	
710080	G57086		710879	G57683		714109	G57023		813487	G57409	
710081	G57132		710880	G57683		714109	G57125		813491	G57035	
710082	G57132		710880	G57683		715022	G57018		813492	G57034	
710083	G57108		710970	G57000		715023	G57017		813493	G57048	
710084	G57107		710970	G57023		715029	G57172		813494	G57047	
710098	G57282		710974	G57067		715101	G57173		813497	G56997	
710099	G57027		710983	G57068		740098	G57282		813498	G56996	
710103	G57178		710984	G57067		745297	G52200		813653	G57397	
710103	G57607		711010	G56943		810071	G57466		813681	G57013	
710139	G57425		711011	G57703		810072	G57465		813685	G57059	
710140	G57424		711016	G57057		810110	G56998		813781	G57203	
710150L	G57416		711077	G57075		810121	G57039		813782	G57202	
710150R	G57682		711193	G57092		810121	G57039		813782	G57202	
710251	G57282		711349	G57134		810145	G57354		813845	G57456	
710252	G57092		711350	G57133		810146	G57353		813846	G57455	
710307	G57092		711388	G57413		810147	G57645		813859	G57201	
710310	G57423		711388	G57646		810148	G57644		813860	G57200	
710311	G57598		711389	G57075		810161	G57391		813863	G57542	
710312	G57597		711392	G57423		810162	G57390		813864	G57541	
710315	G57647		712006	G57036		810163	G57635		813919	G57604	
710317	G57646		712161	G57159		810164	G57634		813920	G57603	
710362	G57421		712161	G57160		810173	G56933		814008	G56925	
710370	G57675		713002	G57010		810174	G56932		814008	G57060	
710371	G57703		713005	G57062		810199	G57500		814009	G57038	
710373	G57429		713006	G57061		810200	G57499		814010	G57037	
710374	G57428		713111L	G57090		810407	G57739		814015L	G56924	
710375	G57646		713111R	G57091		810408	G57738		814015R	G56925	
710377	G57452		713123	G56938		810409	G57484		814043	G56936	
710378	G57451		713171L	G57027		810410	G57483		814078	G56936	
710410	G57023		713171R	G57027		810410	G57658		814079	G56934	
710411	G57036		713193	G57056		810411	G57466		814079	G56937	
710412	G57579		713198L	G57133		810412	G57465		814121	G57040	
710413	G57000		713198R	G57134		810413	G57659		814128	G56927	
710415	G57080		713223	G57607		810414	G57658		814135	G56933	
710416	G57173		713278L	G57451		810415	G57677		814136	G56932	
710419	G57683		713278R	G57452		810416	G57676		814139	G56928	
			713318	G57447		810425	G57659		814177	G57064	

Important Note: Competitive Interchanges are to be used for stocking purposes only. Where multiple crosses are identified, please reference the applications section of this catalog. / **Remarque importante:** Les interchanges concurrentiels ne s'utilisent qu'aux fins de stocks. Dans le cas de rfrences multiples, consulter la section des applications du catalogue. / **Nota importante:** Dans le cas de rfrences multiples, consulter la section des applications du catalogue. / **Nota importante:** Se pueden usar intercambios competitivos para propósitos de almacenamiento solamente. Cuando se identifican intercambios múltiples, consulte la sección de aplicaciones de este catálogo.

COMPETITIVE & O.E.M. INTERCHANGE LIST
Lista de Intercambios contra Competidores y Equipo Original.
Liste dinterchange de produits comptitifs & dquipement original (OEM)

PRT (ADD)... cont'd

Prt (add)	Gabriel	Upgrade	Prt (add)	Gabriel	Upgrade	Prt (add)	Gabriel	Upgrade	Prt (add)	Gabriel	Upgrade
814178	G57063		814805	G57168		815211	G57140		815981	G57480	
814231	G57460		814806	G57167		815212	G57139		815982	G57331	
814232	G57459		814879	G56933		815213	G57050		815982	G57479	
814241	G57376		814879	G57044		815214	G57049		816053	G56931	
814241	G57666		814880	G56932		815215	G57344		816054	G56930	
814242	G57375		814880	G57043		815216	G57343		816057	G56948	
814242	G57665		814907	G57151		815219	G57156		816058	G56948	
814243	G57583		814908	G57150		815219	G57277		816083	G57516	
814244	G57582		814909	G57153		815289	G57334		816084	G57515	
814251	G57474		814910	G57152		815290	G57333		816089	G57205	
814252	G57473		814917	G57031		815299	G57060		816090	G57204	
814319	G56928		814918	G57030		815299	G57142		816091	G57405	
814323	G56964		814923	G57077		815365	G57141		816092	G57404	
814354	G56965		814924	G57076		815367	G57193		816101	G56925	
814368L	G57007		814961	G57070		815368	G57192		816102	G56924	
814368R	G57008		814961	G57122		815373	G57397		816125	G57145	
814381	G56975		814962	G57069		815377	G57055		816126	G57144	
814385	G57664		814962	G57121		815378	G57054		816131	G57472	
814386	G57663		814989	G57370		815395	G57496		816132	G57471	
814405	G57012		814990	G57369		815396	G57495		816225	G57008	
814406	G57011		815007	G57085		815457	G57115		816226	G57007	
814407L	G56956		815008	G57084		815458	G57114		816329	G57051	
814407R	G56957		815009	G57046		815480	G57105		816333	G57035	
814413	G57127		815010	G57045		815881	G57559		816334	G57034	
814414	G57126		815010	G57046		815882	G57558		816335	G57193	
814423	G57006		815011	G57051		815883	G57373		816336	G57192	
814433	G57276		815013	G57053		815883	G57664		816339	G57142	
814434	G57275		815017	G57039		815884	G57372		816339	G57498	
814523	G57342		815019	G57649		815884	G57663		816340	G57497	
814524	G57341		815020	G57648		815907	G57274		816343	G57709	
814525	G57158		815023	G56925		815913	G57394		816345	G57022	
814526	G57157		815024	G56924		815914	G57393		816348	G57192	
814545	G57120		815025	G56925		815915	G57198		816385	G57151	
814546	G57119		815026	G56924		815915	G57323		816386	G57150	
814547	G57115		815027	G57075		815916	G57197		816387	G57582	
814548	G57114		815029	G57613		815916	G57198		816509	G57276	
814557	G57219		815030	G57612		815916	G57322		816510	G57275	
814558	G57218		815037	G57026		815917	G57567		816549	G57482	
814579	G57106		815037	G57075		815918	G57566		816550	G57481	
814580	G57105		815041	G57145		815925	G57106		816551	G57674	
814587	G57534		815042	G57144		815926	G57105		816552	G57673	
814588	G57533		815043	G57497		815937	G57427		816553	G57484	
814635	G57077		815044	G57497		815939	G57330		816554	G57483	
814635	G57079		815047	G57153		815940	G57329		816615	G57267	
814636	G57076		815048	G57152		815943	G57198		816615	G57751	
814636	G57078		815049	G57747		815944	G57197		816616	G57266	
814743	G57050		815051	G57747		815949	G57422		816616	G57750	
814743	G57522		815052	G57746		815953	G57550		816631	G57068	
814744	G57049		815078	G56929		815954	G57549		816631	G57358	
814744	G57521		815123	G57145		815959	G57148		816632	G57067	
814765	G57279		815124	G57144		815959	G57270		816632	G57357	
814766	G57278		815165	G56935		815967	G57466		816633	G57193	
814773	G57158		815187	G56963		815967	G57578		816634	G57192	
814774	G57157		815187	G56964		815968	G57465		816635	G57191	
814797	G57042		815188	G56962		815968	G57577		816635	G57540	
814798	G57041		815188	G56963		815981	G57332		816636	G57190	

Important Note: Competitive Interchanges are to be used for stocking purposes only. Where multiple crosses are identified, please reference the applications section of this catalog. / **Remarque importante:** Les interchanges concurrentiels ne s'utilisent qu'aux fins de stocks. Dans le cas de références multiples, consulter la section des applications du catalogue. / **Nota importante:** Dans le cas de références multiples, consulter la section des applications du catalogue. / **Nota importante:** Se pueden usar intercambios competitivos para propósitos de almacenamiento solamente. Cuando se identifican intercambios múltiples, consulte la sección de aplicaciones de este catálogo.

COMPETITIVE & O.E.M. INTERCHANGE LIST
Lista de Intercambios contra Competidores y Equipo Original.
Liste dinterchange de produits comptitifs & dquipement original (OEM)

PRT (ADD)... cont'd

Prt (add)	Gabriel	Upgrade	Prt (add)	Gabriel	Upgrade	Prt (add)	Gabriel	Upgrade	Prt (add)	Gabriel	Upgrade
816636	G57539		817012	G57489		818222	G57377		818693	G56933	
816637	G57191		817021	G57702		818289	G57606		818694	G56932	
816638	G57190		817022	G57701		818290	G57605		818695	G57565	
816639	G57060		817025	G57702		818297	G57690		818696	G57564	
816639	G57142		817026	G57701		818298	G57689		818885	G57098	
816643	G57129		817029	G57391		818305	G57120		818886	G57097	
816644	G57128		817030	G57390		818306	G57119		818891	G57561	
816645	G57131		817033	G57725		818307	G56951		818892	G57560	
816646	G57130		817034	G57724		818315	G57587		818899	G57812	
816651	G57111		817037	G57060		818316	G57586		818903	G57696	
816651	G57536		817041	G57725		818325	G56925		818904	G57695	
816652	G57110		817042	G57724		818326	G56924		818905	G57733	
816652	G57535		817059	G57142		818327	G57401		818906	G57732	
816653	G57113		817109	G57578		818328	G57400		818907	G57546	
816654	G57112		817110	G57577		818329	G57399		818908	G57545	
816657	G57138		817111	G57346		818330	G57398		818909	G57727	
816658	G57137		817112	G57345		818345	G57456		818910	G57726	
816679	G57099		817129	G57496		818345	G57595		818913	G57472	
816679	G57100		817130	G57495		818346	G57455		818914	G57471	
816681	G57206		817131	G57340		818346	G57594		818917	G57694	
816682	G57206		817132	G57339		818587	G57494		818918	G57693	
816705	G57149		817135	G57747		818588	G57493		818919	G57700	
816715	G57391		817136	G57746		818591	G57162		818920	G57699	
816716	G57390		817137	G57629		818592	G57161		818925	G57494	
816735	G57163		817137	G57705		818595	G57544		818926	G57493	
816736	G57164		817138	G57628		818596	G57543		818929	G57812	
816753	G57270		817138	G57704		818609	G57482		818931	G57083	
816769	G57733		817143	G57373		818610	G57481		818932	G57083	
816770	G57732		817144	G57372		818611	G57340		818933	G57690	
816773	G57427		817151	G57698		818612	G57339		818934	G57689	
816783	G57031		817152	G57697		818613	G57463		818941	G57206	
816784	G57030		817153	G57583		818614	G57464		818942	G57206	
816787	G57208		817157	G57496		818615	G57206		818945	G57083	
816788	G57207		817158	G57495		818616	G57206		818949	G57083	
816799	G57323		817163	G57418		818617	G57498		818961	G57518	
816800	G57322		817164	G57417		818618	G57497		818962	G57517	
816809	G57185		817177	G57378		818625	G57463		818983	G57206	
816810	G57184		817178	G57377		818626	G57464		818985	G57206	
816839	G57269		817487	G57378		818629	G57198		818986	G57206	
816840	G57268		817488	G57377		818630	G57197		818991	G57206	
816841	G57271		817895	G57518		818653	G57147		818992	G57206	
816937	G57419		817896	G57517		818667	G57649		819363	G57071	
816947	G57162		818050	G57746		818668	G57648		819363	G57072	
816947	G57368		818065	G57804		818669	G57039		819379	G57713	
816948	G57161		818066	G57803		818671	G57051		819380	G57712	
816948	G57367		818187	G57659		818675	G57194		819565	G57198	
816949	G57223		818188	G57658		818675	G57195		819565	G57323	
816950	G57222		818207	G57735		818677	G57148		819565	G57550	
816951	G57082		818208	G57734		818679	G57203		819566	G57197	
816952	G57081		818215	G57340		818680	G57202		819566	G57322	
816955	G57177		818216	G57339		818683	G57563		819566	G57549	
816956	G57176		818217	G57692		818684	G57562		819567	G57198	
816957	G57109		818218	G57691		818689	G57474		819567	G57323	
816957	G57314		818219	G57659		818690	G57473		819567	G57550	
816959	G57324		818220	G57658		818691	G57378		819568	G57197	
817011	G57490		818221	G57378		818692	G57377		819568	G57322	

Important Note: Competitive Interchanges are to be used for stocking purposes only. Where multiple crosses are identified, please reference the applications section of this catalog./ **Remarque importante:** Les interchanges concurrentiels ne s'utilisent qu'aux fins de stocks. Dans le cas de rfrences multiples, consulter la section des applications du catalogue./ **Nota Importante:** Dans le cas de rfrences multiples, consulter la section des applications du catalogue./ **Nota Importante:** Se pueden usar intercambios competitivos para propósitos de almacenamiento solamente. Cuando se identifican intercambios múltiples, consulte la sección de aplicaciones de este catálogo.

COMPETITIVE & O.E.M. INTERCHANGE LIST
Lista de Intercambios contra Competidores y Equipo Original.
Liste d'interchange de produits compétitifs & d'équipement original (OEM)

PRT (ADD)... cont'd

Prt (add)	Gabriel	Upgrade	Prt (add)	Gabriel	Upgrade	Prt (add)	Gabriel	Upgrade	Prt (add)	Gabriel	Upgrade
819568	G57549		920240	G57360		925011	83028		925069	89407	
819569	G57198		920241	G57497		925012	83029		925070	83209	89414
819569	G57323		920242	G57498		925013	83035		925070	89414	
819570	G57197		920243	G57764		925014	83038		925071	83215	
819570	G57322		920244	G57765		925015	83039		925072	83216	
819573	G57031		920245	G57724		925016	83040		925073	83219	
819574	G57030		920246	G57725		925017	83041		925074	83221	
819575	G57140		920249	G57444		925018	83042		925075	83225	
819576	G57139		920250	G57444		925019	83044		925076	83303	
819579	G57330		920273	G57222		925021	83047		925078	83308	
819580	G57329		920274	G57223		925022	83048		925079	83309	
819581	G57330		920279	G57161		925024	83050		925080	83312	89409
819582	G57329		920280	G57162		925025	83051		925080	89409	
819583	G57350		920281	G57076		925026	83053		925081	83314	
819584	G57349		920282	G57077		925027	83054		925082	83317	
819587	G57463		920283	G57720		925028	83056		925083	83364	
819588	G57464		920284	G57721		925029	83062		925084	83391	
819789	G57498		920285	G57689		925030	83065		925085	83395	
819790	G57498		920286	G57690		925033	83081		925086	83400	
819931	G56974		920295	G57772		925034	83101		925088	83518	
819932	G56973		920296	G57773		925035	83103		925089	83519	
920009	G57635		920297	G57716		925036	83107		925090	83613	
920010	G57634		920298	G57717		925037	83109		925091	83901	
920020	G57635		920305	G57780		925038	83112		925093	83906	
920021	G57634		920306	G57781		925039	83114		925094	85001	89410
920041	G57518		920319	G57220		925040	83120		925094	89410	
920042	G57517		920320	G57221		925041	83122	89406	925095	85004	
920059	G57748		920325	G57720		925041	89406		925096	85005	89430
920076	G57748		920326	G57721		925042	83123	89405	925096	89430	
920081	G57690		920331	G57772		925042	89405		925097	85006	
920082	G57689		920332	G57773		925043	83124	89407	925098	85007	
920101	G57765		920344	G57420		925043	89407		925099	85009	
920102	G57764		920345	G57800		925044	83125		925100	85012	89413
920103	G57765		920346	G57801		925045	83126	89430	925100	89413	
920104	G57764		920347	G57799		925045	89430		925101	85013	89414
920118	G57421		920348	G57752		925046	83131		925101	89414	
920132	G57703		920349	G57753		925047	83134		925102	85014	
920134	G57156		920350	G57697		925048	83135		925103	85023	89415
920135	G57156		920351	G57698		925049	83136		925103	89415	
920136	G57156		920416	G57450		925050	83137		925104	85024	
920159	G57764		920417	G57449		925051	83140		925105	85026	
920161	G57734		920419	G57775		925052	83141		925106	85029	
920162	G57735		920420	G57774		925053	83142		925107	85030	89440
920165	G57803		920770	G57364		925054	83143		925107	89440	
920166	G57804		920771	G57363		925055	83147		925108	85031	
920169	G57784		925000	83002		925057	83154		925109	85033	89427
920170	G57785		925001	83008		925059	83159		925109	89427	
920181	G57772		925002	83011		925060	83160		925110	85036	89405
920182	G57773		925003	83012		925061	83162		925110	89405	
920200	G57716		925004	83016		925063	83166		925111	85043	
920201	G57717		925005	83017		925064	83169		925112	85046	89434
920215	G57780		925006	83021		925065	83175		925112	89434	
920216	G57781		925007	83023		925066	G63622		925113	85047	89435
920229	G57337		925008	83024		925067	G63623		925113	89435	
920230	G57338		925009	83025		925068	83180		925114	85054	
920239	G57359		925010	83027		925069	83207	89407	925115	85055	89439

Important Note: Competitive Interchanges are to be used for stocking purposes only. Where multiple crosses are identified, please reference the applications section of this catalog. / **Remarque importante:** Les interchanges concurrentiels ne s'utilisent qu'aux fins de stocks. Dans le cas de références multiples, consulter la section des applications du catalogue. / **Nota importante:** Dans le cas de références multiples, consulter la section des applications du catalogue. / **Nota importante:** Se pueden usar intercambios competitivos para propósitos de almacenamiento solamente. Cuando se identifican intercambios múltiples, consulte la sección de aplicaciones de este catálogo.

COMPETITIVE & O.E.M. INTERCHANGE LIST
Lista de Intercambios contra Competidores y Equipo Original.
Liste dinterchange de produits comptitifs & dquipement original (OEM)

PRT (ADD)... cont'd

Prt (add)	Gabriel	Upgrade	Prt (add)	Gabriel	Upgrade	Prt (add)	Gabriel	Upgrade	Prt (add)	Gabriel	Upgrade
925115	89439		925160	89429		925226	85988		925283	85079	
925116	85058	89431	925161	85329		925227	85989		925284	85087	
925116	89431		925162	85331		925228	85994		925286	85300	89419
925118	85061	89450	925163	85335		925229	85995		925286	89419	
925119	85062	89408	925165	85343		925231	83001		925287	85305	
925119	89408		925166	85376		925232	83003		925288	85318	
925120	85063		925167	85637		925233	83004		925289	85321	
925121	85065		925168	85639		925235	83006		925290	85322	
925122	85066	89448	925169	85642		925236	83009		925291	85323	89436
925122	89448		925173	85716		925238	83018		925291	89436	
925123	85067	89451	925174	85722		925239	83019		925292	85332	
925123	89451		925175	85724	89443	925241	83022		925293	85333	
925124	85069	89455	925175	89443		925242	83031		925294	85334	
925124	89455		925178	85900		925243	83102		925295	85337	
925125	85070	89459	925179	85906	89407	925244	83105		925296	85338	
925125	89459		925179	89407		925245	83110		925297	85339	
925126	85071		925180	85909		925246	83111		925298	85340	
925127	85072		925181	85918	89449	925247	83113		925299	85341	
925128	85080		925181	89449		925249	83119		925301	85345	
925129	85081		925182	85919		925250	83127		925302	85351	
925130	85082		925183	85920	89503	925251	83128	89436	925303	85382	
925131	85084	89460	925183	89503		925251	89436		925304	85638	
925131	89460		925184	85656		925252	83130		925306	85702	
925132	85086		925185	85927		925254	83144		925307	85704	
925133	85088		925186	85928		925255	83148		925308	85708	
925134	85090		925187	85932	89453	925256	83149		925309	85709	
925135	85061	89450	925187	89453		925257	83150		925310	85711	
925136	85102		925188	85956		925258	83158		925311	85712	
925137	85106		925189	85958		925259	83164		925314	85723	
925138	85109		925190	85959		925260	83168		925315	85727	
925139	85119		925191	85965		925261	83203	89436	925316	85728	
925142	85124		925192	85967		925261	89436		925317	85729	
925143	85125		925193	85976		925262	83214		925318	85733	
925145	85180		925194	89402		925264	83301		925319	85734	
925146	85181		925199	G63306		925265	83318		925321	89432	
925148	85301		925208	G63610		925266	83363		925330	85737	
925149	85302	89420	925209	85736		925267	83389	89436	925331	85738	
925149	89420		925210	85902		925267	89436		925332	85739	
925150	85303	89422	925211	85921		925268	83401		925333	85740	
925150	89422		925212	85923	89458	925269	83456	89447	925334	85901	
925151	85304		925212	89458		925269	89447		925336	85908	
925152	85307		925213	85924	89457	925270	83635		925337	85910	
925153	85308	89422	925213	89457		925271	85000	89436	925338	85911	
925153	89422		925214	85931	89458	925271	89436		925339	85916	89430
925154	85310	89423	925214	89458		925272	85003	89411	925339	89430	
925154	89423		925215	85933	89454	925272	89411		925340	85648	
925155	85311	89424	925215	89454		925273	85010		925341	85929	
925155	89424		925216	85936	89456	925274	85027		925342	85934	
925156	85314	89425	925216	89456		925275	85040		925343	85935	
925156	89425		925217	85937		925276	85045		925344	85938	
925157	85315		925218	85954		925277	85051		925345	85939	
925158	85316	89426	925219	85957		925278	85052		925346	85955	
925158	89426		925220	85963		925279	85053	89442	925347	85961	
925159	85319	89428	925221	85964		925279	89442		925348	85962	
925159	89428		925222	85972		925281	85064		925349	85970	
925160	85320	89429	925224	85985		925282	85078		925353	87015	

Important Note: Competitive Interchanges are to be used for stocking purposes only. Where multiple crosses are identified, please reference the applications section of this catalog. / **Remarque importante:** Les interchanges concurrentiels ne s'utilisent qu'aux fins de stocks. Dans le cas de rfrences multiples, consulter la section des applications du catalogue. / **Nota importante:** Dans le cas de rfrences multiples, consulter la section des applications du catalogue. / **Nota importante:** Se pueden usar intercambios competitivos para propósitos de almacenamiento solamente. Cuando se identifican intercambios múltiples, consulte la sección de aplicaciones de este catálogo.

COMPETITIVE & O.E.M. INTERCHANGE LIST
Lista de Intercambios contra Competidores y Equipo Original.
Liste dinterchange de produits comptitifs & dquipement original (OEM)

PRT (ADD)... cont'd

Prt (add)	Gabriel	Upgrade	Prt (add)	Gabriel	Upgrade	Prt (add)	Gabriel	Upgrade	Prt (add)	Gabriel	Upgrade
925355	87018		925380	89437		925607	83007		930848	14072	
925363	83015		925397	81744		930201	G51934		932801	70096	
925364	83026		925406	85979		930202	G51934		932803	61655	
925365	83030		925449	G63456		930228	G52172		932805	G51721	
925367	83034		925525	61682		930288	81676		932806	G51901	
925368	83059		925531	61685		930293	G51921		932819	G52495	
925372	83204		925547	81318		930294	G51920		932820	G52494	
925373	83242		925562	G63889		930532	70040		932845	G511044	
925377	85700		925563	G63889		930665	G52295		932855	69952	
925378	85705	89447	925566	61711		930754	G511037		932874	85007	
925378	89447		925567	61713		930792	70040		990002	49255	
925379	85732		925579	81920		930799	G51965				

Rameriz Trailer

Rameriz trailer	Gabriel	Upgrade	Rameriz trailer	Gabriel	Upgrade	Rameriz trailer	Gabriel	Upgrade	Rameriz trailer	Gabriel	Upgrade
18165-01	85006		1816501	85006							

Rancho

Rancho	Gabriel	Upgrade	Rancho	Gabriel	Upgrade	Rancho	Gabriel	Upgrade	Rancho	Gabriel	Upgrade
RS5006	G63689		RS5147	G63403		RS5262	G63866		RS5413	6856SE	
RS5008	G63928		RS5147	G63454		RS5262	G64101		RS55784	G51891	
RS5029	G63905		RS5150	G63609		RS5263	G63803		RS55803	G51865	
RS5039	G63608		RS5150	G63818		RS5265	G63783		RS55804	G51864	
RS5039	G63614		RS5151	G63347		RS5267	G63809		RS55830	G51949	
RS5039	G63635		RS5151	G63411		RS5269	G63961		RS5602	G63950	
RS5040	G63815		RS5158	G63432		RS5269	G64000		RS5605	G63902	
RS5041	G63815		RS5165	G63455		RS5274	G63962		RS5605	G63909	
RS5042	G63886		RS5166	G63489		RS5281	G63958		RS5609	G63903	
RS5045	G63888		RS5168	G63511		RS5282	G63848		RS5609	G63915	
RS5111	G63183		RS5180	G63494		RS5284	G63844		RS5609	G63937	
RS5112	G63692		RS5185	G63679		RS5285	G63870		RS5753	G51723	
RS5112	G63775		RS5187	G63548		RS5287	G63867		RS5753	G56838	
RS5113	G63413		RS5187	G63726		RS5295	G63817		RS5754	G56839	
RS5113	G63490		RS5188	G63813		RS5299	G63882		RS5757	G51815	
RS5115	G63387		RS5190	G63488		RS5300	G63884		RS5758	G51855	
RS5116	G63353		RS5195	G63661		RS5301	G63879		RS5762	G51077	
RS5116	G63492		RS5197	G63673		RS5308	G63965		RS5763	G51077	
RS5117	G63350		RS5198	G63959		RS5315	G63890		RS5764	G51728	
RS5117	G63461		RS5199	G63359		RS5315	G63891		RS5767	G51704	
RS5118	G63349		RS5203	G63604		RS5319	G63889		RS5774	G51703	
RS5118	G63409		RS5208	G63616		RS5319	G64006		RS5775	G51854	
RS5118	G63419		RS5213	G63781		RS5324	G64038		RS5776	G51853	
RS5118	G63510		RS5214	G63495		RS5326	G64008		RS5777	G51739	
RS5120	G63357		RS5214	G63611		RS5368	G64043		RS5784	G51870	
RS5123	G63423		RS5214	G63707		RS5384	G64079		RS5808	G51856	
RS5124	G63422		RS5215	G63708		RS5385	G63837		RS5817	G51718	
RS5124	G63638		RS5221	G64009		RS5386	G63842		RS5821	G51722	
RS5125	G63525		RS5222	G63421		RS5388	G64016		RS5826	G56807	
RS5125	G63773		RS5223	G63782		RS5389	G63892		RS5827	G51715	
RS5126	G63524		RS5229	G63678		RS5394	G63878		RS7040	77815	
RS5128	G63424		RS5233	G63716		RS5395	G63883		RS7042	77951	
RS5128	G63721		RS5234	G63715		RS5396	G63875		RS7044	77674	
RS5128	G63847		RS5236	G63778		RS5397	G63885		RS7044	77948	
RS5129	G63425		RS5240	G63722		RS5397	G64029		RS7044	77980	
RS5132	G63675		RS5248	G63403		RS5397	G64030		RS7112	G63456	
RS5136	G63386		RS5259	G63683		RS5401	14074				
RS5136	G63404		RS5260	G63829		RS5401	6801SE				
RS5145	G63479		RS5262	G63662		RS5409	14071				
RS5145	G63547		RS5262	G63674		RS5410	6854SE				

Important Note: Competitive Interchanges are to be used for stocking purposes only. Where multiple crosses are identified, please reference the applications section of this catalog. / **Remarque importante:** Les interchanges concurrentiels ne s'utilisent qu'aux fins de stocks. Dans le cas de rferences multiples, consulter la section des applications du catalogue. / **Nota importante:** Dans le cas de rrences multiples, consulter la section des applications du catalogue. / **Nota importante:** Se pueden usar intercambios competitivos para propósitos de almacenamiento solamente. Cuando se identifican intercambios múltiples, consulte la sección de aplicaciones de este catálogo.

COMPETITIVE & O.E.M. INTERCHANGE LIST
Lista de Intercambios contra Competidores y Equipo Original.
Liste d'interchange de produits comptitifs & d'equipement original (OEM)

Rancho... cont'd

Rancho	Gabriel	Upgrade	Rancho	Gabriel	Upgrade	Rancho	Gabriel	Upgrade	Rancho	Gabriel	Upgrade
RS7118	77717		RS7254	77952		RS7401	14040		RS999927	G57096	
RS7118	77907		RS7267	77809		RS97488	6855SE		RS999929	G57053	
RS7128	77847		RS7269	77950		RS999120	58357		RS999939	G57095	
RS7128	77978		RS7272	77807		RS999901	G57125		RS999942	G57096	
RS7129	77425		RS7286	G64157		RS999904	G57019		RS999943	G57053	
RS7150	77609		RS7295	77817		RS999909	G57021				
RS7190	77422		RS7326	77981		RS999910	G57020				
RS7190	77488		RS7328	77973		RS999924	G57095				

Raybestos

Raybestos	Gabriel	Upgrade	Raybestos	Gabriel	Upgrade	Raybestos	Gabriel	Upgrade	Raybestos	Gabriel	Upgrade
502-1291	143191		520-1475	143385		717-1103	G57118		717-1572RX	G56957	
520-1010	142135		520-1476	143364		717-1111	G57053		717-1577L	G57007	
520-1034	143281		520-1478	143323		717-1119L	G57123		717-1577R	G57008	
520-1060	142245		520-1482	143419		717-1119R	G57124		717-1592	G56965	
520-1063	142249		520-1487	143335		717-1124	G57095		717-1593	G57046	
520-1117	142329		520-1492	143398		717-1125	G57096		717-1594	G57045	
520-1121	143492		520-1496	143369		717-1138	G57172		717-1597	G57012	
520-1147	142444		520-1496	143468		717-1139	G57173		717-1598	G57011	
520-1163	142625		520-1497	143317		717-1140	G57132		717-1615	G56934	
520-1216	142526		520-1498	143316		717-1266	G56995		717-1615	G56937	
520-1222	142530		520-1501	143416		717-1281	G56938		717-1616	G56936	
520-1230	143458		520-1504	143455		717-1291L	G56996		717-1661	G57060	
520-1242	143465		520-1505	143344		717-1291R	G56997		717-1665	G56929	
520-1243	143466		520-1511	143319		717-1292	G56998		717-1667	G56963	
520-1266	142651		520-1512	143394		717-1293	G57057		717-1668	G56962	
520-1277	143459		520-1512	143422		717-1293	G57058		717-1669	G56964	
520-1290	143367		520-1517	143318		717-1299	G56943		717-1672	G56927	
520-1291	143191		520-1529	143564		717-1312	G57036		717-1685	G57051	
520-1294	143082		520-1530	143391		717-1321	G57017		717-1686	G56928	
520-1300	142828		520-1531	143390		717-1322	G57018		717-1691L	G56991	
520-1301	142930		520-1548	143462		717-1340L	G57032		717-1691R	G56992	
520-1316	143197		520-1549	143460		717-1340L	G57061		717-1920	G56935	
520-1317	143325		520-1552	143342		717-1340R	G57033		717-1924	G57013	
520-1322	143256		520-1553	143191		717-1340R	G57062		717-1925	G57014	
520-1325	142932		520-1553	143365		717-1341	G57022		717-1933	G57006	
520-1334	142938		520-1633	143495		717-1348L	G57027		717-1945	G56994	
520-1349	143315		520-1639	143341		717-1348R	G57027		717-1946	G56993	
520-1352	143209		520-1640	143363		717-1351L	G57065		717-1952	G56948	
520-1353	143204		520-1641	143461		717-1351R	G57066		717-1953	G56950	
520-1380	143087		520-1652	143531		717-1352L	G57010		717-1954	G56949	
520-1390	143073		520-1665	143406		717-1352R	G57010		717-1957	G56933	
520-1391	143074		520-1673	143345		717-1361	G57103		717-1958	G56932	
520-1400	142937		520-1680	142653		717-1369	G57015		717-2105	G57035	
520-1402	143202		520-1683	143491		717-1370	G57016		717-2106	G57034	
520-1403	143244		520-1689	143366		717-1371L	G57133		717-2114	G57115	
520-1404	143244		520-1692	143397		717-1371R	G57134		717-2115	G57114	
520-1415	143404		520-1693	143477		717-1398	G57019		717-2123L	G57054	
520-1434	143088		520-1695	143409		717-1426	G57031		717-2123R	G57055	
520-1436	143194		520-1695	143410		717-1427	G57030		717-2179L	G57047	
520-1441	143191		520-1713	143305		717-1490	G57042		717-2179R	G57048	
520-1443	143354		556-1105	143058		717-1491	G57041		717-2185	G57050	
520-1444	143355		556-1105	143059		717-1492	G57044		717-2186	G57049	
520-1451	143089		556-1108	143057		717-1493	G57043		717-2199	G57070	
520-1465	143418		556-1111	143061		717-1504	G57064				
520-1467	143388		556-1121	143057		717-1505	G57063				
520-1468	143387		713-9104	G57125		717-1525	G57039				
520-1471	143425		713-9105	G57000		717-1572LX	G56956				

Important Note: Competitive Interchanges are to be used for stocking purposes only. Where multiple crosses are identified, please reference the applications section of this catalog. / **Remarque importante:** Les interchanges concurrentiels ne s'utilisent qu'aux fins de stocks. Dans le cas de références multiples, consulter la section des applications du catalogue. / **Nota importante:** Dans le cas de referencias multiples, consultar la sección de aplicaciones del catalogo. / **Nota importante:** Se pueden usar intercambios competitivos para propósitos de almacenamiento solamente. Cuando se identifican intercambios múltiples, consulte la sección de aplicaciones de este catálogo.

COMPETITIVE & O.E.M. INTERCHANGE LIST

Lista de Intercambios contra Competidores y Equipo Original.

Liste d'interchange de produits comptitifs & d'equipement original (OEM)

Raybestos... cont'd

Raybestos	Gabriel	Upgrade	Raybestos	Gabriel	Upgrade	Raybestos	Gabriel	Upgrade	Raybestos	Gabriel	Upgrade
717-2199	G57122		717-2209	G57111		717-2292	G57147		727-1680	G56933	
717-2200	G57069		717-2210	G57110		727-1662L	G56924		727-1681	G56932	
717-2200	G57121		717-2231	G57142		727-1662R	G56925				

Raydan Manufacturing

Raydan manufacturing	Gabriel	Upgrade	Raydan manufacturing	Gabriel	Upgrade	Raydan manufacturing	Gabriel	Upgrade	Raydan manufacturing	Gabriel	Upgrade
14QK-3100	85739		446-51-211	85739		700115	85712				
14QK3100	85739		44651211	85739							

Renegade RV

Renegade rv	Gabriel	Upgrade	Renegade rv	Gabriel	Upgrade	Renegade rv	Gabriel	Upgrade	Renegade rv	Gabriel	Upgrade
10-13760-000	85959		16-16764-000	85724	89443	20551628	85066	89448	471700006040	85088	
10-13809-000	85958		16-16764-000	89443		20551628	89448		SDA471400003920	85958	
10-13976-000	85918	89449	16-18708-000	85724	89443	20973993	85061	89450	SDA471700002809	85724	89443
10-13976-000	89449		16-18708-000	89443		21436086	85061	89450	SDA471700002809	89443	
1013760000	85959		1616764000	85724	89443	21462380	85088		SDA471700002991	85959	
1013809000	85958		1616764000	89443		471700000443	85066	89448	SDA471700003920	85958	
1013976000	85918	89449	1618708000	85724	89443	471700000443	89448				
1013976000	89449		1618708000	89443		471700002991	85959				
141700005838	85061	89450	20433424	85061	89450	471700003920	85958				

Reyco Suspension

Reyco suspension	Gabriel	Upgrade	Reyco suspension	Gabriel	Upgrade	Reyco suspension	Gabriel	Upgrade	Reyco suspension	Gabriel	Upgrade
12885-01	85300	89419	1714601	83209	89414	1880001	89436		2352401	85738	
12885-01	89419		1714601	89414		19495-01	83126	89430	23553-01	85938	
12885-03	85300	89419	17358-01	83126	89430	19495-01	89430		2355301	85938	
12885-03	89419		17358-01	89430		1949501	83126	89430	24392-01	85051	
1288501	85300	89419	1735801	83126	89430	1949501	89430		2439201	85051	
1288501	89419		1735801	89430		19623-01	83123	89405	665519	89414	
1288503	85300	89419	17403-01	83122	89406	19623-01	89405		665748	85086	
1288503	89419		17403-01	89406		1962301	83123	89405	665813	85051	
12886-01	85334		1740301	83122	89406	1962301	89405		665830	85045	
1288601	85334		1740301	89406		19824-01	85006		665833	85052	
12887-01	85013	89414	17408-01	85005	89430	1982401	85006		671707	85323	89436
12887-01	89414		17408-01	89430		20125-01	85030	89440	671707	89436	
12887-02	85013	89414	1740801	85005	89430	20125-01	89440		680551	85738	
12887-02	89414		1740801	89430		2012501	85030	89440	680552	85938	
1288701	85013	89414	17794-01	83215		2012501	89440		680700	85938	
1288701	89414		1779401	83215		20126-01	89440		700098-01	83128	89436
1288702	85013	89414	18163-01	83207	89407	20129-01	85007		700098-01	89436	
1288702	89414		18163-01	89407		2012901	85007		700098-03	85052	
16230-01	85702		1816301	83207	89407	20960-01	83204		70009801	83128	89436
1623001	85702		1816301	89407		2096001	83204		70009801	89436	
16725-01	83126	89430	18164-01	83122	89406	21310-01	85307		70009803	85052	
16725-01	89430		18164-01	89406		2131001	85307		701071-01	665937	
1672501	83126	89430	1816401	83122	89406	21497-01	85005	89430	702135-01	85045	
1672501	89430		1816401	89406		21497-01	89430		70213501	85045	
16824-01	85006		18165-01	85006		2149701	85005	89430	702136-01	85052	
1682401	85006		1816501	85006		2149701	89430		70213601	85052	
17142-01	85001	89410	18166-01	85704		22062-01	85007		702209-01	85014	
17142-01	89410		1816601	85704		2206201	85007		70220901	85014	
1714201	85001	89410	18286-01	89414		23106-01	89430		704672-01	85938	
1714201	89410		18800-01	83203	89436	23523-01	85086		70467201	85938	
17146-01	83209	89414	18800-01	89436		2352301	85086				
17146-01	89414		1880001	83203	89436	23524-01	85738				

Ridewell Corp.

Ridewell corp.	Gabriel	Upgrade	Ridewell corp.	Gabriel	Upgrade	Ridewell corp.	Gabriel	Upgrade	Ridewell corp.	Gabriel	Upgrade
1250005	85901		1250563B000	89436		1253069B000	85005	89430			
1250546B000	85006		1250789B000	85014		1253069B000	89430				
1250563B000	85000	89436	1252607B000	85702							

Important Note: Competitive Interchanges are to be used for stocking purposes only. Where multiple crosses are identified, please reference the applications section of this catalog. / **Remarque importante:** Les interchanges concurrentiels ne s'utilisent qu'aux fins de stocks. Dans le cas de références multiples, consulter la section des applications du catalogue. / **Nota importante:** Dans le cas de referencias multiples, consultar la sección de aplicaciones del catálogo. / **Nota importante:** Se pueden usar intercambios competitivos para propósitos de almacenamiento solamente. Cuando se identifican intercambios múltiples, consulte la sección de aplicaciones de este catálogo.

COMPETITIVE & O.E.M. INTERCHANGE LIST
Lista de Intercambios contra Competidores y Equipo Original.
Liste dinterchange de produits compititifs & dquipement original (OEM)

Ridewell Corp.... cont'd

Ridewell corp.	Gabriel	Upgrade	Ridewell corp.	Gabriel	Upgrade	Ridewell corp.	Gabriel	Upgrade	Ridewell corp.	Gabriel	Upgrade
1254025B000	85712		1275813B000	85704		90-1813	85712		S4025B	85712	
1254190B000	85302	89420	1275943B	85005	89430	901813	85712		S5477B	85307	
1254190B000	89420		1275943B	89430		AS 4025B	85712		S5478B	85307	
1265157B000	85712		1310002	665937		AS30698	85005	89430	S5813B	85704	
1265478B000	85736		1310004	665937		AS30698	89430		S5878B	83207	89407
1266009B000	83130		1317570B001	646155		AS3069B	85005	89430	S5878B	89407	
1267120B000	85734		57645	85005	89430	AS3069B	89430		S6009B	83203	89436
1267249B000	85712		57645	89430		AS546B	85006		S6009B	89436	
1267395B000	85302	89420	665198	85005	89430	AS563B	83203	89436	S7120B	85304	
1267395B000	89420		665198	89430		AS563B	89436		S7172B	83207	89407
1270007	85045		665267	85029		AS575B	85005	89430	S7172B	89407	
1270563B000	85000	89436	665526	85014		AS575B	89430		S7249B	85307	
1270563B000	89436		680101	85702		AS789B	85014		S7365B	85305	
1270563B003	85934		70654	85000	89436	AS789B000	85014				
1270789B000	85014		70654	89436		S2607B	85702				

RIG TOUGH

Rig tough	Gabriel	Upgrade	Rig tough	Gabriel	Upgrade	Rig tough	Gabriel	Upgrade	Rig tough	Gabriel	Upgrade
0202737RTB	85062	89408	0307421RTB	85311	89424	C711002RTB	85067	89451			
0202738RTB	85012	89413	0307423RTB	85033	89427	C711011RTB	85069	89455			

Road Titan

Road titan	Gabriel	Upgrade	Road titan	Gabriel	Upgrade	Road titan	Gabriel	Upgrade	Road titan	Gabriel	Upgrade
RT646155	646155		RT85003	85003	89411	RT85069	85069	89455	RT85918	85918	89449
RT83008	83008		RT85003	89411		RT85069	89455		RT85918	89449	
RT83038	83038		RT85045	85045		RT85070	85070	89459	RT85931	85931	89458
RT83128	83128	89436	RT85062	85062	89408	RT85070	89459		RT85931	89458	
RT83128	89436		RT85062	89408		RT85088	85088		RT85934	85934	
RT85000	85000	89436	RT85066	85066	89448	RT85311	85311	89424	RT85958	85958	
RT85000	89436		RT85066	89448		RT85311	89424				
RT85001	85001	89410	RT85067	85067	89451	RT85724	85724	89443			
RT85001	89410		RT85067	89451		RT85724	89443				

Roadmaster (Monaco)

Roadmaster (monaco)	Gabriel	Upgrade	Roadmaster (monaco)	Gabriel	Upgrade	Roadmaster (monaco)	Gabriel	Upgrade	Roadmaster (monaco)	Gabriel	Upgrade
90045132	85909		90045188	85910							

Sabo

Sabo	Gabriel	Upgrade	Sabo	Gabriel	Upgrade	Sabo	Gabriel	Upgrade	Sabo	Gabriel	Upgrade
8901020	85300	89419	8901025	85000	89436	8901029	89428		890120	85300	89419
8901020	89419		8901025	89436		8901029	89443		890120	89419	
8901021	85320	89429	8901026	85064		8901030	85323	89436	890414	85323	89436
8901021	89429		8901027	85310	89423	8901030	89436		890414	89436	
8901023	85066	89448	8901027	89423		8901031	85900		890449	85300	89419
8901023	89448		8901028	85316	89426	8901032	85901		890449	89419	
8901024	85314	89425	8901028	89426		8901033	85918	89449	895315	83009	
8901024	89425		8901029	85319	89428	8901033	89449		895316	83002	
8901025	83128	89436	8901029	85724	89443	8901156	G63299				

Sachs

Sachs	Gabriel	Upgrade	Sachs	Gabriel	Upgrade	Sachs	Gabriel	Upgrade	Sachs	Gabriel	Upgrade
030 086	G51759		030 211	G63423		030 226	69600		030 261	G63490	
030 094	G51888		030 212	G63424		030 229	69675		030 262	G63492	
030 095	G51887		030 212	G63721		030 230	69676		030 262	G63928	
030 098	G56655		030 214	G63454		030 243	G63350		030 265	G63915	
030 100	G56817		030 215	G63461		030 244	G63353		030 266	G63950	
030 202	G63357		030 218	G63607		030 245	G63360		030 267	69625	
030 204	G63375		030 219	G63608		030 247	G63377		030 281	G51871	
030 204	G63894		030 219	G63614		030 248	G63387				
030 205	G63386		030 221	G63609		030 252	G63409				
030 209	G63421		030 221	G63818		030 255	G63418				
030 210	G63422		030 222	G63907		030 257	G63455				

Important Note: Competitive Interchanges are to be used for stocking purposes only. Where multiple crosses are identified, please reference the applications section of this catalog. / **Remarque importante:** Les interchanges concurrentiels ne s'utilisent qu'aux fins de stocks. Dans le cas de rferences multiples, consulter la section des applications du catalogue. / **Nota importante:** Dans le cas de rferences multiples, consulter la section des applications du catalogue. / **Nota importante:** Se pueden usar intercambios competitivos para propósitos de almacenamiento solamente. Cuando se identifican intercambios múltiples, consulte la sección de aplicaciones de este catálogo.

COMPETITIVE & O.E.M. INTERCHANGE LIST
Lista de Intercambios contra Competidores y Equipo Original.
Liste dinterchange de produits comptitifs & dquipement original (OEM)

Sachs... cont'd

Sachs	Gabriel	Upgrade	Sachs	Gabriel	Upgrade	Sachs	Gabriel	Upgrade	Sachs	Gabriel	Upgrade
030 282	G51904		031 289	G63864		112885	85709		290146	85012	89413
030 296	G51704		031 295	G51716		115 906	G56778		290146	89413	
030 297	G63867		031 304	G51838		124 390	69952		290460	85005	89430
030 297	G64157		031 336	G56731		124693	85708		290460	89430	
030 298	G51703		031 337	G56730		141700000370	89450		290465	83125	
030 299	G63870		031 338	G56735		141700000373	85061	89450	290488	85040	
030 314	69574		031 339	G56734		141700000378	83160		300 138	G56791	
030 315	69575		031 347	G51714		141700000380	85061	89450	303 903	70041	
030 320	G51722		031 350	G63815		141700000440	85066	89448	310 027	69946	
030 321	G51724		031 351	G63815		141700000440	89448		310 032	G51087	
030 334	G56809		031 363	G56636		141700000443	85066	89448	310 173	G63413	
030 335	G56809		031 364	G56635		141700000443	89448		310 175	G63905	
030 645	G55697		031 365	G52013		141700002626	85061	89450	310 178	G63661	
030 660	G55772		031 366	G52014		141700002630	89450		310 183	G63359	
030 667	G51267		031 367	G51736		141700005838	85061	89450	310 190	G63683	
030 669	G55820		031 374	70001		141700005839	85061	89450	310 191	G63425	
030 671	G55901		031 383	G52168		141700131809	85029		310 202	G56620	
030 676	G56701		031 384	G52169		141700131810	83160		310 203	G63426	
030 699	G55896		031 388	G51802		141700131975	83160		310 203	G63690	
030 729	69845		031 392	70028		141700131980	83160		310 218	G63622	
030 731	69898		031 393	G52098		152C030010	83317		310 218	G63929	
030 747	G51268		031 422	G51849		152E030030	85014		310 219	G63624	
030 760	G63443		033 011	G56927		170 811	G51097		310 224	G63716	
030 767	G63671		033 020	G56935		170 819	G51742		310 225	G63678	
030 768	G63411		033 023	G57064		170 823	69903		310 225	G63775	
030 777	G63623		033 024	G57063		170 828	69903		310 227	G63679	
030 780	G63638		033 036	G56957		230 048	G63799		310 231	G63414	
030 780	G63896		033 037	G56956		230 303	G51841		310 235	G63778	
030 798	G63722		033 044	G56997		230 709	G56517		310 249	69606	
030 814	69473		033 045	G56996		230 710	G56516		310 253	G63715	
030 817	G63837		033 046	G56998		280 325	G63781		310 261	G63525	
030 838	G63848		033 054	G56948		280 355	69465		310 272	G63676	
030 844	G63879		033 055	G56948		280 523	69450		310 272	G63873	
030 848	G63773		033 056	G56949		280 757	G64028		310 273	G52314	
030 854	69962		033 057	G56950		280 867	G63832		310 274	G52314	
030 872	69590		033 088	G57178		280 869	G63828		310 277	G63776	
030 875	G63958		033 089	G57176		280499	85300	89419	310 277	G63869	
030 877	G63962		033 090	G57177		280499	89419		310 284	G63489	
030 878	G63810		033 103	G56991		290 005	G64027		310 287	G63488	
030 879	G63808		033 103	G56992		290 074	G55999		310 291	G55698	
030 881	G64087		033 105	G56943		290 075	G55999		310 312	G63783	
030 980	49228		033 107	G57054		290 078	G55662		310 315	G63355	
030 980	49255		033 107	G57055		290 079	G55661		310 315	G63366	
031 084	G63494		033 108	G57056		290 082	G55591		310 317	G63349	
031 085	G63404		033 113	G57114		290 083	G55591		310 322	G52025	
031 091	G63548		033 114	G57115		290 236	G52165		310 325	G63662	
031 095	G63616		033 317	G63878		290 237	G52164		310 325	G63675	
031 098	G63903		101 471	69787		290 238	G51881		310 325	G63959	
031 103	G63782		101 705	69996		290 239	G52145		310 328	G63803	
031 105	G63707		101892	85708		290 240	G52144		310 328	G63893	
031 106	G63708		101968	85708		290 379	G63918		310 343	G63813	
031 110	G63726		105 828	69901		290 561	G56591		310 350	G63299	
031 257	G56565		106 798	69677		290 780	G55911		310 425	G51900	
031 267	G56571		106282	85722		290 781	G55911		310 684	G56616	
031 279	G56640		106884	85708		290 949	G52237		310 685	G56615	
031 280	G56641		106885	85722		290 950	G52238		310 688	G63845	

Important Note: Competitive Interchanges are to be used for stocking purposes only. Where multiple crosses are identified, please reference the applications section of this catalog. / **Remarque importante:** Les interchanges concurrentiels ne s'utilisent qu'aux fins de stocks. Dans le cas de références multiples, consulter la section des applications du catalogue. / **Nota importante:** Dans le cas de referencias multiples, consultar la sección de aplicaciones del catálogo. / **Nota importante:** Se pueden usar intercambios competitivos para propósitos de almacenamiento solamente. Cuando se identifican intercambios múltiples, consulte la sección de aplicaciones de este catálogo.

COMPETITIVE & O.E.M. INTERCHANGE LIST
Lista de Intercambios contra Competidores y Equipo Original.
Liste dinterchange de produits comptitifs & dquipement original (OEM)

Sachs... cont'd

Sachs	Gabriel	Upgrade	Sachs	Gabriel	Upgrade	Sachs	Gabriel	Upgrade	Sachs	Gabriel	Upgrade
310 706	69813		312 139	G56759		313 202	G52175		313 671	69595	
310 718	G52199		312 154	70000		313 203	G52176		313 672	69594	
310 719	G52200		312 170	G51883		313 237	G52095		313 738	G52297	
310 720	70034		312 178	G56672		313 238	G52094		313 739	G52298	
310 838	G52275		312 179	G56671		313 239	70027		313 741	G51934	
310 839	G52274		312 184	G51727		313 243	G52122		313 767	G56799	
310 842	G51841		312 186	G52009		313 244	G52121		313 768	G56800	
310 897	G63712		312 187	G52008		313 245	70089		313 785	G64033	
310 950	G51799		312 188	G51798		313 252	G51993		313 808	G56581	
310 985	G52142		312 209	G51767		313 254	G52142		313 809	G56582	
310 986	G52143		312 214	G51739		313 255	G52143		313 849	G56894	
311 013	G56899		312 215	G63885		313 258	G51723		313 854	G51859	
311 041	69604		312 215	G64029		313 262	69592		313 854	G51897	
311 041	69724		312 215	G64030		313 262	69593		313 855	G51859	
311 120	G63958		312 218	G51804		313 263	G56807		313 855	G51896	
311 120	G64043		312 222	G52108		313 264	G64012		313 856	69591	
311 121	G63961		312 222	G56798		313 265	G51715		313 861	G51794	
311 122	G51728		312 223	G52107		313 277	G56514		313 880	G511004	
311 123	G63844		312 223	G56797		313 278	G56506		313 881	G52300	
311 212	G63817		312 278	G44461		313 279	G55676		313 882	G52299	
311 233	G64046		312 280	G44461		313 280	G55675		313 977	G51841	
311 237	G63720		312 326	G56539		313 411	G52005		313 983	G63883	
311 312	G56729		312 327	G56540		313 415	G52006		314 007	70098	
311 313	G56728		312 473	G64016		313 419	70003		314 037	G52174	
311 409	70045		312 475	G63892		313 455	G52184		314 038	G52173	
311 410	70045		312 485	G52110		313 456	G52185		314 044	G64050	
311 538	G51773		312 486	G52111		313 474	G63884		314 125	G52295	
311 543	G52276		312 587	G56568		313 475	G63882		314 166	69714	
311 750	70039		312 588	G56601		313 477	G63875		314 167	69795	
311 752	70040		312 589	69900		313 517	G52154		314 168	69811	
311 753	70040		312 702	G63847		313 518	G52155		314 220	69622	
311 801	69909		312 703	G63829		313 520	G52257		314 225	69755	
311 820	69585		312 739	G52018		313 521	G52258		314 226	G55856	
311 821	G63717		312 740	G52017		313 522	G64071		314 243	G63673	
311 823	G63714		312 743	G56893		313 523	G511054		314 258	G63710	
311 944	G56688		312 744	G56892		313 524	G511055		314 259	G55994	
311 945	G56687		312 782	70024		313 526	70078		314 260	G63937	
311 946	G56688		312 784	69586		313 527	G52160		314 261	G63620	
311 947	G56687		312 880	G56680		313 528	G52161		314 270	G55993	
311229	85918	89449	312 881	G56679		313 588	G56633		314 288	G63904	
311229	89449		312 901	G56733		313 589	G56634		314 288	G63909	
311230	85956		312 902	G56732		313 620	G56841		314 299	G63495	
311631	85906	89407	312 929	G51795		313 621	G56840		314 299	G63611	
311631	89407		312 932	G51814		313 622	G64037		314 300	69715	
311632	85909		312 933	G51813		313 624	G63889		314 355	69587	
311633	85900		312 963	G51812		313 624	G64006		314 356	69589	
311634	85001	89410	312 984	G52082		313 625	G64009		314 423	G63890	
311634	89410		312 985	G52081		313 625	G64011		314 423	G63891	
311635	85030	89440	312 986	G51842		313 626	G56537		314 461	G52348	
311635	89440		312724	85311	89424	313 627	G56538		314 462	G52349	
311793	85916	89430	312724	89424		313 660	G52282		314 463	G51928	
311793	89430		313 093	G56660		313 661	G52283		314 469	G64032	
312 130	G51718		313 094	G56661		313 663	G51833		314 621	69464	
312 131	G63842		313 096	G55774		313 665	G52275		314 660	G52335	
312 134	G51738		313 097	G55774		313 667	G52274		314 661	G52336	
312 138	G56758		313 123	G63610		313 669	70056		314 752	G51783	

Important Note: Competitive Interchanges are to be used for stocking purposes only. Where multiple crosses are identified, please reference the applications section of this catalog./ **Remarque importante:** Les interchanges concurrentiels ne s'utilisent qu'aux fins de stocks. **Dans le cas de rfrences multiples, consulter la section des applications du catalogue./** **Nota importante:** Dans le cas de rfrences multiples, consulter la section des applications du catalogue./ **Nota importante:** Se pueden usar intercambios competitivos para propósitos de almacenamiento solamente. Cuando se identifican intercambios múltiples, consulte la sección de aplicaciones de este catálogo.

COMPETITIVE & O.E.M. INTERCHANGE LIST
Lista de Intercambios contra Competidores y Equipo Original.
Liste dinterchange de produits comptitifs & dquipement original (OEM)

Sachs... cont'd

Sachs	Gabriel	Upgrade	Sachs	Gabriel	Upgrade	Sachs	Gabriel	Upgrade	Sachs	Gabriel	Upgrade
314 754	70036		315 918	G52129		315536	85086		315612	85006	
314 757	G56842		315 919	G52130		315540	83613		315613	85030	89440
314 758	G56843		315 924	G52131		315541	85052		315613	85909	
314 766	G56886		315 925	G64042		315542	83122	89406	315613	89440	
314 767	G56887		315389	85090		315542	85005	89430	315614	83125	
314 845	G52007		315390	85918	89449	315542	89406		315615	83027	
314 846	G52004		315390	89449		315542	89430		315616	83038	
314 863	G64026		315391	85956		315543	85734		315617	85918	89449
314 894	G52439		315392	85007		315544	83124	89407	315617	89449	
314 895	G52440		315392	85329		315544	85014		315618	83160	
314 994	G56819		315393	85331		315544	89407		315619	83160	
314 995	G56820		315394	85921		315545	85316	89426	315620	85080	
314 996	G56822		315395	85724	89443	315545	85333		315621	85080	
314 997	G56821		315395	89443		315545	89426		315622	85081	
315 087	G56606		315396	85335		315546	85005	89430	315623	85918	89449
315 127	G56810		315397	83120		315546	89430		315623	89449	
315 128	G56810		315398	85058	89431	315547	85924	89457	315624	85959	
315 129	G63872		315398	89431		315547	89457		315626	85933	89454
315 129	G64015		315399	85005	89430	315548	85070	89459	315626	89454	
315 129	G64140		315399	89430		315548	89459		315654	85070	89459
315 148	G51850		315400	85006		315549	85033	89427	315654	89459	
315 150	70052		315401	85331		315549	89427		315655	85937	
315 171	G52162		315402	85900		315550	85311	89424	315656	83040	
315 172	G52163		315403	85919		315550	89424		315657	83039	
315 197	G51908		315404	85900		315551	85310	89423	315659	83047	
315 227	G51807		315406	85918	89449	315551	89423		315660	83009	
315 251	G52383		315406	89449		315552	83389	89436	315661	85932	89453
315 252	G52382		315411	83128	89436	315552	85000	89436	315661	89453	
315 278	G56773		315411	89436		315552	89436		315840	83126	89430
315 279	G56774		315412	85106		315553	85900		315840	89430	
315 280	G51870		315413	85932	89453	315554	83125		316 39	83215	
315 306	G56562		315413	89453		315555	83001		316 396	G52127	
315 307	G56561		315414	85959		315556	83215		316 397	G52128	
315 308	69907		315415	85933	89454	315558	85062	89408	316 398	G56837	
315 641	G52148		315415	89454		315558	89408		316 399	G56836	
315 642	G52149		315416	85003	89411	315593	85029		316 402	G52204	
315 644	G52117		315416	89411		315594	85029		316 403	G52203	
315 645	G52118		315417	85923	89458	315597	85959		316 404	G52202	
315 646	G51863		315417	85931	89458	315598	85933	89454	316 405	G52201	
315 785	G51815		315417	89458		315598	89454		316 408	G52188	
315 786	G51855		315418	83456	89447	315599	85109		316 409	G52187	
315 787	G64038		315418	89447		315600	85918	89449	316 410	G51878	
315 790	G51910		315420	85014		315600	89449		316 411	G51877	
315 792	G51858		315421	85088		315601	85959		316 412	G51892	
315 793	70010		315422	85708		315603	83134		316 413	G64008	
315 796	G52253		315423	83127		315604	85053	89442	316 414	G64040	
315 797	G52254		315424	85067	89451	315604	89442		316 415	G52125	
315 801	G51919		315424	89451		315606	85061	89450	316 416	G52248	
315 804	G51860		315426	85007		315607	85061	89450	316 417	G52247	
315 805	G51861		315427	85713		315608	85061	89450	316 419	G52104	
315 809	G52182		315431	85014		315608	85066	89448	316 420	G52103	
315 810	G52183		315432	83209	89414	315608	89448		316 421	G52116	
315 826	G51911		315432	85013	89414	315609	85066	89448	316 422	G52157	
315 854	70040		315432	89414		315609	89448		316 423	G52156	
315 897	G51983		315434	85065		315610	83026		316 424	G52250	
315 898	G51983		315435	85088		315611	85006		316 425	G52249	

Important Note: Competitive Interchanges are to be used for stocking purposes only. Where multiple crosses are identified, please reference the applications section of this catalog. / **Remarque importante:** Les interchanges concurrentiels ne s'utilisent qu'aux fins de stocks. Dans le cas de rferences multiples, consulter la section des applications du catalogue. / **Nota importante:** Dans le cas de rferences multiples, consulter la section des applications du catalogue. / **Nota importante:** Se pueden usar intercambios competitivos para propósitos de almacenamiento solamente. Cuando se identifican intercambios múltiples, consulte la sección de aplicaciones de este catálogo.

COMPETITIVE & O.E.M. INTERCHANGE LIST
Lista de Intercambios contra Competidores y Equipo Original.
Liste dinterchange de produits comptitifs & dquipement original (OEM)

Sachs... cont'd

Sachs	Gabriel	Upgrade	Sachs	Gabriel	Upgrade	Sachs	Gabriel	Upgrade	Sachs	Gabriel	Upgrade
316 426	G64003		316 666	G51933		316491	85013	89414	317773	85656	
316 426	G64080		316 667	70096		316491	89414		317774	83122	89406
316 427	G52141		316 668	G51926		316493	85010		317774	89406	
316 428	G52140		316 669	G51925		316814	85026		317776	83209	89414
316 434	G51884		316 674	G52150		316815	85030	89440	317776	89414	
316 438	70053		316 675	G52151		316815	89440		317777	85648	
316 439	G52331		316 679	G52026		316816	85012	89413	317778	83045	
316 440	G52332		316 680	G52027		316816	89413		317779	85045	
316 441	G64048		316 686	G52112		316817	85954		317779	85939	
316 442	G51852		316 687	G52113		316818	85046	89434	317780	83030	
316 443	G52096		316 707	G51990		316818	89434		317781	83035	
316 444	G52097		316 747	70013		316819	85055	89439	317782	83207	89407
316 445	G52158		316 749	G51853		316819	89439		317782	89407	
316 446	G52159		316 750	G51854		316820	85012	89413	317783	85024	
316 447	G52264		316 772	G51891		316820	89413		317928	646177	
316 448	G52265		316 774	G51891		316821	83111		317929	83019	
316 462	G63888		316 775	G63866		316822	85978		317930	83025	
316 463	G64111		316 777	G63866		316823	85072		317931	83049	
316 467	G52375		316 842	G56721		316824	85069	89455	317932	83101	
316 468	G51961		316 843	G56722		316824	89455		317933	83103	
316 469	G52374		316 881	G51972		316825	83021		317934	83123	89405
316 496	G56509		316 923	G51766		316826	83031		317934	89405	
316 497	G51832		316 924	G64031		316827	83002		317935	83142	
316 498	G51880		316302	83163		316828	83041		317936	83144	
316 561	G52245		316303	83136		316829	83041		317936	85030	89440
316 562	G52246		316305	83219		316830	85051		317936	89440	
316 563	G51898		316305	85023	89415	316831	85043		317937	83148	
316 578	G51864		316305	89415		316832	83120		317938	85012	89413
316 579	G51865		316306	85319	89428	316833	83112		317938	89413	
316 580	G64079		316306	89428		316834	85058	89431	317939	83314	
316 589	70068		316307	85036	89405	316834	89431		317940	85053	89442
316 595	G51806		316307	89405		316835	83110		317940	89442	
316 596	G51806		316308	85321		316836	85055	89439	317941	85302	89420
316 597	G52439		316309	85901		316836	89439		317941	89420	
316 598	G52440		316310	85311	89424	316837	83312	89409	317943	85979	
316 624	G51805		316310	89424		316837	89409		317944	87015	
316 625	G52106		316311	85047	89435	316838	83309		317945	83515	
316 626	G52105		316311	89435		316839	83215		317953	85301	
316 629	G56679		316312	83136		316840	83126	89430	317955	632147	
316 630	G56680		316313	85061	89450	316840	85030	89440	317956	83025	
316 633	G51765		316314	85064		316840	89430		317957	83225	
316 638	G63886		316314	85938		316840	89440		317957	85007	
316 638	G63969		316316	85936	89456	316841	85303	89422	317958	83308	
316 639	G52152		316316	89456		316841	89422		317959	83400	
316 641	G51905		316318	85045		317 966	G63183		317960	85054	
316 645	G52033		316318	85052		317529	83154		317961	85338	
316 646	G52032		316319	83130		317530	646155		317962	85311	89424
316 647	G51803		316320	85030	89440	317531	83048		317962	89424	
316 651	G52209		316320	89440		317532	83051		317963	85740	
316 652	G52210		316321	83317		317533	85052		317964	85029	
316 653	G64056		316322	85300	89419	317534	85084	89460	317965	83163	
316 654	G52260		316322	89419		317534	85989		317966	G63183	
316 655	G52261		316478	85331		317534	89460		40A850	85708	
316 662	70060		316485	85959		317535	83008		410009	83102	
316 664	G52293		316488	85919		317536	85738		410010	83317	
316 665	G52294		316490	85010		317772	83029		410021	83125	

Important Note: Competitive Interchanges are to be used for stocking purposes only. Where multiple crosses are identified, please reference the applications section of this catalog./ **Remarque importante:** Les interchanges concurrentiels ne s'utilisent qu'aux fins de stocks. Dans le cas de rfrences multiples, consulter la section des applications du catalogue./ **Nota importante:** Dans le cas de rfrences multiples, consulter la section des applications du catalogue./ **Nota importante:** Se pueden usar intercambios competitivos para propósitos de almacenamiento solamente. Cuando se identifican intercambios múltiples, consulte la sección de aplicaciones de este catálogo.

COMPETITIVE & O.E.M. INTERCHANGE LIST
Lista de Intercambios contra Competidores y Equipo Original.
Liste dinterchange de produits comptitifs & dquipement original (OEM)

Sachs... cont'd

Sachs	Gabriel	Upgrade	Sachs	Gabriel	Upgrade	Sachs	Gabriel	Upgrade	Sachs	Gabriel	Upgrade
410022	85006		47170000460	89414		471700011531	85180		510005	85303	89422
410024	85302	89420	47170000460	89440		471700013186	85109		510005	89422	
410024	89420		47170000461	89414		471700014316	85061	89450	510006	85705	89447
410025	83215		47170000464	85090		471700014318	85188		510006	89447	
410026	85918	89449	47170000466	85959		471700131155	85918	89449	510017	85323	89436
410026	89449		47170000470	85918	89449	471700131155	89449		510017	85738	
410032	85001	89410	47170000470	89449		471700131160	85918	89449	510017	89436	
410032	89410		471700002627	85066	89448	471700131160	89449		510018	85724	89443
410035	85001	89410	471700002627	89448		471700131256	85065		510018	89443	
410035	85337		471700002630	85066	89448	471700131258	85081		510019	85916	89430
410035	89410		471700002630	89448		471700131260	85081		510019	89430	
410036	85061	89450	471700002726	85918	89449	471700131330	85932	89453	510023	85316	89426
410037	85081		471700002726	89449		471700131330	89453		510023	89426	
410040	85909		471700002727	85959		471700131331	85932	89453	553 870	70033	
410042	85310	89423	471700002730	85918	89449	471700131331	89453		553 871	G56792	
410042	89423		471700002730	85959		471700131545	85006		554 041	G56802	
410043	85957		471700002730	89449		471700131646	85918	89449	554 046	G56802	
410044	85031		471700002809	85724	89443	471700131646	89449		556 271	69420	
410046	83136		471700002809	89443		471700131650	85918	89449	556 271	69945	
410047	85071		471700002810	85724	89443	471700131650	89449		556 277	69946	
410048	85014		471700002810	89443		471700131775	85006		556 882	69863	
410056	83389	89436	471700002861	85014		471700131778	85331		557 833	G51097	
410056	85000	89436	471700002919	85106		471700131780	85331		558 301	G51740	
410056	89436		471700002920	85106		471700131920	85933	89454	566 281	G51799	
410057	83137		471700002990	85007		471700131920	89454		610 018	G63479	
410057	85013	89414	471700002991	85959		471700131921	85933	89454	610 018	G63547	
410057	89414		471700002992	85331		471700131921	89454		610 023	G63405	
410058	83122	89406	471700002993	85921		471700131970	85029		610 078	G63403	
410058	89406		471700002994	83134		471700131974	85029		610 092	G63772	
410068	85030	89440	471700002995	83134		481700000207	85329		613 640	G52153	
410068	85054		471700002996	85335		481700000209	85713		802 003	142135	
410068	89440		471700003000	85335		481700000210	85329		802 061	142444	
47170000426	85014		471700003009	85006		481700000210	85713		802 070	142651	
47170000428	85006		471700003010	89431		481700000477	85900		802 094	142230	
47170000430	85066	89448	471700003011	85058	89431	481700000480	85900		802 107	143191	
47170000430	89448		471700003011	89431		481700000490	85900		802 143	142249	
47170000431	85066	89448	471700003830	85933	89454	481700000493	85900		802 145	143281	
47170000431	89448		471700003830	89454		481700125969	85956		802 186	143082	
47170000436	85030	89440	471700003832	85933	89454	481700125970	85956		802 196	142653	
47170000436	89440		471700003832	89454		481700131438	85919		802 250	143404	
47170000440	85959		471700003920	85958		481700131440	85919		802 289	142930	
47170000443	85066	89448	471700004420	85109		481700131919	85900		802 291	142625	
47170000443	89448		471700004423	85109		481700131920	85900		802 292	143204	
47170000445	85080		471700005079	85005	89430	481700999376	85329		802 297	142419	
47170000447	85919		471700005079	89430		481700999380	85329		802 298	143367	
47170000449	85918	89449	471700005080	89430		481700999386	85376		802 299	142649	
47170000449	89449		471700006039	85088		481700999386	85736		802 300	142650	
47170000450	85080		471700006040	85088		481700999390	85376		802 304	143492	
47170000450	85918	89449	471700006269	85932	89453	510 007	85705	89447	802 306	143201	
47170000450	85919		471700006269	89453		510 009	85711		802 346	143465	
47170000450	89449		471700006270	85932	89453	510001	85303	89422	802 347	143466	
47170000451	85080		471700006270	89453		510001	89422		802 349	143087	
47170000458	85014		471700009646	85088		510002	85302	89420	802 358	142937	
47170000459	85030	89440	471700009647	85088		510002	89420		802 360	143202	
47170000459	89440		471700009650	85088		510003	85004		802 377	142252	
47170000460	85090		471700011530	85181		510004	85307		802 379	143191	

Important Note: Competitive Interchanges are to be used for stocking purposes only. Where multiple crosses are identified, please reference the applications section of this catalog. / **Remarque importante:** Les interchanges concurrentiels ne s'utilisent qu'aux fins de stocks. Dans le cas de références multiples, consulter la section des applications du catalogue. / **Nota importante:** Dans le cas de referencias multiples, consultar la sección de aplicaciones del catálogo. / **Nota importante:** Se pueden usar intercambios competitivos para propósitos de almacenamiento solamente. Cuando se identifican intercambios múltiples, consulte la sección de aplicaciones de este catálogo.

COMPETITIVE & O.E.M. INTERCHANGE LIST
Lista de Intercambios contra Competidores y Equipo Original.
Liste dinterchange de produits comptitifs & dquipement original (OEM)

Sachs... cont'd

Sachs	Gabriel	Upgrade	Sachs	Gabriel	Upgrade	Sachs	Gabriel	Upgrade	Sachs	Gabriel	Upgrade
802 399	143239		802 504	143468		802 747	142245		803 085	143088	
802 432	143218		802 513	143408		802 767	142329		803 097	143339	
802 435	143418		802 536	143473		802 780	143209		814903003480	83039	
802 437	143388		802 540	143422		802 782	142843		814903003480	83040	
802 438	143387		802 582	143495		802 791	143458		814903003482	83040	
802 444	143491		802 583	143318		802 844	142828		814903003483	83039	
802 453	142195		802 585	143391		802 849	143197		814903003486	83047	
802 458	143191		802 586	143390		802 850	143325		814903003496	83009	
802 458	143365		802 590	143415		802 853	142561		814903003500	83026	
802 476	143317		802 594	143363		802 854	142836		814903003501	83027	
802 477	143354		802 595	143462		802 861	142530		814903003528	83038	
802 478	143355		802 596	143461		802 863	143459		814903003530	83038	
802 479	143323		802 598	143460		802 885	142938		820 690	143477	
802 486	143416		802 609	143342		802 887	143244		900 002	143057	
802 487	143419		802 615	143406		802 893	142932		900 003	143058	
802 490	143398		802 657	143366		802 895	143256		900 097	143059	
802 492	143455		802 657	143486		802 896	143315		900 099	143061	
802 497	143089		802 680	143409		802 906	143464		900 101	143063	
802 501	143385		802 680	143410		802 909	143423		900 301	143064	
802 502	143324		802 689	143397		802 929	143244				
802 503	143364		802 722	142852		803 020	143349				
802 504	143369		802 739	142546		803 022	143305				

SAF Holland

Saf holland	Gabriel	Upgrade	Saf holland	Gabriel	Upgrade	Saf holland	Gabriel	Upgrade	Saf holland	Gabriel	Upgrade
471700000436	85030	89440	680234	85906	89407	90044162	89436		90044978	85059	
471700000436	89440		680234	89407		90044448	85051		90044979	83113	
471700000458	85014		680268	85323	89436	90044625	83125		90044981	85000	89436
471700000459	85030	89440	680268	89436		90044626	83126	89430	90044981	89436	
471700000459	89440		680298	85321		90044626	89430		90044982	85000	89436
471700000460	85014		680645	85321		90044642	83127		90044982	89436	
471700000460	89414		6898	83125		90044679	83122	89406	90044989	85059	
471700000460	89440		90044001	85005	89430	90044679	89406		90044991	85000	89436
471700000461	89414		90044001	89430		90044680	83125		90044991	89436	
481700000483	89430		90044008	85000	89436	90044681	83204		90044992	85000	89436
481700000485	89430		90044008	89436		90044682	83209	89414	90044992	89436	
57639	85000	89436	90044011	85004		90044682	89414		90045000	85906	89407
57639	89436		90044012	85006		90044683	83122	89406	90045000	89407	
57643	85013	89414	90044016	85300	89419	90044683	89406		90045001	85323	89436
57643	89414		90044016	89419		90044684	83124	89407	90045001	89436	
6025	83122	89406	90044017	83204		90044684	89407		90045002	85906	89407
6025	89406		90044025	83209	89414	90044685	83389	89436	90045002	89407	
6026	83204		90044025	89414		90044685	89436		90045003	85323	89436
632155	646177		90044046	83123	89405	90044686	85051		90045003	89436	
646201	646177		90044046	89405		90044687	83125		90045040	83130	
665002	85004		90044071	85000	89436	90044688	83122	89406	90045053	85908	
665003	85300	89419	90044071	89436		90044688	89406		90045054	85051	
665003	89419		90044081	85000	89436	90044769	83207	89407	90045075	85911	
665197	85051		90044081	89436		90044769	89407		90045083	85910	
665454	85045		90044086	85000	89436	90044770	83207	89407	90045096	85916	89430
665514	83127		90044086	89436		90044770	89407		90045096	89430	
665969	89430		90044089	83124	89407	90044794	83127		90045099	85906	89407
671921	85916	89430	90044089	89407		90044833	85052		90045099	89407	
671921	89430		90044089C	83124	89407	90044834	85052		90045110	83137	
671922	89405		90044089C	89407		90044868	85045				
671923	89440		90044095	83203	89436	90044878	83635				
671931	85916	89430	90044095	89436		90044907	83635				
671931	89430		90044162	83128	89436	90044915	83127				

Important Note: Competitive Interchanges are to be used for stocking purposes only. Where multiple crosses are identified, please reference the applications section of this catalog. / **Remarque importante:** Les interchanges concurrentiels ne s'utilisent qu'aux fins de stocks. Dans le cas de rfrences multiples, consulter la section des applications du catalogue. / **Nota importante:** Dans le cas de rfrences multiples, consulter la section des applications du catalogue. / **Nota importante:** Se pueden usar intercambios competitivos para propósitos de almacenamiento solamente. Cuando se identifican intercambios múltiples, consulte la sección de aplicaciones de este catálogo.

COMPETITIVE & O.E.M. INTERCHANGE LIST
Lista de Intercambios contra Competidores y Equipo Original.
Liste dinterchange de produits comptitifs & dquipement original (OEM)

SAF Holland... cont'd

Saf holland	Gabriel	Upgrade	Saf holland	Gabriel	Upgrade	Saf holland	Gabriel	Upgrade	Saf holland	Gabriel	Upgrade
90045132	85909		90045503	89430		AR-1141	83204		AR1202	85300	89419
90045138	85910		90045504	85030	89440	AR-1141-C	83204		AR1202	89419	
90045175	85916	89430	90045504	89440		AR-1202	85300	89419	AR134C	85005	89430
90045175	89430		90045532	85030	89440	AR-1202	89419		AR134C	89430	
90045188	85910		90045532	89440		AR-134-C	85005	89430	AR1404	85301	
90045207	89405		90045534	85014		AR-134-C	89430		AR1425	85301	
90045277	85030	89440	90045536	89414		AR-1404	85301		AR1434	83203	89436
90045277	89440		90045563	85014		AR-1425	85301		AR1434	89436	
90045298	83363		90045564	83128	89436	AR-1434	83203	89436	AR1654	83209	89414
90045299	83389	89436	90045564	89436		AR-1434	89436		AR1654	89414	
90045299	89436		90045568	85060		AR-1654	83209	89414	AR1822	85304	
90045331	646155		90045572	85045		AR-1654	89414		AR2451	83203	89436
90045336	85014		90045574	83130		AR-1822	85304		AR2451	89436	
90045337	85911		90045575	85051		AR-2451	83203	89436	AR2598	83123	89405
90045338	85060		90045576	83150		AR-2451	89436		AR2598	89405	
90045381	83150		90045605	85109		AR-2598	83123	89405	AR718C	83203	89436
90045384	85916	89430	90045607	83150		AR-2598	89405		AR718C	89436	
90045384	89430		90045608	83363		AR-718-C	83203	89436	AR718CHD	85000	89436
90045418	85916	89430	90045665	85029		AR-718-C	89436		AR718CHD	89436	
90045418	89430		90045666	83130		AR-718-C-HD	85000	89436	AR781	83203	89436
90045419	89405		90045666	85051		AR-718-C-HD	89436		AR781	89436	
90045420	89440		90045667	85060		AR-781	83203	89436	AR958	83207	89407
90045432	85321		90045669	83389	89436	AR-781	89436		AR958	89407	
90045433	85916	89430	90045669	89436		AR-958	83207	89407	AR995	85734	
90045433	89430		90045803	85109		AR-958	89407		SAF83166SAF	83166	
90045455	85909		90045812	85109		AR-995	85734		XB-SPN-053-36	83125	
90045466	89406		90045813	85030	89440	AR1008	85006		XBSPN05336	83125	
90045471	85078		90045813	89440		AR1141	83204				
90045500	89430		AR-1008	85006		AR1141C	83204				

Safari Motor Coach

Safari motor coach	Gabriel	Upgrade	Safari motor coach	Gabriel	Upgrade	Safari motor coach	Gabriel	Upgrade	Safari motor coach	Gabriel	Upgrade
B462092	83126	89430	B462092	89430		B462093	89431				
B462092	85910		B462093	85058	89431						

Seagrave Fire Apparatus LLC

Seagrave fire apparatus llc	Gabriel	Upgrade	Seagrave fire apparatus llc	Gabriel	Upgrade	Seagrave fire apparatus llc	Gabriel	Upgrade	Seagrave fire apparatus llc	Gabriel	Upgrade
680117	85300	89419	P0025500	85300	89419	P2598000	85712				
680117	89419		P0025500	89419							

SenSen

Sensen	Gabriel	Upgrade	Sensen	Gabriel	Upgrade	Sensen	Gabriel	Upgrade	Sensen	Gabriel	Upgrade
1212-0022	61651		1212-0097	82001		1213-0145	81871		1213-0189	61524	
1212-0022	69813		1212-0098	61592		1213-0146	G63726		1213-0189	81164	
1212-0057	81416		1212-0098	81937		1213-0147	69901		1213-0190	G63815	
1212-0066	69585		1212-0100	61509		1213-0153	81911		1213-0191	G63432	
1212-0066	70001		1212-0100	61606		1213-0155	G63299		1213-0191	G63548	
1212-0083	69677		1212-0100	81541		1213-0156	61704		1213-0193	81924	
1212-0086	69996		1212-0134	69465		1213-0157	69909		1213-0246	G64026	
1212-0088	69715		1212-0136	G64052		1213-0157	81910		1213-0247	G64032	
1212-0088	69725		1212-0172	70040		1213-0158	G64087		1213-0250	70078	
1212-0088	69863		1212-0187	70027		1213-0159	81872		1213-0271	G64003	
1212-0090	61560		1213-0030	69591		1213-0160	61508		1213-0272	G64046	
1212-0090	81904		1213-0101	70000		1213-0160	61662		1213-0273	81147	
1212-0091	69787		1213-0144	61552		1213-0160	81507		1213-0276	G63815	
1212-0092	70020		1213-0144	81870		1213-0188	61516		1213-0285	G64050	
1212-0093	G63845		1213-0145	61510		1213-0188	61525		1213-0293	81495	
1212-0094	81478		1213-0145	61699		1213-0188	81039		1213-0299	69587	
1212-0096	69952		1213-0145	61700		1213-0188	81113		1213-0300	69589	

Important Note: Competitive Interchanges are to be used for stocking purposes only. Where multiple crosses are identified, please reference the applications section of this catalog. / **Remarque importante:** Les interchanges concurrentiels ne s'utilisent qu'aux fins de stocks. Dans le cas de rferences multiples, consulter la section des applications du catalogue. / **Nota importante:** Dans le cas de rferences multiples, consulter la section des applications du catalogue. / **Nota importante:** Se pueden usar intercambios competitivos para propósitos de almacenamiento solamente. Cuando se identifican intercambios múltiples, consulte la sección de aplicaciones de este catálogo.

COMPETITIVE & O.E.M. INTERCHANGE LIST
Lista de Intercambios contra Competidores y Equipo Original.
Liste dinterchange de produits comptitifs & dquipement original (OEM)

SenSen... cont'd

Sensen	Gabriel	Upgrade	Sensen	Gabriel	Upgrade	Sensen	Gabriel	Upgrade	Sensen	Gabriel	Upgrade
1213-0302	69473		1214-0010	G63832		1214-0158	61696		1214-0191	81914	
1213-0304	61616		1214-0106	G63885		1214-0158	61697		1214-0192	61612	
1213-0304	81929		1214-0106	G64029		1214-0159	G64042		1214-0192	81913	
1213-0305	81516		1214-0106	G64030		1214-0161	G63879		1214-0193	61641	
1213-0306	69590		1214-0125	61710		1214-0161	G63884		1214-0193	81920	
1213-0307	69592		1214-0125	61716		1214-0162	61718		1214-0194	81922	
1213-0307	69593		1214-0126	G63809		1214-0163	61720		1214-0195	G63772	
1213-0308	70031		1214-0127	81930		1214-0164	61734		1214-0196	61664	
1213-0309	69464		1214-0128	G63455		1214-0165	G63870		1214-0196	81869	
1213-0309	81935		1214-0129	81726		1214-0166	G63867		1214-0198	81922	
1213-0310	70086		1214-0130	61547		1214-0166	G64157		1214-0199	61663	
1213-0311	69676		1214-0130	81082		1214-0167	G63890		1214-0199	81925	
1213-0311	81481		1214-0131	G63456		1214-0167	G63891		1214-0200	81933	
1213-0312	69675		1214-0132	81667		1214-0168	61715		1214-0201	81932	
1213-0313	69898		1214-0133	61533		1214-0169	G63867		1214-0202	69900	
1213-0313	81794		1214-0133	61627		1214-0169	G64079		1214-0203	61601	
1213-0314	69574		1214-0133	81730		1214-0170	61675		1214-0203	81836	
1213-0314	69575		1214-0133	81917		1214-0171	61690		1214-0204	61711	
1213-0315	61615		1214-0134	61629		1214-0172	61643		1214-0205	G63882	
1213-0315	81548		1214-0134	81540		1214-0173	G63958		1214-0206	G63894	
1213-0315	81936		1214-0134	81905		1214-0174	61712		1214-0207	77803	
1213-0317	81559		1214-0134	81918		1214-0174	61714		1214-0210	61654	
1213-0318	G64037		1214-0135	61528		1214-0175	G63614		1214-0211	61656	
1213-0331	61679		1214-0135	81482		1214-0175	G63622		1214-0212	61565	
1213-0332	81744		1214-0136	61624		1214-0176	61685		1214-0213	61687	
1213-0346	G63782		1214-0136	81890		1214-0176	81668		1214-0214	61536	
1213-0347	G63781		1214-0137	81821		1214-0177	61591		1214-0214	81549	
1213-0351	G64027		1214-0138	61543		1214-0178	61595		1214-0215	81560	
1213-0352	G64028		1214-0138	81667		1214-0178	61646		1214-0216	81837	
1213-0353	G64048		1214-0140	61575		1214-0178	81828		1214-0217	81548	
1213-0353	G64143		1214-0140	81891		1214-0179	61544		1214-0218	61535	
1213-0365	81318		1214-0141	61600		1214-0179	61555		1214-0218	81548	
1213-0367	G63889		1214-0141	61642		1214-0179	81668		1214-0219	81691	
1213-0368	G63909		1214-0141	81873		1214-0180	G63414		1214-0220	61541	
1213-0369	G64006		1214-0142	81873		1214-0182	81446		1214-0220	81583	
1213-0404	70098		1214-0143	61625		1214-0182	81713		1214-0221	61512	
1213-0470	61777		1214-0144	61605		1214-0183	81833		1214-0221	81559	
1213-0516	G63918		1214-0144	81878		1214-0184	61546		1214-0222	G64047	
1213-0547	81675		1214-0145	61542		1214-0184	81490		1214-0223	G63678	
1213-0548	G63620		1214-0145	81726		1214-0185	61599		1214-0235	G63875	
1213-0549	69600		1214-0146	81923		1214-0185	81928		1214-0235	G64033	
1213-0549	81582		1214-0147	61658		1214-0186	61634		1214-0236	G64031	
1213-0552	69604		1214-0147	81923		1214-0186	61635		1214-0237	G63878	
1213-0552	69724		1214-0148	G63717		1214-0186	81919		1214-0240	81510	
1213-0552	81514		1214-0149	G63717		1214-0187	61623		1214-0240	81710	
1213-0555	69845		1214-0150	81873		1214-0187	61626		1214-0241	G64040	
1213-0564	69755		1214-0151	81921		1214-0187	81893		1214-0242	69594	
1213-0566	81553		1214-0152	61659		1214-0187	81916		1214-0242	69595	
1213-0569	G63426		1214-0153	61676		1214-0188	61504		1214-0243	70010	
1213-0571	G63818		1214-0153	81926		1214-0188	81750		1214-0244	G63864	
1213-0572	G63707		1214-0154	G63675		1214-0189	61611		1214-0252	61680	
1213-0574	69962		1214-0155	G63844		1214-0189	81912		1214-0253	61682	
1213-0575	G64111		1214-0156	61691		1214-0190	61638		1214-0253	61713	
1213-0576	G63411		1214-0156	61692		1214-0190	81892		1214-0255	G63888	
1213-0587	G64146		1214-0156	81931		1214-0191	61613		1214-0271	G63883	
1214-0009	G63828		1214-0157	61717		1214-0191	61614		1214-0272	G63907	

Important Note: Competitive Interchanges are to be used for stocking purposes only. Where multiple crosses are identified, please reference the applications section of this catalog. / **Remarque importante:** Les interchanges concurrentiels ne s'utilisent qu'aux fins de stocks. Dans le cas de rfrences multiples, consulter la section des applications du catalogue. / **Nota importante:** Dans le cas de rfrences multiples, consulter la section des applications du catalogue. / **Nota importante:** Se pueden usar intercambios competitivos para propósitos de almacenamiento solamente. Cuando se identifican intercambios múltiples, consulte la sección de aplicaciones de este catálogo.

COMPETITIVE & O.E.M. INTERCHANGE LIST

Lista de Intercambios contra Competidores y Equipo Original.

Liste d'interchange de produits compétitifs & d'équipement original (OEM)

SenSen... cont'd

Sensen	Gabriel	Upgrade	Sensen	Gabriel	Upgrade	Sensen	Gabriel	Upgrade	Sensen	Gabriel	Upgrade
1214-0273	61582		3213-0157	69766		3213-0635	70059		4213-0513	G56529	
1214-0273	81147		3213-0169	G55825		3214-0032	G51723		4213-0514	G56530	
1214-0305	61531		3213-0171	G51087		3214-0039	G51722		4213-0534	G56517	
1214-0392	G63607		3213-0197	G51716		3214-0053	G51477		4213-0535	G56516	
1214-0394	G63837		3213-0198	G51832		3214-0091	G51477		4213-0585	G52095	
1214-0395	61517		3213-0199	G51833		3214-0092	G51739		4213-0586	G52094	
1214-0396	61522		3213-0200	69907		3214-0094	G51077		4213-0590	G56887	
1214-0396	81496		3213-0201	G51802		3214-0105	G51870		4213-0591	G56886	
1214-0408	81484		3213-0212	G51799		3214-0107	G51865		4213-0606	G51878	
1214-0410	61608		3213-0236	G51738		3214-0108	G51864		4213-0607	G51877	
1214-0415	G63511		3213-0240	G51881		3214-0110	G51724		4213-0608	G51892	
1214-0418	G63394		3213-0241	G51798		3214-0111	G51718		4213-0617	G51896	
1214-0418	G63625		3213-0245	G51961		3214-0112	G51888		4213-0617	G51897	
1214-0420	61530		3213-0252	G56598		3214-0113	G51704		4213-0619	G51854	
1214-0424	G63616		3213-0253	G51740		3214-0114	G51703		4213-0620	G51853	
1214-0428	G64043		3213-0254	G51700		3214-0115	G51719		4213-0640	G52018	
1214-0429	G64038		3213-0256	G51814		3214-0116	G51729		4213-0640	G52162	
1214-0433	61554		3213-0257	G51813		3214-0117	G56807		4213-0641	G52017	
2213-0076	G44461		3213-0258	G51742		3214-0118	G51728		4213-0850	G52155	
2213-0077	69787		3213-0259	G51804		3214-0119	G51760		4213-0851	G52154	
3212-0057	G51727		3213-0259	G51805		3214-0119	G51761		4213-0944	G55591	
3212-0079	G51794		3213-0261	70049		3214-0119	G51947		4213-0945	G55591	
3212-0113	G51838		3213-0262	G64049		3214-0119	G51948		4213-0958	G52354	
3212-0147	69945		3213-0263	70013		3214-0125	G51891		4213-0959	G52353	
3212-0147	81934		3213-0265	G56597		3214-0132	G51477		4213-0960	G52440	
3212-0170	G51908		3213-0269	G51905		3214-0133	G51766		4213-0961	G52439	
3212-0175	70033		3213-0271	G511004		3214-0134	G51715		4214-0014	G56606	
3212-0178	G51727		3213-0284	G51815		3214-0136	61590		4214-0023	G55675	
3212-0181	69946		3213-0285	G51849		3214-0140	G51765		4214-0029	G52244	
3212-0182	69863		3213-0288	G51746		3214-0150	G51855		4214-0029	G55949	
3212-0182	69903		3213-0289	G51267		3214-0152	G51856		4214-0032	G55676	
3212-0183	70003		3213-0290	G51859		3214-0162	G51861		4214-0141	G55999	
3212-0184	70065		3213-0291	G51842		3214-0168	G56838		4214-0142	G55999	
3212-0226	G51807		3213-0295	G51268		3214-0185	61561		4214-0167	G56778	
3212-0242	G51795		3213-0305	G51267		3214-0185	81744		4214-0168	G56778	
3212-0243	G51794		3213-0322	69450		3214-0186	G51850		4214-0191	G56539	
3212-0244	69586		3213-0326	G63418		3214-0188	G56839		4214-0192	G56540	
3212-0246	70028		3213-0327	G51874		4213-0279	G55820		4214-0248	G56633	
3212-0266	G51990		3213-0328	70053		4213-0305	G55662		4214-0249	G56634	
3212-0273	G51863		3213-0330	G51799		4213-0306	G55661		4214-0258	G56537	
3212-0276	70055		3213-0331	70037		4213-0320	G55774		4214-0259	G56538	
3212-0277	70041		3213-0337	G51879		4213-0321	G55774		4214-0484	G56581	
3212-0278	G51863		3213-0338	G51803		4213-0322	G56894		4214-0485	G56582	
3212-0353	G51848		3213-0383	70045		4213-0359	G52163		4214-0588	G52006	
3212-0366	70052		3213-0451	G63720		4213-0366	G55999		4214-0589	G52005	
3212-0367	70036		3213-0452	G51910		4213-0367	G55999		4214-0664	G56514	
3212-0429	G51983		3213-0513	70096		4213-0368	G55999		4214-0665	G56506	
3213-0046	G55821		3213-0515	G51852		4213-0370	G51714		4214-0674	G51097	
3213-0047	G56591		3213-0557	G64056		4213-0377	G56893		4214-0687	G56821	
3213-0079	G55910		3213-0599	61593		4213-0378	G56892		4214-0688	G56822	
3213-0096	G52037		3213-0600	G51884		4213-0489	G52335		4214-0689	G56820	
3213-0097	G52036		3213-0601	G51996		4213-0489	G52336		4214-0690	G56819	
3213-0109	G51736		3213-0602	G511001		4213-0491	G51806		4214-0694	G55994	
3213-0144	G51077		3213-0604	70089		4213-0494	G51806		4214-0695	G55993	
3213-0153	G51858		3213-0616	G511043		4213-0501	G52153		4214-0698	G56672	
3213-0155	G51767		3213-0624	70068		4213-0502	G52152		4214-0699	G56671	

Important Note: Competitive Interchanges are to be used for stocking purposes only. Where multiple crosses are identified, please reference the applications section of this catalog. / **Remarque importante:** Les interchanges concurrentiels ne s'utilisent qu'aux fins de stocks. Dans le cas de références multiples, consulter la section des applications du catalogue. / **Nota importante:** Dans le cas de références multiples, consulter la section des applications du catalogue. / **Nota importante:** Se pueden usar intercambios competitivos para propósitos de almacenamiento solamente. Cuando se identifican intercambios múltiples, consulte la sección de aplicaciones de este catálogo.

COMPETITIVE & O.E.M. INTERCHANGE LIST
Lista de Intercambios contra Competidores y Equipo Original.
Liste d'interchange de produits complitifs & d'equpement original (OEM)

SenSen... cont'd

Sensen	Gabriel	Upgrade	Sensen	Gabriel	Upgrade	Sensen	Gabriel	Upgrade	Sensen	Gabriel	Upgrade
4214-0700	G56622		4214-1175	G56730		4214-1428	G52122		9213-0012	G56949	
4214-0701	G56621		4214-1176	G56894		4214-1429	G52121		9213-0024	G57421	
4214-0702	G56758		4214-1177	G52248		4214-1432	G52125		9213-0025	G57420	
4214-0703	G56759		4214-1178	G52247		4214-1433	G52332		9213-0029	G57064	
4214-0712	G56561		4214-1184	G56688		4214-1434	G52331		9213-0030	G56992	
4214-0713	G56562		4214-1185	G56687		4214-1437	G52014		9213-0031	G57026	
4214-0734	G55901		4214-1186	G52145		4214-1438	G52013		9213-0032	G56948	
4214-0747	G55948		4214-1187	G52144		4214-1441	G52157		9213-0033	G57063	
4214-0777	G52007		4214-1188	G52141		4214-1442	G52156		9213-0034	G56948	
4214-0778	G52004		4214-1189	G52140		4214-1445	G56843		9213-0035	G56991	
4214-0790	G56718		4214-1191	G52106		4214-1446	G56842		9213-0038	G57087	
4214-0795	G52204		4214-1192	G52105		4214-1447	G52254		9213-0039	G57086	
4214-0796	G52203		4214-1198	G56733		4214-1448	G52253		9213-0046	G57035	
4214-0811	G52161		4214-1199	G56732		4214-1462	G56735		9213-0047	G57034	
4214-0812	G52160		4214-1202	G52108		4214-1463	G56734		9213-0048	G57033	
4214-0813	G52104		4214-1202	G56797		4214-1466	G51758		9213-0048	G57062	
4214-0814	G52103		4214-1203	G52107		4214-1467	G51860		9213-0049	G57032	
4214-0815	G52300		4214-1203	G56798		4214-1476	G52033		9213-0049	G57061	
4214-0816	G52299		4214-1257	G52131		4214-1477	G52032		9213-0050	G56943	
4214-0838	G56635		4214-1258	G56620		4214-1559	G52143		9213-0051	G57168	
4214-0839	G56636		4214-1261	G56568		4214-1560	G52142		9213-0052	G57167	
4214-0840	G56641		4214-1262	G56601		4214-1731	G52258		9213-0053	G57055	
4214-0841	G56640		4214-1264	G56681		4214-1732	G52257		9213-0054	G57054	
4214-0851	G56722		4214-1265	G56655		4214-1775	G52149		9213-0055	G57089	
4214-0852	G56721		4214-1267	G56817		4214-1776	G52148		9213-0056	G57088	
4214-0853	G56729		4214-1270	G56836		4214-1899	G52246		9213-0057	G57409	
4214-0854	G56728		4214-1271	G56837		4214-1900	G52245		9213-0058	G57146	
4214-0855	G56802		4214-1272	G56841		4214-2072	G52281		9213-0065	G57068	
4214-0892	G52009		4214-1273	G56840		4214-2073	G52280		9213-0066	G57067	
4214-0893	G52008		4214-1274	G52116		4214-2076	G52406		9213-0074	G57404	
4214-0901	G52185		4214-1275	G52082		4214-2085	G52295		9213-0075	G57405	
4214-0902	G52184		4214-1276	G52081		4214-2086	G52097		9213-0076	G57059	
4214-0903	G52169		4214-1277	G55892		4214-2087	G52096		9213-0079	G57279	
4214-0904	G52168		4214-1280	G55948		4214-2127	G56700		9213-0080	G57278	
4214-0906	G52159		4214-1284	G55856		4214-2129	G55551		9213-0081	G57422	
4214-0907	G52158		4214-1286	G55697		4214-2201	G52250		9213-0082	G57056	
4214-1033	G52375		4214-1288	G56810		4214-2202	G52249		9213-0083	G57075	
4214-1034	G52374		4214-1292	G56809		4214-2241	G52174		9213-0084	G57091	
4214-1076	G52113		4214-1293	G56774		4214-2242	G52173		9213-0085	G57090	
4214-1077	G52112		4214-1294	G56773		4214-2390	G52361		9213-0095	G57149	
4214-1089	G56660		4214-1295	G52027		4214-2391	G52360		9213-0096	G57178	
4214-1090	G56661		4214-1296	G52026		4214-2394	G52383		9213-0097	G57419	
4214-1091	G52165		4214-1302	G56509		4214-2395	G52382		9213-0098	G57425	
4214-1091	G52298		4214-1303	G55896		9212-0001	G57036		9213-0099	G57424	
4214-1092	G52164		4214-1304	G55698		9212-0002	G56998		9213-0100	G57208	
4214-1092	G52297		4214-1336	G56701		9212-0003	G57057		9213-0102	G57270	
4214-1102	G52210		4214-1347	G52025		9212-0003	G57058		9213-0103	G57427	
4214-1103	G52209		4214-1347	G55948		9212-0004	G57159		9213-0104	G57148	
4214-1157	G56799		4214-1393	G52188		9212-0004	G57160		9213-0106	G57428	
4214-1158	G56800		4214-1394	G52187		9213-0001	G56996		9213-0107	G57429	
4214-1159	G52098		4214-1407	G52128		9213-0002	G57013		9213-0110	G57423	
4214-1172	G56735		4214-1408	G52127		9213-0003	G56997		9213-0113	G57108	
4214-1173	G56734		4214-1409	G52118		9213-0004	G57014		9213-0114	G57107	
4214-1174	G56680		4214-1410	G52117		9213-0005	G57020		9213-0116	G57415	
4214-1174	G56731		4214-1411	G52118		9213-0010	G56938		9213-0117	G57414	
4214-1175	G56679		4214-1412	G52117		9213-0011	G56950		9213-0119	G57682	

Important Note: Competitive Interchanges are to be used for stocking purposes only. Where multiple crosses are identified, please reference the applications section of this catalog./ **Remarque importante:** Les interchanges concurrentiels ne s'utilisent qu'aux fins de stocks. Dans le cas de rferences multiples, consulter la section des applications du catalogue./ **Nota importante:** Dans le cas de rferences multiples, consulter la section des applications du catalogue./ **Nota importante:** Se pueden usar intercambios competitivos para propósitos de almacenamiento solamente. Cuando se identifican intercambios múltiples, consulte la sección de aplicaciones de este catálogo.

COMPETITIVE & O.E.M. INTERCHANGE LIST
Lista de Intercambios contra Competidores y Equipo Original.
Liste d'interchange de produits compétitifs & d'équipement original (OEM)

SenSen... cont'd

Sensen	Gabriel	Upgrade	Sensen	Gabriel	Upgrade	Sensen	Gabriel	Upgrade	Sensen	Gabriel	Upgrade
9214-0120	G57416		9214-0125	G57646		9214-0189	G56964		9214-0280	G57276	
9214-0162	G57453		9214-0127	G57039		9214-0190	G57111		9214-0281	G57275	
9214-0162	G57454		9214-0128	G57103		9214-0191	G57110		9214-0286	G57490	
9214-0001	G56936		9214-0128	G57132		9214-0192	G57191		9214-0287	G57489	
9214-0002	G57019		9214-0129	G57053		9214-0193	G57190		9214-0290	G57460	
9214-0004	G57016		9214-0130	G57115		9214-0194	G57113		9214-0291	G57459	
9214-0005	G57021		9214-0131	G57114		9214-0195	G57112		9214-0294	G57153	
9214-0006	G57007		9214-0132	G57048		9214-0196	G57098		9214-0295	G57152	
9214-0007	G57015		9214-0133	G57047		9214-0197	G57097		9214-0296	G57151	
9214-0008	G57022		9214-0134	G57044		9214-0210	G57177		9214-0297	G57150	
9214-0009	G57018		9214-0135	G57043		9214-0211	G57176		9214-0298	G57140	
9214-0010	G57017		9214-0136	G57079		9214-0212	G57120		9214-0299	G57139	
9214-0011	G56927		9214-0137	G57078		9214-0213	G57119		9214-0313	G57474	
9214-0011	G56931		9214-0138	G57042		9214-0214	G57378		9214-0314	G57473	
9214-0012	G56930		9214-0139	G57041		9214-0215	G57377		9214-0319	G57203	
9214-0014	G57060		9214-0140	G56931		9214-0216	G57031		9214-0320	G57202	
9214-0015	G57060		9214-0141	G56930		9214-0217	G57030		9214-0321	G57334	
9214-0016	G56933		9214-0142	G56925		9214-0218	G57142		9214-0322	G57333	
9214-0017	G56931		9214-0143	G56924		9214-0219	G57141		9214-0327	G57391	
9214-0019	G57008		9214-0144	G56957		9214-0220	G57106		9214-0328	G57390	
9214-0020	G56924		9214-0145	G56956		9214-0221	G57105		9214-0329	G57573	
9214-0021	G56925		9214-0146	G57083		9214-0222	G57081		9214-0330	G57572	
9214-0075	G56935		9214-0147	G57083		9214-0223	G57082		9214-0331	G57456	
9214-0076	G56934		9214-0148	G57070		9214-0234	G57338		9214-0332	G57455	
9214-0076	G56937		9214-0148	G57122		9214-0235	G57337		9214-0333	G57332	
9214-0077	G57051		9214-0149	G57069		9214-0236	G57282		9214-0334	G57331	
9214-0078	G56932		9214-0149	G57121		9214-0237	G56975		9214-0351	G57185	
9214-0079	G56963		9214-0150	G57010		9214-0238	G57031		9214-0352	G57184	
9214-0080	G56965		9214-0151	G57010		9214-0239	G57030		9214-0353	G57131	
9214-0081	G56951		9214-0152	G57060		9214-0240	G57164		9214-0354	G57130	
9214-0083	G57066		9214-0153	G57071		9214-0241	G57163		9214-0371	G57394	
9214-0084	G56962		9214-0155	G57000		9214-0242	G57267		9214-0372	G57393	
9214-0089	G57065		9214-0155	G57023		9214-0243	G57266		9214-0414	G57494	
9214-0090	G57085		9214-0156	G57147		9214-0244	G57206		9214-0415	G57493	
9214-0091	G57084		9214-0157	G57172		9214-0247	G56924		9214-0416	G57376	
9214-0099	G57046		9214-0158	G57080		9214-0249	G57219		9214-0417	G57375	
9214-0100	G57045		9214-0159	G57173		9214-0250	G57218		9214-0430	G57664	
9214-0101	G57031		9214-0160	G56928		9214-0251	G57363		9214-0431	G57663	
9214-0102	G57030		9214-0161	G57027		9214-0252	G57364		9214-0440	G57274	
9214-0103	G57050		9214-0162	G57027		9214-0255	G57370		9214-0447	G57518	
9214-0104	G57049		9214-0163	G57125		9214-0256	G57369		9214-0448	G57517	
9214-0107	G57134		9214-0164	G56951		9214-0259	G57342		9214-0451	G56726	
9214-0108	G57133		9214-0169	G57099		9214-0260	G57341		9214-0452	G57006	
9214-0109	G57124		9214-0169	G57100		9214-0263	G57340		9214-0456	G56929	
9214-0110	G57123		9214-0171	G57158		9214-0264	G57339		9214-0465	G57177	
9214-0113	G57012		9214-0177	G57372		9214-0265	G57346		9214-0466	G57176	
9214-0114	G57011		9214-0178	G57373		9214-0266	G57345		9214-0475	G56974	
9214-0119	G57050		9214-0179	G57162		9214-0267	G57269		9214-0476	G56973	
9214-0120	G57049		9214-0180	G57161		9214-0268	G57268		9214-0483	G57646	
9214-0121	G57027		9214-0181	G57191		9214-0273	G57223		9214-0484	G57645	
9214-0122	G57027		9214-0182	G57190		9214-0274	G57222		9214-0501	G57198	
9214-0123	G57077		9214-0183	G57193		9214-0275	G57277		9214-0502	G57197	
9214-0124	G57076		9214-0184	G57192		9214-0276	G57324		9214-0543	G57613	
9214-0125	G57092		9214-0186	G57271		9214-0277	G57201		9214-0544	G57612	
9214-0125	G57118		9214-0187	G57095		9214-0278	G57200		9214-0545	G57072	
9214-0125	G57413		9214-0188	G57096		9214-0279	G57109		9214-0546	G57071	

Important Note: Competitive Interchanges are to be used for stocking purposes only. Where multiple crosses are identified, please reference the applications section of this catalog. / **Remarque importante:** Les interchanges concurrentiels ne s'utilisent qu'aux fins de stocks. Dans le cas de références multiples, consulter la section des applications du catalogue. / **Nota importante:** Dans le cas de références multiples, consulter la section des applications du catalogue. / **Nota importante:** Se pueden usar intercambios competitivos para propósitos de almacenamiento solamente. Cuando se identifican intercambios múltiples, consulte la sección de aplicaciones de este catálogo.

COMPETITIVE & O.E.M. INTERCHANGE LIST

Lista de Intercambios contra Competidores y Equipo Original.

Liste d'interchange de produits compititifs & d'equipement original (OEM)

SenSen... cont'd

Sensen	Gabriel	Upgrade	Sensen	Gabriel	Upgrade	Sensen	Gabriel	Upgrade	Sensen	Gabriel	Upgrade
9214-0562	G57647		M70265	143390		M72070	143388		M73120	143305	
9214-0579	G57145		M70275	143391		M72080	143387		M73280	143324	
9214-0580	G57144		M70280	142252		M72180	143087		M73520	143256	
9214-0592	G57354		M70290	143492		M72440	142530		M73540	143191	
9214-0593	G57353		M70300	143367		M72500	142245		M73620	143464	
B70090	143063		M70330	142938		M72600	143074		M73630	143202	
B70100	143057		M70375	143344		M72610	143073		M73690	143318	
B70120	143058		M70440	143082		M72630	142526		M73700	143353	
B70150	143057		M70450	143325		M72680	142828		M73710	143353	
B70160	143059		M70490	142625		M72690	142932		M73770	143204	
B70170	143061		M70510	142561		M72700	142930		M73780	143201	
B70250	143058		M70550	142444		M72770	143317		M73805	143341	
B72270	143058		M70660	143458		M72780	143244		M73855	143335	
M70000	142651		M70690	142195		M72810	143323		M73970	143345	
M70040	142650		M70700	142135		M72820	143355		M74045	143089	
M70070	142649		M70870	143209		M72830	143354		M74055	143363	
M70135	143477		M70920	143197		M72840	143316		M74065	143342	
M70140	143281		M71200	142852		M72860	143385		M75125	143339	
M70150	143088		M71280	143404		M72880	143364		M75155	143406	
M70170	143315		M71730	143191		M72890	143369		M75165	143360	
M70205	143365		M71950	142230		M72890	143468		M75170	143361	
M70215	143531		M71950	142419		M72910	143319		M75175	143495	
M70220	142836		M71950	143423		M73080	142547		M75235	143473	
M70230	142546		M72030	143218		M73090	142937				

Shasta RV

Shasta rv	Gabriel	Upgrade	Shasta rv	Gabriel	Upgrade	Shasta rv	Gabriel	Upgrade	Shasta rv	Gabriel	Upgrade
8C24-18045-DA	G63622		8C2Z-18124-D	G63622		ASH-1136	G63623		AT-163G	G63622	
8C24-18080-DB	G63623		8C2Z-18125-D	G63623		ASH-1154	G63622		AT-164G	G63623	
8C2418045DA	G63622		8C2Z18124D	G63622		ASH1136	G63623		AT163G	G63622	
8C2418080DB	G63623		8C2Z18125D	G63623		ASH1154	G63622		AT164G	G63623	

Spartan Motors

Spartan motors	Gabriel	Upgrade	Spartan motors	Gabriel	Upgrade	Spartan motors	Gabriel	Upgrade	Spartan motors	Gabriel	Upgrade
0272-SS5	85712		2502B46	85013	89414	60665014L	85962		B461725	85029	
0272SS5	85712		2502B46	89414		60665025L	85036	89405	B461725	85910	
0346-SS5	85013	89414	471700000456	85959		60665025L	89405		B461731	85909	
0346-SS5	85030	89440	471700000460	85959		78068	85304		B461732	85030	89440
0346-SS5	89414		58913-009	85959		AS 4025B	85712		B461732	89440	
0346-SS5	89440		58913-009L	85959		B46-1594	85013	89414	B462150	85909	
0346SS5	85013	89414	58913009	85959		B46-1594	85030	89440	B462151	85007	
0346SS5	85030	89440	58913009L	85959		B46-1594	89414		B462151	85030	89440
0346SS5	89414		59011	83214		B46-1594	89440		B462151	89440	
0346SS5	89440		60665-014	85962		B46-1725	85029		B462385	85030	89440
0377-SS5	85029		60665-014L	85962		B46-2151	85007		B462385	89440	
0377SS5	85029		60665-025	85036	89405	B461593	85909		B462502	85013	89414
1300B46	85029		60665-025	89405		B461594	85013	89414	B462502	85030	89440
21310-01	85307		60665-025L	85036	89405	B461594	85030	89440	B462502	89414	
2131001	85307		60665-025L	89405		B461594	89414		B462502	89440	
2200201	85007		60665014	85962		B461594	89440		S2607B	85702	

Spring Valley

Spring valley	Gabriel	Upgrade	Spring valley	Gabriel	Upgrade	Spring valley	Gabriel	Upgrade	Spring valley	Gabriel	Upgrade
632155	646177										

Starcraft Bus Co.

Starcraft bus co.	Gabriel	Upgrade	Starcraft bus co.	Gabriel	Upgrade	Starcraft bus co.	Gabriel	Upgrade	Starcraft bus co.	Gabriel	Upgrade
3578858C1	85656		3584116C2	83175		471700011531	85180		4C4Z-18124-RA	85928	
3578858C2	85656		3584118C2	85928		4C4Z-18124-JB	85928		4C4Z-18125-B	83317	
3584116C1	83175		471700011530	85181		4C4Z-18124-QA	83175		4C4Z-18125-DA	85656	

Important Note: Competitive Interchanges are to be used for stocking purposes only. Where multiple crosses are identified, please reference the applications section of this catalog. / **Remarque importante:** Les interchanges concurrentiels ne s'utilisent qu'aux fins de stocks. Dans le cas de rferences multiples, consulter la section des applications du catalogue. / **Nota importante:** Dans le cas de rferences multiples, consulter la section des applications du catalogue. / **Nota importante:** Se pueden usar intercambios competitivos para propósitos de almacenamiento solamente. Cuando se identifican intercambios múltiples, consulte la sección de aplicaciones de este catálogo.

COMPETITIVE & O.E.M. INTERCHANGE LIST
Lista de Intercambios contra Competidores y Equipo Original.
Liste d'interchange de produits complitifs & d'equpement original (OEM)

Starcraft Bus Co.... cont'd

Starcraft bus co.	Gabriel	Upgrade	Starcraft bus co.	Gabriel	Upgrade	Starcraft bus co.	Gabriel	Upgrade	Starcraft bus co.	Gabriel	Upgrade
4C4Z18124JB	85928		AA616	83175		ASH24659	85181		FC4418080AB	85180	
4C4Z18124QA	83175		AA617	85928		ASH24660	85180		FC4Z-18124-A	85181	
4C4Z18124RA	85928		ASH-1136	G63623		ASH24661	83317		FC4Z-18124-B	85181	
4C4Z18125B	83317		ASH-1154	G63622		AT-812	85928		FC4Z-18125-A	85180	
4C4Z18125DA	85656		ASH-24658	85181		AT812	85928		FC4Z18124A	85181	
501906C92	83317		ASH-24659	85181		FC44-18045-BB	85181		FC4Z18124B	85181	
AA-616	83175		ASH-24660	85180		FC44-18080-AB	85180		FC4Z18125A	85180	
AA-617	85928		ASH24658	85181		FC4418045BB	85181				

Stellantis

Stellantis	Gabriel	Upgrade	Stellantis	Gabriel	Upgrade	Stellantis	Gabriel	Upgrade	Stellantis	Gabriel	Upgrade
0489 5466AC	G51948		4766 958AD	G51848		5105 105AF	G57178		5211 0214AB	81931	
0489 5467AC	G51947		478 2643AD	G57194		5105 170AF	G57177		5272 325AE	G55892	
05168284AC	85649		478 2643AD	G57195		5105 170AH	G57177		5272 612AK	G51863	
05168295AB	85649		478 2731AE	G57071		5105 171AF	G57176		5272 613AL	G51863	
05168296AA	85650		478 2731AE	G57072		5105 171AH	G57176		5272 706AE	G57178	
2174 915AG	G57053		478 2731AE	G57194		5105 790AL	G51863		5272 706AH	G57178	
2516 009	G63183		478 2731AE	G57195		5114 318AB	81936		5285 5333AF	G63892	
2516009	G63183		478 2732AE	G57071		5135 538AA	G56620		5285 5334AD	G63892	
2960 707	G63183		478 2732AE	G57072		5135 573AJ	G56807		6800 1151AB	61720	
2960707	G63183		4782 644AD	G57194		5161 265AC	G57146		6800 3952AC	G51728	
2961 043	G63183		4782 644AD	G57195		5161 273AC	G57146		6800 3954AB	G51728	
2961043	G63183		4782 732AE	G57194		5161 274AB	G57146		6802 6140AD	G52118	
3633 643	G63183		4782 732AE	G57195		5166 820AI	G56807		6802 6141AD	G52117	
3633 744	G63183		4782 733AD	G57194		5168 236AB	143336		6802 6142AC	G52118	
3633643	G63183		4782 733AD	G57195		5170 297AG	G57053		6802 6142AD	G52118	
3633744	G63183		4782 734AD	G57194		5170 298AG	G57053		6802 6143AC	G52117	
3638 112	G63183		4782 734AD	G57195		5170 298AH	G57053		6802 6143AD	G52117	
3638 631	G63605		4886 509AI	61536		5171 093AC	143336		6802 6148AD	G52118	
3638112	G63183		489 5747AA	G57071		5171 122AC	143336		6802 6149AC	G52117	
3638631	G63605		489 5747AA	G57072		5174 300AH	G57053		6802 6149AD	G52117	
4036 892	G63605		489 5748AB	G57071		5174 563AF	G57146		6802 6158AD	G52118	
4036892	G63605		489 5748AB	G57072		5174 915AH	G57053		6802 6159AD	G52117	
4443 482	81825		4895 000AE	G55856		5174 997AD	G51758		6802 6528AD	G52118	
4656 439AH	69473		4895 516AC	G57194		518 0998AA	G57071		6802 6529AD	G52117	
4656 449AD	G55896		4895 516AC	G57195		518 0998AA	G57072		6803 3950AB	G52131	
4656 612AH	69473		4897 412AD	81548		5180 998AA	G57194		6803 9638AF	G52149	
4670 468AA	143385		4897 412AH	61535		5180 998AA	G57195		6803 9639AF	G52148	
4684 681AB	81878		4897 413AA	81691		52038134	81559		6803 9640AB	G52149	
4684 682AB	81878		4897 413AG	81548		52038135	81559		6803 9640AE	G52149	
4684 770	69632		4897 414AG	61535		52038910	81837		6803 9641AB	G52148	
4684 777	69632		4897 414AG	81691		52038912	81837		6803 9641AE	G52148	
4684 779	69632		4897 443AD	81928		52038914	81837		6803 9642AF	G52149	
4694 773	69632		4897 451AA	G55697		52039302	81560		6803 9643AF	G52148	
4721 686AE	G64042		4897 472AD	81919		52039303	81560		6804 0880AG	G64011	
4721 687AB	G64042		4897 567AA	81936		5208 7777AF	61536		6804 0882AD	G64011	
4743 125	G63426		5014 730AA	81869		5208 777AF	81549		6804 2864AC	G52131	
4743 127	G63426		5014 732AG	81869		5208 7948AF	61536		6804 3990AB	G52149	
4743 128	G63426		5015 442AD	81836		5208 7948AF	81549		6804 3991AB	G52148	
4743 224AA	61605		5016 354AB	81836		5208 8221AG	81926		6804 6314AB	G57007	
4743 225AA	61605		5066 334AA	G56620		5208 8235AE	81926		6804 6314AC	G57007	
4743 229AA	61605		5066 336AA	G56620		5208 8654AB	81929		6804 6314AD	G57007	
4743 413AC	81878		5073 263AC	81932		5208 9751AL	61715		6804 6318AB	G57007	
4743 866AD	G51848		5073 265AC	81932		52087901	81891		6804 7812AD	G64008	
4764 523AA	G51267		5085 461AB	143495		5210 6928AB	81923				
4766 053AF	G51863		5103 514AC	81933		5210 6955AB	81923				
4766 124	G63426		5105 096AG	G57177		5210 9912AD	G63844				
4766 957AD	G51848		5105 097AG	G57176		5211 0211AB	81931				

Important Note: Competitive Interchanges are to be used for stocking purposes only. Where multiple crosses are identified, please reference the applications section of this catalog. / **Remarque importante:** Les interchanges concurrentiels ne s'utilisent qu'aux fins de stocks. Dans le cas de références multiples, consulter la section des applications du catalogue. / **Nota importante:** Dans le cas de références multiples, consulter la section des applications du catalogue. / **Nota importante:** Se pueden usar intercambios competitivos para propósitos de almacenamiento solamente. Cuando se identifican intercambios múltiples, consulte la sección de aplicaciones de este catálogo.

COMPETITIVE & O.E.M. INTERCHANGE LIST

Lista de Intercambios contra Competidores y Equipo Original.

Liste dinterchange de produits comptitifs & dquipement original (OEM)

Stellantis... cont'd

Stellantis	Gabriel	Upgrade	Stellantis	Gabriel	Upgrade	Stellantis	Gabriel	Upgrade	Stellantis	Gabriel	Upgrade
6804 7814AB	G63966		6811 1104AB001	85649		6815 5259AC	G57007		6824 5775AA	G57801	
6805 3860AA	14040		6811 1105AC	85649		6815 6980AB	G52131		6827 0280AA	G57800	
6805 7374AA	G64043		6811 1105AC-001	85649		6815 7795AD	G57800		6827 0280AA	G57801	
6805 8866AA	G51842		6811 1105AC001	85649		6815 7795AD	G57801		G0060043	81834	
6806 7325AA	G64043		6811 1107AA	85650		6817 0198AB	G51856		MB109561	G63950	
6806 7515AD	G63967		6811 1107AA-001	85650		6817 0199AB	G51856		MB111216	G63419	
6806 7516AF	G64008		6811 1107AA001	85650		6818 5556AE	G57800		MB242146	81147	
6808 7339AA	G52131		6813 8247AC	G64042		6818 5556AE	G57801		MB515371	81147	
6808 7359AF	G64008		6813 8247AE	G64042		6821 0451AA	G64008		MB910496	G55820	
6808 7362AD	G63967		6813 8775AB	G64008		6821 0452AA	G63966		SG23086	81496	
6808 7363AC	G63967		6813 9381AA	61712		6822 4858AD	G511038		SG23095	69632	
6809 2726AA	G64042		6814 4549AE	G64042		6822 4861AD	G511038		SG23127	81096	
6811 1104AB	85649		6814 8548AC	G52149		6823 4553AD	61712				
6811 1104AB-001	85649		6814 8549AC	G52148		6824 5775AA	G57800				

Sterling Truck

Sterling truck	Gabriel	Upgrade	Sterling truck	Gabriel	Upgrade	Sterling truck	Gabriel	Upgrade	Sterling truck	Gabriel	Upgrade
05168284AC	85649		481700006850	85724	89443	AX267A	83309		F2HZ18124B	85301	
05168295AB	85649		481700006850	89443		AX310	83215		F4HT-18080-AB	85314	89425
05168296AA	85650		481700125969	85956		C4HZ-18124-E	83309		F4HT-18080-AB	89425	
10-12388-000	85920	89503	481700125970	85956		C4HZ18124E	83309		F4HT-18080-BA	85001	89410
10-12388-000	89503		4C4Z-18124-N	85957		C4TZ-18124-AB	83308		F4HT-18080-BA	89410	
10-12390-000	85920	89503	4C4Z-18125-DA	85656		C4TZ18124AB	83308		F4HT18080AB	85314	89425
10-12390-000	89503		4C4Z18124N	85957		D8HZ-18124-A	85301		F4HT18080AB	89425	
10-13205-000	85918	89449	4C4Z18125DA	85656		D8HZ18124A	85301		F4HT18080BA	85001	89410
10-13205-000	89449		57241-2	83109		E6HZ-18124-A	85301		F4HT18080BA	89410	
1012388000	85920	89503	572412	83109		E6HZ-18124-D	85301		F5HZ-18124-A	83314	
1012388000	89503		58913-003	85932	89453	E6HZ-18125-D	83215		F5HZ-18124-B	83107	
1012390000	85920	89503	58913-003	89453		E6HZ18124A	85301		F5HZ-18124-C	85063	
1012390000	89503		58913-003L	85932	89453	E6HZ18124D	85301		F5HZ-18124-D	83125	
1013205000	85918	89449	58913-003L	89453		E6HZ18125D	83215		F5HZ-18125-A	85314	89425
1013205000	89449		58913003	85932	89453	E7HZ-18124-A	85301		F5HZ-18125-A	89425	
1202-1043	83025		58913003	89453		E7HZ18124A	85301		F5HZ-18125-B	85001	89410
12021043	83025		58913003L	85932	89453	E7XZ-18124-A	G63386		F5HZ-18125-B	89410	
16-13957-000	85724	89443	58913003L	89453		E7XZ-18125-B	G63387		F5HZ18124A	83314	
16-13957-000	89443		6803230300	85006		E7XZ18124A	G63386		F5HZ18124B	83107	
16-15770-000	85956		6803260000	83120		E7XZ18125B	G63387		F5HZ18124C	85063	
16-15817-000	85724	89443	680339	85724	89443	E9HZ-18124-A	83309		F5HZ18124D	83125	
16-15817-000	89443		680339	89443		E9HZ18124A	83309		F5HZ18125A	85314	89425
1613957000	85724	89443	680611	85724	89443	F0HZ-18124-B	85006		F5HZ18125A	89425	
1613957000	89443		680611	89443		F0HZ18124B	85006		F5HZ18125B	85001	89410
1615770000	85956		6811 1104AB	85649		F1HZ-18124-A	83309		F5HZ18125B	89410	
1615817000	85724	89443	6811 1104AB-001	85649		F1HZ-18124-B	83308		F6HT-18045-AA	85054	
1615817000	89443		6811 1104AB001	85649		F1HZ-18124-D	85006		F6HT-18045-AC	85054	
18-45067-000	83034		6811 1105AC	85649		F1HZ-18124-E	85006		F6HT-18045-BC	85047	89435
1845067000	83034		6811 1105AC-001	85649		F1HZ-18124-H	85040		F6HT-18045-BC	89435	
471700002810	85724	89443	6811 1105AC001	85649		F1HZ-18124-J	83308		F6HT-18045-CC	85055	89439
471700002810	89443		6811 1107AA	85650		F1HZ-18124-K	89402		F6HT-18045-CC	89439	
471700131331	85932	89453	6811 1107AA-001	85650		F1HZ18124A	83309		F6HT-18045-EB	85055	89439
471700131331	89453		6811 1107AA001	85650		F1HZ18124B	83308		F6HT-18045-EB	89439	
471700131646	85918	89449	6E7Z-18125-A	83364		F1HZ18124D	85006		F6HT-18045-EC	85055	89439
471700131646	89449		6E7Z18125A	83364		F1HZ18124E	85006		F6HT-18045-EC	89439	
471700131650	85918	89449	90045099	85906	89407	F1HZ18124H	85040		F6HT-18045-GB	85030	89440
471700131650	89449		90045099	89407		F1HZ18124J	83308		F6HT-18045-GB	89440	
47902-28	85013	89414	AT-560	G63809		F1HZ18124K	89402				
47902-28	89414		AT560	G63809		F2HZ-18124-A	85376				
4790228	85013	89414	AX-267A	83309		F2HZ-18124-B	85301				
4790228	89414		AX-310	83215		F2HZ18124A	85376				

Important Note: Competitive Interchanges are to be used for stocking purposes only. Where multiple crosses are identified, please reference the applications section of this catalog. / Remarque importante: Les interchanges concurrentiels ne s'utilisent qu'aux fins de stocks. Dans le cas de rferences multiples, consulter la section des applications du catalogue. / Nota importante: En el caso de referencias multiples, consultar la sección de aplicaciones del catálogo. / Nota importante: Se pueden usar intercambios competitivos para propósitos de almacenamiento solamente. Cuando se identifican intercambios múltiples, consulte la sección de aplicaciones de este catálogo.

COMPETITIVE & O.E.M. INTERCHANGE LIST
Lista de Intercambios contra Competidores y Equipo Original.
Liste dinterchange de produits comptitifs & dquipement original (OEM)

Sterling Truck... cont'd

Sterling truck	Gabriel	Upgrade	Sterling truck	Gabriel	Upgrade	Sterling truck	Gabriel	Upgrade	Sterling truck	Gabriel	Upgrade
F6HT-18045-GC	85030	89440	F6HT18045CC	89439		F6HT18124JC	89402		F6HZ18124D	85055	89439
F6HT-18045-GC	89440		F6HT18045EB	85055	89439	F6HT18124KA	89402		F6HZ18124D	89439	
F6HT-18045-HB	85054		F6HT18045EC	89439		F6HZ-18124-A	85054		F6HZ18124E	85055	89439
F6HT-18045-HC	85054		F6HT18045EC	85055	89439	F6HZ-18124-B	83308		F6HZ18124E	89439	
F6HT-18045-JB	89402		F6HT18045EC	89439		F6HZ-18124-C	85055	89439	F6HZ18124F	85055	89439
F6HT-18045-JC	89402		F6HT18045GB	85030	89440	F6HZ-18124-C	89439		F6HZ18124F	89439	
F6HT-18045-KA	89402		F6HT18045GB	89440		F6HZ-18124-D	85055	89439	F6HZ18124G	85054	
F6HT-18045-LA	85376		F6HT18045GC	85030	89440	F6HZ-18124-D	89439		F6HZ18124H	85054	
F6HT-18080-B	83109		F6HT18045GC	89440		F6HZ-18124-E	85055	89439	F6HZ18124J	89402	
F6HT-18080-CA	85314	89425	F6HT18045HB	85054		F6HZ-18124-E	89439		F6HZ18125B	83109	
F6HT-18080-CA	89425		F6HT18045HC	85054		F6HZ-18124-F	85055	89439	F6HZ18125D	85013	89414
F6HT-18080-DA	83109		F6HT18045JB	89402		F6HZ-18124-F	89439		F6HZ18125D	89414	
F6HT-18080-EA	85906	89407	F6HT18045JC	89402		F6HZ-18124-G	85054		F6HZ5K407AB	83034	
F6HT-18080-EA	89407		F6HT18045KA	89402		F6HZ-18124-H	85054		F81A-18045-AGB	G63809	
F6HT-18080-FC	85013	89414	F6HT18045LA	85376		F6HZ-18124-J	89402		F81A18045AGB	G63809	
F6HT-18080-FC	89414		F6HT18080B	83109		F6HZ-18125-B	83109		XC45-18045-AA	83216	
F6HT-18124-JC	89402		F6HT18080CA	85314	89425	F6HZ-18125-D	85013	89414	XC45-18080-BA	85724	89443
F6HT-18124-KA	89402		F6HT18080CA	89425		F6HZ-18125-D	89414		XC45-18080-BA	89443	
F6HT18045AA	85054		F6HT18080DA	83109		F6HZ-5K407-AB	83034		XC4518045AA	83216	
F6HT18045AC	85054		F6HT18080EA	85906	89407	F6HZ18124A	85054		XC4518080BA	85724	89443
F6HT18045BC	85047	89435	F6HT18080EA	89407		F6HZ18124B	83308		XC4518080BA	89443	
F6HT18045BC	89435		F6HT18080FC	85013	89414	F6HZ18124C	85055	89439			
F6HT18045CC	85055	89439	F6HT18080FC	89414		F6HZ18124C	89439				

Stoughton Trailers Inc.

Stoughton trailers inc.	Gabriel	Upgrade	Stoughton trailers inc.	Gabriel	Upgrade	Stoughton trailers inc.	Gabriel	Upgrade	Stoughton trailers inc.	Gabriel	Upgrade
HTA20001	83389	89436	HTA20002	89436		NW90044448	85051		RT18165-01	85006	
HTA20001	89436		NW90044162	83128	89436	NW90044978	85059		RT1816501	85006	
HTA20002	85000	89436	NW90044162	89436		NW90044979	83113				

Subaru

Subaru	Gabriel	Upgrade	Subaru	Gabriel	Upgrade	Subaru	Gabriel	Upgrade	Subaru	Gabriel	Upgrade
20310 SC062	G52375		20310 SC112	G52374		20360 SA1919L	G52182		20365SC001	G51961	
20310 SC072	G52374		20320 AA100	143492		20365 AE05A	G51767		20365SC021	G51961	
20310 SC102	G52375		20360 SA1819L	G52183		20365 AG14A	G51910		20365SC051	G51961	

Suzuki

Suzuki	Gabriel	Upgrade	Suzuki	Gabriel	Upgrade	Suzuki	Gabriel	Upgrade	Suzuki	Gabriel	Upgrade
88946326	143204										

SYD

Syd	Gabriel	Upgrade	Syd	Gabriel	Upgrade	Syd	Gabriel	Upgrade	Syd	Gabriel	Upgrade
1209005	G51919		1909027	G52314		7000011	70027		7000048	81928	
1209006	G51919		2709080	G52396		7000012	69587		7000049	61600	
1209010	G52250		2709081	G52395		7000018	69945		7000050	61500	
1209011	G52249		2709083	G52280		7000020	81147		7000056	81082	
1209012	G64080		2709084	G52281		7000022	61508		7000057	G63813	
1209013	G52187		4009076	G52352		7000024	61531		7000058	81668	
1209014	G52188		4009077	G52351		7000025	G63608		7000059	81667	
1209015	G51966		4709033	70207		7000026	81730		7000060	81918	
1209016	G52141		5009031	G64104		7000027	81878		7000062	61629	
1209017	G52140		5009032	G52361		7000028	61504		7000064	G63776	
1209018	G64003		5009033	G52360		7000034	G63875		7000064	G63868	
1609006	G51740		5009034	G51972		7000035	81933		7000065	G63678	
1909013	G52164		6709082	G63907		7000036	61691		7000066	G63844	
1909014	G52165		6709120	G51766		7000036	61692		7000067	69900	
1909015	G51881		6709121	G63907		7000039	G63969		7000068	G64026	
1909016	G52297		7000007	70003		7000040	77968				
1909017	G52298		7000008	81934		7000041	G63716				
1909019	G51934		7000009	70056		7000044	81490				
1909026	G52314		7000010	70041		7000045	81713				

Important Note: Competitive Interchanges are to be used for stocking purposes only. Where multiple crosses are identified, please reference the applications section of this catalog. / **Remarque importante:** Les interchanges concurrentiels ne s'utilisent qu'aux fins de stocks. Dans le cas de rferences multiples, consulter la section des applications du catalogue. / **Nota importante:** Dans le cas de rferences multiples, consulter la section des applications du catalogue. / **Nota importante:** Se pueden usar intercambios competitivos para propósitos de almacenamiento solamente. Cuando se identifican intercambios múltiples, consulte la sección de aplicaciones de este catálogo.

COMPETITIVE & O.E.M. INTERCHANGE LIST
Lista de Intercambios contra Competidores y Equipo Original.
Liste d'interchange de produits compititifs & d'equipement original (OEM)

SYD... cont'd

Syd	Gabriel	Upgrade	Syd	Gabriel	Upgrade	Syd	Gabriel	Upgrade	Syd	Gabriel	Upgrade
7000068	G64151		7000173	G63813		7000286	G51738		7000400	82156	
7000073	G51815		7000175	G63873		7000287	G56807		7000403	81541	
7000075	G51268		7000176	G51891		7000288	G51723		7000404	G63937	
7000077	G51700		7000177	G63866		7000291	G55896		7000405	G51077	
7000078	G56672		7000179	G51863		7000292	G52244		7000406	6853SE	
7000079	G56671		7000180	G52118		7000309	G56655		7000407	61699	
7000080	G56622		7000181	G52117		7000310	G56817		7000408	81869	
7000081	G56621		7000182	G56517		7000313	69592		7000410	81926	
7000082	G56606		7000183	G56516		7000313	69593		7000411	G51739	
7000083	G51267		7000184	G52238		7000314	G56722		7000411	G51853	
7000084	G51728		7000185	G52237		7000315	G56721		7000411	G51854	
7000085	G55892		7000191	G52025		7000316	G56728		7000414	81478	
7000086	G56568		7000192	G51859		7000317	G56729		7000415	G63905	
7000087	G56601		7000195	G52143		7000318	G56774		7000417	61700	
7000088	G55948		7000196	G52142		7000319	G56773		7000418	G63915	
7000088	G55949		7000210	G55825		7000320	G56797		7000419	81923	
7000099	G56810		7000212	G55698		7000321	G56798		7000420	G63716	
7000100	70086		7000214	61718		7000324	G56841		7000420	G63809	
7000101	G52006		7000215	61720		7000325	G56840		7000426	G511044	
7000102	G52005		7000218	6804SE		7000326	G64037		7000427	G51990	
7000103	G52007		7000219	6828SE		7000329	G56843		7000433	G52494	
7000104	G52004		7000220	14071		7000330	G56842		7000434	G52495	
7000105	G56887		7000223	70060		7000331	G52155		7000435	G511030	
7000106	G56886		7000224	G52283		7000332	G52154		7000436	G51949	
7000108	G56899		7000225	G52282		7000335	G52104		7000439	G63867	
7000109	G52275		7000227	70045		7000336	G52103		7000443	69590	
7000110	G52274		7000229	70052		7000339	G52108		7000445	G52025	
7000113	G52081		7000233	G63547		7000340	G52107		7000446	G51971	
7000114	G52082		7000234	69465		7000341	G52106		7000452	G51860	
7000115	G52095		7000235	69473		7000342	G52105		7000453	G51861	
7000116	G52094		7000238	82130		7000343	G52300		7000454	G51850	
7000117	G51842		7000239	G63717		7000344	G52299		7000455	G63882	
7000130	G56620		7000241	81076		7000345	G52261		7000456	G63884	
7000134	G55697		7000243	61643		7000346	G52260		7000457	G63879	
7000135	G63679		7000244	G63778		7000350	G52188		7000458	G51718	
7000136	G63890		7000247	G63622		7000351	G52187		7000459	61717	
7000136	G63891		7000248	61646		7000352	G52149		7000460	G52125	
7000151	G51807		7000250	81726		7000353	G52148		7000461	G64040	
7000152	70036		7000258	G63772		7000354	G51848		7000462	G51878	
7000153	G51783		7000259	G51804		7000359	G52256		7000463	G51877	
7000155	69589		7000260	61711		7000360	G52255		7000464	G51892	
7000156	69591		7000261	G511004		7000361	G52128		7000465	G52153	
7000157	69464		7000264	69946		7000361	G64015		7000466	G52152	
7000157	81935		7000265	G51870		7000362	G52127		7000467	G51905	
7000158	81446		7000270	G56838		7000363	G52200		7000475	G56660	
7000160	81495		7000271	G56839		7000364	G52199		7000476	G56661	
7000164	61663		7000272	G52131		7000365	G52174		7000477	G51736	
7000164	81922		7000273	G51838		7000366	G52173		7000478	G52246	
7000164	81925		7000277	G55910		7000367	G64050		7000479	G52245	
7000166	61641		7000278	G51087		7000374	61734		7000480	G51898	
7000166	81920		7000279	G51722		7000375	61715		7000487	G51798	
7000167	81873		7000280	G51724		7000385	G64042		7000487	G52009	
7000167	81921		7000281	G51727		7000386	G51983		7000488	G52008	
7000170	G63929		7000282	G51740		7000393	81318		7000490	G51766	
7000171	G63624		7000283	69586		7000397	6847SE		7000491	G64031	
7000172	G63608		7000285	G51887		7000398	81872		7000493	G64089	

Important Note: Competitive Interchanges are to be used for stocking purposes only. Where multiple crosses are identified, please reference the applications section of this catalog. / **Remarque importante:** Les interchanges concurrentiels ne s'utilisent qu'aux fins de stocks. Dans le cas de rfrences multiples, consulter la section des applications du catalogue. / **Nota importante:** Dans le cas de rfrences multiples, consulter la section des applications du catalogue. / **Nota importante:** Se pueden usar intercambios competitivos para propósitos de almacenamiento solamente. Cuando se identifican intercambios múltiples, consulte la sección de aplicaciones de este catálogo.

COMPETITIVE & O.E.M. INTERCHANGE LIST
Lista de Intercambios contra Competidores y Equipo Original.
Liste dinterchange de produits comptitifs & dquipement original (OEM)

SYD... cont'd

Syd	Gabriel	Upgrade	Syd	Gabriel	Upgrade	Syd	Gabriel	Upgrade	Syd	Gabriel	Upgrade
7000495	G63907		7000548	G511135		7000597	G52351		7000699	G511001	
7000501	G56799		7000554	G52406		7000602	G51874		7000719	G56778	
7000502	G56800		7000555	G52301		7000603	G52121		7000721	G63918	
7000504	G56758		7000556	G51993		7000604	G52122		7000722	G63918	
7000505	G56759		7000557	82001		7000608	G51972		7000745	G64216	
7000506	61704		7000563	G64063		7000609	G511092		7000746	69813	
7000516	G51766		7000567	81904		7000616	81904		7000747	G56582	
7000517	G51842		7000568	70034		7000622	G63889		7000748	G52185	
7000518	G52082		7000569	70059		7000622	G64006		7000749	G52184	
7000519	G52081		7000570	G63860		7000625	G52278		7000750	G51879	
7000520	G52354		7000571	G511007		7000626	G52279		7000753	G63862	
7000521	G52353		7000573	G52112		7000628	G511000		7000753	G64047	
7000522	70095		7000574	G52113		7000638	G51897		7000763	70207	
7000522	70098		7000575	G51858		7000639	G51896		7000764	G52410	
7000522	70208		7000579	G64111		7000647	G511122		7000765	G52411	
7000528	G52171		7000581	G52293		7000651	70010		7000791	G51908	
7000529	G52170		7000582	G52294		7000652	G52525		7000797	G52439	
7000530	G51884		7000583	G51933		7000653	G52524		7000798	G52440	
7000539	G52360		7000584	G64052		7000688	G511038		7000802	G511078	
7000540	G52361		7000586	G52281		7000691	G511142		8709033	G63815	
7000541	G64104		7000587	G52280		7000692	G64148		8709034	G51477	
7000546	G52254		7000588	G51916		7000693	G64121		8709056	G51855	
7000547	G52253		7000589	G52395		7000694	G52209		8709057	G64038	
7000548	G511002		7000590	G52396		7000695	G52210		8709073	G52245	
7000548	G511134		7000596	G52352		7000696	G64056		8709074	G52246	

The Binkley Company

The binkley company	Gabriel	Upgrade	The binkley company	Gabriel	Upgrade	The binkley company	Gabriel	Upgrade	The binkley company	Gabriel	Upgrade
16965	85006		6898	83125							

Thomas

Thomas	Gabriel	Upgrade	Thomas	Gabriel	Upgrade	Thomas	Gabriel	Upgrade	Thomas	Gabriel	Upgrade
00614966	85307		3000614966	85307		61310102	85308	89422	6803260000	83120	
10-13211-000	85918	89449	471700131545	85006		61310102	89422		70445	85014	
10-13211-000	89449		471700131550	85006		61310103	85308	89422	728802	85736	
10-13634-000	85918	89449	60670-006	83147		61310103	89422		87002	85736	
10-13634-000	89449		60670-006L	83147		61310104	85713		8C24-18045-DA	G63622	
1013211000	85918	89449	60670006	83147		61310232	85000	89436	8C24-18080-DB	G63623	
1013211000	89449		60670006L	83147		61310232	89436		8C2Z-18124-D	G63622	
1013634000	85918	89449	60998-001	85006		61310434	85724	89443	8C2Z-18125-D	G63623	
1013634000	89449		60998-003	85006		61310434	89443		90045504	85030	89440
128745	83102		60998001	85006		61310478	85724	89443	90045504	89440	
16-15817-000	85724	89443	60998003	85006		61310478	89443		A-4890	85712	
16-15817-000	89443		6130-0114	89437		614974	85304		A4890	85712	
16-18708-000	85724	89443	61300112	83613		63-0001	85713		ASH-1136	G63623	
16-18708-000	89443		61300219	85014		630001	85713		ASH-1154	G63622	
16-19138-000	85058	89431	61300222	85014		651442	83102		AT-163G	G63622	
16-19138-000	89431		61300223	85014		659287	83102		AT-164G	G63623	
1615817000	85724	89443	61300224	85918	89449	680-323-0300	85006		GBL651442	83102	
1615817000	89443		61300224	89449		680-326-0000	83120		GBL654725	83120	
1618708000	85724	89443	61300240	85918	89449	680010	85304		GBL665538	85006	
1618708000	89443		61300240	89449		680054	85307		TBB128745	83102	
1619138000	85058	89431	61300285	83102		680088	85713				
1619138000	89431		6130029	85712		680102	85712				
300-0614966	85307		61310101	85736		6803230300	85006				

Thor Motor Coach

Thor motor coach	Gabriel	Upgrade	Thor motor coach	Gabriel	Upgrade	Thor motor coach	Gabriel	Upgrade	Thor motor coach	Gabriel	Upgrade
01-205219	85727		10-13976-000	85918	89449						
01205219	85727		10-13976-000	89449							

Important Note: Competitive Interchanges are to be used for stocking purposes only. Where multiple crosses are identified, please reference the applications section of this catalog. / **Remarque importante:** Les interchanges concurrentiels ne s'utilisent qu'aux fins de stocks. Dans le cas de rferences multiples, consulter la section des applications du catalogue. / **Nota importante:** Dans le cas de rferences multiples, consulter la section des applications du catalogue. / **Nota importante:** Se pueden usar intercambios competitivos para propósitos de almacenamiento solamente. Cuando se identifican intercambios múltiples, consulte la sección de aplicaciones de este catálogo.

COMPETITIVE & O.E.M. INTERCHANGE LIST
Lista de Intercambios contra Competidores y Equipo Original.
Liste d'interchange de produits compititifs & d'equipement original (OEM)

Thor Motor Coach... cont'd

Thor motor coach	Gabriel	Upgrade	Thor motor coach	Gabriel	Upgrade	Thor motor coach	Gabriel	Upgrade	Thor motor coach	Gabriel	Upgrade
1013976000	85918	89449	12051142	85340		12L-5-70	85700		1C34-18045-JA	89414	
1013976000	89449		12051146	85340		12L-5-71	85708		1C3418045AA	83209	89414
12-05-1021	85340		12051147	85341		12L-5-72	85709		1C3418045AA	89414	
12-05-1022	85970		12051148	85970		12L-5-88	85729		1C3418045JA	83209	89414
12-05-1023	85341		12051150	85711		12L-5-89	85729		1C3418045JA	89414	
12-05-1101	85340		12051165	85711		12L-5-96	85728		22012067	85700	
12-05-1102	85970		12051166	85341		12L-5-97	85728		22024061	85704	
12-05-1103	85341		12051170	85340		12L-5-98	85339		22045526	85702	
12-05-1137	85340		12051176	85728		12L-5-99	85339		22052014	85702	
12-05-1138	85970		12051177	85729		12L4170	83158		3166657	85700	
12-05-1139	85341		12051178	85339		12L5100	85727		3178157	85700	
12-05-1142	85340		12051179	85727		12L5114	85727		3192333	85700	
12-05-1146	85340		12051188	85970		12L558	85728		481700000490	85900	
12-05-1147	85341		12051194	85339		12L567	85728		481700000493	85900	
12-05-1148	85970		12051199	85729		12L569	85700		63-0127GS	85303	89422
12-05-1150	85711		12051228	85711		12L570	85700		63-0127GS	89422	
12-05-1165	85711		12051242	85728		12L571	85708		630127GS	85303	89422
12-05-1166	85341		12051243	85729		12L572	85709		630127GS	89422	
12-05-1170	85340		12051244	85727		12L588	85729		6314933	85708	
12-05-1176	85728		12051260	85728		12L589	85729		654789	83158	
12-05-1177	85729		12051261	85729		12L596	85728		680232	85733	
12-05-1178	85339		12051262	85727		12L597	85728		680322	85704	
12-05-1179	85727		12051264	85727		12L598	85339		680323	85700	
12-05-1188	85970		12051327	85728		12L599	85339		680333	85708	
12-05-1194	85339		12051328	85729		12T-1-13	85303	89422	680369	85708	
12-05-1199	85729		12051329	85727		12T-1-13	89422		680374	85728	
12-05-1228	85711		12056000	85711		12T113	85303	89422	680441	85729	
12-05-1242	85728		12056001	85740		12T113	89422		680452	85339	
12-05-1243	85729		12056002	85339		12TA-01-013	85303	89422	680462	85728	
12-05-1244	85727		12056033	85339		12TA-01-013	89422		680470	85713	
12-05-1260	85728		12056053	85711		12TA01013	85303	89422	680482	85727	
12-05-1261	85729		12056054	85740		12TA01013	89422		680485	85733	
12-05-1262	85727		12056055	85339		141700131809	85029		680544	85711	
12-05-1264	85727		12056068	85727		141700131810	83160		680546	85339	
12-05-1327	85728		1251G	85700		1497835	85711		680602	85339	
12-05-1328	85729		1251GS	85700		1498200	85740		680677	85728	
12-05-1329	85727		12B-5-1-G	85700		1498565	85339		680680	85729	
12-05-6000	85711		12B-5-1-GS	85700		16-16736-000	85029		680681	85727	
12-05-6001	85740		12B51G	85700		16-16737-000	83160		690029	85700	
12-05-6002	85339		12B51GS	85700		16-16764-000	85724	89443	695125	85704	
12-05-6033	85339		12G-5-1	85700		16-16764-000	89443		85729	85729	
12-05-6053	85711		12G51	85700		16-16873-000	85029		8C24-18045-DA	G63622	
12-05-6054	85740		12J-5-10	85733		16-16874-000	83160		8C24-18080-DB	G63623	
12-05-6055	85339		12J-5-10GS	85733		16-18103-000	85900		8C2418045DA	G63622	
12-05-6068	85727		12J-5-71	85733		1616736000	85029		8C2418080DB	G63623	
12-5-1-G	85700		12J-5-9	85700		1616737000	83160		8C2Z-18124-D	G63622	
12-5-1-GS	85700		12J510	85733		1616764000	85724	89443	8C2Z-18125-D	G63623	
12051021	85340		12J510GS	85733		1616764000	89443		8C2Z18124D	G63622	
12051022	85970		12J571	85733		1616873000	85029		8C2Z18125D	G63623	
12051023	85341		12J59	85700		1616874000	83160		90-2587	85339	
12051101	85340		12L-4-170	83158		1618103000	85900		97-2201-00151	85700	
12051102	85970		12L-5-100	85727		19507669	85340		97-2210-00164	85708	
12051103	85341		12L-5-114	85727		196013	85340		97-9999-02514	85700	
12051137	85340		12L-5-58	85728		1C34-18045-AA	83209	89414	97-9999-02585	85723	
12051138	85970		12L-5-67	85728		1C34-18045-AA	89414		97-9999-02634	85733	
12051139	85341		12L-5-69	85700		1C34-18045-JA	83209	89414	97220100151	85700	

Important Note: Competitive Interchanges are to be used for stocking purposes only. Where multiple crosses are identified, please reference the applications section of this catalog. / **Remarque importante:** Les interchanges concurrentiels ne s'utilisent qu'aux fins de stocks. Dans le cas de références multiples, consulter la section des applications du catalogue. / **Nota importante:** Dans le cas de références multiples, consulter la section des applications du catalogue. / **Nota importante:** Se pueden usar intercambios competitivos para propósitos de almacenamiento solamente. Cuando se identifican intercambios múltiples, consulte la sección de aplicaciones de este catálogo.

COMPETITIVE & O.E.M. INTERCHANGE LIST

Lista de Intercambios contra Competidores y Equipo Original.

Liste d'interchange de produits comptitifs & d'equipement original (OEM)

Thor Motor Coach... cont'd

Thor motor coach	Gabriel	Upgrade	Thor motor coach	Gabriel	Upgrade	Thor motor coach	Gabriel	Upgrade	Thor motor coach	Gabriel	Upgrade
97221000164	85708		ASH-1206	83122	89406	ASH1205	89414		AT164G	G63623	
97999902514	85700		ASH-1206	89406		ASH1206	83122	89406	AT620	83209	89414
97999902585	85723		ASH-1228	83209	89414	ASH1206	89406		AT620	89414	
97999902634	85733		ASH-1228	89414		ASH1228	83209	89414	AT621	83122	89406
9U94-18045-AA	83209	89414	ASH-1229	83209	89414	ASH1228	89414		AT621	89406	
9U94-18045-AA	89414		ASH-1229	89414		ASH1229	83209	89414	AT766	83209	89414
9U94-18080-AA	83122	89406	ASH-1230	83122	89406	ASH1229	89414		AT766	89414	
9U94-18080-AA	89406		ASH-1230	89406		ASH1230	83122	89406	G1011822	85702	
9U9418045AA	83209	89414	ASH-137	83122	89406	ASH1230	89406		G1101590	85713	
9U9418045AA	89414		ASH-137	89406		ASH137	83122	89406	G1101590GS	85713	
9U9418080AA	83122	89406	ASH-25820	85005	89430	ASH137	89406		G1201339	85702	
9U9418080AA	89406		ASH-25820	89430		ASH25820	85005	89430	G5008069	85700	
9U9Z-18124-A	83209	89414	ASH-25821	85006		ASH25820	89430		OE10086S	85702	
9U9Z-18124-A	89414		ASH-25822	83209	89414	ASH25821	85006		OE10881	85711	
9U9Z-18125-A	83122	89406	ASH-25822	89414		ASH25822	83209	89414	OE10882	85740	
9U9Z-18125-A	89406		ASH-25823	83209	89414	ASH25822	89414		OE10883	85339	
9U9Z18124A	83209	89414	ASH-25823	89414		ASH25823	83209	89414	T12-1208	85727	
9U9Z18124A	89414		ASH-25824	83122	89406	ASH25823	89414		T121208	85727	
9U9Z18125A	83122	89406	ASH-25824	89406		ASH25824	83122	89406	T14-1045GS	85700	
9U9Z18125A	89406		ASH-294	83209	89414	ASH25824	89406		T14-1048	85302	89420
ASH-1022	83209	89414	ASH-294	89414		ASH294	83209	89414	T14-1048	89420	
ASH-1022	89414		ASH1022	83209	89414	ASH294	89414		T14-1080	85728	
ASH-1023	83122	89406	ASH1022	89414		AT-163G	G63622		T14-1081	85729	
ASH-1023	89406		ASH1023	83122	89406	AT-164G	G63623		T14-1082	85727	
ASH-1136	G63623		ASH1023	89406		AT-620	83209	89414	T141045GS	85700	
ASH-1154	G63622		ASH1136	G63623		AT-620	89414		T141048	85302	89420
ASH-1161	85006		ASH1154	G63622		AT-621	83122	89406	T141048	89420	
ASH-1162	85005	89430	ASH1161	85006		AT-621	89406		T141080	85728	
ASH-1162	89430		ASH1162	85005	89430	AT-766	83209	89414	T141081	85729	
ASH-1205	83209	89414	ASH1162	89430		AT-766	89414		T141082	85727	
ASH-1205	89414		ASH1205	83209	89414	AT163G	G63622				

Tiffin Motorhomes Inc.

Tiffin motorhomes inc.	Gabriel	Upgrade	Tiffin motorhomes inc.	Gabriel	Upgrade	Tiffin motorhomes inc.	Gabriel	Upgrade	Tiffin motorhomes inc.	Gabriel	Upgrade
10-13976-000	85918	89449	1013976000	89449		1616764000	85724	89443	58913-009L	85959	
10-13976-000	89449		16-16764-000	85724	89443	1616764000	89443		58913009	85959	
1013976000	85918	89449	16-16764-000	89443		58913-009	85959		58913009L	85959	

Tokico

Tokico	Gabriel	Upgrade	Tokico	Gabriel	Upgrade	Tokico	Gabriel	Upgrade	Tokico	Gabriel	Upgrade
2219	G63909		E3816	G63492		E4125	G63775				
2518	G63492		E4124	G63678		E4153	G63775				

Toyota

Toyota	Gabriel	Upgrade	Toyota	Gabriel	Upgrade	Toyota	Gabriel	Upgrade	Toyota	Gabriel	Upgrade
19294294	143094		48510-09S60	G51937		48510-52C31	G57354		48510-8Z254	G57133	
48401-47010	143094		48510-09S61	G51937		48510-80013	G56721		48510-8Z255	G57133	
48510-09A71	G52246		48510-09S70	G51937		48510-80142	G52097		48510-A9280	G57027	
48510-09L81	G57133		48510-09S71	G57453		48510-80294	G57354		48510-A9290	G57027	
48510-09Q50	G57124		48510-09S80	G52246		48510-80307	G51832		48510-A9300	G57027	
48510-09Q63	G57124		48510-09S90	G52246		48510-80480	G52202		48510-A9310	G57027	
48510-09Q70	G57124		48510-09T00	G52246		48510-80497	G51739		48510-A9330	G52014	
48510-09Q90	G57124		48510-09T10	G52246		48510-80498	G57133		48510-A9360	G56731	
48510-09Q92	G57124		48510-09T90	G52246		48510-80516	G57354		48510-A9520	G57027	
48510-09Q93	G51855		48510-09U50	G57133		48510-80528	G52246		48510-A9530	G57027	
48510-09Q94	G57124		48510-1A130	G55591		48510-80563	G52246		48510-A9540	G57027	
48510-09Q95	G57124		48510-1A260	G55591		48510-80637	G52007				
48510-09R10	G57124		48510-49535	G56581		48510-8Z010	G52246				
48510-09R20M	G57124		48510-49655	G56680		48510-8Z162	G57124				
48510-09R30	G57124		48510-49705	G56581		48510-8Z163	G57124				

Important Note: Competitive Interchanges are to be used for stocking purposes only. Where multiple crosses are identified, please reference the applications section of this catalog. / **Remarque importante:** Les interchanges concurrentiels ne s'utilisent qu'aux fins de stocks. Dans le cas de rferences multiples, consulter la section des applications du catalogue. / **Nota importante:** Dans le cas de rferences multiples, consulter la section des applications du catalogue. / **Nota importante:** Se pueden usar intercambios competitivos para propósitos de almacenamiento solamente. Cuando se identifican intercambios múltiples, consulte la sección de aplicaciones de este catálogo.

COMPETITIVE & O.E.M. INTERCHANGE LIST
Lista de Intercambios contra Competidores y Equipo Original.
Liste dinterchange de produits comptitifs & dquipement original (OEM)

Toyota... cont'd

Toyota	Gabriel	Upgrade	Toyota	Gabriel	Upgrade	Toyota	Gabriel	Upgrade	Toyota	Gabriel	Upgrade
48510-A9550	G57027		48520-80020	G52201		48530-09Q40	G64006		48540-09530	G63889	
48510-A9560	G57027		48520-80220	G52201		48530-09Q92	G64006		48540-39465	G56728	
48510-A9580	G57027		48520-80246	G57353		48530-39885	G56729		48540-49215	G56732	
48510-A9590	G57027		48520-80256	G52245		48530-42040	G64026		48540-49245	G56734	
48510-A9690	G52108		48520-80283	G52245		48530-49295	G56735		48540-49295	G56732	
48510-A9700	G52106		48520-80340	G52004		48530-49325	G56733		48540-80004	G52203	
48510-A9840	G52202		48520-A9190	G52013		48530-49415	G56735		48540-A9150	G56734	
48510-B9810	G52202		48520-A9220	G56730		48530-49555	G56733		48540-A9160	G56732	
48510-B9820	G52202		48520-A9370	G52105		48530-49715	G51795		48540-A9370	G52203	
48520-09A71	G52245		48520-A9380	G52107		48530-59446	69450		48540-A9390	G52203	
48520-09F00	G51853		48520-A9530	G52201		48530-80268	G51852		48603-33021	142649	
48520-09L10	G52245		48520-A9580	G52201		48530-80428	G52204		48609-06090	143202	
48520-09L20	G52245		48520-A9590	G52201		48530-80603	G63885		48609-0C030	143339	
48520-09L30	G52245		48530-02630	G51898		48530-80604	G63885		48609-0E010	143202	
48520-09L40	G52245		48530-09895	G64006		48530-A9200	G56735		48609-21030	143406	
48520-09M20	G52245		48530-09896	G64006		48530-A9210	G56733		48609-33011	142561	
48520-09T60	G52245		48530-09M90	G64038		48530-A9720	G52204		48609-33011	142836	
48520-29835	G52096		48530-09N20	G64038		48530-A9740	G52204		48609-33121	142650	
48520-33010	142561		48530-09N40	G64038		48531-09850	G51992		48609-42012	143367	
48520-49615	G56582		48530-09N50	G64038		48531-09880	G511007		48609-52011	143194	
48520-49715	G56679		48530-09N91	G64038		48531-0E060	G64186		48609-52050	143194	
48520-49775	G56582		48530-09N92	G64038		48531-0E110	G64186		48609-63002	142836	
48520-52141	G57353		48530-09N93	G64038		48531-0E132	G64163		48750-0E010	143388	
48520-59365	G57353		48530-09N94	G64038		48531-0R051	G64151		48760-0E010	143387	

Trailmobile Canada Corp.

Trailmobile canada corp.	Gabriel	Upgrade	Trailmobile canada corp.	Gabriel	Upgrade	Trailmobile canada corp.	Gabriel	Upgrade	Trailmobile canada corp.	Gabriel	Upgrade
43-4-235	85051		43-6-164	89407		434277	85000	89436	438014	85013	89414
43-4-236	85029		43-8-002	83209	89414	434277	89436		438014	89414	
43-4-237	85000	89436	43-8-002	89414		434278	85059		438015	85006	
43-4-237	89436		43-8-011	83207	89407	434279	83204		438022	83225	
43-4-239	83207	89407	43-8-011	89407		436028	85000	89436	438031	85029	
43-4-239	89407		43-8-013	85000	89436	436028	89436		90044089	83124	89407
43-4-241	85006		43-8-013	89436		436118	85000	89436	90044089	89407	
43-4-277	85000	89436	43-8-014	85013	89414	436118	89436		90044625	83125	
43-4-277	89436		43-8-014	89414		436137	85006		90044642	83127	
43-4-278	85059		43-8-015	85006		436158	85013	89414	90044978	85059	
43-4-279	83204		43-8-022	83225		436158	89414		90044979	83113	
43-6-028	85000	89436	43-8-031	85029		436164	83207	89407	90044992	85000	89436
43-6-028	89436		434235	85051		436164	89407		90044992	89436	
43-6-118	85000	89436	434236	85029		438002	83209	89414	90045054	85051	
43-6-118	89436		434237	85000	89436	438002	89414		A-2212	85029	
43-6-137	85006		434237	89436		438011	83207	89407	A2212	85029	
43-6-158	85013	89414	434239	83207	89407	438011	89407				
43-6-158	89414		434239	89407		438013	85000	89436			
43-6-164	83207	89407	434241	85006		438013	89436				

Transportation Mfg. Corp.

Transportation mfg. corp.	Gabriel	Upgrade	Transportation mfg. corp.	Gabriel	Upgrade	Transportation mfg. corp.	Gabriel	Upgrade	Transportation mfg. corp.	Gabriel	Upgrade
12-05-6000	85711		12J-5-9	85700		12T-1-13	85303	89422	1498358	85339	
12-05-6002	85339		12J510	85733		12T-1-13	89422		1509681	85339	
12-05-6033	85339		12J59	85700		12T113	85303	89422	22045526	85702	
12056000	85711		12L-5-69	85700		12T113	89422		22052014	85702	
12056002	85339		12L-5-70	85700		12TA-01-13	85303	89422	680349	85702	
12056033	85339		12L-5-99	85339		12TA-01-13	89422		680470	85713	
12G-5-1	85700		12L569	85700		12TA0113	85303	89422	G1011822	85702	
12G51	85700		12L570	85700		12TA0113	89422		G1101590	85713	
12J-5-10	85733		12L599	85339		1497628	85711				

Important Note: Competitive Interchanges are to be used for stocking purposes only. Where multiple crosses are identified, please reference the applications section of this catalog. / **Remarque importante:** Les interchanges concurrentiels ne s'utilisent qu'aux fins de stocks. Dans le cas de rfrences multiples, consulter la section des applications du catalogue. / **Nota importante:** Dans le cas de rfrences multiples, consulter la section des applications du catalogue. / **Nota importante:** Se pueden usar intercambios competitivos para propósitos de almacenamiento solamente. Cuando se identifican intercambios múltiples, consulte la sección de aplicaciones de este catálogo.

COMPETITIVE & O.E.M. INTERCHANGE LIST
Lista de Intercambios contra Competidores y Equipo Original.
Liste dinterchange de produits comptitifs & dquipement original (OEM)

Transportation Mfg. Corp.... cont'd

TRIANGLE GROUP

Triangle group	Gabriel	Upgrade	Triangle group	Gabriel	Upgrade	Triangle group	Gabriel	Upgrade	Triangle group	Gabriel	Upgrade
F65101	85062	89408	F65400	85033	89427	F65495	85067	89451	F65528	85069	89455

TRP

Trp	Gabriel	Upgrade	Trp	Gabriel	Upgrade	Trp	Gabriel	Upgrade	Trp	Gabriel	Upgrade
89402GSK	89402		89440GSK	89440		HS 85005	89430		HS 85320	85320	89429
89405GSK	89405		89442GSK	89442		HS 85006	85006		HS 85320	89429	
89406GSK	89406		89443GSK	89443		HS 85012	85012	89413	HS 85323	85323	89436
89407GSK	89407		89448GSK	89448		HS 85012	89413		HS 85323	89436	
89408GSK	89408		89449GSK	89449		HS 85029	85029		HS 85724	85724	89443
89409GSK	89409		89450GSK	89450		HS 85033	85033	89427	HS 85724	89443	
89410GSK	89410		89451GSK	89451		HS 85033	89427		HS 85738	85738	
89411GSK	89411		89456GSK	89456		HS 85047	85047	89435	HS 85900	85900	
89413GSK	89413		89459GSK	89459		HS 85047	89435		HS 85918	85918	89449
89414GSK	89414		HS 646155	646155		HS 85052	85052		HS 85918	89449	
89415GSK	89415		HS 727603	83203	89436	HS 85058	85058	89431	HS 85919	85919	
89419GSK	89419		HS 727603	89436		HS 85058	89431		HS 85920	85920	89503
89420GSK	89420		HS 727607	83207	89407	HS 85061	85061	89450	HS 85920	89503	
89422GSK	89422		HS 727607	89407		HS 85062	85062	89408	HS 85924	85924	89457
89423GSK	89423		HS 83008	83008		HS 85062	89408		HS 85924	89457	
89424GSK	89424		HS 83009	83009		HS 85066	85066	89448	HS 85931	85931	89458
89426GSK	89426		HS 83038	83038		HS 85066	89448		HS 85931	89458	
89427GSK	89427		HS 83125	83125		HS 85067	85067	89451	HS 85933	85933	89454
89428GSK	89428		HS 83128	83128	89436	HS 85067	89451		HS 85933	89454	
89429GSK	89429		HS 83128	89436		HS 85069	85069	89455	HS 85934	85934	
89430GSK	89430		HS 83147	83147		HS 85069	89455		HS 85936	85936	89456
89431GSK	89431		HS 85000	85000	89436	HS 85070	85070	89459	HS 85936	89456	
89432GSK	89432		HS 85000	89436		HS 85070	89459		HS 85938	85938	
89434GSK	89434		HS 85001	85001	89410	HS 85088	85088		HS 85954	85954	
89435GSK	89435		HS 85001	89410		HS 85310	85310	89423	HS 85958	85958	
89436GSK	89436		HS 85003	85003	89411	HS 85310	89423				
89437GSK	89437		HS 85003	89411		HS 85311	85311	89424			
89439GSK	89439		HS 85005	85005	89430	HS 85311	89424				

Truckmaster

Truckmaster	Gabriel	Upgrade	Truckmaster	Gabriel	Upgrade	Truckmaster	Gabriel	Upgrade	Truckmaster	Gabriel	Upgrade
665632	85013	89414	665930	89410		680240	89420		680303	85007	
665632	89414		665931	83312	89409	680241	85311	89424	680348	85012	89413
665633	85033	89427	665931	89409		680241	89424		680348	89413	
665633	89427		665932	85012	89413	680242	85308	89422	680385	85311	89424
665783	83123	89405	665932	89413		680242	89422		680385	89424	
665783	89405		665950	85902		680243	85001	89410	680425	85320	89429
665784	83122	89406	671052	85070	89459	680243	89410		680425	89429	
665784	89406		671052	89459		680253	85314	89425	680435	85033	89427
665785	83137		671654	85936	89456	680253	89425		680435	89427	
665844	85069	89455	671654	89456		680261	85062	89408	680473	85319	89428
665844	89455		671699	85937		680261	89408		680473	89428	
665918	85900		671794	85067	89451	680279	83209	89414	680586	85311	89424
665926	85047	89435	671794	89451		680279	89414		680586	89424	
665926	89435		680237	85303	89422	680280	85906	89407	680601	85012	89413
665927	85901		680237	89422		680280	89407		680601	89413	
665928	85062	89408	680239	85310	89423	680281	85003	89411			
665928	89408		680239	89423		680281	89411				
665930	85001	89410	680240	85302	89420	680283	85740				

TRW

Trw	Gabriel	Upgrade	Trw	Gabriel	Upgrade	Trw	Gabriel	Upgrade	Trw	Gabriel	Upgrade
JGA4002S	G56927		JGA4011SL	G56956							
JGA4006S	G56935		JGA4011SR	G56957							

Important Note: Competitive Interchanges are to be used for stocking purposes only. Where multiple crosses are identified, please reference the applications section of this catalog. / **Remarque importante:** Les interchanges concurrentiels ne s'utilisent qu'aux fins de stocks. Dans le cas de références multiples, consulter la section des applications du catalogue. / **Nota importante:** Dans le cas de referencias multiples, consultar la sección de aplicaciones del catálogo. / **Nota importante:** Se pueden usar intercambios competitivos para propósitos de almacenamiento solamente. Cuando se identifican intercambios múltiples, consulte la sección de aplicaciones de este catálogo.

COMPETITIVE & O.E.M. INTERCHANGE LIST
Lista de Intercambios contra Competidores y Equipo Original.
Liste dinterchange de produits comptitifs & equipement original (OEM)

TRW... cont'd

Trw	Gabriel	Upgrade	Trw	Gabriel	Upgrade	Trw	Gabriel	Upgrade	Trw	Gabriel	Upgrade
JGA4014S	G56998		JGM4155SR	G55999		JGM4291SR	G56729		JGM4378S	G55856	
JGA4015SL	G56996		JGM4157SL	G55661		JGM4292S	G56620		JGM4379SL	G52297	
JGA4015SR	G56997		JGM4157SR	G55662		JGM4293SL	G56728		JGM4383SL	G56800	
JGA4021SL	G56948		JGM4159SL	G55591		JGM4293SR	G56729		JGM4383SR	G56799	
JGA4021SR	G56948		JGM4159SR	G55591		JGM4296S	G55698		JGM4389SL	G56582	
JGA4023SL	G56949		JGM4163SL	G52164		JGM4297SL	G56601		JGM4389SR	G56581	
JGA4023SR	G56950		JGM4163SR	G52165		JGM4297SR	G56568		JGM4395SL	G52299	
JGA4030S	G57178		JGM4165SL	G52144		JGM4300S	G52025		JGM4395SR	G52300	
JGA4031SL	G57176		JGM4165SR	G52145		JGM4303SL	G52017		JGM4405SL	G52156	
JGA4031SR	G57177		JGM4167SL	G55911		JGM4303SR	G52018		JGM4405SR	G52157	
JGA4036S	G56991		JGM4167SR	G55911		JGM4304S	G56899		JGM4406S	G51911	
JGA4036S	G56992		JGM4171SL	G52237		JGM4305SL	G56892		JGM4407SL	G52173	
JGA4040S	G56943		JGM4171SR	G52238		JGM4305SR	G56893		JGM4407SR	G52174	
JGA4044S	G57054		JGM4175SL	G52237		JGM4306S	G56899		JGM4412S	G52131	
JGA4044S	G57055		JGM4175SR	G52238		JGM4308S	G52276		JGM4415SL	G52335	
JGA4046S	G57056		JGM4185SL	G52314		JGM4313SL	G56679		JGM4415SR	G52336	
JGA4047SL	G57114		JGM4185SR	G52314		JGM4313SR	G56680		JGM4416S	G55949	
JGA4047SR	G57115		JGM4193SL	G56615		JGM4316S	G51718		JGM4420S	G56509	
JGC4092S	G44461		JGM4193SR	G56616		JGM4318S	G56899		JGM4422S	G51898	
JGC4094S	G44461		JGM4195SL	G52199		JGM4321SL	G56732		JGM4423SL	G56842	
JGM4001SL	G55774		JGM4195SR	G52200		JGM4321SR	G56733		JGM4423SR	G56843	
JGM4001SR	G55774		JGM4197SL	G52274		JGM4325SL	G52081		JGM4424S	G51864	
JGM4007SL	G56506		JGM4197SR	G52275		JGM4325SR	G52082		JGM4425SL	G56886	
JGM4007SR	G56514		JGM4199SL	G52142		JGM4329SL	G56661		JGM4425SR	G56887	
JGM4017SL	G56809		JGM4199SR	G52143		JGM4329SR	G56660		JGM4426S	G51980	
JGM4017SR	G56809		JGM4201SL	G56728		JGM4332S	G56899		JGM4427SL	G52004	
JGM4040S	G56655		JGM4201SR	G56729		JGM4335SL	G52175		JGM4427SR	G52007	
JGM4042S	G56817		JGM4209SL	G52142		JGM4335SR	G52176		JGM4431SL	G52439	
JGM4057SL	G56640		JGM4209SR	G52143		JGM4339SL	G52094		JGM4431SR	G52440	
JGM4057SR	G56641		JGM4234S	G56565		JGM4339SR	G52095		JGM4432S	70013	
JGM4069SL	G56621		JGM4235SL	G56687		JGM4341SL	G52121		JGM4433SL	G56819	
JGM4069SR	G56622		JGM4235SR	G56688		JGM4341SR	G52122		JGM4433SR	G56820	
JGM4071SL	G56730		JGM4236S	G56571		JGM4343SL	G52142		JGM4434S	G51806	
JGM4071SR	G56731		JGM4237SL	G56687		JGM4343SR	G52143		JGM4435SL	G56822	
JGM4073SL	G56734		JGM4237SR	G56688		JGM4345SL	G56506		JGM4435SR	G56821	
JGM4073SR	G56735		JGM4242S	G56899		JGM4345SR	G56514		JGM4437SL	G56810	
JGM4089SL	G56636		JGM4244S	G51714		JGM4347SL	G55675		JGM4437SR	G56810	
JGM4089SR	G56635		JGM4245SL	G56759		JGM4347SR	G55676		JGM4439SL	G52162	
JGM4090S	G55681		JGM4245SR	G56758		JGM4355SL	G52184		JGM4439SR	G52163	
JGM4091SL	G52013		JGM4246S	G52098		JGM4355SR	G52185		JGM4442S	G51765	
JGM4091SR	G52014		JGM4253SL	G56671		JGM4357SL	G52154		JGM4444S	70013	
JGM4092S	G55697		JGM4253SR	G56672		JGM4357SR	G52155		JGM4445SL	G52382	
JGM4093SL	G52168		JGM4259SL	G52008		JGM4359SL	G52257		JGM4445SR	G52383	
JGM4093SR	G52169		JGM4259SR	G52009		JGM4359SR	G52258		JGM4447SL	G56773	
JGM4114S	G55772		JGM4264S	G56778		JGM4360S	G56899		JGM4447SR	G56774	
JGM4126S	G51267		JGM4271SL	G52107		JGM4361SL	G52160		JGM4448S	G51833	
JGM4128S	G55820		JGM4271SL	G56797		JGM4361SR	G52161		JGM4449SL	G56562	
JGM4129SL	G56516		JGM4271SR	G52108		JGM4362S	G56894		JGM4449SR	G56561	
JGM4129SR	G56517		JGM4271SR	G56798		JGM4365SL	G56634		JGM4450S	G51933	
JGM4132S	G55901		JGM4280S	G56899		JGM4365SR	G56633		JGM4452S	G51898	
JGM4134S	G56701		JGM4283SL	G56539		JGM4368S	G52295		JGM4453SL	G52148	
JGM4139SL	G56615		JGM4283SR	G56540		JGM4369SL	G56840		JGM4453SR	G52149	
JGM4139SR	G56616		JGM4286S	G56791		JGM4369SR	G56841		JGM4454S	70013	
JGM4148S	G55896		JGM4287SL	G52110		JGM4371SL	G56538		JGM4455SL	G52117	
JGM4150S	G51268		JGM4287SR	G52111		JGM4371SR	G56537		JGM4455SR	G52118	
JGM4155SL	G55999		JGM4291SL	G56728		JGM4376SR	G52298		JGM4456S	69898	

Important Note: Competitive Interchanges are to be used for stocking purposes only. Where multiple crosses are identified, please reference the applications section of this catalog. / **Remarque importante:** Les interchanges concurrentiels ne s'utilisent qu'aux fins de stocks. Dans le cas de références multiples, consulter la section des applications du catalogue. / **Nota importante:** Dans le cas de referencias multiples, consultar la sección des aplicaciones du catalogue. / **Nota importante:** Se pueden usar intercambios competitivos para propósitos de almacenamiento solamente. Cuando se identifican intercambios múltiples, consulte la sección de aplicaciones de este catálogo.

COMPETITIVE & O.E.M. INTERCHANGE LIST
Lista de Intercambios contra Competidores y Equipo Original.
Liste dinterchange de produits comptitifs & dquipement original (OEM)

TRW... cont'd

Trw	Gabriel	Upgrade	Trw	Gabriel	Upgrade	Trw	Gabriel	Upgrade	Trw	Gabriel	Upgrade
JGM4457SL	G51910		JGM4595SR	G52153		JGS4014S	G51703		JGT4020S	G63721	
JGM4461SL	G52253		JGM4597SL	G52032		JGS4020S	G55825		JGT4022S	G63454	
JGM4461SR	G52254		JGM4597SR	G52033		JGS4058S	G51736		JGT4024S	G63461	
JGM4462S	G56792		JGM4601SL	G52209		JGS4084S	G51742		JGT4026S	G63607	
JGM4464S	G56802		JGM4601SR	G52210		JGS4100S	G51841		JGT4028S	G63608	
JGM4466S	G56802		JGM4603SL	G52260		JGS4126S	G51722		JGT4028S	G63614	
JGM4469SL	G52182		JGM4603SR	G52261		JGS4148S	G51881		JGT4030S	G63614	
JGM4469SR	G52183		JGM4607SL	G52282		JGS4152S	G56591		JGT4031SL	G51961	
JGM4479SR	G56886		JGM4607SR	G52283		JGS4154S	G51087		JGT4031SR	G52374	
JGM4491SL	G52129		JGM4609SL	G52293		JGS4156S	G63678		JGT4032S	G63609	
JGM4491SR	G52130		JGM4609SR	G52294		JGS4156S	G63775		JGT4032S	G63818	
JGM4497SL	G52103		JGM4611SL	G51925		JGS4158S	G51900		JGT4034S	G63907	
JGM4497SR	G52104		JGM4611SR	G51926		JGS4168S	G51841		JGT4038S	69600	
JGM4501SL	G52127		JGM4613SL	G52150		JGS4174S	70040		JGT4042S	69675	
JGM4501SR	G52128		JGM4613SR	G52151		JGS4176S	70040		JGT4044S	69676	
JGM4503SL	G56836		JGM4617SL	G52026		JGS4192S	G51723		JGT4058S	G63350	
JGM4503SR	G56837		JGM4617SR	G52027		JGS4194S	G56807		JGT4060S	G63353	
JGM4507SL	G52203		JGM4625SL	G51853		JGS4196S	G51715		JGT4062S	G63360	
JGM4507SR	G52204		JGM4625SR	G51854		JGS4206S	G64006		JGT4066S	G63377	
JGM4509SL	G52201		JGM4629SL	G56721		JGS4208S	G64009		JGT4068S	G63387	
JGM4509SR	G52202		JGM4629SR	G56722		JGS4208S	G64011		JGT4074S	G63409	
JGM4513SL	G52187		JGM4657SL	G52005		JGS4210S	G51841		JGT4078S	G63418	
JGM4513SR	G52188		JGM4657SR	G52006		JGS4214S	70036		JGT4080S	G63524	
JGM4515SL	G51877		JGM4661SL	G52274		JGS4222S	G51850		JGT4082S	G63455	
JGM4515SR	G51878		JGM4661SR	G52275		JGS4226S	G51870		JGT4088S	G63490	
JGM4517SL	G52247		JGM4671SL	G55993		JGS4230S	G51848		JGT4090S	G63492	
JGM4517SR	G52248		JGM4671SR	G55994		JGS4232S	G51863		JGT4090S	G63928	
JGM4519SL	G52103		JGM4672S	G56606		JGS4234S	G51815		JGT4094S	G63915	
JGM4519SR	G52104		JGM4673SL	G52112		JGS4236S	G51799		JGT4096S	G63950	
JGM4521SL	G52156		JGM4673SR	G52113		JGS4244S	G51097		JGT4098S	69625	
JGM4521SR	G52157		JGM4685SL	G52187		JGS4252S	G51740		JGT4106S	81270	
JGM4523SL	G52249		JGM4685SR	G52188		JGS4316S	G51766		JGT4116S	G63867	
JGM4523SR	G52250		JGM4687SL	G56800		JGS4362S	G51815		JGT4116S	G64157	
JGM4525SL	G52140		JGM4687SR	G56799		JGS4406S	G51865		JGT4118S	G63870	
JGM4525SR	G52141		JGM4751SR	G52202		JGT4000S	G51888		JGT4120S	69574	
JGM4533SL	G52331		JGM4821SL	G52255		JGT4002S	G51887		JGT4122S	69575	
JGM4533SR	G52332		JGM4821SR	G52256		JGT4003SL	G51761		JGT4124S	G63878	
JGM4535SL	G52096		JGM4861SL	G52245		JGT4003SR	G51760		JGT4128S	G51724	
JGM4535SR	G52097		JGM4861SR	G52246		JGT4005SL	G51813		JGT4138S	82156	
JGM4537SL	G52158		JGM9086SL	G52008		JGT4005SR	G51814		JGT4142S	69845	
JGM4537SR	G52159		JGM9086SR	G52009		JGT4006S	G63357		JGT4144S	69898	
JGM4539SL	G52264		JGM9134SL	G56732		JGT4007SL	G511054		JGT4152S	G63443	
JGM4539SR	G52265		JGM9134SR	G56733		JGT4007SR	G511055		JGT4156S	G63671	
JGM4551SL	G52245		JGM9300SL	G56601		JGT4008S	G63375		JGT4156S	G63678	
JGM4551SR	G52246		JGM9300SR	G56568		JGT4008S	G63894		JGT4158S	G63411	
JGM4569SL	G52127		JGM9901SL	G56842		JGT4009SL	G51859		JGT4162S	G63524	
JGM4569SR	G52128		JGM9901SR	G56843		JGT4009SL	G51896		JGT4168S	G63623	
JGM4571SL	G52439		JGP4006S	G63783		JGT4009SR	G51859		JGT4170S	G63638	
JGM4571SR	G52440		JGP4014S	G51891		JGT4009SR	G51897		JGT4170S	G63896	
JGM4585SL	G52105		JGP4018S	G51891		JGT4010S	G63386		JGT4172S	G63717	
JGM4585SR	G52106		JGP4020S	G63866		JGT4014S	G63421		JGT4174S	G63722	
JGM4589SL	G56679		JGP4024S	G63866		JGT4015SL	G52348		JGT4188S	69473	
JGM4589SR	G56680		JGP4458S	G63803		JGT4015SR	G52349		JGT4192S	82090	
JGM4593SL	G52329		JGS4000S	G51759		JGT4016S	G63422		JGT4194S	G63837	
JGM4593SR	G52330		JGS4003S	G51934		JGT4018S	G63423		JGT4214S	G63848	
JGM4595SL	G52152		JGS4012S	G51704		JGT4020S	G63424		JGT4216S	G63882	

Important Note: Competitive Interchanges are to be used for stocking purposes only. Where multiple crosses are identified, please reference the applications section of this catalog. / **Remarque importante:** Les interchanges concurrentiels ne s'utilisent qu'aux fins de stocks. Dans le cas de références multiples, consulter la section des applications du catalogue. / **Nota importante:** Dans le cas de referencias multiples, consultar la sección de aplicaciones del catálogo. / **Nota importante:** Se pueden usar intercambios competitivos para propósitos de almacenamiento solamente. Cuando se identifican intercambios múltiples, consulte la sección de aplicaciones de este catálogo.

COMPETITIVE & O.E.M. INTERCHANGE LIST
Lista de Intercambios contra Competidores y Equipo Original.
Liste d'interchange de produits compititifs & d'equipement original (OEM)

TRW... cont'd

Trw	Gabriel	Upgrade	Trw	Gabriel	Upgrade	Trw	Gabriel	Upgrade	Trw	Gabriel	Upgrade
JGT4220S	G63773		JGT4420S	G63714		JGT4534S	70000		JGT4730S	G63620	
JGT4222S	G63775		JGT4422S	G63716		JGT4538S	G51883		JGT4736S	G63904	
JGT4224S	69962		JGT4424S	G63679		JGT4542S	G51727		JGT4736S	G63909	
JGT4228S	G63810		JGT4426S	G63414		JGT4544S	G51798		JGT4738S	G63495	
JGT4234S	69590		JGT4428S	G63778		JGT4546S	G51767		JGT4738S	G63611	
JGT4238S	G63962		JGT4430S	G63614		JGT4548S	G51739		JGT4740S	69715	
JGT4240S	G63810		JGT4430S	G63622		JGT4550S	G63885		JGT4744S	69587	
JGT4242S	G63808		JGT4432S	G63809		JGT4550S	G64029		JGT4746S	69589	
JGT4244S	G64087		JGT4434S	69606		JGT4550S	G64030		JGT4748S	G63890	
JGT4252S	G63494		JGT4436S	G63715		JGT4552S	G51804		JGT4748S	G63891	
JGT4254S	G63404		JGT4438S	81916		JGT4556S	81318		JGT4754S	G51928	
JGT4266S	G63548		JGT4440S	G63525		JGT4560S	G51721		JGT4756S	G64032	
JGT4272S	G63616		JGT4442S	G63676		JGT4576S	69900		JGT4762S	69464	
JGT4274S	G63903		JGT4442S	G63873		JGT4578S	G51799		JGT4766S	70013	
JGT4282S	G63782		JGT4442S	G64042		JGT4580S	G51799		JGT4770S	G51783	
JGT4284S	G63707		JGT4444S	G63776		JGT4590S	G63847		JGT4772S	G64026	
JGT4286S	G63708		JGT4444S	G63869		JGT4592S	G63829		JGT4776S	70102	
JGT4288S	G63726		JGT4446S	G63489		JGT4594S	69586		JGT4782S	G63872	
JGT4294S	G63813		JGT4448S	G63488		JGT4596S	69586		JGT4782S	G64015	
JGT4300S	G63864		JGT4450S	G63783		JGT4606S	G51795		JGT4782S	G64140	
JGT4302S	G51716		JGT4452S	G63355		JGT4608S	G51812		JGT4784S	70052	
JGT4306S	G63815		JGT4452S	G63366		JGT4610S	G51842		JGT4788S	G51908	
JGT4308S	G63815		JGT4454S	G63349		JGT4622S	G63610		JGT4790S	G51807	
JGT4318S	70001		JGT4456S	G63662		JGT4632S	70027		JGT4792S	70089	
JGT4322S	G51802		JGT4456S	G63675		JGT4634S	70089		JGT4796S	69907	
JGT4324S	70028		JGT4456S	G63959		JGT4636S	G51993		JGT4798S	G63967	
JGT4328S	G51838		JGT4458S	G63893		JGT4640S	69592		JGT4814S	G51855	
JGT4332S	G63845		JGT4460S	G63813		JGT4640S	69593		JGT4816S	G64038	
JGT4334S	G51849		JGT4462S	G63299		JGT4642S	G64012		JGT4818S	G51858	
JGT4344S	69901		JGT4464S	69945		JGT4656S	70003		JGT4820S	70010	
JGT4362S	G51097		JGT4466S	69813		JGT4658S	G63884		JGT4824S	G51919	
JGT4366S	69903		JGT4468S	70034		JGT4660S	G63879		JGT4826S	G51860	
JGT4368S	69903		JGT4472S	G63712		JGT4662S	G63875		JGT4828S	G51861	
JGT4372S	G63799		JGT4474S	G51799		JGT4664S	69587		JGT4834S	G64104	
JGT4374S	69465		JGT4478S	G51799		JGT4666S	G64071		JGT4840S	G51983	
JGT4376S	69450		JGT4480S	69604		JGT4668S	70078		JGT4842S	G51983	
JGT4380S	G64028		JGT4480S	69724		JGT4670S	69946		JGT4846S	G64042	
JGT4382S	G63832		JGT4482S	G63958		JGT4672S	G63889		JGT4850S	G511044	
JGT4384S	G63828		JGT4482S	G64043		JGT4672S	G64006		JGT4852S	G51874	
JGT4386S	G63860		JGT4484S	G63961		JGT4674S	70056		JGT4854S	G51892	
JGT4388S	G64027		JGT4486S	G51728		JGT4682S	G64033		JGT4856S	G64008	
JGT4394S	69946		JGT4488S	G63844		JGT4688S	69591		JGT4858S	G64040	
JGT4396S	69946		JGT4490S	G63817		JGT4690S	G51794		JGT4860S	G52125	
JGT4400S	G63413		JGT4492S	G64046		JGT4694S	G511004		JGT4864S	G52116	
JGT4402S	G63905		JGT4494S	G63720		JGT4696S	70041		JGT4866S	G64080	
JGT4404S	G63661		JGT4496S	G51799		JGT4698S	G63883		JGT4868S	G64003	
JGT4406S	G63359		JGT4500S	G64049		JGT4700S	70098		JGT4870S	G51884	
JGT4408S	G63424		JGT4502S	70045		JGT4704S	G64050		JGT4872S	70053	
JGT4410S	G63683		JGT4504S	70045		JGT4708S	69714		JGT4874S	G64048	
JGT4412S	G63425		JGT4508S	70039		JGT4710S	69795		JGT4876S	G51852	
JGT4414S	G63866		JGT4514S	69909		JGT4712S	69811		JGT4880S	G63888	
JGT4416S	G63426		JGT4516S	69585		JGT4720S	69622		JGT4882S	G64111	
JGT4416S	G63690		JGT4518S	G63717		JGT4722S	69755		JGT4886S	G52375	
JGT4418S	G63614		JGT4520S	G63714		JGT4724S	G63673		JGT4888S	G51832	
JGT4418S	G63622		JGT4530S	G63842		JGT4726S	G63710		JGT4890S	G51880	
JGT4418S	G63929		JGT4532S	G51738		JGT4728S	G63937		JGT4894S	G511092	

Important Note: Competitive Interchanges are to be used for stocking purposes only. Where multiple crosses are identified, please reference the applications section of this catalog. / **Remarque importante:** Les interchanges concurrentiels ne s'utilisent qu'aux fins de stocks. Dans le cas de rferences multiples, consulter la section des applications du catalogue. / **Nota importante:** Dans le cas de rferences multiples, consultar la section des applications du catalogue. / **Nota importante:** Se pueden usar intercambios competitivos para propósitos de almacenamiento solamente. Cuando se identifican intercambios múltiples, consulte la sección de aplicaciones de este catálogo.

COMPETITIVE & O.E.M. INTERCHANGE LIST
Lista de Intercambios contra Competidores y Equipo Original.
Liste dinterchange de produits comptitifs & dquipement original (OEM)

TRW... cont'd

Trw	Gabriel	Upgrade	Trw	Gabriel	Upgrade	Trw	Gabriel	Upgrade	Trw	Gabriel	Upgrade
JGT4896S	G511092		JGT5078S	81873		JOT5310S	G63845		JSB4720S	142828	
JGT4898S	G51865		JGT5084S	81318		JOT5318S	G64016		JSB4726S	143197	
JGT4900S	G64079		JGT5086S	G63403		JOT5320S	G63892		JSB4728S	143325	
JGT4906S	70068		JGT5088S	81490		JOT5324S	77425		JSB4734S	142561	
JGT4914S	G51805		JGT5090S	81920		JOT5328S	77829		JSB4736S	142836	
JGT4918S	70013		JGT5092S	G63847		JOT5336S	70024		JSB4772S	143244	
JGT4920S	G63886		JGT5094S	81912		JOT5390S	70033		JSB4782S	142932	
JGT4920S	G63969		JGT5096S	G63772		JSB4008S	142135		JSB4784S	143256	
JGT4922S	G51905		JGT5098S	G63424		JSB4009SL	143465		JSB4790S	143087	
JGT4926S	G64121		JGT5100S	G63803		JSB4009SR	143466		JSB4810S	143244	
JGT4928S	G51803		JGT5102S	81514		JSB4021SL	143387		JSB4876S	143349	
JGT4930S	G51812		JGT5406S	G63624		JSB4021SR	143388		JSB4940S	G51715	
JGT4932S	G64056		JGT5412S	70068		JSB4027SL	143390		JSK4002T	143057	
JGT4936S	70060		JGT5416S	G51972		JSB4027SR	143391		JSK4004T	143058	
JGT4938S	70096		JGT5418S	G64031		JSB4030S	142444		JSK4092T	143059	
JGT4942S	69595		JGT5430S	70010		JSB4031SL	143461		JSK4096T	143061	
JGT4944S	69594		JGT5432S	G64003		JSB4031SR	143462		JSK4100T	143063	
JGT4950S	G51990		JGT5440S	69625		JSB4036S	142651		JSK4210T	143064	
JGT4964S	69945		JGT5442S	G63915		JSB4056S	143191		JSL4007SL	142650	
JGT4966S	69945		JGT5444S	G63872		JSB4094S	143281		JSL4007SR	142649	
JGT4972S	69946		JGT5460S	70052		JSB4116S	143082		JSL4023SL	143354	
JGT4980S	69863		JGT5562S	G64056		JSB4118S	142653		JSL4023SR	143355	
JGT4982S	81559		JGT5572S	G64012		JSB4126S	143404		JSL4136S	142651	
JGT4984S	G63929		JGT5574S	82155		JSB4146S	142625		JSL4144S	142930	
JGT4986S	81446		JGT5578S	G63461		JSB4148S	143204		JSL4214S	143353	
JGT4988S	81750		JGT5612S	G63722		JSB4158S	143367		JSL4216S	142937	
JGT4990S	81494		JGT5628S	G51805		JSB4162S	143492		JSL4220S	143202	
JGT4994S	G63675		JGT5632S	G64104		JSB4166S	143201		JSL4232S	142252	
JGT4998S	G63829		JGT5924S	G64026		JSB4206S	143087		JSL4248S	143239	
JGT5000S	81937		JGT5982S	G63867		JSB4236S	143191		JSL4270S	143218	
JGT5006S	69675		JGT5984S	G63867		JSB4266S	142419		JSL4300S	143323	
JGT5008S	81892		JGT5994S	G63403		JSB4276S	143418		JSL4322S	143398	
JGT5014S	G63479		JGT6032S	G63902		JSB4288S	143491		JSL4336S	143089	
JGT5014S	G63547		JGT6038S	G63662		JSB4290S	142195		JSL4418S	143365	
JGT5016S	81871		JGT6052S	82156		JSB4292S	143365		JSL4422S	143495	
JGT5018S	G63638		JGT6056S	G63907		JSB4298S	143317		JSL4428S	142930	
JGT5020S	81928		JGT6060S	G63492		JSB4314S	143416		JSL4438S	143363	
JGT5022S	81878		JGT9038S	G51804		JSB4316S	143419		JSL4442S	143460	
JGT5024S	G63405		JGT9042S	G51798		JSB4326S	143455		JSL4516S	143409	
JGT5026S	81516		JGT9161S	G63862		JSB4344S	143385		JSL4516S	143410	
JGT5028S	G63609		JGT9246S	G63845		JSB4346S	143324		JSL4524S	143397	
JGT5030S	G63425		JHM4486S	G56606		JSB4348S	143364		JSL4526S	143477	
JGT5034S	81082		JHS4254S	49228		JSB4350S	143369		JSL4630S	142329	
JGT5036S	G63683		JHS4254S	49255		JSB4350S	143468		JSL4652S	142843	
JGT5038S	81914		JHT5112S	69787		JSB4368S	143408		JSL4662S	143458	
JGT5040S	81713		JHT5168S	G63918		JSB4390S	143473		JSL4672S	142419	
JGT5044S	81924		JHT5778S	G63409		JSB4394S	143422		JSL4750S	142530	
JGT5046S	81890		JOS4292S	G51773		JSB4424S	143318		JSL4754S	143459	
JGT5048S	81918		JOT 5368S	70040		JSB4464S	143342		JSL4768S	142938	
JGT5050S	81482		JOT5244S	G51871		JSB4476S	143406		JSL4786S	143315	
JGT5056S	81917		JOT5246S	G51904		JSB4502S	143366		JSL4794S	143464	
JGT5058S	81893		JOT5250S	69587		JSB4502S	143486		JSL4798S	143423	
JGT5060S	81668		JOT5254S	77674		JSB4566S	142852		JSL4878S	143305	
JGT5064S	81667		JOT5256S	69996		JSB4602S	142245		JSL4914S	143088	
JGT5068S	81836		JOT5276S	69952		JSB4650S	143209		JSL4922S	143339	
JGT5076S	81113		JOT5306S	G63781		JSB4658S	142546				

Important Note: Competitive Interchanges are to be used for stocking purposes only. Where multiple crosses are identified, please reference the applications section of this catalog. / **Remarque importante:** Les interchanges concurrentiels ne s'utilisent qu'aux fins de stocks. Dans le cas de rferences multiples, consulter la section des applications du catalogue. / **Nota importante:** Dans le cas de rferences multiples, consulter la section des applications du catalogue. / **Nota importante:** Se pueden usar intercambios competitivos para propósitos de almacenamiento solamente. Cuando se identifican intercambios múltiples, consulte la sección de aplicaciones de este catálogo.

COMPETITIVE & O.E.M. INTERCHANGE LIST
Lista de Intercambios contra Competidores y Equipo Original.
Liste dinterchange de produits compititifs & equipement original (OEM)

Turtletop Bus

Turtletop bus	Gabriel	Upgrade	Turtletop bus	Gabriel	Upgrade	Turtletop bus	Gabriel	Upgrade	Turtletop bus	Gabriel	Upgrade
ASH-1136	G63623		ASH-1154	G63622							

Tuthill Technologies

Tuthill technologies	Gabriel	Upgrade	Tuthill technologies	Gabriel	Upgrade	Tuthill technologies	Gabriel	Upgrade	Tuthill technologies	Gabriel	Upgrade
1085	83214		17142-01	89410		18164-01	89406		20126-01	89440	
12885-01	85300	89419	1714201	85001	89410	1816401	83122	89406	20129-01	85007	
12885-01	89419		1714201	89410		1816401	89406		2012901	85007	
12885-03	85300	89419	17146-01	83209	89414	18165-01	85006		20960-01	83204	
12885-03	89419		17146-01	89414		1816501	85006		2096001	83204	
1288501	85300	89419	1714601	83209	89414	18166-01	85704		21497-01	85005	89430
1288501	89419		1714601	89414		1816601	85704		21497-01	89430	
1288503	85300	89419	17358-01	83126	89430	18286-01	89414		2149701	85005	89430
1288503	89419		17358-01	89430		18800-01	83203	89436	2149701	89430	
12887-01	85013	89414	1735801	83126	89430	18800-01	89436		23524-01	85738	
12887-01	89414		1735801	89430		1880001	83203	89436	2352401	85738	
12887-02	85013	89414	17403-01	83122	89406	1880001	89436		23553-01	85938	
12887-02	89414		17403-01	89406		19495-01	83126	89430	2355301	85938	
1288701	85013	89414	1740301	83122	89406	19495-01	89430		24392-01	85051	
1288701	89414		1740301	89406		1949501	83126	89430	2439201	85051	
1288702	85013	89414	17408-01	85005	89430	1949501	89430		2697	85712	
1288702	89414		17408-01	89430		19623-01	83123	89405	66502	646155	
16230-01	85702		1740801	85005	89430	19623-01	89405		680162	85300	89419
1623001	85702		1740801	89430		1962301	83123	89405	680162	89419	
16725-01	83126	89430	17794-01	83215		1962301	89405		702135-01	85045	
16725-01	89430		1779401	83215		19824-01	85006		70213501	85045	
1672501	83126	89430	18163-01	83207	89407	1982401	85006		702136-01	85052	
1672501	89430		18163-01	89407		20125-01	85030	89440	70213601	85052	
16824-01	85006		1816301	83207	89407	20125-01	89440		702209-01	85014	
1682401	85006		1816301	89407		2012501	85030	89440	70220901	85014	
17142-01	85001	89410	18164-01	83122	89406	2012501	89440		OE12425	83214	

Twin Coach

Twin coach	Gabriel	Upgrade	Twin coach	Gabriel	Upgrade	Twin coach	Gabriel	Upgrade	Twin coach	Gabriel	Upgrade
90044089	83124	89407	90044162	83128	89436	AR-958	83207	89407	AR958	83207	89407
90044089	89407		90044162	89436		AR-958	89407		AR958	89407	
90044089C	83124	89407	AR-718-C-HD	85000	89436	AR718CHD	85000	89436			
90044089C	89407		AR-718-C-HD	89436		AR718CHD	89436				

UD

Ud	Gabriel	Upgrade	Ud	Gabriel	Upgrade	Ud	Gabriel	Upgrade	Ud	Gabriel	Upgrade
561000T825	83515		56101Z5014	83162		56110-Z5014	83162		56110Z5017	83162	
56101-30Z02	G63610		56101Z5017	83162		56110-Z5017	83162		66400	G63432	
56101-Z5008	83114		56110-30Z02	G63610		56110T8123	G63432		E61000T825	83515	
56101-Z5014	83162		56110-T8123	G63432		56110T8129	G63432				
56101-Z5017	83162		56110-T8129	G63432		56110Z5008	83114				
56101Z5008	83114		56110-Z5008	83114		56110Z5014	83162				

Unity

Unity	Gabriel	Upgrade	Unity	Gabriel	Upgrade	Unity	Gabriel	Upgrade	Unity	Gabriel	Upgrade
11010	G56934		11060	G57277		11094	G57146		11132	G57089	
11010	G56937		11061	G57063		11096	G57146		11133	G57393	
11011	G57110		11062	G57064		11100	G57039		11134	G57394	
11012	G57111		11071	G56956		11101	G57404		11135	G57275	
11013	G57495		11072	G56957		11102	G57405		11136	G57276	
11014	G57496		11074	G56965		11110	G56927		11141	G57268	
11020	G57060		11081	G57010		11111	G57022		11142	G57269	
11021	G57359		11082	G57010		11111	G57398		11150	G56951	
11022	G57360		11083	G57081		11112	G57399				
11024	G57141		11084	G57082		11114	G57059				
11030	G56935		11091	G56991		11130	G57060				
11060	G57156		11092	G56992		11131	G57088				

Important Note: Competitive Interchanges are to be used for stocking purposes only. Where multiple crosses are identified, please reference the applications section of this catalog. / **Remarque importante:** Les interchanges concurrentiels ne s'utilisent qu'aux fins de stocks. Dans le cas de rfrences multiples, consulter la section des applications du catalogue. / **Nota importante:** Dans le cas de rfrences multiples, consulter la section des aplicaciones du catalogue. / **Nota importante:** Se pueden usar intercambios competitivos para propósitos de almacenamiento solamente. Cuando se identifican intercambios múltiples, consulte la sección de aplicaciones de este catálogo.

COMPETITIVE & O.E.M. INTERCHANGE LIST
Lista de Intercambios contra Competidores y Equipo Original.
Liste d'interchange de produits compétitifs & d'équipement original (OEM)

Unity... cont'd

Unity	Gabriel	Upgrade	Unity	Gabriel	Upgrade	Unity	Gabriel	Upgrade	Unity	Gabriel	Upgrade
11151	G56948		11336	G57494		11572	G57035		11733	G57473	
11152	G56948		11343	G57144		11573	G57329		11734	G57474	
11160	G57017		11344	G57145		11574	G57330		11741	G57190	
11171	G56962		11345	G57144		11580	G57000		11742	G57191	
11172	G56963		11346	G57145		11580	G57023		11743	G57218	
11173	G57112		11350	G56975		11581	G57176		11744	G57219	
11174	G57113		11351	G57037		11582	G57177		11745	G57758	
11180	G57022		11352	G57038		11590	G57125		11746	G57759	
11181	G56930		11353	G57202		11591	G57030		11751	G57114	
11182	G56931		11354	G57203		11592	G57031		11752	G57115	
11190	G57142		11356	G57266		11593	G57030		11753	G57558	
11200	G57019		11357	G57267		11594	G57031		11754	G57559	
11201	G57007		11360	G57051		11595	G57367		11761	G57163	
11202	G57008		11373	G57363		11596	G57368		11762	G57164	
11204	G57020		11374	G57364		11597	G57161		11790	G57397	
11206	G57021		11380	G57015		11598	G57162		11800	G57080	
11210	G57060		11381	G57027		11601	G57047		11801	G57369	
11211	G57083		11382	G57027		11602	G57048		11802	G57370	
11212	G57083		11383	G57454		11605	G57479		11805	G57353	
11220	G57013		11384	G57455		11606	G57480		11806	G57354	
11231	G56996		11403	G57130		11610	G57053		11813	G57391	
11232	G56997		11404	G57131		11611	G57161		11814	G57390	
11235	G57207		11410	G57006		11612	G57162		11815	G57390	
11237	G57417		11411	G57541		11613	G57161		11816	G57391	
11238	G57418		11412	G57542		11614	G57162		11821	G57459	
11253	G57204		11420	G56929		11615	G57150		11822	G57460	
11254	G57205		11423	G57126		11616	G57151		11853	G57341	
11255	G57204		11424	G57127		11617	G57481		11854	G57342	
11256	G57205		11450	G56929		11618	G57482		11871	G57054	
11257	G57105		11453	G57200		11620	G57147		11872	G57055	
11258	G57106		11454	G57201		11621	G57045		11873	G57197	
11260	G57071		11463	G57197		11622	G57046		11874	G57198	
11270	G57099		11464	G57198		11631	G57049		11881	G57377	
11270	G57100		11472	G56931		11632	G57050		11882	G57378	
11271	G57135		11473	G57648		11643	G57119		11890	G57095	
11272	G57136		11474	G57649		11644	G57120		11891	G57105	
11280	G57072		11475	G57184		11661	G57011		11892	G57106	
11281	G56930		11476	G57185		11662	G57012		11893	G57515	
11282	G56931		11493	G57337		11663	G57222		11894	G57516	
11283	G57139		11494	G57338		11664	G57223		11900	G57172	
11284	G57140		11505	G57333		11667	G57084		11901	G57137	
11285	G57471		11506	G57334		11668	G57085		11902	G57138	
11286	G57472		11541	G56993		11671	G57069		11903	G57564	
11290	G57118		11542	G56994		11671	G57121		11904	G57565	
11290	G57413		11543	G57449		11672	G57070		11905	G57339	
11296	G57646		11544	G57450		11672	G57122		11906	G57340	
11300	G57092		11545	G57497		11675	G57465		11913	G57673	
11304	G57132		11546	G57498		11676	G57466		11914	G57674	
11306	G57103		11550	G57040		11680	G57109		11921	G57123	
11311	G57603		11560	G57149		11700	G57324		11922	G57124	
11312	G57604		11561	G57065		11701	G57041		11923	G57345	
11320	G57274		11562	G57066		11702	G57042		11924	G57346	
11330	G57421		11563	G57133		11711	G57076		11927	G57628	
11333	G57030		11564	G57134		11712	G57077		11928	G57629	
11334	G57031		11570	G57282		11713	G57560		11931	G57027	
11335	G57493		11571	G57034		11714	G57561		11932	G57027	

Important Note: Competitive Interchanges are to be used for stocking purposes only. Where multiple crosses are identified, please reference the applications section of this catalog. / **Remarque importante:** Les interchanges concurrentiels ne s'utilisent qu'aux fins de stocks. Dans le cas de références multiples, consulter la section des applications du catalogue. / **Nota importante:** Dans le cas de références multiples, consulter la section des applications du catalogue. / **Nota importante:** Se pueden usar intercambios competitivos para propósitos de almacenamiento solamente. Cuando se identifican intercambios múltiples, consulte la sección de aplicaciones de este catálogo.

COMPETITIVE & O.E.M. INTERCHANGE LIST
Lista de Intercambios contra Competidores y Equipo Original.
Liste dinterchange de produits comptitifs & dquipement original (OEM)

Unity... cont'd

Unity	Gabriel	Upgrade	Unity	Gabriel	Upgrade	Unity	Gabriel	Upgrade	Unity	Gabriel	Upgrade
11943	G57157		15072	G57091		15412	G57659		212600	G55681	
11944	G57158		15073	G57499		15413	G57658		212800	G51703	
11950	G57271		15074	G57500		15414	G57659		212810	G51704	
11953	G57489		15080	G57016		15430	G57159		212900	G56817	
11954	G57490		15081	G57400		15430	G57160		212901	G52026	
11961	G57097		15082	G57401		15511	G57344		212902	G52027	
11962	G57098		15085	G57416		15512	G57343		213000	G51758	
11970	G57206		15086	G57416		15580	G57178		213010	G55697	
11973	G57517		15111	G57278		15801	G57428		213020	G55896	
11974	G57518		15112	G57279		15802	G57429		213050	G64040	
11980	G57148		15123	G57415		15903	G57533		213100	G56807	
11981	G57375		15124	G57414		15904	G57534		213200	G55892	
11982	G57376		15130	G56928		15910	G57423		213400	G52131	
11985	G57594		15145	G57086		15911	G57167		213500	G56620	
11986	G57595		15146	G57087		15912	G57168		213501	G52081	
11990	G57270		15161	G56932		18-125001	G52145		213502	G52082	
11990	G57427		15162	G56933		18-125002	G52144		213700	G51728	
11991	G57373		15170	G56964		210020	G55774		213800	G51815	
11992	G57372		15180	G57419		210101	G52112		213900	G51267	
11993	G57107		15190	G57420		210102	G52113		214010	G51739	
11994	G57108		15211	G56973		210160	G64008		214011	G56730	
12-143000	69675		15212	G56974		210201	G56621		214012	G56731	
12-198000	G64001		15220	G56998		210202	G56622		214020	G51855	
12-199000	G63817		15230	G57014		210301	G56759		214051	G55591	
12-514800-HD	G63842		15270	G57057		210302	G56758		214052	G55591	
12-525000	G64046		15270	G57058		210901	G56800		214100	G51477	
12-540000	69606		15280	G56943		210902	G56799		214101	G55993	
12-541000	69575		15301	G57128		211000	G55948		214102	G55994	
12-543000	69606		15302	G57129		211001	G55999		214200	G51077	
12-560000	G63717		15310	G57447		211002	G55999		214300	G51077	
12-598000	77983		15311	G56924		211010	G51746		214301	G56506	
13-110900	77803		15312	G56925		211050	G56718		214302	G56514	
13423	G57853		15320	G57444		211060	G55698		214400	G51477	
13424	G57852		15321	G56932		211080	G56700		214701	G56661	
14-510900	49231		15322	G56933		211100	G56509		214702	G56660	
15021	G56924		15330	G56995		211110	77803		214801	G52013	
15022	G56925		15340	G57026		211200	G52125		214802	G52014	
15025	G57499		15341	G57043		211201	G56886		214901	G56721	
15026	G57500		15342	G57044		211202	G56887		214902	G56722	
15030	G56938		15343	G57424		211300	G56810		215011	G52008	
15031	G56932		15344	G57425		211400	G52116		215012	G52009	
15032	G56933		15350	G57036		211401	G56773		215021	G52121	
15040	G56936		15351	G57078		211402	G56774		215022	G52122	
15041	G57449		15352	G57079		211500	G51718		215101	G56671	
15042	G57450		15361	G57192		211700	G51850		215102	G56672	
15043	G57449		15362	G57193		211800	G52025		215200	G51765	
15044	G57450		15371	G57067		212001	G56516		215300	G51766	
15050	G57056		15372	G57068		212002	G56517		215401	G56615	
15051	G56949		15380	G57075		212030	G55551		215402	G56616	
15052	G56950		15381	G57032		212100	G51722		215901	G52094	
15060	G57018		15381	G57061		212101	G56836		215902	G52095	
15061	G56924		15382	G57033		212102	G56837		217100	G51097	
15062	G56925		15382	G57062		212110	G51887		217101	G52237	
15063	G57451		15400	G57096		212200	G51859		217102	G52238	
15064	G57452		15410	G57173		212300	G63716		217200	G56606	
15071	G57090		15411	G57658		212400	G51723		219001	G52164	

Important Note: Competitive Interchanges are to be used for stocking purposes only. Where multiple crosses are identified, please reference the applications section of this catalog./ **Remarque importante:** Les interchanges concurrentiels ne s'utilisent qu'aux fins de stocks. Dans le cas de rfrences multiples, consulter la section des applications du catalogue./ **Nota importante:** Dans le cas de rfrences multiples, consulter la section des applications du catalogue./ **Nota importante:** Se pueden usar intercambios competitivos para propósitos de almacenamiento solamente. Cuando se identifican intercambios múltiples, consulte la sección de aplicaciones de este catálogo.

COMPETITIVE & O.E.M. INTERCHANGE LIST
Lista de Intercambios contra Competidores y Equipo Original.
Liste dinterchange de produits comptitifs & dquipement original (OEM)

Unity... cont'd

Unity	Gabriel	Upgrade	Unity	Gabriel	Upgrade	Unity	Gabriel	Upgrade	Unity	Gabriel	Upgrade
219002	G52165		251400	G63866		254030	G64029		259110	G64080	
219010	G56894		251500	G63959		254030	G64030		259120	G64012	
219021	G52005		251600	G63868		254040	G51804		259130	G63966	
219022	G52006		252000	G56838		254051	61699		259130	G63967	
219030	G56809		252010	69900		254052	61700		259140	G51980	
219201	G56539		252020	69465		254060	G64026		259150	70036	
219202	G56540		252030	69464		254070	G63889		259201	G56640	
219300	G51714		252040	G64047		254070	G64006		259202	G56641	
219301	G56634		252080	69591		254080	G63610		259300	G51759	
219302	G56633		252090	G63870		254090	G64087		259320	69901	
219401	G56562		252100	G51724		254300	G51736		259340	69901	
219402	G56561		252110	G63867		254301	G56728		259340	70040	
219500	G56802		252110	G64157		254302	G56729		259350	70028	
219801	G56601		252130	70096		254700	G63815		259400	G51794	
219802	G56568		252200	G63717		254800	G63815		259401	G52335	
219910	G51806		252300	G55901		255030	70089		259402	G52336	
231400	G52131		252310	G64037		255040	G63875		259420	G64056	
250000	G51858		252400	69592		255050	G64033		259710	70045	
250020	69909		252400	69593		255100	G51087		259800	69907	
250030	G64003		252420	G511001		255110	G51812		259810	70013	
250310	70010		252500	G63299		255130	70089		259820	69813	
250600	G51738		252600	G64079		255300	G51727		259830	70000	
25100	G51715		252700	G63676		255400	G63878		259850	G64032	
251010	69589		253000	G51861		255410	G64031		259870	G64000	
251020	G63842		253010	69473		255420	G63712		259880	G64071	
251020	G64014		253020	G63844		255500	G63883		259890	70037	
251030	69587		253030	G63690		255510	G64050		801940	142230	
251040	69590		253040	G51807		255600	G51798		801940	142419	
251050	G51700		253050	G64042		255610	G51803		801940	143353	
251060	G55949		253100	G51842		255700	70041		804975	143315	
251090	G55825		253200	G51268		255800	70027		805606	143239	
251100	G55949		253500	G55856		255900	G51802		805904	143305	
251120	G63842		253600	G51721		256100	G51863		805907	143323	
251130	G63776		253610	69676		256200	61716		805908	143355	
251130	G63869		253620	G51884		256400	G63891		805909	143354	
251140	G63872		254001	G55675		257010	69945		805966	143468	
251140	G64015		254002	G55676		257020	G51799		805983	143342	
251160	70031		254010	G63726		259000	G51881		806914	142937	
251201	G55661		254020	G64038		259020	70003		806980	143365	
251202	G55662		254030	G63885		259100	G51767				

Universal Coach

Universal coach	Gabriel	Upgrade	Universal coach	Gabriel	Upgrade	Universal coach	Gabriel	Upgrade	Universal coach	Gabriel	Upgrade
12-05-1199	85729		12051199	85729		680777	85729				

UPS Truck

Ups truck	Gabriel	Upgrade	Ups truck	Gabriel	Upgrade	Ups truck	Gabriel	Upgrade	Ups truck	Gabriel	Upgrade
P117099	83120										

Utility Trailer Manufacturing Company

Utility trailer manufacturing company	Gabriel	Upgrade	Utility trailer manufacturing company	Gabriel	Upgrade	Utility trailer manufacturing company	Gabriel	Upgrade	Utility trailer manufacturing company	Gabriel	Upgrade
B-23361	85911		B-24125	85323	89436	B24023	85738		S-24088	83389	89436
B-23566	85000	89436	B-24125	89436		B24088	83389	89436	S-24088	85000	89436
B-23566	89436		B-24579	85939		B24088	85000	89436	S-24088	89436	
B-23651	85045		B-25515	85338		B24088	89436		S24088	83389	89436
B-24023	85738		B23361	85911		B24125	85323	89436	S24088	85000	89436
B-24088	83389	89436	B23566	85000	89436	B24125	89436		S24088	89436	
B-24088	85000	89436	B23566	89436		B24579	85939				
B-24088	89436		B23651	85045		B25515	85338				

Important Note: Competitive Interchanges are to be used for stocking purposes only. Where multiple crosses are identified, please reference the applications section of this catalog. / **Remarque importante:** Les interchanges concurrentiels ne s'utilisent qu'aux fins de stocks. Dans le cas de rferences multiples, consulter la section des applications du catalogue. / **Nota importante:** Dans le cas de rferences multiples, consulter la section des applications du catalogue. / **Nota importante:** Se pueden usar intercambios competitivos para propósitos de almacenamiento solamente. Cuando se identifican intercambios múltiples, consulte la sección de aplicaciones de este catálogo.

COMPETITIVE & O.E.M. INTERCHANGE LIST
Lista de Intercambios contra Competidores y Equipo Original.
Liste dinterchange de produits comptitifs & dquipement original (OEM)

Utility Trailer Manufacturing Company... cont'd

Volkswagen

Volkswagen	Gabriel	Upgrade	Volkswagen	Gabriel	Upgrade	Volkswagen	Gabriel	Upgrade	Volkswagen	Gabriel	Upgrade
1J0 413 031 GC	G56606		1T0 413 031 HM	G56899		5N0 413 031 AA	G52301		7B0 412 031 A	G52131	
1J0 513 025 DP	69945		1T0 413 031 HN	G56899		5N0 413 031 AC	G52301		7B0 412 031 B	G52131	
1K0 412 331 B	143344		1T0 413 031 HP	G56899		5N0 413 031 AK	G52301		7B0 412 031 C	G52131	
1K0 412 331 C	143344		3AA 413 031 M	G56899		5N0 413 031 AS	G52301		7B0 513 031 N	G64042	
1K0 513 029 FP	G51799		3C0 413 031 AS	G56899		5N0 512 011 AA	G51993		7B0 513 031 P	G64042	
1K0 513 029 HM	G51799		3C0 413 031 AT	G56899		5N0 513 049 AB	G51993		7L6 413 031 S	G52348	
1K0 513 029 HN	G51799		3C0 413 031 M	G56899		5N0 513 049 AC	G51993		7L6 413 031 T	G52348	
1K0 513 029 HQ	G51799		3C0 513 049 BD	G51799		5N0 513 049 AJ	G51993		7L6 413 032 S	G52349	
1K0 513 029 ME	G51799		3C0 513 049 BH	G51799		5N0 513 049 AK	G51993		7L6 413 032 T	G52349	
1K0 513 029 MF	G51799		3C0 513 049 CP	G51799		5N0 513 049 AP	G51993		7L6 513 029 N	G51928	
1K0 513 029 MG	G51799		3C0 513 353 C	143345		5N0 513 049 AQ	G51993		7L6 513 029 P	G51928	
1K0 513 353 G	143345		5C0 413 031 BB	G56899		5N0 513 049 BF	G51993				
1T0 413 031 EQ	G56899		5C0 513 025 H	G51799		5N0 513 049 BG	G51993				
1T0 413 031 HK	G56899		5C0 513 049 BS	G51799		5N0 513 049 T	G51993				

Volvo

Volvo	Gabriel	Upgrade	Volvo	Gabriel	Upgrade	Volvo	Gabriel	Upgrade	Volvo	Gabriel	Upgrade
02-7005976	83400		1091373	89420		20433427	85065		22662125	83048	
02-7005977	83400		1091374	85303	89422	20434880	85081		22662224	83048	
027005976	83400		1091374	89422		20469001	85933	89454	22662230	83905	
027005977	83400		1091375	85304		20469001	89454		22662235	83905	
03-1106460	85005	89430	1091376	85305		20469002	85933	89454	22662237	83905	
03-1106460	89430		1091377	85307		20469002	89454		22866844	83048	
031106460	85005	89430	1091378	85308	89422	20485632	85933	89454	23159761	85188	
031106460	89430		1091378	89422		20485632	89454		23159763	85188	
1091347	83125		1091379	85310	89423	20485633	85933	89454	23288402	85061	89450
1091348	83122	89406	1091379	89423		20485633	89454		23288403	85061	89450
1091348	89406		1093100	85027		20496215	83048		23567823	85072	
1091349	83204		1093176	85024		20496217	83029		23568046	85036	89405
1091350	83207	89407	1093178	85026		20513881	85061	89450	23568046	89405	
1091350	89407		1093180	85030	89440	20551628	85066	89448	25624698	83041	
1091351	83209	89414	1093180	89440		20551628	89448		25624730	85005	89430
1091351	89414		1201-0012	83023		20704334	83048		25624730	89430	
1091353	83215		12010012	83023		20707753	85030	89440	25625008	83019	
1091354	83216		1202-0012	83023		20707753	85906	89407	2562558	85060	
1091357	83219		1202-0032	83016		20707753	89407		3082284	83400	
1091358	83456	89447	12020012	83023		20707753	89440		3092842	85061	89450
1091358	89447		12020032	83016		20721254	83048		31200386	70040	
1091359	83123	89405	141700000370	85061	89450	20782199	85072		31200599	143191	
1091359	89405		141700000370	89450		20863239	85080		31200754	70040	
1091360	83303		141700000373	85061	89450	20874147	83050		31262173	70040	
1091362	83309		141700005838	85061	89450	20973993	85061	89450	3130140	85315	
1091363	83221		14QK-429M2	85072		21137330	85933	89454	3171696	85307	
1091364	83312	89409	1505190	85722		21137330	89454		3172948	85303	89422
1091364	89409		1591501	85722		21368411	83905		3172948	89422	
1091365	83400		1593843	83215		21368413	83048		3199937	85316	89426
1091366	83401		1716824	85304		21391412	83048		3199937	89426	
1091367	85000	89436	19501669	85339		21391413	83048		3199938	85030	89440
1091367	89436		19502711	85702		21436086	85061	89450	3199938	89440	
1091368	85003	89411	19506846	85339		21462378	85088		3199939	85058	89431
1091368	89411		20353932	85081		21462380	85088		3199939	89431	
1091370	85006		20414440	85081		22012065	85304		3199940	85005	89430
1091371	85300	89419	20433424	85061	89450	22046483	85304				
1091371	89419		20433425	85066	89448	22052336	85304				
1091372	85301		20433425	89448		22314111	85036	89405			
1091373	85302	89420	20433426	85081		22314111	89405				

Important Note: Competitive Interchanges are to be used for stocking purposes only. Where multiple crosses are identified, please reference the applications section of this catalog. / **Remarque importante:** Les interchanges concurrentiels ne s'utilisent qu'aux fins de stocks. Dans le cas de rfrences multiples, consulter la section des applications du catalogue. / **Nota importante:** Dans le cas de rfrences multiples, consulter la section des applications du catalogue. / **Nota importante:** Se pueden usar intercambios competitivos para propósitos de almacenamiento solamente. Cuando se identifican intercambios múltiples, consulte la sección de aplicaciones de este catálogo.

COMPETITIVE & O.E.M. INTERCHANGE LIST
Lista de Intercambios contra Competidores y Equipo Original.
Liste dinterchange de produits comptitifs & dquipement original (OEM)

Volvo... cont'd

Volvo	Gabriel	Upgrade	Volvo	Gabriel	Upgrade	Volvo	Gabriel	Upgrade	Volvo	Gabriel	Upgrade
3199940	89430		3199984	89425		37301-0018	89430		3919902	89430	
3199941	85006		3199985	85723		37301-0021	85026		3919903	83216	
3199942	89402		3199986	85318		37301-3201	85027		3919904	G63183	
3199943	85012	89413	3199987	85705	89447	37301-3202	85026		3919906	83308	
3199943	89413		3199987	89447		373010001	85013	89414	3919907	83309	
3199944	85006		3199988	85311	89424	373010001	89414		3919909	G63605	
3199945	85027		3199988	89424		373010008	83400		3919910	83221	
3199946	85033	89427	3199989	85709		373010016	85026		3919911	83124	89407
3199946	89427		3199990	85003	89411	373010018	85005	89430	3919911	89407	
3199947	85013	89414	3199990	89411		373010018	89430		3919912	83215	
3199947	89414		3199991	85708		373010021	85026		3919913	83203	89436
3199948	85311	89424	3199992	85733		373013201	85027		3919913	89436	
3199948	89424		3199993	85712		373013202	85026		3919914	83209	89414
3199949	85310	89423	3199994	85308	89422	3915917	85319	89428	3919914	89414	
3199949	89423		3199994	89422		3915917	89428		3919915	83127	
3199950	85023	89415	35901-0001	83209	89414	3915947	85001	89410	3919916	83126	89430
3199950	89415		35901-0001	89414		3915947	89410		3919916	89430	
3199951	85024		35901-0003	85301		3915948	85311	89424	3919917	83125	
3199952	85736		35901-0004	83219		3915948	89424		3919918	83401	
3199953	85319	89428	35901-0005	83219		3916352	85013	89414	3919919	G63625	
3199953	89428		35901-0008	85060		3916352	89414		3919920	83303	
3199954	85003	89411	35901-0011	83123	89405	3919055	85007		3919921	83123	89405
3199954	89411		35901-0011	89405		3919056	83203	89436	3919921	89405	
3199955	85300	89419	35901-0017	83314		3919056	89436		3919922	83318	
3199955	89419		35901-0022	83635		3919057	83225		3919923	83301	
3199956	85036	89405	35901-3201	85024		3919526	83314		3919924	83456	89447
3199956	89405		35901-3406	85305		3919561	85314	89425	3919924	89447	
3199957	83122	89406	35901-3409	85304		3919561	89425		3919925	83317	
3199957	89406		35901-3410	85307		3919565	83103		3919926	G63403	
3199959	85323	89436	35901-3413	85006		3919567	83613		3919927	83101	
3199959	89436		35901-3420	85303	89422	3919569	85052		3919928	83225	
3199960	85322		35901-3420	89422		3919570	83128	89436	3919931	83126	89430
3199961	85307		359010001	83209	89414	3919570	89436		3919931	89430	
3199962	85314	89425	359010001	89414		3919571	83635		3919932	85062	89408
3199962	89425		359010003	85301		3919572	83130		3919932	89408	
3199963	85315		359010004	83219		3919573	83123	89405	3919933	85001	89410
3199965	85736		359010005	83219		3919573	89405		3919933	89410	
3199966	85303	89422	359010008	85060		3919574	85006		3919934	85320	89429
3199966	89422		359010011	83123	89405	3919575	83120		3919934	89429	
3199967	85302	89420	359010011	89405		3919582	83215		3919935	85026	
3199967	89420		359010017	83314		3919585	83209	89414	3919936	83207	89407
3199968	85308	89422	359010022	83635		3919585	89414		3919936	89407	
3199968	89422		359013201	85024		3919587	83105		3919937	85316	89426
3199972	85320	89429	359013406	85305		3919588	83216		3919937	89426	
3199972	89429		359013409	85304		3919588	83216		3919938	85030	89440
3199973	85722		359013410	85307		3919589	85026		3919938	89440	
3199974	85712		359013413	85006		3919591	83515		3919938	89440	
3199975	85700		359013420	85303	89422	3919592	85024		3919939	85058	89431
3199976	85711		359013420	89422		3919593	83242		3919939	89431	
3199977	85711		37001-5	83401		3919594	85003	89411	3919940	85005	89430
3199978	85712		370015	83401		3919594	89411		3919940	89430	
3199979	85702		37301-0001	85013	89414	3919598	83312	89409	3919941	85006	
3199980	85310	89423	37301-0001	89414		3919598	89409		3919942	89402	
3199980	89423		37301-0008	83400		3919900	85012	89413	3919943	85012	89413
3199983	85704		37301-0016	85026		3919900	89413		3919943	89413	
3199984	85314	89425	37301-0018	85005	89430	3919901	83103		3919944	85036	89405
						3919902	83126	89430	3919944	89405	

Important Note: Competitive Interchanges are to be used for stocking purposes only. Where multiple crosses are identified, please reference the applications section of this catalog. / **Remarque importante:** Les interchanges concurrentiels ne s'utilisent qu'aux fins de stocks. Dans le cas de références multiples, consulter la section des applications du catalogue. / **Nota importante:** Dans le cas de références multiples, consulter la section des applications du catalogue. / **Nota importante:** Se pueden usar intercambios competitivos para propósitos de almacenamiento solamente. Cuando se identifican intercambios múltiples, consulte la sección de aplicaciones de este catálogo.

COMPETITIVE & O.E.M. INTERCHANGE LIST
Lista de Intercambios contra Competidores y Equipo Original.
Liste d'interchange de produits compititifs & d'equpement original (OEM)

Volvo... cont'd

Volvo	Gabriel	Upgrade	Volvo	Gabriel	Upgrade	Volvo	Gabriel	Upgrade	Volvo	Gabriel	Upgrade
3919945	85027		3919991	85708		47902-24	83137		64838-003	89454	
3919946	85033	89427	3919992	85733		4790224	83137		64838-003L	85933	89454
3919946	89427		3919993	85712		494-660	83219		64838-003L	89454	
3919947	85013	89414	3919994	85310	89423	4940640	83216		64838001	85933	89454
3919947	89414		3919994	89423		494660	83219		64838001	89454	
3919948	85311	89424	3945808	89407		4975479	83400		64838002	85933	89454
3919948	89424		3945809	89410		4975480	83400		64838002	89454	
3919949	85310	89423	3945810	89420		4975549	83216		64838003	85933	89454
3919949	89423		3945811	89409		530596	85308	89422	64838003	89454	
3919950	83219		3945812	89423		530596	89422		64838003L	85933	89454
3919951	83309		3945813	89428		5322338	83214		64838003L	89454	
3919952	85736		3945814	89424		5513989	83216		66010-0007	83004	
3919953	85319	89428	3945815	89406		5531435	85307		66010-0008	83004	
3919953	89428		3945816	89430		5531436	85307		660100007	83004	
3919954	85003	89411	3945817	89422		5531437	85307		660100008	83004	
3919954	89411		3945818	89415		5534430	85303	89422	662211401	83215	
3919955	85300	89419	3945819	89411		5534430	89422		665410	85027	
3919955	89419		3945820	89413		5534447	85303	89422	665539	85026	
3919956	85036	89405	3945821	89419		5534447	89422		665607	85047	89435
3919956	89405		3945842	83009		5549899	83207	89407	665607	89435	
3919957	83122	89406	3946210	83103		5549899	89407		665623	85046	89434
3919957	89406		3946217	83125		5549925	85304		665623	89434	
3919958	85046	89434	3946219	83400		5554959	83401		665739	85047	89435
3919958	89434		3946239	85724	89443	57241-3	83112		665739	89435	
3919959	85000	89436	3946239	89443		572413	83112		668302	83216	
3919959	89436		3949240	85047	89435	60657-007	85072		676081	83401	
3919960	85322		3949240	89435		60657007	85072		676082	83401	
3919961	85302	89420	3949241	85061	89450	60675-001	85978		6771501	85040	
3919961	89420		3953643	85040		60675-001L	85978		6772218	85040	
3919962	85700		3971703	83112		60675-13	85036	89405	6775411	85040	
3919964	85304		3972662	85976		60675-13	89405		6775412	85040	
3919965	85702		41700014316	85061	89450	60675001	85978		6790756	83215	
3919966	85736		471700000443	85066	89448	60675001L	85978		6794358	85040	
3919967	85302	89420	471700000443	89448		6067513	85036	89405	6857668	83105	
3919967	89420		471700002627	85066	89448	6067513	89405		6876828	83105	
3919968	85736		471700002627	89448		60680-003	83112		70042	85302	89420
3919972	85320	89429	471700002630	85066	89448	60680-003L	83112		70042	89420	
3919972	89429		471700002630	89448		60680-004	83143		8026658	85046	89434
3919973	85956		471700003830	85933	89454	60680-004L	83143		8026658	89434	
3919974	85712		471700003830	89454		60680-005	83142		8056892	85023	89415
3919975	85700		471700003832	85933	89454	60680-005L	83142		8056892	89415	
3919976	85033	89427	471700003832	89454		60680003	83112		8060026	85065	
3919976	89427		471700004420	85109		60680003L	83112		8065787	85026	
3919977	85033	89427	471700004423	85109		60680004	83143		8071524	85024	
3919977	89427		471700006038	85088		60680004L	83143		8071881	85061	89450
3919978	85702		471700006040	85088		60680005	83142		8073212	85065	
3919979	85702		471700013186	85109		60680005L	83142		8075257	85065	
3919980	85702		471700014316	85061	89450	629398	85307		8075287	85065	
3919983	85704		471700014318	85188		629501	85307		8077874	85047	89435
3919984	85700		471700131256	85065		635869	83004		8077874	89435	
3919985	85723		471700131258	85081		646220	85734		8077874-P01	85047	89435
3919988	85311	89424	471700131260	85081		64838-001	85933	89454	8077874-P01	89435	
3919988	89424		471700131920	85933	89454	64838-001	89454		8077874P01	85047	89435
3919989	85709		471700131920	89454		64838-002	85933	89454	8077874P01	89435	
3919990	85003	89411	471700131921	85933	89454	64838-002	89454		8078195	85061	89450
3919990	89411		471700131921	89454		64838-003	85933	89454	8078546	83028	

Important Note: Competitive Interchanges are to be used for stocking purposes only. Where multiple crosses are identified, please reference the applications section of this catalog. / **Remarque importante:** Les interchanges concurrentiels ne s'utilisent qu'aux fins de stocks. Dans le cas de références multiples, consulter la section des applications du catalogue. / **Nota importante:** Dans le cas de références multiples, consulter la section des applications du catalogue. / **Nota importante:** Se pueden usar intercambios competitivos para propósitos de almacenamiento solamente. Cuando se identifican intercambios múltiples, consulte la sección de aplicaciones de este catálogo.

COMPETITIVE & O.E.M. INTERCHANGE LIST
Lista de Intercambios contra Competidores y Equipo Original.
Liste dinterchange de produits comptitifs & dquipement original (OEM)

Volvo... cont'd

Volvo	Gabriel	Upgrade	Volvo	Gabriel	Upgrade	Volvo	Gabriel	Upgrade	Volvo	Gabriel	Upgrade
8078547	83029		83176221	85047	89435	ASH-24446	83215		RC SA5933	85933	89454
8083872	85978		83176221	89435		ASH24446	83215		RC SA5933	89454	
8086053	85047	89435	83176222	85052		AX-310	83215		RC SA6155	646155	
8086053	89435		83176223	85061	89450	AX310	83215		SA3019	83019	
8086651	85066	89448	83176224	85062	89408	D7HT-18080-AA	83215		SA3041	83041	
8086651	89448		83176224	89408		D7HT-18080-DA	83215		SA3045	83045	
8162662	83004		83176225	85066	89448	D7HT18080AA	83215		SA3048	83048	
8168617	83030		83176225	89448		D7HT18080DA	83215		SA3103	83103	
8169859	85047	89435	83176226	85067	89451	E0HT-18080-AA	83215		SA3110	83110	
8169859	89435		83176226	89451		E0HT18080AA	83215		SA3111	83111	
8174749	85906	89407	83176227	85069	89455	RC SA3041	83041		SA3112	83112	
8174749	89407		83176227	89455		RC SA3045	83045		SA3123	83123	89405
83176191	83019		83176228	85070	89459	RC SA3048	83048		SA3123	89405	
83176192	83041		83176228	89459		RC SA3103	83103		SA3124	83124	89407
83176193	83045		83176229	85303	89422	RC SA3111	83111		SA3124	89407	
83176194	83048		83176229	89422		RC SA3112	83112		SA3125	83125	
83176195	83103		83176230	85310	89423	RC SA3124	83124	89407	SA3126	83126	89430
83176196	83110		83176230	89423		RC SA3124	89407		SA3126	89430	
83176197	83111		83176231	85311	89424	RC SA3125	83125		SA3127	83127	
83176198	83112		83176231	89424		RC SA3127	83127		SA3128	83128	89436
83176199	83123	89405	83176232	85320	89429	RC SA3128	83128	89436	SA3128	89436	
83176199	89405		83176232	89429		RC SA3128	89436		SA3136	83136	
83176200	83124	89407	83176233	85321		RC SA3136	83136		SA3148	83148	
83176200	89407		83176234	85323	89436	RC SA3148	83148		SA5000	85000	89436
83176201	83125		83176234	89436		RC SA3203	83203	89436	SA5000	89436	
83176202	83126	89430	83176235	85724	89443	RC SA3203	89436		SA5001	85001	89410
83176202	89430		83176235	89443		RC SA3216	83216		SA5001	89410	
83176203	83127		83176236	85900		RC SA5000	85000	89436	SA5003	85003	89411
83176204	83128	89436	83176237	85916	89430	RC SA5000	89436		SA5003	89411	
83176204	89436		83176237	89430		RC SA5001	85001	89410	SA5005	85005	89430
83176205	83136		83176238	85918	89449	RC SA5001	89410		SA5005	89430	
83176206	83148		83176238	89449		RC SA5003	85003	89411	SA5023	85023	89415
83176207	83203	89436	83176239	85933	89454	RC SA5003	89411		SA5023	89415	
83176207	89436		83176239	89454		RC SA5005	85005	89430	SA5026	85026	
83176208	83209	89414	83176240	646155		RC SA5005	89430		SA5033	85033	89427
83176208	89414		85104186	85006		RC SA5047	85047	89435	SA5033	89427	
83176209	83215		85104221	85066	89448	RC SA5047	89435		SA5036	85036	89405
83176210	83216		85104221	89448		RC SA5052	85052		SA5036	89405	
83176211	85000	89436	85105667	83128	89436	RC SA5061	85061	89450	SA5045	85045	
83176211	89436		85105667	89436		RC SA5062	85062	89408	SA5046	85046	89434
83176212	85001	89410	85106580	85918	89449	RC SA5062	89408		SA5046	89434	
83176212	89410		85106580	89449		RC SA5066	85066	89448	SA5047	85047	89435
83176213	85003	89411	85107095	83009		RC SA5066	89448		SA5047	89435	
83176213	89411		85107238	85976		RC SA5067	85067	89451	SA5052	85052	
83176214	85005	89430	85134402	85061	89450	RC SA5067	89451		SA5061	85061	89450
83176214	89430		85137234	83125		RC SA5070	85070	89459	SA5062	85062	89408
83176215	85023	89415	85137420	85000	89436	RC SA5070	89459		SA5062	89408	
83176215	89415		85137420	89436		RC SA5310	85310	89423	SA5066	85066	89448
83176216	85026		8667252	G56802		RC SA5310	89423		SA5066	89448	
83176217	85033	89427	8667253	G56802		RC SA5320	85320	89429	SA5067	85067	89451
83176217	89427		90045132	85906	89407	RC SA5320	89429		SA5067	89451	
83176218	85036	89405	90045132	85909		RC SA5724	85724	89443	SA5069	85069	89455
83176218	89405		90045132	89407		RC SA5724	89443		SA5069	89455	
83176219	85045		90045605	85109		RC SA5900	85900		SA5070	85070	89459
83176220	85046	89434	90045803	85109		RC SA5918	85918	89449	SA5070	89459	
83176220	89434		90045812	85109		RC SA5918	89449		SA5303	85303	89422

Important Note: Competitive Interchanges are to be used for stocking purposes only. Where multiple crosses are identified, please reference the applications section of this catalog. / **Remarque importante:** Les interchanges concurrentiels ne s'utilisent qu'aux fins de stocks. Dans le cas de références multiples, consulter la section des applications du catalogue. / **Nota importante:** Dans le cas de referencias multiples, consultar la sección de aplicaciones del catálogo. / **Nota importante:** Se pueden usar intercambios competitivos para propósitos de almacenamiento solamente. Cuando se identifican intercambios múltiples, consulte la sección de aplicaciones de este catálogo.

COMPETITIVE & O.E.M. INTERCHANGE LIST

Lista de Intercambios contra Competidores y Equipo Original.

Liste d'interchange de produits compititifs & d'equipement original (OEM)

Volvo... cont'd

Volvo	Gabriel	Upgrade	Volvo	Gabriel	Upgrade	Volvo	Gabriel	Upgrade	Volvo	Gabriel	Upgrade
SA5303	89422		SA5320	89429		SA5900	85900		SA5933	89454	
SA5310	85310	89423	SA5321	85321		SA5916	85916	89430	SA6155	646155	
SA5310	89423		SA5323	85323	89436	SA5916	89430		SDA471700131258	85081	
SA5311	85311	89424	SA5323	89436		SA5918	85918	89449			
SA5311	89424		SA5724	85724	89443	SA5918	89449				
SA5320	85320	89429	SA5724	89443		SA5933	85933	89454			

Volvo RoadChoice

Volvo roadchoice	Gabriel	Upgrade	Volvo roadchoice	Gabriel	Upgrade	Volvo roadchoice	Gabriel	Upgrade	Volvo roadchoice	Gabriel	Upgrade
SA3008	83008		SA3203	83203	89436	SA5036	89405		SA5311	85311	89424
SA3019	83019		SA3203	89436		SA5045	85045		SA5311	89424	
SA3038	83038		SA3209	83209	89414	SA5046	85046	89434	SA5320	85320	89429
SA3041	83041		SA3209	89414		SA5046	89434		SA5320	89429	
SA3045	83045		SA3215	83215		SA5047	85047	89435	SA5321	85321	
SA3048	83048		SA3216	83216		SA5047	89435		SA5323	85323	89436
SA3066	83066		SA3905	83905		SA5052	85052		SA5323	89436	
SA3103	83103		SA5000	85000	89436	SA5061	85061	89450	SA5724	85724	89443
SA3110	83110		SA5000	89436		SA5062	85062	89408	SA5724	89443	
SA3111	83111		SA5001	85001	89410	SA5062	89408		SA5900	85900	
SA3112	83112		SA5001	89410		SA5066	85066	89448	SA5916	85916	89430
SA3123	83123	89405	SA5003	85003	89411	SA5066	89448		SA5916	89430	
SA3123	89405		SA5003	89411		SA5067	85067	89451	SA5918	85918	89449
SA3124	83124	89407	SA5005	85005	89430	SA5067	89451		SA5918	89449	
SA3124	89407		SA5005	89430		SA5069	85069	89455	SA5931	85931	89458
SA3125	83125		SA5012	85012	89413	SA5069	89455		SA5931	89458	
SA3126	83126	89430	SA5012	89413		SA5070	85070	89459	SA5933	85933	89454
SA3126	89430		SA5023	85023	89415	SA5070	89459		SA5933	89454	
SA3127	83127		SA5023	89415		SA5088	85088		SA5934	85934	
SA3128	83128	89436	SA5026	85026		SA5303	85303	89422	SA5958	85958	
SA3128	89436		SA5033	85033	89427	SA5303	89422		SA6155	646155	
SA3136	83136		SA5033	89427		SA5310	85310	89423	SA83203	83203	89436
SA3148	83148		SA5036	85036	89405	SA5310	89423				

Wabash National

Wabash national	Gabriel	Upgrade	Wabash national	Gabriel	Upgrade	Wabash national	Gabriel	Upgrade	Wabash national	Gabriel	Upgrade
202447	85919		FRUUCE12951	85300	89419	HENS20002	89436		NEW900-45-298	83128	89436
203447	85919		FRUUCE12951	89419		HENS20126	85323	89436	NEW900-45-298	89436	
DANSR1VJ100	85078		FRUUCE1295901	85300	89419	HENS20126	89436		NEW900-45-299	85000	89436
FLL83203-071	83203	89436	FRUUCE1295901	89419		HENS21292	85052		NEW900-45-299	89436	
FLL83203-071	89436		FRUUCE2983-1	85322		HENS23566	85000	89436	NEW90044089	83124	89407
FLL83203071	83203	89436	FRUUCE29831	85322		HENS23566	89436		NEW90044089	89407	
FLL83203071	89436		FRUUCF8339-1	85321		HENS24088	83389	89436	NEW90044162	83128	89436
FLL83207-071	83207	89407	FRUUCF83391	85321		HENS24088	85000	89436	NEW90044162	89436	
FLL83207-071	89407		HENS-20001	83389	89436	HENS24088	89436		NEW90044625	83125	
FLL83207071	83207	89407	HENS-20001	89436		NEW900-44-089	83124	89407	NEW90044626	83126	89430
FLL83207071	89407		HENS-20002	85000	89436	NEW900-44-089	89407		NEW90044626	89430	
FLL85000-071	85000	89436	HENS-20002	89436		NEW900-44-162	83128	89436	NEW90044642	83127	
FLL85000-071	89436		HENS-20126	85323	89436	NEW900-44-162	89436		NEW90044794	83127	
FLL85000071	85000	89436	HENS-20126	89436		NEW900-44-625	83125		NEW90044868	85045	
FLL85000071	89436		HENS-21292	85052		NEW900-44-626	83126	89430	NEW90044978	85059	
FLL85030-071	85030	89440	HENS-23566	85000	89436	NEW900-44-626	89430		NEW90044979	83113	
FLL85030-071	89440		HENS-23566	89436		NEW900-44-642	83127		NEW90045040	83130	
FLL85030071	85030	89440	HENS-24088	83389	89436	NEW900-44-794	83127		NEW90045054	85051	
FLL85030071	89440		HENS-24088	85000	89436	NEW900-44-868	85045		NEW90045298	83363	
FRUUCE1295-1	85300	89419	HENS-24088	89436		NEW900-44-978	85059		NEW90045299	85000	89436
FRUUCE1295-1	89419		HENS20001	83389	89436	NEW900-44-979	83113		NEW90045299	89436	
FRUUCE1295-901	85300	89419	HENS20001	89436		NEW900-45-040	83130				
FRUUCE1295-901	89419		HENS20002	85000	89436	NEW900-45-054	85051				

Important Note: Competitive Interchanges are to be used for stocking purposes only. Where multiple crosses are identified, please reference the applications section of this catalog. / **Remarque importante:** Les interchanges concurrentiels ne s'utilisent qu'aux fins de stocks. Dans le cas de rfrences multiples, consulter la section des applications du catalogue. / **Nota importante:** Dans le cas de rfrences multiples, consulter la section des applications du catalogue. / **Nota importante:** Se pueden usar intercambios competitivos para propósitos de almacenamiento solamente. Cuando se identifican intercambios múltiples, consulte la sección de aplicaciones de este catálogo.

COMPETITIVE & O.E.M. INTERCHANGE LIST
Lista de Intercambios contra Competidores y Equipo Original.
Liste dinterchange de produits comptitifs & dquipement original (OEM)

Wabash National... cont'd

Watson & Chalin Mfg. Inc.

Watson & chalin mfg. inc.	Gabriel	Upgrade	Watson & chalin mfg. inc.	Gabriel	Upgrade	Watson & chalin mfg. inc.	Gabriel	Upgrade	Watson & chalin mfg. inc.	Gabriel	Upgrade
10147	83203	89436	17186	85323	89436	19603	85939		727603	83203	89436
10147	89436		17186	89436		3946219	83400		727603	89436	
10147HD	85000	89436	17186-01	85323	89436	53000070-001	646177		727604	83204	
10147HD	89436		17186-01	89436		665724	85000	89436	A-20345	85345	
10148	83204		1718601	85323	89436	665724	89436		A20345	85345	
10634	G63357		1718601	89436		665727	85005	89430	B-23649	85064	
11418	646155		17218	85029		665727	89430		B-23650	85052	
11418	646177		17297	85064		665728	85060		B-23651	85045	
11604	83125		17300	85052		665769	85052		B-23743	85938	
11724	83123	89405	17306	85938		665770	85064		B23649	85064	
11724	89405		17382	85014		665862	85000	89436	B23650	85052	
12128	85005	89430	17430	85321		665862	89436		B23651	85045	
12128	89430		17474	85009		680547	85323	89436	B23743	85938	
17069	632147		19036	85934		680547	89436				
17079	85300	89419	19249	85939		680584	85938				
17079	89419		19250	85382		680714	85934				

Western Star

Western star	Gabriel	Upgrade	Western star	Gabriel	Upgrade	Western star	Gabriel	Upgrade	Western star	Gabriel	Upgrade
02-7005976	83400		1672501	83126	89430	37301-3405	85053	89442	471700006269	85932	89453
02-7005977	83400		1672501	89430		37301-3405	89442		471700006269	89453	
027005976	83400		18-60772-000	83026		37301-3409	85053	89442	471700006270	85932	89453
027005977	83400		18-60773-000	83027		37301-3409	89442		471700006270	89453	
04-9041375	85315		1860772000	83026		37301-3412	85053	89442	471700013186	85109	
049041375	85315		1860773000	83027		37301-3412	89442		471700131330	85932	89453
10-13684-000	85918	89449	19495-01	83126	89430	373013401	85053	89442	471700131330	89453	
10-13684-000	89449		19495-01	89430		373013401	89442		471700131331	85932	89453
10-13809-000	85958		1949501	83126	89430	373013404	85053	89442	471700131331	89453	
1011839	83216		1949501	89430		373013404	89442		47902-13	83122	89406
1013684000	85918	89449	28R010	83216		373013405	85053	89442	47902-13	89406	
1013684000	89449		35066-4413	83122	89406	373013405	89442		47902-24	83137	
1013809000	85958		35066-4413	89406		373013409	85053	89442	47902-8	83122	89406
1201-0012	83023		350664413	83122	89406	373013409	89442		47902-8	89406	
12010012	83023		350664413	89406		373013412	85053	89442	4790213	83122	89406
1202-0012	83023		35901-0001	83209	89414	373013412	89442		4790213	89406	
1202-0032	83016		35901-0001	89414		37390-4401	85053	89442	4790224	83137	
12020012	83023		35901-3406	85305		37390-4401	89442		479028	83122	89406
12020032	83016		35901-3409	85304		37390-4402	85053	89442	479028	89406	
16-15770-000	85956		35901-3410	85307		37390-4402	89442		481700006848	85724	89443
16-15817-000	85724	89443	35901-3413	85006		37390-4403	85053	89442	481700006848	89443	
16-15817-000	89443		35901-3420	85303	89422	37390-4403	89442		481700125969	85956	
16-18331-000	85053	89442	35901-3420	89422		373904401	85053	89442	481700125970	85956	
16-18331-000	89442		35901-4403	85060		373904401	89442		57241-1	83111	
16-18706-000	85331		359010001	83209	89414	373904402	85053	89442	572411	83111	
16-18708-000	85724	89443	359010001	89414		373904402	89442		57252	85308	89422
16-18708-000	89443		359013406	85305		373904403	85053	89442	57252	89422	
1615770000	85956		359013409	85304		373904403	89442		57905-1	85976	
1615817000	85724	89443	359013410	85307		471700000470	85918	89449	57905-2	85006	
1615817000	89443		359013413	85006		471700000470	89449		579051	85976	
1618331000	85053	89442	359013420	85303	89422	471700002809	85724	89443	579052	85006	
1618331000	89442		359013420	89422		471700002809	89443		58913-003	85932	89453
1618706000	85331		359014403	85060		471700002810	85724	89443	58913-003	89453	
1618708000	85724	89443	37301-3401	85053	89442	471700002810	89443				
1618708000	89443		37301-3401	89442		471700003920	85958				
16725-01	83126	89430	37301-3404	85053	89442	471700004420	85109				
16725-01	89430		37301-3404	89442		471700004423	85109				

Important Note: Competitive Interchanges are to be used for stocking purposes only. Where multiple crosses are identified, please reference the applications section of this catalog. / **Remarque importante:** Les interchanges concurrentiels ne s'utilisent qu'aux fins de stocks. Dans le cas de rferences multiples, consulter la section des applications du catalogue. / **Nota importante:** Dans le cas de rferences multiples, consulter la section des applications du catalogue. / **Nota importante:** Se pueden usar intercambios competitivos para propósitos de almacenamiento solamente. Cuando se identifican intercambios múltiples, consulte la sección de aplicaciones de este catálogo.

COMPETITIVE & O.E.M. INTERCHANGE LIST
Lista de Intercambios contra Competidores y Equipo Original.
Liste dinterchange de produits compititifs & dquipement original (OEM)

Western Star... cont'd

Western star	Gabriel	Upgrade	Western star	Gabriel	Upgrade	Western star	Gabriel	Upgrade	Western star	Gabriel	Upgrade
58913-003L	85932	89453	60675-002	85979		654846	83027		680611	89443	
58913-003L	89453		60675-002L	85979		66010-3402	83022		81-4903003500	83026	
58913-012	85932	89453	60675002	85979		66010-3403	83022		814903003500	83026	
58913-012	89453		60675002L	85979		66010-3404	83022		814903003501	83027	
58913-012L	85932	89453	60680-003	83112		66010-3405	83026		90044025	83209	89414
58913-012L	89453		60680-003L	83112		66010-3406	83027		90044025	89414	
58913003	85932	89453	60680-004	83143		66010-3407	83065		90044907	83635	
58913003	89453		60680-004L	83143		660103402	83022		90045099	85906	89407
58913003L	85932	89453	60680-005	83142		660103403	83022		90045099	89407	
58913003L	89453		60680-005L	83142		660103404	83022		90045605	85109	
58913012	85932	89453	60680003	83112		660103405	83026		90045803	85109	
58913012	89453		60680003L	83112		660103406	83027		90045812	85109	
58913012L	85932	89453	60680004	83143		660103407	83065		CP-5222	85315	
58913012L	89453		60680004L	83143		665682	85053	89442	CP5222	85315	
60657-003	85072		60680005	83142		665682	89442		GBL 654916	83026	
60657-003L	85072		60680005L	83142		676081	83401		SDA471700002809	85724	89443
60657003	85072		615016	83401		676082	83401		SDA471700002809	89443	
60657003L	85072		617547	83022		680611	85724	89443	SDA481700125969	85956	

Western Unit Stabiliaire Suspension

Western unit stabiliaire suspension	Gabriel	Upgrade	Western unit stabiliaire suspension	Gabriel	Upgrade	Western unit stabiliaire suspension	Gabriel	Upgrade	Western unit stabiliaire suspension	Gabriel	Upgrade
101030	85307		4939967	85308	89422	80370	85304		80600	89419	
101364	85305		4939967	89422		80600	85300	89419			

Westport Axle Corp.

Westport axle corp.	Gabriel	Upgrade	Westport axle corp.	Gabriel	Upgrade	Westport axle corp.	Gabriel	Upgrade	Westport axle corp.	Gabriel	Upgrade
143699-0185	646177		646124	646177							

Wheeled Coach Ind.

Wheeled coach ind.	Gabriel	Upgrade	Wheeled coach ind.	Gabriel	Upgrade	Wheeled coach ind.	Gabriel	Upgrade	Wheeled coach ind.	Gabriel	Upgrade
ASH-1136	G63623		ASH-1154	G63622		ASH1136	G63623		ASH1154	G63622	

Winnebago

Winnebago	Gabriel	Upgrade	Winnebago	Gabriel	Upgrade	Winnebago	Gabriel	Upgrade	Winnebago	Gabriel	Upgrade
141700131809	85029		481700000493	85900		9U9Z-18125-B	89406		ASH-137	89406	
141700131810	83160		66153-002	83124	89407	9U9Z18124A	83209	89414	ASH-25820	85005	89430
16-16736-000	85029		66153-002	89407		9U9Z18124A	89414		ASH-25820	89430	
16-16737-000	83160		66153002	83124	89407	9U9Z18125A	83122	89406	ASH-25821	85006	
16-16873-000	85029		66153002	89407		9U9Z18125A	89406		ASH-25822	83209	89414
16-16874-000	83160		8C24-18045-DA	G63622		9U9Z18125B	83122	89406	ASH-25822	89414	
16-18103-000	85900		8C24-18080-DB	G63623		9U9Z18125B	89406		ASH-25823	83209	89414
1616736000	85029		8C2418045DA	G63622		ASH-1022	83209	89414	ASH-25823	89414	
1616737000	83160		8C2418080DB	G63623		ASH-1022	89414		ASH-25824	83122	89406
1616873000	85029		8C2Z-18124-D	G63622		ASH-1023	83122	89406	ASH-25824	89406	
1616874000	83160		8C2Z-18125-D	G63623		ASH-1023	89406		ASH-294	83209	89414
1618103000	85900		8C2Z18124D	G63622		ASH-1136	G63623		ASH-294	89414	
1C34-18045-AA	83209	89414	8C2Z18125D	G63623		ASH-1154	G63622		ASH1022	83209	89414
1C34-18045-AA	89414		90045455	85909		ASH-1161	85006		ASH1022	89414	
1C34-18045-JA	83209	89414	9U94-18045-AA	83209	89414	ASH-1162	85005	89430	ASH1023	83122	89406
1C34-18045-JA	89414		9U94-18045-AA	89414		ASH-1162	89430		ASH1023	89406	
1C3418045AA	83209	89414	9U94-18080-AA	83122	89406	ASH-1205	83209	89414	ASH1136	G63623	
1C3418045AA	89414		9U94-18080-AA	89406		ASH-1205	89414		ASH1154	G63622	
1C3418045JA	83209	89414	9U9418045AA	83209	89414	ASH-1206	83122	89406	ASH1161	85006	
1C3418045JA	89414		9U9418045AA	89414		ASH-1206	89406		ASH1162	85005	89430
24-153249	85125		9U9418080AA	83122	89406	ASH-1228	83209	89414	ASH1162	89430	
24-153256	85124		9U9418080AA	89406		ASH-1228	89414		ASH1205	83209	89414
24-186629	85125		9U9Z-18124-A	83209	89414	ASH-1229	83209	89414	ASH1205	89414	
24153249	85125		9U9Z-18124-A	89414		ASH-1229	89414				
24153256	85124		9U9Z-18125-A	83122	89406	ASH-1230	83122	89406			
24186629	85125		9U9Z-18125-A	89406		ASH-1230	89406				
481700000490	85900		9U9Z-18125-B	83122	89406	ASH-137	83122	89406			

Important Note: Competitive Interchanges are to be used for stocking purposes only. Where multiple crosses are identified, please reference the applications section of this catalog. / **Remarque importante:** Les interchanges concurrentiels ne s'utilisent qu'aux fins de stocks. Dans le cas de rfrences multiples, consulter la section des applications du catalogue. / **Nota importante:** Dans le cas de rfrences multiples, consultar la section des aplicaciones du catalogue. / **Nota importante:** Se pueden usar intercambios competitivos para propósitos de almacenamiento solamente. Cuando se identifican intercambios múltiples, consulte la sección de aplicaciones de este catálogo.

COMPETITIVE & O.E.M. INTERCHANGE LIST
Lista de Intercambios contra Competidores y Equipo Original.
Liste dinterchange de produits comptitifs & dquipement original (OEM)

Winnebago... cont'd

Winnebago	Gabriel	Upgrade	Winnebago	Gabriel	Upgrade	Winnebago	Gabriel	Upgrade	Winnebago	Gabriel	Upgrade
ASH1206	83122	89406	ASH25822	89414		AT-766	89414		F4-BE5-F325-HO	85124	
ASH1206	89406		ASH25823	83209	89414	AT163G	G63622		F4BE5A832MO	85125	
ASH1228	83209	89414	ASH25823	89414		AT164G	G63623		F4BE5B492HO	85125	
ASH1228	89414		ASH25824	83122	89406	AT620	83209	89414	F4BE5C832MO	83124	89407
ASH1229	83209	89414	ASH25824	89406		AT620	89414		F4BE5C832MO	89407	
ASH1229	89414		ASH294	83209	89414	AT621	83122	89406	F4BE5F324HO	85125	
ASH1230	83122	89406	ASH294	89414		AT621	89406		F4BE5F325HO	85124	
ASH1230	89406		AT-163G	G63622		AT766	83209	89414	HU9Z-18125-B	83122	89406
ASH137	83122	89406	AT-164G	G63623		AT766	89414		HU9Z-18125-B	89406	
ASH137	89406		AT-620	83209	89414	F4-BE5-A832-MO	85125		HU9Z18125B	83122	89406
ASH25820	85005	89430	AT-620	89414		F4-BE5-B492-HO	85125		HU9Z18125B	89406	
ASH25820	89430		AT-621	83122	89406	F4-BE5-C832-MO	83124	89407	W0005662	85125	
ASH25821	85006		AT-621	89406		F4-BE5-C832-MO	89407		W0005663	85124	
ASH25822	83209	89414	AT-766	83209	89414	F4-BE5-F324-HO	85125		W0006254	85125	

Workhorse

Workhorse	Gabriel	Upgrade	Workhorse	Gabriel	Upgrade	Workhorse	Gabriel	Upgrade	Workhorse	Gabriel	Upgrade
24-153249	85125		66153-002	89407		F4-BE5-C832-MO	83124	89407	F4BE5F324HO	85125	
24-153256	85124		66153002	83124	89407	F4-BE5-C832-MO	89407		F4BE5F325HO	85124	
24-186629	85125		66153002	89407		F4-BE5-F324-HO	85125		W0005662	85125	
24153249	85125		680672	85919		F4-BE5-F325-HO	85124		W0005663	85124	
24153256	85124		7805-X-1012	85919		F4BE5A832MO	85125		W0006254	85125	
24186629	85125		7805X1012	85919		F4BE5B492HO	85125		W0007365	G63866	
659223	G63866		F4-BE5-A832-MO	85125		F4BE5C832MO	83124	89407	W0011635	83221	
66153-002	83124	89407	F4-BE5-B492-HO	85125		F4BE5C832MO	89407		W0011636	G63366	

World Trans Bus Co.

World trans bus co.	Gabriel	Upgrade	World trans bus co.	Gabriel	Upgrade	World trans bus co.	Gabriel	Upgrade	World trans bus co.	Gabriel	Upgrade
ASH-1136	G63623		ASH-1154	G63622		ASH1136	G63623		ASH1154	G63622	

XOS Truck Company

Xos truck company	Gabriel	Upgrade	Xos truck company	Gabriel	Upgrade	Xos truck company	Gabriel	Upgrade	Xos truck company	Gabriel	Upgrade
58913-009	85959		58913009L	85959		60665-025L	85036	89405	60665025	89405	
58913-009L	85959		60665-025	85036	89405	60665-025L	89405		60665025L	85036	89405
58913009	85959		60665-025	89405		60665025	85036	89405	60665025L	89405	

ZF

Zf	Gabriel	Upgrade	Zf	Gabriel	Upgrade	Zf	Gabriel	Upgrade	Zf	Gabriel	Upgrade
SAC315390	85918	89449	SAC315435	85088		SAC315606	85061	89450	SAC410056	83389	89436
SAC315395	85724	89443	SAC315542	83122	89406	SAC315608	85061	89450			

Important Note: Competitive Interchanges are to be used for stocking purposes only. Where multiple crosses are identified, please reference the applications section of this catalog. / **Remarque importante:** Les interchanges concurrentiels ne s'utilisent qu'aux fins de stocks. Dans le cas de références multiples, consulter la section des applications du catalogue. / **Nota importante:** Dans le cas de références multiples, consulter la section des applications du catalogue. / **Nota importante:** Se pueden usar intercambios competitivos para propósitos de almacenamiento solamente. Cuando se identifican intercambios múltiples, consulte la sección de aplicaciones de este catálogo.

EXPLANATION OF SPECIFICATIONS

- Part Number:** The catalog number for the individual shock absorber.
- Extended Length*:** The length of the shock absorber when it is fully extended. See "How to Measure" instructions.
- Collapsed Length*:** The length of the shock absorber when it is fully collapsed. See "How to Measure" instructions.
- Stroke:** This is the approximate length of the stroke of the individual shock absorber being described.
- Mounting Codes:** Indicates the type of mounting ends for the upper and lower end of each shock absorber. They are listed as follows:
 Top mounts ("TM")
 Eye ring and bushing with sleeve mounts ("ES")
 Stud type mounts ("S" & "DS")
 Eye ring and bushing with bar pin mounts ("BP")
 Special mounting codes ("SP")
 Eye ring and bushing mounts ("EB")
 Clevis mounts ("CL")
 Pinch socket mounts ("LP")
 U joint mounts ("LU")

CONVERSION CHART

Fraction (Inches)	Decimal (Inches)	Metric (MM)	Fraction (Inches)	Decimal (Inches)	Metric (MM)
1/64	0.016	0.397	33/64	0.516	13.097
1/32	0.031	0.794	17/32	0.531	13.494
3/64	0.047	1.191	35/64	0.547	13.891
1/16	0.063	1.588	9/16	0.563	14.288
5/64	0.078	1.984	37/64	0.578	14.684
3/32	0.094	2.381	19/32	0.594	15.081
7/64	0.109	2.778	39/64	0.609	15.478
1/8	0.125	3.175	5/8	0.625	15.875
9/64	0.141	3.572	41/64	0.641	16.272
5/32	0.156	3.969	21/32	0.656	16.669
11/64	0.172	4.366	43/64	0.672	17.066
3/16	0.188	4.763	11/16	0.688	17.463
13/64	0.203	5.159	45/64	0.703	17.859
7/32	0.219	5.556	23/32	0.719	18.256
15/64	0.234	5.953	47/64	0.734	18.653
1/4	0.250	6.350	3/4	0.750	19.050
17/64	0.266	6.747	49/64	0.766	19.447
9/32	0.281	7.144	25/32	0.781	19.844
19/64	0.297	7.541	51/64	0.797	20.241
5/16	0.313	7.938	13/16	0.813	20.638
21/64	0.328	8.334	53/64	0.828	21.034
11/32	0.344	8.731	27/32	0.844	21.431
23/64	0.359	9.128	55/64	0.859	21.828
3/8	0.375	9.525	7/8	0.875	22.225
25/64	0.391	9.922	57/64	0.891	22.622
13/32	0.406	10.319	29/32	0.906	23.019
27/64	0.422	10.716	59/64	0.922	23.416
7/16	0.438	11.113	15/16	0.938	23.813
29/64	0.453	11.509	61/64	0.953	24.209
15/32	0.469	11.906	31/32	0.969	24.606
31/64	0.484	12.303	63/64	0.984	25.003
1/2	0.500	12.700	1	1.000	25.400

METRIC CONVERSION CHART

MILLIMETERS	INCHES	MILLIMETERS	INCHES	MILLIMETERS	INCHES
1	0.03937	10	0.39370	19	0.74803
2	0.07874	11	0.43307	20	0.78740
3	0.11811	12	0.47244	21	0.82677
4	0.15748	13	0.51181	22	0.86614
5	0.19685	14	0.55118	23	0.90551
6	0.23622	15	0.59055	24	0.94488
7	0.27559	16	0.62992	25	0.98425
8	0.31496	17	0.66929		
9	0.35433	18	0.70866		

HOW TO MEASURE EXTENDED & COLLAPSED LENGTHS OF SHOCK ABSORBERS

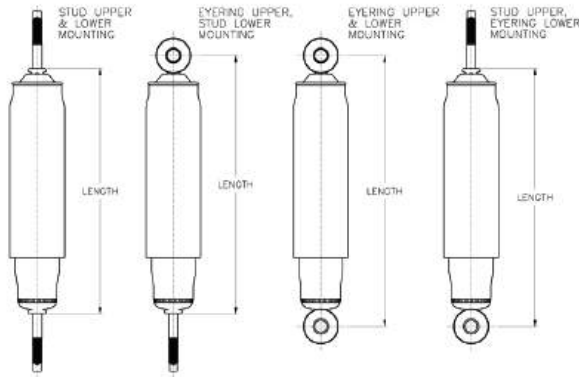

Instructions

1. Using the proper measuring points as shown above find the nearest replacement shock absorber from the listing increments of extended length.
2. Identify the proper mounting form the mounting codes and match these requirements by carefully measuring the mounting dimensions (top and bottom) of the shock absorber to be replaced.
3. Carefully take note of the following requirements:
 - a. **Mounting Accessories** - Contents and descriptions of parts are shown in this manual.
 - b. **Dust tubes** - This requirement should be noted in comparison with the shock absorber to be replaced. Shock absorber environment in its application makes this requirement necessary for piston rod protection and extended shock absorber life.
 - c. **Recoil Cutoff and Compression Bumper** - Carefully note these specifications- deviation of length requirements should not exceed $\pm\frac{1}{2}$ ". These shock absorber designs are footnoted for easy identification.
 - d. **Limited Environment Application** - Most conventional shock absorbers are offered in "straight" construction to fit limited environment applications. These shock absorber designs are footnoted.

SHOCK ABSORBER DIAMETERS

Shown below are measuring points for diameters by type of shock absorber. Refer to the chart below which lists diameters for the various bore sizes available for each type.

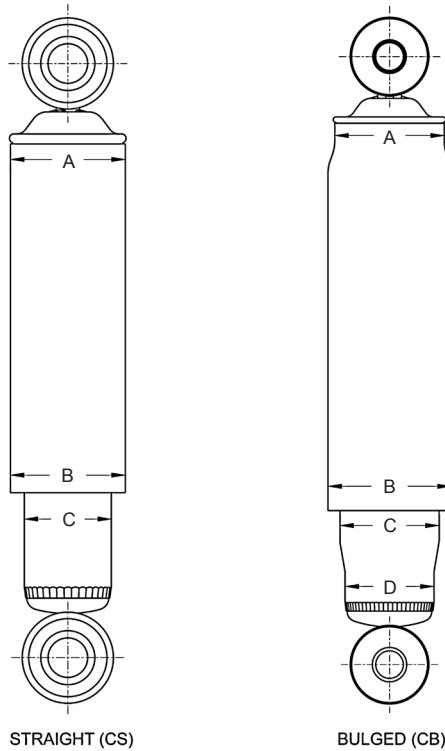

BORE SIZE	SHOCK ABSORBERS	TYPE (Shown Above)	Diameters			
			A	B	C	D
1 3/16"	Classic, Guardian, Ultra Pass. Car	CS	2.06	2.00	1.63	NA
1 3/16"	Classic, Guardian, Ultra Pass. Car	CB	2.06	2.19	1.81	1.63
1 3/8"	Ultra Truck	CS	NA	2.37	2.00	NA
1 3/8"	Ultra Truck	CB	2.37	2.50	2.19	2.00

EXTERNAL DIMENSIONS

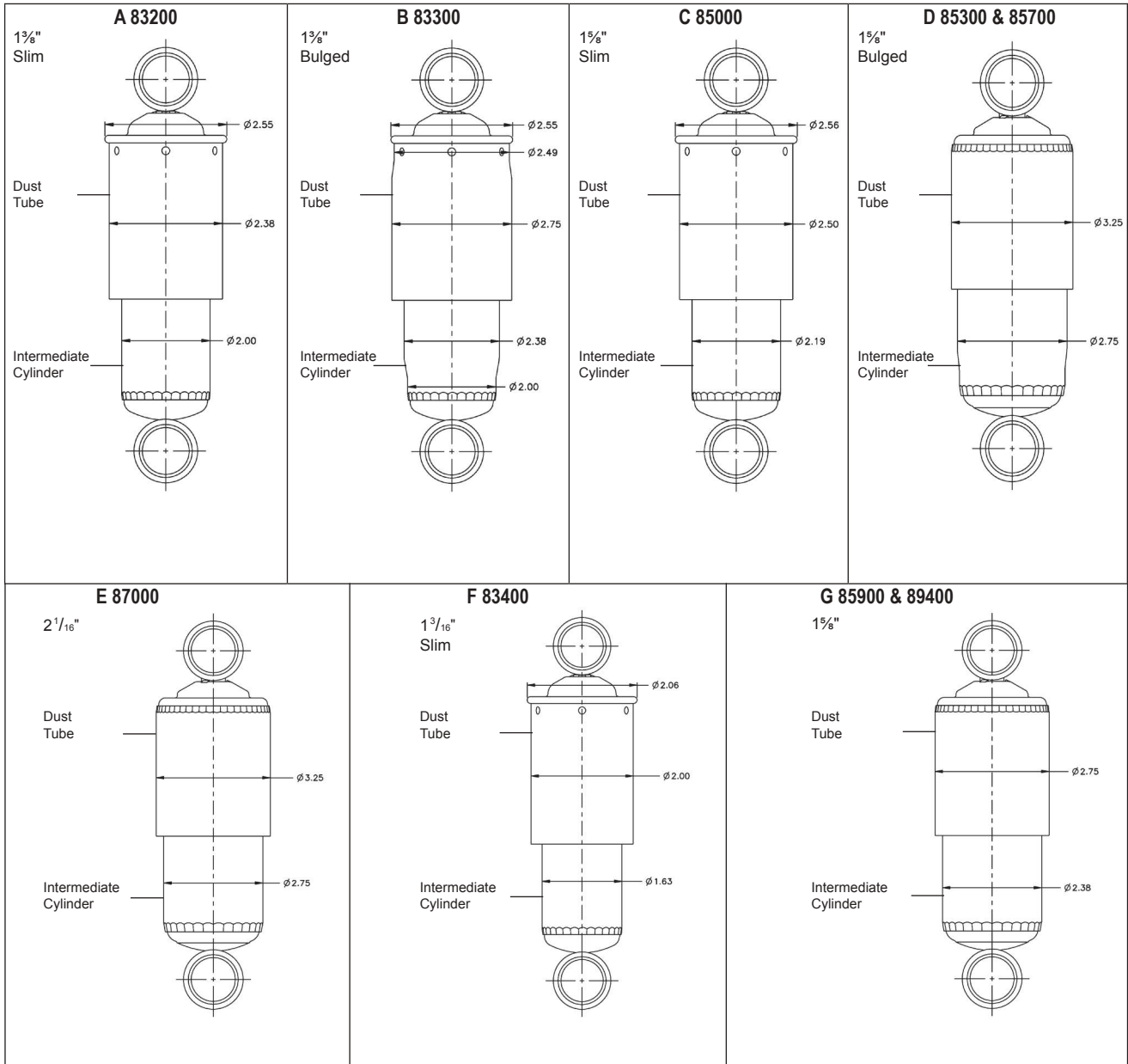

MOUNTING CODE "EB" EYE RING AND BUSHING

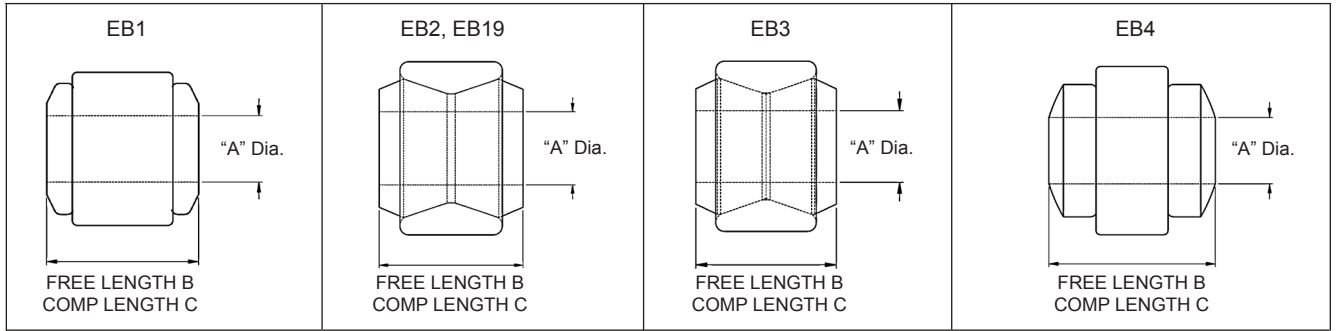

MOUNTING CODE	A DIAMETER	B FREE LENGTH	C COMP. LENGTH	VEHICLE MOUNTING PIN DIAMETER
EB1	5/8	1.44	1.31	5/8
EB2	3/4	1.75	1.50	3/4
EB3	1.00	1.91	1.75	1.00
EB4	11/16	1.72	1.55	11/16
EB18	19MM	1.65	--	19MM
EB19	20MM	1.75	1.25	20MM

"DS" & "S" STUD MOUNTS

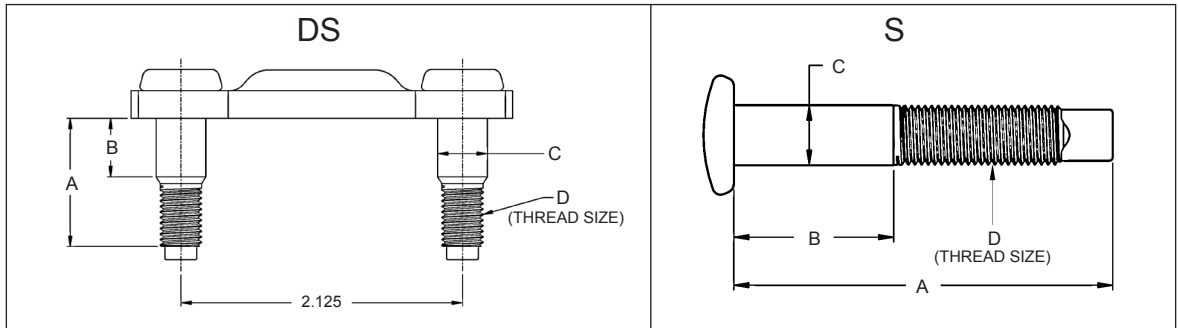

MOUNTING CODE	DIMENSION						
	A		B		C		D
	(inches)	(mm)	(inches)	(mm)	(inches)	(mm)	(thread)
DS1	1.27		.66		0.38		5/16-24
S1	2.37	60.20	1.00	25.40	0.38	9.53	3/8-24
S11	3.00	76.20	1.12	28.45	0.38	9.53	3/8-24
S12	2.37	60.20	1.15	29.21	0.44	11.11	3/8-24
S16	2.95	74.93	1.45	36.83	0.63	16.00	M16x1.5
S21	3.28	83.31	1.75	44.45	0.63	15.88	5/8-18
S29	2.99	75.95	1.87	47.50	0.38	9.53	3/8-24
S36	2.49	63.25	1.33	33.78	0.44	11.11	3/8-24
S38	2.75	69.85	1.70	43.18	0.55	14.00	M12x1.25
S40	2.52	64.01	1.33	33.78	0.44	11.11	3/8-24
S42	3.50	88.90	2.00	50.80	0.63	15.88	5/8-18
S43	2.75	69.85	1.25	31.75	0.63	15.88	5/8-18
S47	2.20	55.88	1.31	33.27	0.39	10.00	M10x1.25
S61	3.11	78.99	1.45	36.83	0.55	14.00	M12x1.25
S62	3.24	82.30	1.70	43.18	0.56	14.29	M12x1.25
S68	2.95	74.93	1.45	36.83	0.63	15.88	M16x1.5
S92	1.42	36.07	0.63	16.00	0.41	10.41	M12x1.25

MOUNTING CODE "BP" EYE RING AND BUSHING WITH BAR PIN

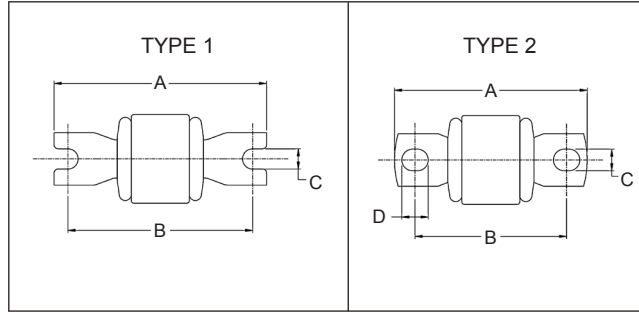

MOUNTING CODE	TYPE	DIMENSION									
		A		B		C		D		E	
		(inches)	(mm)	(inches)	(mm)	(inches)	(mm)	(inches)	(mm)	(inches)	(mm)
BP4	1	3.19	81.03	2.38	60.45	0.33	8.38	--	--	--	--
BP6	1	4.25	107.95	3.62	91.95	0.33	8.38	--	--	--	--
BP7	2	3.13	79.50	2.50	63.50	0.35	8.89	0.42	10.67	--	--
BP8	2	3.50	88.90	2.87	72.90	0.35	8.89	0.42	10.67	--	--
BP9	1	3.38	85.85	2.6	66.04	0.35	8.89	0.42	10.67	--	--
BP11	1	2.96	75.18	2.52	64.01	0.33	8.38	--	--	--	--
BP13	1	3.45	87.63	3.00	76.20	0.33	8.38	--	--	--	--
BP14	2	3.43	87.12	2.87	72.90	0.45	11.43	--	--	--	--
BP27	2	4.00	101.60	2.95	74.93	0.52	13.21	0.50	12.70	--	--
BP38	2	3.22	81.79	1.54	39.12	0.40	10.16	0.40	10.16	--	--

MOUNTING CODE "ES" EYE RING AND BUSHING WITH STEEL SLEEVE

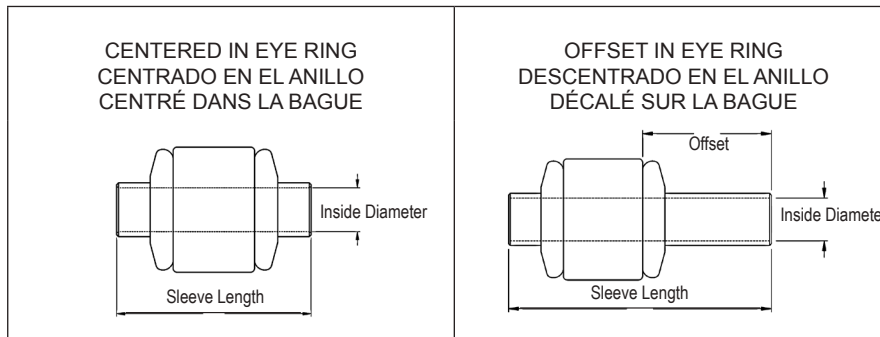

MOUNTING CODE	DIMENSION			
	Inside Diameter		Sleeve Length	
	(inches)	(mm)	(inches)	(mm)
ES3	0.39	10.00	1.56	39.62
ES7	0.56	14.29	1.25	31.75
ES10	0.44	11.11	1.38	35.05
ES13	0.56	14.29	1.89	48.01
ES19	0.47	12.00	1.88	47.75
ES24	0.50	12.70	1.38	35.05
ES25	0.50	12.70	1.50	38.10
ES26	0.50	12.70	1.56	39.62
ES27	0.50	12.70	1.62	41.15
ES31*	0.50	12.70	2.25	57.15
ES34	0.56	14.29	1.66	42.16
ES35	0.63	15.88	1.38	35.05
ES36	0.75	19.05	1.75	44.45
ES38	0.44	11.17	2.18	55.37
ES41	0.47	12.00	3.48	88.39
ES45	0.51	13.00	1.68	42.67
ES48	0.55	13.97	1.42	36.07

MOUNTING CODE	DIMENSION			
	Inside Diameter		Sleeve Length	
	(inches)	(mm)	(inches)	(mm)
ES48	0.55	13.97	1.66	42.16
ES56	0.55	14.00	1.58	40.13
ES60	0.55	14.00	1.26	32.00
ES64	0.63	16.00	1.25	31.75
ES65	0.47	12.00	1.38	35.05
ES77	0.79	20.07	1.48	37.59
ES83	0.47	12.00	1.48	37.59
ES87	0.48	12.30	1.65	41.91
ES90	0.63	15.88	2.00	50.80
ES120	0.75	19.05	2.76	70.10
ES126	0.50	12.70	2.44	61.98
ES128	0.50	12.70	1.66	42.16
ES136	0.63	15.88	1.75	44.45
ES141	0.47	12.00	1.61	40.89
ES149	0.50	12.70	2.36	59.94
ES150	0.75	19.05	2.24	56.90
ES153	0.55	14.00	1.55	39.37

MOUNTING CODE "ES" EYE RING AND BUSHING WITH STEEL SLEEVE (CONTINUED)

MOUNTING CODE	DIMENSION			
	Inside Diameter		Sleeve Length	
	(inches)	(mm)	(inches)	(mm)
ES158	0.75	19.05	3.80	96.52
ES159**	0.75	19.05	3.21	81.53
ES160	1.00	25.40	2.01	51.05
ES161	0.63	16.00	3.95	100.33
ES162	0.63	16.00	2.60	66.04
ES163	0.44	11.11	2.50	63.50
ES164	0.50	12.70	2.26	57.40
ES165	0.50	12.70	1.75	44.45
ES171	0.50	12.70	1.88	47.75
ES172	0.50	12.70	2.72	69.09
ES174	0.63	15.88	3.25	82.55
ES175	0.63	16.00	1.96	49.78
ES176	0.63	16.00	3.72	94.49

MOUNTING CODE	DIMENSION			
	Inside Diameter		Sleeve Length	
	(inches)	(mm)	(inches)	(mm)
ES177	0.63	16.00	3.55	90.17
ES178	0.75	19.05	1.96	49.78
ES179	0.79	20.00	1.75	44.45
ES183	0.79	20.00	3.80	96.52
ES184	0.79	20.00	1.75	44.45
ES185	0.47	12.00	2.44	61.98
ES190	0.87	22.00	1.75	44.45
ES194	0.88	22.23	2.28	57.91
ES204	0.57	14.50	1.68	42.67
ES210	0.73	18.50	1.87	47.50
ES216	0.57	14.50	3.15	80.00

MOUNTING CODE "CL" CLEVIS

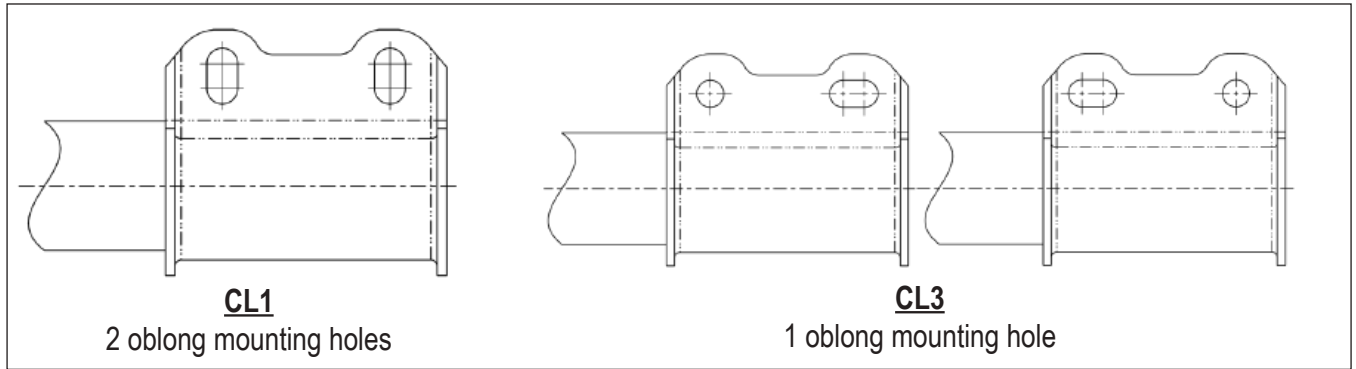

MOUNTING CODE "LP" PINCH SOCKET

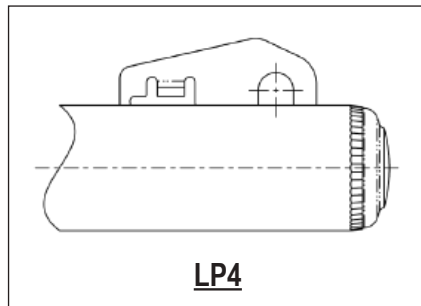

MOUNTING CODE "LU" U JOINT

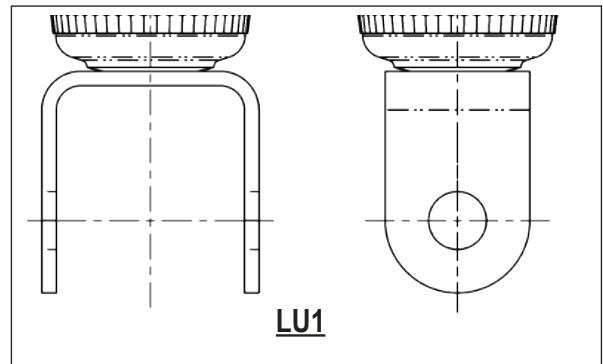

MOUNTING CODE "TM" TOP MOUNT

TM###

1st & 2nd digit - "Top Mount"

3rd digit - Part type/shape from the five categories listed below

4th digit - Number of studs / bolts (the amount of mounting points to the vehicle (see example below)

5th digit - Design of the mounting point - Stud (S) Bolt (B) Clip (C) (see example below)

TOP MOUNT DESIGN SHAPES



Triangle



Square



Circle



Oval



Unique

EXAMPLES

The fourth digit will note how many mounting points to the vehicle body exist.
The final digits indicate the type of mounting point **Stud (S) Bolt (B) Clip (C)**
(a combination is used for multiple mounting points)



3S

3 mounting points
stud type



2C

2 mounting points
clip type



4S

4 mounting points
stud type



2S2B

2 mounting points, stud type
2 mounting points, bolt type

TOP MOUNT CODE	TOP MOUNT DESIGN	MOUNTING TYPE
TMR4S	Rectangle	4 Stud
TMT3S	Triangle	3 Stud
TMU2B	Unique	2 bolt
TMU2B1S	Unique	2 Bolt, 1 Stud

SPECIFICATIONS BY END MOUNT
ESPECIFICACIONES POR TIPO DE MONTAJE
SPÉCIFICATIONS PAR FIXATION DES EXTRÉMITÉS

Gabriel	Mounting		Lengths			Dust Tube	Recoil Cutoff	Controls*	
	Upper	Lower	Extended	Collapsed	Stroke			Rebound	Compression
82012	BP6	ES25	16.04	10.53	5.51				
43180	BP8	ES34	23.55	14.19	9.36				
43163	BP14	ES34	25.05	15.69	9.36				
49218	BP14	ES34	26.34	16.36	9.98				
49231	BP14	ES34	24.27	14.79	9.48				
58488	BP14	ES34	26.69	16.02	10.63				
58638	BP14	ES34	23.87	14.49	9.38				
61543	BP14	ES34	26.76	16.23	10.53				
61565	BP14	ES34	24.26	14.73	9.53				
61687	BP14	ES34	23.87	14.68	9.19				
77488	BP14	ES34	26.77	16.26	10.51				
77607	BP14	ES83	25.39	15.18	10.21				
77638	BP14	ES34	24.31	14.78	9.53				
77837	BP14	ES83	28.73	16.92	11.81				
81667	BP14	ES34	26.95	16.19	10.76				
G63488	BP14	ES34	26.61	16.33	10.28				
G63607	BP14	ES83	25.58	15.3	10.28				
G63638	BP14	ES34	24.33	14.8	9.53				
G63837	BP14	ES83	28.23	17.95	10.28				
G63896	BP14	ES34	22.36	13.92	8.44				
G63897	BP14	ES34	23.87	14.68	9.19				
14017	EB1	EB1	24.04	14.43	9.61				
34036	EB1	ES24	14.16	9.53	4.63				
43048	EB1	EB1	20.45	12.62	7.83				
43058	EB1	ES25	19.95	12.37	7.58				
43167	EB1	ES83	22.99	13.88	9.11				
49127	EB1	ES25	19.87	12.63	7.24				
49155	EB1	ES34	23.27	14.29	8.98				
49310	EB1	EB1	20.35	12.75	7.60				
49311	EB1	EB1	22.44	14	8.44				
58808	EB1	ES83	28.38	16.75	11.63				
58809	EB1	ES83	23.65	14.53	9.12				
58810	EB1	ES83	31.42	18.42	13.00				
61500	EB1	EB1	20.23	12.37	7.86				
61506	EB1	EB1	21.86	13.58	8.28				
61519	EB1	ES25	19.98	12.45	7.53				
61524	EB1	ES34	23.26	14.23	9.03				

* Damping force, in pounds, to either extend or collapse the shock absorber at an average operating velocity. Fuerza de amortiguación en libras para extender o comprimir el amortiguador a una velocidad de operación promedio. La puissance d'amortissement en poids de l'amortisseur, soit comprimé, doit détendu, à une vitesse de fonctionnement moyenne.

SPECIFICATIONS BY END MOUNT
ESPECIFICACIONES POR TIPO DE MONTAJE
SPÉCIFICATIONS PAR FIXATION DES EXTRÉMITÉS

Gabriel	Mounting		Lengths			Dust Tube	Recoil Cutoff	Controls*	
	Upper	Lower	Extended	Collapsed	Stroke			Rebound	Compression
61525	EB1	ES24	15.01	9.95	5.06				
61530	EB1	ES83	25.48	15.2	10.28				
61547	EB1	ES83	23.01	14.07	8.94				
61554	EB1	ES83	21.48	13.2	8.28				
61654	EB1	ES83	28.76	16.98	11.78				
61682	EB1	ES83	31.36	18.67	12.69				
61713	EB1	ES83	26.94	16	10.94				
77461	EB1	ES83	25.39	15.18	10.21				
77808	EB1	ES83	28.73	16.92	11.81				
77809	EB1	ES83	22.92	13.9	9.02				
77810	EB1	ES83	31.53	18.5	13.03				
77907	EB1	EB1	19.87	12.23	7.64				
77952	EB1	ES83	29.68	17.43	12.25				
77968	EB1	ES83	24.71	15.09	9.62				
77969	EB1	ES83	25.43	15.81	9.62				
77986	EB1	ES48	31.01	18.65	12.36				
77987	EB1	ES48	27.24	16.38	10.86				
77988	EB1	ES56	30.12	17.97	12.14				
81039	EB1	ES24	14.73	9.62	5.11				
81082	EB1	ES83	23.23	13.87	9.36				
81147	EB1	EB1	20.23	12.37	7.86				
81164	EB1	ES34	23.23	13.87	9.36				
81318	EB1	EB1	22.73	13.87	8.86				
81484	EB1	ES25	20.23	12.37	7.86				
81510	EB1	ES83	25.73	15.12	10.61				
81676	EB1	EB1	17.73	11.12	6.61				
81710	EB1	ES185	21.73	13.12	8.61				
82007	EB1	EB1	18.23	11.37	6.86				
82047	EB1	EB1	20.23	12.37	7.86				
82147	EB1	ES25	23.23	13.87	9.36				
82156	EB1	EB1	20.23	12.37	7.86				
6804SE	EB1	EB1	24.08	14.67	9.41				
6828SE	EB1	EB1	21.23	12.87	8.36				
6847SE	EB1	ES65	23	13.83	9.17				
6850SE	EB1	S1	23.3	13.77	9.53				
6853SE	EB1	ES24	19.33	12.05	7.28				
6854SE	EB1	EB1	23.03	14.27	8.76				

* Damping force, in pounds, to either extend or collapse the shock absorber at an average operating velocity. Fuerza de amortiguación en libras para extender o comprimir el amortiguador a una velocidad de operación promedio. La puissance d'amortissement en poids de l'amortisseur, soit comprimé, doit détendu, à une vitesse de fonctionnement moyenne.

SPECIFICATIONS BY END MOUNT
ESPECIFICACIONES POR TIPO DE MONTAJE
SPÉCIFICATIONS PAR FIXATION DES EXTRÉMITÉS

Gabriel	Mounting		Lengths			Dust Tube	Recoil Cutoff	Controls*	
	Upper	Lower	Extended	Collapsed	Stroke			Rebound	Compression
6855SE	EB1	EB1	23.83	14.3	9.53				
G63299	EB1	EB1	18.08	11.55	6.53				
G63349	EB1	ES34	23.33	14.3	9.03				
G63355	EB1	ES24	14.98	9.95	5.03				
G63377	EB1	ES25	20.08	12.55	7.53				
G63394	EB1	ES24	16.01	10.48	5.53				
G63405	EB1	EB1	20.01	12.48	7.53				
G63409	EB1	ES185	21.48	13.2	8.28				
G63419	EB1	EB1	24.08	14.55	9.53				
G63456	EB1	ES83	26.85	16.07	10.78				
G63461	EB1	ES83	25.51	15.23	10.28				
G63492	EB1	EB1	22.58	13.8	8.78				
G63604	EB1	ES142	19.74	12.46	7.28				
G63625	EB1	ES24	22.56	13.78	8.78				
G63692	EB1	EB1	27.58	16.3	11.28				
G63808	EB1	ES83	28.86	17.08	11.78				
G63809	EB1	ES83	22.98	13.95	9.03				
G63810	EB1	ES185	31.6	18.57	13.03				
G63888	EB1	ES83	31.36	18.67	12.69				
G63907	EB1	EB1	20.23	12.37	7.86				
G64010	EB1	ES83	26.94	16	10.94				
G64268	EB1	ES56	31.34	18.70	12.64				
G64269	EB1	ES56	26.93	16.04	10.89				
83159	EB2	EB2	21.85	13.56	8.29	YES	NO	658	149
83216	EB2	EB2	23.51	14.48	9.03	YES	YES	776	262
83308	EB2	EB2	25.14	15.36	9.78	YES	YES	445	180
83312	EB2	EB2	26.64	16.11	10.53	YES	YES	527	152
83519	EB2	EB2	23.83	14.35	9.48	YES	NO	292	132
85012	EB2	EB2	21.02	13.23	7.79	YES	NO	523	199
89409	EB2	EB2	27.13	16.92	10.2	YES	YES	567‡	165
89413	EB2	EB2	20.94	13.53	7.41	YES	NO	536‡	201
83140	EB3	EB3	25.28	15.53	9.75	YES	NO	738	88
83141	EB3	EB3	25.27	15.52	9.75	YES	NO	408	113
83215	EB3	EB3	26.64	16.36	10.28	YES	YES	697	108
83225	EB3	EB3	24.14	15.11	9.03	YES	YES	482	159
85001	EB3	EB3	26.3	16.39	9.92	YES	NO	1202	186
85007	EB3	EB3	24.33	15.4	8.93	YES	YES	1008	171

* Damping force, in pounds, to either extend or collapse the shock absorber at an average operating velocity. Fuerza de amortiguación en libras para extender o comprimir el amortiguador a una velocidad de operación promedio. La puissance d'amortissement en poids de l'amortisseur, soit comprimé, doit détendu, à une vitesse de fonctionnement moyenne.

SPECIFICATIONS BY END MOUNT
ESPECIFICACIONES POR TIPO DE MONTAJE
SPÉCIFICATIONS PAR FIXATION DES EXTRÉMITÉS

Gabriel	Mounting		Lengths			Dust Tube	Recoil Cutoff	Controls*	
	Upper	Lower	Extended	Collapsed	Stroke			Rebound	Compression
85712	EB3	EB3	20.5	13.47	7.04	YES	YES	1435	562
85723	EB3	S21	19.93	12.9	7.03	YES	YES	1318	248
85734	EB3	EB3	20.73	13.7	7.03	YES	YES	1288	227
89410	EB3	EB3	26.34	16.57	9.77	YES	NO	1185‡	182
43085	EB4	ES27	20.61	12.78	n/a				
61632	EB4	EB4	20.79	13.01	7.78				
81825	EB4	EB4	21.1	12.99	8.11				
82065	EB4	EB4	19.04	11.93	7.11				
G63183	EB4	EB4	20.79	13.01	7.78				
43111	EB7	ES34	22.9	13.82	9.08				
83021	ES10	ES10	9.41	7.4	2.01	YES	YES	745	315
G64042	ES18	ES18	14.92	10.55	4.37				
49107	ES24	ES24	19.27	12.29	6.98				
49162	ES24	ES24	20.02	12.79	7.23				
58357	ES24	ES24	14.68	10.06	4.62				
61517	ES24	ES24	14.98	9.95	5.03				
82003	ES24	ES24	18.55	11.44	7.11				
82035	ES24	EB1	14.64	9.53	5.11				
G63306	ES24	ES24	19.85	12.57	7.28				
G63357	ES24	ES24	14.98	9.95	5.03				
58403	ES26	ES26	24.48	14.95	9.53				
77403	ES26	ES26	24.31	14.78	9.53				
G63403	ES26	ES26	24.58	14.8	9.78				
G63671	ES26	ES26	22.48	13.7	8.78				
49149	ES27	EB4	24.93	15.64	9.29				
49212	ES27	ES27	21.02	13.29	7.73				
61522	ES27	ES27	20.49	12.63	7.86				
81091	ES27	EB4	25.14	15.28	9.86				
81342	ES27	EB4	28.89	16.78	12.11				
81496	ES27	ES27	20.49	12.63	7.86				
G63353	ES27	EB4	24.74	14.96	9.78				
G63413	ES27	ES27	20.76	12.98	7.78				
61516	ES31	ES24	18.23	11.37	6.86				
81113	ES31	ES24	18.23	11.37	6.86				
G63347	ES31	ES24	18.08	11.55	6.53				
G63411	ES31	ES26	18.58	11.8	6.78				
43181	ES34	ES34	24.24	14.88	9.36				

* Damping force, in pounds, to either extend or collapse the shock absorber at an average operating velocity. Fuerza de amortiguación en libras para extender o comprimir el amortiguador a una velocidad de operación promedio. La puissance d'amortissement en poids de l'amortisseur, soit comprimé, soit détendu, à une vitesse de fonctionnement moyenne.

SPECIFICATIONS BY END MOUNT
ESPECIFICACIONES POR TIPO DE MONTAJE
SPÉCIFICATIONS PAR FIXATION DES EXTRÉMITÉS

Gabriel	Mounting		Lengths			Dust Tube	Recoil Cutoff	Controls*	
	Upper	Lower	Extended	Collapsed	Stroke			Rebound	Compression
49235	ES34	ES34	24.77	15.04	9.73				
58412	ES34	ES34	26.68	16.18	10.50				
58662	ES34	ES34	24.68	15.36	9.32				
58930	ES34	ES34	22.81	14.06	8.75				
61600	ES34	ES34	24.51	14.98	9.53				
61642	ES34	ES34	26.76	15.98	10.78				
61710	ES34	ES34	27.58	17.14	10.44				
61716	ES34	ES34	26.5	16.33	10.17				
77412	ES34	ES34	26.77	16.26	10.51				
77662	ES34	ES34	24.31	14.78	9.53				
77675	ES34	ES34	26.25	15.74	10.51				
77950	ES34	ES34	27.5	17.5	10.00				
77976	ES34	ES34	24.84	16.07	8.76				
81873	ES34	ES34	24.74	14.88	9.86				
81921	ES34	ES34	26.76	15.67	11.09				
G63366	ES34	ES34	23.26	14.23	9.03				
G63662	ES34	ES34	24.58	15.05	9.53				
G63675	ES34	ES34	26.86	16.08	10.78				
G63918	ES34	ES141	21.25	13.56	7.69				
G63971	ES34	ES34	27.58	17.14	10.44				
G64013	ES34	ES34	26.52	16.33	10.19				
G64121	ES34	ES34	25.35	16.17	9.18				
82086	ES35	ES35	25.54	14.93	10.61				
83122	ES36	ES36	25.28	15.79	9.49	YES	YES	661	201
83123	ES36	ES36	26.65	16.41	10.24	YES	YES	589	119
83124	ES36	ES36	21.65	13.77	7.88	YES	YES	750	137
83126	ES36	ES36	24.41	15.27	9.14	YES	YES	625	115
83127	ES36	ES36	20.16	13.14	7.01	YES	YES	940	218
83137	ES36	ES36	30.04	17.79	12.25	YES	YES	517	132
83157	ES36	ES90	26.38	15.76	10.61	YES	NO	446	303
83164	ES36	ES165	24.22	14.59	9.63	YES	NO	426	274
83209	ES36	ES36	29.64	17.61	12.03	YES	YES	670	78
83221	ES36	ES36	24.01	14.73	9.28	YES	YES	599	153
85005	ES36	ES36	24.76	15.24	9.52	YES	YES	1019	219
85006	ES36	ES36	28.54	17.13	11.41	YES	YES	1019	219
85010	ES36	ES36	26.8	16.26	10.54	YES	YES	1019	219
85013	ES36	ES36	29.79	17.76	12.04	YES	YES	1019	219

* Damping force, in pounds, to either extend or collapse the shock absorber at an average operating velocity. Fuerza de amortiguación en libras para extender o comprimir el amortiguador a una velocidad de operación promedio. La puissance d'amortissement en poids de l'amortisseur, soit comprimé, doit détendu, à une vitesse de fonctionnement moyenne.

SPECIFICATIONS BY END MOUNT
ESPECIFICACIONES POR TIPO DE MONTAJE
SPÉCIFICATIONS PAR FIXATION DES EXTRÉMITÉS

Gabriel	Mounting		Lengths			Dust Tube	Recoil Cutoff	Controls*	
	Upper	Lower	Extended	Collapsed	Stroke			Rebound	Compression
85029	ES36	ES36	20.54	13.11	7.43	YES	YES	1019	219
85043	ES36	ES36	27.63	16.85	10.78	YES	YES	628	163
85058	ES36	ES36	22.67	14.26	8.41	YES	YES	722	114
85072	ES36	ES176	24.17	14.81	9.36	YES	YES	1387	305
85919	ES36	ES36	22.52	14.33	8.19	YES	YES	1265	121
85976	ES36	ES36	29.92	18.12	11.8	YES	YES	582	138
89405	ES36	ES36	26.3	16.57	9.73	YES	YES	1009‡	249
89406	ES36	ES36	24.76	15.82	8.93	YES	YES	658‡	125
89407	ES36	ES36	21.61	14.17	7.45	YES	YES	652‡	218
89414	ES36	ES36	29.65	18.18	11.46	YES	YES	1045‡	217
89430	ES36	ES36	24.61	15.66	8.94	YES	YES	1462‡	279
89431	ES36	ES36	22.41	14.16	8.25	YES	NO	751‡	211
61614	ES41	ES41	22.98	13.95	9.03				
G64089	ES56	ES56	20.43	13.03	7.4				
14072	ES83	EB18	28.22	16.49	11.73				
77455	ES83	ES83	22.92	13.9	9.02				
81821	ES83	ES83	23.23	13.87	9.36				
G63455	ES83	ES83	22.98	13.95	9.03				
83101	ES90	ES90	24.63	15.13	9.49	YES	YES	481	142
83135	ES90	ES90	19.49	12.38	7.11	YES	NO	519	121
83169	ES90	ES90	18.55	11.91	6.64	YES	NO	599	171
83180	ES90	ES83	30.2	21.24	8.96	YES	NO	909	204
83364	ES90	ES83	24.06	15.07	8.99	YES	YES	855	206
85082	ES90	ES90	28.6	20.64	7.97	YES	YES	1435	266
85656	ES90	ES90	26.49	16.94	10.75	YES	YES	1225	274
85928	ES90	ES90	20.31	13.24	7.07	YES	NO	957	229
85957	ES90	ES90	20.78	13.19	7.6	YES	NO	1583	138
83120	ES120	S21	22.17	13.66	8.51	YES	YES	779	164
83154	ES120	S21	20.78	12.72	8.06	YES	YES	599	140
58609	ES126	ES45	16.49	11.05	5.44				
61542	ES126	ES128	16.73	10.95	5.78				
77609	ES126	ES128	16.43	10.95	5.48				
81726	ES126	ES128	16.48	10.87	5.61				
G63609	ES126	ES128	16.5	10.97	5.53				
83160	ES128	ES36	24.31	14.9	9.37	YES	YES	920	161
85650	ES136	ES34	24.88	16.35	8.53	YES	NO	941	463
83006	ES149	EB1	10.71	8.52	2.78	YES	YES	525	182

* Damping force, in pounds, to either extend or collapse the shock absorber at an average operating velocity. Fuerza de amortiguación en libras para extender o comprimir el amortiguador a una velocidad de operación promedio. La puissance d'amortissement en poids de l'amortisseur, soit comprimé, doit détendu, à une vitesse de fonctionnement moyenne.

SPECIFICATIONS BY END MOUNT
ESPECIFICACIONES POR TIPO DE MONTAJE
SPÉCIFICATIONS PAR FIXATION DES EXTRÉMITÉS

Gabriel	Mounting		Lengths			Dust Tube	Recoil Cutoff	Controls*	
	Upper	Lower	Extended	Collapsed	Stroke			Rebound	Compression
85106	ES150	ES150	20.03	12.89	7.14	YES	YES	1054	109
85918	ES150	ES150	22.97	14.58	8.39	YES	NO	1726	412
85920	ES150	ES150	21.16	13.57	7.59	YES	NO	845	49
85958	ES150	ES150	22.89	14.5	8.39	YES	YES	1926	281
85959	ES150	ES150	21.16	13.57	7.59	YES	YES	1021	123
89449	ES150	ES150	23.25	14.9	8.35	YES	NO	1519‡	324
89503	ES150	ES150	21.28	13.72	7.56	YES	NO	1033‡	123
83066	ES153	ES153	11.15	9.2	2.78	YES	YES	599	221
85125	ES158	ES159	26.9	16.64	10.26	YES	YES	1479	183
85331	ES158	ES159	19.62	12.85	6.77	YES	YES	1757	396
85335	ES158	ES159	19.62	12.85	6.77	YES	YES	827	107
85724	ES158	ES159	22.81	14.51	8.3	YES	YES	1235	454
89443	ES158	ES159	22.19	14.66	7.53	YES	YES	1206‡	466
85188	ES161	ES162	25.31	15.52	9.79	YES	YES	1074	255
83142	ES162	S42	23.92	14.49	9.43	YES	YES	367	131
83143	ES162	S42	21.92	13.51	8.41	YES	YES	403	137
83025	ES163	ES163	8.02	6.53	1.48	YES	YES	710	230
83040	ES171	ES172	10.44	8.4	3	YES	YES	876	326
85084	ES174	ES136	20.59	13.03	7.57	YES	NO	1145	407
85989	ES174	ES136	20.78	13.15	7.63	YES	NO	1812	351
89460	ES174	ES136	20.58	13.03	7.55	YES	NO	997‡	384
83163	ES175	ES175	20.75	13.01	7.74	YES	NO	828	98
83243	ES175	ES175	24.41	15.26	9.15	YES	YES	296	170
83397	ES175	ES175	18.67	11.91	6.76	YES	NO	303	101
83398	ES175	ES175	23.23	15.38	7.85	YES	YES	293	168
85670	ES175	ES175	23.19	14.67	8.52	YES	YES	591	176
85031	ES176	EB2	25.63	15.87	9.76	YES	NO	941	257
85642	ES177	ES90	22.52	14.52	8	YES	YES	1920	309
85923	ES177	ES161	22.52	14.52	8	YES	YES	1940	221
89458	ES177	ES161	22.48	14.6	7.88	YES	YES	1575‡	222
85932	ES178	ES150	21.26	13.7	7.56	YES	YES	1102	430
89453	ES178	ES150	21.14	13.93	7.21	YES	YES	860‡	435
83166	ES179	ES179	25.28	15.78	9.49	YES	YES	622	132
85956	ES183	ES184	30.65	18.77	11.88	YES	YES	979	373
61655	ES185	ES185	23.01	14.07	8.94				
61656	ES185	ES185	31.51	18.48	13.03				
83054	ES185	ES185	10.28	7.56	2.72	YES	YES	1004	184
83391	ES190	ES190	25.52	15.61	9.91	YES	NO	590	105

* Damping force, in pounds, to either extend or collapse the shock absorber at an average operating velocity. Fuerza de amortiguación en libras para extender o comprimir el amortiguador a una velocidad de operación promedio. La puissance d'amortissement en poids de l'amortisseur, soit comprimé, doit détendu, à une vitesse de fonctionnement moyenne.

SPECIFICATIONS BY END MOUNT
ESPECIFICACIONES POR TIPO DE MONTAJE
SPÉCIFICATIONS PAR FIXATION DES EXTRÉMITÉS

Gabriel	Mounting		Lengths			Dust Tube	Recoil Cutoff	Controls*	
	Upper	Lower	Extended	Collapsed	Stroke			Rebound	Compression
G64164	ES210	ES13	19.95	12.81	7.14				
G64177	ES216	ES19	25.86	16.1	9.76				
G64148	LU1	DS1	18.39	14.09	4.3				
34052	S1	BP13	13.62	9	4.62				
34073	S1	BP7	14.29	9.37	4.92				
43099	S1	ES25	19.17	11.77	7.40				
43140	S1	EB1	20.92	12.84	8.08				
49173	S1	ES25	19.24	12.01	7.23				
49178	S1	ES25	23.12	13.89	9.23				
49203	S1	EB1	20.24	12.51	7.73				
49205	S1	EB1	21.12	13.13	7.99				
58359	S1	BP13	13.92	9.14	4.78				
61518	S1	ES25	18.73	11.7	7.03				
61523	S1	BP13	13.7	8.92	4.78				
61529	S1	BP4	14.1	9.34	4.76				
61546	S1	EB1	18.45	11.67	6.78				
61556	S1	BP7	14.2	9.09	5.11				
81096	S1	BP13	13.7	8.84	4.86				
81242	S1	ES25	19.2	11.59	7.61				
81270	S1	S1	17.67	10.56	7.11				
81340	S1	EB1	20.7	12.34	8.36				
81495	S1	EB1	20.2	12.34	7.86				
81834	S1	BP13	15.7	9.84	5.86				
82026	S1	S1	13.42	8.56	4.86				
82034	S1	S1	22.17	12.81	9.36				
82066	S1	EB1	22.7	13.34	9.36				
82155	S1	EB1	20.7	12.34	8.36				
83515	S1	EB2	23.34	13.89	9.45	YES	NO	643	205
83518	S1	EB2	24.4	14.26	10.14	YES	NO	153	82
6802SE	S1	S1	20.02	12.11	7.91				
6803SE	S1	S1	22.52	13.36	9.16				
6856SE	S1	EB1	27.3	15.77	11.53				
6861SE	S1	S1	20.27	11.99	8.28				
G63350	S1	ES25	18.82	11.79	7.03				
G63359	S1	BP13	13.7	8.92	4.78				
G63360	S1	BP13	15.7	9.92	5.78				
G63387	S1	ES25	23.32	14.04	9.28				

* Damping force, in pounds, to either extend or collapse the shock absorber at an average operating velocity. Fuerza de amortiguación en libras para extender o comprimir el amortiguador a una velocidad de operación promedio. La puissance d'amortissement en poids de l'amortisseur, soit comprimé, doit détendu, à une vitesse de fonctionnement moyenne.

SPECIFICATIONS BY END MOUNT
ESPECIFICACIONES POR TIPO DE MONTAJE
SPÉCIFICATIONS PAR FIXATION DES EXTRÉMITÉS

Gabriel	Mounting		Lengths			Dust Tube	Recoil Cutoff	Controls*	
	Upper	Lower	Extended	Collapsed	Stroke			Rebound	Compression
G63418	S1	BP11	13.95	9.17	4.78				
G63950	S1	BP7	14.2	9.09	5.11				
61683	S11	LU1	15.07	10.44	4.63				
61684	S11	BP9	12.82	8.88	3.94				
61685	S11	BP9	14.12	9.68	4.44				
G63893	S11	LU1	15.07	10.44	4.63				
G63894	S11	BP9	12.82	8.88	3.94				
G63895	S11	BP9	14.12	9.68	4.44				
34058	S12	ES3	17.13	11.01	n/a				
49237	S12	ES171	24.18	14.45	9.73				
58817	S12	ES60	15.59	10.96	4.63				
61521	S12	ES25	16.45	10.67	5.78				
61555	S12	BP7	14.14	9.11	5.03				
61612	S12	ES171	28.39	16.36	12.03				
61638	S12	ES171	24.45	14.42	10.03				
61641	S12	BP11	14.7	10.17	4.53				
61663	S12	ES60	15.7	10.92	4.78				
77375	S12	BP7	14.14	9.04	5.10				
77661	S12	ES34	13.72	9.5	4.22				
77715	S12	ES171	28.32	16.33	11.99				
77783	S12	BP11	14.64	10.12	4.52				
77817	S12	ES60	15.73	10.94	4.79				
81490	S12	ES83	14.85	9.84	5.01				
81892	S12	ES171	24.2	14.09	10.11				
81913	S12	ES171	28.39	16.28	12.11				
81920	S12	BP11	14.71	10.1	4.61				
81925	S12	ES7	14.7	9.59	5.11				
G63375	S12	BP7	14.14	9.11	5.03				
G63410	S12	EB1	18.55	11.77	6.78				
G63715	S12	ES171	28.55	16.52	12.03				
G63778	S12	ES171	24.55	14.52	10.03				
G63783	S12	BP11	14.59	10.21	4.38				
G63817	S12	ES60	15.8	11.02	4.78				
83317	S16	ES90	27.03	16	11.34	YES	YES		
83613	S16	S16	21.04	12.76	8.28	YES	YES	601	242
83103	S21	S21	19.66	11.93	7.74	YES	YES	517	301
83134	S21	ES36	22.27	13.51	8.77	YES	NO	430	49

* Damping force, in pounds, to either extend or collapse the shock absorber at an average operating velocity. Fuerza de amortiguación en libras para extender o comprimir el amortiguador a una velocidad de operación promedio. La puissance d'amortissement en poids de l'amortisseur, soit comprimé, doit détendu, à une vitesse de fonctionnement moyenne.

SPECIFICATIONS BY END MOUNT
ESPECIFICACIONES POR TIPO DE MONTAJE
SPÉCIFICATIONS PAR FIXATION DES EXTRÉMITÉS

Gabriel	Mounting		Lengths			Dust Tube	Recoil Cutoff	Controls*	
	Upper	Lower	Extended	Collapsed	Stroke			Rebound	Compression
83136	S21	S21	29.31	16.8	12.51	YES	NO	914	65
83395	S21	ES178	27.19	16.28	10.91	YES	NO	616	105
83456	S21	S21	24.03	14.25	9.78	YES	YES	566	80
85009	S21	ES36	23.56	14.4	9.16	YES	YES	857	144
85069	S21	S21	26.31	15.97	10.33	YES	YES	762	255
85071	S21	S21	25.57	15.02	10.55	YES	NO	610	107
85124	S21	S21	20.91	12.9	8.01	YES	YES	1086	222
85310	S21	S21	18.63	11.71	6.92	YES	YES	1379	578
85311	S21	EB3	23.95	14.79	9.16	YES	YES	764	254
85900	S21	S21	17.33	11.23	6.11	YES	YES	1467	337
85902	S21	S21	19.03	12.09	6.93	YES	YES	1441	267
85921	S21	ES36	22.07	13.57	8.5	YES	NO	2053	339
85988	S21	EB3	23.84	14.87	8.97	YES	YES	1200	138
89423	S21	S21	18.67	12.21	6.46	YES	YES	1352‡	573
89424	S21	EB3	23.73	15.14	8.59	YES	YES	794‡	253
89447	S21	S21	23.63	14.69	8.94	YES	YES	702‡	241
89455	S21	S21	26.31	16.03	10.28	YES	YES	791‡	276
58489	S29	BP11	14.64	9.61	5.03				
61544	S29	BP11	14.54	9.75	4.79				
77489	S29	BP11	14.36	9.55	4.81				
81668	S29	BP11	14.32	9.56	4.76				
81713	S29	BP7	14.42	9.31	5.11				
G63489	S29	BP11	14.42	9.64	4.78				
34076	S36	EB1	14.59	9.87	n/a				
58622	S36	EB1	15.04	10.16	4.88				
58623	S36	ES83	22.54	13.91	8.63				
58807	S36	EB1	15.24	10.11	5.13				
58929	S36	EB1	14.54	9.76	4.78				
61520	S36	ES41	15.34	10.31	5.03				
61591	S36	EB1	14.47	9.71	4.76				
61646	S36	ES83	22.57	14.29	8.28				
77414	S36	ES83	15.33	10.34	4.99				
77608	S36	EB1	14.45	9.64	4.81				
77614	S36	EB1	15.04	10.05	4.99				
77807	S36	EB1	15.33	10.34	4.99				
81394	S36	ES25	17.47	11.21	6.26				
81744	S36	EB1	14.52	9.76	4.76				

* Damping force, in pounds, to either extend or collapse the shock absorber at an average operating velocity. Fuerza de amortiguación en libras para extender o comprimir el amortiguador a una velocidad de operación promedio. La puissance d'amortissement en poids de l'amortisseur, soit comprimé, doit détendu, à une vitesse de fonctionnement moyenne.

SPECIFICATIONS BY END MOUNT
ESPECIFICACIONES POR TIPO DE MONTAJE
SPÉCIFICATIONS PAR FIXATION DES EXTRÉMITÉS

Gabriel	Mounting		Lengths			Dust Tube	Recoil Cutoff	Controls*	
	Upper	Lower	Extended	Collapsed	Stroke			Rebound	Compression
81828	S36	ES83	22.72	14.21	8.51				
G63386	S36	ES25	16.11	10.58	5.53				
G63414	S36	ES41	15.09	10.06	5.03				
G63614	S36	EB1	15.09	10.06	5.03				
G63622	S36	EB1	15.32	10.29	5.03				
G63623	S36	ES83	22.57	14.29	8.28				
61599	S38	ES34	13.8	9.52	4.28				
61634	S38	ES34	22.3	13.77	8.53				
61635	S38	ES34	23.27	14.24	9.03				
61680	S38	ES34	20.83	13.39	7.44				
77623	S38	ES83	22.38	13.84	8.54				
77673	S38	ES34	22.38	13.84	8.54				
77674	S38	ES34	23.27	14.27	9.00				
77714	S38	BP7	15.34	9.84	5.50				
77716	S38	ES26	15.32	9.84	5.48				
77948	S38	ES34	23.5	14.75	8.75				
77949	S38	BP27	16.16	10.67	5.49				
77951	S38	ES34	20.5	13	7.50				
77980	S38	ES204	23	14.39	8.61				
81919	S38	ES34	22.3	13.54	8.76				
81928	S38	ES34	13.78	9.52	4.26				
G63661	S38	ES34	13.8	9.52	4.28				
G63673	S38	ES34	22.3	13.77	8.53				
G63674	S38	ES34	23.39	14.36	9.03				
G63886	S38	ES34	20.8	13.36	7.44				
G64009	S38	ES34	23.29	14.25	9.04				
83114	S40	ES35	23.02	13.78	9.24	YES	NO	450	102
83162	S40	ES190	24.35	14.69	9.67	YES	NO	877	52
83244	S43	ES175	27.28	16.38	10.9	YES	NO	502	112
85182	S43	S43	26.86	16.04	10.82	YES	NO	708	232
61592	S47	EB1	21.45	13.17	8.28				
G63610	S47	EB1	21.95	13.17	8.78				
G64043	S61	BP38	14.09	9.68	4.41				
58714	S62	BP7	15.26	9.98	5.28				
58944	S62	ES204	20.73	13.35	7.38				
61611	S62	BP7	15.48	9.95	5.53				
61613	S62	ES26	15.48	9.95	5.53				

* Damping force, in pounds, to either extend or collapse the shock absorber at an average operating velocity. Fuerza de amortiguación en libras para extender o comprimir el amortiguador a una velocidad de operación promedio. La puissance d'amortissement en poids de l'amortisseur, soit comprimé, doit détendu, à une vitesse de fonctionnement moyenne.

SPECIFICATIONS BY END MOUNT
ESPECIFICACIONES POR TIPO DE MONTAJE
SPÉCIFICATIONS PAR FIXATION DES EXTRÉMITÉS

Gabriel	Mounting		Lengths			Dust Tube	Recoil Cutoff	Controls*	
	Upper	Lower	Extended	Collapsed	Stroke			Rebound	Compression
61714	S62	ES34	23.36	14.22	9.14				
77967	S62	ES34	20.75	13.13	7.62				
81912	S62	BP7	15.48	9.87	5.61				
81914	S62	ES26	15.48	9.87	5.61				
85649	S62	ES34	23.16	16.46	6.7	YES	NO	875	421
G63714	S62	BP7	15.39	9.86	5.53				
G63716	S62	ES26	16.39	9.86	6.53				
G63969	S62	ES34	20.75	13.31	7.44				
G64011	S62	ES87	23.36	14.21	9.15				
G56778	S68	CL1	21.37	14.37	7				
G51856	S92	LU1	21.18	15.11	6.07				
G57802	TMR4S	CL3	17.20	9.96	7.24				
G57147	TMT3S	LU1	21.18	15.11	6.06				
G57206	TMT3S	CL1	22.71	15.74	6.97				
G57816	TMT3S	LP4	27.17	18.98	8.19				
G57800	TMU2B1S	LP4	26.73	19.49	7.24				
G57801	TMU2B1S	LP4	26.73	19.49	7.24				
G57852	TMU3S	CL1	21.28	n/a	n/a				
G57853	TMU3S	CL1	21.28	n/a	n/a				

* Damping force, in pounds, to either extend or collapse the shock absorber at an average operating velocity. Fuerza de amortiguación en libras para extender o comprimir el amortiguador a una velocidad de operación promedio. La puissance d'amortissement en poids de l'amortisseur, soit comprimé, doit détendu, à une vitesse de fonctionnement moyenne.

**SPECIFICATIONS BY PART NUMBER
ESPECIFICACIONES POR NÚMERO DE PARTE
SPÉCIFICATIONS PAR NUMÉRO DE PIÈCE**

Gabriel	Mounting		Lengths			Dust Tube	Recoil Cutoff	Controls*	
	Upper	Lower	Extended	Collapsed	Stroke			Rebound	Compression
14017	EB1	EB1	24.04	14.43	9.61				
14072	ES83	EB18	28.22	16.49	11.73				
34036	EB1	ES24	14.16	9.53	4.63				
34052	S1	BP13	13.62	9	4.62				
34058	S12	ES3	17.13	11.01	n/a				
34073	S1	BP7	14.29	9.37	4.92				
34076	S36	EB1	14.59	9.87	n/a				
43048	EB1	EB1	20.45	12.62	7.83				
43058	EB1	ES25	19.95	12.37	7.58				
43085	EB4	ES27	20.61	12.78	n/a				
43099	S1	ES25	19.17	11.77	7.40				
43111	EB7	ES34	22.9	13.82	9.08				
43140	S1	EB1	20.92	12.84	8.08				
43163	BP14	ES34	25.05	15.69	9.36				
43167	EB1	ES83	22.99	13.88	9.11				
43180	BP8	ES34	23.55	14.19	9.36				
43181	ES34	ES34	24.24	14.88	9.36				
49107	ES24	ES24	19.27	12.29	6.98				
49127	EB1	ES25	19.87	12.63	7.24				
49149	ES27	EB4	24.93	15.64	9.29				
49155	EB1	ES34	23.27	14.29	8.98				
49162	ES24	ES24	20.02	12.79	7.23				
49173	S1	ES25	19.24	12.01	7.23				
49178	S1	ES25	23.12	13.89	9.23				
49203	S1	EB1	20.24	12.51	7.73				
49205	S1	EB1	21.12	13.13	7.99				
49212	ES27	ES27	21.02	13.29	7.73				
49218	BP14	ES34	26.34	16.36	9.98				
49231	BP14	ES34	24.27	14.79	9.48				
49235	ES34	ES34	24.77	15.04	9.73				
49237	S12	ES171	24.18	14.45	9.73				
49310	EB1	EB1	20.35	12.75	7.60				
49311	EB1	EB1	22.44	14	8.44				
58357	ES24	ES24	14.68	10.06	4.62				
58359	S1	BP13	13.92	9.14	4.78				
58403	ES26	ES26	24.48	14.95	9.53				
58412	ES34	ES34	26.68	16.18	10.50				

* Damping force, in pounds, to either extend or collapse the shock absorber at an average operating velocity. Fuerza de amortiguación en libras para extender o comprimir el amortiguador a una velocidad de operación promedio. La puissance d'amortissement en poids de l'amortisseur, soit comprimé, doit détendu, à une vitesse de fonctionnement moyenne.

SPECIFICATIONS BY PART NUMBER
ESPECIFICACIONES POR NÚMERO DE PARTE
SPÉCIFICATIONS PAR NUMÉRO DE PIÈCE

Gabriel	Mounting		Lengths			Dust Tube	Recoil Cutoff	Controls*	
	Upper	Lower	Extended	Collapsed	Stroke			Rebound	Compression
58488	BP14	ES34	26.69	16.02	10.63				
58489	S29	BP11	14.64	9.61	5.03				
58609	ES126	ES45	16.49	11.05	5.44				
58622	S36	EB1	15.04	10.16	4.88				
58623	S36	ES83	22.54	13.91	8.63				
58638	BP14	ES34	23.87	14.49	9.38				
58662	ES34	ES34	24.68	15.36	9.32				
58714	S62	BP7	15.26	9.98	5.28				
58807	S36	EB1	15.24	10.11	5.13				
58808	EB1	ES83	28.38	16.75	11.63				
58809	EB1	ES83	23.65	14.53	9.12				
58810	EB1	ES83	31.42	18.42	13.00				
58817	S12	ES60	15.59	10.96	4.63				
58929	S36	EB1	14.54	9.76	4.78				
58930	ES34	ES34	22.81	14.06	8.75				
58944	S62	ES204	20.73	13.35	7.38				
61500	EB1	EB1	20.23	12.37	7.86				
61506	EB1	EB1	21.86	13.58	8.28				
61516	ES31	ES24	18.23	11.37	6.86				
61517	ES24	ES24	14.98	9.95	5.03				
61518	S1	ES25	18.73	11.7	7.03				
61519	EB1	ES25	19.98	12.45	7.53				
61520	S36	ES41	15.34	10.31	5.03				
61521	S12	ES25	16.45	10.67	5.78				
61522	ES27	ES27	20.49	12.63	7.86				
61523	S1	BP13	13.7	8.92	4.78				
61524	EB1	ES34	23.26	14.23	9.03				
61525	EB1	ES24	15.01	9.95	5.06				
61529	S1	BP4	14.1	9.34	4.76				
61530	EB1	ES83	25.48	15.2	10.28				
61542	ES126	ES128	16.73	10.95	5.78				
61543	BP14	ES34	26.76	16.23	10.53				
61544	S29	BP11	14.54	9.75	4.79				
61546	S1	EB1	18.45	11.67	6.78				
61547	EB1	ES83	23.01	14.07	8.94				
61554	EB1	ES83	21.48	13.2	8.28				
61555	S12	BP7	14.14	9.11	5.03				

* Damping force, in pounds, to either extend or collapse the shock absorber at an average operating velocity. Fuerza de amortiguación en libras para extender o comprimir el amortiguador a una velocidad de operación promedio. La puissance d'amortissement en poids de l'amortisseur, soit comprimé, doit détendu, à une vitesse de fonctionnement moyenne.

**SPECIFICATIONS BY PART NUMBER
ESPECIFICACIONES POR NÚMERO DE PARTE
SPÉCIFICATIONS PAR NUMÉRO DE PIÈCE**

Gabriel	Mounting		Lengths			Dust Tube	Recoil Cutoff	Controls*	
	Upper	Lower	Extended	Collapsed	Stroke			Rebound	Compression
61556	S1	BP7	14.2	9.09	5.11				
61565	BP14	ES34	24.26	14.73	9.53				
61591	S36	EB1	14.47	9.71	4.76				
61592	S47	EB1	21.45	13.17	8.28				
61599	S38	ES34	13.8	9.52	4.28				
61600	ES34	ES34	24.51	14.98	9.53				
61611	S62	BP7	15.48	9.95	5.53				
61612	S12	ES171	28.39	16.36	12.03				
61613	S62	ES26	15.48	9.95	5.53				
61614	ES41	ES41	22.98	13.95	9.03				
61632	EB4	EB4	20.79	13.01	7.78				
61634	S38	ES34	22.3	13.77	8.53				
61635	S38	ES34	23.27	14.24	9.03				
61638	S12	ES171	24.45	14.42	10.03				
61641	S12	BP11	14.7	10.17	4.53				
61642	ES34	ES34	26.76	15.98	10.78				
61646	S36	ES83	22.57	14.29	8.28				
61654	EB1	ES83	28.76	16.98	11.78				
61655	ES185	ES185	23.01	14.07	8.94				
61656	ES185	ES185	31.51	18.48	13.03				
61663	S12	ES60	15.7	10.92	4.78				
61680	S38	ES34	20.83	13.39	7.44				
61682	EB1	ES83	31.36	18.67	12.69				
61683	S11	LU1	15.07	10.44	4.63				
61684	S11	BP9	12.82	8.88	3.94				
61685	S11	BP9	14.12	9.68	4.44				
61687	BP14	ES34	23.87	14.68	9.19				
61710	ES34	ES34	27.58	17.14	10.44				
61713	EB1	ES83	26.94	16	10.94				
61714	S62	ES34	23.36	14.22	9.14				
61716	ES34	ES34	26.5	16.33	10.17				
77375	S12	BP7	14.14	9.04	5.10				
77403	ES26	ES26	24.31	14.78	9.53				
77412	ES34	ES34	26.77	16.26	10.51				
77414	S36	ES83	15.33	10.34	4.99				
77455	ES83	ES83	22.92	13.9	9.02				
77461	EB1	ES83	25.39	15.18	10.21				

* Damping force, in pounds, to either extend or collapse the shock absorber at an average operating velocity. Fuerza de amortiguación en libras para extender o comprimir el amortiguador a una velocidad de operación promedio. La puissance d'amortissement en poids de l'amortisseur, soit comprimé, doit détendu, à une vitesse de fonctionnement moyenne.

SPECIFICATIONS BY PART NUMBER
ESPECIFICACIONES POR NÚMERO DE PARTE
SPÉCIFICATIONS PAR NUMÉRO DE PIÈCE

Gabriel	Mounting		Lengths			Dust Tube	Recoil Cutoff	Controls*	
	Upper	Lower	Extended	Collapsed	Stroke			Rebound	Compression
77488	BP14	ES34	26.77	16.26	10.51				
77489	S29	BP11	14.36	9.55	4.81				
77607	BP14	ES83	25.39	15.18	10.21				
77608	S36	EB1	14.45	9.64	4.81				
77609	ES126	ES128	16.43	10.95	5.48				
77614	S36	EB1	15.04	10.05	4.99				
77623	S38	ES83	22.38	13.84	8.54				
77638	BP14	ES34	24.31	14.78	9.53				
77661	S12	ES34	13.72	9.5	4.22				
77662	ES34	ES34	24.31	14.78	9.53				
77673	S38	ES34	22.38	13.84	8.54				
77674	S38	ES34	23.27	14.27	9.00				
77675	ES34	ES34	26.25	15.74	10.51				
77714	S38	BP7	15.34	9.84	5.50				
77715	S12	ES171	28.32	16.33	11.99				
77716	S38	ES26	15.32	9.84	5.48				
77783	S12	BP11	14.64	10.12	4.52				
77807	S36	EB1	15.33	10.34	4.99				
77808	EB1	ES83	28.73	16.92	11.81				
77809	EB1	ES83	22.92	13.9	9.02				
77810	EB1	ES83	31.53	18.5	13.03				
77817	S12	ES60	15.73	10.94	4.79				
77837	BP14	ES83	28.73	16.92	11.81				
77907	EB1	EB1	19.87	12.23	7.64				
77948	S38	ES34	23.5	14.75	8.75				
77949	S38	BP27	16.16	10.67	5.49				
77950	ES34	ES34	27.5	17.5	10.00				
77951	S38	ES34	20.5	13	7.50				
77952	EB1	ES83	29.68	17.43	12.25				
77967	S62	ES34	20.75	13.13	7.62				
77968	EB1	ES83	24.71	15.09	9.62				
77969	EB1	ES83	25.43	15.81	9.62				
77976	ES34	ES34	24.84	16.07	8.76				
77980	S38	ES204	23	14.39	8.61				
77986	EB1	ES48	31.01	18.65	12.36				
77987	EB1	ES48	27.24	16.38	10.86				
77988	EB1	ES56	30.12	17.97	12.14				

* Damping force, in pounds, to either extend or collapse the shock absorber at an average operating velocity. Fuerza de amortiguación en libras para extender o comprimir el amortiguador a una velocidad de operación promedio. La puissance d'amortissement en poids de l'amortisseur, soit comprimé, doit détendu, à une vitesse de fonctionnement moyenne.

**SPECIFICATIONS BY PART NUMBER
ESPECIFICACIONES POR NÚMERO DE PARTE
SPÉCIFICATIONS PAR NUMÉRO DE PIÈCE**

Gabriel	Mounting		Lengths			Dust Tube	Recoil Cutoff	Controls*	
	Upper	Lower	Extended	Collapsed	Stroke			Rebound	Compression
81039	EB1	ES24	14.73	9.62	5.11				
81082	EB1	ES83	23.23	13.87	9.36				
81091	ES27	EB4	25.14	15.28	9.86				
81096	S1	BP13	13.7	8.84	4.86				
81113	ES31	ES24	18.23	11.37	6.86				
81147	EB1	EB1	20.23	12.37	7.86				
81164	EB1	ES34	23.23	13.87	9.36				
81242	S1	ES25	19.2	11.59	7.61				
81270	S1	S1	17.67	10.56	7.11				
81318	EB1	EB1	22.73	13.87	8.86				
81340	S1	EB1	20.7	12.34	8.36				
81342	ES27	EB4	28.89	16.78	12.11				
81394	S36	ES25	17.47	11.21	6.26				
81484	EB1	ES25	20.23	12.37	7.86				
81490	S12	ES83	14.85	9.84	5.01				
81495	S1	EB1	20.2	12.34	7.86				
81496	ES27	ES27	20.49	12.63	7.86				
81510	EB1	ES83	25.73	15.12	10.61				
81667	BP14	ES34	26.95	16.19	10.76				
81668	S29	BP11	14.32	9.56	4.76				
81676	EB1	EB1	17.73	11.12	6.61				
81710	EB1	ES185	21.73	13.12	8.61				
81713	S29	BP7	14.42	9.31	5.11				
81726	ES126	ES128	16.48	10.87	5.61				
81744	S36	EB1	14.52	9.76	4.76				
81821	ES83	ES83	23.23	13.87	9.36				
81825	EB4	EB4	21.1	12.99	8.11				
81828	S36	ES83	22.72	14.21	8.51				
81834	S1	BP13	15.7	9.84	5.86				
81873	ES34	ES34	24.74	14.88	9.86				
81892	S12	ES171	24.2	14.09	10.11				
81912	S62	BP7	15.48	9.87	5.61				
81913	S12	ES171	28.39	16.28	12.11				
81914	S62	ES26	15.48	9.87	5.61				
81919	S38	ES34	22.3	13.54	8.76				
81920	S12	BP11	14.71	10.1	4.61				
81921	ES34	ES34	26.76	15.67	11.09				

* Damping force, in pounds, to either extend or collapse the shock absorber at an average operating velocity. Fuerza de amortiguación en libras para extender o comprimir el amortiguador a una velocidad de operación promedio. La puissance d'amortissement en poids de l'amortisseur, soit comprimé, doit détendu, à une vitesse de fonctionnement moyenne.

SPECIFICATIONS BY PART NUMBER
ESPECIFICACIONES POR NÚMERO DE PARTE
SPÉCIFICATIONS PAR NUMÉRO DE PIÈCE

Gabriel	Mounting		Lengths			Dust Tube	Recoil Cutoff	Controls*	
	Upper	Lower	Extended	Collapsed	Stroke			Rebound	Compression
81925	S12	ES7	14.7	9.59	5.11				
81928	S38	ES34	13.78	9.52	4.26				
82003	ES24	ES24	18.55	11.44	7.11				
82007	EB1	EB1	18.23	11.37	6.86				
82012	BP6	ES25	16.04	10.53	5.51				
82026	S1	S1	13.42	8.56	4.86				
82034	S1	S1	22.17	12.81	9.36				
82035	ES24	EB1	14.64	9.53	5.11				
82047	EB1	EB1	20.23	12.37	7.86				
82065	EB4	EB4	19.04	11.93	7.11				
82066	S1	EB1	22.7	13.34	9.36				
82086	ES35	ES35	25.54	14.93	10.61				
82147	EB1	ES25	23.23	13.87	9.36				
82155	S1	EB1	20.7	12.34	8.36				
82156	EB1	EB1	20.23	12.37	7.86				
83006	ES149	EB1	10.71	8.52	2.78	YES	YES	525	182
83021	ES10	ES10	9.41	7.4	2.01	YES	YES	745	315
83025	ES163	ES163	8.02	6.53	1.48	YES	YES	710	230
83040	ES171	ES172	10.44	8.4	3	YES	YES	876	326
83054	ES185	ES185	10.28	7.56	2.72	YES	YES	1004	184
83066	ES153	ES153	11.15	9.2	2.78	YES	YES	599	221
83101	ES90	ES90	24.63	15.13	9.49	YES	YES	481	142
83103	S21	S21	19.66	11.93	7.74	YES	YES	517	301
83114	S40	ES35	23.02	13.78	9.24	YES	NO	450	102
83120	ES120	S21	22.17	13.66	8.51	YES	YES	779	164
83122	ES36	ES36	25.28	15.79	9.49	YES	YES	661	201
83123	ES36	ES36	26.65	16.41	10.24	YES	YES	589	119
83124	ES36	ES36	21.65	13.77	7.88	YES	YES	750	137
83126	ES36	ES36	24.41	15.27	9.14	YES	YES	625	115
83127	ES36	ES36	20.16	13.14	7.01	YES	YES	940	218
83134	S21	ES36	22.27	13.51	8.77	YES	NO	430	49
83135	ES90	ES90	19.49	12.38	7.11	YES	NO	519	121
83136	S21	S21	29.31	16.8	12.51	YES	NO	914	65
83137	ES36	ES36	30.04	17.79	12.25	YES	YES	517	132
83140	EB3	EB3	25.28	15.53	9.75	YES	NO	738	88
83141	EB3	EB3	25.27	15.52	9.75	YES	NO	408	113
83142	ES162	S42	23.92	14.49	9.43	YES	YES	367	131

* Damping force, in pounds, to either extend or collapse the shock absorber at an average operating velocity. Fuerza de amortiguación en libras para extender o comprimir el amortiguador a una velocidad de operación promedio. La puissance d'amortissement en poids de l'amortisseur, soit comprimé, soit détendu, à une vitesse de fonctionnement moyenne.

**SPECIFICATIONS BY PART NUMBER
ESPECIFICACIONES POR NÚMERO DE PARTE
SPÉCIFICATIONS PAR NUMÉRO DE PIÈCE**

Gabriel	Mounting		Lengths			Dust Tube	Recoil Cutoff	Controls*	
	Upper	Lower	Extended	Collapsed	Stroke			Rebound	Compression
83143	ES162	S42	21.92	13.51	8.41	YES	YES	403	137
83154	ES120	S21	20.78	12.72	8.06	YES	YES	599	140
83157	ES36	ES90	26.38	15.76	10.61	YES	NO	446	303
83159	EB2	EB2	21.85	13.56	8.29	YES	NO	658	149
83160	ES128	ES36	24.31	14.9	9.37	YES	YES	920	161
83162	S40	ES190	24.35	14.69	9.67	YES	NO	877	52
83163	ES175	ES175	20.75	13.01	7.74	YES	NO	828	98
83164	ES36	ES165	24.22	14.59	9.63	YES	NO	426	274
83166	ES179	ES179	25.28	15.78	9.49	YES	YES	622	132
83169	ES90	ES90	18.55	11.91	6.64	YES	NO	599	171
83180	ES90	ES83	30.2	21.24	8.96	YES	NO	909	204
83209	ES36	ES36	29.64	17.61	12.03	YES	YES	670	78
83215	EB3	EB3	26.64	16.36	10.28	YES	YES	697	108
83216	EB2	EB2	23.51	14.48	9.03	YES	YES	776	262
83221	ES36	ES36	24.01	14.73	9.28	YES	YES	599	153
83225	EB3	EB3	24.14	15.11	9.03	YES	YES	482	159
83243	ES175	ES175	24.41	15.26	9.15	YES	YES	296	170
83244	S43	ES175	27.28	16.38	10.9	YES	NO	502	112
83308	EB2	EB2	25.14	15.36	9.78	YES	YES	445	180
83312	EB2	EB2	26.64	16.11	10.53	YES	YES	527	152
83317	S16	ES90	27.03	16	11.34	YES	YES		
83364	ES90	ES83	24.06	15.07	8.99	YES	YES	855	206
83391	ES190	ES190	25.52	15.61	9.91	YES	NO	590	105
83395	S21	ES178	27.19	16.28	10.91	YES	NO	616	105
83397	ES175	ES175	18.67	11.91	6.76	YES	NO	303	101
83398	ES175	ES175	23.23	15.38	7.85	YES	YES	293	168
83456	S21	S21	24.03	14.25	9.78	YES	YES	566	80
83515	S1	EB2	23.34	13.89	9.45	YES	NO	643	205
83518	S1	EB2	24.4	14.26	10.14	YES	NO	153	82
83519	EB2	EB2	23.83	14.35	9.48	YES	NO	292	132
83613	S16	S16	21.04	12.76	8.28	YES	YES	601	242
85001	EB3	EB3	26.3	16.39	9.92	YES	NO	1202	186
85005	ES36	ES36	24.76	15.24	9.52	YES	YES	1019	219
85006	ES36	ES36	28.54	17.13	11.41	YES	YES	1019	219
85007	EB3	EB3	24.33	15.4	8.93	YES	YES	1008	171
85009	S21	ES36	23.56	14.4	9.16	YES	YES	857	144
85010	ES36	ES36	26.8	16.26	10.54	YES	YES	1019	219
85012	EB2	EB2	21.02	13.23	7.79	YES	NO	523	199

* Damping force, in pounds, to either extend or collapse the shock absorber at an average operating velocity. Fuerza de amortiguación en libras para extender o comprimir el amortiguador a una velocidad de operación promedio. La puissance d'amortissement en poids de l'amortisseur, soit comprimé, doit détendu, à une vitesse de fonctionnement moyenne.

SPECIFICATIONS BY PART NUMBER
ESPECIFICACIONES POR NÚMERO DE PARTE
SPECIFICATIONS PAR NUMÉRO DE PIÈCE

Gabriel	Mounting		Lengths			Dust Tube	Recoil Cutoff	Controls*	
	Upper	Lower	Extended	Collapsed	Stroke			Rebound	Compression
85013	ES36	ES36	29.79	17.76	12.04	YES	YES	1019	219
85029	ES36	ES36	20.54	13.11	7.43	YES	YES	1019	219
85031	ES176	EB2	25.63	15.87	9.76	YES	NO	941	257
85043	ES36	ES36	27.63	16.85	10.78	YES	YES	628	163
85058	ES36	ES36	22.67	14.26	8.41	YES	YES	722	114
85069	S21	S21	26.31	15.97	10.33	YES	YES	762	255
85071	S21	S21	25.57	15.02	10.55	YES	NO	610	107
85072	ES36	ES176	24.17	14.81	9.36	YES	YES	1387	305
85082	ES90	ES90	28.6	20.64	7.97	YES	YES	1435	266
85084	ES174	ES136	20.59	13.03	7.57	YES	NO	1145	407
85106	ES150	ES150	20.03	12.89	7.14	YES	YES	1054	109
85124	S21	S21	20.91	12.9	8.01	YES	YES	1086	222
85125	ES158	ES159	26.9	16.64	10.26	YES	YES	1479	183
85182	S43	S43	26.86	16.04	10.82	YES	NO	708	232
85188	ES161	ES162	25.31	15.52	9.79	YES	YES	1074	255
85310	S21	S21	18.63	11.71	6.92	YES	YES	1379	578
85311	S21	EB3	23.95	14.79	9.16	YES	YES	764	254
85331	ES158	ES159	19.62	12.85	6.77	YES	YES	1757	396
85335	ES158	ES159	19.62	12.85	6.77	YES	YES	827	107
85642	ES177	ES90	22.52	14.52	8	YES	YES	1920	309
85649	S62	ES34	23.16	16.46	6.7	YES	NO	875	421
85650	ES136	ES34	24.88	16.35	8.53	YES	NO	941	463
85656	ES90	ES90	26.49	16.94	10.75	YES	YES	1225	274
85670	ES175	ES175	23.19	14.67	8.52	YES	YES	591	176
85712	EB3	EB3	20.5	13.47	7.04	YES	YES	1435	562
85723	EB3	S21	19.93	12.9	7.03	YES	YES	1318	248
85724	ES158	ES159	22.81	14.51	8.3	YES	YES	1235	454
85734	EB3	EB3	20.73	13.7	7.03	YES	YES	1288	227
85900	S21	S21	17.33	11.23	6.11	YES	YES	1467	337
85902	S21	S21	19.03	12.09	6.93	YES	YES	1441	267
85918	ES150	ES150	22.97	14.58	8.39	YES	NO	1726	412
85919	ES36	ES36	22.52	14.33	8.19	YES	YES	1265	121
85920	ES150	ES150	21.16	13.57	7.59	YES	NO	845	49
85921	S21	ES36	22.07	13.57	8.5	YES	NO	2053	339
85923	ES177	ES161	22.52	14.52	8	YES	YES	1940	221
85928	ES90	ES90	20.31	13.24	7.07	YES	NO	957	229
85932	ES178	ES150	21.26	13.7	7.56	YES	YES	1102	430

* Damping force, in pounds, to either extend or collapse the shock absorber at an average operating velocity. Fuerza de amortiguación en libras para extender o comprimir el amortiguador a una velocidad de operación promedio. La puissance d'amortissement en poids de l'amortisseur, soit comprimé, doit détendu, à une vitesse de fonctionnement moyenne.

SPECIFICATIONS BY PART NUMBER
ESPECIFICACIONES POR NÚMERO DE PARTE
SPÉCIFICATIONS PAR NUMÉRO DE PIÈCE

Gabriel	Mounting		Lengths			Dust Tube	Recoil Cutoff	Controls*	
	Upper	Lower	Extended	Collapsed	Stroke			Rebound	Compression
85956	ES183	ES184	30.65	18.77	11.88	YES	YES	979	373
85957	ES90	ES90	20.78	13.19	7.6	YES	NO	1583	138
85958	ES150	ES150	22.89	14.5	8.39	YES	YES	1926	281
85959	ES150	ES150	21.16	13.57	7.59	YES	YES	1021	123
85976	ES36	ES36	29.92	18.12	11.8	YES	YES	582	138
85988	S21	EB3	23.84	14.87	8.97	YES	YES	1200	138
85989	ES174	ES136	20.78	13.15	7.63	YES	NO	1812	351
89405	ES36	ES36	26.3	16.57	9.73	YES	YES	1009‡	249
89406	ES36	ES36	24.76	15.82	8.93	YES	YES	658‡	125
89407	ES36	ES36	21.61	14.17	7.45	YES	YES	652‡	218
89409	EB2	EB2	27.13	16.92	10.2	YES	YES	567‡	165
89410	EB3	EB3	26.34	16.57	9.77	YES	NO	1185‡	182
89413	EB2	EB2	20.94	13.53	7.41	YES	NO	536‡	201
89414	ES36	ES36	29.65	18.18	11.46	YES	YES	1045‡	217
89423	S21	S21	18.67	12.21	6.46	YES	YES	1352‡	573
89424	S21	EB3	23.73	15.14	8.59	YES	YES	794‡	253
89430	ES36	ES36	24.61	15.66	8.94	YES	YES	1462‡	279
89431	ES36	ES36	22.41	14.16	8.25	YES	NO	751‡	211
89443	ES158	ES159	22.19	14.66	7.53	YES	YES	1206‡	466
89447	S21	S21	23.63	14.69	8.94	YES	YES	702‡	241
89449	ES150	ES150	23.25	14.9	8.35	YES	NO	1519‡	324
89453	ES178	ES150	21.14	13.93	7.21	YES	YES	860‡	435
89455	S21	S21	26.31	16.03	10.28	YES	YES	791‡	276
89458	ES177	ES161	22.48	14.6	7.88	YES	YES	1575‡	222
89460	ES174	ES136	20.58	13.03	7.55	YES	NO	997‡	384
89503	ES150	ES150	21.28	13.72	7.56	YES	NO	1033‡	123
6802SE	S1	S1	20.02	12.11	7.91				
6803SE	S1	S1	22.52	13.36	9.16				
6804SE	EB1	EB1	24.08	14.67	9.41				
6828SE	EB1	EB1	21.23	12.87	8.36				
6847SE	EB1	ES65	23	13.83	9.17				
6850SE	EB1	S1	23.3	13.77	9.53				
6853SE	EB1	ES24	19.33	12.05	7.28				
6854SE	EB1	EB1	23.03	14.27	8.76				
6855SE	EB1	EB1	23.83	14.3	9.53				
6856SE	S1	EB1	27.3	15.77	11.53				
6861SE	S1	S1	20.27	11.99	8.28				

* Damping force, in pounds, to either extend or collapse the shock absorber at an average operating velocity. Fuerza de amortiguación en libras para extender o comprimir el amortiguador a una velocidad de operación promedio. La puissance d'amortissement en poids de l'amortisseur, soit comprimé, doit détendu, à une vitesse de fonctionnement moyenne.

SPECIFICATIONS BY PART NUMBER
ESPECIFICACIONES POR NÚMERO DE PARTE
SPÉCIFICATIONS PAR NUMÉRO DE PIÈCE

Gabriel	Mounting		Lengths			Dust Tube	Recoil Cutoff	Controls*	
	Upper	Lower	Extended	Collapsed	Stroke			Rebound	Compression
G51856	S92	LU1	21.18	15.11	6.07				
G56778	S68	CL1	21.37	14.37	7				
G57147	TMT3S	LU1	21.18	15.11	6.06				
G57206	TMT3S	CL1	22.71	15.74	6.97				
G57800	TMU2B1S	LP4	26.73	19.49	7.24				
G57801	TMU2B1S	LP4	26.73	19.49	7.24				
G57802	TMR4S	CL3	17.20	9.96	7.24				
G57816	TMT3S	LP4	27.17	18.98	8.19				
G57852	TMU3S	CL1	21.28	n/a	n/a				
G57853	TMU3S	CL1	21.28	n/a	n/a				
G63183	EB4	EB4	20.79	13.01	7.78				
G63299	EB1	EB1	18.08	11.55	6.53				
G63306	ES24	ES24	19.85	12.57	7.28				
G63347	ES31	ES24	18.08	11.55	6.53				
G63349	EB1	ES34	23.33	14.3	9.03				
G63350	S1	ES25	18.82	11.79	7.03				
G63353	ES27	EB4	24.74	14.96	9.78				
G63355	EB1	ES24	14.98	9.95	5.03				
G63357	ES24	ES24	14.98	9.95	5.03				
G63359	S1	BP13	13.7	8.92	4.78				
G63360	S1	BP13	15.7	9.92	5.78				
G63366	ES34	ES34	23.26	14.23	9.03				
G63375	S12	BP7	14.14	9.11	5.03				
G63377	EB1	ES25	20.08	12.55	7.53				
G63386	S36	ES25	16.11	10.58	5.53				
G63387	S1	ES25	23.32	14.04	9.28				
G63394	EB1	ES24	16.01	10.48	5.53				
G63403	ES26	ES26	24.58	14.8	9.78				
G63405	EB1	EB1	20.01	12.48	7.53				
G63409	EB1	ES185	21.48	13.2	8.28				
G63410	S12	EB1	18.55	11.77	6.78				
G63411	ES31	ES26	18.58	11.8	6.78				
G63413	ES27	ES27	20.76	12.98	7.78				
G63414	S36	ES41	15.09	10.06	5.03				
G63418	S1	BP11	13.95	9.17	4.78				
G63419	EB1	EB1	24.08	14.55	9.53				
G63455	ES83	ES83	22.98	13.95	9.03				

* Damping force, in pounds, to either extend or collapse the shock absorber at an average operating velocity. Fuerza de amortiguación en libras para extender o comprimir el amortiguador a una velocidad de operación promedio. La puissance d'amortissement en poids de l'amortisseur, soit comprimé, soit détendu, à une vitesse de fonctionnement moyenne.

**SPECIFICATIONS BY PART NUMBER
ESPECIFICACIONES POR NÚMERO DE PARTE
SPÉCIFICATIONS PAR NUMÉRO DE PIÈCE**

Gabriel	Mounting		Lengths			Dust Tube	Recoil Cutoff	Controls*	
	Upper	Lower	Extended	Collapsed	Stroke			Rebound	Compression
G63456	EB1	ES83	26.85	16.07	10.78				
G63461	EB1	ES83	25.51	15.23	10.28				
G63488	BP14	ES34	26.61	16.33	10.28				
G63489	S29	BP11	14.42	9.64	4.78				
G63492	EB1	EB1	22.58	13.8	8.78				
G63604	EB1	ES142	19.74	12.46	7.28				
G63607	BP14	ES83	25.58	15.3	10.28				
G63609	ES126	ES128	16.5	10.97	5.53				
G63610	S47	EB1	21.95	13.17	8.78				
G63614	S36	EB1	15.09	10.06	5.03				
G63622	S36	EB1	15.32	10.29	5.03				
G63623	S36	ES83	22.57	14.29	8.28				
G63625	EB1	ES24	22.56	13.78	8.78				
G63638	BP14	ES34	24.33	14.8	9.53				
G63661	S38	ES34	13.8	9.52	4.28				
G63662	ES34	ES34	24.58	15.05	9.53				
G63671	ES26	ES26	22.48	13.7	8.78				
G63673	S38	ES34	22.3	13.77	8.53				
G63674	S38	ES34	23.39	14.36	9.03				
G63675	ES34	ES34	26.86	16.08	10.78				
G63692	EB1	EB1	27.58	16.3	11.28				
G63714	S62	BP7	15.39	9.86	5.53				
G63715	S12	ES171	28.55	16.52	12.03				
G63716	S62	ES26	16.39	9.86	6.53				
G63778	S12	ES171	24.55	14.52	10.03				
G63783	S12	BP11	14.59	10.21	4.38				
G63808	EB1	ES83	28.86	17.08	11.78				
G63809	EB1	ES83	22.98	13.95	9.03				
G63810	EB1	ES185	31.6	18.57	13.03				
G63817	S12	ES60	15.8	11.02	4.78				
G63837	BP14	ES83	28.23	17.95	10.28				
G63886	S38	ES34	20.8	13.36	7.44				
G63888	EB1	ES83	31.36	18.67	12.69				
G63893	S11	LU1	15.07	10.44	4.63				
G63894	S11	BP9	12.82	8.88	3.94				
G63895	S11	BP9	14.12	9.68	4.44				
G63896	BP14	ES34	22.36	13.92	8.44				

* Damping force, in pounds, to either extend or collapse the shock absorber at an average operating velocity. Fuerza de amortiguación en libras para extender o comprimir el amortiguador a una velocidad de operación promedio. La puissance d'amortissement en poids de l'amortisseur, soit comprimé, doit détendu, à une vitesse de fonctionnement moyenne.

SPECIFICATIONS BY PART NUMBER
ESPECIFICACIONES POR NÚMERO DE PARTE
SPÉCIFICATIONS PAR NUMÉRO DE PIÈCE

Gabriel	Mounting		Lengths			Dust Tube	Recoil Cutoff	Controls*	
	Upper	Lower	Extended	Collapsed	Stroke			Rebound	Compression
G63897	BP14	ES34	23.87	14.68	9.19				
G63907	EB1	EB1	20.23	12.37	7.86				
G63918	ES34	ES141	21.25	13.56	7.69				
G63950	S1	BP7	14.2	9.09	5.11				
G63969	S62	ES34	20.75	13.31	7.44				
G63971	ES34	ES34	27.58	17.14	10.44				
G64009	S38	ES34	23.29	14.25	9.04				
G64010	EB1	ES83	26.94	16	10.94				
G64011	S62	ES87	23.36	14.21	9.15				
G64013	ES34	ES34	26.52	16.33	10.19				
G64042	ES18	ES18	14.92	10.55	4.37				
G64043	S61	BP38	14.09	9.68	4.41				
G64089	ES56	ES56	20.43	13.03	7.4				
G64121	ES34	ES34	25.35	16.17	9.18				
G64148	LU1	DS1	18.39	14.09	4.3				
G64164	ES210	ES13	19.95	12.81	7.14				
G64177	ES216	ES19	25.86	16.1	9.76				
G64268	EB1	ES56	31.34	18.70	12.64				
G64269	EB1	ES56	26.93	16.04	10.89				

* Damping force, in pounds, to either extend or collapse the shock absorber at an average operating velocity. Fuerza de amortiguación en libras para extender o comprimir el amortiguador a una velocidad de operación promedio. La puissance d'amortissement en poids de l'amortisseur, soit comprimé, doit détendu, à une vitesse de fonctionnement moyenne.



HERE TO HELP



800.999.3903 | ANSWERGARAGE.COM

Gabriel®

THE ORIGINAL

Ride Control AnswerGarage/Tech Line:

800.999.3903

For application, technical and product questions
Monday - Friday, 9AM - 4PM ET

Gabriel Customer Service:

800.251.5932

To place and track orders
Monday - Friday, 7AM - 5PM CT

Watch our Videos:

Gabriel® Shock Selector



Last Mile Delivery



ReadyMount® Installation



MaxControl™ Installation



FIND MORE AT GABRIEL.COM
part lookup, product info, technical help & training



Ride Control, LLC, 39300 Country Club Dr.
Farmington Hills, MI 48331, 248.247.7600