

Gabriel®

THE ORIGINAL

20 23

SHOCK & STRUT
CATALOG



SCAN TO WATCH!
*Which is the best Gabriel®
shock or strut for my vehicle?*

AnswerGarage.com/ShockSelector

Gabriel.com

2023 Table of Contents / Table des matières / Contenido

Footnote Index	2
Sales Popularity Listing / Liste des Codes de « Popularité » / Lista de Terminos mas Populares.....	3
Application Data	
Passenger Cars & Light Trucks.....	4
Numerical Listing	
Steering Stabilizers	245
Steering Dampers	249
Front Load Carriers	249
Rear Load Carriers.....	250
Ultra Strut Cartridges	252
HiJackers	252
Ultra Struts.....	257
Guardian Struts.....	266
Ultra ReadyMount.....	267
LTV Severe Duty Shocks	277
ProGuard Shocks.....	279
Ultra Truck Shocks	285
Ultra Shocks.....	293
MaxControl Monotube Shocks	298
Guardian Shocks.....	301
Classic Shocks.....	309
Suspension Mounts	312
Strut Cushions.....	317
Reference Section:	
A..... Left / Right Combinations.....	321
B..... Mounting Codes / Extended and Collapsed Length Charts.....	325
B..... Specs by Part Number.....	335
C..... Disposal of Old or Defective Shocks & Struts.....	359
C..... <i>Disposition de Vieux ou Défectueux Chocs et de Contrefiches</i> <i>de Gas-Pressurized</i>	360
C..... <i>Como Deshacerse de Amortiguadores y Struts Viejos o</i> <i>Defectuosos-sin Presurizacion con Gas</i>	361
D..... Air Adjustable Hose Kits.....	362





FOOTNOTE INDEX

- 1 - 4 Future Part
- 5 Use kit no. 140719 to replace O.E. hardware for lower shock absorber mounting when studs break or self-tapping screws are no longer useable.
- 6 It is recommended that when replacing shocks on vehicles with "quad shocks" option, all 4 shocks should be matched by series.
- 7 Pair Packs. Air hose kit included.
- 8 Pair Packs.
- 9 See Ref. D for procedures to replace Elec. Adj. Susp. with non-adj. product.
- 10 The Nivomat leveling shocks are on the rear only. If suspension spring contacts units, rotate suspension spring 180 degrees.
- 30 For GM Vehicles equipped with factory installed leveling systems, see Ref. A.
- 31 With Nivomat Self-Leveling Suspension replace spring with Volvo No. 1229052/4.
- 32 With Nivomat Self-Leveling Suspension replace spring with Volvo No. 1359710 or 1273977.
- 33 Also works as conventional type replacement for Nivomat suspension.
- 34 If suspension spring contacts this unit, rotate suspension spring 180 degrees.
- 35 Sight grinding of control arm opening is required to install product made before Aug. 1988.
- 36 Requires special strut installation tool.
- 37 Jounce Bumper hardware from O.E. part may need to be reused.
- 39 Conventional gas-charged strut can be used to replace O.E. air adjustable gas-charged strut. However, the self-leveling system must be deactivated. See Ref. A for instructions.
- 40 ReadyMount Strut. Complete Assembled Unit.
- 41 ReadyMount Strut. Complete Assembled Unit. See Ref. D for procedures to replace Elec. Adj. Susp. with non-adj. product.
- 42 ReadyMount Strut, does not include springs due to vehicle design.
- 43 ReadyMount Strut, does not include springs due to vehicle design. See Ref. D for procedures to replace Elec. Adj. Susp. with non-adj. product.
- 44 This strut is not gas pressurized therefore the piston rod will not extend without assistance.
- 45 Strut must be rotated to align notch with lower control arm
- 46 Upper Mount orientation may be required.
- 50 Bellows Kit No.141242 is recommended for use to protect piston rod from potentially harmful road debris.
- 51 Strut Cushion.
- 52 See Ref. C for optional Steering Stabilizer Boots.
- 53 Strut Mount. Hardware from O.E. Part may need to be reused.
- 54 Kit with Mount and Bearing. Hardware from O.E. Part may need to be reused.
- 55 Mount Kit includes Mount, Spring Seat, Bearing & Isolator. Hardware from O.E. Part may need to be reused.
- 56 Mount Kit includes Mount, Bumper/Bellow & Retainers. Hardware from O.E. Part may need to be reused.
- 57 Mount Kit includes Lower Spring Seat with Internal Bearing & Isolator. Hardware from O.E. Part may need to be reused.
- 58 Mount Kit includes Suspension Bearing. Hardware from O.E. Part may need to be reused.
- 59 Strut Mount Contains a Plastic Bearing. Hardware from O.E. Part may need to be reused.
- 60 Strut Mount Contains a Metal Bearing. Hardware from O.E. Part may need to be reused.
- 61 Mount Kit includes Upper Spring Seat. Hardware from O.E. Part may need to be reused.
- 62 Mount Kit includes Lower Suspension Mount Bushing. Hardware from O.E. Part may need to be reused.
- 63 Mount Kit includes Isolator. Hardware from O.E. Part may need to be reused.
- 64 Mount Kit includes Lower Rubber Spring Seat Isolator. Hardware from O.E. Part may need to be reused.
- 65 Mount Kit includes Upper Spring Seat with Isolator. Hardware from O.E. Part may need to be reused.
- 66 Upper Spring Seat with Spacer. Hardware from O.E. Part may need to be reused.
- 67 Strut Mount Kit. Hardware from O.E. Part may need to be reused.
- 69 Strut Mount & 1 Retainer. Hardware from O.E. Part may need to be reused.
- 70 Mount Kit includes Bushing & Sleeve. Hardware from O.E. Part may need to be reused.
- 72 Mount Kit includes Upper/Lower Retainer, Upper/Lower Cushion, 1 Lower Spring Isolator & 1 Sleeve
- 80 Mounting bracket not required, install on O.E. Shock Mounts. See Ref. C for optional Steering Stabilizer Boots.
- 81 Mounting bracket kit is required for installation. See Numeric Listing. See Ref. C for optional Steering Stabilizer Boots.
- 82 Use kit if listed. See Ref. C for optional Steering Stabilizer Boots.
- 83 For dual system, two stabilizers and one bracket kit are to be ordered. See Ref. C for optional Steering Stabilizer Boots.
- 98 Notice: The level of difficulty to install this product is moderately high. Please review the installation instructions carefully before proceeding.
- 99 Notice: The level of difficulty to install this product is moderately high. Please review the installation instructions carefully before proceeding. Requires special strut installation tool.

SALES POPULARITY LISTING
LISTE DES CODES DE «POPULARITÉ»
LISTA DE TERMINOS MAS POPULARES

- A** FAST
RAPIDE
RAPIDO
- B** GOOD
BON
BUENO
- C** FAIR
PASSABLE
RAZONABLE
- D** SLOW
LENT
LENTO
- FF** NEW ITEM, AVAILABILITY TO BE ANNOUNCED
NOUVEL ITEM DISPONIBILITÉ À ÊTRE ANNONCÉE
ARTICULO NUEVO, DISPONIBILIDAD SERA ANUNCIADO
- N** NEW ITEM
NOUVEL ARTICLE
ARTICULO NUEVO
- S** SUPERSEDED - SELL UNTIL FACTORY INVENTORY IS DEPLETED,
THEN USE REPLACEMENT PART NUMBER
REPLACÉ – VENDRE JUSQU’À ÉPUISEMENT DU STOCK EN USINE,
PUIS UTILISER LE NUMÉRO DE PIÈCE DE REMPLACEMENT
REEMPLAZA – VENDERSE HASTA QUE EL INVENTARIO DE LA FABRICA
SE TERMINE, ENTONCES USE LA PARTE QUE LA REEMPLAZA
- W** EXTREMELY SLOW
TRÈS LENT
EXTREMADAMENTE LENTO
- X** DISCONTINUE WHEN CURRENT FACTORY INVENTORY IS DEPLETED -
LAST YEAR IN CATALOG
ARRÊTEZ QUAND L’INVENTAIRE DU FABRICANT EST ÉPUISE –
DERNIÈRE ANNÉE DANS LE CATALOGUE
DESCONTINUAR CUANDO EL INVENTARIO ACTUAL SE TERMINE –
EN EL CATALOGO DEL AÑO PASADO







APPLICATION GUIDE

Year	Fitment Notes										
		 Ultra	Ready Mounts	Max Control\ LTV Severe Duty\ ProGuard\ Guardian	Strut Cushion\ Strut Mount\ Dampers\ Stabilizer	HiJackers\ Load Carrier\ Classic	 Ultra	Ready Mounts	Max Control\ LTV Severe Duty\ ProGuard\ Guardian	Strut Cushion\ Strut Mount\ Dampers\ Stabilizer	HiJackers\ Load Carrier\ Classic





ACURA

ACURA









CL

01-03	Left	 G55870	G56991 ⁴⁰	M55870	142230 ⁵³		G56943 ⁴⁰	M55871
	Right	 G55870	G56992 ⁴⁰	M55870	142230 ⁵³		G56943 ⁴⁰	M55871
97-99	All		M55877	142230 ⁵³		M55786	143064 ⁵¹











CSX

06-11	Left	 G52038	G57390 ⁴⁰	 G51807
	Right	 G52039	G57391 ⁴⁰	 G51807





EL

01-03	Left	 G56621	G57521 ⁴⁰	M56621	142230 ⁵³	 G51700
	Right	 G56622	G57522 ⁴⁰	M56622	142230 ⁵³	 G51700
97-00	Left	 G55909	G56996 ⁴⁰	142230 ⁵³ 143064 ⁵¹	 G55910	G56998 ⁴⁰	143064 ⁵¹
	Right	 G55909	G56997 ⁴⁰	142230 ⁵³ 143064 ⁵¹	 G55910	G56998 ⁴⁰	143064 ⁵¹













INTEGRA

94-01	All		142230 ⁵³ 143064 ⁵¹		143064 ⁵¹
	Exc. RS & Type R Models		M55802 ⁴⁶	142230 ⁵³ 143064 ⁵¹		M55803	143064 ⁵¹
	Exc. Type R Models Left		G56993 ⁴⁰	142230 ⁵³ 143064 ⁵¹		G56995 ⁴⁰	143064 ⁵¹
	Exc. Type R Models Right		G56994 ⁴⁰	142230 ⁵³ 143064 ⁵¹		G56995 ⁴⁰	143064 ⁵¹
90-93	All		142230 ⁵³ 143064 ⁵¹		142230 ⁵³ 142300 ⁶⁷ 143064 ⁵¹

LEGEND

91-95	All			143063 ⁵¹
86-90	Auto-Leveling System		142230 ⁵³ 143064 ⁵¹		143063 ⁵¹

MDX

07-13	Left Exc. Active Suspension	 G52249	G57560 ⁴⁰	 G64080
	Right Exc. Active Suspension	 G52250	G57561 ⁴⁰	 G64080
03-06	Left	 G52140	143315 ⁵⁴	 G64003	61704
	Right	 G52141	143315 ⁵⁴	 G64003	61704
01-02	Left	 G56759	G57119 ⁴⁰	143315 ⁵⁴	 G64003	61704
	Right	 G56758	G57120 ⁴⁰	143315 ⁵⁴	 G64003	61704

40 Complete Assembled Unit.

51 Strut Cushion for use with the Strut/Cartridge/Shocks.





54 Kit with Mount and Bearing. Hardware from O.E. Part may need to be reused.

46 Upper Mount orientation may be required.

53 Hardware from O.E. Part may need to be reused.





67 Mount Kit. Hardware from O.E. Part may need to be reused.

APPLICATION GUIDE



Year	Fitment Notes										
		 Ultra	Ready Mounts	Max Control\ LTV Severe Duty\ ProGuard\ Guardian	Strut Cushion\ Strut Mount\ Dampers\ Stabilizer	HiJackers\ Load Carrier\ Classic	 Ultra	Ready Mounts	Max Control\ LTV Severe Duty\ ProGuard\ Guardian	Strut Cushion\ Strut Mount\ Dampers\ Stabilizer	HiJackers\ Load Carrier\ Classic

ACURA















RDX

07-12	Left		G52187	G57574 ⁴⁰		G51966
	Right		G52188	G57575 ⁴⁰		G51966



RL

05-12	All		G51911	
-------	-----	-----------------------------------------------------------------------------------	--------	------	------	------	------	-------------------------------------------------------------------------------------	------	------	------	------	------





















RSX

05-06	Left			G51914	G57442 ⁴⁰	142230 ⁵³
	Right			G51914	G57441 ⁴⁰	142230 ⁵³
	Type-S Left		143233 ⁵⁰	
	Type-S Right		143265 ⁵⁰	
02-06	Base & Type S Models		143353 ⁵⁴	
02-04	Left		G57523 ⁴⁰		G57442 ⁴⁰	142230 ⁵³
	Right		G57524 ⁴⁰		G57441 ⁴⁰	142230 ⁵³





SLX

96-99	All		G63707		G63708	61608
-------	-----	-------------------------------------------------------------------------------------	--------	------	------	------	------	---------------------------------------------------------------------------------------	--------	------	-------	------	------

TL

13-14	Left		G51917	142230 ⁵³		G51919
	Right		G51918	142230 ⁵³		G51919
09-12	Left		G51917	142230 ⁵³		G51919	142230 ⁵³
	Right		G51918	142230 ⁵³		G51919	142230 ⁵³
04-08	All		G51737	142230 ⁵³		G51738	G57056 ⁴⁰	142230 ⁵³
99-03	Left		G55870	G56991 ⁴⁰	M55870	142230 ⁵³		M55871	142230 ⁵³
	Right		G55870	G56992 ⁴⁰	M55870	142230 ⁵³		M55871	142230 ⁵³
	Base SubModel			G56943 ⁴⁰
	Type-S SubModel			G57576 ⁴⁰
95-98	All		142230 ⁵³	

TSX

09-14	All			G51919
04-08	All		G51737		G51847



40 Complete Assembled Unit.

54 Kit with Mount and Bearing. Hardware from O.E. Part may need to be reused.

53 Hardware from O.E. Part may need to be reused.

60 Strut Mount Contains a Metal Bearing. Hardware from O.E. Part may need to be reused.

APPLICATION GUIDE

Year	Fitment Notes										
		Ultra	Ready Mounts	Max Control\ LTV Severe Duty\ ProGuard\ Guardian	Strut Cushion\ Strut Mount\ Dampers\ Stabilizer	HiJackers\ Load Carrier\ Classic	Ultra	Ready Mounts	Max Control\ LTV Severe Duty\ ProGuard\ Guardian	Strut Cushion\ Strut Mount\ Dampers\ Stabilizer	HiJackers\ Load Carrier\ Classic

ACURA

ACURA

VIGOR

92-94	All	↓	142230 ⁵³ 143064 ⁵¹	↓	143064 ⁵¹
-------	-----	---	------	------	------	----------------------------------------------	------	---	------	------	------	----------------------	------

ZDX

10-13	Left Exc. Electronic Suspension	↓	G52249	○	G64080
	Right Exc. Electronic Suspension	↓	G52250	○	G64080

AMERICAN MOTORS

AMERICAN MOTORS

AMBASSADOR

70-74	All		82126		○	81340	43140 ⁸
67-69	All			○	43140 ⁸ 49205 ⁷ 82155
60-66	All			○	82066

AMERICAN

64-68	All		82069		○	43140 ⁸ 49205 ⁷ 82155
61-63	All			○	43140 ⁸ 49205 ⁷ 82155
59-60	All			○	43140 ⁸ 82155

AMX

78-80	All		82126		○	82125
70	All		82126		○	81340	43140 ⁸
68-69	All		82069		○	43140 ⁸ 82155

CLASSIC

61-66	All			○	82066
-------	-----	--	------	------	------	------	--	---	------	------	------	------	-------

CONCORD

78-83	All		82126		○	82125
-------	-----	--	------	------	------	-------	--	---	------	------	------	------	-------

EAGLE

80-88	All		81491	6804SE ⁸⁰		○	81340	43140 ⁸
-------	-----	--	------	------	-------	----------------------	------	--	---	------	------	-------	------	--------------------

GREMLIN

71-78	All		82126		○	82125
70	All		82126		○	49131 ⁷ 82051

HORNET

71-77	All		82126		○	82125
70	All		82126		○	49131 ⁷ 82051

JAVELIN

70-74	All		82126		○	81340	43140 ⁸
68-69	All		82069		○	43140 ⁸ 49205 ⁷ 82155

7 Pair Packs, Air hose kit included.



51 Strut Cushion for use with the Strut/Cartridge/Shocks.

80 Mounting bracket not required, install on O.E. Shock Mounts. See Ref. C for optional Steering Stabilizer Boots

8 Pair Packs.

53 Hardware from O.E. Part may need to be reused.

APPLICATION GUIDE

Year	Fitment Notes										
		Ultra	Ready Mounts	Max Control\ LTV Severe Duty\ ProGuard\ Guardian	Strut Cushion\ Strut Mount\ Dampers\ Stabilizer	HiJackers\ Load Carrier\ Classic	Ultra	Ready Mounts	Max Control\ LTV Severe Duty\ ProGuard\ Guardian	Strut Cushion\ Strut Mount\ Dampers\ Stabilizer	HiJackers\ Load Carrier\ Classic

AMERICAN MOTORS

MARLIN

67	All		43140 ⁹ 49205 ⁷ 82155
65-66	All		82066

MATADOR

71-78	All	I T	82126	I O	81340	43140 ⁹
-------	-----	--------	------	------	------	------	------	-------	--------	------	------	-------	------	------	--------------------

PACER

75-80	All	I E	82025	I T	81270	49105 ⁷
-------	-----	--------	------	------	------	------	------	-------	--------	------	------	-------	------	------	--------------------

RAMBLER

69	All	I T	82069	I O	43140 ⁹ 49205 ⁷ 82155
59-60	All		I O	43140 ⁹ 49205 ⁷ 82155

SPIRIT

79-83	All	I T	82126	I T	82125
-------	-----	--------	------	------	------	------	------	-------	--------	------	------	------	------	------	-------

ASUNA

GT, SE

93	All	O	G44903 ⁹⁸	143057 ⁵¹
----	-----	---	----------------------	------	------	------	------	----------------------	------	------	------	------	------	------	------

SUNFIRE (CANADIAN VEHICLE)

93	Exc. Lotus Suspension	I	142317 ⁵³ 143058 ⁵¹	I	143061 ⁵¹
----	-----------------------	---	------	------	------	------	------	----------------------------------------------	---	------	------	------	------	------	----------------------	------

SUNRUNNER

92-93	All		I O	G63799	61560 81904
	Non-ABS	I	G56518	I O	G63799	61560 81904

AUDI

80

88-92	All	I	142195 ⁵³ 143057 ⁵¹	I	143061 ⁵¹
-------	-----	---	------	------	------	------	------	----------------------------------------------	---	------	------	------	------	------	----------------------	------

80 QUATTRO

88-92	All	I	142195 ⁵³ 143057 ⁵¹	
-------	-----	---	------	------	------	------	------	----------------------------------------------	--	------	------	------	------	------	------	------

90

93-95	All	I	142195 ⁵³ 143057 ⁵¹	I	143061 ⁵¹
88-91	All	I	142195 ⁵³ 143057 ⁵¹	I	143061 ⁵¹

90 QUATTRO

93-95	All	I	142195 ⁵³ 143057 ⁵¹	
88-91	All	I	142195 ⁵³ 143057 ⁵¹	

7 Pair Packs, Air hose kit included.



51 Strut Cushion for use with the Strut/Cartridge/Shocks.

98 Notice: The level of difficulty to install this product is moderately high. Please review the installation instructions carefully before proceeding

8 Pair Packs.

53 Hardware from O.E. Part may need to be reused.

APPLICATION GUIDE

Year	Fitment Notes										
		Ultra	Ready Mounts	Max Control\ LTV Severe Duty\ ProGuard\ Guardian	Strut Cushion\ Strut Mount\ Dampers\ Stabilizer	HiJackers\ Load Carrier\ Classic	Ultra	Ready Mounts	Max Control\ LTV Severe Duty\ ProGuard\ Guardian	Strut Cushion\ Strut Mount\ Dampers\ Stabilizer	HiJackers\ Load Carrier\ Classic

AUDI

100

91-94	Mfg. Late 91	143061 ⁵¹	...
	Mfg. Late 91	143061 ⁵¹
89-90	Mfg. Late 91	143061 ⁵¹
	Mfg. Late 91	143061 ⁵¹	...

100 QUATTRO

89-90	All	143057 ⁵¹
-------	-----	-----	-----	-----	----------------------	-----	-----	-----	-----	-----

200

89-90	All	143061 ⁵¹	...
-------	-----	-----	-----	-----	-----	-----	-----	-----	----------------------	-----

200 QUATTRO

89-90	Wagon	143057 ⁵¹
-------	-------	-----	-----	-----	----------------------	-----	-----	-----	-----	-----

4000

80-87	All	142195 ⁵³ 143057 ⁵¹	143061 ⁵¹	...
-------	-----	-----	-----	-----	----------------------------------------------	-----	-----	-----	----------------------	-----

4000 QUATTRO

84-87	All	142195 ⁵³ 143057 ⁵¹	143061 ⁵¹	...
-------	-----	-----	-----	-----	----------------------------------------------	-----	-----	-----	----------------------	-----

A3

12-13	All	...	G57277 ⁴⁰
	Exc. Electronic Suspension	...	G57277 ⁴⁰	G51799
06-11	All	...	G57277 ⁴⁰	...	143344 ⁵³	143345 ⁵³	...
	Exc. Electronic Suspension	...	G57277 ⁴⁰	...	143344 ⁵³	...	G51799	...	143345 ⁵³	...

A3 QUATTRO

06-13	Exc. Electronic Suspension	...	G57277 ⁴⁰	G51799
04-13	All	...	G57277 ⁴⁰

A4

01-08	All	G51740	G69586
00	All	G51740
96-99	Exc. Sport Suspension	G51097





A4 QUATTRO

01-08	Mfg. from 11/00; Exc. Sport Suspension	G69586
00-08	Mfg. from 11/00; Exc. Sport Suspension	G51740
96-00	Mfg. to 11/00; Exc. Sport Suspension	G51097

40 Complete Assembled Unit.

51 Strut Cushion for use with the Strut/Cartridge/Shocks.







APPLICATION GUIDE

Year	Fitment Notes										
		 Ultra	Ready Mounts	Max Control\ LTV Severe Duty\ ProGuard\ Guardian	Strut Cushion\ Strut Mount\ Dampers\ Stabilizer	HiJackers\ Load Carrier\ Classic	 Ultra	Ready Mounts	Max Control\ LTV Severe Duty\ ProGuard\ Guardian	Strut Cushion\ Strut Mount\ Dampers\ Stabilizer	HiJackers\ Load Carrier\ Classic









AUDI

AUDI



A6

00-04	Left Exc. Sport Suspension		G57135 ⁴⁰		69946	142653 ⁵³
	Right Exc. Sport Suspension		G57136 ⁴⁰		69946	142653 ⁵³
98-04	All			69946	142653 ⁵³



A6 QUATTRO

00-04	Left Exc. Sport Suspension		G57135 ⁴⁰		G51742
	Right Exc. Sport Suspension		G57136 ⁴⁰		G51742
98-04	All			G51742
95-97	All		143061 ⁵¹		G51742



COUPE

83-87	All		142195 ⁵³ 143057 ⁵¹		143061 ⁵¹
-------	-----	-----------------------------------------------------------------------------------	------	------	------	----------------------------------------------	------	-------------------------------------------------------------------------------------	------	------	------	----------------------	------



COUPE QUATTRO

90-91	All		142195 ⁵³ 143057 ⁵¹	
-------	-----	------------------------------------------------------------------------------------	------	------	------	----------------------------------------------	------	--------------------------------------------------------------------------------------	------	------	------	------	------





FOX

73-79	All		142091 ⁵⁴		143059 ⁵¹
-------	-----	-------------------------------------------------------------------------------------	------	------	------	----------------------	------	---------------------------------------------------------------------------------------	------	------	------	----------------------	------





QUATTRO

84-86	All			G51742
-------	-----	-------------------------------------------------------------------------------------	------	------	------	------	------	---------------------------------------------------------------------------------------	--------	------	------	------	------



TT

08-09	All		143344 ⁵³		143345 ⁵³
00-06	All		142651 ⁵⁴		69420

TT QUATTRO

08-10	All		143344 ⁵³		143345 ⁵³
00-06	All		142651 ⁵⁴	





V8 QUATTRO

90-94	All		143057 ⁵¹	
-------	-----	-------------------------------------------------------------------------------------	------	------	------	----------------------	------	---------------------------------------------------------------------------------------	------	------	------	------	------

AVANTI

AVANTI

II

89-91	All		69600		69724
87-88	All		69600		69604



40 Complete Assembled Unit.

53 Hardware from O.E. Part may need to be reused.

51 Strut Cushion for use with the Strut/Cartridge/Shocks.

54 Kit with Mount and Bearing. Hardware from O.E. Part may need to be reused.

APPLICATION GUIDE

Year	Fitment Notes										
		Ultra	Ready Mounts	Max Control\ LTV Severe Duty\ ProGuard\ Guardian	Strut Cushion\ Strut Mount\ Dampers\ Stabilizer	HiJackers\ Load Carrier\ Classic	Ultra	Ready Mounts	Max Control\ LTV Severe Duty\ ProGuard\ Guardian	Strut Cushion\ Strut Mount\ Dampers\ Stabilizer	HiJackers\ Load Carrier\ Classic

BMW

128i

08-13	All	70045 ⁹⁷
	Left Exc. Sport Suspension	G52142	G57363 ⁴⁰	70045 ⁹⁷
	Right Exc. Sport Suspension	G52143	G57364 ⁴⁰	70045 ⁹⁷

135i

08-13	Left Exc. Sport Suspension	G52142	G57363 ⁴⁰	70045 ⁹⁷
	Right Exc. Sport Suspension	G52143	G57364 ⁴⁰	70045 ⁹⁷
08-11	All	70045 ⁹⁷

318i

99	All	69863
92-98	All	143061 ⁵¹	...	69863	142135 ⁵³	...
91	All	143061 ⁵¹	...	69725	142135 ⁵³	...
84-85	All	143061 ⁵¹	...	69725	142135 ⁵³	...

318IS

92-98	All	143061 ⁵¹	...	69863	142135 ⁵³	...
91	All	143061 ⁵¹	...	69725	142135 ⁵³	...

318TI

95-99	All	143057 ⁵¹	...	69903	142135 ⁵³	...
-------	-----	-----	-----	-----	----------------------	-----	-------	-----	-----	----------------------	-----

323Ci

00	All	69863
	Coupe	143082 ⁵³	...	69863
	Coupe Left Exc. Sport Suspension	G52237	69863
	Coupe Right Exc. Sport Suspension	G52238	69863

323i

07-11	Left Exc. Sport Suspension	G52142
	Right Exc. Sport Suspension	G52143
00	Sedan Left Exc. Sport Suspension	G52237
	Sedan Right Exc. Sport Suspension	G52238
	Wagon	143082 ⁵³	...	69863
	Wagon Left Exc. Sport Suspension	G56750



40 Complete Assembled Unit.

53 Hardware from O.E. Part may need to be reused.

51 Strut Cushion for use with the Strut/Cartridge/Shocks.

97 Notice: The level of difficulty to install this product is moderately high. Please review Gabriel Technical Bulletin 70045 carefully before proceeding. (<https://gabriel.com/answergarage/lv-technical-bulletins>)



APPLICATION GUIDE

Year	Fitment Notes										
		Ultra	Ready Mounts	Max Control\ LTV Severe Duty\ ProGuard\ Guardian	Strut Cushion\ Strut Mount\ Dampers\ Stabilizer	HiJackers\ Load Carrier\ Classic	Ultra	Ready Mounts	Max Control\ LTV Severe Duty\ ProGuard\ Guardian	Strut Cushion\ Strut Mount\ Dampers\ Stabilizer	HiJackers\ Load Carrier\ Classic

BMW

BMW



323i (cont)

00	Wagon Right Exc. Sport Suspension		G56751	
98-99	All		143061 ⁵¹	69863	142135 ⁵³





323IS

98-99	All		69863
-------	-----	-----------------------------------------------------------------------------------	------	------	------	------	------	------	------	-------	------	------	------	------

325

87-88	All		143061 ⁵¹	69725	142135 ⁵³
86	All		69725















325CI

01-06	All		69863
	Left Exc. Sport Suspension		G52237	69863
	Right Exc. Sport Suspension		G52238	69863
	Sport Suspension; Exc. M-Sport Pack II		143082 ⁵³	69863

325E

84-87	All		143061 ⁵¹	69725	142135 ⁵³
-------	-----	-------------------------------------------------------------------------------------	------	------	------	----------------------	------	------	------	-------	------	------	----------------------	------

325i

06	All		70045 ⁹⁷
	Left Exc. Sport Suspension		G57363 ⁴⁰	70045 ⁹⁷
	Left Mfg. to 9/01; Sport Suspension		G52142	70045 ⁹⁷
	Mfg. to 9/01; Sport Suspension		143082 ⁵³	70045 ⁹⁷
	Right Exc. Sport Suspension		G57364 ⁴⁰	70045 ⁹⁷
	Right Mfg. to 9/01; Sport Suspension		G52143	70045 ⁹⁷
01-05	All		69863
	Mfg. to 9/01; Sport Suspension		143082 ⁵³	69863
	Sedan Left Exc. Sport Suspension		G52237	69863
	Sedan Right Exc. Sport Suspension		G52238	69863
	Wagon Left Mfg. to 9/01; Sport Suspension		G56750	69863
	Wagon Right Mfg. to 9/01; Sport Suspension		G56751	69863
92-95	E36(MfrBodyCode)		143061 ⁵¹	69863	142135 ⁵³
87-95	All		143061 ⁵¹	142135 ⁵³



40 Complete Assembled Unit.

53 Hardware from O.E. Part may need to be reused.

51 Strut Cushion for use with the Strut/Cartridge/Shocks.

97 Notice: The level of difficulty to install this product is moderately high. Please review Gabriel Technical Bulletin 70045 carefully before proceeding. (<https://gabriel.com/answergarage/lv-technical-bulletins>)

APPLICATION GUIDE

Year	Fitment Notes										
		Ultra	Ready Mounts	Max Control\ LTV Severe Duty\ ProGuard\ Guardian	Strut Cushion\ Strut Mount\ Dampers\ Stabilizer	HiJackers\ Load Carrier\ Classic	Ultra	Ready Mounts	Max Control\ LTV Severe Duty\ ProGuard\ Guardian	Strut Cushion\ Strut Mount\ Dampers\ Stabilizer	HiJackers\ Load Carrier\ Classic

BMW

BMW

325I (cont)

87-92	E30(MfrBodyCode) Exc. Sport Suspension	↓	143061 ⁵¹	↓	69725	142135 ⁵³
-------	----------------------------------------	---	------	------	------	----------------------	------	---	-------	------	------	----------------------	------

325IS

87-92	All	↓	143061 ⁵¹	↓	69725	142135 ⁵³
-------	-----	---	------	------	------	----------------------	------	---	-------	------	------	----------------------	------

325IX

88-91	All	↓	143061 ⁵¹	↓	142135 ⁵³
-------	-----	---	------	------	------	----------------------	------	---	------	------	------	----------------------	------

328CI

00	All	↓	143082 ⁵³	↓	69863
	Coupe Left Exc. Sport Suspension	↓	G52237	143082 ⁵³	↓	69863
	Coupe Right Exc. Sport Suspension	↓	G52238	143082 ⁵³	↓	69863

328D

14	All	↓	↓	70045 ⁹⁷
----	-----	---	------	------	------	------	------	---	---------------------	------	------	------	------

328D XDRIVE

14	All	↓	↓	70045 ⁹⁷
----	-----	---	------	------	------	------	------	---	---------------------	------	------	------	------

328I

07-14	Exc. F30 Suspension	↓	↓	70045 ⁹⁷
07-13	Left	↓	G52142	↓
	Left Exc. Sport Suspension	↓	G57363 ⁴⁰	↓
	Right	↓	G52143	↓
	Right Exc. Sport Suspension	↓	G57364 ⁴⁰	↓
99-00	All	↓	143082 ⁵³	↓	69863
96-98	All	↓	143061 ⁵¹	↓	69863	142135 ⁵³

328IS

96-99	All	↓	↓	69863
-------	-----	---	------	------	------	------	------	---	-------	------	------	------	------

328XI

07-08	All	↓	↓	70045 ⁹⁷
-------	-----	---	------	------	------	------	------	---	---------------------	------	------	------	------

330CI

01-06	All	↓	↓	69863
	Exc. Sport Suspension M-Sport Pack II	↓	143082 ⁵³	↓	69863
	Left Exc. Sport Suspension	↓	G52237	↓	69863
	Right Exc. Sport Suspension	↓	G52238	↓	69863



40 Complete Assembled Unit.

53 Hardware from O.E. Part may need to be reused.

51 Strut Cushion for use with the Strut/Cartridge/Shocks.

97 Notice: The level of difficulty to install this product is moderately high. Please review Gabriel Technical Bulletin 70045 carefully before proceeding. (<https://gabriel.com/answergarage/lv-technical-bulletins>)





APPLICATION GUIDE

Year	Fitment Notes										
		Ultra	Ready Mounts	Max Control\ LTV Severe Duty\ ProGuard\ Guardian	Strut Cushion\ Strut Mount\ Dampers\ Stabilizer	HiJackers\ Load Carrier\ Classic	Ultra	Ready Mounts	Max Control\ LTV Severe Duty\ ProGuard\ Guardian	Strut Cushion\ Strut Mount\ Dampers\ Stabilizer	HiJackers\ Load Carrier\ Classic









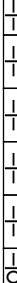

BMW

BMW





330Ci (cont)

01	Convertible Left Sport Suspension		G56750		69863
	Convertible Right Sport Suspension		G56751		69863









330i

06	All			70045 ⁹⁷
	Left		G52142		70045 ⁹⁷
	Left Exc. Sport Suspension		G57363 ⁴⁰		70045 ⁹⁷
	Right		G52143		70045 ⁹⁷
	Right Exc. Sport Suspension		G57364 ⁴⁰		70045 ⁹⁷
01-05	All			69863

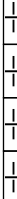

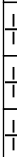

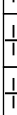
335D

09-11	Left		G52142	
	Right		G52143	











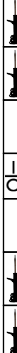

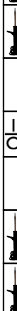
335i

07-13	All			70045 ⁹⁷
	Left		G52142		70045 ⁹⁷
	Left Exc. Sport Suspension		G57363 ⁴⁰		70045 ⁹⁷
	Right		G52143		70045 ⁹⁷
	Right Exc. Sport Suspension		G57364 ⁴⁰		70045 ⁹⁷

335iS

11-13	Left		G52142		70045 ⁹⁷
	Right		G52143		70045 ⁹⁷

525i

08	All			G51900
04-07	All		G52314		G51900
01-03	Sedan Exc. Electronic Adjustable Suspension		G56608	
	Wagon Exc. Electronic Adjustable Suspension			69998
92-95	All		143061 ⁵¹	
	Exc. Electronic Adjustable Suspension		G44493 ⁹⁸	143061 ⁵¹		142735 ⁵³
89-91	All		143061 ⁵¹		142735 ⁵³

40 Complete Assembled Unit.





53 Hardware from O.E. Part may need to be reused.

98 Notice: The level of difficulty to install this product is moderately high. Please review the installation instructions carefully before proceeding

51 Strut Cushion for use with the Strut/Cartridge/Shocks.

97 Notice: The level of difficulty to install this product is moderately high. Please review Gabriel Technical Bulletin 70045 carefully before proceeding. (<https://gabriel.com/answergarage/iv-technical-bulletins>)



APPLICATION GUIDE

Year	Fitment Notes										
		 Ultra	Ready Mounts	Max Control\ LTV Severe Duty\ ProGuard\ Guardian	Strut Cushion\ Strut Mount\ Dampers\ Stabilizer	HiJackers\ Load Carrier\ Classic	 Ultra	Ready Mounts	Max Control\ LTV Severe Duty\ ProGuard\ Guardian	Strut Cushion\ Strut Mount\ Dampers\ Stabilizer	HiJackers\ Load Carrier\ Classic









BMW

BMW









528E

82-88	All		143061 ⁵¹	
-------	-----	-----------------------------------------------------------------------------------	------	------	------	----------------------	------	-----------------------------------------------------------------------------------	------	------	------	------	------



528i

08-10	All		G52314	
99-00	Wagon			69998
97-00	Exc. Electronic Adjustable Suspension		143082 ⁵³	
	Sedan		G56608	









530i

08	All			G51900
04-07	All		G52314		G51900
01-03	Exc. Electronic Adjustable Suspension		G56608	
94-95	All		143061 ⁵¹		142735 ⁵³



533i

83-84	All		143061 ⁵¹	
-------	-----	-------------------------------------------------------------------------------------	------	------	------	----------------------	------	-------------------------------------------------------------------------------------	------	------	------	------	------



535i

08-10	All		G52314	
90-93	Mfg. from 8/90		143061 ⁵¹		142735 ⁵³
88-89	Mfg. from 8/90		143061 ⁵¹		142735 ⁵³
85-89	All		143061 ⁵¹	



535iS

88	All		143061 ⁵¹		142735 ⁵³
----	-----	-------------------------------------------------------------------------------------	------	------	------	----------------------	------	-------------------------------------------------------------------------------------	------	------	------	----------------------	------



540i

00-03	Wagon Exc. Electronic Adjustable Suspension			69998
-------	---------------------------------------------	-------------------------------------------------------------------------------------	------	------	------	------	------	-------------------------------------------------------------------------------------	-------	------	------	------	------



545i

04-05	All		G52314	
-------	-----	-------------------------------------------------------------------------------------	--------	------	------	------	------	-------------------------------------------------------------------------------------	------	------	------	------	------



550i

06-10	All		G52314	
-------	-----	-------------------------------------------------------------------------------------	--------	------	------	------	------	-------------------------------------------------------------------------------------	------	------	------	------	------



635CSI

85-89	All		143061 ⁵¹		143063 ⁵¹
-------	-----	-------------------------------------------------------------------------------------	------	------	------	----------------------	------	-------------------------------------------------------------------------------------	------	------	------	----------------------	------

735i

86-92	All		143061 ⁵¹	
-------	-----	-------------------------------------------------------------------------------------	------	------	------	----------------------	------	-------------------------------------------------------------------------------------	------	------	------	------	------



APPLICATION GUIDE

Year	Fitment Notes										
		Ultra	Ready Mounts	Max Control\ LTV Severe Duty\ ProGuard\ Guardian	Strut Cushion\ Strut Mount\ Dampers\ Stabilizer	HiJackers\ Load Carrier\ Classic	Ultra	Ready Mounts	Max Control\ LTV Severe Duty\ ProGuard\ Guardian	Strut Cushion\ Strut Mount\ Dampers\ Stabilizer	HiJackers\ Load Carrier\ Classic





BMW

BMW



735iL

88-92	All		143061 ⁵¹	
-------	-----	-----------------------------------------------------------------------------------	------	------	------	----------------------	------	-------------------------------------------------------------------------------------	------	------	------	------	------



740i

97-01	Exc. Electronic Adjustable Suspension		143083 ⁵³		143263 ⁵³
94-95	Exc. Electronic Adjustable Suspension		143083 ⁵³		143263 ⁵³

740iL

94-01	Exc. Electronic Adjustable Suspension		143083 ⁵³		143263 ⁵³
-------	---------------------------------------	-----------------------------------------------------------------------------------	------	------	------	----------------------	------	-------------------------------------------------------------------------------------	------	------	------	----------------------	------

750iL

94-01	Exc. Electronic Adjustable Suspension		143083 ⁵³	
-------	---------------------------------------	-----------------------------------------------------------------------------------	------	------	------	----------------------	------	-------------------------------------------------------------------------------------	------	------	------	------	------

M3

88-91	All			69725	142135 ⁵³
-------	-----	--	------	------	------	------	------	-------------------------------------------------------------------------------------	-------	------	------	----------------------	------





M5

00-03	All			143263 ⁵³
-------	-----	--	------	------	------	------	------	--------------------------------------------------------------------------------------	------	------	------	----------------------	------

X3

04-10	Left		G52199		70034
	Right		G52200		70034



















X5

00-06	All			G64046	143259 ⁵³
	Coil(FrontSpringType) Left		G52144		G64046	143259 ⁵³
	Coil(FrontSpringType) Right		G52145		G64046	143259 ⁵³

BUICK

BUICK

ALLURE

10	FWD, Left Exc. Electronic Suspension		G52278		70059
	FWD, Right Exc. Electronic Suspension		G52279		70059
05-09	All		G55948	G57060 ⁴⁰	142524 ⁵⁷ 142526 ⁵⁴		143061 ⁵¹
	Exc. Models w/ 17" Wheels		G55948	G57060 ⁴⁰	142524 ⁵⁷ 142526 ⁵⁴		G55949	143061 ⁵¹
	Left		G55948	G57060 ⁴⁰	142524 ⁵⁷ 142526 ⁵⁴		143073 ⁵³ 143061 ⁵¹
	Left Models w/ 16" Wheels		G55948	G57060 ⁴⁰	142524 ⁵⁷ 142526 ⁵⁴		G56924 ⁴⁰	143061 ⁵¹
	Models w/ 17" or 18" Wheels		G55948	G57060 ⁴⁰	142524 ⁵⁷ 142526 ⁵⁴		G52244	143061 ⁵¹
	Right		G55948	G57060 ⁴⁰	142524 ⁵⁷ 142526 ⁵⁴		143074 ⁵³ 143061 ⁵¹
	Right Models w/ 16" Wheels		G55948	G57060 ⁴⁰	142524 ⁵⁷ 142526 ⁵⁴		G56925 ⁴⁰	143061 ⁵¹

40 Complete Assembled Unit.



53 Hardware from O.E. Part may need to be reused.

67 Mount Kit. Hardware from O.E. Part may need to be reused.

51 Strut Cushion for use with the Strut/Cartridge/Shocks.

54 Kit with Mount and Bearing. Hardware from O.E. Part may need to be reused.

APPLICATION GUIDE

Year	Fitment Notes										
		Ultra	Ready Mounts	Max Control\ LTV Severe Duty\ ProGuard\ Guardian	Strut Cushion\ Strut Mount\ Dampers\ Stabilizer	HiJackers\ Load Carrier\ Classic	Ultra	Ready Mounts	Max Control\ LTV Severe Duty\ ProGuard\ Guardian	Strut Cushion\ Strut Mount\ Dampers\ Stabilizer	HiJackers\ Load Carrier\ Classic

BUICK

BUICK

APOLLO

74-75	All	69600	...	81494	...	34051 ⁸	69724 ⁵	...	81514	...	43049 ⁸ 49131 ³⁰
73	All	81494	...	34051 ⁸
	Exc. Heavy Duty Suspension	81494	...	34051 ⁸	82093
	Heavy Duty Suspension	81494	...	34051 ⁸	69724	...	81514	...	49157 ⁷

CENTURION

71-73	All	69675 ⁵	...	81446	...	34073 ⁸	69724 ⁵	...	81514	...	43049 ⁸ 49131 ³⁰
-------	-----	--------------------	-----	-------	-----	--------------------	--------------------	-----	-------	-----	-------------------------------------------

CENTURY

97-05	All	G55948	G57060 ⁴⁰	...	142524 ⁶⁷ 142526 ⁵⁴	...	G55949	143061 ⁵¹	...
	Left	G55948	G57060 ⁴⁰	...	142524 ⁶⁷ 142526 ⁵⁴	...	G55949	G56924 ⁴⁰	...	143073 ⁵³ 143061 ⁵¹	...
	Right	G55948	G57060 ⁴⁰	...	142524 ⁶⁷ 142526 ⁵⁴	...	G55949	G56925 ⁴⁰	...	143074 ⁵³ 143061 ⁵¹	...
78-81	All	69600	...	81494	...	34051 ⁸	69604	...	81492	...	43060 ⁸ 49334 ³⁰
73-77	All	69600	...	81494	...	34051 ⁸	69604	...	81492	...	43060 ⁸ 49152 ³⁰
58	All	81270	49310 ⁷ 82156
57	All	49310 ⁷ 82156
56	All	82087

COMMERCIAL CHASSIS

92-96	All	69675 ⁵	...	81446	...	34073 ⁸	43049 ⁸
91	All	69675 ⁵	...	81446	...	34073 ⁸

ELECTRA

85-90	All	G56701	142227 ⁶⁷ 143061 ⁵¹
	Air(RearSpringType) Conventional Replacement for Air Assist Rear Susp. Strut w/Upper Mount	G56701	142227 ⁶⁷ 143061 ⁵¹	G56726 ⁴¹
85-89	Estate Wagon	G56701	142227 ⁶⁷ 143061 ⁵¹	34073 ⁸
71-84	All	69675 ⁵	...	81446	...	34073 ⁸	69724	...	81514	...	43049 ⁸ 49131 ³⁰
65-70	All	82601	82602
61-64	All	82087	82609
59-60	Exc. Air Suspension	43140 ⁸ 82155

ENCLAVE

13-17	All	...	G57709 ⁴⁰	G64040
08-12	All	G52125	143366 ⁵³	...	G64040
	AWD	G52125	G57109 ⁴⁰	...	143366 ⁵³	...	G64040

5 Use kit No. 140719 to replace O.E. hardware for lower shock absorber mounting when studs break or self-tapping screws are not longer useable.

8 Pair Packs.

40 Complete Assembled Unit.

51 Strut Cushion for use with the Strut/Cartridge/Shocks.

54 Kit with Mount and Bearing. Hardware from O.E. Part may need to be reused.

7 Pair Packs, Air hose kit included.



30 For GM Vehicles equipped with factory installed leveling systems, see Ref A.

41 Complete Assembled Unit. See Ref. D for procedures to replace Elec Adj Susp with non-adj product.

53 Hardware from O.E. Part may need to be reused.

67 Mount Kit. Hardware from O.E. Part may need to be reused.

APPLICATION GUIDE

Year	Fitment Notes										
		Ultra	Ready Mounts	Max Control\ LTV Severe Duty\ ProGuard\ Guardian	Strut Cushion\ Strut Mount\ Dampers\ Stabilizer	HiJackers\ Load Carrier\ Classic	Ultra	Ready Mounts	Max Control\ LTV Severe Duty\ ProGuard\ Guardian	Strut Cushion\ Strut Mount\ Dampers\ Stabilizer	HiJackers\ Load Carrier\ Classic

BUICK

BUICK

ENCLAVE (cont)

08-11	FWD	I O	G52125	G57314 ⁴⁰	143366 ⁵³	O O	G64040
-------	-----	--------	--------	----------------------	------	----------------------	------	--------	--------	------	------	------	------

ENCORE

13-22	Left	I O	G52494	I O	G511030
	Right	I O	G52495	I O	G511030

ESTATE WAGON

71-83	All	I O	69675 ⁵	81446	34073 ⁸	O O	69604	81492	43060 ⁹ 49152 ³⁰
70	All	I O	82601	O O	69724	81514	49128 ³⁰

GRAN SPORT

65-67	All	I O	82138	O O	69604	81492	43060 ⁹ 49152 ³⁰
-------	-----	--------	------	------	------	------	-------	--------	-------	------	-------	------	-------------------------------------------

GS / GS350 / GS400 / GS455

68-72	All	I O	69600	81494	O O	69604	81492	43060 ⁹ 49152 ³⁰
-------	-----	--------	-------	------	-------	------	------	--------	-------	------	-------	------	-------------------------------------------

INVICTA

61-63	All	I O	82087	O O	82609
59-60	Exc. Air Suspension	I O	O O	43140 ⁹ 82155

LACROSSE

10-16	FWD, Left Exc. Electronic Suspension	I O	G52278	I O	70059
	FWD, Right Exc. Electronic Suspension	I O	G52279	I O	70059
05-09	All	I O	G55948	G57060 ⁴⁰	142524 ⁶⁷ 142526 ⁵⁴	I O	143061 ⁵¹
	Exc. Models w/ 17" Wheels	I O	G55948	G57060 ⁴⁰	142524 ⁶⁷ 142526 ⁵⁴	I O	G55949	143061 ⁵¹
	Left	I O	G55948	G57060 ⁴⁰	142524 ⁶⁷ 142526 ⁵⁴	I O	143073 ⁵³ 143061 ⁵¹
	Left Models w/ 16" Wheels	I O	G55948	G57060 ⁴⁰	142524 ⁶⁷ 142526 ⁵⁴	I O	G56924 ⁴⁰	143061 ⁵¹
	Models w/ 17" or 18" Wheels	I O	G55948	G57060 ⁴⁰	142524 ⁶⁷ 142526 ⁵⁴	I O	G52244	143061 ⁵¹
	Right	I O	G55948	G57060 ⁴⁰	142524 ⁶⁷ 142526 ⁵⁴	I O	143074 ⁵³ 143061 ⁵¹
	Right Models w/ 16" Wheels	I O	G55948	G57060 ⁴⁰	142524 ⁶⁷ 142526 ⁵⁴	I O	G56925 ⁴⁰	143061 ⁵¹

LESABRE

00-05	All	I O	G56509	142524 ⁶⁷	I O
	Exc. Electronic Adjustable Suspension	I O	G56509	G57051 ⁴⁰	142524 ⁶⁷	I O
	With OE Style air fitting	I O	G56509	142524 ⁶⁷	I O	49255 ⁷
	Without OE Style air fitting	I O	G56509	142524 ⁶⁷	I O	49228 ³⁰

5 Use kit No. 140719 to replace O.E. hardware for lower shock absorber mounting when studs break or self-tapping screws are not longer useable.

8 Pair Packs.

40 Complete Assembled Unit.

53 Hardware from O.E. Part may need to be reused.

67 Mount Kit. Hardware from O.E. Part may need to be reused.





7 Pair Packs, Air hose kit included.

30 For GM Vehicles equipped with factory installed leveling systems, see Ref A.

51 Strut Cushion for use with the Strut/Cartridge/Shocks.

54 Kit with Mount and Bearing. Hardware from O.E. Part may need to be reused.



































APPLICATION GUIDE

Year	Fitment Notes										
		 Ultra	Ready Mounts	Max Control\ LTV Severe Duty\ ProGuard\ Guardian	Strut Cushion\ Strut Mount\ Dampers\ Stabilizer	HiJackers\ Load Carrier\ Classic	 Ultra	Ready Mounts	Max Control\ LTV Severe Duty\ ProGuard\ Guardian	Strut Cushion\ Strut Mount\ Dampers\ Stabilizer	HiJackers\ Load Carrier\ Classic



BUICK

BUICK





LESABRE (cont)

97-99	All	 G56718 ⁹	M56718 ⁹	142524 ⁶⁷ 142530 ⁵⁴ 142751 ⁶⁷	
	Coil(RearSpringType)	 G56718 ⁹	M56718 ⁹	142524 ⁶⁷ 142530 ⁵⁴ 142751 ⁶⁷		G56726 ⁴³
91-96	All	 G56718 ⁹	M56718 ⁹	142751 ⁶⁷	
	Coil(RearSpringType)	 G56718 ⁹	M56718 ⁹	142751 ⁶⁷		G56726 ⁴³
90	All		142227 ⁶⁷ 142752 ⁶⁷	
	Early Design Front Strut w/ Spring Guard	 G56701	143061 ⁵¹ 142227 ⁶⁷ 142752 ⁶⁷	
	Late Design Front Strut without Spring Guard	 G56718 ⁹	M56718 ⁹	142227 ⁶⁷ 142752 ⁶⁷	
	Coil(RearSpringType)	 G56718 ⁹	142227 ⁶⁷ 142752 ⁶⁷		G56726 ⁴³
88-89	All	 G56701	142227 ⁶⁷ 142752 ⁶⁷ 143061 ⁵¹	34073 ⁸	
	Coil(RearSpringType)	 G56701	142227 ⁶⁷ 142752 ⁶⁷ 143061 ⁵¹	34073 ⁸		G56726 ⁴³
86-87	All	 G56701	142227 ⁶⁷ 142752 ⁶⁷ 143061 ⁵¹	
	Coil(RearSpringType)	 G56701	142227 ⁶⁷ 142752 ⁶⁷ 143061 ⁵¹		G56726 ⁴³
71-85	All	 69675 ⁵	81446	34073 ⁸		69724	81514	43049 ⁸ 49131 ³⁰
65-70	All		82601		82602
61-64	All		82087		82609
60	All			43140 ⁸ 82155
59	Exc. Air Suspension			43140 ⁸ 82155







LIMITED

58	All		81270		49310 ⁷ 82156
----	-----	-------------------------------------------------------------------------------------	------	-------	------	------	-------------------------------------------------------------------------------------	------	------	------	-----------------------------

LUCERNE

06-11	All		G57324 ⁴⁰	
	Exc. Magnetic Ride Control Suspension	 G52116	G57324 ⁴⁰		49228 ³⁰

PARK AVENUE

98-05	All		G56929 ⁴⁰	142524 ⁶⁷ 143057 ⁵¹	
	With OE Style air fitting	 G56929 ⁴⁰	142524 ⁶⁷ 143057 ⁵¹		49255 ⁷
	Without OE Style air fitting	 G56929 ⁴⁰	142524 ⁶⁷ 143057 ⁵¹		49228 ³⁰

5 Use kit No. 140719 to replace O.E. hardware for lower shock absorber mounting when studs break or self-tapping screws are not longer useable.

8 Pair Packs.

30 For GM Vehicles equipped with factory installed leveling systems, see Ref A.

43 Does not include springs due to vehicle design. See Ref. D for procedures to replace Elec Adj Susp with non-adj product.

54 Kit with Mount and Bearing. Hardware from O.E. Part may need to be reused.

7 Pair Packs, Air hose kit included.



9 See Ref. D for procedures to replace Elec Adj Susp with non-adj product.

40 Complete Assembled Unit.

51 Strut Cushion for use with the Strut/Cartridge/Shocks.

67 Mount Kit. Hardware from O.E. Part may need to be reused.

APPLICATION GUIDE

Year	Fitment Notes										
		Ultra	Ready Mounts	Max Control\ LTV Severe Duty\ ProGuard\ Guardian	Strut Cushion\ Strut Mount\ Dampers\ Stabilizer	HiJackers\ Load Carrier\ Classic	Ultra	Ready Mounts	Max Control\ LTV Severe Duty\ ProGuard\ Guardian	Strut Cushion\ Strut Mount\ Dampers\ Stabilizer	HiJackers\ Load Carrier\ Classic

BUICK

BUICK

PARK AVENUE (cont)

97	All	↓	142524 ⁵⁷ 142529 ⁵⁴ 143057 ⁵¹	↓
	With OE Style air fitting	↓	142524 ⁵⁷ 142529 ⁵⁴ 143057 ⁵¹	↓	49255 ⁷
	Without OE Style air fitting	↓	142524 ⁵⁷ 142529 ⁵⁴ 143057 ⁵¹	↓	49228 ³⁰
91-96	All	↓	G56718 ⁹	M56718 ⁹	142227 ⁵⁷ 142751 ⁵⁷	↓
	Air(RearSpringType) Conventional Replacement for Air Assist Susp; Exc. Elec. Adj. Susp.	↓	G56718 ⁹	M56718 ⁹	142227 ⁵⁷ 142751 ⁵⁷	↓	G56726 ⁴²

RAINIER

04-07	All	↓	G51718 ⁴⁵	G57022 ⁴⁰	143241 ⁵³	↓	61717 77971
	Coil(FrontSpringType)	↓	G51718 ⁴⁵	G57022 ⁴⁰	143241 ⁵³	↓	G63842	61717 77971

REGAL

17	FWD, Left Exc. Active Suspension	↓	G52435	↓	G51982
	FWD, Right Exc. Active Suspension	↓	G52436	↓	G51982
11-16	Left Exc. Active Suspension	↓	G52435	↓	G51982
	Right Exc. Active Suspension	↓	G52436	↓	G51982
97-04	All	↓	G55948	G57060 ⁴⁰	↓	G55949	143061 ⁵¹
	Exc. Heavy Duty Suspension	↓	G55948	G57060 ⁴⁰	142524 ⁵⁷ 142526 ⁵⁴	↓	G55949	143061 ⁵¹
	Left	↓	G55948	G57060 ⁴⁰	↓	G55949	G56924 ⁴⁰	143061 ⁵¹
	Left Exc. Heavy Duty Suspension	↓	G55948	G57060 ⁴⁰	↓	G55949	143073 ⁵³ 143061 ⁵¹
	Right	↓	G55948	G57060 ⁴⁰	↓	G55949	G56925 ⁴⁰	143061 ⁵¹
	Right Exc. Heavy Duty Suspension	↓	G55948	G57060 ⁴⁰	↓	G55949	143074 ⁵³ 143061 ⁵¹
88-96	All	↓	G44459 ³⁸	↓	M56708
	Exc. Heavy Duty Suspension	↓	G44459 ³⁸	142144 ⁵³	↓	M56708
78-87	All	↓	69600	81494	34051 ⁸	↓	69604	81492	43060 ⁸ 49334 ³⁰
73-77	All	↓	69600	81494	34051 ⁸	↓	69604	81492	43060 ⁸ 49152 ³⁰

RENDEZVOUS

02-07	All	↓	G57274 ⁴⁰	↓
	Exc. Hydraulic Self-Leveling System	↓	G57274 ⁴⁰	143091 ⁵³	↓	G63868	61777

7 Pair Packs, Air hose kit included.

9 See Ref. D for procedures to replace Elec Adj Susp with non-adj product.

36 Requires special strut installation tool.

42 Does not include springs due to vehicle design.

51 Strut Cushion for use with the Strut/Cartridge/Shocks.

54 Kit with Mount and Bearing. Hardware from O.E. Part may need to be reused.

8 Pair Packs.

30 For GM Vehicles equipped with factory installed leveling systems, see Ref A.











40 Complete Assembled Unit.

45 Strut must be rotated to align notch with lower control arm.

53 Hardware from O.E. Part may need to be reused.

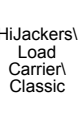
67 Mount Kit. Hardware from O.E. Part may need to be reused.



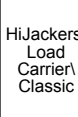

























APPLICATION GUIDE

Year	Fitment Notes										
		 Ultra	 Ready Mounts	 Max Control\ LTV Severe Duty\ ProGuard\ Guardian	 Strut Cushion\ Strut Mount\ Dampers\ Stabilizer	 HiJackers\ Load Carrier\ Classic	 Ultra	 Ready Mounts	 Max Control\ LTV Severe Duty\ ProGuard\ Guardian	 Strut Cushion\ Strut Mount\ Dampers\ Stabilizer	 HiJackers\ Load Carrier\ Classic

















BUICK

BUICK











RIVIERA

98-99	All		G56929 ⁴⁰	142524 ⁶⁷ 143057 ⁵¹	
	With OE Style air fitting		G56929 ⁴⁰	142524 ⁶⁷ 143057 ⁵¹		49255 ⁷
	Without OE Style air fitting		G56929 ⁴⁰	142524 ⁶⁷ 143057 ⁵¹		49228 ³⁰
97	All		143057 ⁵¹	
	With OE Style air fitting		143057 ⁵¹		49255 ⁷
	Without OE Style air fitting		143057 ⁵¹		49228 ³⁰
95-96	All		G56718 ⁹	M56718 ⁹	
	With OE Style air fitting		G56718 ⁹	M56718 ⁹		49255 ⁷
	Without OE Style air fitting		G56718 ⁹	M56718 ⁹		49228 ³⁰
91-93	All		142751 ⁶⁷	
86-89	All		143061 ⁵¹	
71-78	All		69675 ⁵	81446	34073 ⁸		69724	81514	43049 ⁸ 49131 ³⁰
66-70	All		82601		82618
63-65	All		82087		82609

ROADMASTER

92-96	All		69675 ⁵	81446	34073 ⁸	
	Sedan		69675 ⁵	81446	34073 ⁸		69724	81514	43049 ⁸ 49131 ³⁰
	Wagon		69675 ⁵	81446	34073 ⁸		69604	81492	43060 ⁸ 49152 ³⁰
91	All		81446	34073 ⁸	
	Wagon		69675 ⁵	81446	34073 ⁸		69604	81492	43060 ⁸ 49152 ³⁰
58	Exc. Air Suspension		81270		49310 ⁷ 82156
57	Exc. Air Suspension			49310 ⁷ 82156
56	Exc. Air Suspension		82087		81147

SKYLARK

95-98	All		143059 ⁵¹		81790
	Exc. FE3 and Electronic Ride Control		142227 ⁶⁷ 143059 ⁵¹		81790
92-94	All		143059 ⁵¹	
	Exc. FE3 and Electronic Ride Control		142224 ⁵⁴ 142227 ⁶⁷ 143059 ⁵¹	
75-79	All		69600	81494	34051 ⁸		82093

5 Use kit No. 140719 to replace O.E. hardware for lower shock absorber mounting when studs break or self-tapping screws are not longer useable.

8 Pair Packs.

30 For GM Vehicles equipped with factory installed leveling systems, see Ref A.

51 Strut Cushion for use with the Strut/Cartridge/Shocks.

67 Mount Kit. Hardware from O.E. Part may need to be reused.



7 Pair Packs, Air hose kit included.

9 See Ref. D for procedures to replace Elec Adj Susp with non-adj product.

40 Complete Assembled Unit.

54 Kit with Mount and Bearing. Hardware from O.E. Part may need to be reused.

APPLICATION GUIDE

Year	Fitment Notes										
		Ultra	Ready Mounts	Max Control\ LTV Severe Duty\ ProGuard\ Guardian	Strut Cushion\ Strut Mount\ Dampers\ Stabilizer	HiJackers\ Load Carrier\ Classic	Ultra	Ready Mounts	Max Control\ LTV Severe Duty\ ProGuard\ Guardian	Strut Cushion\ Strut Mount\ Dampers\ Stabilizer	HiJackers\ Load Carrier\ Classic

BUICK

SKYLARK (cont)

BUICK

69-72	All	⊕	69600	81494	34051 ⁸	⊕	69604	81492	43060 ⁸ 49152 ³⁰
68	All	⊕	69600	81494	⊕	69604	81492	43060 ⁸ 49152 ³⁰
	Heavy Duty Suspension	⊕	69600	81494	34051 ⁸	⊕	69604	81492	43060 ⁸ 49152 ³⁰
64-67	Exc. Heavy Duty Suspension		⊕	69724	81514	43049 ⁸ 49131 ³⁰
	Heavy Duty Suspension	⊕	82138	⊕	69604	81492	43060 ⁸ 49152 ³⁰
61-63	All		⊕	81495	43140 ⁸ 49205 ⁷

SPECIAL

68-69	All	⊕	69600	81494	34051 ⁸	⊕	69604	81492	43060 ⁸ 49152 ³⁰
64-67	Exc. Heavy Duty Suspension		⊕	69724	81514	43049 ⁸ 49131 ³⁰
	Heavy Duty Suspension	⊕	82138	⊕	69604	81492	43060 ⁸ 49152 ³⁰
61-63	All		⊕	81495	43140 ⁸ 49205 ⁷
58	Exc. Air Suspension	⊕	81270	⊕	49310 ⁷ 82156
57	Exc. Air Suspension		⊕	49310 ⁷ 82156
56	All	⊕	82087	⊕	81147

SPORTWAGON

70-72	All	⊕	69600	81494	34051 ⁸	⊕	69604	81492	43060 ⁸ 49152 ³⁰
68-69	All	⊕	69600	81494	34051 ⁸	⊕	69606	81495	43140 ⁸ 49205 ⁷
64-67	All	⊕	82138	⊕	69606	81495	43140 ⁸ 49205 ⁷

SUPER

58	Exc. Air Suspension	⊕	81270	⊕	49310 ⁷ 82156
57	Exc. Air Suspension		⊕	49310 ⁷ 82156
56	All		⊕	81147
	Exc. Air Suspension	⊕	82087	⊕	81147

TERRAZA

05-07	Exc. Auto-Leveling System	⊕	G52025	⊕
	FWD	⊕	G57142 ⁴⁰	142526 ⁵⁴	⊕
	FWD, Exc. Air-Leveling Suspension		⊕	G63776	49230 ⁷
05-06	AWD	⊕	G55948	⊕

VERANO

12-17	Left	⊕	G57377 ⁴⁰	⊕
	Right	⊕	G57378 ⁴⁰	⊕



7 Pair Packs, Air hose kit included.

30 For GM Vehicles equipped with factory installed leveling systems, see Ref A.
54 Kit with Mount and Bearing. Hardware from O.E. Part may need to be reused.

8 Pair Packs.

40 Complete Assembled Unit.

APPLICATION GUIDE

Year	Fitment Notes										
		Ultra	Ready Mounts	Max Control\ LTV Severe Duty\ ProGuard\ Guardian	Strut Cushion\ Strut Mount\ Dampers\ Stabilizer	HiJackers\ Load Carrier\ Classic	Ultra	Ready Mounts	Max Control\ LTV Severe Duty\ ProGuard\ Guardian	Strut Cushion\ Strut Mount\ Dampers\ Stabilizer	HiJackers\ Load Carrier\ Classic

CADILLAC

CADILLAC

DEVILLE (cont)

98-99	Coil(RearSpringType) Exc. Electronic Adjustable Suspension	⌚	G56664
94-97	Air(RearSpringType) Exc. Electronic Adjustable Suspension	⌚	G56664
91-93	All	⌚	142227 ⁶⁷ 142751 ⁶⁷	⌚
	Exc. Electronic Adjustable Suspension	⌚	G56718 ⁹	M56718 ⁹	142227 ⁶⁷ 142751 ⁶⁷	⌚
	Air(RearSpringType) Conventional Type Replacement for Air Assist Rear Suspension	⌚	142227 ⁶⁷ 142751 ⁶⁷	⌚	G56726 ⁴³
85-90	All	⌚	G56701	142227 ⁶⁷ 142752 ⁶⁷ 143061 ⁵¹	⌚
	Air(RearSpringType) Conventional Type Replacement for Air Assist Rear Suspension	⌚	G56701	142227 ⁶⁷ 142752 ⁶⁷ 143061 ⁵¹	⌚	G56726 ⁴³
77-84	All	⌚	69675 ⁵	81446	⌚	69724	81514	43049 ⁹ 49131 ⁹⁰
71-76	All	⌚	⌚	82602
69-70	All	⌚	⌚
65-68	All	⌚	⌚	82060
61-64	All	⌚	⌚	82125
58-60	All	⌚	⌚	82125
56	All	⌚	⌚	82034
55	All	⌚	⌚	82034
54	All	⌚	⌚	82066
53	All	⌚	⌚	82066

DTS

06-11	Exc. Magnetic Ride Control Suspension	⌚	G52116	G57324 ⁴⁰	⌚	49228 ⁹⁰
-------	---------------------------------------	---	--------	----------------------	-------	-------	---	-------	-------	-------	-------	---------------------

ELDORADO

97-02	Exc. Electronic Ride Control	⌚	142227 ⁶⁷	⌚	49254 ⁷
91-02	All	⌚	142227 ⁶⁷	⌚
86-89	All	⌚	143061 ⁵¹	⌚
71-78	All	⌚	82010	⌚
68-70	Vertically Mounted	⌚	82010	⌚	49122 ⁷
	Vertically Mounted; Single Leaf Rear Springs	⌚	⌚	82040
67	Vertically Mounted	⌚	82010	⌚	82034

ESCALADE

07-13	Exc. Electronic Ride Control	⌚	143316 ⁵³	⌚	G63866	58930 61675 77953
-------	------------------------------	---	-------	-------	-------	----------------------	-------	---	--------	-------	-------------------------	-------

5 Use kit No. 140719 to replace O.E. hardware for lower shock absorber mounting when studs break or self-tapping screws are not longer useable.

8 Pair Packs.

30 For GM Vehicles equipped with factory installed leveling systems, see Ref A.

43 Does not include springs due to vehicle design. See Ref. D for procedures to replace Elec Adj Susp with non-adj product.

53 Hardware from O.E. Part may need to be reused.

7 Pair Packs, Air hose kit included.



9 See Ref. D for procedures to replace Elec Adj Susp with non-adj product.

40 Complete Assembled Unit.

51 Strut Cushion for use with the Strut/Cartridge/Shocks.

67 Mount Kit. Hardware from O.E. Part may need to be reused.

APPLICATION GUIDE

Year	Fitment Notes										
		Ultra	Ready Mounts	Max Control\ LTV Severe Duty\ ProGuard\ Guardian	Strut Cushion\ Strut Mount\ Dampers\ Stabilizer	HiJackers\ Load Carrier\ Classic	Ultra	Ready Mounts	Max Control\ LTV Severe Duty\ ProGuard\ Guardian	Strut Cushion\ Strut Mount\ Dampers\ Stabilizer	HiJackers\ Load Carrier\ Classic

CADILLAC

CADILLAC

ESCALADE (cont)

07-13	AWD, Exc. Z55 Auto Ride Suspension		49235 ⁷	
	RWD, Exc. Electronic Ride Control		49155 ⁵	
02-06	All		77803	
	Exc. Electronic Ride Control		77803	
	NON-GAS-CHARGED		58803 77803	
	AWD, Exc. Z55 Auto Ride Suspension		77803	49235 ⁷	
	RWD, Exc. Electronic Ride Control		77803	49155 ⁵	
99-00	All		G63609	58609 61542 77609 81726	G63638	58638 61565 77638	43180 ⁹ 49231 ⁷

ESCALADE ESV

11-13	Exc. Electronic Ride Control		143316 ⁵³
07-10	Exc. Electronic Ride Control		143316 ⁵³	61675
03-06	Exc. Electronic Ride Control		61675

ESCALADE EXT

11-13	Exc. Electronic Ride Control		143316 ⁵³
07-10	Exc. Electronic Ride Control		143316 ⁵³	61675
05-06	Exc. Electronic Ride Control		61675
02-04	All		77803
	Exc. Electronic Ride Control		77803	61675
	NON-GAS-CHARGED		58803 77803

FLEETWOOD

94-96	All		34073 ⁸
	RWD		69675 ⁵	81446	34073 ⁸	69724	81514
93	All		G56718 ⁹	M56718 ⁹	142227 ⁶⁷ 142751 ⁶⁷	34073 ⁸
	Conventional Type Replacement for Air Assist Rear Suspension		G56718 ⁹	M56718 ⁹	142227 ⁶⁷ 142751 ⁶⁷	34073 ⁸	G56726 ⁴³
	RWD		69675 ⁵	81446 M56718 ⁹	142227 ⁶⁷ 142751 ⁶⁷	34073 ⁸	69724	81514
91-92	All		G56718 ⁹	M56718 ⁹	142227 ⁶⁷ 142751 ⁶⁷
	Conventional Type Replacement for Air Assist Rear Suspension		G56718 ⁹	M56718 ⁹	142227 ⁶⁷ 142751 ⁶⁷	G56726 ⁴³
87-90	All		G56701	142227 ⁶⁷ 142752 ⁶⁷ 143061 ⁵¹
	Conventional Type Replacement for Air Assist Rear Suspension		G56701	142227 ⁶⁷ 142752 ⁶⁷ 143061 ⁵¹	G56726 ⁴³

5 Use kit No. 140719 to replace O.E. hardware for lower shock absorber mounting when studs break or self-tapping screws are not longer useable.

8 Pair Packs.

30 For GM Vehicles equipped with factory installed leveling systems, see Ref A.

51 Strut Cushion for use with the Strut/Cartridge/Shocks.

67 Mount Kit. Hardware from O.E. Part may need to be reused.



7 Pair Packs, Air hose kit included.

9 See Ref. D for procedures to replace Elec Adj Susp with non-adj product.

43 Does not include springs due to vehicle design. See Ref. D for procedures to replace Elec Adj Susp with non-adj product.

53 Hardware from O.E. Part may need to be reused.

APPLICATION GUIDE

Year	Fitment Notes										
		Ultra	Ready Mounts	Max Control\ LTV Severe Duty\ ProGuard\ Guardian	Strut Cushion\ Strut Mount\ Dampers\ Stabilizer	HiJackers\ Load Carrier\ Classic	Ultra	Ready Mounts	Max Control\ LTV Severe Duty\ ProGuard\ Guardian	Strut Cushion\ Strut Mount\ Dampers\ Stabilizer	HiJackers\ Load Carrier\ Classic

CADILLAC

CADILLAC

FLEETWOOD (cont)

85-86	All		G56701	142227 ⁶⁷ 143061 ⁵¹	
	Conventional Type Replacement for Air Assist Rear Suspension		G56701	142227 ⁶⁷ 143061 ⁵¹	G56726 ⁴³
	RWD		69675 ⁵	81446	142227 ⁶⁷ 143061 ⁵¹	34073 ⁸		69724	81514
77-84	All		34073 ⁸	
	RWD		69675 ⁵	81446	34073 ⁸		69724	81514
71-76	All		82601		82602
69-70	All		82601	
65-68	All		82601		82060

FLEETWOOD / 60 SERIES / 70 SERIES

61-64	All		82109		82125
57-60	All		82099		82125
56	All		82099		82034
55	All		82034
54	All		82066
52-53	All		82026		82066
50-51	All		82026		82060

SEVILLE

98-04	All		142524 ⁶⁷
	Exc. Electronic Adjustable Suspension		G56509	G57051 ⁴⁰	142524 ⁶⁷
	w/ OE Style air fitting Exc. Electronic Adjustable Suspension		142524 ⁶⁷	49255 ⁷
	Without OE Style air fitting		142524 ⁶⁷	49228 ³⁰
90-97	All		142227 ⁶⁷
87-89	All		142227 ⁶⁷ 143061 ⁵¹
86	All		143061 ⁵¹
76-79	All		69600	81494	14018	34051 ⁸		82093

CHEVROLET

CHEVROLET

ASTRO

90-05	All			G63454	61539 77454 81581	49215 ⁷
	AWD		G63818	58609 61542 77609 81726		G63454	61539 77454 81581	49215 ⁷
	RWD		G63375 ⁵	61555 77375 81713 ⁵		G63454	61539 77454 81581	49215 ⁷

5 Use kit No. 140719 to replace O.E. hardware for lower shock absorber mounting when studs break or self-tapping screws are not longer useable.

8 Pair Packs.

40 Complete Assembled Unit.

51 Strut Cushion for use with the Strut/Cartridge/Shocks.

7 Pair Packs, Air hose kit included.



30 For GM Vehicles equipped with factory installed leveling systems, see Ref A.

43 Does not include springs due to vehicle design. See Ref. D for procedures to

replace Elec Adj Susp with non-adj product.

67 Mount Kit. Hardware from O.E. Part may need to be reused.

APPLICATION GUIDE

Year	Fitment Notes										
		Ultra	Ready Mounts	Max Control\ LTV Severe Duty\ ProGuard\ Guardian	Strut Cushion\ Strut Mount\ Dampers\ Stabilizer	HiJackers\ Load Carrier\ Classic	Ultra	Ready Mounts	Max Control\ LTV Severe Duty\ ProGuard\ Guardian	Strut Cushion\ Strut Mount\ Dampers\ Stabilizer	HiJackers\ Load Carrier\ Classic











CHEVROLET

ASTRO (cont)







85-89	RWD		G63375 ⁵	...	61555 77375 81713 ⁵		G63454	...	61539 77454 81581	...	49215 ⁷
-------	-----	-----------------------------------------------------------------------------------	---------------------	-----	--------------------------------------	-----	-----	-----------------------------------------------------------------------------------	--------	-----	-------------------------	-----	--------------------

CHEVROLET





AVALANCHE 1500

07-13	Exc. Electronic Ride Control		143316 ⁵³	...	
	Exc. Z55 or ZW7 Ride Suspension		G51891	G57125 ⁴⁰		G63866	...	58930 61675 77953 81930
02-13	4WD, Exc. Z55 Auto Ride Suspension			49235 ⁷
	RWD			49155 ⁷
02-06	Exc. Electronic Ride Control		G63803	...	58803 61643 77803 81922		G63866	...	58930 61675 77953 81930





























AVALANCHE 2500

02-06	Exc. Electronic Ride Control		G63817	...	58817 61663 77817 81925		G63866	...	58930 61675 77953 81930
	4WD, Exc. Z55 Auto Ride Suspension			49235 ⁷
	RWD			49155 ⁷

AVEO

04-11	Left		G56886	G57130 ⁴⁰	...	143239 ⁵³	...	
	Right		G56887	G57131 ⁴⁰	...	143239 ⁵³	...	

BEL AIR

81	All		77375	
	Sedan		77375		69724	...	81514	...	43049 ⁸ 49131 ³⁰
	Sedan Police and Taxi Models		G63375 ⁵	...	61555 77375	
	Sedan; Exc. Police and Taxi Models		69675 ⁵	...	81446 77375	...	34073 ⁸	
75	All		77375		69724	...	81514
	Sedan		77375		69724	...	81514	...	43049 ⁸ 49131 ³⁰
	Sedan Police and Taxi Models		G63375 ⁵	...	61555 77375		69724	...	81514
	Sedan; Exc. Police and Taxi Models		69675 ⁵	...	81446 77375	...	34073 ⁸		69724	...	81514
	Wagon		81713 ⁵ 77375		69724	...	81514
71-74	All		77375		69724	...	81514	...	43049 ⁸ 49131 ³⁰
	Sedan Police and Taxi Models		G63375 ⁵	...	61555 77375		69724	...	81514	...	43049 ⁸ 49131 ³⁰
	Sedan; Exc. Police and Taxi Models		69675 ⁵	...	81446 77375	...	34073 ⁸		69724	...	81514	...	43049 ⁸ 49131 ³⁰
	Wagon		81713 ⁵ 77375		69724	...	81514	...	43049 ⁸ 49131 ³⁰
65-70	All			69724	...	81514	...	43049 ⁸ 49131 ³⁰	

5 Use kit No. 140719 to replace O.E. hardware for lower shock absorber mounting when studs break or self-tapping screws are not longer useable.

8 Pair Packs.



40 Complete Assembled Unit.

7 Pair Packs, Air hose kit included.

30 For GM Vehicles equipped with factory installed leveling systems, see Ref A.

53 Hardware from O.E. Part may need to be reused.

APPLICATION GUIDE

Year	Fitment Notes										
		Ultra	Ready Mounts	Max Control\ LTV Severe Duty\ ProGuard\ Guardian	Strut Cushion\ Strut Mount\ Dampers\ Stabilizer	HiJackers\ Load Carrier\ Classic	Ultra	Ready Mounts	Max Control\ LTV Severe Duty\ ProGuard\ Guardian	Strut Cushion\ Strut Mount\ Dampers\ Stabilizer	HiJackers\ Load Carrier\ Classic

CHEVROLET

BEL AIR (cont)

65-70	Sedan; Exc. Police and Taxi Models	I	69675 ⁵	81446	34073 ⁸	O	69724	81514	43049 ⁸ 49131 ³⁰
58-64	All	I	82118	O	49131 ³⁰ 82051
55-57	All	I	69625	82099	O	82066
51-54	All	I	82026	O	43140 ⁸ 82155
50	All	I	82026	O
	Exc. Air Suspension	I	82026	O	43140 ⁸ 82155

CHEVROLET

BERETTA

95-96	All	I	142227 ⁶⁷ 143059 ⁵¹	O	81790
92-94	All	I	142224 ⁵⁴ 142227 ⁶⁷ 143059 ⁵¹	O

BISCAYNE

71-72	All	I	69675 ⁵	77375	34073 ⁸	O	69724	81514	43049 ⁸ 49131 ³⁰
	Exc. Police and Taxi Models	I	69675 ⁵	81446 77375	34073 ⁸	O	69724	81514	43049 ⁸ 49131 ³⁰
	Police and Taxi Models	I	69675 ⁵	61555 81713 ³ 77375	34073 ⁸	O	69724	81514	43049 ⁸ 49131 ³⁰
65-70	All	I	34073 ⁸	O	69724	81514	43049 ⁸ 49131 ³⁰
	Exc. Police and Taxi Models	I	81446	34073 ⁸	O	69724	81514	43049 ⁸ 49131 ³⁰
58-64	All	I	82118	O	49131 ³⁰ 82051

BLAZER 2WD

95-05	RWD; S Models, Exc. Xtreme Models	I	G63421	58421 61504 81750	34051 ⁸	O	G63422	58422 61528 77422 81482	43162 ⁸ 49213 ⁷
76-86	Single System Steering Stabilizer	O	6804SE 14017	O
75-86	All	O	14017	O
79-84	RWD; Dual System Steering Stabilizer	O	6802SE ⁸⁴ 14017	O
77-84	Exc. Lift Kit	O	14017	O	G63349	61524 81164	43111 ⁸
75-84	RWD	O	G63355	61525 81039	14017	34036 ⁸	O
75-76	Exc. Lift Kit	O	14017	O	G63349	61524 81164	43111 ⁸ 49155 ⁷
75	Single System Steering Stabilizer	O	6804SE ⁸⁰ 14017	O
73-74	Exc. Lift Kit	O	O	G63349	61524 81164	43111 ⁸ 49155 ⁷
69-74	RWD	O	G63355	61525 81039	34036 ⁸	O
69-72	Coil(RearSpringType)	O	O	49107 ⁷ 82003
	Leaf(RearSpringType)	O	O	49162 ⁷
	RWD	O	O	G63306

5 Use kit No. 140719 to replace O.E. hardware for lower shock absorber mounting when studs break or self-tapping screws are not longer useable.

8 Pair Packs.

51 Strut Cushion for use with the Strut/Cartridge/Shocks.

67 Mount Kit. Hardware from O.E. Part may need to be reused.

84 Replacement damper for vehicles with the Gabriel Aftermarket mounting kit



7 Pair Packs, Air hose kit included.

30 For GM Vehicles equipped with factory installed leveling systems, see Ref A.

54 Kit with Mount and Bearing. Hardware from O.E. Part may need to be reused.

80 Mounting bracket not required, install on O.E. Shock Mounts. See Ref. C for optional Steering Stabilizer Boots

APPLICATION GUIDE

Year	Fitment Notes										
		Ultra	Ready Mounts	Max Control\ LTV Severe Duty\ ProGuard\ Guardian	Strut Cushion\ Strut Mount\ Dampers\ Stabilizer	HiJackers\ Load Carrier\ Classic	Ultra	Ready Mounts	Max Control\ LTV Severe Duty\ ProGuard\ Guardian	Strut Cushion\ Strut Mount\ Dampers\ Stabilizer	HiJackers\ Load Carrier\ Classic

CHEVROLET

CHEVROLET

BLAZER 2WD (cont)

69-72	Single System Steering Stabilizer	○	6803SE ⁸⁴
-------	-----------------------------------	---	------	------	------	----------------------	------	------	------	------	------

BLAZER 4WD

95-05	4WD; S Models; Exc. ZR2	○	G63423	58423 61531 77423 81516	43162 ⁶ 49213 ⁷		
92-94	4WD, Full Size	○	G63609	58609 61542 77609 81726	43180 ⁶ 49231 ⁷		
87-91	4WD	○	14017		
	4WD, Full Size; Quad Suspension Long Shock; Exc. Lift Kit	○	61522 ⁵ 81496 ⁹		
	4WD; Exc. Quad Suspension and Lift Kit	○	G63347	61516 ⁵ 81113 ⁵		
	4WD; Full Size; Exc. Quad Suspension and Lift Kit	○	G63349	61524 81164	43111 ⁸ 49155 ⁷	
85-86	4WD; Exc. Quad Suspension and Lift Kit	○	G63347	14017	○	G63349	61524 81164	43111 ⁸
81-86	4WD, Quad Suspension Long Shock; Exc. Lift Kit	○	61522 ⁵ 81496 ⁹	14017	
	4WD, Quad Suspension Short Shock; Exc. Lift Kit	○	61516 ⁵ 81113 ⁵	14017	
79-86	4WD; Dual System Steering Stabilizer	○	6802SE ⁸⁴ 14017		
77-86	4WD, Exc. Lift Kit	○	14017	○	49155 ⁷	
76-86	Single System Steering Stabilizer	○	6804SE 14017		
75-86	All	○	14017		
81-84	4WD; Exc. Quad Suspension and Lift Kit	○	G63347	14017		
77-84	Exc. Lift Kit	○	14017	○	G63349	61524 81164	43111 ⁸
75-80	4WD; Exc. Quad Suspension and Lift Kit	○	G63347	61516 ⁵ 81113 ⁵	14017		
75-76	Exc. Lift Kit	○	14017	○	G63349	61524 81164	43111 ⁸ 49155 ⁷
75	Single System Steering Stabilizer	○	6804SE ⁸⁰ 14017		
73-74	Exc. Lift Kit	○	○	G63349	61524 81164	43111 ⁸ 49155 ⁷
69-74	4WD; Exc. Quad Suspension and Lift Kit	○	G63347	61516 ⁵ 81113 ⁵		
	RWD	○	G63355	61525 81039	34036 ⁸		
69-72	Coil(RearSpringType)	○	○	49107 ⁷ 82003	
	Leaf(RearSpringType)	○	○	49162 ⁷	
	Single System Steering Stabilizer	○	6803SE ⁸⁴		

BLAZER, S MODELS

88-94	4WD, Torsion Bar(FrontSpringType)	○	142316 ⁵³	○	G63422	58422 61528 77422 81482	43162 ⁶ 49213 ⁷
83-94	All	○	○	G63422	58422 61528 77422 81482	43162 ⁶ 49213 ⁷

6 It is recommended that when replacing shocks on vehicles with "quad shocks" all 4 shocks should be matched by series.

8 Pair Packs.

53 Hardware from O.E. Part may need to be reused.



84 Replacement damper for vehicles with the Gabriel Aftermarket mounting kit

7 Pair Packs, Air hose kit included.

50 Bellows Kit No. 141242 is recommended for use to protect piston rod from potentially harmful road debris.

80 Mounting bracket not required, install on O.E. Shock Mounts. See Ref. C for optional Steering Stabilizer Boots







APPLICATION GUIDE

Year	Fitment Notes										
		Ultra	Ready Mounts	Max Control\ LTV Severe Duty\ ProGuard\ Guardian	Strut Cushion\ Strut Mount\ Dampers\ Stabilizer	HiJackers\ Load Carrier\ Classic	Ultra	Ready Mounts	Max Control\ LTV Severe Duty\ ProGuard\ Guardian	Strut Cushion\ Strut Mount\ Dampers\ Stabilizer	HiJackers\ Load Carrier\ Classic





CHEVROLET

CHEVROLET



BLAZER, S MODELS (cont)

83-94	4WD		G63423	58423 61531 77423 81516		G63422	58422 61528 77422 81482	43162 ⁹ 49213 ⁷
	RWD		G63421	58421 61504 81750	34051 ⁸		G63422	58422 61528 77422 81482	43162 ⁹ 49213 ⁷
	Single system Steering Stabilizer; with a factory mounting hole in the steering linkage.		6801SE ⁸⁰		G63422	58422 61528 77422 81482	43162 ⁹ 49213 ⁷





































BROOKWOOD

71-72	All		69675 ⁵	81446	34073 ⁸		69604	81492
69-70	All		69675 ⁵	81446	34073 ⁸		69724	81514	43049 ⁹ 49131 ⁹⁰

C3500HD

91-02	HD Solid Front Axle			58488 61543	43163 ⁹
-------	---------------------	-----------------------------------------------------------------------------------	------	------	------	------	------	-------------------------------------------------------------------------------------	------	------	----------------	------	--------------------

CAMARO

13-15	SS, Left		G52395		G51916
	SS, Right		G52396		G51916
13	All			G51916
	3.6L V6 Left		G52280		G51916
	3.6L V6 Right		G52281		G51916
10-12	Left		143460 ⁶⁸		G51916	143461 ⁵³
	Right		143460 ⁶⁸		G51916	143462 ⁵³
	3.6L V6 Left		G52280	
	3.6L V6 Right		G52281	
	SS, Left		G52395		G51975
	SS, Right		G52396		G51975
93-02	Left		G57107 ⁴⁰		69676	75676 81481	49203 ⁷
	Right		G57108 ⁴⁰		69676	75676 81481	49203 ⁷
82-92	All		G56700		69676	75676 81481	49203 ⁷
70-81	All		69675 ⁵	81446	34073 ⁸		69624	81095	49135 ⁹⁰
68-69	All		69600	81494	34051 ⁸		49205 ⁷
	Multi Leaf Models		69600	81494	34051 ⁸		69606	81495	49205 ⁷
	Multi-Leaf Springs		69600	81494	34051 ⁸		43140 ⁹ 49205 ⁷

5 Use kit No. 140719 to replace O.E. hardware for lower shock absorber mounting when studs break or self-tapping screws are not longer useable.

8 Pair Packs.

40 Complete Assembled Unit.

68 Mount Kit. Hardware from O.E. Part may need to be reused.;



7 Pair Packs, Air hose kit included.

30 For GM Vehicles equipped with factory installed leveling systems, see Ref A.

53 Hardware from O.E. Part may need to be reused.

80 Mounting bracket not required, install on O.E. Shock Mounts. See Ref. C for optional Steering Stabilizer Boots

APPLICATION GUIDE

Year	Fitment Notes										
		Ultra	Ready Mounts	Max Control\ LTV Severe Duty\ ProGuard\ Guardian	Strut Cushion\ Strut Mount\ Dampers\ Stabilizer	HiJackers\ Load Carrier\ Classic	Ultra	Ready Mounts	Max Control\ LTV Severe Duty\ ProGuard\ Guardian	Strut Cushion\ Strut Mount\ Dampers\ Stabilizer	HiJackers\ Load Carrier\ Classic

CHEVROLET

CAMARO (cont)

68-69	Single Leaf Rear Springs	⊕	69600	81494	34051 ⁸	⊕	49122 ⁷ 82040 49205 ⁷
67	All	⊕	69600	81494	34051 ⁸	⊕
	Multi-Leaf Springs	⊕	69600	81494	34051 ⁸	⊕	43140 ⁸
	Single Leaf Rear Springs	⊕	69600	81494	34051 ⁸	⊕	82040
	Single Leaf Spring	⊕	69600	81494	34051 ⁸	⊕	49122 ⁷

CHEVROLET

CAPRICE

81-96	Sedan Police and Taxi Models	⊕	G63375 ⁵	61555 77375 81713 ⁵	34073 ⁸	⊕	69724	81514	43049 ⁸ 49131 ³⁰
77-96	Wagon	⊕	69675 ⁵	81446	34073 ⁸	⊕	69604	81492	43060 ⁸ 49152 ³⁰
71-96	All	⊕	69675 ⁵	34073 ⁸	⊕
75-80	Exc. Wagon	⊕	69675 ⁵	34073 ⁸	⊕	43049 ⁸ 49131 ³⁰
	Sedan Police and Taxi Models	⊕	G63375 ⁵	61555 77375 81713 ⁵	34073 ⁸	⊕	69724	81514
73-76	Wagon	⊕	69675 ⁵	81446	34073 ⁸	⊕	69604	81492	49152 ³⁰
73-74	Sedan Police and Taxi Models	⊕	G63375 ⁵	61555 77375 81713 ⁵	34073 ⁸	⊕	69724	81514	43049 ⁸ 49131 ³⁰
71-72	Police and Taxi Models	⊕	G63375 ⁵	61555	34073 ⁸	⊕	43049 ⁸
	Sedan; Police and Taxi Models	⊕	69675 ⁵	77375	34073 ⁸	⊕
	Hardtop Exc. Police and Taxi Models	⊕	69675 ⁵	81446	34073 ⁸	⊕
	Hardtop Police and Taxi Models	⊕	69675 ⁵	81713 ⁵	34073 ⁸	⊕	69724	81514	49131 ³⁰
	Wagon	⊕	69675 ⁵	34073 ⁸	⊕	69604	81492	49152 ³⁰
70	All	⊕	69675 ⁵	34073 ⁸	⊕	69724	81514	43049 ⁸ 49131 ³⁰
	Hardtop	⊕	69675 ⁵	81446	34073 ⁸	⊕	69724	81514	43049 ⁸ 49131 ³⁰
66-69	All	⊕	69675 ⁵	81446	34073 ⁸	⊕	69724	81514	43049 ⁸ 49131 ³⁰

CAPTIVA SPORT

12-15	Left	⊕	G57549 ⁴⁰	⊕
	Right	⊕	G57550 ⁴⁰	⊕

CAVALIER

99-05	All	⊕	G55698	G56951 ⁴⁰	143057 ⁵¹	⊕	G55825	G56938 ⁴⁰
95-98	All	⊕	G55698	G56939 ⁴⁰	142227 ⁶⁷ 143057 ⁵¹	⊕	G55825	G56938 ⁴⁰
87-94	All	⊕	143059 ⁵¹	⊕

CHEVELLE

68-73	All	⊕	69600	81494	34051 ⁸	⊕	69604	81492	43060 ⁸ 49152 ³⁰
64-67	All	⊕	82138	⊕

5 Use kit No. 140719 to replace O.E. hardware for lower shock absorber mounting when studs break or self-tapping screws are not longer useable.

8 Pair Packs.

40 Complete Assembled Unit.



67 Mount Kit. Hardware from O.E. Part may need to be reused.

7 Pair Packs, Air hose kit included.

30 For GM Vehicles equipped with factory installed leveling systems, see Ref A.

51 Strut Cushion for use with the Strut/Cartridge/Shocks.

APPLICATION GUIDE

Year	Fitment Notes										
		Ultra	Ready Mounts	Max Control\ LTV Severe Duty\ ProGuard\ Guardian	Strut Cushion\ Strut Mount\ Dampers\ Stabilizer	HiJackers\ Load Carrier\ Classic	Ultra	Ready Mounts	Max Control\ LTV Severe Duty\ ProGuard\ Guardian	Strut Cushion\ Strut Mount\ Dampers\ Stabilizer	HiJackers\ Load Carrier\ Classic

CHEVROLET

CHEVROLET

CHEVELLE (cont)

64-67	Exc. Heavy Duty Suspension		82138		69724	81514	43049 ⁸ 49131 ³⁰
	Heavy Duty Suspension		82138		69604	81492	43060 ⁸ 49152 ³⁰

CHEVETTE

76-87	All		81340	43140 ⁸
-------	-----	--	------	------	------	------	------	--	------	------	-------	------	--------------------

CHEVY II

68	All		69600	81494		69724	81514	43049 ⁸
	Multi-Leaf Rear Spring		69600	81494		69724	81514	49157 ⁷ 43049 ⁸
	Single Leaf Rear Springs		69600	81494		69724	81514	82093 43049 ⁸
62-67	All		82070		81242	43099 ⁸ 49173 ⁷

CITY EXPRESS

15-18	All			G64146
-------	-----	--	------	------	------	------	------	--	--------	------	------	------	------

CLASSIC

04-05	All		G56927 ⁴⁰	M55974	G56928 ⁴⁰	M56501	143057 ⁵¹
-------	-----	--	------	----------------------	--------	------	------	--	------	----------------------	--------	----------------------	------

COBALT

05-10	Exc. SS & Sport Models Left		G56810	G57047 ⁴⁰	143323 ⁵³		69587
	Exc. SS & Sport Models Right		G56810	G57048 ⁴⁰	143323 ⁵³		69587

COLORADO

15-22	Exc. ZR2		G57748 ⁴⁰		G63866
04-12	All		G57282 ⁴⁰
	RWD, Coil(FrontSpringType) D Standard Suspension; Exc. Z71 Off Road Package		G51850	G57282 ⁴⁰		G63882
	Torsion Bar(FrontSpringType)		G63884	G57282 ⁴⁰		G63879	77422	43162 ⁸ 49213 ⁷

CORSICA

95-96	All		142227 ⁵⁷ 143059 ⁵¹	81790
94	All		142227 ⁵⁷ 143059 ⁵¹
	Base		142224 ⁵⁴ 142227 ⁵⁷ 143059 ⁵¹
92-93	All		142224 ⁵⁴ 142227 ⁵⁷ 143059 ⁵¹

CORVAIR

60-64	All		82099	
-------	-----	--	------	------	------	------	-------	--	------	------	------	------	------

CORVAIR TRUCK

61-64	All		82099	
-------	-----	--	------	------	------	------	-------	--	------	------	------	------	------

7 Pair Packs, Air hose kit included.

30 For GM Vehicles equipped with factory installed leveling systems, see Ref A.

51 Strut Cushion for use with the Strut/Cartridge/Shocks.

54 Kit with Mount and Bearing. Hardware from O.E. Part may need to be reused.

Bold Type - New / Future Part



8 Pair Packs.

40 Complete Assembled Unit.

53 Hardware from O.E. Part may need to be reused.

67 Mount Kit. Hardware from O.E. Part may need to be reused.

APPLICATION GUIDE

Year	Fitment Notes										
		Ultra	Ready Mounts	Max Control\ LTV Severe Duty\ ProGuard\ Guardian	Strut Cushion\ Strut Mount\ Dampers\ Stabilizer	HiJackers\ Load Carrier\ Classic	Ultra	Ready Mounts	Max Control\ LTV Severe Duty\ ProGuard\ Guardian	Strut Cushion\ Strut Mount\ Dampers\ Stabilizer	HiJackers\ Load Carrier\ Classic

CHEVROLET

CORVETTE

97-13	Exc. Electronic Adjustable Suspension	⊕	G51904	⊕	G51871
89-96	Exc. Electronic Adjustable Suspension	⊕	69811 ⁹	⊕	69795 ⁹
88	All		⊕	69795 ⁹
84-87	All	⊕	69714	⊕	69715
63-82	All	⊕	69625	⊕	69622	81880	49304 ⁷
60-62	All	⊕	82026	⊕	43140 ⁸ 82155
53-59	All	⊕	82026	⊕	82039

CHEVROLET

CRUZE

11-15	Left	⊕	G57377 ⁴⁰	143473 ⁵³	⊕	G51971	143474 ⁵³
	Right	⊕	G57378 ⁴⁰	143473 ⁵³	⊕	G51971	143474 ⁵³
10	All	⊕	143473 ⁵³	⊕	143474 ⁵³

CRUZE LIMITED

16	All	⊕	143473 ⁵³	⊕	G51971	143474 ⁵³
	Left Exc. 3 Stud Mounts	⊕	G57377 ⁴⁰	143473 ⁵³	⊕	G51971	143474 ⁵³
	Right Exc. 3 Stud Mounts	⊕	G57378 ⁴⁰	143473 ⁵³	⊕	G51971	143474 ⁵³

DEL RAY

58	All	⊕	82118	⊕	49131 ³⁰ 82051
----	-----	---	------	------	------	------	-------	---	------	------	------	------	------------------------------

EL CAMINO

78-87	All	⊕	61504 81750	34051 ⁸	⊕	81492	43060 ⁸ 49334 ³⁰
68-77	All	⊕	61504 81750	34051 ⁸	⊕	81492	43060 ⁸ 49152 ³⁰
64-67	All	⊕	82138	⊕	81514	43049 ⁸
	Exc. Heavy Duty Suspension	⊕	82138	⊕	69724	81514	49131 ⁷ 43049 ⁸
59-60	All	⊕	82118	⊕	49131 ⁷ 82051

EQUINOX

14-17	All	⊕	⊕	G64140
	Left Exc. Models w/ 19" Wheels	⊕	G57197 ⁴⁰	⊕	G64140
	Left Exc. Sport Suspension	⊕	G52127	⊕	G64140
	Right Exc. Models w/ 19" Wheels	⊕	G57198 ⁴⁰	⊕	G64140
	Right Exc. Sport Suspension	⊕	G52128	⊕	G64140
07-13	All	⊕	⊕	G64015	61718
	Left Exc. Models w/ 19" Wheels	⊕	G57197 ⁴⁰	⊕	G64015	61718

7 Pair Packs, Air hose kit included.

9 See Ref. D for procedures to replace Elec Adj Susp with non-adj product.



40 Complete Assembled Unit.

8 Pair Packs.

30 For GM Vehicles equipped with factory installed leveling systems, see Ref A.















53 Hardware from O.E. Part may need to be reused.

APPLICATION GUIDE

Year	Fitment Notes										
		Ultra	Ready Mounts	Max Control\ LTV Severe Duty\ ProGuard\ Guardian	Strut Cushion\ Strut Mount\ Dampers\ Stabilizer	HiJackers\ Load Carrier\ Classic	Ultra	Ready Mounts	Max Control\ LTV Severe Duty\ ProGuard\ Guardian	Strut Cushion\ Strut Mount\ Dampers\ Stabilizer	HiJackers\ Load Carrier\ Classic



CHEVROLET

EQUINOX (cont)





07-13	Left Exc. Sport Suspension		G52127		G64015	61718
	Right Exc. Models w/ 19" Wheels		G57198 ⁴⁰		G64015	61718
	Right Exc. Sport Suspension		G52128		G64015	61718
07-12	Left Models w/ 19" Wheels		G57322 ⁴⁰		G64015	61718
	Right Models w/ 19" Wheels		G57323 ⁴⁰		G64015	61718
05-06	Left		G56773	G57110 ⁴⁰	143363 ⁵³		G64015	61718
	Right		G56774	G57111 ⁴⁰	143363 ⁵³		G64015	61718

CHEVROLET































EXPRESS 4500

09-22	All		G63895	61685		G63897	58638 61687 77638
-------	-----	-----------------------------------------------------------------------------------	--------	------	-------	------	------	-------------------------------------------------------------------------------------	--------	------	-------------------------	------	------

HHR

06-11	Exc. SS Models Left		G56810	G57047 ⁴⁰	143323 ⁵³		69587
	Exc. SS Models Right		G56810	G57048 ⁴⁰	143323 ⁵³		69587

IMPALA

17-20	Left		G57716 ⁴⁰		70204
	Right		G57717 ⁴⁰		70204
14-16	All		142524 ⁶⁷ 142526 ⁵⁴		70204	143061 ⁵¹
	Exc. Models w/ 17" Wheels		142524 ⁶⁷ 142526 ⁵⁴		G55949 70204	143061 ⁵¹
	Left		G57716 ⁴⁰	142524 ⁶⁷ 142526 ⁵⁴		70204	143061 ⁵¹
	Left Models w/ 16" Wheels		142524 ⁶⁷ 142526 ⁵⁴		70204	G56924 ⁴⁰	143061 ⁵¹
	Right		G57717 ⁴⁰	142524 ⁶⁷ 142526 ⁵⁴		70204	143061 ⁵¹
	Right Models w/ 16" Wheels		142524 ⁶⁷ 142526 ⁵⁴		70204	G56925 ⁴⁰	143061 ⁵¹
00-13	All		G55948	G57060 ⁴⁰	142524 ⁶⁷ 142526 ⁵⁴		143061 ⁵¹
	Exc. Models w/ 17" Wheels		G55948	G57060 ⁴⁰	142524 ⁶⁷ 142526 ⁵⁴		G55949	143061 ⁵¹
	Left Models w/ 16" Wheels		G55948	G57060 ⁴⁰	142524 ⁶⁷ 142526 ⁵⁴		G56924 ⁴⁰	143061 ⁵¹
	Right Models w/ 16" Wheels		G55948	G57060 ⁴⁰	142524 ⁶⁷ 142526 ⁵⁴		G56925 ⁴⁰	143061 ⁵¹
04-11	Models w/ 17" or 18" Wheels		G55948	G57060 ⁴⁰	142524 ⁶⁷ 142526 ⁵⁴		G52244	143061 ⁵¹
00-11	Left		G55948	G57060 ⁴⁰	142524 ⁶⁷ 142526 ⁵⁴		143073 ⁵³ 143061 ⁵¹
	Right		G55948	G57060 ⁴⁰	142524 ⁶⁷ 142526 ⁵⁴		143074 ⁵³ 143061 ⁵¹

40 Complete Assembled Unit.



53 Hardware from O.E. Part may need to be reused.

67 Mount Kit. Hardware from O.E. Part may need to be reused.

51 Strut Cushion for use with the Strut/Cartridge/Shocks.

54 Kit with Mount and Bearing. Hardware from O.E. Part may need to be reused.

APPLICATION GUIDE

Year	Fitment Notes										
		Ultra	Ready Mounts	Max Control\ LTV Severe Duty\ ProGuard\ Guardian	Strut Cushion\ Strut Mount\ Dampers\ Stabilizer	HiJackers\ Load Carrier\ Classic	Ultra	Ready Mounts	Max Control\ LTV Severe Duty\ ProGuard\ Guardian	Strut Cushion\ Strut Mount\ Dampers\ Stabilizer	HiJackers\ Load Carrier\ Classic

CHEVROLET

IMPALA (cont)

CHEVROLET

94-96	All		69675 ⁵	34073 ⁸		69724	81514	43049 ⁸ 49131 ³⁰
	Wagon; Exc. Police and Taxi Models		69675 ⁵	81446	34073 ⁸		69724	81514	43049 ⁸ 49131 ³⁰
83-85	All		69675 ⁵	34073 ⁸		69724	81514	43049 ⁸ 49131 ³⁰
	Sedan; Police and Taxi Models		G63375 ⁵	61555 77375 81713 ⁵	34073 ⁸		69724	81514	43049 ⁸ 49131 ³⁰
85	Wagon; Exc. Police and Taxi Models		69675 ⁵	81446	34073 ⁸		69724	81514	43049 ⁸ 49131 ³⁰
84	Exc. Police and Taxi Models		69675 ⁵	81446	34073 ⁸		69724	81514	43049 ⁸ 49131 ³⁰
83	Wagon; Exc. Police and Taxi Models		69675 ⁵	81446	34073 ⁸		69724	81514	43049 ⁸ 49131 ³⁰
73-82	Exc. Wagon		69675 ⁵	34073 ⁸		69724	81514	43049 ⁸ 49131 ³⁰
71-82	All		69675 ⁵	34073 ⁸		49131 ³⁰
	Sedan; Police and Taxi Models		G63375 ⁵	61555 77375 81713 ⁵	34073 ⁸		49131 ³⁰
	Wagon		69675 ⁵	34073 ⁸		69604	81492	43060 ⁸ 49152 ³⁰ 49131 ³⁰
	Wagon; Exc. Police and Taxi Models		69675 ⁵	81446	34073 ⁸		49131 ³⁰
65-72	Sedan		69675 ⁵	34073 ⁸		69724	81514	43049 ⁸ 49131 ³⁰
65-70	All		69675 ⁵	34073 ⁸		69724	49131 ³⁰
	Wagon; Exc. Police and Taxi Models		69675 ⁵	81446	34073 ⁸		69724	49131 ³⁰
59-64	All		82118		49131 ³⁰ 82051

IMPALA LIMITED

14-16	All		G55948
	Classic Body Style		G55948	G57060 ⁴⁰
	Exc. Models w/ 17" Wheels		G55948		G55949

KINGSWOOD

71-72	All		69675 ⁵	81446	34073 ⁸		69604	81492
69-70	All		69675 ⁵	81446	34073 ⁸		69724	81514	43049 ⁸ 49131 ³⁰

LUMINA

95-01	All		G44459 ³⁶	143061 ⁵¹
	Exc. Heavy Duty Suspension		G44459 ³⁶	142144 ⁵³	143061 ⁵¹
	Left		G44459 ³⁶	143071 ⁵³ 143073 ⁵³ 143061 ⁵¹
	Right		G44459 ³⁶	143072 ⁵³ 143074 ⁵³ 143061 ⁵¹
90-94	All		G44459 ³⁶	M56708

5 Use kit No. 140719 to replace O.E. hardware for lower shock absorber mounting when studs break or self-tapping screws are not longer useable.

30 For GM Vehicles equipped with factory installed leveling systems, see Ref A.

40 Complete Assembled Unit.



53 Hardware from O.E. Part may need to be reused.

8 Pair Packs.

36 Requires special strut installation tool.

51 Strut Cushion for use with the Strut/Cartridge/Shocks.

APPLICATION GUIDE

Year	Fitment Notes										
		Ultra	Ready Mounts	Max Control\ LTV Severe Duty\ ProGuard\ Guardian	Strut Cushion\ Strut Mount\ Dampers\ Stabilizer	HiJackers\ Load Carrier\ Classic	Ultra	Ready Mounts	Max Control\ LTV Severe Duty\ ProGuard\ Guardian	Strut Cushion\ Strut Mount\ Dampers\ Stabilizer	HiJackers\ Load Carrier\ Classic

CHEVROLET

LUMINA (cont)

90-94	Exc. Heavy Duty Suspension	○	G44459 ⁹⁸	142144 ⁵³	○	M56708
-------	----------------------------	---	----------------------	------	------	----------------------	------	---	------	------	--------	------	------

LUV PICKUP

81-82	All	○	○	G63492	61506 81318	49311 ⁷
	4WD	○	G63909	61508 77909 81507	○	G63492	61506 81318	49311 ⁷
	4WD; Single system Steering Stabilizer; with a factory mounting hole in the steering linkage.	○	6801SE ⁸⁰	○	G63492	61506 81318	49311 ⁷
	RWD	○	G63902	61501 81478	○	G63492	61506 81318	49311 ⁷
79-80	4WD; Single system Steering Stabilizer; with a factory mounting hole in the steering linkage.	○	G63909	61508 77909 81507	6801SE ⁸⁰	○	G63907	61500 77907 81147	43048 ⁸
72-80	All	○	G63909	61508 77909 81507	○	G63907	61500 77907 81147	43048 ⁸

MALIBU

08-12	All	○	○	143425 ⁶⁸
	Exc. Classic Models Left	○	143354 ⁵³	○	69590	143425 ⁶⁸
	Exc. Classic Models Right	○	143355 ⁵³	○	69590	143425 ⁶⁸
	Exc. Hybrid Models Left	○	G57069 ⁴⁰	○	143425 ⁶⁸
	Exc. Hybrid Models Right	○	G57070 ⁴⁰	○	143425 ⁶⁸
08-10	4Cyl: Exc. Classic and Hybrid Models Left	○	G57121 ⁴⁰	○	143425 ⁶⁸
	4Cyl: Exc. Classic and Hybrid Models Right	○	G57122 ⁴⁰	○	143425 ⁶⁸
08	Exc. Maxx Models	○	○	69589	143425 ⁶⁸
05-07	Exc. Classic Models Left	○	143354 ⁵³	○	69590
	Exc. Classic Models Right	○	143355 ⁵³	○	69590
	Exc. Hybrid Models Left	○	G57069 ⁴⁰	○
	Exc. Hybrid Models Right	○	G57070 ⁴⁰	○
	Exc. Maxx Models	○	○	69589
04	All	○	○	143425 ⁶⁸
	Exc. Classic Models Left	○	143354 ⁵³	○	69590	143425 ⁶⁸
	Exc. Classic Models Right	○	143355 ⁵³	○	69590	143425 ⁶⁸
	Exc. Hybrid Models Left	○	G57069 ⁴⁰	○	143425 ⁶⁸
	Exc. Hybrid Models Right	○	G57070 ⁴⁰	○	143425 ⁶⁸

7 Pair Packs, Air hose kit included.

36 Requires special strut installation tool.

53 Hardware from O.E. Part may need to be reused.



80 Mounting bracket not required, install on O.E. Shock Mounts. See Ref. C for optional Steering Stabilizer Boots

8 Pair Packs.

40 Complete Assembled Unit.

68 Mount Kit. Hardware from O.E. Part may need to be reused.;

APPLICATION GUIDE

Year	Fitment Notes										
		Ultra	Ready Mounts	Max Control\ LTV Severe Duty\ ProGuard\ Guardian	Strut Cushion\ Strut Mount\ Dampers\ Stabilizer	HiJackers\ Load Carrier\ Classic	Ultra	Ready Mounts	Max Control\ LTV Severe Duty\ ProGuard\ Guardian	Strut Cushion\ Strut Mount\ Dampers\ Stabilizer	HiJackers\ Load Carrier\ Classic

CHEVROLET

MALIBU (cont)

04	Exc. Maxx Models	69589	143425 ⁶⁸	...
98-03	Rear Strut Lower Mounting holes at 2.4" Apart	...	G56927 ⁴⁰	M55974	G56928 ⁴⁰	M56501	143057 ⁵¹	...
97-03	All	...	G56927 ⁴⁰	M55974	143057 ⁵¹	...
97-98	Rear Strut Lower Mounting holes at 3.2" Apart	...	G56927 ⁴⁰	M55974	M55975	143057 ⁵¹	...
78-83	All	69600	...	81494	...	34051 ⁸	69604	...	81492	...	43060 ⁸ 49334 ³⁰
73-77	All	69600	...	81494	...	34051 ⁸	69604	...	81492	...	43060 ⁸ 49152 ³⁰
64-67	All	82138
	Exc. Heavy Duty Suspension	82138	69724	...	81514	...	43049 ⁸ 49131 ³⁰
	Heavy Duty Suspension	82138	69604	...	81492	...	43060 ⁸ 49152 ³⁰

CHEVROLET

METRO

98-01	Non-ABS	143059 ⁵¹	...	G55772	143057 ⁵¹	...
-------	---------	-----	-----	-----	----------------------	-----	--------	-----	-----	----------------------	-----

MONTE CARLO

05-07	Models w/ 17" or 18" Wheels	G55948	G57060 ⁴⁰	...	142524 ⁶⁷ 142526 ⁵⁴	...	G52244	143059 ⁵¹	...
00-07	All	G55948	G57060 ⁴⁰	...	142524 ⁶⁷ 142526 ⁵⁴	143059 ⁵¹	...
	Exc. Models w/ 17" Wheels	G55948	G57060 ⁴⁰	...	142524 ⁶⁷ 142526 ⁵⁴	...	G55949	143059 ⁵¹	...
	Left	G55948	G57060 ⁴⁰	...	142524 ⁶⁷ 142526 ⁵⁴	143073 ⁵³ 143059 ⁵¹	...
	Left Models w/ 16" Wheels	G55948	G57060 ⁴⁰	...	142524 ⁶⁷ 142526 ⁵⁴	G56924 ⁴⁰	...	143059 ⁵¹	...
	Right	G55948	G57060 ⁴⁰	...	142524 ⁶⁷ 142526 ⁵⁴	143074 ⁵³ 143059 ⁵¹	...
	Right Models w/ 16" Wheels	G55948	G57060 ⁴⁰	...	142524 ⁶⁷ 142526 ⁵⁴	G56925 ⁴⁰	...	143059 ⁵¹	...
97-99	Left	G44459 ³⁶	142144 ⁵³	143073 ⁵³ 143059 ⁵¹	...
	Right	G44459 ³⁶	142144 ⁵³	143074 ⁵³ 143059 ⁵¹	...
95-99	All	G44459 ³⁶	142144 ⁵³	143059 ⁵¹	...
95-96	Left	G44459 ³⁶	142144 ⁵³	143071 ⁵³ 143073 ⁵³ 143059 ⁵¹	...
	Right	G44459 ³⁶	142144 ⁵³	143072 ⁵³ 143074 ⁵³ 143059 ⁵¹	...
73-88	All	69600	...	81494	...	34051 ⁸	69604	...	81492	...	43060 ⁸ 49334 ³⁰
70-72	All	69600	...	81494	...	34051 ⁸	69604	...	81492	...	43060 ⁸ 49152 ³⁰

NOVA

85-88	All	142134 ⁵³ 143059 ⁵¹	142249 ⁵³ 143058 ⁵¹	...
-------	-----	-----	-----	-----	----------------------------------------------	-----	-----	-----	-----	----------------------------------------------	-----

8 Pair Packs.

36 Requires special strut installation tool.

51 Strut Cushion for use with the Strut/Cartridge/Shocks.

54 Kit with Mount and Bearing. Hardware from O.E. Part may need to be reused.

68 Mount Kit. Hardware from O.E. Part may need to be reused.;



30 For GM Vehicles equipped with factory installed leveling systems, see Ref A.

40 Complete Assembled Unit.

53 Hardware from O.E. Part may need to be reused.

67 Mount Kit. Hardware from O.E. Part may need to be reused.

APPLICATION GUIDE

Year	Fitment Notes										
		Ultra	Ready Mounts	Max Control\ LTV Severe Duty\ ProGuard\ Guardian	Strut Cushion\ Strut Mount\ Dampers\ Stabilizer	HiJackers\ Load Carrier\ Classic	Ultra	Ready Mounts	Max Control\ LTV Severe Duty\ ProGuard\ Guardian	Strut Cushion\ Strut Mount\ Dampers\ Stabilizer	HiJackers\ Load Carrier\ Classic

CHEVROLET

NOVA (cont)

73-79	All	69600	81494	34051 ⁸	82093
73	Heavy Duty Suspension	69600	81494	34051 ⁸	69724	81514	49157 ⁷ 82093
69-72	All	69600	81494	34051 ⁸	69724	81514	43049 ⁹
	Multi-Leaf Rear Spring	69600	81494	34051 ⁸	69724	81514	49157 ⁷ 43049 ⁹
	Single Leaf Rear Springs	69600	81494	34051 ⁸	69724	81514	82093 43049 ⁹

CHEVROLET

ONE-FIFTY SERIES

55-57	All	69625	82099	82066
53-54	All	82026	43140 ⁹ 82155

OPTRA

06-08	All	143349 ⁸⁸	143350 ⁹³
-------	-----	------	------	------	----------------------	------	------	------	------	----------------------	------

PICKUP

60	All	82035	82086
	Dana 60 Axle up to 3 1/2" O.D. or Napco axle up to 3 3/8" O.D.	6803SE ⁸⁴	82035	82086
57-58	All	82047
	3100, 3200 & 3600 Models	82047	82060
	3800	82047	43140 ⁹ 82155
	Dana 60 Axle up to 3 1/2" O.D. or Napco axle up to 3 3/8" O.D.	6803SE ⁸⁴	82047
	Single System Steering Stabilizer; w/ I-Beam Axle	6802SE ⁸⁴	82047
55-56	All	G63405
	3200 & 3600 2nd Series	G63405	81147
	3800	G63405	61500 81147	43048 ⁸	43140 ⁹ 82155
	Single System Steering Stabilizer; w/ I-Beam Axle	G63405	6802SE ⁸⁴
55	3100	G63405	49311 ⁷
	3100, 3124 2nd Series	G63405	61500 81147	43048 ⁸	81318	49311 ⁷
	3100, 3200, 3600 & 3800	G63405	81270
54	All	43140 ⁹ 82155
	3100, 3200, 3600 & 3800	81270	43140 ⁹ 82155
	Single System Steering Stabilizer; w/ I-Beam Axle	6802SE ⁸⁴	43140 ⁹ 82155
50-53	3100, 3200, 3600 & 3800	81270	82066
	Single System Steering Stabilizer; w/ I-Beam Axle	6802SE ⁸⁴

PICKUP 1/2 TON, C10

75-86	All	G63355	61525 81039	34036 ⁸	G63349	61524 81164	43111 ⁸ 49155 ⁷
	Single System Steering Stabilizer	G63355	61525 81039	6802SE ⁸⁴	34036 ⁸	G63349	61524 81164	43111 ⁸ 49155 ⁷
73-74	All	G63355	61525 81039	34036 ⁸	61524 81164	43111 ⁸ 49155 ⁷

7 Pair Packs, Air hose kit included.



53 Hardware from O.E. Part may need to be reused.

84 Replacement damper for vehicles with the Gabriel Aftermarket mounting kit

8 Pair Packs.

68 Mount Kit. Hardware from O.E. Part may need to be reused.;

APPLICATION GUIDE

Year	Fitment Notes										
		Ultra	Ready Mounts	Max Control\ LTV Severe Duty\ ProGuard\ Guardian	Strut Cushion\ Strut Mount\ Dampers\ Stabilizer	HiJackers\ Load Carrier\ Classic	Ultra	Ready Mounts	Max Control\ LTV Severe Duty\ ProGuard\ Guardian	Strut Cushion\ Strut Mount\ Dampers\ Stabilizer	HiJackers\ Load Carrier\ Classic

CHEVROLET

CHEVROLET

PICKUP 1/2 TON, C10 (cont)

73-74	Single System Steering Stabilizer	⊖	G63355	61525 81039	6802SE ⁸⁴	34036 ⁸	⊖	61524 81164	43111 ⁸ 49155 ⁷
67-72	Coil(RearSpringType)	⊖	G63355	61525 81039	34036 ⁸	⊖	49107 ⁷ 82003
63-72	All	⊖	G63355	61525 81039	34036 ⁸	⊖
	Leaf(RearSpringType)	⊖	G63355	61525 81039	34036 ⁸	⊖	G63306	49162 ⁷
60-62	All	⊖	82035	⊖	82086

PICKUP 1/2 TON, C15 / C1500

92-99	Exc. OE Unit	⊖	G63489	58489 61544 77489 81668	6853SE ⁸⁶	34073 ⁸	⊖	G63488	58488 61543 77488 81667	43163 ⁸ 49218 ⁷
88-99	All	⊖	G63489	58489 61544 77489 81668	34073 ⁸	⊖	G63488	58488 61543 77488 81667	43163 ⁸ 49218 ⁷

PICKUP 1/2 TON, K10

81-86	Exc. Lift Kit	⊖	G63347	14017	⊖	G63349	61524 81164	43111 ⁸
	Quad Suspension Long Shock; Exc. Lift Kit	⊖	61522 ⁸ 81496 ⁸	14017	⊖
	Quad Suspension Short Shock; Exc. Lift Kit	⊖	61516 ⁸	14017	⊖
	Standard Suspension; Exc. Lift Kit	⊖	81113 ⁸	14017	⊖	49155 ⁷
73-86	All	⊖	14017	⊖
	Single System Steering Stabilizer	⊖	6804SE ⁸⁰ 14017	⊖
	Dual System Steering Stabilizer	⊖	6802SE ⁸⁴ 14017	⊖
73-80	Exc. Lift Kit	⊖	G63347	61516 ⁸ 81113 ⁸	14017	⊖	G63349	61524 81164	43111 ⁸ 49155 ⁷
69-72	All	⊖	G63347	⊖
	Exc. Lift Kit	⊖	G63347	61516 ⁸ 81113 ⁸	⊖
	Single System Steering Stabilizer	⊖	G63347	6803SE ⁸⁴	⊖
	Dual System Steering Stabilizer	⊖	G63347	6802SE ⁸⁴	⊖
67-68	Dual System Steering Stabilizer	⊖	6802SE ⁸⁴	⊖
61-68	Single System Steering Stabilizer	⊖	6803SE ⁸⁴	⊖

PICKUP 1/2 TON, K15 / K1500

88-99	All	⊖	G63818	58901 77609	⊖	G63488	58488 61543 77488 81667	43163 ⁸ 49218 ⁷
92-97	Exc. OE Unit	⊖	G63818	58901 77609	6853SE ⁸⁶	⊖	G63488	58488 61543 77488 81667	43163 ⁸ 49218 ⁷
88	Quad Suspension Long Shock; Exc. Lift Kit	⊖	G63818	61522 ⁸ 58901 77609	⊖	G63488	58488 61543 77488 81667	43163 ⁸ 49218 ⁷
	Quad Suspension Short Shock; Exc. Lift Kit	⊖	G63818	61516 ⁸ 58901 77609	⊖	G63488	58488 61543 77488 81667	43163 ⁸ 49218 ⁷

6 It is recommended that when replacing shocks on vehicles with "quad shocks" all 4 shocks should be matched by series.

8 Pair Packs.



84 Replacement damper for vehicles with the Gabriel Aftermarket mounting kit

7 Pair Packs, Air hose kit included.

80 Mounting bracket not required, install on O.E. Shock Mounts. See Ref. C for optional Steering Stabilizer Boots

86 Exc. OE Unit

APPLICATION GUIDE

Year	Fitment Notes										
		Ultra	Ready Mounts	Max Control\ LTV Severe Duty\ ProGuard\ Guardian	Strut Cushion\ Strut Mount\ Dampers\ Stabilizer	HiJackers\ Load Carrier\ Classic	Ultra	Ready Mounts	Max Control\ LTV Severe Duty\ ProGuard\ Guardian	Strut Cushion\ Strut Mount\ Dampers\ Stabilizer	HiJackers\ Load Carrier\ Classic

CHEVROLET

CHEVROLET

PICKUP 1/2 TON, R10

87	All	○	G63355	61525 81039	34036 ⁸	○	G63349	61524 81164	43111 ⁹
	RWD	○	G63355	61525 81039	34036 ⁸	○	G63349	61524 81164	49155 ⁷ 43111 ⁹
	Single System Steering Stabilizer	○	G63355	61525 81039	6802SE ⁸⁴	34036 ⁸	○	G63349	61524 81164	43111 ⁹

PICKUP 1/2 TON, SILVERADO 1500

19-22	All		○	43181 ⁹ 49235 ⁷	
19-21	Exc. Electronic Adjustable Suspension		○	77412	43181 ⁹ 49235 ⁷	
	Exc. Classic Models and Electronic Adjustable Suspension		○	G63959	61690	43181 ⁹ 49235 ⁷	
18	All	↓	G51949	○	43181 ⁹ 49235 ⁷	
	Exc. Electronic Adjustable Suspension	↓	G51949	○	77412	43181 ⁹ 49235 ⁷	
	4WD	↓	G51949	G57000 ⁴⁰	○	43181 ⁹ 49235 ⁷	
	Exc. Classic Models and Electronic Adjustable Suspension	↓	G51949	○	G63959	61690	43181 ⁹ 49235 ⁷	
	RWD, Exc. Electronic Ride Control	↓	G51949	G57023 ⁴⁰	○	43181 ⁹ 49235 ⁷	
14-17	All	↓	G51949	○	77976	43181 ⁹ 49235 ⁷	
	Exc. Electronic Adjustable Suspension	↓	G51949	○	77412 77976	43181 ⁹ 49235 ⁷	
	4WD	↓	G51949	G57000 ⁴⁰	○	77976	43181 ⁹ 49235 ⁷
	Exc. Classic Models and Electronic Adjustable Suspension	↓	G51949	○	G63959	61690 77976	43181 ⁹ 49235 ⁷	
	RWD, Exc. Electronic Ride Control	↓	G51949	G57023 ⁴⁰	○	77976	43181 ⁹ 49235 ⁷
07-13	All		○	77976	43181 ⁹ 49235 ⁷	
	Exc. Electronic Adjustable Suspension		○	77412 77976	43181 ⁹ 49235 ⁷	
	4WD	↓	G57000 ⁴⁰	○	77976	43181 ⁹ 49235 ⁷
	Exc. Classic Models and Electronic Adjustable Suspension	↓	G51870	143316 ⁵³	○	G63959	61690 77976	43181 ⁹ 49235 ⁷	
	RWD, Exc. Electronic Ride Control	↓	G57023 ⁴⁰	○	77976	43181 ⁹ 49235 ⁷
07	4WD; Classic and Old Body Style; Exc. Electronic Adjustable Suspension	↓	G63803	58803 61643 77803 81922	○	G63675	58412 61642 77412 81921 77976	43181 ⁹ 49235 ⁷	
	RWD, Exc. Electronic Adjustable Suspension		○	61600 77976	43181 ⁹ 49235 ⁷	
	RWD; Classic and Old Body Style; Exc. Electronic Adjustable Suspension		○	77662 77976	43181 ⁹ 49235 ⁷	
	RWD; Classic Models Only; Exc. Electronic Adjustable Suspension	↓	G63783	61641 77783 81920	○	G63662	58662 81873 77976	43181 ⁹ 49235 ⁷	
	RWD; Classic Models Only; Exc. Z55 Auto Ride Suspension		○	77976	49235 ⁷ 43181 ⁹

7 Pair Packs, Air hose kit included.



40 Complete Assembled Unit.

84 Replacement damper for vehicles with the Gabriel Aftermarket mounting kit

8 Pair Packs.

53 Hardware from O.E. Part may need to be reused.





APPLICATION GUIDE

Year	Fitment Notes										
		Ultra	Ready Mounts	Max Control\ LTV Severe Duty\ ProGuard\ Guardian	Strut Cushion\ Strut Mount\ Dampers\ Stabilizer	HiJackers\ Load Carrier\ Classic	Ultra	Ready Mounts	Max Control\ LTV Severe Duty\ ProGuard\ Guardian	Strut Cushion\ Strut Mount\ Dampers\ Stabilizer	HiJackers\ Load Carrier\ Classic





CHEVROLET

CHEVROLET













PICKUP 1/2 TON, SILVERADO 1500 (cont)

99-06	4WD; Classic and Old Body Style; Exc. Electronic Adjustable Suspension		G63803	...	58803 61643 77803 81922		G63675	...	58412 61642 77412 81921
	RWD; Classic Models Only; Exc. Electronic Adjustable Suspension		G63783	...	61641 77783 81920		G63662	...	58662 61600 77662 81873	...	43181 ⁸ 49235 ⁷





























PICKUP 1/2 TON, SILVERADO 1500 HD

05-06	All		G63817	...	58817 61663 77817 81925		G63675	...	58412 61642 77412 81921
01-03	All		G63817	...	58817 61663 77817 81925		G63675	...	58412 61642 77412 81921



PICKUP 1/2 TON, V10

87	All		14017	...		49155 ⁷
	Exc. Lift Kit		G63347	14017	...		G63349	...	61524 81164	...	43111 ⁸ 49155 ⁷
	Quad Suspension Long Shock; Exc. Lift Kit		61522 ⁵ 81496 ⁶	14017	...		49155 ⁷
	Quad Suspension Short Shock; Exc. Lift Kit		61516 ⁵ 81113 ⁶	14017	...		49155 ⁷
	Single System Steering Stabilizer		6804SE ⁸⁰ 14017	...		49155 ⁷
	Dual System Steering Stabilizer		6802SE ⁸⁴ 14017	...		49155 ⁷

PICKUP 3/4 TON, C20

75-86	All		G63355	...	61525 81039	
	Crew Cab Pickup		G63355	...	61525 81039	...	34036 ⁶		G63366
	Single System Steering Stabilizer		G63355	...	61525 81039	6802SE ⁸⁴	...	
	Standard Cab Pickup		G63355	...	61525 81039	...	34036 ⁶		G63349	...	61524 81164	...	43111 ⁸ 49155 ⁷
73-74	Crew Cab Pickup		G63355	...	61525 81039	...	34036 ⁶	
	Single System Steering Stabilizer		6802SE ⁸⁴	...		
	Standard Cab Pickup			...	61524 81164	...	43111 ⁸ 49155 ⁷	
67-72	All		G63355	...	61525 81039	...	34036 ⁶		G63306
	Coil(RearSpringType)		G63355	...	61525 81039	...	34036 ⁶		G63306	49107 ⁷ 82003
	Leaf(RearSpringType)		G63355	...	61525 81039	...	34036 ⁶		G63306	49162 ⁷
	Single System Steering Stabilizer		G63355	...	61525 81039	6802SE ⁸⁴	34036 ⁶		G63306
63-66	All		G63355	...	61525 81039	...	34036 ⁶		G63306	49162 ⁷
	Single System Steering Stabilizer		G63355	...	61525 81039	6802SE ⁸⁴	34036 ⁶		G63306	49162 ⁷
60-62	All		82035		82086

PICKUP 3/4 TON, C25 / C2500

88-00	All		G63489	...	58489 61544 77489 81668	...	34073 ⁶		G63488	...	58488 61543 77488 81667	...	43163 ⁸ 49218 ⁷
-------	-----	-------------------------------------------------------------------------------------	--------	-----	----------------------------------	-----	--------------------	-------------------------------------------------------------------------------------	--------	-----	----------------------------------	-----	------------------------------------------



6 It is recommended that when replacing shocks on vehicles with "quad shocks" all 4 shocks should be matched by series.

8 Pair Packs.

7 Pair Packs, Air hose kit included.

80 Mounting bracket not required, install on O.E. Shock Mounts. See Ref. C for optional Steering Stabilizer Boots

APPLICATION GUIDE

Year	Fitment Notes										
		Ultra	Ready Mounts	Max Control\ LTV Severe Duty\ ProGuard\ Guardian	Strut Cushion\ Strut Mount\ Dampers\ Stabilizer	HiJackers\ Load Carrier\ Classic	Ultra	Ready Mounts	Max Control\ LTV Severe Duty\ ProGuard\ Guardian	Strut Cushion\ Strut Mount\ Dampers\ Stabilizer	HiJackers\ Load Carrier\ Classic

CHEVROLET

CHEVROLET

PICKUP 3/4 TON, C25 / C2500 (cont)

92-99	Exc. OE Unit	I O	G63489	58489 61544 77488 81668	6853SE ⁸⁶	34073 ⁸	O O	G63488	58488 61543 77488 81667	43163 ⁹ 49218 ⁷
-------	--------------	--------	--------	------	----------------------------------	----------------------	--------------------	--------	--------	------	----------------------------------	------	------------------------------------------

PICKUP 3/4 TON, K20

81-86	Exc. Lift Kit	O O	G63347	14017	O O	G63349	61524 81164	43111 ⁹
	Quad Suspension Long Shock; Exc. Lift Kit	O O	61522 ⁶ 81496 ⁶	14017	O O
	Quad Suspension Short Shock; Exc. Lift Kit	O O	61516 ⁶	14017	O O
	Standard Suspension; Exc. Lift Kit	O O	81113 ⁶	14017	O O	49155 ⁷
73-86	All	O O	14017	O O
	Single System Steering Stabilizer	O O	6804SE ⁸⁰ 14017	O O
	Dual System Steering Stabilizer	O O	6802SE ⁸⁴ 14017	O O
75-80	Exc. Lift Kit	O O	G63347	61516 ⁶ 81113 ⁶	14017	O O	G63349	61524 81164	43111 ⁹ 49155 ⁷
73-74	Exc. Lift Kit	O O	G63347	61516 ⁶ 81113 ⁶	14017	O O	61524 81164	43111 ⁹ 49155 ⁷
69-72	Exc. Lift Kit	O O	G63347	61516 ⁶ 81113 ⁶	O O
67-72	Dual System Steering Stabilizer	O O	6802SE ⁸⁴	O O
61-72	Single System Steering Stabilizer	O O	6803SE ⁸⁴	O O

PICKUP 3/4 TON, K25 / K2500

99-00	Exc. OE Unit	O O	G63609	58609 61542 77609 81726	6853SE ⁸⁶	O O	G63488	58488 61543 77488 81667	43163 ⁹ 49218 ⁷
88-00	All	O O	G63609	58609 61542 77609 81726	O O	G63488	58488 61543 77488 81667	43163 ⁹ 49218 ⁷

PICKUP 3/4 TON, R20

87-88	All	O O	G63355	61525 81039	O O
	Crew Cab Pickup	O O	G63355	61525 81039	34036 ⁸	O O	G63366
	Single System Steering Stabilizer	O O	G63355	61525 81039	6802SE ⁸⁴	O O
87	Standard Cab Pickup	O O	G63355	61525 81039	O O	G63349	61524 81164	43111 ⁹ 49155 ⁷

PICKUP 3/4 TON, R2500

89	All	O O	G63355	61525 81039	34036 ⁸	O O	G63366
	Single System Steering Stabilizer	O O	G63355	61525 81039	6802SE ⁸⁴	34036 ⁸	O O	G63366

PICKUP 3/4 TON, SILVERADO 2500

11-18	All		O O	G64121
05-08	All	I O	G63817	58817 61663 77817 81925	O O	G63675	58412 61642 77412 81921
99-04	All		O O	G63675	58412 61642 77412 81921

6 It is recommended that when replacing shocks on vehicles with "quad shocks" all 4 shocks should be matched by series.

8 Pair Packs.



84 Replacement damper for vehicles with the Gabriel Aftermarket mounting kit

7 Pair Packs, Air hose kit included.

80 Mounting bracket not required, install on O.E. Shock Mounts. See Ref. C for optional Steering Stabilizer Boots

86 Exc. OE Unit





APPLICATION GUIDE

Year	Fitment Notes										
		Ultra	Ready Mounts	Max Control\ LTV Severe Duty\ ProGuard\ Guardian	Strut Cushion\ Strut Mount\ Dampers\ Stabilizer	HiJackers\ Load Carrier\ Classic	Ultra	Ready Mounts	Max Control\ LTV Severe Duty\ ProGuard\ Guardian	Strut Cushion\ Strut Mount\ Dampers\ Stabilizer	HiJackers\ Load Carrier\ Classic















CHEVROLET

CHEVROLET











PICKUP 3/4 TON, SILVERADO 2500 (cont)

99-04	4WD		G63817	58817 61663 77817 81925		G63675	58412 61642 77412 81921
	RWD, Exc. Electronic Adjustable Suspension		G63783	61641 77783 81920		G63675	58412 61642 77412 81921

















PICKUP 3/4 TON, SILVERADO 2500 HD

21-22	All		G64148		G64121	43181 ⁸
11-20	All		G64148		G64121	77976	43181 ⁸
01-10	All			G63675	58412 61642 77412 81921
	9200# GVW		G63817	58817 61663 77817		G63675	58412 61642 77412 81921
01-09	9200# GVW w/ OE Unit - 15059138 15155638		6853SE ⁸²		G63675	58412 61642 77412 81921
	9200# GVW w/o OE Unit - 15059138 15155638		6803SE ⁸⁴		G63675	58412 61642 77412 81921
01-04	RWD		G63783	61641 77783 81920		G63675	58412 61642 77412 81921



PICKUP 3/4 TON, V20

87	All		14017		49155 ⁷
	Exc. Quad Suspension and Lift Kit		G63347	61516	14017		G63349	61524 81164	43111 ⁸ 49155 ⁷
	Quad Suspension Long Shock; Exc. Lift Kit		61522 ⁸ 81496 ⁸	14017		49155 ⁷
	Single System Steering Stabilizer		6804SE ⁸⁰ 14017		49155 ⁷
	Dual System Steering Stabilizer		6802SE ⁸⁴ 14017		49155 ⁷

PICKUP 1 TON, C30

75-86	All		G63355	61525 81039	34036 ⁸		G63366
	Single System Steering Stabilizer; with Cooler		G63355	61525 81039	6802SE ⁸⁴	34036 ⁸		G63366
73-74	Single System Steering Stabilizer; with Cooler		G63355	61525 81039	6802SE ⁸⁴	34036 ⁸	
63-74	All		G63355	61525 81039	34036 ⁸	
67-72	Exc. 11,000# Rear Axle		G63355	61525 81039	34036 ⁸		G63306	49162 ⁷
63-72	Single System Steering Stabilizer		G63355	61525 81039	6802SE ⁸⁴	34036 ⁸	
61-62	All		82035	
	Single System Steering Stabilizer		6802SE ⁸⁴	82035	

PICKUP 1 TON, C35/3500

98-00	Crew Cab; Exc. HD Straight Front Axle		G63489	58489 61544		G63488	77488	49218 ⁷
-------	---------------------------------------	-------------------------------------------------------------------------------------	--------	------	----------------	------	------	-------------------------------------------------------------------------------------	--------	------	-------	------	--------------------

6 It is recommended that when replacing shocks on vehicles with "quad shocks" all 4 shocks should be matched by series.

8 Pair Packs.



82 Use kit if listed, See Ref. C for optional Steering Stabilizer Boots.

7 Pair Packs, Air hose kit included.

80 Mounting bracket not required, install on O.E. Shock Mounts. See Ref. C for optional Steering Stabilizer Boots

84 Replacement damper for vehicles with the Gabriel Aftermarket mounting kit

APPLICATION GUIDE

Year	Fitment Notes										
		Ultra	Ready Mounts	Max Control\ LTV Severe Duty\ ProGuard\ Guardian	Strut Cushion\ Strut Mount\ Dampers\ Stabilizer	HiJackers\ Load Carrier\ Classic	Ultra	Ready Mounts	Max Control\ LTV Severe Duty\ ProGuard\ Guardian	Strut Cushion\ Strut Mount\ Dampers\ Stabilizer	HiJackers\ Load Carrier\ Classic

CHEVROLET

CHEVROLET

PICKUP 1 TON, C35/3500 (cont)

92-00	Exc. HD Straight Front Axle	⊖	81668	⊖	77488	49218 ⁷
	Exc. HD Straight Front Axle	⊖	G63489	58489 61544 77489	⊖	G63488	77488	49218 ⁷
	Extended & Standard Cab; Exc. HD Straight Front Axle	⊖	⊖	81667 77488	49218 ⁷
91-00	All	⊖	⊖	77488	49218 ⁷
	Extended & Standard Cab; Exc. Straight Front Axle	⊖	34073 ⁸	⊖	77488	49218 ⁷
92-97	Crew Cab; Exc. HD Straight Front Axle	⊖	G63489	58489 61544 77489	⊖	G63488	77488	49218 ⁷
91	Cab & Chassis; Exc. HD Solid Front Axle	⊖	G63355	61525 81039	34036 ⁸	⊖	G63366	77488	49218 ⁷
	Extended & Standard Cab; Exc. HD Straight Front Axle	⊖	G63489	58489 61544 77489 81668	⊖	G63488	81667 77488	49218 ⁷
88-90	Cab & Chassis; Exc. HD Solid Front Axle	⊖	G63355	61525 81039	34036 ⁸	⊖	G63366
	Extended & Standard Cab; Exc. HD Straight Front Axle	⊖	G63489	58489 61544 77489 81668	⊖	G63488	58488 61543 77488 81667	43163 ⁸ 49218 ⁷
	Extended & Standard Cab; Exc. Straight Front Axle	⊖	34073 ⁸	⊖

PICKUP 1 TON, K30

77-86	All	⊖	G63411	14017	⊖	G63675	58412 61642 77412 81921
	Single System Steering Stabilizer	⊖	G63411	6804SE ⁸⁰ 14017	⊖	G63675	58412 61642 77412 81921
	Dual System Steering Stabilizer	⊖	G63411	6802SE ⁸⁴ 14017	⊖	G63675	58412 61642 77412 81921
73-74	All	⊖	14017	⊖

PICKUP 1 TON, K35 / K3500

95-00	Exc. OE Unit	⊖	G63609	58609 61542 77609 81726	6853SE ⁸⁶	⊖	G63488	58488 61543 77488 81667	43163 ⁸ 49218 ⁷
88-00	All	⊖	G63609	58609 61542 77609 81726	⊖	G63488	58488 61543 77488 81667	43163 ⁸ 49218 ⁷

PICKUP 1 TON, R30

87-88	All	⊖	G63355	61525 81039	34036 ⁸	⊖	G63366
	Single System Steering Stabilizer; with Cooler	⊖	G63355	61525 81039	6802SE ⁸⁴	34036 ⁸	⊖	G63366

PICKUP 1 TON, R3500

90-91	All	⊖	G63411	81039	14017	⊖	G63675	58412 61642 77412 81921
	Single System Steering Stabilizer; with Cooler	⊖	G63411	81039	6802SE ⁸⁴ 14017	⊖	G63675	58412 61642 77412 81921

7 Pair Packs, Air hose kit included.



80 Mounting bracket not required, install on O.E. Shock Mounts. See Ref. C for optional Steering Stabilizer Boots

86 Exc. OE Unit

8 Pair Packs.

84 Replacement damper for vehicles with the Gabriel Aftermarket mounting kit

APPLICATION GUIDE

Year	Fitment Notes										
		Ultra	Ready Mounts	Max Control\ LTV Severe Duty\ ProGuard\ Guardian	Strut Cushion\ Strut Mount\ Dampers\ Stabilizer	HiJackers\ Load Carrier\ Classic	Ultra	Ready Mounts	Max Control\ LTV Severe Duty\ ProGuard\ Guardian	Strut Cushion\ Strut Mount\ Dampers\ Stabilizer	HiJackers\ Load Carrier\ Classic

CHEVROLET

CHEVROLET

PICKUP 1 TON, R3500 (cont)

89	All	○	81039	14017	
	Exc. Standard Cab	○	G63411	81039	14017	○	G63675	58412 61642 77412 81921
	Single System Steering Stabilizer; with Cooler	○	81039	6802SE ⁵⁴ 14017
	Standard Cab Pickup	○	G63355	61525 81039	14017	34036 ⁸	○	G63366

PICKUP 1 TON, SILVERADO 3500

15-18	All	○	○	G64121
11-13	All	○	○	G64121
01-09	All	○	G63817	58817 61663 77817 81925	○	G63675	58412 61642 77412 81921

PICKUP 1 TON, SILVERADO 3500 HD

21-22	All	○	G64148	○	G64121	43181 ⁸
20	All	○	G64148	○	G64121	77976	43181 ⁸
16-19	All	○	G64148	77817	○	G64121	77976	43181 ⁸
15	All	○	G64148	○	G64121	77976	43181 ⁸
11-14	All	○	G64148	○	77976	43181 ⁸
08-10	All	○	G63817	58817 61663 77817	○	G63675	58412 61642 77412 81921
07	All	○	G63817	58817 61663 77817	○	G63675	58412 61642
	Classic	○	G63817	58817 61663 77817	○	G63675	77412 58412 61642

PICKUP 1 TON, V30

87-88	All	○	G63411	14017	○	G63675	58412 61642 77412 81921
-------	-----	---	--------	------	------	-------	------	---	--------	------	----------------------------------	------	------

PICKUP 1 TON, V3000 / V3500

89-91	All	○	G63411	14017	○	G63675	58412 61642 77412 81921
-------	-----	---	--------	------	------	-------	------	---	--------	------	----------------------------------	------	------

PRIZM

98-02	Left	↑	G55999	G56948 ⁴⁰	143059 ⁵¹ 143281 ⁵³	↑	G55661	G56949 ⁴⁰	143058 ⁵¹
	Right	↑	G55999	G56948 ⁴⁰	143059 ⁵¹ 143281 ⁵³	↑	G55662	G56950 ⁴⁰	143058 ⁵¹

S10

92-04	4WD; Exc. ZR2, ZR5 or Sport Chassis	○	G63423	58423 61531 77423 81516	○	G63422	58422 61528 77422 81482	43162 ⁸ 49213 ⁷
88-04	4WD, Torsion Bar(FrontSpringType)	↑	142316 ⁵³

7 Pair Packs, Air hose kit included.

40 Complete Assembled Unit.



53 Hardware from O.E. Part may need to be reused.

8 Pair Packs.

51 Strut Cushion for use with the Strut/Cartridge/Shocks.

84 Replacement damper for vehicles with the Gabriel Aftermarket mounting kit

APPLICATION GUIDE

Year	Fitment Notes										
		Ultra	Ready Mounts	Max Control\ LTV Severe Duty\ ProGuard\ Guardian	Strut Cushion\ Strut Mount\ Dampers\ Stabilizer	HiJackers\ Load Carrier\ Classic	Ultra	Ready Mounts	Max Control\ LTV Severe Duty\ ProGuard\ Guardian	Strut Cushion\ Strut Mount\ Dampers\ Stabilizer	HiJackers\ Load Carrier\ Classic

CHEVROLET

S10 (cont)

83-04	4WD; Single system Steering Stabilizer; with a factory mounting hole in the steering linkage.	○	6801SE ⁸⁰	
02-03	RWD; Exc. Sport Chassis or Xtreme Chassis	⊖	G63421	58421 61504 81750	34051 ⁸	⊖	58422 61528 77422 81482	43162 ⁸ 49213 ⁷
82-03	RWD; Single System Steering Stabilizer	○	6802SE ⁸⁴
01	RWD; Exc. Sport Chassis or Xtreme Chassis	⊖	G63421	58421 61504 81750	34051 ⁸	⊖	58422 61528 81482	43162 ⁸ 49213 ⁷
99-00	RWD; Exc. Sport Chassis or Xtreme Chassis	⊖	G63421	58421 61504 81750	34051 ⁸	⊖	58422 61528 77422 81482	43162 ⁸ 49213 ⁷
92-98	RWD; Exc. Sport Chassis or Xtreme Chassis	⊖	G63421	58421 61504 81750	34051 ⁸
91	4WD; Exc. ZR2, Baja & Sport Chassis	○	G63423	58423 61531 77423 81516
	4WD; Exc. ZR2, ZR5 or Sport Chassis	○	⊖	G63422	58422 61528 77422 81482	43162 ⁸ 49213 ⁷
	RWD; Exc. ZR2, Baja & Sport Chassis	⊖	G63421	58421 61504 81750	34051 ⁸
83-90	4WD; Exc. ZR2, ZR5 or Sport Chassis	○	G63423	58423 61531 77423 81516	⊖	G63422	58422 61528 77422 81482	43162 ⁸ 49213 ⁷
82-90	RWD; Exc. Sport Chassis or Xtreme Chassis	⊖	G63421	58421 61504 81750	34051 ⁸
82	4WD; Exc. ZR2, ZR5 or Sport Chassis	⊖	⊖	49213 ⁷

SILVERADO 1500 HD CLASSIC

07	All	⊖	G63817	58817 61663 77817 81925	⊖	G63675	58412 81921
	4WD	⊖	G63817	58817 61663 77817 81925	⊖	G63675	61642 77412 58412 81921

SILVERADO 1500 LD

19	All	○	○	61690 77412	43181 ⁸ 49235 ⁷
	4WD	⊖	G57000 ⁴⁰	○	61690 77412	43181 ⁸ 49235 ⁷
	RWD, Exc. Electronic Ride Control	⊖	G57023 ⁴⁰	○	61690 77412	43181 ⁸ 49235 ⁷

SILVERADO 2500 HD CLASSIC

07	All	⊖	G63817	61663 77817	⊖	G63675	58412 61642 77412
	9200# GVW	⊖	G63817	58817 61663 77817	⊖	G63675	58412 61642 77412

SILVERADO 3500 CLASSIC

07	All	○	○	58412 81921
----	-----	---	------	------	------	------	------	---	------	------	----------------	------	------

7 Pair Packs, Air hose kit included.



40 Complete Assembled Unit.

84 Replacement damper for vehicles with the Gabriel Aftermarket mounting kit

8 Pair Packs.

80 Mounting bracket not required, install on O.E. Shock Mounts. See Ref. C for optional Steering Stabilizer Boots

APPLICATION GUIDE

Year	Fitment Notes										
		Ultra	Ready Mounts	Max Control\ LTV Severe Duty\ ProGuard\ Guardian	Strut Cushion\ Strut Mount\ Dampers\ Stabilizer	HiJackers\ Load Carrier\ Classic	Ultra	Ready Mounts	Max Control\ LTV Severe Duty\ ProGuard\ Guardian	Strut Cushion\ Strut Mount\ Dampers\ Stabilizer	HiJackers\ Load Carrier\ Classic

CHEVROLET

CHEVROLET

SILVERADO 3500 CLASSIC (cont)

07	Heavy Duty		58817	58412 81921
----	------------	--	-------	-------	-------	-------	-------	--	-------	-------	----------------	-------	-------

SPECTRUM

85-88	All		143058 ⁵¹
-------	-----	--	-------	-------	-------	----------------------	-------	--	-------	-------	-------	-------	-------

SPRINT

89-91	All		143059 ⁵¹		G55772	143057 ⁵¹
-------	-----	--	-------	-------	-------	----------------------	-------	--	--------	-------	-------	----------------------	-------

SSR

03-06	All		G51718 ⁴⁵	143241 ⁵³		G63842
-------	-----	--	----------------------	-------	-------	----------------------	-------	--	--------	-------	-------	-------	-------

STYLELINE DELUXE

49-52	All		82026	43140 ⁸ 82155
-------	-----	--	-------	-------	-------	-------	-------	--	-------	-------	-------	-------	-----------------------------

STYLELINE SPECIAL

49-52	All		82026	43140 ⁸ 82155
-------	-----	--	-------	-------	-------	-------	-------	--	-------	-------	-------	-------	-----------------------------

SUBURBAN 1/2 TON, 1500

14-20	Old Body Style			G64101	77975
20	4WD, Old Body Style		G57023 ⁴⁰
15-19	All			G64101
	4WD		G57023 ⁴⁰		G64101
14	All			G64101	77975
	Exc. Z55 or ZW7 Ride Suspension		G51891	G57125 ⁴⁰		G64101	77975
12-13	All			G64101
	Exc. Z55 or ZW7 Ride Suspension		G51891	G57125 ⁴⁰	143316 ⁵³		G64101
07-11	Exc. Z55 or ZW7 Ride Suspension		G51891	G57125 ⁴⁰	143316 ⁵³		G63866	58930 61675 77953 81930
00-11	4WD, Exc. Z55 Auto Ride Suspension		49235 ⁷
	RWD		49155 ⁷
00-06	Exc. Z55 Auto Ride Suspension		G63803	58803 61643 77803 81922		G63866	58930 61675 77953 81930
00-05	4WD, Exc. OE Unit		6853SE ⁸⁶
63-66	All		G63355	61525 81039	34036 ⁸		G63306	49162 ⁷
61-62	All		82035		82086

SUBURBAN 1/2 TON, C10

73-86	All		G63355	61525 81039	34036 ⁸		G63349	61524 81164	43111 ⁸ 49155 ⁷
	Single System Steering Stabilizer		G63355	61525 81039	6802SE ⁸⁴	34036 ⁸		G63349	61524 81164	43111 ⁸ 49155 ⁷

7 Pair Packs, Air hose kit included.

40 Complete Assembled Unit.

51 Strut Cushion for use with the Strut/Cartridge/Shocks.

84 Replacement damper for vehicles with the Gabriel Aftermarket mounting kit



8 Pair Packs.

45 Strut must be rotated to align notch with lower control arm.

53 Hardware from O.E. Part may need to be reused.

86 Exc. OE Unit

APPLICATION GUIDE

Year	Fitment Notes										
		Ultra	Ready Mounts	Max Control\ LTV Severe Duty\ ProGuard\ Guardian	Strut Cushion\ Strut Mount\ Dampers\ Stabilizer	HiJackers\ Load Carrier\ Classic	Ultra	Ready Mounts	Max Control\ LTV Severe Duty\ ProGuard\ Guardian	Strut Cushion\ Strut Mount\ Dampers\ Stabilizer	HiJackers\ Load Carrier\ Classic

CHEVROLET

CHEVROLET

SUBURBAN 1/2 TON, C10 (cont)

68-72	All	○	G63355	61525 81039	34036 ⁸	○	49107 ⁷ 82003
	Single System Steering Stabilizer	○	G63355	61525 81039	6802SE ⁸⁴	34036 ⁸	○	49107 ⁷ 82003
67	All	○	G63355	61525 81039	34036 ⁸	○

SUBURBAN 1/2 TON, C15 / C1500

92-99	All	○	G63489	58489 61544 77489 81668	34073 ⁸	○	G63896	58638 61565 77638	43180 ⁹ 49231 ⁷
-------	-----	---	--------	------	----------------------------------	------	--------------------	---	--------	------	-------------------------	------	------------------------------------------

SUBURBAN 1/2 TON, K10

81-86	Exc. Lift Kit	○	G63347	14017	○	G63349	61524 81164	43111 ⁸
	Quad Suspension Long Shock; Exc. Lift Kit	○	61522 ⁶ 81496 ⁶	14017	○
	Quad Suspension Short Shock; Exc. Lift Kit	○	61516 ⁶	14017	○
	Standard Suspension; Exc. Lift Kit	○	81113 ⁶	14017	○	49155 ⁷
73-86	All	○	14017	○
	Single System Steering Stabilizer	○	6804SE ⁸⁰ 14017	○
	Dual System Steering Stabilizer	○	6802SE ⁸⁴ 14017	○
73-80	Exc. Lift Kit	○	G63347	61516 ⁶ 81113 ⁶	14017	○	G63349	61524 81164	43111 ⁸ 49155 ⁷
69-72	Exc. Lift Kit	○	G63347	61516 ⁶ 81113 ⁶	○
68-72	Single System Steering Stabilizer	○	6803SE ⁸⁴	○
	Dual System Steering Stabilizer	○	6802SE ⁸⁴	○

SUBURBAN 1/2 TON, K15 / K1500

92-99	All	○	G63609	58609 61542 77609 81726	○	G63638	58638 61565 77638	43180 ⁹ 49231 ⁷
-------	-----	---	--------	------	----------------------------------	------	------	---	--------	------	-------------------------	------	------------------------------------------

SUBURBAN 1/2 TON, R10

87-88	All	○	G63355	61525 81039	14017	34036 ⁸	○	G63349	61524 81164	43111 ⁸
	Single System Steering Stabilizer	○	G63355	61525 81039	6804SE ⁸⁰ 14017	34036 ⁸	○	G63349	61524 81164	43111 ⁸
	Dual System Steering Stabilizer	○	G63355	61525 81039	6802SE ⁸⁴ 14017	34036 ⁸	○	G63349	61524 81164	43111 ⁸
	RWD	○	G63355	61525 81039	14017	34036 ⁸	○	G63349	61524 81164	49155 ⁷ 43111 ⁸

SUBURBAN 1/2 TON, R1500

89-91	All	○	G63355	61525 81039	34036 ⁸	○	G63349	61524 81164	43111 ⁸
	RWD	○	G63355	61525 81039	34036 ⁸	○	G63349	61524 81164	49155 ⁷ 43111 ⁸
	Single System Steering Stabilizer	○	G63355	61525 81039	6802SE ⁸⁴	34036 ⁸	○	G63349	61524 81164	43111 ⁸

SUBURBAN 1/2 TON, V10

87-88	Quad Suspension Long Shock; Exc. Lift Kit	○	61522 ⁶ 81496 ⁶	○
	Quad Suspension Short Shock; Exc. Lift Kit	○	61516 ⁶ 81113 ⁶	○

6 It is recommended that when replacing shocks on vehicles with "quad shocks" all 4 shocks should be matched by series.



8 Pair Packs.

84 Replacement damper for vehicles with the Gabriel Aftermarket mounting kit

7 Pair Packs, Air hose kit included.

80 Mounting bracket not required, install on O.E. Shock Mounts. See Ref. C for optional Steering Stabilizer Boots

APPLICATION GUIDE

Year	Fitment Notes										
		Ultra	Ready Mounts	Max Control\ LTV Severe Duty\ ProGuard\ Guardian	Strut Cushion\ Strut Mount\ Dampers\ Stabilizer	HiJackers\ Load Carrier\ Classic	Ultra	Ready Mounts	Max Control\ LTV Severe Duty\ ProGuard\ Guardian	Strut Cushion\ Strut Mount\ Dampers\ Stabilizer	HiJackers\ Load Carrier\ Classic

CHEVROLET

SUBURBAN 1/2 TON, V1500

CHEVROLET

89-91	All	49155 ⁷
	Exc. Lift Kit	G63349	...	61524 81164	...	43111 ⁸ 49155 ⁷
	Exc. Quad Suspension and Lift Kit	61516	49155 ⁷

SUBURBAN 3/4 TON, 2500

12-13	All	81925
00-11	Exc. Z55 Auto Ride Suspension and Quadrateer	G63817	...	58817 61663 77817 81925	G63866	...	58930 61675 77953 81930
	4WD, Exc. Z55 Auto Ride Suspension	49235 ⁷
	RWD	49155 ⁷
00-05	4WD, Exc. OE Unit	6853SE ⁸⁶

SUBURBAN 3/4 TON, C20

73-86	All	G63355	...	61525 81039	...	34036 ⁸	G63349	...	61524 81164	...	43111 ⁸ 49155 ⁷
	Single System Steering Stabilizer	G63355	...	61525 81039	6802SE ⁸⁴	34036 ⁸	G63349	...	61524 81164	...	43111 ⁸ 49155 ⁷
68-72	All	G63355	...	61525 81039	...	34036 ⁸	49107 ⁷ 82003
	Single System Steering Stabilizer	G63355	...	61525 81039	6802SE ⁸⁴	34036 ⁸	49107 ⁷ 82003
67	All	61525	...	34036 ⁸

SUBURBAN 3/4 TON, C25 / C2500

92-99	All	G63489	...	58489 61544 77489 81668	...	34073 ⁸	G63896	...	58638 61565 77638	...	43180 ⁸ 49231 ⁷
-------	-----	--------	-----	----------------------------------	-----	--------------------	--------	-----	-------------------------	-----	------------------------------------------

SUBURBAN 3/4 TON, K20

81-86	Exc. Lift Kit	G63347	14017	...	G63349	...	61524 81164	...	43111 ⁸
	Quad Suspension Long Shock; Exc. Lift Kit	61522 ⁸ 81496 ⁸	14017
	Quad Suspension Short Shock; Exc. Lift Kit	61516 ⁸	14017
	Standard Suspension; Exc. Lift Kit	81113 ⁸	14017	49155 ⁷
73-86	All	14017
	Single System Steering Stabilizer	6804SE ⁸⁰ 14017
	Dual System Steering Stabilizer	6802SE ⁸⁴ 14017
73-80	Exc. Lift Kit	G63347	...	61516 ⁸ 81113 ⁸	14017	...	G63349	...	61524 81164	...	43111 ⁸ 49155 ⁷
69-72	Exc. Lift Kit	G63347	...	61516 ⁸ 81113 ⁸
68-72	Single System Steering Stabilizer	6803SE ⁸⁴
	Dual System Steering Stabilizer	6802SE ⁸⁴



SUBURBAN 3/4 TON, K25 / K2500

95-99	Exc. OE Unit	G63609	...	58609 61542 77609 81726	6853SE ⁸⁶	...	G63638	...	58638 61565 77638	...	43180 ⁸ 49231 ⁷
-------	--------------	--------	-----	----------------------------------	----------------------	-----	--------	-----	-------------------------	-----	------------------------------------------

6 It is recommended that when replacing shocks on vehicles with "quad shocks" all 4 shocks should be matched by series.
8 Pair Packs.

7 Pair Packs, Air hose kit included.
80 Mounting bracket not required, install on O.E. Shock Mounts. See Ref. C for optional Steering Stabilizer Boots

APPLICATION GUIDE

Year	Fitment Notes										
		Ultra	Ready Mounts	Max Control\ LTV Severe Duty\ ProGuard\ Guardian	Strut Cushion\ Strut Mount\ Dampers\ Stabilizer	HiJackers\ Load Carrier\ Classic	Ultra	Ready Mounts	Max Control\ LTV Severe Duty\ ProGuard\ Guardian	Strut Cushion\ Strut Mount\ Dampers\ Stabilizer	HiJackers\ Load Carrier\ Classic

CHEVROLET

CHEVROLET

SUBURBAN 3/4 TON, K25 / K2500 (cont)

92-99	All	G63609	58609 61542 77609 81726	G63638	58638 61565 77638	43180 ⁸ 49231 ⁷
-------	-----	--------	------	----------------------------------	------	------	--------	------	-------------------------	------	------------------------------------------

SUBURBAN 3/4 TON, R20

87-88	All	G63355	61525 81039	34036 ⁸	G63349	61524 81164	43111 ⁸
	RWD	G63355	61525 81039	34036 ⁸	G63349	61524 81164	49155 ⁷ 43111 ⁸
	Single System Steering Stabilizer	G63355	61525 81039	6802SE ⁸⁴	34036 ⁸	G63349	61524 81164	43111 ⁸

SUBURBAN 3/4 TON, R2500

89-91	All	G63355	61525 81039	34036 ⁸	G63349	61524 81164	43111 ⁸
	RWD	G63355	61525 81039	34036 ⁸	G63349	61524 81164	49155 ⁷ 43111 ⁸
	Single System Steering Stabilizer	G63355	61525 81039	6802SE ⁸⁴	34036 ⁸	G63349	61524 81164	43111 ⁸

SUBURBAN 3/4 TON, V20

87-88	All	14017	49155 ⁷
	Exc. Quad Suspension and Lift Kit	G63347	14017	G63349	61524 81164	43111 ⁸ 49155 ⁷
	Quad Suspension Long Shock; Exc. Lift Kit	61522 ⁶ 81496 ⁶	14017	49155 ⁷
	Quad Suspension Short Shock; Exc. Lift Kit	61516 81113 ⁶	14017	49155 ⁷
	Single System Steering Stabilizer	6804SE ⁸⁰ 14017	49155 ⁷
	Dual System Steering Stabilizer	6802SE ⁸⁴ 14017	49155 ⁷

SUBURBAN 3/4 TON, V2500

89-91	All	14017	49155 ⁷
	Exc. Lift Kit	G63347	14017	G63349	61524 81164	43111 ⁸ 49155 ⁷
	Quad Suspension Long Shock; Exc. Lift Kit	61522 ⁶ 81496 ⁶	14017	49155 ⁷
	Quad Suspension Short Shock; Exc. Lift Kit	61516 81113 ⁶	14017	49155 ⁷
	Single System Steering Stabilizer	6804SE ⁸⁰ 14017	49155 ⁷
	Dual System Steering Stabilizer	6802SE ⁸⁴ 14017	49155 ⁷

SUBURBAN 3500 HD

16-19	All	61663	G64000
-------	-----	------	------	-------	------	------	--------	------	------	------	------

TAHOE

15-19	4WD	G57023 ⁴⁰	77975
12-19	All	77975
	Exc. Police Package	G64101	77975
12-14	Exc. Z55 or ZW7 Ride Suspension	G51891	G57125 ⁴⁰	143316 ⁵³	77975

6 It is recommended that when replacing shocks on vehicles with "quad shocks" all 4 shocks should be matched by series.

8 Pair Packs.

53 Hardware from O.E. Part may need to be reused.



84 Replacement damper for vehicles with the Gabriel Aftermarket mounting kit

7 Pair Packs, Air hose kit included.

40 Complete Assembled Unit.

80 Mounting bracket not required, install on O.E. Shock Mounts. See Ref. C for optional Steering Stabilizer Boots

APPLICATION GUIDE

Year	Fitment Notes										
		Ultra	Ready Mounts	Max Control\ LTV Severe Duty\ ProGuard\ Guardian	Strut Cushion\ Strut Mount\ Dampers\ Stabilizer	HiJackers\ Load Carrier\ Classic	Ultra	Ready Mounts	Max Control\ LTV Severe Duty\ ProGuard\ Guardian	Strut Cushion\ Strut Mount\ Dampers\ Stabilizer	HiJackers\ Load Carrier\ Classic

CHEVROLET

TAHOE (cont)

CHEVROLET

07-11	Exc. Z55 or ZW7 Ride Suspension	G51891	G57125 ⁴⁰	143316 ⁵³	G63866	58930 61675 77953 81930
02-11	RWD	49155 ⁷
00-11	4WD, Exc. Z55 Auto Ride Suspension	49235 ⁷
11	Exc. Police Package	G64101
02-06	Exc. Z55 Auto Ride Suspension	G63803	58803 61643 77803 81922	G63866	58930 61675 77953 81930
01-05	4WD; New Body Style; Exc. Z55 Auto Ride Suspension	6853SE ⁵²
00-01	New Body Style; Exc. Z55 Auto Ride Suspension	G63803	58803 61643 77803	G63866	58930 61675 77953
	New Body Style; Exc. Z55 Auto Ride Suspension	81922	81930
01	RWD, Old Body Style	49155 ⁷
95-00	Old Body Style	58638 61565 77638	43180 ⁸ 49231 ⁷
	4WD, Old Body Style	G63609	58901 61542 77609 81726	G63638
	4WD; Old Body Style	6853SE ⁵²
00	RWD, Old Body Style	G63489	58489 61544 77489 81668	34073 ⁸	G63896	49155 ⁷
96-99	RWD, Old Body Style	G63489	58489 61544 77489 81668	34073 ⁸	G63896
95	RWD	34073 ⁸
	RWD, Old Body Style	G63489	58489 61544 77489 81668	G63896

TORNADO

04-08	All	G63875
-------	-----	------	------	------	------	------	--------	------	------	------	------

TOWNSMAN

71-72	All	69675 ⁵	81446	34073 ⁸	69604	81492
69-70	All	69675 ⁵	81446	34073 ⁸	69724	81514	43049 ⁸ 49131 ³⁰

TRACKER

99-04	All	143204 ⁵³
	Non-ABS	G56518	143204 ⁵³	G63799	61560 81904
98	Non-ABS	G56518	G63799	61560 81904

5 Use kit No. 140719 to replace O.E. hardware for lower shock absorber mounting when studs break or self-tapping screws are not longer useable.

8 Pair Packs.

40 Complete Assembled Unit.



82 Use kit if listed, See Ref. C for optional Steering Stabilizer Boots.

7 Pair Packs, Air hose kit included.

30 For GM Vehicles equipped with factory installed leveling systems, see Ref A.

53 Hardware from O.E. Part may need to be reused.

APPLICATION GUIDE

Year	Fitment Notes										
		Ultra	Ready Mounts	Max Control\ LTV Severe Duty\ ProGuard\ Guardian	Strut Cushion\ Strut Mount\ Dampers\ Stabilizer	HiJackers\ Load Carrier\ Classic	Ultra	Ready Mounts	Max Control\ LTV Severe Duty\ ProGuard\ Guardian	Strut Cushion\ Strut Mount\ Dampers\ Stabilizer	HiJackers\ Load Carrier\ Classic

CHEVROLET

TRAILBLAZER

06-09	All	↓	143241 ⁵³		
	Air(RearSpringType)	↓	143241 ⁵³	○	G64014	61717
	Coil(RearSpringType)	↓	143241 ⁵³	○	G63842	77971
	Exc. SS Models	↓	G51718 ⁴⁵	G57022 ⁴⁰	143241 ⁵³
02-05	All	↓	G51718 ⁴⁵	G57022 ⁴⁰	143241 ⁵³
	Air(RearSpringType)	↓	G51718 ⁴⁵	G57022 ⁴⁰	143241 ⁵³	○	G64014	61717
	Coil(RearSpringType)	↓	G51718 ⁴⁵	G57022 ⁴⁰	143241 ⁵³	○	G63842	77971

CHEVROLET

TRAILBLAZER EXT

02-06	All	↓	G51718 ⁴⁵	○	77971
-------	-----	---	----------------------	------	------	------	------	---	------	------	-------	------	------

TRAVERSE

15-17	All	↓	G57709 ⁴⁰	○	G64040
13-14	All	↓	G57709 ⁴⁰	143486 ⁶⁸	○	G64040
09-12	All	↓	G52125	143366 ⁵³	○	G64040
	AWD	↓	G52125	G57109 ⁴⁰	143366 ⁵³	○	G64040
09-11	FWD	↓	G52125	G57314 ⁴⁰	143366 ⁵³	○	G64040

TRAX

13-22	Left	↓	G52494	↓	G511030
	Right	↓	G52495	↓	G511030

TWO-TEN SERIES

55-57	All	⊖	69625	82099	⊖	82066
53-54	All	⊖	82026	⊖	43140 ⁹ 82155

UPLANDER

05-09	Exc. Auto-Leveling System	↓	G52025
	FWD, Exc. Air-Leveling Suspension	↓	142526 ⁵⁴
	FWD, Exc. Auto-Leveling System	↓	G57142 ⁴⁰	○	G63776
05-08	FWD, Exc. Auto-Leveling System & Independent Rear Suspension	↓	○	49230 ⁷

VAN 1/2 TON, G / EXPRESS

12-14	AWD, Torsion Bar(FrontSpringType)	⊖	G63893	61683	⊖	G63896	58638 77638	43180 ⁹ 49231 ⁷
03-14	All	⊖	⊖	G63896	58638 77638	43180 ⁹ 49231 ⁷

7 Pair Packs, Air hose kit included.

40 Complete Assembled Unit.

53 Hardware from O.E. Part may need to be reused.



68 Mount Kit. Hardware from O.E. Part may need to be reused.;

8 Pair Packs.

45 Strut must be rotated to align notch with lower control arm.

54 Kit with Mount and Bearing. Hardware from O.E. Part may need to be reused.























APPLICATION GUIDE

Year	Fitment Notes										
		Ultra	Ready Mounts	Max Control\ LTV Severe Duty\ ProGuard\ Guardian	Strut Cushion\ Strut Mount\ Dampers\ Stabilizer	HiJackers\ Load Carrier\ Classic	Ultra	Ready Mounts	Max Control\ LTV Severe Duty\ ProGuard\ Guardian	Strut Cushion\ Strut Mount\ Dampers\ Stabilizer	HiJackers\ Load Carrier\ Classic











CHEVROLET

CHEVROLET

















VAN 1/2 TON, G / EXPRESS (cont)

03-14	RWD, Coil(FrontSpringType)		G63894	61684		G63896	58638 77638	43180 ⁶ 49231 ⁷
03-11	Exc. Upfitter Package and Cutaway Chassis			G63896	61565 58638 77638	43180 ⁶ 49231 ⁷
	Torsion Bar (FrontSpringType)		G63893	61683		G63896	58638 77638	43180 ⁶ 49231 ⁷
96-02	All		G63375 ⁵	61555 77375 81713 ⁵		G63896	58638 61565 77638	43180 ⁶ 49231 ⁷
	Exc. 8600# GVW		G63375 ⁵	61555 77375 81713 ⁵	34073 ⁸		G63896	58638 61565 77638	43180 ⁶ 49231 ⁷
78-95	All		G63357 ⁵	58357 61517		G63413	61522 81496 ⁶	49212 ⁷
	Single System Steering Stabilizer		G63357 ⁵	58357 61517	6802SE ⁸⁴		G63413	61522 81496 ⁶	49212 ⁷
71-77	All		G63357 ⁵	58357 61517		G63306	49162 ⁷
	Single System Steering Stabilizer		G63357 ⁵	58357 61517	6802SE ⁸⁴		G63306	49162 ⁷
67-70	All			G63306	49162 ⁷
70	Independent Front Suspension		G63357 ⁵	58357 61517		G63306	49162 ⁷
	Single System Steering Stabilizer		6802SE ⁸⁴		G63306	49162 ⁷
64-66	All			82003

VAN 1/2 TON, P SERIES

74-80	All		G63355	61525 81039	34036 ⁸		G63366	77662
73	All		G63355	61525 81039	34036 ⁸		G63349	61524 81164	43111 ⁸ 49155 ⁷
67-72	All		G63355	61525 81039	34036 ⁸		49107 ⁷ 82003
63-66	All		G63355	61525 81039	34036 ⁸		G63306	49162 ⁷
61-62	All		82035		82086

VAN 3/4 TON, G / EXPRESS

21-22	All		G63895	61685		G63897	61687	43180 ⁶
17-20	All		G63895	61685		G63897	61687 77638	43180 ⁶
10-16	All			G63897	61687 77638	43180 ⁶
	Coil(FrontSpringType)		G63895	61685		G63897	61687 77638	43180 ⁶
10-12	Torsion Bar (FrontSpringType)		G63893	61683		G63897	61687 77638	43180 ⁶
07-09	All			G63897	58638 61687 77638	43180 ⁶
	Coil(FrontSpringType)		G63895	61685		G63897	58638 61687 77638	43180 ⁶
	Torsion Bar (FrontSpringType)		G63893	61683		G63897	58638 61687 77638	43180 ⁶
03-06	All			G63897	61687 77638	43180 ⁶
	Coil(FrontSpringType)		G63895	61685		G63897	61687 77638	43180 ⁶

5 Use kit No. 140719 to replace O.E. hardware for lower shock absorber mounting when studs break or self-tapping screws are not longer useable.



7 Pair Packs, Air hose kit included.

84 Replacement damper for vehicles with the Gabriel Aftermarket mounting kit

6 It is recommended that when replacing shocks on vehicles with "quad shocks" all 4 shocks should be matched by series.

8 Pair Packs.

APPLICATION GUIDE

Year	Fitment Notes										
		Ultra	Ready Mounts	Max Control\ LTV Severe Duty\ ProGuard\ Guardian	Strut Cushion\ Strut Mount\ Dampers\ Stabilizer	HiJackers\ Load Carrier\ Classic	Ultra	Ready Mounts	Max Control\ LTV Severe Duty\ ProGuard\ Guardian	Strut Cushion\ Strut Mount\ Dampers\ Stabilizer	HiJackers\ Load Carrier\ Classic

CHEVROLET

CHEVROLET

VAN 3/4 TON, G / EXPRESS (cont)

03-06	Torsion Bar (FrontSpringType)	I N	G63893	61683	O O	G63897	61687 77638	43180 ⁸
96-02	Exc. 8600# GVW	I O	G63375 ⁵	61555 77375 81713 ⁵	34073 ⁸	O O	G63638	58638 61565 77638	43180 ⁸ 49231 ⁷
78-95	All	O O	G63357 ⁵	O O
	Exc. 8600# GVW	O O	G63357 ⁵	58357 61517	O O	G63413	61522 81496 ⁶	49212 ⁷
	Single System Steering Stabilizer	O O	G63357 ⁵	6802SE ⁸⁴	O O
71-77	All	O O	G63357 ⁵	58357 61517	O O	G63306	49162 ⁷
	Single System Steering Stabilizer	O O	G63357 ⁵	58357 61517	6802SE ⁸⁴	O O	G63306	49162 ⁷
70	All	O O	58357	O O	G63306	49162 ⁷
	Independent Front Suspension	O O	G63357 ⁵	61517 58357	O O	G63306	49162 ⁷
	Single System Steering Stabilizer	O O	58357	6802SE ⁸⁴	O O	G63306	49162 ⁷
67-69	All	O O	O O	G63306	49162 ⁷

VAN 3/4 TON, P SERIES

79-89	All	O O	G63355	61525 81039	34036 ⁸	O O	G63366	77662
73-78	All	O O	G63355	61525 81039	34036 ⁸	O O	G63349	61524 81164	43111 ⁸ 49155 ⁷
68-72	All	O O	G63355	61525 81039	34036 ⁸	O O	G63306	49162 ⁷
63-67	All	O O	82047	O O
61-62	All	O O	82047	I O	43140 ⁸ 82155

VAN 1 TON, G / EXPRESS

17-22	All	I O	G63895	61685	O O	G63897	61687 77638	43180 ⁸
13-16	All	I O	O O	G63897	61687 77638	43180 ⁸
	Coil(FrontSpringType)	I O	G63895	61685	O O	G63897	61687 77638	43180 ⁸
10-12	All	I O	O O	58638 77638	43180 ⁸
	Single Rear Wheels	I O	O O	G63897	61687 58638 77638	43180 ⁸
	Torsion Bar (FrontSpringType)	I N	G63893	O O	58638 77638	43180 ⁸
	Coil(FrontSpringType)	I O	G63895	61685	O O	58638 77638	43180 ⁸
07-09	All	I O	O O	77638	43180 ⁸
	Single Rear Wheels	I O	O O	G63897	61687 77638	43180 ⁸
	Torsion Bar (FrontSpringType)	I N	G63893	O O	77638	43180 ⁸
	Coil(FrontSpringType)	I O	G63895	61685	O O	77638	43180 ⁸
03-06	All	I O	O O	58638 77638	43180 ⁸
	Single Rear Wheels	I O	O O	G63897	61687 58638 77638	43180 ⁸
	Torsion Bar (FrontSpringType)	I N	G63893	O O	58638 77638	43180 ⁸

5 Use kit No. 140719 to replace O.E. hardware for lower shock absorber mounting when studs break or self-tapping screws are not longer useable.



7 Pair Packs, Air hose kit included.

84 Replacement damper for vehicles with the Gabriel Aftermarket mounting kit

6 It is recommended that when replacing shocks on vehicles with "quad shocks" all 4 shocks should be matched by series.

8 Pair Packs.















































APPLICATION GUIDE

Year	Fitment Notes										
		Ultra	Ready Mounts	Max Control\ LTV Severe Duty\ ProGuard\ Guardian	Strut Cushion\ Strut Mount\ Dampers\ Stabilizer	HiJackers\ Load Carrier\ Classic	Ultra	Ready Mounts	Max Control\ LTV Severe Duty\ ProGuard\ Guardian	Strut Cushion\ Strut Mount\ Dampers\ Stabilizer	HiJackers\ Load Carrier\ Classic







CHEVROLET

CHEVROLET

VAN 1 TON, G / EXPRESS (cont)

03-06	Coil(FrontSpringType)		G63895	61685		58638 77638	43180 ⁶
97-02	All		G63375 ⁵	61555 77375 81713 ⁵		61565	43180 ⁶ 49231 ⁷
	Exc. 8600# GVW		G63375 ⁵	61555 77375 81713 ⁵	34073 ⁸		G63638	61565	43180 ⁶ 49231 ⁷
96	All		G63357	58357 61517 61555 77375 81713 ⁵		43180 ⁶ 49231 ⁷
	Exc. 8600# GVW		G63357	58357 61517 61555 77375 81713 ⁵	34073 ⁸		61565	43180 ⁶ 49231 ⁷
	Cutaway Van		G63357	58357 61517 61555 77375 81713 ⁵		G63671	43180 ⁶ 49231 ⁷
94-95	Single System Steering Stabilizer; HD with Straight Front Axle & Tilt Hood		G63357	58357 61517	6804SE ⁸⁰	
92-95	9200# GVW		G63357	58357 61517		77403
	Cutaway Van		G63357	58357 61517		G63671	58403 61522 81496 ⁶	49212 ⁷
78-95	All		G63357	58357 61517	
	Exc. Cutaway Van		G63357	58357 61517		G63413
	Single System Steering Stabilizer		G63357	58357 61517	6802SE ⁸⁴	
79-91	9200# GVW		G63357	58357 61517		G63403	77403
	Cutaway Van		G63357	58357 61517		58403 61522 81496 ⁶	49212 ⁷
78	Cutaway Van		G63357	58357 61517		61522 81496 ⁶	49212 ⁷
76-77	All		G63357		G63306	49162 ⁷
	Single System Steering Stabilizer		G63357	6802SE ⁸⁴		G63306	49162 ⁷
75	110.0 / 279.4(WheelBase)			G63306	49162 ⁷
	125.0 / 317.5(WheelBase)			G63306	49162 ⁷
	146.0 / 370.8(WheelBase)		G63357	58357 61517	
	Single System Steering Stabilizer		6802SE ⁸⁴	
71-74	All		G63357	58357 61517		G63306	49162 ⁷
	Single System Steering Stabilizer		G63357	58357 61517	6802SE ⁸⁴		G63306	49162 ⁷

VAN 1 TON, P SERIES

86-99	Motorhome Chassis w/ I-Beam Front Suspension		G63625		G63366
85-99	Motorhome Chassis w/ Independent Front Suspension		G63394		G63366
73-99	All			G63366

5 Use kit No. 140719 to replace O.E. hardware for lower shock absorber mounting when studs break or self-tapping screws are not longer useable.

7 Pair Packs, Air hose kit included.



80 Mounting bracket not required, install on O.E. Shock Mounts. See Ref. C for optional Steering Stabilizer Boots

6 It is recommended that when replacing shocks on vehicles with "quad shocks" all 4 shocks should be matched by series.

8 Pair Packs.

84 Replacement damper for vehicles with the Gabriel Aftermarket mounting kit

APPLICATION GUIDE

Year	Fitment Notes										
		Ultra	Ready Mounts	Max Control\ LTV Severe Duty\ ProGuard\ Guardian	Strut Cushion\ Strut Mount\ Dampers\ Stabilizer	HiJackers\ Load Carrier\ Classic	Ultra	Ready Mounts	Max Control\ LTV Severe Duty\ ProGuard\ Guardian	Strut Cushion\ Strut Mount\ Dampers\ Stabilizer	HiJackers\ Load Carrier\ Classic

CHEVROLET

VAN 1 TON, P SERIES (cont)

85-93	Single System Steering Stabilizer; w/ I-Beam Front Suspension	○	6804SE ⁸⁰	○	G63366
73-90	Cutaway Chassis	○	G63355	61525 81039	○	G63366
85	Motorhome Chassis w/ I-Beam Front Suspension	○	G63403	58403 77403	○	G63366
74-84	Motorhome Chassis	○	G63394	○	G63366
68-72	All	○	○
	Cutaway Chassis	○	G63355	61525 81039	○
	Exc. 11,000# Rear Axle	○	○	G63306	49162 ⁷
63-67	All	○	○
61-62	All	○	○	43140 ⁸ 82155

CHEVROLET

VENTURE

05	All	○	G55948	G57060 ⁴⁰	142524 ⁶⁷ 142526 ⁵⁴	○	G63776	61659 81924
	FWD	○	G55948	G57060 ⁴⁰	142524 ⁶⁷ 142526 ⁵⁴	○	G63776	61659 81924	49230 ⁷
02-04	All	○	G55948	142524 ⁶⁷ 142526 ⁵⁴	○	G63776	61659 81924
	FWD	○	G55948	G57060 ⁴⁰	142524 ⁶⁷ 142526 ⁵⁴	○	G63776	61659 81924	49230 ⁷
97-01	FWD	○	G55948	G57060 ⁴⁰	142524 ⁶⁷ 142526 ⁵⁴	○	G63776	61659 81924	49230 ⁷

CHRYSLER

200

14	Left	○	G52117	143336 ⁵⁴	○	G51863	143337 ⁶⁷
	Right	○	G52118	143336 ⁵⁴	○	G51863	143337 ⁶⁷
	Convertible Left	○	G57577 ⁴⁰	○	G57579 ⁴⁰
	Convertible Right	○	G57578 ⁴⁰	○	G57579 ⁴⁰
	Sedan Left	○	G57465 ⁴⁰	○	G57447 ⁴⁰
	Sedan Right	○	G57466 ⁴⁰	○	G57447 ⁴⁰
12-13	All	○	143336 ⁵³	○	143337 ⁶⁷
	Left	○	G52117	143336 ⁵³	○	143337 ⁶⁷
	Right Standard Suspension	○	G52118	143336 ⁵³	○	143337 ⁶⁷
	Standard Suspension	○	143336 ⁵³	○	G51863	143337 ⁶⁷
	Convertible Left	○	G57577 ⁴⁰	143336 ⁵³	○	G57579 ⁴⁰	143337 ⁶⁷
	Convertible Right	○	G57578 ⁴⁰	143336 ⁵³	○	G57579 ⁴⁰	143337 ⁶⁷

CHRYSLER

7 Pair Packs, Air hose kit included.

40 Complete Assembled Unit.

54 Kit with Mount and Bearing. Hardware from O.E. Part may need to be reused.



80 Mounting bracket not required, install on O.E. Shock Mounts. See Ref. C for optional Steering Stabilizer Boots

8 Pair Packs.

53 Hardware from O.E. Part may need to be reused.

67 Mount Kit. Hardware from O.E. Part may need to be reused.

APPLICATION GUIDE

Year	Fitment Notes										
		Ultra	Ready Mounts	Max Control\ LTV Severe Duty\ ProGuard\ Guardian	Strut Cushion\ Strut Mount\ Dampers\ Stabilizer	Hijackers\ Load Carrier\ Classic	Ultra	Ready Mounts	Max Control\ LTV Severe Duty\ ProGuard\ Guardian	Strut Cushion\ Strut Mount\ Dampers\ Stabilizer	Hijackers\ Load Carrier\ Classic

CHRYSLER

200 (cont)

12-13	Sedan Left	...	G57465 ⁴⁰	...	143336 ⁵³	G57447 ⁴⁰	...	143337 ⁶⁷	...
	Sedan Right	...	G57466 ⁴⁰	...	143336 ⁵³	G57447 ⁴⁰	...	143337 ⁶⁷	...
11	All	143336 ^{53,54}	143337 ⁶⁷	...
	Left	G52117	143336 ^{53,54}	143337 ⁶⁷	...
	Right Standard Suspension	G52118	143336 ^{53,54}	143337 ⁶⁷	...
	Standard Suspension	143336 ^{53,54}	...	G51863	143337 ⁶⁷	...
	Convertible Left	...	G57577 ⁴⁰	...	143336 ^{53,54}	G57579 ⁴⁰	...	143337 ⁶⁷	...
	Convertible Right	...	G57578 ⁴⁰	...	143336 ^{53,54}	G57579 ⁴⁰	...	143337 ⁶⁷	...
	Sedan Left	...	G57465 ⁴⁰	...	143336 ^{53,54}	G57447 ⁴⁰	...	143337 ⁶⁷	...
	Sedan Right	...	G57466 ⁴⁰	...	143336 ^{53,54}	G57447 ⁴⁰	...	143337 ⁶⁷	...

CHRYSLER

300

14-22	RWD	G51721
11-13	All	143468 ⁶⁸
	RWD	143468 ⁶⁸	...	G51721
06-10	RWD, Left	...	G57071 ⁴⁰ G57194 ⁴⁰	143335 ⁶⁷	...
	RWD, Right	...	G57072 ⁴⁰ G57195 ⁴⁰	143335 ⁶⁷	...
05-10	All	143335 ⁶⁷	...
	AWD, Exc. Nivomat Suspension	70086	143335 ⁶⁷	...
	RWD	143369 ⁵³	143335 ⁶⁷	...
	RWD, Exc. Nivomat Suspension	G51721	143335 ⁶⁷	...
	RWD, Left Exc. Performance Suspension	G51761	143335 ⁶⁷	...
	RWD, Left Performance Suspension	G51947	143335 ⁶⁷	...
	RWD, Right Exc. Performance Suspension	G51760	143335 ⁶⁷	...
RWD, Right Performance Suspension	G51948	143335 ⁶⁷	...	
05	RWD, Left	...	G57071 ⁴⁰	143335 ⁶⁷	...
	RWD, Right	...	G57072 ⁴⁰	143335 ⁶⁷	...
70-71	All	82011	49149 ⁷	
65-69	All	82011	49106 ⁷ 82131	
57-64	All	82072	...	81469	...	49110 ⁷	

7 Pair Packs, Air hose kit included.



53 Hardware from O.E. Part may need to be reused.

56 68 Mount Kit. Hardware from O.E. Part may need to be reused.;

40 Complete Assembled Unit.

67 Mount Kit. Hardware from O.E. Part may need to be reused.

APPLICATION GUIDE

Year	Fitment Notes										
		Ultra	Ready Mounts	Max Control\ LTV Severe Duty\ ProGuard\ Guardian	Strut Cushion\ Strut Mount\ Dampers\ Stabilizer	HiJackers\ Load Carrier\ Classic	Ultra	Ready Mounts	Max Control\ LTV Severe Duty\ ProGuard\ Guardian	Strut Cushion\ Strut Mount\ Dampers\ Stabilizer	HiJackers\ Load Carrier\ Classic

CHRYSLER 300M

99-04	Left		G56962 ⁴⁰	143057 ⁵¹		G55856	G56964 ⁴⁰	142828 ⁵³ 143058 ⁵¹
	Right		G56963 ⁴⁰	143057 ⁵¹		G55856	G56964 ⁴⁰	142828 ⁵³ 143058 ⁵¹

CHRYSLER

ASPEN

07-09	All		G64016	61720		G63892
-------	-----	--	--------	------	-------	------	------	--	--------	------	------	------	------

CIRRUS

99-00	All		143030 ⁵³ 143064 ⁵¹		G51268	G57025 ⁴⁰	143063 ⁵¹
	2.4L & 2.7L Left		G57431 ⁴⁰	143030 ⁵³ 143064 ⁵¹		G51268	G57025 ⁴⁰	143063 ⁵¹
	2.4L & 2.7L Right		G57432 ⁴⁰	143030 ⁵³ 143064 ⁵¹		G51268	G57025 ⁴⁰	143063 ⁵¹
	J2(MfrBodyCode)		G51267	143030 ⁵³ 143064 ⁵¹		G51268	G57025 ⁴⁰	143063 ⁵¹
95-98	All		143030 ⁵³ 143064 ⁵¹	G57437 ⁴⁰	143063 ⁵¹
	Convertible		143030 ⁵³ 143064 ⁵¹	G57422 ⁴⁰ G57437 ⁴⁰	143063 ⁵¹

CONCORDE

98-04	Left		G56962 ⁴⁰	143057 ⁵¹		G55856	G56964 ⁴⁰	142828 ⁵³ 143058 ⁵¹
	Right		G56963 ⁴⁰	143057 ⁵¹		G55856	G56964 ⁴⁰	142828 ⁵³ 143058 ⁵¹
93-97	All		142755 ⁵⁷ 142842 ⁵⁴ 143057 ⁵¹

CONQUEST

87-89	Exc. Electronic Adjustable Suspension		143058 ⁵¹	143057 ⁵¹
-------	---------------------------------------	--	------	------	------	----------------------	------	--	------	------	------	----------------------	------

CORDOBA

77-79	All		81153
75-76	All		81153	49106 ⁷ 82131

CROSSFIRE

04-08	All		70064		70065
-------	-----	--	-------	------	------	------	------	--	-------	------	------	------	------

DAYTONA

87-93	All		G55526	142567 ⁵⁷ 142933 ⁵⁸ 142940 ⁵⁶		69632	81459	49369 ⁷
	CAN		G55526	143059 ⁵¹ 142567 ⁵⁷ 142933 ⁵⁸ 142940 ⁵⁶		69632	81459	49369 ⁷
86	All		G55526	142933 ⁵⁸ 142940 ⁵⁶		69632	81459	49369 ⁷
	CAN		G55526	142567 ⁵⁷ 143059 ⁵¹ 142933 ⁵⁸ 142940 ⁵⁶		69632	81459	49369 ⁷
84-85	All			69632	81459	49369 ⁷

7 Pair Packs, Air hose kit included.

51 Strut Cushion for use with the Strut/Cartridge/Shocks.

54 Kit with Mount and Bearing. Hardware from O.E. Part may need to be reused.

67 Mount Kit. Hardware from O.E. Part may need to be reused.



40 Complete Assembled Unit.

53 Hardware from O.E. Part may need to be reused.

66 Upper Spring Seat with Spacer. Hardware from O.E. Part may need to be reused.

68 Mount Kit. Hardware from O.E. Part may need to be reused.;

APPLICATION GUIDE

Year	Fitment Notes										
		Ultra	Ready Mounts	Max Control\ LTV Severe Duty\ ProGuard\ Guardian	Strut Cushion\ Strut Mount\ Dampers\ Stabilizer	Hijackers\ Load Carrier\ Classic	Ultra	Ready Mounts	Max Control\ LTV Severe Duty\ ProGuard\ Guardian	Strut Cushion\ Strut Mount\ Dampers\ Stabilizer	Hijackers\ Load Carrier\ Classic

CHRYSLER

DYNASTY

88-93	All		142567 ⁶⁷ 142933 ⁶⁸ 142940 ⁶⁶
	Exc. Hydraulic Self-Leveling System		G55526	142567 ⁶⁷ 142933 ⁶⁸ 142940 ⁶⁶
	CAN		143059 ⁵¹ 142567 ⁶⁷ 142933 ⁶⁸ 142940 ⁶⁶

CHRYSLER

E CLASS

84	All		69632	81459	49369 ⁷
83	All		143057 ⁵¹	69632	81459	49369 ⁷

EXECUTIVE LIMOUSINE

85	All		69632	81459	49369 ⁷
----	-----	--	------	------	------	------	------	-------	------	-------	------	--------------------

EXECUTIVE SEDAN

84	All		69632	81459	49369 ⁷
83	All		143057 ⁵¹	69632	81459	49369 ⁷

IMPERIAL

90-93	All		142933 ⁶⁸ 143059 ⁵¹
	Exc. Hydraulic Self-Leveling System		G55526	142567 ⁶⁷ 142940 ⁶⁶ 142933 ⁶⁸ 143059 ⁵¹	69632	81459	49369 ⁷
74-75	All		49106 ⁷ 82131
67-73	All		82011	81091	49149 ⁷
57-66	All		82072	81469	49110 ⁷
55	All		81469	49110 ⁷

INTREPID

98-04	Left		G56962 ⁴⁰	G55856	142828 ⁵³
	Right		G56963 ⁴⁰	G55856	142828 ⁵³
	CAN		143057 ⁵¹	143058 ⁵¹
93-97	CAN		142842 ⁵⁴ 143057 ⁵¹

LASER

86	All		G55526	142567 ⁶⁷ 142933 ⁶⁸	69632	81459	49369 ⁷
	Mfg. from 1/2/86		G55526	142940 ⁶⁶ 142567 ⁶⁷ 142933 ⁶⁸	69632	81459	49369 ⁷
84-85	All		69632	81459	49369 ⁷

LEBARON

86-95	All		G55526	142567 ⁶⁷ 142933 ⁶⁸ 143059 ⁵¹	69632	81459	49369 ⁷
-------	-----	--	--------	------	------	----------------------------------------------------------------------	------	-------	------	-------	------	--------------------

7 Pair Packs, Air hose kit included.

51 Strut Cushion for use with the Strut/Cartridge/Shocks.

54 Kit with Mount and Bearing. Hardware from O.E. Part may need to be reused.

67 Mount Kit. Hardware from O.E. Part may need to be reused.



40 Complete Assembled Unit.

53 Hardware from O.E. Part may need to be reused.

66 Upper Spring Seat with Spacer. Hardware from O.E. Part may need to be reused.











68 Mount Kit. Hardware from O.E. Part may need to be reused.

APPLICATION GUIDE

Year	Fitment Notes										
		Ultra	Ready Mounts	Max Control\ LTV Severe Duty\ ProGuard\ Guardian	Strut Cushion\ Strut Mount\ Dampers\ Stabilizer	HiJackers\ Load Carrier\ Classic	Ultra	Ready Mounts	Max Control\ LTV Severe Duty\ ProGuard\ Guardian	Strut Cushion\ Strut Mount\ Dampers\ Stabilizer	HiJackers\ Load Carrier\ Classic







CHRYSLER

LEBARON (cont)



86-95	Mfg. from 1/2/86		G55526	142940 ⁶⁶ 142567 ⁶⁷ 142933 ⁶⁸ 143059 ⁵¹		69632	81459	49369 ⁷
84-85	All			69632	81459	49369 ⁷
82-83	All		143057 ⁵¹		69632	81459	49369 ⁷
81	All		143057 ⁵¹		69632	81459
	Exc. M Body		143057 ⁵¹		69632	81459	49369 ⁷

CHRYSLER





LHS

99-01	Left		G56962 ⁴⁰	143057 ⁵¹		G55856	G56964 ⁴⁰	142828 ⁵³ 143058 ⁵¹
	Right		G56963 ⁴⁰	143057 ⁵¹		G55856	G56964 ⁴⁰	142828 ⁵³ 143058 ⁵¹
94-97	All		142755 ⁶⁷ 142842 ⁵⁴ 143057 ⁵¹		143058 ⁵¹



























NASSAU

55-56	All			81469	49110 ⁷
-------	-----	------------------------------------------------------------------------------------	------	------	------	------	------	--------------------------------------------------------------------------------------	------	------	-------	------	--------------------

NEON

00-02	Left		G55892	G56975 ⁴⁰	M55892	142932 ⁶⁸		G56973 ⁴⁰	143057 ⁵¹ 143256 ⁵³
	Right		G55892	G56975 ⁴⁰	M55892	142932 ⁶⁸		G56974 ⁴⁰	143057 ⁵¹ 143256 ⁵³

NEW YORKER

94-96	All		142755 ⁶⁷ 142842 ⁵⁴ 143057 ⁵¹	
88-93	All		G55526	142567 ⁶⁷ 142933 ⁶⁸	
	Exc. Hydraulic Self-Leveling System		G55526	142567 ⁶⁷ 142933 ⁶⁸		69632	81459	49369 ⁷
	Mfg. from 1/2/86		G55526	142940 ⁶⁶ 142567 ⁶⁷ 142933 ⁶⁸	
86-87	All		G55526	142567 ⁶⁷ 142933 ⁶⁸		69632	81459	49369 ⁷
	Mfg. from 1/2/86		G55526	142940 ⁶⁶ 142567 ⁶⁷ 142933 ⁶⁸		69632	81459	49369 ⁷
84-85	All			69632	81459	49369 ⁷
83	All		143057 ⁵¹		69632	81459	49369 ⁷
74-78	All			49106 ⁷ 82131
70-73	All		82011		81091	49149 ⁷
65-69	All		82011		49106 ⁷ 82131
57-64	All		82072		81469	49110 ⁷
51-56	All			81469	49110 ⁷

7 Pair Packs, Air hose kit included.

51 Strut Cushion for use with the Strut/Cartridge/Shocks.

54 Kit with Mount and Bearing. Hardware from O.E. Part may need to be reused.

67 Mount Kit. Hardware from O.E. Part may need to be reused.



40 Complete Assembled Unit.

53 Hardware from O.E. Part may need to be reused.

66 Upper Spring Seat with Spacer. Hardware from O.E. Part may need to be reused.

68 Mount Kit. Hardware from O.E. Part may need to be reused.;

APPLICATION GUIDE

Year	Fitment Notes										
		Ultra	Ready Mounts	Max Control\ LTV Severe Duty\ ProGuard\ Guardian	Strut Cushion\ Strut Mount\ Dampers\ Stabilizer	HiJackers\ Load Carrier\ Classic	Ultra	Ready Mounts	Max Control\ LTV Severe Duty\ ProGuard\ Guardian	Strut Cushion\ Strut Mount\ Dampers\ Stabilizer	HiJackers\ Load Carrier\ Classic

CHRYSLER

NEWPORT

79-81	All	○	81153
74-78	All	○	49106 ⁷ 82131
70-73	All	○	82011	49149 ⁷
65-69	All	○	82011	49106 ⁷ 82131
57-64	All	○	82072	49110 ⁷
51-56	All	○	49110 ⁷

CHRYSLER

PACIFICA

04-08	Left	↑	G56772	G57112 ⁴⁰	143059 ⁵¹
	Right	↑	G56772	G57113 ⁴⁰	143059 ⁵¹

PT CRUISER

01-10	All	↑	G55896	G56965 ⁴⁰	M55896	142932 ⁶⁸	○	69473	143057 ⁵¹
-------	-----	---	--------	----------------------	--------	----------------------	------	---	-------	------	------	----------------------	------

SARATOGA

57-60	All	○	82072	○	81469	49110 ⁷
51-52	All	○	○	81469	49110 ⁷

SEBRING

08-10	Left	↑	G52117	143336 ⁵³	↑	G51863	143337 ⁶⁷
	Right	↑	G52118	143336 ⁵³	↑	G51863	143337 ⁶⁷
	Convertible Left	↑	G57577 ⁴⁰	↑	G57579 ⁴⁰
	Convertible Right	↑	G57578 ⁴⁰	↑	G57579 ⁴⁰
	Sedan Left	↑	G57465 ⁴⁰	↑	G57447 ⁴⁰
	Sedan Right	↑	G57466 ⁴⁰	↑	G57447 ⁴⁰
07	All	↑	143336 ⁵³	↑	G51863	143337 ⁶⁷
03-06	Sedan and Convertible; JR (MfrBodyCode)	↑	G51267	143423 ⁶⁷	↑	G51268	143321 ⁵³ 143423 ⁶⁷
01-06	Convertible	↑	↑	G57422 ⁴⁰
	Sedan, JR(MfrBodyCode)	↑	↑	G57026 ⁴⁰
01-05	Coupe, ST(MfrBodyCode)	↑	143087 ⁵³	↑	G51254	G57075 ⁴⁰	142419 ⁶⁸
01-02	Sedan and Convertible; JR (MfrBodyCode)	↑	G51267	143423 ⁶⁷	↑	G51268	143321 ⁵³
99-00	Convertible	↑	143030 ⁵³ 143064 ⁵¹	↑	143063 ⁵¹ 143320 ⁵³
	Coupe	↑	G55820	142419 ⁶⁸ 143057 ⁵¹	↑	G51254	G57075 ⁴⁰	142419 ⁶⁸ 143057 ⁵¹
	Sedan and Convertible; JR (MfrBodyCode)	↑	G51267	↑	G51268

7 Pair Packs, Air hose kit included.

51 Strut Cushion for use with the Strut/Cartridge/Shocks.



60 67 Mount Kit. Hardware from O.E. Part may need to be reused.

40 Complete Assembled Unit.

53 Hardware from O.E. Part may need to be reused.

68 Mount Kit. Hardware from O.E. Part may need to be reused.;

APPLICATION GUIDE

Year	Fitment Notes										
		Ultra	Ready Mounts	Max Control\ LTV Severe Duty\ ProGuard\ Guardian	Strut Cushion\ Strut Mount\ Dampers\ Stabilizer	HiJackers\ Load Carrier\ Classic	Ultra	Ready Mounts	Max Control\ LTV Severe Duty\ ProGuard\ Guardian	Strut Cushion\ Strut Mount\ Dampers\ Stabilizer	HiJackers\ Load Carrier\ Classic

CHRYSLER

SEBRING (cont)

96-98	Convertible	143030 ⁵³ 143064 ⁵¹	143063 ⁵¹
	Coupe	G55820	142419 ⁶⁸ 143057 ⁵¹	G51254	142419 ⁶⁸ 143057 ⁵¹
95	All	142419 ⁶⁸ 143057 ⁵¹	142419 ⁶⁸ 143057 ⁵¹
	Coupe	G55820	142419 ⁶⁸ 143057 ⁵¹	G51254	142419 ⁶⁸ 143057 ⁵¹

CHRYSLER

SPIRIT

92-95	All	69632
-------	-----	-------	-------	-------	-------	-------	-------	-------	-------	-------	-------

ST REGIS

55-56	All	81469	49110 ⁷
-------	-----	-------	-------	-------	-------	-------	-------	-------	-------	-------	--------------------

TOWN & COUNTRY

08-16	All	G57206 ⁴⁰	143463 ⁶⁸
	Exc. Self-Leveling Suspension	G57206 ⁴⁰	143463 ⁶⁸	G64042
	Exc. S Models	G52131	G57206 ⁴⁰	143463 ⁶⁸
01-07	All	G56620	49236 ⁷
	Exc. Hydraulic Self-Leveling System	G56620	G63690 ¹⁰	61605 ³⁴ 81878	49236 ⁷
	Left	G56620	G56956 ⁴⁰	49236 ⁷
	Right	G56620	G56957 ⁴⁰	49236 ⁷
96-00	All	G55697	M55697	143059 ⁵¹	49236 ⁷
	Exc. Hydraulic Self-Leveling System	G55697	M55697	143059 ⁵¹	G63690 ¹⁰	61605 ³⁴ 81878	49236 ⁷
90-95	All	142567 ⁶⁷ 142933 ⁶⁸ 142940 ⁶⁶ 143059 ⁵¹	G63426	49236 ⁷
86-88	All	G55526	142567 ⁶⁷	69632	81459	49369 ⁷
82-85	All	69632	81459	49369 ⁷
79-81	All	81153
74-78	All	49106 ⁷ 82131
71-73	All	82011	81091	49149 ⁷
65-70	All	82011	49106 ⁷ 82131
57-64	All	82072	81469	49110 ⁷
51-56	All	81469	49110 ⁷

VOYAGER / GRAND VOYAGER

03-07	Left	G56620	G56956 ⁴⁰	143059 ⁵¹
-------	------	--------	----------------------	-------	----------------------	-------	-------	-------	-------	-------	-------

7 Pair Packs, Air hose kit included.

34 If suspension spring contacts this unit, rotate suspension spring 180 degrees.

51 Strut Cushion for use with the Strut/Cartridge/Shocks.

66 Upper Spring Seat with Spacer. Hardware from O.E. Part may need to be reused.

68 Mount Kit. Hardware from O.E. Part may need to be reused.;



10 The Nivomat leveling shocks are on the rear only. If suspension spring contacts units, rotate suspension spring 180 degrees.

40 Complete Assembled Unit.

53 Hardware from O.E. Part may need to be reused.

67 Mount Kit. Hardware from O.E. Part may need to be reused.

APPLICATION GUIDE

Year	Fitment Notes										
		Ultra	Ready Mounts	Max Control\ LTV Severe Duty\ ProGuard\ Guardian	Strut Cushion\ Strut Mount\ Dampers\ Stabilizer	HiJackers\ Load Carrier\ Classic	Ultra	Ready Mounts	Max Control\ LTV Severe Duty\ ProGuard\ Guardian	Strut Cushion\ Strut Mount\ Dampers\ Stabilizer	HiJackers\ Load Carrier\ Classic

CHRYSLER

CHRYSLER

VOYAGER / GRAND VOYAGER (cont)

03-07	Right	↑	G56620	G56957 ⁴⁰	143059 ⁵¹	↑
03	All	↑	G56620	143059 ⁵¹	↑
	Exc. Hydraulic Self-Leveling System	↑	G56620	143059 ⁵¹	○	G63690 ¹⁰	61605 ³⁴ 81878	49236 ⁷
01-02	All	↑	G56620	143059 ⁵¹	○	49236 ⁷
	Exc. Hydraulic Self-Leveling System	↑	G56620	143059 ⁵¹	○	G63690 G63690 ¹⁰	61605 ³⁴ 81878	49236 ⁷
	Left	↑	G56620	G56956 ⁴⁰	143059 ⁵¹	○	49236 ⁷
	Right	↑	G56620	G56957 ⁴⁰	143059 ⁵¹	○	49236 ⁷
00	All	↑	G55697	M55697	143059 ⁵¹	○	49236 ⁷
	Exc. Hydraulic Self-Leveling System	↑	G55697	M55697	143059 ⁵¹	○	G63690 G63690 ¹⁰	61605 ³⁴ 81878	49236 ⁷
	Non-ABS	↑	G55697	M55697	143059 ⁵¹	○	49236 ⁷
	Non-ABS Exc. Hydraulic Self-Leveling System	↑	G55697	M55697	143059 ⁵¹	○	61605 ³⁴ 81878	49236 ⁷

WINDSOR

57-61	All	↑	82072	○	81469	49110 ⁷
51-56	All	↑	○	81469	49110 ⁷

DAEWOO

DAEWOO

LANOS

99-02	All	○	G44903 ⁶⁸	↑
-------	-----	---	----------------------	------	------	------	------	---	------	------	------	------	------

DAIHATSU

DAIHATSU

ROCKY

90-92	All	↑	G63611	81872	↑	81270
-------	-----	---	--------	------	-------	------	------	---	------	------	-------	------	------

DODGE

DODGE

330

63-64	All	↑	82090	○	49106 ⁷ 82131
-------	-----	---	------	------	------	------	-------	---	------	------	------	------	-----------------------------

400

82-83	All	↑	143057 ⁵¹	○	69632	81459	49369 ⁷
-------	-----	---	------	------	------	----------------------	------	---	-------	------	-------	------	--------------------

440

63-64	All	↑	82090	○	49106 ⁷ 82131
-------	-----	---	------	------	------	------	-------	---	------	------	------	------	-----------------------------

600

87-88	All	↑	G55526	142567 ⁶⁷ 142933 ⁶⁸ 142940 ⁶⁶	○	69632	81459	49369 ⁷
-------	-----	---	--------	------	------	----------------------------------------------------------------------	------	---	-------	------	-------	------	--------------------

7 Pair Packs, Air hose kit included.

34 If suspension spring contacts this unit, rotate suspension spring 180 degrees.

51 Strut Cushion for use with the Strut/Cartridge/Shocks.

67 Mount Kit. Hardware from O.E. Part may need to be reused.

98 Notice: The level of difficulty to install this product is moderately high. Please

review the installation instructions carefully before proceeding



10 The Nivomat leveling shocks are on the rear only. If suspension spring contacts units, rotate suspension spring 180 degrees.

40 Complete Assembled Unit.

66 Upper Spring Seat with Spacer. Hardware from O.E. Part may need to be reused.









68 Mount Kit. Hardware from O.E. Part may need to be reused.

APPLICATION GUIDE

Year	Fitment Notes										
		Ultra	Ready Mounts	Max Control\ LTV Severe Duty\ ProGuard\ Guardian	Strut Cushion\ Strut Mount\ Dampers\ Stabilizer	HiJackers\ Load Carrier\ Classic	Ultra	Ready Mounts	Max Control\ LTV Severe Duty\ ProGuard\ Guardian	Strut Cushion\ Strut Mount\ Dampers\ Stabilizer	HiJackers\ Load Carrier\ Classic





DODGE

600 (cont)





86	All		G55526	142567 ⁵⁷ 142933 ⁵⁸ 142940 ⁶⁶		69632	49369 ⁷
	Mfg. to 2/86		G55526	142567 ⁵⁷ 142933 ⁵⁸ 142940 ⁶⁶		69632	81459	49369 ⁷
84-85	All			69632	81459	49369 ⁷
83	All		143057 ⁵¹		69632	81459	49369 ⁷

DODGE









880

65	All		82011		49106 ⁷ 82131
62-64	All		82072		81469	49110 ⁷







2000 GTX

89-90	Exc. Auto-Leveling System		142219 ⁵³		142419 ⁶⁸
89	CAN			143064 ⁵¹









A100 TRUCK

64-70	All			81469	49110 ⁷
70	Dual System Steering Stabilizer; with I-Beam Axle		6802SE ⁸⁴		81469	49110 ⁷
	Single System Steering Stabilizer; with I Beam Axle		6803SE ⁸⁴		81469	49110 ⁷
64-69	Dual System Steering Stabilizer		6802SE ⁸⁴		81469	49110 ⁷







ARIES

86-89	All		G55526	142567 ⁵⁷ 142933 ⁵⁸ 142940 ⁶⁶		69632	81459	49369 ⁷
84-85	All			69632	81459	49369 ⁷
81-83	All		143057 ⁵¹		69632	81459	49369 ⁷

ATTITUDE

12-14	Left		G52353		70095
	Right		G52354		70095
06-11	Left		G52154		70036
	Right		G52155		70036

AVENGER

08-14	Left		G52117	G57465 ⁴⁰	143336 ⁵³		G51863	G57447 ⁴⁰	143337 ⁶⁷
	Right		G52118	G57466 ⁴⁰	143336 ⁵³		G51863	G57447 ⁴⁰	143337 ⁶⁷
95-00	All		G55820	142419 ⁶⁸		G51254	142419 ⁶⁸

7 Pair Packs, Air hose kit included.

51 Strut Cushion for use with the Strut/Cartridge/Shocks.

66 Upper Spring Seat with Spacer. Hardware from O.E. Part may need to be reused.

68 Mount Kit. Hardware from O.E. Part may need to be reused.;



40 Complete Assembled Unit.

53 Hardware from O.E. Part may need to be reused.

67 Mount Kit. Hardware from O.E. Part may need to be reused.

84 Replacement damper for vehicles with the Gabriel Aftermarket mounting kit

APPLICATION GUIDE

Year	Fitment Notes										
		Ultra	Ready Mounts	Max Control\ LTV Severe Duty\ ProGuard\ Guardian	Strut Cushion\ Strut Mount\ Dampers\ Stabilizer	HiJackers\ Load Carrier\ Classic	Ultra	Ready Mounts	Max Control\ LTV Severe Duty\ ProGuard\ Guardian	Strut Cushion\ Strut Mount\ Dampers\ Stabilizer	HiJackers\ Load Carrier\ Classic

DODGE

CALIBER

DODGE

12	Left		G52081	G57176 ⁴⁰	143495 ⁵⁴		G51842	G57178 ⁴⁰	143337 ⁶⁷
	Right		G52082	G57177 ⁴⁰	143495 ⁵⁴		G51842	G57178 ⁴⁰	143337 ⁶⁷
07-11	Left		G52081	G57176 ⁴⁰	143495 ⁵⁴		G51842	G57178 ⁴⁰	143337 ⁶⁷ 143496 ⁶⁷
	Right		G52082	G57177 ⁴⁰	143495 ⁵⁴		G51842	G57178 ⁴⁰	143337 ⁶⁷ 143496 ⁶⁷

CARAVAN / GRAND CARAVAN

19-20	All		G57206 ⁴⁰		G64042
17-20	Exc. GT & RT Models		G52131	G57206 ⁴⁰		G64042
17-18	All		G57206 ⁴⁰
12-16	Exc. Self-Leveling Suspension		G57206 ⁴⁰	143463 ⁶⁸		G64042
	Exc. GT & RT Models		G52131	G57206 ⁴⁰	143463 ⁶⁸
08-16	All		G57206 ⁴⁰	143463 ⁶⁸
08-11	Exc. Self-Leveling Suspension		G52131	G57206 ⁴⁰	143463 ⁶⁸		G64042
06-07	All		G56620
	Left		G56620	G56956 ⁴⁰
	Right		G56620	G56957 ⁴⁰
01-07	Exc. Hydraulic Self-Leveling System		G56620		G63690 ¹⁰	61605 ³⁴ 81878	49236 ⁷
05	All		G56620		G63690 ¹⁰
	Left		G56620	G56956 ⁴⁰		G63690 ¹⁰
	Right		G56620	G56957 ⁴⁰		G63690 ¹⁰
01-04	All		G56620
	Left		G56620	G56956 ⁴⁰
	Right		G56620	G56957 ⁴⁰
96-00	All		143059 ⁵¹
	Exc. Hydraulic Self-Leveling System		G55697	M55697	143059 ⁵¹		G63690 ¹⁰	61605 ³⁴ 81878	49236 ⁷
86-95	All		142567 ⁶⁷ 142933 ⁶⁸ 142940 ⁶⁶ 143059 ⁵¹		G63426	49236 ⁷
84-85	All		143059 ⁵¹		G63426	49236 ⁷

7 Pair Packs, Air hose kit included.

34 If suspension spring contacts this unit, rotate suspension spring 180 degrees.

51 Strut Cushion for use with the Strut/Cartridge/Shocks.

66 Upper Spring Seat with Spacer. Hardware from O.E. Part may need to be reused.

68 Mount Kit. Hardware from O.E. Part may need to be reused.;





10 The Nivomat leveling shocks are on the rear only. If suspension spring contacts units, rotate suspension spring 180 degrees.

40 Complete Assembled Unit.

54 Kit with Mount and Bearing. Hardware from O.E. Part may need to be reused.

67 Mount Kit. Hardware from O.E. Part may need to be reused.











APPLICATION GUIDE

Year	Fitment Notes										
		 Ultra	Ready Mounts	Max Control\ LTV Severe Duty\ ProGuard\ Guardian	Strut Cushion\ Strut Mount\ Dampers\ Stabilizer	HiJackers\ Load Carrier\ Classic	 Ultra	Ready Mounts	Max Control\ LTV Severe Duty\ ProGuard\ Guardian	Strut Cushion\ Strut Mount\ Dampers\ Stabilizer	HiJackers\ Load Carrier\ Classic



































DODGE

CHALLENGER











DODGE

11-22	RWD, Exc. Nivomat Suspension			G51721
08-10	Left		G51947	143369 ⁵³		143335 ⁵⁷
	Right		G51948	143369 ⁵³		143335 ⁵⁷
78-83	All		143059 ⁵¹	
70-74	All		82090		49106 ⁷ 82131

CHARGER

11-22	RWD, Exc. Nivomat Suspension			G51721
11-13	AWD		143468 ⁶⁸	
07-10	AWD, Exc. Nivomat Suspension			70086	143335 ⁵⁷
	RWD, Exc. Nivomat Suspension			G51721	143335 ⁵⁷
06-10	All			143335 ⁵⁷
	RWD		143369 ⁵³		143335 ⁵⁷
	RWD, Left		G57071 ⁴⁰ G57194 ⁴⁰		143335 ⁵⁷
	RWD, Left Exc. Police Models		G51761		143335 ⁵⁷
	RWD, Left Police Package		G51947		143335 ⁵⁷
	RWD, Right		G57072 ⁴⁰ G57195 ⁴⁰		143335 ⁵⁷
	RWD, Right Exc. Police Models		G51760		143335 ⁵⁷
RWD, Right Police Package		G51948		143335 ⁵⁷	
06	Exc. Nivomat Suspension			G51721	143335 ⁵⁷
83-87	All		143057 ⁵¹		142173 ⁵³
77-78	All		81153	
73-76	All		81153		49106 ⁷ 82131
66-72	All		82090		49106 ⁷ 82131

COLT

93-95	All		G55911	142329 ⁵³		G51063	142419 ⁶⁸ 143064 ⁵¹
	Exc. Wagon		G55911	143057 ⁵¹ 142329 ⁵³		G51063	142419 ⁶⁸ 143064 ⁵¹
92	All		142240 ⁵⁴		142419 ⁶⁸ 143064 ⁵¹
	Exc. Wagon		143057 ⁵¹ 142240 ⁵⁴		142419 ⁶⁸ 143064 ⁵¹
90-91	Exc. Wagon		143057 ⁵¹	

7 Pair Packs, Air hose kit included.

51 Strut Cushion for use with the Strut/Cartridge/Shocks.

54 Kit with Mount and Bearing. Hardware from O.E. Part may need to be reused.



68 Mount Kit. Hardware from O.E. Part may need to be reused.;

40 Complete Assembled Unit.

53 Hardware from O.E. Part may need to be reused.

67 Mount Kit. Hardware from O.E. Part may need to be reused.

APPLICATION GUIDE

Year	Fitment Notes										
		Ultra	Ready Mounts	Max Control\ LTV Severe Duty\ ProGuard\ Guardian	Strut Cushion\ Strut Mount\ Dampers\ Stabilizer	HiJackers\ Load Carrier\ Classic	Ultra	Ready Mounts	Max Control\ LTV Severe Duty\ ProGuard\ Guardian	Strut Cushion\ Strut Mount\ Dampers\ Stabilizer	HiJackers\ Load Carrier\ Classic

DODGE

DODGE

COLT (cont)

89-91	Hatchback	↓	142240 ⁵⁴	↓	142419 ⁶⁸ 143064 ⁵¹
85-91	Vista, FWD, Wagon	↓	143059 ⁵¹	↓
84	Wagon	↓	143059 ⁵¹	↓
75-80	Wagon	↓	143059 ⁵¹	○	43048 ⁸ 49310 ⁷ 82156
77-79	Exc. Wagon & Hatchback	↓	○	81676
71-74	All	↓	○	43048 ⁸ 49310 ⁷ 82156
	Wagon	↓	143059 ⁵¹	○	43048 ⁸ 49310 ⁷ 82156

CONQUEST

84-86	All	↓	↓	143058 ⁵¹
-------	-----	---	------	------	------	------	------	---	------	------	------	----------------------	------

CORONET

73-76	All	○	81153	○	49106 ⁷ 82131
65-72	All	○	82090	○	49106 ⁷ 82131
57-59	All	○	82072	○	81469	49110 ⁷
51-56	All	○	○	81469	49110 ⁷

CUSTOM

57-61	All	○	82072	○	81469	49110 ⁷
54-56	All	○	○	81469	49110 ⁷

D50

79-82	RWD	○	G63950	61556	○	G63907	61500 77907 81147	43048 ⁸ 49310 ⁷
	Single System Steering Stabilizer	○	6802SE ⁵⁴	○
82	4WD	○	G63418	61529	○	G63419

DAKOTA

10	4WD	○	○	G63891
	RWD	○	○	G63890
05-09	All	↓	G51815	143385 ⁶⁸	↓
	4WD	↓	G51815	G57146 ⁴⁰	143385 ⁶⁸	↓	G63891
	RWD	↓	G51815	G57409 ⁴⁰	143385 ⁶⁸	↓	G63890
97-04	All	○	○	G63403	58403 61658 77403 81923
	4WD	○	G63905	61601 77905 81836	○	G63403	58403 61658 77403 81923

7 Pair Packs, Air hose kit included.

40 Complete Assembled Unit.

54 Kit with Mount and Bearing. Hardware from O.E. Part may need to be reused.





84 Replacement damper for vehicles with the Gabriel Aftermarket mounting kit

8 Pair Packs.

51 Strut Cushion for use with the Strut/Cartridge/Shocks.

68 Mount Kit. Hardware from O.E. Part may need to be reused.;









APPLICATION GUIDE

Year	Fitment Notes										
			Ultra	Ready Mounts	Max Control\ LTV Severe Duty\ ProGuard\ Guardian	Strut Cushion\ Strut Mount\ Dampers\ Stabilizer	HiJackers\ Load Carrier\ Classic		Ultra	Ready Mounts	Max Control\ LTV Severe Duty\ ProGuard\ Guardian









DODGE

DODGE











DAKOTA (cont)

97-04	RWD		G63915	61512 77915 81559		G63403	58403 61658 77403 81923
87-96	4WD		61679		61584 81837
	RWD		G63915	61512 77915 81559		81560
87-94	Single System Steering Stabilizer		6804SE ⁸⁰	

















DART

13-16	Sport Suspension			G511142
63-76	All		82090		81469	49110 ⁷
62	All		82090		49106 ⁷ 82131
60-61	All		82072		81469	49110 ⁷



DAYTONA

87-93	All		142567 ⁶⁷ 142933 ⁶⁸ 143059 ⁵¹	
	Exc. Shelby & Base Models		G55526	142940 ⁶⁶ 142567 ⁶⁷ 142933 ⁶⁸ 143059 ⁵¹		69632	81459	49369 ⁷
86	All		G55526	142567 ⁶⁷ 142933 ⁶⁸ 142940 ⁶⁶ 143059 ⁵¹	
	Exc. Shelby & Base Models		G55526	142567 ⁶⁷ 142933 ⁶⁸ 142940 ⁶⁶ 143059 ⁵¹		69632	81459	49369 ⁷
84-85	Exc. Shelby & Base Models			69632	81459	49369 ⁷

DURANGO

16-21	All			G511000
11-15	Left		G57749 ⁴⁰		G511000
	Right		G57825 ⁴⁰		G511000
04-09	All		G64016	61720		G63892	61734
99-03	RWD		G63915	61512 77915 81559		G63403	77403
98-03	All			G63403	77403
	4WD		G63905	61601 77905 81836		G63403	77403
	Exc. AWD			G63403	58403 61658 81923 77403

DYNASTY

88-93	All		142933 ⁶⁸ 143059 ⁵¹	
-------	-----	-------------------------------------------------------------------------------------	------	------	------	----------------------------------------------	------	---------------------------------------------------------------------------------------	------	------	------	------	------

7 Pair Packs, Air hose kit included.

51 Strut Cushion for use with the Strut/Cartridge/Shocks.

67 Mount Kit. Hardware from O.E. Part may need to be reused.



80 Mounting bracket not required, install on O.E. Shock Mounts. See Ref. C for optional Steering Stabilizer Boots

40 Complete Assembled Unit.

66 Upper Spring Seat with Spacer. Hardware from O.E. Part may need to be reused.

68 Mount Kit. Hardware from O.E. Part may need to be reused.;



APPLICATION GUIDE

Year	Fitment Notes										
		Ultra	Ready Mounts	Max Control\ LTV Severe Duty\ ProGuard\ Guardian	Strut Cushion\ Strut Mount\ Dampers\ Stabilizer	HiJackers\ Load Carrier\ Classic	Ultra	Ready Mounts	Max Control\ LTV Severe Duty\ ProGuard\ Guardian	Strut Cushion\ Strut Mount\ Dampers\ Stabilizer	HiJackers\ Load Carrier\ Classic







DODGE

DODGE



























DYNASTY (cont)

88-93	Exc. Hydraulic Self-Leveling System		G55526	142567 ⁶⁷ 142940 ⁶⁶ 142933 ⁶⁸ 143059 ⁵¹	
-------	-------------------------------------	-----------------------------------------------------------------------------------	--------	------	------	----------------------------------------------------------------------------------------------	------	-----------------------------------------------------------------------------------	------	------	------	------	------







INTREPID

98-04	Left		G56962 ⁴⁰	143057 ⁵¹		G55856	G56964 ⁴⁰	142828 ⁵³ 143058 ⁵¹
	Right		G56963 ⁴⁰	143057 ⁵¹		G55856	G56964 ⁴⁰	142828 ⁵³ 143058 ⁵¹
93-97	All		142755 ⁶⁷ 142842 ⁵⁴ 143057 ⁵¹	



JOURNEY

17-20	Exc. GT Left		G52148	
	Exc. GT Right		G52149	
14-20	FWD; Exc. GT & R/T Models Left		G57266 ⁴⁰	
	FWD; Exc. GT & R/T Models Right		G57267 ⁴⁰	
11-20	AWD Right		G57751 ⁴⁰	
20	Left AWD		G57750 ⁴⁰	
12-19	AWD, Left		G57750 ⁴⁰	
14-16	Left		G52148	
	Right		G52149	
09-13	Left		G52148	G57266 ⁴⁰	
	Right		G52149	G57267 ⁴⁰	
11	AWD Left		G57750 ⁴⁰	
09-10	FWD			G51848



LANCER

86-89	All		G55526	142567 ⁶⁷ 142933 ⁶⁸ 142940 ⁶⁶		69632	81459	49369 ⁷
85	All			69632	81459	49369 ⁷
61-62	All		82090		81469	49110 ⁷

M300

74	All		G63605		G63183	82065
----	-----	-------------------------------------------------------------------------------------	--------	------	------	------	------	-------------------------------------------------------------------------------------	--------	------	------	------	-------

M350

74	All		G63605		82065
----	-----	-------------------------------------------------------------------------------------	--------	------	------	------	------	-------------------------------------------------------------------------------------	------	------	------	------	-------

7 Pair Packs, Air hose kit included.

51 Strut Cushion for use with the Strut/Cartridge/Shocks.

54 Kit with Mount and Bearing. Hardware from O.E. Part may need to be reused.

67 Mount Kit. Hardware from O.E. Part may need to be reused.



40 Complete Assembled Unit.

53 Hardware from O.E. Part may need to be reused.

66 Upper Spring Seat with Spacer. Hardware from O.E. Part may need to be reused.

68 Mount Kit. Hardware from O.E. Part may need to be reused.;

APPLICATION GUIDE

Year	Fitment Notes										
		Ultra	Ready Mounts	Max Control\ LTV Severe Duty\ ProGuard\ Guardian	Strut Cushion\ Strut Mount\ Dampers\ Stabilizer	HiJackers\ Load Carrier\ Classic	Ultra	Ready Mounts	Max Control\ LTV Severe Duty\ ProGuard\ Guardian	Strut Cushion\ Strut Mount\ Dampers\ Stabilizer	HiJackers\ Load Carrier\ Classic

DODGE

MAGNUM

DODGE

05-08	All		143335 ⁶⁷
	Exc. Nivomat Suspension			G51721	143335 ⁶⁷
	RWD		143369 ⁶³	143335 ⁶⁷
	RWD, Left		G57071 ⁴⁰ G57194 ⁴⁰	143335 ⁶⁷
	RWD, Left Exc. Performance Suspension		G51761	143335 ⁶⁷
	RWD, Left Performance Suspension		G51947	143335 ⁶⁷
	RWD, Right		G57072 ⁴⁰ G57195 ⁴⁰	143335 ⁶⁷
	RWD, Right Exc. Performance Suspension		G51760	143335 ⁶⁷
	RWD, Right Performance Suspension		G51948	143335 ⁶⁷
78-79	All		81153

MEADOWBROOK

51-54	All		81469	49110 ⁷
-------	-----	--	------	------	------	------	--	------	------	-------	------	--------------------

MINI RAM

87-88	All		143059 ⁶¹		G63426	49236 ⁷
84-86	All		G63359 ³⁵	58359 ³⁶ 61523 ³⁶ 81096 ³⁶	34052 ⁸		G63413 ³⁵	61522 ⁸ 81496	43085 ⁸ 49212 ⁷

MONACO

77-78	All		81153	49106 ⁷ 82131
74-76	All		49106 ⁷ 82131
73	All		82011		81091	82131
	Exc. Wagon		82011		81091	49106 ⁷ 82131
	Wagon		82011		81091	49149 ⁷ 82131
72	All		82011		49106 ⁷ 82131
71	All		82011		81091
	Wagon		82011		81091	49149 ⁷
65-70	All		82011		49106 ⁷ 82131

NEON

00-05	All		142932 ⁶⁸	143057 ⁶¹ 143256 ⁶³
	Exc. SRT4 Left		G55892	G56975 ⁴¹	M55892	142932 ⁶⁸	G56973 ⁴⁰	143057 ⁶¹ 143256 ⁶³
	Exc. SRT4 Right		G55892	G56975 ⁴¹	M55892	142932 ⁶⁸	G56974 ⁴⁰	143057 ⁶¹ 143256 ⁶³

6 It is recommended that when replacing shocks on vehicles with "quad shocks" all 4 shocks should be matched by series.

8 Pair Packs.

40 Complete Assembled Unit.

51 Strut Cushion for use with the Strut/Cartridge/Shocks.

67 Mount Kit. Hardware from O.E. Part may need to be reused.

7 Pair Packs, Air hose kit included.



35 Sight grinding of control arm opening is required to install product made before Aug 1988.

41 Complete Assembled Unit. See Ref. D for procedures to replace Elec Adj Susp with non-adj product.

53 Hardware from O.E. Part may need to be reused.

68 Mount Kit. Hardware from O.E. Part may need to be reused.;



APPLICATION GUIDE

Year	Fitment Notes										
		Ultra	Ready Mounts	Max Control\ LTV Severe Duty\ ProGuard\ Guardian	Strut Cushion\ Strut Mount\ Dampers\ Stabilizer	HiJackers\ Load Carrier\ Classic	Ultra	Ready Mounts	Max Control\ LTV Severe Duty\ ProGuard\ Guardian	Strut Cushion\ Strut Mount\ Dampers\ Stabilizer	HiJackers\ Load Carrier\ Classic





DODGE

DODGE





NEON (cont)

95-99	All		142840 ⁵⁴ 143057 ⁵¹		143059 ⁵¹
-------	-----	-----------------------------------------------------------------------------------	------	------	------	----------------------------------------------	------	-----------------------------------------------------------------------------------	------	------	------	----------------------	------

















NITRO

07-11	Left		G51728	G57007 ⁴⁰		G63844
	Right		G51728	G57008 ⁴⁰		G63844























OMNI

90	All		143059 ⁵¹		142173 ⁵³
78-89	All		143057 ⁵¹		142173 ⁵³

PICKUP 1/2 TON, D100 SERIES

86-93	All		G63359 ³⁵	58359 ³⁵ 61523 ³⁵ 81096 ³⁵	34052 ⁸		G63353	81091	49149 ⁷
86-89	Single System Steering Stabilizer		G63359 ³⁵	58359 ³⁵ 61523 ³⁵ 81096 ³⁵	6802SE ⁸⁴	34052 ⁸		G63353	81091	49149 ⁷
84-85	All		G63359	58359 ³⁵ 61523 ³⁵ 81096 ³⁵	34052 ⁸		G63353	81091	49149 ⁷
72-83	All		G63359 ³⁵	58359 ³⁵ 61523 ³⁵ 81096 ³⁵	34052 ⁸		G63353	81091	49149 ⁷
72-79	Single System Steering Stabilizer		G63359 ³⁵	58359 ³⁵ 61523 ³⁵ 81096 ³⁵	6802SE ⁸⁴	34052 ⁸		G63353	81091	49149 ⁷
61-71	Single System Steering Stabilizer; with I Beam Axle		6802SE ⁸⁴	
60	All		82065	
	Single System Steering Stabilizer; with I Beam Axle		6802SE ⁸⁴	82065	

PICKUP 1/2 TON, W100 SERIES

90-93	Single System Steering Stabilizer		6802SE ⁸⁴	
81-93	Exc. Lift Kit		G63183	61632 81825		81342
81-89	Single System Steering Stabilizer		6803SE ⁸⁴	
81-86	Dual System Steering Stabilizer; Exc. Vacuum Servo Mounted on Drivers Side of Axle		6802SE ⁸⁴	
72-80	All		G63183	61632 81825		81342
	Dual System Steering Stabilizer; Exc. Vacuum Servo Mounted on Drivers Side of Axle		G63183	61632 81825	6802SE ⁸⁴		81342
	Single System Steering Stabilizer		G63183	61632 81825	6803SE ⁸⁴		81342
61-71	All		G63183	61632 81825	
	Dual System Steering Stabilizer; Exc. Vacuum Servo Mounted on Drivers Side of Axle		G63183	61632 81825	6802SE ⁸⁴	
	Single System Steering Stabilizer		G63183	61632 81825	6803SE ⁸⁴	
60	All		82065	

7 Pair Packs, Air hose kit included.

35 Sight grinding of control arm opening is required to install product made before Aug 1988.

51 Strut Cushion for use with the Strut/Cartridge/Shocks.

54 Kit with Mount and Bearing. Hardware from O.E. Part may need to be reused.



8 Pair Packs.

40 Complete Assembled Unit.

53 Hardware from O.E. Part may need to be reused.

84 Replacement damper for vehicles with the Gabriel Aftermarket mounting kit

APPLICATION GUIDE

Year	Fitment Notes										
		Ultra	Ready Mounts	Max Control\ LTV Severe Duty\ ProGuard\ Guardian	Strut Cushion\ Strut Mount\ Dampers\ Stabilizer	HiJackers\ Load Carrier\ Classic	Ultra	Ready Mounts	Max Control\ LTV Severe Duty\ ProGuard\ Guardian	Strut Cushion\ Strut Mount\ Dampers\ Stabilizer	HiJackers\ Load Carrier\ Classic

DODGE

DODGE

PICKUP 1/2 TON, W100 SERIES (cont)

60	Dual System Steering Stabilizer; Exc. Vacuum Servo Mounted on Drivers Side of Axle	○	6802SE ⁸⁴	82065	○
	Single System Steering Stabilizer	○	6803SE ⁸⁴	82065	○

PICKUP 3/4 TON, D200 SERIES

82-93	All	○	○	G63353	81091	49149 ⁷
	Exc. Heavy Duty Package	⊖	G63359 ³⁵	58359 ³⁵ 61523 ³⁵ 81096 ³⁵	34052 ⁸	○	G63353	81091	49149 ⁷
	Heavy Duty Package	⊖	G63360 ³⁵	81834	○	G63353	81091	49149 ⁷
	Single System Steering Stabilizer	○	6802SE ⁸⁴	○	G63353	81091	49149 ⁷
81	All	○	○	G63353	81091
	Exc. Heavy Duty Package	⊖	G63359 ³⁵	58359 ³⁵ 61523 ³⁵ 81096 ³⁵	34052 ⁸	○	G63353	81091	49149 ⁷
	Heavy Duty Package	⊖	G63360 ³⁵	○	G63353	81091
	165.0 / 419.1(WheelBase) Heavy Duty Package	⊖	81834	○	G63353	81091
	Single System Steering Stabilizer	○	6802SE ⁸⁴	○	G63353	81091
75-80	Heavy Duty Package	⊖	G63360 ³⁵	○	G63353	81091	49149 ⁷
	165.0 / 419.1(WheelBase) Heavy Duty Package	⊖	81834	○	G63353	81091	49149 ⁷
73-80	Single System Steering Stabilizer	○	6802SE ⁸⁴	○	G63353	81091	49149 ⁷
72-80	All	○	○	G63353	81091	49149 ⁷
	Exc. Heavy Duty Package	⊖	G63359 ³⁵	58359 ³⁵ 61523 ³⁵ 81096 ³⁵	34052 ⁸	○	G63353	81091	49149 ⁷
72-74	Heavy Duty Package	⊖	G63360 ³⁵	81834	○	G63353	81091	49149 ⁷
61-71	Single System Steering Stabilizer; with I Beam Axle	○	6802SE ⁸⁴	○
60	All	○	82065	○
	Single System Steering Stabilizer; with I Beam Axle	○	6802SE ⁸⁴	82065	○

PICKUP 3/4 TON, W200 SERIES

90-93	Single System Steering Stabilizer	○	6802SE ⁸⁴	○
81-93	Exc. Crew Cab & Lift Kit	○	G63183	61632 81825	○	81342
81-89	Single System Steering Stabilizer	○	6803SE ⁸⁴	○
81-86	Dual System Steering Stabilizer; Exc. Vacuum Servo Mounted on Drivers Side of Axle	○	6802SE ⁸⁴	○
72-80	All	○	G63183	61632 81825	○	81342
	Dual System Steering Stabilizer; Exc. Vacuum Servo Mounted on Drivers Side of Axle	○	G63183	61632 81825	6802SE ⁸⁴	○	81342
	Single System Steering Stabilizer	○	G63183	61632 81825	6803SE ⁸⁴	○	81342
69-71	All	○	G63183	61632 81825	○
	Dual System Steering Stabilizer; Exc. Vacuum Servo Mounted on Drivers Side of Axle	○	G63183	61632 81825	6802SE ⁸⁴	○
	Single System Steering Stabilizer	○	G63183	61632 81825	6803SE ⁸⁴	○

7 Pair Packs, Air hose kit included.

35 Sight grinding of control arm opening is required to install product made before Aug 1988.

8 Pair Packs.

84 Replacement damper for vehicles with the Gabriel Aftermarket mounting kit

APPLICATION GUIDE

Year	Fitment Notes										
		Ultra	Ready Mounts	Max Control\ LTV Severe Duty\ ProGuard\ Guardian	Strut Cushion\ Strut Mount\ Dampers\ Stabilizer	HiJackers\ Load Carrier\ Classic	Ultra	Ready Mounts	Max Control\ LTV Severe Duty\ ProGuard\ Guardian	Strut Cushion\ Strut Mount\ Dampers\ Stabilizer	HiJackers\ Load Carrier\ Classic

DODGE

DODGE

PICKUP 3/4 TON, W200 SERIES (cont)

68	Dual System Steering Stabilizer; Exc. Vacuum Servo Mounted on Drivers Side of Axle	○	6802SE ⁸⁴
61-67	All	○	G63183	61632 81825
	Dual System Steering Stabilizer; Exc. Vacuum Servo Mounted on Drivers Side of Axle	○	G63183	61632 81825	6802SE ⁸⁴
	Single System Steering Stabilizer	○	G63183	61632 81825	6803SE ⁸⁴
60	All	○	82065
	Dual System Steering Stabilizer; Exc. Vacuum Servo Mounted on Drivers Side of Axle	○	6802SE ⁸⁴	82065
	Single System Steering Stabilizer	○	6803SE ⁸⁴	82065

PICKUP 1 TON, D300 SERIES

75-93	Single System Steering Stabilizer	○	6802SE ⁸⁴	G63353	81091	49149 ⁷
72-93	All	○	G63353	81091	49149 ⁷
	Heavy Duty Package	○	G63360 ³⁵	81834	G63353	81091	49149 ⁷
72-74	Single System Steering Stabilizer; with Coil Spring Front Suspension	○	6802SE ⁸⁴	G63353	81091	49149 ⁷
61-71	All	○	82065
	Single System Steering Stabilizer; with I Beam Axle	○	6802SE ⁸⁴	82065
60	Single System Steering Stabilizer; with I Beam Axle	○	6802SE ⁸⁴

PICKUP 1 TON, W300 SERIES

90-93	Single System Steering Stabilizer	○	6802SE ⁸⁴
81-93	Exc. Quad Suspension and Lift Kit	○	G63183	61632 81825	81342
81-89	Single System Steering Stabilizer	○	6803SE ⁸⁴
81-86	Dual System Steering Stabilizer; Exc. Vacuum Servo Mounted on Drivers Side of Axle	○	6802SE ⁸⁴
72-80	All	○	G63183	61632 81825	81342
	Dual System Steering Stabilizer; Exc. Vacuum Servo Mounted on Drivers Side of Axle	○	G63183	61632 81825	6802SE ⁸⁴	81342
	Single System Steering Stabilizer	○	G63183	61632 81825	6803SE ⁸⁴	81342
61-71	All	○	G63183	61632 81825	G63183	61632 81825
	Dual System Steering Stabilizer; Exc. Vacuum Servo Mounted on Drivers Side of Axle	○	G63183	61632 81825	6802SE ⁸⁴	G63183	61632 81825
	Single System Steering Stabilizer	○	G63183	61632 81825	6803SE ⁸⁴	G63183	61632 81825
60	Dual System Steering Stabilizer; Exc. Vacuum Servo Mounted on Drivers Side of Axle	○	6802SE ⁸⁴
	Single System Steering Stabilizer	○	6803SE ⁸⁴

PICKUP 1/2 TON, RAM 1500 (SEE RAM 1500)

09-10	All	○	G64044	77412
	Exc. Mega Cab	○	G64044	58412 77412

7 Pair Packs, Air hose kit included.

35 Sight grinding of control arm opening is required to install product made before Aug 1988.

APPLICATION GUIDE

Year	Fitment Notes										
		Ultra	Ready Mounts	Max Control\ LTV Severe Duty\ ProGuard\ Guardian	Strut Cushion\ Strut Mount\ Dampers\ Stabilizer	HiJackers\ Load Carrier\ Classic	Ultra	Ready Mounts	Max Control\ LTV Severe Duty\ ProGuard\ Guardian	Strut Cushion\ Strut Mount\ Dampers\ Stabilizer	HiJackers\ Load Carrier\ Classic

DODGE

DODGE

PICKUP 1/2 TON, RAM 1500 (SEE RAM 1500) (cont)

09-10	4WD	G51856	G57147 ⁴⁰	G64044	77412
	RWD	G64043	G64044	77412
06-08	Exc. Mega Cab	58412 77412
08	All	77412
	4WD, Mega Cab	61712	77412
	4WD; Exc. Mega Cab	G51758	G57053 ⁴⁰	143324 ⁵³	G63961	61691 81931 77412
	4WD; w/5.7L	77980	77412
	RWD, Exc. Mega Cab	34052 ⁸	77412
	RWD, Extended Crew Cab Pickup	77949	77412
	RWD; Exc. Mega Cab	G63958	77954 81933	G63962	61692 77412
06-07	4WD, Mega Cab	61712
	4WD; Exc. Mega Cab	G51758	G57053 ⁴⁰	143324 ⁵³	G63961	61691 81931
	4WD; w/5.7L	77980	77412
	4WD; With OEM # 52106909AB, AC, AD	6847SE ⁸²
	RWD, Exc. Mega Cab	34052 ⁸
	RWD, Extended Crew Cab Pickup	77949
	RWD; Exc. Mega Cab	G63958	77954 81933	G63962	61692
02-05	All	G63675	58412 77412
	4WD	G63848	77947 81932	G63675	61691 81931 58412 77412
	4WD; With OEM # 52106909AB, AC, AD	6847SE ⁸²	G63675	58412 77412
	RWD	G63958	77954 81933	34052 ⁸	G63675	61692 58412 77412
00-01	4WD; With OEM # 52106909AB, AC, AD	6847SE ⁸²	G63662	58662 61600 77662 81873	43181 ⁹ 49235 ⁷
94-01	All	G63662	58662 61600 77662 81873	43181 ⁹ 49235 ⁷
	4WD	G63673	61634 77673 81919	G63662	58662 61600 77662 81873	43181 ⁹ 49235 ⁷
	RWD	G63661	61599 77661 81928	G63662	58662 61600 77662 81873	43181 ⁹ 49235 ⁷
94-97	4WD; With OEM 52038276	6804SE ⁸⁰	G63662	58662 61600 77662 81873	43181 ⁹ 49235 ⁷

7 Pair Packs, Air hose kit included.

40 Complete Assembled Unit.



80 Mounting bracket not required, install on O.E. Shock Mounts. See Ref. C for optional Steering Stabilizer Boots

8 Pair Packs.

53 Hardware from O.E. Part may need to be reused.

82 Use kit if listed, See Ref. C for optional Steering Stabilizer Boots.

APPLICATION GUIDE

Year	Fitment Notes										
		Ultra	Ready Mounts	Max Control\ LTV Severe Duty\ ProGuard\ Guardian	Strut Cushion\ Strut Mount\ Dampers\ Stabilizer	HiJackers\ Load Carrier\ Classic	Ultra	Ready Mounts	Max Control\ LTV Severe Duty\ ProGuard\ Guardian	Strut Cushion\ Strut Mount\ Dampers\ Stabilizer	HiJackers\ Load Carrier\ Classic

DODGE

DODGE

PICKUP 3/4 TON, RAM 2500 (SEE RAM 2500)

09-10	4WD	 O	77948	 O	61716 77950
03-10	All	 O	 O	77950
	4WD, 8800# GVW	 O	 O	G64013	77950
	RWD	 O	77949	 O	77950
07-08	4WD	 O	G64011	61714 77948	 O	61716 77950
03-08	RWD, Crew Cab Pickup	 O	 O	G63971	61710 77950
03-07	4WD; With OEM # 52106909AB, AC, AD	 O	6847SE ⁸²	 O	77950
06	4WD	 O	G64011	61714	 O	61716 77950
	4WD; Exc. 5.7L	 O	77948	 O	77950
	4WD; w/5.7L	 O	77980	 O	77950
05	4WD	 O	G64011	61714 77948	 O	61716 77950
03-04	4WD	 O	77948	 O	61716 77950
03	Exc. 8800# GVW	 O	 O	G63662	61600 81873 77950
00-02	4WD; With OEM # 52106909AB, AC, AD	 O	6847SE ⁸²	 O
99-02	4WD, Exc. 8800# GVW	 O	G63673	61634 77673 81919	 O
94-02	Exc. 8800# GVW	 O	 O	G63662	58662 61600 77662 81873	49235 ⁷
	4WD, 8800# GVW	 O	G63674	61635 77674	 O	G63675	61642 77675 81921
	RWD	 O	G63661	61599 77661 81928	 O
96-98	4WD, Exc. 8800# GVW	 O	G63673	61634 77673	 O
94-97	4WD; With OEM 52038276	 O	6804SE ⁸⁰	 O
94-95	4WD, Exc. 8800# GVW	 O	G63673	61634 77673 81919	 O

PICKUP 1 TON, RAM 3500 (SEE RAM 3500)



07-10	4WD	 O	G63673	77948	 O	77950
03-10	All	 O	 O	77950
	RWD	 O	77949	 O	77950
03-07	4WD; With OEM # 52106909AB, AC, AD	 O	6847SE ⁸²	 O	77950
	RWD, Crew Cab Pickup	 O	 O	G63971	61710 77950
	RWD; With OEM # 52106909AB, AC, AD and Solid Front Axle	 O	6847SE ⁸²	 O	77950
06	4WD	 O	G63673	 O	77950
	4WD, Exc. 5.9L	 O	77948	 O	77950
	4WD; w/5.7L	 O	77980	 O	77950
03-05	4WD	 O	G63673	77948	 O	77950

7 Pair Packs, Air hose kit included.

82 Use kit if listed, See Ref. C for optional Steering Stabilizer Boots.

80 Mounting bracket not required, install on O.E. Shock Mounts. See Ref. C for optional Steering Stabilizer Boots

APPLICATION GUIDE

Year	Fitment Notes										
		Ultra	Ready Mounts	Max Control\ LTV Severe Duty\ ProGuard\ Guardian	Strut Cushion\ Strut Mount\ Dampers\ Stabilizer	HiJackers\ Load Carrier\ Classic	Ultra	Ready Mounts	Max Control\ LTV Severe Duty\ ProGuard\ Guardian	Strut Cushion\ Strut Mount\ Dampers\ Stabilizer	HiJackers\ Load Carrier\ Classic

DODGE

DODGE

PICKUP 1 TON, RAM 3500 (SEE RAM 3500) (cont)

00-02	4WD; With OEM # 52106909AB, AC, AD	○	6847SE ⁸²		
	RWD; With OEM # 52106909AB, AC, AD and Solid Front Axle	○	6847SE ⁸²		
94-02	4WD	○	G63674	61635 77674	○	G63675	61642 77675 81921
	RWD, Exc. Solid Front Axle	○	G63661	61599 77661 81928	○	G63662	58662 61600 77662 81873	43181 ⁸ 49235 ⁷
	RWD, Solid Front Axle	○	G63674	61635 77674	○	G63675	61642 77675 81921
94-97	4WD; With OEM 52038276	○	6804SE ⁸⁰	
	RWD; w/ OEM 52038276 Solid Front Axle	○	6804SE ⁸⁰	

PICKUP, RAM 50

87-93	4WD	○	61529	○	G63419
	RWD	○	G63950	61556	○	G63907	61500 77907 81147	43048 ⁸ 49310 ⁷
	Single System Steering Stabilizer	○	6802SE ⁸⁴
83-86	All	○	○	G63907	61500 77907	43048 ⁸ 49310 ⁷
	4WD	○	G63418	○	G63907	61500 77907	43048 ⁸ 49310 ⁷
	RWD	○	G63950	61556	○	G63907	81147 61500 77907	43048 ⁸ 49310 ⁷
	Single System Steering Stabilizer	○	6802SE ⁸⁴	○	G63907	61500 77907	43048 ⁸ 49310 ⁷

POLARA

73	All	○	82011	○	81091
	Exc. Wagon	○	82011	○	81091	49106 ⁷ 82131
	Wagon	○	82011	○	81091	49149 ⁷
72	All	○	82011	○	49106 ⁷ 82131
71	All	○	82011	○	81091
	Wagon	○	82011	○	81091	49149 ⁷
65-70	All	○	82011	○	49106 ⁷ 82131
62-64	All	○	82090	○	49106 ⁷ 82131
60-61	All	○	82072	○	81469	49110 ⁷

RAIDER

87-89	All	○	G63418	61529	○	81318	49311 ⁷
	Exc. Sport Utility	○	G63418	61529	○	G63492	81318	49311 ⁷
	2.6L 4Cyl	○	G63418	61529	○	61506 81318	49311 ⁷
	Single System Steering Stabilizer	○	G63418	61529	6802SE ⁸⁴	81318	49311 ⁷
89	Sport Utility	○	G63418	61529	○	G63604	81318	49311 ⁷

7 Pair Packs, Air hose kit included.



80 Mounting bracket not required, install on O.E. Shock Mounts. See Ref. C for optional Steering Stabilizer Boots

84 Replacement damper for vehicles with the Gabriel Aftermarket mounting kit

8 Pair Packs.

82 Use kit if listed, See Ref. C for optional Steering Stabilizer Boots.

APPLICATION GUIDE

Year	Fitment Notes										
		Ultra	Ready Mounts	Max Control\ LTV Severe Duty\ ProGuard\ Guardian	Strut Cushion\ Strut Mount\ Dampers\ Stabilizer	HiJackers\ Load Carrier\ Classic	Ultra	Ready Mounts	Max Control\ LTV Severe Duty\ ProGuard\ Guardian	Strut Cushion\ Strut Mount\ Dampers\ Stabilizer	HiJackers\ Load Carrier\ Classic

DODGE

DODGE

RAMCHARGER

87-93	Single System Steering Stabilizer	○	6802SE ⁸⁴ 6803SE ⁸⁴	○
76-93	4WD	○	G63183	61632 81825	○	81342
	RWD	○	G63359 ³⁵	58359 ³⁵ 61523 ³⁵ 81096 ³⁵	34052 ²	○	G63353	81091	49149 ⁷
76-86	Dual System Steering Stabilizer; Exc. Vacuum Servo Mounted on Drivers Side of Axle	○	6802SE ⁸⁴	○
	Single System Steering Stabilizer	○	6803SE ⁸⁴	○
75	All	○	○	49149 ⁷
	4WD	○	G63183	61632 81825	○	49149 ⁷
	Dual System Steering Stabilizer; Exc. Vacuum Servo Mounted on Drivers Side of Axle	○	6802SE ⁸⁴	○	49149 ⁷
	RWD	○	G63359 ³⁵	58359 ³⁵ 61523 ³⁵ 81096 ³⁵	34052 ⁸	○	G63353	81091	49149 ⁷
	Single System Steering Stabilizer	○	6803SE ⁸⁴	○	49149 ⁷
74	All	○	○	G63353	49149 ⁷
	RWD	○	○	G63353	81091	49149 ⁷
	4WD	○	G63183	61632 81825	○	G63353	49149 ⁷
	Dual System Steering Stabilizer; Exc. Vacuum Servo Mounted on Drivers Side of Axle	○	6802SE ⁸⁴	○	G63353	49149 ⁷
	Single System Steering Stabilizer	○	6803SE ⁸⁴	○	G63353	49149 ⁷

RAMPAGE

82-84	All	○	143057 ⁵¹	○
-------	-----	---	------	------	------	----------------------	------	---	------	------	------	------	------

RD200

78-80	All	○	G63183	81825	○	81342
-------	-----	---	--------	------	-------	------	------	---	------	------	-------	------	------

ROYAL MONACO

75-77	All	○	○	49106 ⁷ 82131
-------	-----	---	------	------	------	------	------	---	------	------	------	------	-----------------------------

SHADOW

87-94	All	○	G55526	142567 ⁶⁷ 142933 ⁶⁸ 142940 ⁶⁶ 143059 ⁵¹	○	69632	81459	49369 ⁷
-------	-----	---	--------	------	------	----------------------------------------------------------------------------------------------	------	---	-------	------	-------	------	--------------------

SPIRIT

89-95	All	○	G55526	142567 ⁶⁷ 142933 ⁶⁸ 142940 ⁶⁶ 143059 ⁵¹	○	69632	81459	49369 ⁷
-------	-----	---	--------	------	------	----------------------------------------------------------------------------------------------	------	---	-------	------	-------	------	--------------------

SPRINTER 2500

07-09	All	○	G57802⁴⁰	○
-------	-----	---	------	----------------------------	------	------	------	---	------	------	------	------	------

7 Pair Packs, Air hose kit included.

35 Sight grinding of control arm opening is required to install product made before Aug 1988.

51 Strut Cushion for use with the Strut/Cartridge/Shocks.

67 Mount Kit. Hardware from O.E. Part may need to be reused.

84 Replacement damper for vehicles with the Gabriel Aftermarket mounting kit



8 Pair Packs.

40 Complete Assembled Unit.

66 Upper Spring Seat with Spacer. Hardware from O.E. Part may need to be reused.

68 Mount Kit. Hardware from O.E. Part may need to be reused.;





APPLICATION GUIDE

Year	Fitment Notes										
		Ultra	Ready Mounts	Max Control\ LTV Severe Duty\ ProGuard\ Guardian	Strut Cushion\ Strut Mount\ Dampers\ Stabilizer	HiJackers\ Load Carrier\ Classic	Ultra	Ready Mounts	Max Control\ LTV Severe Duty\ ProGuard\ Guardian	Strut Cushion\ Strut Mount\ Dampers\ Stabilizer	HiJackers\ Load Carrier\ Classic









DODGE

DODGE



SPRINTER 2500 (cont)

07-09	Single Rear Wheels		G57802⁴⁰		G63918
03-06	All		G56778	
	Exc. Dual Rear Wheels		G56778		G63918



SPRINTER 3500

07-09	All		G57802⁴⁰	
	Single Rear Wheels		G57802⁴⁰		G63918
03-06	All		G56778	
	Exc. Dual Rear Wheels		G56778		G63918























ST. REGIS

79-81	All		81153	
-------	-----	-----------------------------------------------------------------------------------	------	------	-------	------	------	-------------------------------------------------------------------------------------	------	------	------	------	------





STEALTH

91-96	All			142419 ⁶⁸
-------	-----	------------------------------------------------------------------------------------	------	------	------	------	------	--------------------------------------------------------------------------------------	------	------	------	----------------------	------

STRATUS

01-06	Sedan		G51267		G51268	G57026 ⁴⁰	143321 ⁵³
	Sedan and Convertible; JR (MfrBodyCode)		143423 ⁶⁷		143423 ⁶⁷
01-05	Coupe			G57075 ⁴⁰
	Coupe, ST(MfrBodyCode)		143087 ⁵³		G51254	142419 ⁶⁸
99-00	All		143064 ⁵¹		G57025 ⁴⁰	143063 ⁵¹
	2.4L & 2.7L Left		G57431 ⁴⁰	143064 ⁵¹		G57025 ⁴⁰	143063 ⁵¹
	2.4L & 2.7L Right		G57432 ⁴⁰	143064 ⁵¹		G57025 ⁴⁰	143063 ⁵¹
	Sedan		G51267	143064 ⁵¹		G51268	G57025 ⁴⁰	143063 ⁵¹
	Sedan and Convertible; JR (MfrBodyCode)		143064 ⁵¹		G57025 ⁴⁰	143423 ⁶⁷ 143063 ⁵¹
95-98	All		143030 ⁵³ 143064 ⁵¹		G57437 ⁴⁰	143063 ⁵¹
	Convertible		143030 ⁵³ 143064 ⁵¹		G57422 ⁴⁰ G57437 ⁴⁰	143063 ⁵¹

TRUCK

59-60	All		82065	
53-58	All		82065		82065

40 Complete Assembled Unit.

53 Hardware from O.E. Part may need to be reused.



68 Mount Kit. Hardware from O.E. Part may need to be reused.;

Bold Type - New / Future Part

51 Strut Cushion for use with the Strut/Cartridge/Shocks.

67 Mount Kit. Hardware from O.E. Part may need to be reused.



















APPLICATION GUIDE

Year	Fitment Notes										
		Ultra	Ready Mounts	Max Control\ LTV Severe Duty\ ProGuard\ Guardian	Strut Cushion\ Strut Mount\ Dampers\ Stabilizer	HiJackers\ Load Carrier\ Classic	Ultra	Ready Mounts	Max Control\ LTV Severe Duty\ ProGuard\ Guardian	Strut Cushion\ Strut Mount\ Dampers\ Stabilizer	HiJackers\ Load Carrier\ Classic

















DODGE

DODGE











VAN 1/2 TON, A / B SERIES / RAM

99-03	109.3 / 277.6(WheelBase) Exc. 7000# GVW		G63359 ³⁵	58359 ³⁵ 61523 ³⁵ 81096 ³⁵	34052 ⁸		G63413	61522 ⁸ 81496	43085 ⁸ 49212 ⁷
82-98	109.6 / 278.4(WheelBase) Exc. 7000# GVW		G63359 ³⁵	58359 ³⁵ 61523 ³⁵ 81096 ³⁵	34052 ⁸		G63413	61522 ⁸ 81496	43085 ⁸ 49212 ⁷
81-87	Single System Steering Stabilizer		6803SE ⁸⁴
81	109.6 / 278.4(WheelBase) Exc. 7000# GVW		G63359 ³⁵	58359 ³⁵ 61523 ³⁵ 81096 ³⁵		G63413	61522 ⁸ 81496	43085 ⁸
71-80	All		58359 ³⁵ 61523 ³⁵ 81096 ³⁵	34052 ⁸		G63413	61522 ⁸ 81496	43085 ⁸ 49212 ⁷
	Exc. 4000# Front Axle		G63359 ³⁵	58359 ³⁵ 61523 ³⁵ 81096 ³⁵	34052 ⁸		G63413	61522 ⁸ 81496	43085 ⁸ 49212 ⁷
	Single System Steering Stabilizer		58359 ³⁵ 61523 ³⁵ 81096 ³⁵	6803SE ⁸⁴	34052 ⁸		G63413	61522 ⁸ 81496	43085 ⁸ 49212 ⁷
71	Single System Steering Stabilizer; with I Beam Axle		58359 ³⁵ 61523 ³⁵ 81096 ³⁵	6802SE ⁸⁴	34052 ⁸		G63413	61522 ⁸ 81496	43085 ⁸ 49212 ⁷
64-70	All			81469	49110 ⁷
	Van			81469	82065 49110 ⁷

VAN 3/4 TON, A / B SERIES / RAM

81-03	All		G63359 ³⁵	58359 ³⁵ 61523 ³⁵ 81096 ³⁵	34052 ⁸		G63413	61522 ⁸ 81496	43085 ⁸ 49212 ⁷
81-87	Single System Steering Stabilizer		G63359 ³⁵	58359 ³⁵ 61523 ³⁵ 81096 ³⁵	6803SE ⁸⁴	34052 ⁸		G63413	61522 ⁸ 81496	43085 ⁸ 49212 ⁷
71-80	All		58359 ³⁵ 61523 ³⁵ 81096 ³⁵	34052 ⁸		G63413	61522 ⁸ 81496	43085 ⁸ 49212 ⁷
	Exc. 4000# Front Axle		G63359 ³⁵	58359 ³⁵ 61523 ³⁵ 81096 ³⁵	34052 ⁸		G63413	61522 ⁸ 81496	43085 ⁸ 49212 ⁷
80	Single System Steering Stabilizer		58359 ³⁵ 61523 ³⁵ 81096 ³⁵	6803SE ⁸⁴	34052 ⁸		G63413	61522 ⁸ 81496	43085 ⁸ 49212 ⁷
78-79	Van Charger Special		58359 ³⁵ 61523 ³⁵ 81096 ³⁵	6803SE ⁸⁴	34052 ⁸		G63413	61522 ⁸ 81496	43085 ⁸ 49212 ⁷
71-77	Single System Steering Stabilizer		58359 ³⁵ 61523 ³⁵ 81096 ³⁵	6803SE ⁸⁴	34052 ⁸		G63413	61522 ⁸ 81496	43085 ⁸ 49212 ⁷
71	Single System Steering Stabilizer; with I Beam Axle		58359 ³⁵ 61523 ³⁵ 81096 ³⁵	6802SE ⁸⁴	34052 ⁸		G63413	61522 ⁸ 81496	43085 ⁸ 49212 ⁷

VAN 1 TON, A / B SERIES / RAM

99-03	All		G63359 ³⁵	58359 ³⁵ 61523 ³⁵ 81096 ³⁵	34052 ⁸		G63413	61522 ⁸ 81496	43085 ⁸ 49212 ⁷
95-98	Exc. 4000# Front Axle		G63359 ³⁵	58359 ³⁵ 61523 ³⁵ 81096 ³⁵	34052 ⁸		G63413	61522 ⁸ 81496	43085 ⁸ 49212 ⁷
71-94	Exc. 4000# Front Axle		G63359 ³⁵	58359 ³⁵ 61523 ³⁵ 81096 ³⁵	34052 ⁸		G63413	61522 ⁸ 81496	43085 ⁸ 49212 ⁷
94	All			61522 ⁸ 81496	43085 ⁸ 49212 ⁷
71-93	All			G63413	61522 ⁸ 81496	43085 ⁸ 49212 ⁷

6 It is recommended that when replacing shocks on vehicles with "quad shocks" all 4 shocks should be matched by series.



8 Pair Packs.

78 84 Replacement damper for vehicles with the Gabriel Aftermarket mounting kit

7 Pair Packs, Air hose kit included.

35 Sight grinding of control arm opening is required to install product made before Aug 1988.

APPLICATION GUIDE

Year	Fitment Notes										
		Ultra	Ready Mounts	Max Control\ LTV Severe Duty\ ProGuard\ Guardian	Strut Cushion\ Strut Mount\ Dampers\ Stabilizer	HiJackers\ Load Carrier\ Classic	Ultra	Ready Mounts	Max Control\ LTV Severe Duty\ ProGuard\ Guardian	Strut Cushion\ Strut Mount\ Dampers\ Stabilizer	HiJackers\ Load Carrier\ Classic

DODGE

DODGE

VAN 1 TON, A / B SERIES / RAM (cont)

71-93	4000# Front Axle	I	G63360 ³⁵	81834	O	G63413	61522 ⁶ 81496	43085 ⁵ 49212 ⁷
71-87	Single System Steering Stabilizer	O	6803SE ⁸⁴	O	G63413	61522 ⁶ 81496	43085 ⁵ 49212 ⁷
71	Single System Steering Stabilizer; with I Beam Axle	O	6802SE ⁸⁴	O	G63413	61522 ⁶ 81496	43085 ⁵ 49212 ⁷

VAN 1 TON, P SERIES

66-72	All		O	82065
61-64	All		O	82065

VAN, CB300

78-80	All		O	G63413	61522 ⁶ 81496	43085 ⁵ 49212 ⁷
	4000# Front Axle	I	G63360 ³⁵	81834	O	G63413	61522 ⁶ 81496	43085 ⁵ 49212 ⁷
	Exc. 4000# Front Axle	I	G63359 ³⁵	58359 ³⁵ 61523 ³⁵ 81096 ³⁵	34052 ⁸	O	G63413	61522 ⁶ 81496	43085 ⁵ 49212 ⁷
77	All		O	G63413	61522 ⁶ 81496	43085 ⁵
	4000# Front Axle	I	G63360 ³⁵	81834	O	G63413	61522 ⁶ 81496	43085 ⁵
	Exc. 4000# Front Axle	I	G63359 ³⁵	61523 ³⁵ 81096 ³⁵	O	G63413	61522 ⁶ 81496	43085 ⁵
	Over 8300# GVW		O	G63413	61522 ⁶ 81496	49212 ⁷ 43085 ⁵
	Up through 8300# GVW	I	58359 ³⁵	34052 ⁸	O	G63413	61522 ⁶ 81496	43085 ⁵
75-76	All		O	G63413	61522 ⁶ 81496	43085 ⁵ 49212 ⁷
	4000# Front Axle	I	G63360 ³⁵	81834	O	G63413	61522 ⁶ 81496	43085 ⁵ 49212 ⁷
	Exc. 4000# Front Axle	I	G63359 ³⁵	61523 ³⁵ 81096 ³⁵	O	G63413	61522 ⁶ 81496	43085 ⁵ 49212 ⁷
	Up through 8300# GVW	I	58359 ³⁵	34052 ⁸	O	G63413	61522 ⁶ 81496	43085 ⁵ 49212 ⁷
74	All		O	G63413	61522 ⁶ 81496	43085 ⁵
	4000# Front Axle	I	G63360 ³⁵	81834	O	G63413	61522 ⁶ 81496	43085 ⁵
	Exc. 4000# Front Axle	I	G63359 ³⁵	61523 ³⁵ 81096 ³⁵	O	G63413	61522 ⁶ 81496	43085 ⁵
	Over 8300# GVW		O	G63413	61522 ⁶ 81496	49212 ⁷ 43085 ⁵
	Up through 8300# GVW	I	58359 ³⁵	34052 ⁸	O	G63413	61522 ⁶ 81496	43085 ⁵

EAGLE

EAGLE

2000 GTX

91-93	All		I	142419 ⁹⁸
	CAN	I	143057 ⁵¹	I	143064 ⁵¹ 142419 ⁹⁸

SUMMIT

93-96	All	I	143057 ⁵¹	I	142419 ⁹⁸
	Coupe	I	G55911	142329 ⁵³ 143057 ⁵¹	I	G51063	142419 ⁹⁸

6 It is recommended that when replacing shocks on vehicles with "quad shocks" all 4 shocks should be matched by series.

8 Pair Packs.

51 Strut Cushion for use with the Strut/Cartridge/Shocks.

68 Mount Kit. Hardware from O.E. Part may need to be reused.;





7 Pair Packs, Air hose kit included.

35 Sight grinding of control arm opening is required to install product made before Aug 1988.

53 Hardware from O.E. Part may need to be reused.

84 Replacement damper for vehicles with the Gabriel Aftermarket mounting kit

















APPLICATION GUIDE

Year	Fitment Notes										
		 Ultra	Ready Mounts	Max Control\ LTV Severe Duty\ ProGuard\ Guardian	Strut Cushion\ Strut Mount\ Dampers\ Stabilizer	HiJackers\ Load Carrier\ Classic	 Ultra	Ready Mounts	Max Control\ LTV Severe Duty\ ProGuard\ Guardian	Strut Cushion\ Strut Mount\ Dampers\ Stabilizer	HiJackers\ Load Carrier\ Classic









EAGLE

EAGLE



SUMMIT (cont)

93-96	Sedan		G55911	142329 ⁵³ 143057 ⁵¹		G51063	142419 ⁶⁸
	Wagon		143057 ⁵¹		69462	142419 ⁶⁸
91-92	Sedan		142240 ⁵⁴ 143057 ⁵¹		142419 ⁶⁸ 143064 ⁵¹
92	All		143057 ⁵¹	
	Wagon		143057 ⁵¹		69462	142419 ⁶⁸
91	All		143057 ⁵¹		143064 ⁵¹
89-90	All		142240 ⁵⁴ 143057 ⁵¹		143064 ⁵¹
	Sedan		142240 ⁵⁴ 143057 ⁵¹		142419 ⁶⁸ 143064 ⁵¹



TALON

95-98	All		142419 ⁶⁸		142419 ⁶⁸
	AWD		142419 ⁶⁸		G51712	142419 ⁶⁸
	FWD		142419 ⁶⁸		G51254	142419 ⁶⁸
90-94	All		142219 ⁵³ 143057 ⁵¹		142419 ⁶⁸ 143064 ⁵¹

VISION

93-97	All		142755 ⁶⁷ 142842 ⁵⁴ 143057 ⁵¹	
-------	-----	-------------------------------------------------------------------------------------	------	------	------	----------------------------------------------------------------------	------	-------------------------------------------------------------------------------------	------	------	------	------	------



VISTA

89-91	CAN, Wagon		143059 ⁵¹	
-------	------------	-------------------------------------------------------------------------------------	------	------	------	----------------------	------	-------------------------------------------------------------------------------------	------	------	------	------	------



EDSEL

EDSEL





BERMUDA

58	All		82099	
----	-----	-------------------------------------------------------------------------------------	------	------	------	-------	------	-------------------------------------------------------------------------------------	------	------	------	------	------



CITATION

58	All		82099	
----	-----	-------------------------------------------------------------------------------------	------	------	------	-------	------	-------------------------------------------------------------------------------------	------	------	------	------	------





CORSAIR

58-59	All		82099		82076
	Exc. Wagon		82099		81469	49110 ⁷ 82076

PACER

58	All		82099	
----	-----	-------------------------------------------------------------------------------------	------	------	------	-------	------	-------------------------------------------------------------------------------------	------	------	------	------	------

RANGER

58-60	All		82099		82076
58-59	Exc. Wagon		82099		81469	49110 ⁷ 82076

7 Pair Packs, Air hose kit included.

53 Hardware from O.E. Part may need to be reused.



67 Mount Kit. Hardware from O.E. Part may need to be reused.

51 Strut Cushion for use with the Strut/Cartridge/Shocks.

54 Kit with Mount and Bearing. Hardware from O.E. Part may need to be reused.

68 Mount Kit. Hardware from O.E. Part may need to be reused.;

APPLICATION GUIDE

Year	Fitment Notes										
		Ultra	Ready Mounts	Max Control\ LTV Severe Duty\ ProGuard\ Guardian	Strut Cushion\ Strut Mount\ Dampers\ Stabilizer	HiJackers\ Load Carrier\ Classic	Ultra	Ready Mounts	Max Control\ LTV Severe Duty\ ProGuard\ Guardian	Strut Cushion\ Strut Mount\ Dampers\ Stabilizer	HiJackers\ Load Carrier\ Classic

EDSEL

EDSEL

ROUNDUP

58	All	I	82099	I
----	-----	---	-------	-------	-------	-------	-------	---	-------	-------	-------	-------	-------

VILLAGER

58-60	All	I	82099	O	82076
58-59	Exc. Wagon	I	82099	O	81469	49110 ⁷ 82076

FIAT

FIAT

124

68-76	Wagon	I	O	82156
67	Wagon	I	O	49310 ⁷ 82156
66	Wagon	I	O	49310 ⁷

1100

66-67	Exc. Wagon	I	O	43140 ⁸ 82155
	Wagon	I	O	49310 ⁷ 82156

1500

64-67	Exc. Wagon	I	O	43140 ⁸ 82155
	Wagon	I	O	49310 ⁷ 82156

FORD

FORD

AEROSTAR

89-97	All	I	O	49221 ⁷
	RWD	I	81582	O	49221 ⁷
86-88	RWD	I	81582	O	G63490	61541 81583

ASPIRE

94-97	Non-ABS	I	G55615	143057 ⁵¹	I
-------	---------	---	--------	-------	-------	----------------------	-------	---	-------	-------	-------	-------	-------

BRONCO

80-96	Exc. Lift Kit	I	O	G63409	61554 81710	43167 ⁸
	Quad Suspension; Forward of Front Axle; Exc. Lift Kit	I	G63410 ⁶	61546 ⁶	O
	Rearward of Front Axle; Exc. Lift Kit	I	G63414 ⁶	61520 ⁶ 77414 ⁶ 81490	34057 ⁸	O
78-96	Dual System Steering Stabilizer; Exc. Sway Bar	O	6802SE ⁸⁴	O
78-79	4WD Quad Suspension Forward of Front Axle Non Quad Suspension	I	G63511 ⁶	O
	Exc. Lift Kit	I	O	G63377	61519 81484	43058 ⁸ 49127 ⁷
	Quad Front Suspension, Shocks behind the front axle; Exc. Lift Kit	I	81394	O
	RWD, 4WD Quad Suspension Rearward of Front Axle, Non Quad Suspension	I	61521 ⁶ 81394	O
70-79	Single System Steering Stabilizer	O	6803SE ⁸⁴	O



6 It is recommended that when replacing shocks on vehicles with "quad shocks" all 4 shocks should be matched by series.

7 Pair Packs, Air hose kit included.
51 Strut Cushion for use with the Strut/Cartridge/Shocks.

8 Pair Packs.

84 Replacement damper for vehicles with the Gabriel Aftermarket mounting kit

APPLICATION GUIDE

Year	Fitment Notes										
		Ultra	Ready Mounts	Max Control\ LTV Severe Duty\ ProGuard\ Guardian	Strut Cushion\ Strut Mount\ Dampers\ Stabilizer	HiJackers\ Load Carrier\ Classic	Ultra	Ready Mounts	Max Control\ LTV Severe Duty\ ProGuard\ Guardian	Strut Cushion\ Strut Mount\ Dampers\ Stabilizer	HiJackers\ Load Carrier\ Classic

FORD

FORD

BRONCO (cont)

67-77	From Serial #830001; Exc. Lift Kit	○	81394	○	G63377	61519 81484	43058 ⁸ 49127 ⁷
66-77	From Serial #830001; Exc. Lift Kit RWD, 4WD Quad Suspension Rearward of Front Axle	○	34058 ⁸	○
	From Serial #830001; Exc. Lift Kit RWD, 4WD Quad Suspension Rearward of Front Axle, Non Quad Suspension	○	G63386	61521 ⁵ 81394	○
66-69	Single System Steering Stabilizer	○	6804SE ⁶⁰	○
66	From Serial #830001; Exc. Lift Kit	○	81394	○	G63377	61519 81484	43058 ⁸
	Thru Serial #830000	○	○	G63350	61518 81242	43099 ⁸ 49173 ⁷

BRONCO II

90	All	○	G63614	58929 61561 77614 81744 ⁴⁸	○	G63525	61559 77525 81730	49223 ⁷
	Single System Steering Stabilizer	○	G63614	58929 61561 77614 81744 ⁴⁸	6802SE ⁶⁴	○	G63525	61559 77525 81730	49223 ⁷
84-89	Single System Steering Stabilizer	○	6802SE ⁶⁴	○
89	Mfg. from 2/89; Vehicles w/ 12mm bolt in rear lower mount	○	77414 ⁵	○	G63525	61559 77525 81730	49223 ⁷
	Mfg. to 2/89; Vehicles w/ 10mm & 12mm bolt in rear lower mount	○	G63414 ⁶	61520 ⁵ 81490	34057 ⁸	○	61533
84-88	w/ 10mm Bolt In Rear Lower Mount	○	G63414 ⁶	61520 ⁵ 77414 ⁵ 81490	34057 ⁸	○	61533

CONTOUR

95-00	All		142843 ⁵⁴ 143061 ⁵¹	M55693	142402 ⁵³ 143058 ⁵¹
-------	-----	--	------	------	------	----------------------------------------------	------	--	------	------	--------	----------------------------------------------	------

COUNTRY SEDAN

65-74	All	○	69675 ⁵	81446	34073 ⁸	○	69606	81495	43140 ⁸ 49205 ⁷
60-64	All	○	82099	○	82076
57-59	All	○	82099	○	49105 ⁷ 82125
52-56	All	○	82026	○	49105 ⁷ 82125
50-51	All	○	82026	○	49310 ⁷ 82156

COUNTRY SQUIRE

87-91	All	○	69675 ⁵	81446	34073 ⁸	○	69606	81495	43140 ⁸ 49205 ⁷
65-74	All	○	69675 ⁵	81446	34073 ⁸	○	69606	81495	43140 ⁸ 49205 ⁷
59-64	All	○	82099	○	82076
57-58	All	○	82099	○
52-56	All	○	82026	○	49105 ⁷ 82125
50-51	All	○	82026	○	82060

5 Use kit No. 140719 to replace O.E. hardware for lower shock absorber mounting when studs break or self-tapping screws are not longer useable.

7 Pair Packs, Air hose kit included.

48 Installation Hardware Included

53 Hardware from O.E. Part may need to be reused.

80 Mounting bracket not required, install on O.E. Shock Mounts. See Ref. C for optional Steering Stabilizer Boots

6 It is recommended that when replacing shocks on vehicles with "quad shocks" all 4 shocks should be matched by series.



8 Pair Packs.

51 Strut Cushion for use with the Strut/Cartridge/Shocks.

54 Kit with Mount and Bearing. Hardware from O.E. Part may need to be reused.

84 Replacement damper for vehicles with the Gabriel Aftermarket mounting kit

APPLICATION GUIDE

Year	Fitment Notes										
		Ultra	Ready Mounts	Max Control\ LTV Severe Duty\ ProGuard\ Guardian	Strut Cushion\ Strut Mount\ Dampers\ Stabilizer	HiJackers\ Load Carrier\ Classic	Ultra	Ready Mounts	Max Control\ LTV Severe Duty\ ProGuard\ Guardian	Strut Cushion\ Strut Mount\ Dampers\ Stabilizer	HiJackers\ Load Carrier\ Classic

FORD

FORD

COURIER

72-82	All	⊖	G63421	58421 61504 81750	⊖	82125
-------	-----	---	--------	------	-------------------------	------	------	---	------	------	------	------	-------

COURIER SEDAN DELIVERY

59-60	All	⊖	82099	⊖	82076
57-58	All	⊖	82099	⊖
54-56	All	⊖	82026	⊖	49105 ⁷ 82125

CRESTLINE

52-54	All	⊖	82026	⊖	49105 ⁷ 82125
50-51	All	⊖	82026	⊖	49310 ⁷ 82156

CROWN VICTORIA

07-11	All	⊖	143357 ⁶⁸	⊖
	Exc. Police and Taxi Models	⊖	G51887	G57080 ⁴⁰	79900	143357 ⁶⁸	⊖	69575
	Police and Taxi Models	⊖	G51888	143357 ⁶⁸	⊖	69574
	Police Interceptor	⊖	79901	143357 ⁶⁸	⊖
11	Mfg. to 12/05; Exc. Police and Taxi Models	⊖	79900	143357 ⁶⁸	⊖
03-06	Police and Taxi Models	⊖	G51888	⊖	69574
	Police Interceptor	⊖	79901	⊖
06	Exc. Police and Taxi Models	⊖	G51887	G57080 ⁴⁰	79900	143357 ⁶⁸	⊖	69575
05	Exc. Police and Taxi Models	⊖	G51887	G57080 ⁴⁰	143357 ⁶⁸	⊖	69575
	Mfg. to 12/05; Exc. Police and Taxi Models	⊖	79900	⊖
	Police Interceptor, Mfg. to 12/05	⊖	79901	⊖
03-04	Exc. Police and Taxi Models	⊖	G51887	G57080 ⁴⁰	79900	143357 ⁶⁸	⊖	69575
94-02	All	⊖	69675 ⁵	⊖	69606	81495	43140 ⁸
	Exc. Hydraulic Self-Leveling System	⊖	69675 ⁵	34073 ⁸	⊖	69606	81495	43140 ⁸
	Rear Air Springs	⊖	69675 ⁵	⊖	69606	81495	49205 ⁷ 43140 ⁸
	Exc. Police and Taxi Models	⊖	69675 ⁵	81446	⊖	69606	81495	43140 ⁸
	Police and Taxi Models	⊖	G63375 ⁵	61555 77375 81713	⊖	69606	81495	43140 ⁸
93	All	⊖	69675 ⁵	⊖	69606	81495
	Exc. Hydraulic Self-Leveling System	⊖	69675 ⁵	34073 ⁸	⊖	69606	81495	43140 ⁸
	Rear Air Springs	⊖	69675 ⁵	⊖	69606	81495	49205 ⁷
	Exc. Police and Taxi Models	⊖	69675 ⁵	81446	⊖	69606	81495
	Police and Taxi Models	⊖	G63375 ⁵	61555 77375 81713 ⁵	⊖	69606	81495

5 Use kit No. 140719 to replace O.E. hardware for lower shock absorber mounting when studs break or self-tapping screws are not longer useable.





8 Pair Packs.

68 Mount Kit. Hardware from O.E. Part may need to be reused.;

7 Pair Packs, Air hose kit included.

40 Complete Assembled Unit.









APPLICATION GUIDE

Year	Fitment Notes										
		 Ultra	Ready Mounts	Max Control\ LTV Severe Duty\ ProGuard\ Guardian	Strut Cushion\ Strut Mount\ Dampers\ Stabilizer	HiJackers\ Load Carrier\ Classic	 Ultra	Ready Mounts	Max Control\ LTV Severe Duty\ ProGuard\ Guardian	Strut Cushion\ Strut Mount\ Dampers\ Stabilizer	HiJackers\ Load Carrier\ Classic













FORD

FORD







CROWN VICTORIA (cont)

92	All		69675 ⁵		69606	81495	43140 ⁶
	Exc. Hydraulic Self-Leveling System		69675 ⁵	34073 ⁸		69606	81495	43140 ⁶
	Rear Air Springs		69675 ⁵		69606	81495	49205 ⁷ 43140 ⁶
	Exc. Police and Taxi Models		69675 ⁵	81446		69606	81495	43140 ⁶



CUSTOM

67-72	All		69675 ⁵	81446	34073 ⁸		69606	81495	43140 ⁶ 49205 ⁷
65-66	All		69675 ⁵	81446	34073 ⁸ 82099		69606	81495	43140 ⁶ 49205 ⁷ 82076
64	All		82099		82076
57	All		82099		49105 ⁷ 82125
52	All		82026		49105 ⁷ 82125
50-51	All		82026		49310 ⁷ 82156



CUSTOM 300

60	All		82099		82076
59	All		82099	
58	All		82099		49105 ⁷ 82125



CUSTOM 500

68-77	All		69675 ⁵	81446	34073 ⁸		69606	81495	43140 ⁶ 49205 ⁷
-------	-----	-------------------------------------------------------------------------------------	--------------------	------	-------	------	--------------------	-------------------------------------------------------------------------------------	-------	------	-------	------	------------------------------------------







CUSTOMLINE

52-56	All		82026		49105 ⁷ 82125
-------	-----	-------------------------------------------------------------------------------------	------	------	------	------	-------	-------------------------------------------------------------------------------------	------	------	------	------	-----------------------------





DEL RIO WAGON

57-58	All		82099	
-------	-----	-------------------------------------------------------------------------------------	------	------	------	------	-------	-------------------------------------------------------------------------------------	------	------	------	------	------



DELUXE

49-51	All		82026		82156
	Direct Acting Shocks		82026		49310 ⁷ 82156
47-48	Direct Acting Shocks		82007		49310 ⁷ 82156



E-450 ECONOLINE SUPER DUTY

00-02	All		G63622	58622 77614	6828SE ⁸⁰		G63623	58623 61646 77623
	Exc. Cutaway Chassis		G63622	58622 77614	6828SE ⁸⁰		G63623	77623 58623 61646

E-550 ECONOLINE SUPER DUTY

02	All		6828SE ⁸⁰		61655
----	-----	-------------------------------------------------------------------------------------	------	------	------	----------------------	------	-------------------------------------------------------------------------------------	------	------	-------	------	------

E-550 SUPER DUTY





03	All		6828SE ⁸⁰		61655
----	-----	-------------------------------------------------------------------------------------	------	------	------	----------------------	------	-------------------------------------------------------------------------------------	------	------	-------	------	------

5 Use kit No. 140719 to replace O.E. hardware for lower shock absorber mounting when studs break or self-tapping screws are not longer useable.

7 Pair Packs, Air hose kit included.

80 Mounting bracket not required, install on O.E. Shock Mounts. See Ref. C for optional Steering Stabilizer Boots





APPLICATION GUIDE

Year	Fitment Notes										
			Ultra	Ready Mounts	Max Control\ LTV Severe Duty\ ProGuard\ Guardian	Strut Cushion\ Strut Mount\ Dampers\ Stabilizer	HiJackers\ Load Carrier\ Classic		Ultra	Ready Mounts	Max Control\ LTV Severe Duty\ ProGuard\ Guardian



FORD

FORD



ECONOLINE

00-06	All		G63622	58622		G63623	58623 61646
61-67	All		G63492	61506 81318		G63299	49311 ⁷ 82007

















ECONOLINE SUPER DUTY

96-99	All		77614	6828SE ⁸⁰		77623
-------	-----	-----------------------------------------------------------------------------------	------	------	-------	----------------------	------	-------------------------------------------------------------------------------------	------	------	-------	------	------



ECONOLINE VAN

61-67	Van All models with factory frame bracket. Kit 143168 required to install to linkage.		6802SE ⁸⁴	
-------	---------------------------------------------------------------------------------------	-----------------------------------------------------------------------------------	------	------	------	----------------------	------	-------------------------------------------------------------------------------------	------	------	------	------	------



















EDGE

15-18	Left		G57752 ⁴⁰	
	Right		G57753 ⁴⁰	
11-14	Left		G52351		G64111
	Right		G52352		G64111
07-14	FWD, Left		G57582 ⁴⁰	
	FWD, Right		G57583 ⁴⁰	
07-10	Left		G56840	143415 ⁵³		G64037
	Right		G56841	143415 ⁵³		G64037

ELITE

75-76	All		69675	81446		69606	81495	43140 ⁸ 49205 ⁷
-------	-----	-------------------------------------------------------------------------------------	-------	------	-------	------	------	---------------------------------------------------------------------------------------	-------	------	-------	------	------------------------------------------

ESCAPE

17-19	All			G511001
13-16	Left		G57517 ⁴⁰		G511001 ¹
	Right		G57518 ⁴⁰		G511001 ¹
12	Left		G56601	G57045 ⁴⁰		G511001 G64047
	Right		G56568	G57046 ⁴⁰		G511001 G64047
08-11	Left		G56601	G57045 ⁴⁰		G64047
	Right		G56568	G57046 ⁴⁰		G64047
01-07	Left		G56601	G57045 ⁴⁰		69900 G63862
	Right		G56568	G57046 ⁴⁰		69900 G63862

1 Future Part

8 Pair Packs.

53 Hardware from O.E. Part may need to be reused.

84 Replacement damper for vehicles with the Gabriel Aftermarket mounting kit





Bold Type - New / Future Part

7 Pair Packs, Air hose kit included.

40 Complete Assembled Unit.

80 Mounting bracket not required, install on O.E. Shock Mounts. See Ref. C for optional Steering Stabilizer Boots







APPLICATION GUIDE

Year	Fitment Notes										
		 Ultra	Ready Mounts	Max Control\ LTV Severe Duty\ ProGuard\ Guardian	Strut Cushion\ Strut Mount\ Dampers\ Stabilizer	HiJackers\ Load Carrier\ Classic	 Ultra	Ready Mounts	Max Control\ LTV Severe Duty\ ProGuard\ Guardian	Strut Cushion\ Strut Mount\ Dampers\ Stabilizer	HiJackers\ Load Carrier\ Classic







FORD

FORD



ESCORT

97-03	All		143061 ⁵¹		M55848
91-96	All		142854 ⁵⁴ 143057 ⁵¹		M55848	143058 ⁵¹
81-90	All		143057 ⁵¹		143059 ⁵¹



































EXCURSION

00-05	4WD		G63809	77809		G63837	77837
	4WD; With OE Unit		6854SE ⁸⁰	
	RWD		G63614	77614		G63607	77607

EXP

82-88	All		143057 ⁵¹		143059 ⁵¹
-------	-----	-----------------------------------------------------------------------------------	------	------	------	----------------------	------	-----------------------------------------------------------------------------------	------	------	------	----------------------	------

EXPEDITION

17-21	4WD		G57683⁴⁰	
	Coil (FrontSpringType); Exc. Air Suspension			G51861
17	4WD; RWD; Exc. Air Suspension			G57173 ⁴⁰	143393 ⁶⁸
15-16	4WD; RWD; Exc. Air Suspension		143424 ⁶⁸		G57173 ⁴⁰	143393 ⁶⁸
14-16	4WD		G57683⁴⁰	143424 ⁶⁸	
07-16	All		143424 ⁶⁸	
	Coil (FrontSpringType); Exc. Air Suspension		143424 ⁶⁸		G51861
14	4WD; RWD; Exc. Air Suspension		143424 ⁶⁸		G57173 ⁴⁰	143393
07-13	4WD; RWD; Exc. Air Suspension		G57172 ⁴⁰	143424 ⁶⁸		G57173 ⁴⁰	143393
	Coil (RearSpringType); Exc. Air Suspension		G51860	143424 ⁶⁸	
03-06	All			G51729	G57016 ⁴⁰	143317 ⁵³
	Exc. Adjustable Suspension		143244 ⁵³		G51729	G57016 ⁴⁰	143317 ⁵³
	4WD		G57015 ⁴⁰		G51729	G57016 ⁴⁰	143317 ⁵³
	RWD		G51719	G57212 ⁴⁰		G51729	G57016 ⁴⁰	143317 ⁵³
97-02	All			G63717	61614 77717
	4WD, Exc. Front Air- Leveling		G63716	61613 77716 81914		G63717	61614 77717
	4WD, Torsion Bar(FrontSpringType)		6861SE ⁸²		G63717	61614 77717

40 Complete Assembled Unit.

53 Hardware from O.E. Part may need to be reused.

68 Mount Kit. Hardware from O.E. Part may need to be reused.;



82 Use kit if listed, See Ref. C for optional Steering Stabilizer Boots.

51 Strut Cushion for use with the Strut/Cartridge/Shocks.

54 Kit with Mount and Bearing. Hardware from O.E. Part may need to be reused.

80 Mounting bracket not required, install on O.E. Shock Mounts. See Ref. C for optional Steering Stabilizer Boots



APPLICATION GUIDE

Year	Fitment Notes										
		Ultra	Ready Mounts	Max Control\ LTV Severe Duty\ ProGuard\ Guardian	Strut Cushion\ Strut Mount\ Dampers\ Stabilizer	HiJackers\ Load Carrier\ Classic	Ultra	Ready Mounts	Max Control\ LTV Severe Duty\ ProGuard\ Guardian	Strut Cushion\ Strut Mount\ Dampers\ Stabilizer	HiJackers\ Load Carrier\ Classic







































FORD

FORD

EXPEDITION (cont)

97-02	RWD, Exc. Front Air- Leveling		G63714	58714 61611 77714 81912		G63717	61614 77717
-------	-------------------------------	-----------------------------------------------------------------------------------	--------	------	----------------------------------	------	------	-------------------------------------------------------------------------------------	--------	------	----------------	------	------

EXPLORER

16-19	Left		G57819⁴⁰		G51980
	Right		G57820⁴⁰		G51980
14-15	FWD, Left		G57699 ⁴⁰	
	FWD, Right		G57700 ⁴⁰	
15	AWD, Left		G57697 ⁴⁰		G51980
	AWD, Right		G57698 ⁴⁰		G51980
13-14	AWD, Left		G57697 ⁴⁰		G51980	143476 ⁵³
	AWD, Right		G57698 ⁴⁰		G51980	143476 ⁵³
11-13	All			G51980	143476 ⁵³
	AWD, Left Mfg. to 9/4/12		G57691 ⁴⁰		G51980	143476 ⁵³
	AWD, Right Mfg. to 9/4/12		G57692 ⁴⁰		G51980	143476 ⁵³
	FWD; Mfg. to 9/4/12 Left		G57693 ⁴⁰		G51980	143476 ⁵³
	FWD; Mfg. to 9/4/12 Right		G57694 ⁴⁰		G51980	143476 ⁵³
13	FWD, Left		G57699 ⁴⁰		G51980	143476 ⁵³
	FWD, Right		G57700 ⁴⁰		G51980	143476 ⁵³
07-10	All		G56838	G57095 ⁴⁰	143360 ⁵³		G56839	G57096 ⁴⁰	143361 ⁵³ 143362 ²⁷
06	All		G56838	G57095 ⁴⁰	143360 ⁵³		G56839	G57096 ⁴⁰	143361 ⁵³ 143362 ⁵³
04-05	Exc. All Sport & Sport Trac Models		G51723	G57019 ⁴⁰	143318 ⁵³		G51724	G57018 ⁴⁰	143319 ⁵³
02-05	All		143318 ⁵³		143319 ⁵³
02-03	Exc. All Sport & Sport Trac Models		G51722	G57017 ⁴⁰	143318 ⁵³		G51724	G57018 ⁴⁰	143319 ⁵³
95-01	Exc. Adjustable Suspension		G63678	61623 77678 81893		G63679	61624 77679 81890	43171 ⁸ 49232 ⁷
91-94	All		G63608	58929 61591 77608 81744 ⁴⁸	34076 ⁸		G63607	61590 77607 81823
	All models with factory frame bracket. Kit 143168 required to install to linkage.		G63608	58929 61591 77608 81744 ⁴⁸	6802SE ⁸⁴	34076 ⁸		G63607	61590 77607 81823

7 Pair Packs, Air hose kit included.

40 Complete Assembled Unit.

53 Hardware from O.E. Part may need to be reused.

84 Replacement damper for vehicles with the Gabriel Aftermarket mounting kit





Bold Type - New / Future Part

8 Pair Packs.

48 Installation Hardware Included

67 Mount Kit. Hardware from O.E. Part may need to be reused.



APPLICATION GUIDE

Year	Fitment Notes										
		 Ultra	Ready Mounts	Max Control\ LTV Severe Duty\ ProGuard\ Guardian	Strut Cushion\ Strut Mount\ Dampers\ Stabilizer	Hijackers\ Load Carrier\ Classic	 Ultra	Ready Mounts	Max Control\ LTV Severe Duty\ ProGuard\ Guardian	Strut Cushion\ Strut Mount\ Dampers\ Stabilizer	Hijackers\ Load Carrier\ Classic



FORD

FORD







EXPLORER SPORT TRAC

01-05	All		G63678	...	61623 77678 81893		G63679	...	61624 77679 81890	...	43171 ⁸ 49232 ⁷
-------	-----	-----------------------------------------------------------------------------------	--------	-----	-------------------------	-----	-----	-----------------------------------------------------------------------------------	--------	-----	-------------------------	-----	------------------------------------------



F-200

86-90	All		81490	
-------	-----	-----------------------------------------------------------------------------------	-----	-----	-------	-----	-----	-----------------------------------------------------------------------------------	-----	-----	-----	-----	-----















F-250 HD

97	All			77809
	4WD		G63455	...	61614 77414 81821		G63461	...	61530 77461 81510 77809
	RWD		G63414	...	61520 81490		G63406	...	61547 81082 77809	...	43167 ⁸



F59

89-91	Single System Steering Stabilizer; Superduty Motorhome		6802SE ⁵⁴	
-------	--------------------------------------------------------	-----------------------------------------------------------------------------------	-----	-----	----------------------	-----	-----	-----------------------------------------------------------------------------------	-----	-----	-----	-----	-----















FAIRLANE

66-70	All		82126		81270	...	49105 ⁷
	Wagon; Multi-Leaf Rear Spring		82126		69606	...	81270	...	49105 ⁷
62-65	All		82075		81270	...	49105 ⁷
60-61	All		82099		82076
59	All		82099	
57-58	All		82099		81270	...	49105 ⁷
55-56	All		82026		81270	...	49105 ⁷



FAIRMONT

78-83	All		143059 ⁵¹	...		49199 ⁷
-------	-----	-------------------------------------------------------------------------------------	-----	-----	----------------------	-----	-------------------------------------------------------------------------------------	-----	-----	-----	-----	--------------------







FALCON

66-70	All		82126	
	Exc. Wagon		82126		81270
	Wagon		82126		43140 ⁸ 49205 ⁷
	Wagon; Multi-Leaf Rear Spring		82126		69606
	Exc. Wagon		82126		49105 ⁷
	Wagon		82126		81495	...
60-65	All		82126		81270	...	49105 ⁷

FESTIVA

88-93	All		G55615	143059 ⁵¹	...		143063 ⁵¹	...
-------	-----	-------------------------------------------------------------------------------------	--------	-----	-----	----------------------	-----	-------------------------------------------------------------------------------------	-----	-----	-----	----------------------	-----

FIESTA

15-19	All			70052
14	All		143399 ⁵⁴	...		70052
13	Left		G52255	143399 ⁵⁴	...		70052



7 Pair Packs, Air hose kit included.

51 Strut Cushion for use with the Strut/Cartridge/Shocks.

8 Pair Packs.

54 Kit with Mount and Bearing. Hardware from O.E. Part may need to be reused.







APPLICATION GUIDE

Year	Fitment Notes										
		Ultra	Ready Mounts	Max Control\ LTV Severe Duty\ ProGuard\ Guardian	Strut Cushion\ Strut Mount\ Dampers\ Stabilizer	HiJackers\ Load Carrier\ Classic	Ultra	Ready Mounts	Max Control\ LTV Severe Duty\ ProGuard\ Guardian	Strut Cushion\ Strut Mount\ Dampers\ Stabilizer	HiJackers\ Load Carrier\ Classic





FORD

FORD







FIESTA (cont)

13	Right		G52256	143399 ⁵⁴		70052
11-12	Left		G52255	143399 ⁵⁴		70052	143400 ⁵³
	Right		G52256	143399 ⁵⁴		70052	143400 ⁵³





































FIVE HUNDRED

05-07	FWD, Left			G51849	143390 ⁵³
	FWD, Right			G51849	143391 ⁵³

FLEX

09-19	All			G51996
09-11	Mfg. from 07/09 Left		G57495 ⁴⁰		G51996
	Mfg. from 07/09 Right		G57496 ⁴⁰		G51996

FOCUS

12-18	Exc. Sport Suspension			G511134
	Left Heavy Duty Suspension		G57726 ⁴⁰	
	Left Standard Suspension		G57724 ⁴⁰	
	Right Heavy Duty Suspension		G57727 ⁴⁰	
	Right Standard Suspension		G57725 ⁴⁰	
	w/ Sport Suspension			G511135
12-14	Exc. Heavy Duty Suspension			G511002
08-11	Left		G56836	G57081 ⁴⁰	142930 ⁵⁴		69464 ³⁷	81935 ³⁷	142992 ⁵³
	Right		G56837	G57082 ⁴⁰	142930 ⁵⁴		69464 ³⁷	81935 ³⁷	142992 ⁵³
06-07	Left		G56836	G57081 ⁴⁰	142930 ⁵⁴	
	Right		G56837	G57082 ⁴⁰	142930 ⁵⁴	
	Hatchback			69464 ³⁷	81935	142992 ⁵³
	Sedan			69464 ³⁷	81935	142992 ⁵³
00-07	Wagon			69465
00-05	Left		G56516	G57063 ⁴⁰	M56516	142930 ⁵⁴	
	Right		G56517	G57064 ⁴⁰	M56517	142930 ⁵⁴	
	Hatchback		143057 ⁵¹		69464 ³⁷	81935	142992 ⁵³
	Sedan		143057 ⁵¹		69464 ³⁷	81935	142992 ⁵³

37 Reuse or replace O.E. bumper. It is not included with this shock. Use mount kit 142992 if upper hardware needs to be replaced.



40 Complete Assembled Unit.

51 Strut Cushion for use with the Strut/Cartridge/Shocks.

53 Hardware from O.E. Part may need to be reused.

54 Kit with Mount and Bearing. Hardware from O.E. Part may need to be reused.

APPLICATION GUIDE

Year	Fitment Notes										
		Ultra	Ready Mounts	Max Control\ LTV Severe Duty\ ProGuard\ Guardian	Strut Cushion\ Strut Mount\ Dampers\ Stabilizer	HiJackers\ Load Carrier\ Classic	Ultra	Ready Mounts	Max Control\ LTV Severe Duty\ ProGuard\ Guardian	Strut Cushion\ Strut Mount\ Dampers\ Stabilizer	HiJackers\ Load Carrier\ Classic

FORD

FORD

FORD

49	All		82026	⊖	82060
----	-----	--	------	------	------	------	-------	---	------	------	------	------	-------

FREESTAR

04-07	All		G56655	143246 ⁵³	⊖	G63873
-------	-----	--	--------	------	------	----------------------	------	---	--------	------	------	------	------

FREESTYLE

05-07	Left		G52110	143341 ⁵³
	Right		G52111	143341 ⁵³

FUSION

13-20	All		G57812⁴⁰	⊖	G51965
10-12	Left		G51896	G57427 ⁴⁰
	Right		G51897	G57427 ⁴⁰
	FWD		⊖	G69591
06-09	All		G51859	G57148 ⁴⁰	⊖
	FWD		G51859	G57148 ⁴⁰	⊖	G69591

GALAXIE

65-67	All	⊖	69675 ⁵	81446	34073 ⁸	⊖	69606	81495	43140 ⁶ 49205 ⁷
60-64	All	⊖	82099	⊖	82076
59	All	⊖	82099	⊖

GALAXIE 500

68-74	All	⊖	69675 ⁵	81446	34073 ⁸	⊖	69606	81495	43140 ⁶ 49205 ⁷
64-66	All	⊖	69675 ⁵	81446	⊖	69606	81495

GRANADA

81-82	All		143059 ⁵¹	⊖	49199 ⁷
75-80	All		81491	⊖	82130

GRAND MARQUIS

03-04	All	⊖	79900
01-02	All	⊖	69675 ⁵	81446	34073 ⁸	⊖	69606	81495	43140 ⁶ 49205 ⁷

LOBO

22	4WD		G57683⁴⁰
14-21	4WD		G57683⁴⁰	⊖	G64079
14-20	RWD		⊖	G64157

5 Use kit No. 140719 to replace O.E. hardware for lower shock absorber mounting when studs break or self-tapping screws are not longer useable.

8 Pair Packs.



51 Strut Cushion for use with the Strut/Cartridge/Shocks.

7 Pair Packs, Air hose kit included.

40 Complete Assembled Unit.

53 Hardware from O.E. Part may need to be reused.





































APPLICATION GUIDE

Year	Fitment Notes										
		Ultra	Ready Mounts	Max Control\ LTV Severe Duty\ ProGuard\ Guardian	Strut Cushion\ Strut Mount\ Dampers\ Stabilizer	HiJackers\ Load Carrier\ Classic	Ultra	Ready Mounts	Max Control\ LTV Severe Duty\ ProGuard\ Guardian	Strut Cushion\ Strut Mount\ Dampers\ Stabilizer	HiJackers\ Load Carrier\ Classic











FORD

FORD



LOBO (cont)

12-13	RWD		G51865	G57132 ⁴⁰	143424 ⁶⁸		G64157
10-13	All		143424 ⁶⁸	
	4WD		G51864	143424 ⁶⁸		G64079
	4WD, Extended Cab Pickup Exc. Sport Suspension		G57103 ⁴⁰	143424 ⁶⁸	
11	RWD		G51865	G57132 ⁴⁰	143424 ⁶⁸		G64157 ¹
10	RWD		G51865	G57132 ⁴⁰	143424 ⁶⁸		G63867
09	4WD		G51864		G64079
	4WD, Extended Cab Pickup Exc. Sport Suspension		G57103 ⁴⁰	
	RWD		G51865	G57132 ⁴⁰		G63867
05-08	RWD		G51703	G57021 ⁴⁰	143248 ⁵³	
04-08	All		143248 ⁵³	
	4WD		G51704	G57020 ⁴⁰	143248 ⁵³		G63867
	RWD; Exc Lightning Model		143248 ⁵³		G63870
04	RWD		G51703	G57021 ⁴⁰	143248 ⁵³	
00-03	RWD; Exc Lightning Model			G63778	61638 81892	49237 ⁷
98-03	4WD		G63716	61613 77716 81914	6861SE ⁸²		G63715	61612 77715 81913
97-03	RWD		G63714	58714 61611 77714 81912	
97-98	RWD; Exc Lightning Model			G63778	61638 81892	49237 ⁷



LTD / COUNTRY SEDAN / COUNTRY SQUIRE / CROWN VICTORIA

87-91	All		69675 ⁵	81446	34073 ⁸		69606	81495	43140 ⁹ 49205 ⁷
85-86	Police and Taxi Models		81446	143059 ⁵¹		49199 ⁷
83-86	All		143059 ⁵¹		49199 ⁷
67-82	All		69675 ⁵	81446	34073 ⁸		69606	81495	43140 ⁹ 49205 ⁷
65-66	All		69675 ⁵	81446		69606	81495

LTD II

77-79	All		69675 ⁵	81446	34073 ⁸		69606	81495	43140 ⁹ 49205 ⁷
-------	-----	-------------------------------------------------------------------------------------	--------------------	------	-------	------	--------------------	---------------------------------------------------------------------------------------	-------	------	-------	------	------------------------------------------

MAINLINE

52-56	All		82026		81270	49105 ⁷
-------	-----	-------------------------------------------------------------------------------------	------	------	------	------	-------	---------------------------------------------------------------------------------------	------	------	-------	------	--------------------

1 Future Part

7 Pair Packs, Air hose kit included.

40 Complete Assembled Unit.

53 Hardware from O.E. Part may need to be reused.

82 Use kit if listed, See Ref. C for optional Steering Stabilizer Boots.





5 Use kit No. 140719 to replace O.E. hardware for lower shock absorber mounting when studs break or self-tapping screws are not longer useable.

8 Pair Packs.

51 Strut Cushion for use with the Strut/Cartridge/Shocks.

68 Mount Kit. Hardware from O.E. Part may need to be reused;



APPLICATION GUIDE

Year	Fitment Notes										
		 Ultra	Ready Mounts	Max Control\ LTV Severe Duty\ ProGuard\ Guardian	Strut Cushion\ Strut Mount\ Dampers\ Stabilizer	HiJackers\ Load Carrier\ Classic	 Ultra	Ready Mounts	Max Control\ LTV Severe Duty\ ProGuard\ Guardian	Strut Cushion\ Strut Mount\ Dampers\ Stabilizer	HiJackers\ Load Carrier\ Classic



FORD

FORD













































MAVERICK

70-77	All		81076		82130
-------	-----	-----------------------------------------------------------------------------------	------	------	-------	------	------	-----------------------------------------------------------------------------------	------	------	------	------	-------



MOTORHOME CHASSIS / F53

89-91	Single System Steering Stabilizer; Motorhome		6802SE ⁸⁴	
-------	----------------------------------------------	-----------------------------------------------------------------------------------	------	------	------	----------------------	------	-----------------------------------------------------------------------------------	------	------	------	------	------



MUSTANG / MUSTANG II

11-14	All		G52406	
	Convertible		G52406		69593
	Coupe		G52406		69592
05-10	All		G56817	G57271 ⁴⁰	143341 ⁵³	
	Convertible		G56817	G57271 ⁴⁰	143341 ⁵³		69593
	Coupe		G56817	G57271 ⁴⁰	143341 ⁵³		69592
94-04	Position Rear		14039 ⁸⁵	
	Base, Mach & GT Models Only		G55681		69898	81794	49234 ⁷
87-93	LX		143059 ⁵¹		49199 ⁷
84-93	Position Rear		14039 ⁸⁵ 143059 ⁵¹	
	GT		G55551	143059 ⁵¹		69755
82-93	All		143059 ⁵¹	
84-86	LX Exc. 5.0L		143059 ⁵¹		49199 ⁷
	SVO		143059 ⁵¹		69755
82-83	GT		143059 ⁵¹		69755
83	GL, GLX, L		143059 ⁵¹		49199 ⁷
82	GL, GLX, Ghia, L		143059 ⁵¹		49199 ⁷
79-81	All		143059 ⁵¹		49199 ⁷
74-77	All		82128	
71-73	All		81491		81270	49105 ⁷
67-70	All		81076		81270	49105 ⁷
65-66	All		82104		81270	49105 ⁷

PARK LANE WAGON

56	All		82026		81270
----	-----	-------------------------------------------------------------------------------------	------	------	------	------	-------	-------------------------------------------------------------------------------------	------	------	-------	------	------

PICKUP 1/2 TON, F SUPERDUTY

93-97	Mfg. from 2/93		G63692		G63409	61554 81710	43167 ⁸
-------	----------------	-------------------------------------------------------------------------------------	--------	------	------	------	------	-------------------------------------------------------------------------------------	--------	------	----------------	------	--------------------

7 Pair Packs, Air hose kit included.

40 Complete Assembled Unit.

53 Hardware from O.E. Part may need to be reused.



85 Rear Only

8 Pair Packs.

51 Strut Cushion for use with the Strut/Cartridge/Shocks.

84 Replacement damper for vehicles with the Gabriel Aftermarket mounting kit

APPLICATION GUIDE

Year	Fitment Notes										
		Ultra	Ready Mounts	Max Control\ LTV Severe Duty\ ProGuard\ Guardian	Strut Cushion\ Strut Mount\ Dampers\ Stabilizer	HiJackers\ Load Carrier\ Classic	Ultra	Ready Mounts	Max Control\ LTV Severe Duty\ ProGuard\ Guardian	Strut Cushion\ Strut Mount\ Dampers\ Stabilizer	HiJackers\ Load Carrier\ Classic

FORD

FORD

PICKUP 1/2 TON, F SUPERDUTY (cont)

88-97	All			O	G63409	61554 81710	43167 ⁸
90-92	All models with factory frame bracket. Kit 143168 required to install to linkage.	O	6802SE ⁸⁴		O	G63409	61554 81710	43167 ⁸

PICKUP 1/2 TON, F-100

80-83	All			O	43167 ⁸
	RWD	I	G63414 ⁶	61520 77414 ⁶ 81490	34057 ⁸		O	G63409	61554 81710	43167 ⁸
	Single System Steering Stabilizer	O	6802SE ⁸⁴		O	43167 ⁸
77-79	Single System Steering Stabilizer; with Twin I-Beam Axle	O	6802SE ⁸⁴		O
75-79	4WD; Dual System Steering Stabilizer; Exc. Sway Bar	O	6802SE ⁸⁴		O
	4WD; Single System Steering Stabilizer	O	6803SE ⁸⁴		O
	RWD	I	G63386		O	G63350	61518 81242	43099 ⁸ 49173 ⁷ 49173 ⁷
	RWD, 4WD Quad Suspension Rearward of Front Axle	I	61521 ⁶ 81394 ⁶	34058 ⁸		O
75-76	4WD			I	49178 ⁷
	4WD; Exc. Lift Kit			I	G63387
	RWD; Single System Steering Stabilizer; with Twin I-Beam Axle	O	6802SE ⁸⁴		O
70-74	All			I	49173 ⁷ 49178 ⁷
	Exc. Supercab			I	43099 ⁸ 49173 ⁷ 49178 ⁷
	RWD			I	G63350	61518	49173 ⁷ 49178 ⁷
	RWD, 4WD Quad Suspension Rearward of Front Axle, Non Quad Suspension	I	G63386		O	49173 ⁷ 49178 ⁷
	4WD; Exc. Lift Kit			I	G63387	49173 ⁷ 49178 ⁷
	4WD; Single System Steering Stabilizer	O	6803SE ⁸⁴		O	49173 ⁷ 49178 ⁷
	RWD			I	81242	49173 ⁷ 49178 ⁷
	RWD, 4WD Quad Suspension Rearward of Front Axle	I	61521 ⁶ 81394 ⁶	34058 ⁸		O	49173 ⁷ 49178 ⁷
RWD; Single System Steering Stabilizer with Twin I Beam Axle	O	6802SE ⁸⁴		O	49173 ⁷ 49178 ⁷	
66-69	RWD			O	G63377	49127 ⁷
	RWD, 4WD Quad Suspension Rearward of Front Axle, Non Quad Suspension	I	G63386		O
	4WD; Exc. Lift Kit			O	82147
	4WD; Single System Steering Stabilizer	O	6803SE ⁸⁴		O
	RWD			O	61519	43058 ⁸
	RWD, 4WD Quad Suspension Rearward of Front Axle	I	61521 ⁶ 81394 ⁶	34058 ⁸		O
	RWD; Single System Steering Stabilizer with Twin I Beam Axle	O	6802SE ⁸⁴		O
RWD; w/Front Coil Springs			O	81484	
65	All	O	81147		O



6 It is recommended that when replacing shocks on vehicles with "quad shocks" all 4 shocks 7 Pair Packs, Air hose kit included.

should be matched by series.

84 Replacement damper for vehicles with the Gabriel Aftermarket mounting kit

8 Pair Packs.

APPLICATION GUIDE

Year	Fitment Notes										
		Ultra	Ready Mounts	Max Control\ LTV Severe Duty\ ProGuard\ Guardian	Strut Cushion\ Strut Mount\ Dampers\ Stabilizer	HiJackers\ Load Carrier\ Classic	Ultra	Ready Mounts	Max Control\ LTV Severe Duty\ ProGuard\ Guardian	Strut Cushion\ Strut Mount\ Dampers\ Stabilizer	HiJackers\ Load Carrier\ Classic

FORD

FORD

PICKUP 1/2 TON, F-100 (cont)

65	RWD	○	○	81147	○	G63377	49127 ⁷
	RWD, 4WD Quad Suspension Rearward of Front Axle, Non Quad Suspension	○	○	G63386	81147	○
	4WD; Exc. Lift Kit	○	○	81147	○	82147
	4WD; Single System Steering Stabilizer	○	○	81147	6803SE ⁸⁴	○
	RWD	○	○	81147	○	61519	43058 ⁸
	RWD, 4WD Quad Suspension Rearward of Front Axle	○	○	61521 ⁶ 81394 ⁶ 81147	34058 ⁸	○
	RWD; Single System Steering Stabilizer with Twin I Beam Axle	○	○	81147	6802SE ⁸⁴	○
	RWD; w/Front Coil Springs	○	○	81147	○	81484
61-64	All	○	○	81147	○	G63405	61500	43048 ⁸ 49310 ⁷
	4WD; Single System Steering Stabilizer	○	○	81147	6803SE ⁸⁴	○	G63405	61500	43048 ⁸ 49310 ⁷
	RWD; Single Steering Stabilizer; with I Beam Axle	○	○	81147	6802SE ⁸⁴	○	G63405	61500	43048 ⁸ 49310 ⁷
60	All	○	○	○	81270
	4WD; Single System Steering Stabilizer	○	○	6803SE ⁸⁴	○	81270
	RWD; Single Steering Stabilizer; with I Beam Axle	○	○	6802SE ⁸⁴	○	81270
54-55	All	○	○	○	81676	
53	Exc. Heavy Duty Suspension	○	○	○	81676

PICKUP 1/2 TON, F-150

22-23	4WD Exc. Tremor	○	○	G57683⁴⁰	○
14-22	RWD	○	○	○	G64157
22	4WD	○	○	○	G64079
14-21	4WD	○	○	G57683⁴⁰	○	G64079
13	4WD	○	○	G51864	○	G64079
	4WD, Extended Cab Pickup Exc. Sport Suspension	○	○	G57103 ⁴⁰	○
	RWD	○	○	G51865	G57132 ⁴⁰	○	G64157
11-12	RWD	○	○	G51865	G57132 ⁴⁰	143424 ⁶⁸	○	G64157
10-12	All	○	○	143424 ⁶⁸	○
	4WD	○	○	G51864	143424 ⁶⁸	○	G64079
	4WD, Extended Cab Pickup Exc. Sport Suspension	○	○	G57103 ⁴⁰	143424 ⁶⁸	○
10	RWD	○	○	G51865	G57132 ⁴⁰	143424 ⁶⁸	○	G63867
09	4WD	○	○	G51864	○	G64079

6 It is recommended that when replacing shocks on vehicles with "quad shocks" all 4 shocks should be matched by series.

8 Pair Packs.



68 Mount Kit. Hardware from O.E. Part may need to be reused;

7 Pair Packs, Air hose kit included.

40 Complete Assembled Unit.

84 Replacement damper for vehicles with the Gabriel Aftermarket mounting kit

APPLICATION GUIDE

Year	Fitment Notes										
		Ultra	Ready Mounts	Max Control\ LTV Severe Duty\ ProGuard\ Guardian	Strut Cushion\ Strut Mount\ Dampers\ Stabilizer	HiJackers\ Load Carrier\ Classic	Ultra	Ready Mounts	Max Control\ LTV Severe Duty\ ProGuard\ Guardian	Strut Cushion\ Strut Mount\ Dampers\ Stabilizer	HiJackers\ Load Carrier\ Classic

FORD

FORD

PICKUP 1/2 TON, F-150 (cont)

09	4WD, Extended Cab Pickup Exc. Sport Suspension		G57103 ⁴⁰
	RWD		G51865	G57132 ⁴⁰	O	G63867
05-08	4WD		G51704	G57020 ⁴⁰	143248 ⁵³	O	G63867
	RWD		G51703	G57021 ⁴⁰	143248 ⁵³	O
	RWD; Exc Lightning Model		143248 ⁵³	O	G63870
04-08	All		143248 ⁵³	O
04	4WD		G51704	G57020 ⁴⁰	143248 ⁵³	I	G63715 G63867	61612 77715 81913
	4WD, Exc. 7000# GVW		G63716	61613 77716 81914	143248 ⁵³	I
	RWD		G51703	G57021 ⁴⁰	58714 61611 77714 81912	143248 ⁵³	I	61638 81892	49237 ⁷
	RWD; Exc Lightning Model		143248 ⁵³	I	G63778 G63870
97-03	4WD		G63716	61613 77716 81914	6861SE ⁸²	I	G63715	61612 77715 81913
	RWD		G63714	58714 61611 77714 81912	I
	RWD; Exc Lightning Model		I	G63778	61638 81892	49237 ⁷
94-96	4WD; Single System Steering Stabilizer; with Twin Traction Beam		81490	6802SE ⁸⁴	I
85-96	RWD		G63414 ⁶	61520 ⁶ 77414 ⁶ 81490	34057 ⁸	O	G63406	61547 77809 81082	43167 ⁸
80-96	All		81490	O
	4WD, Exc. Lift Kit		81490	O	G63461	61530 77461 81510
	4WD, Quad Suspension; Forward of Front Axle; Exc. Lift Kit		G63410 ⁶	61546 ⁶ 81490	O
	4WD, Rearward of Front Axle; Exc. Lift Kit		G63414 ⁶	61520 ⁶ 77414 ⁶ 81490	34057 ⁸	O
90-93	Single System Steering Stabilizer		81490	6802SE ⁸⁴	I
80-89	All models with factory frame bracket. Kit 143168 required to install to linkage.		81490	6802SE ⁸⁴	I
80-84	RWD		G63414 ⁶	61520 ⁶ 77414 ⁶ 81490	34057 ⁸	O	G63409	61554 81710	43167 ⁸
77-79	Dual System Steering Stabilizer; Exc. Sway Bar		6802SE ⁸⁴	I
76-79	4WD		I	49178 ⁷
	Single System Steering Stabilizer		6803SE ⁸⁴	O
75-79	4WD; Exc. Lift Kit		I	G63387



6 It is recommended that when replacing shocks on vehicles with "quad shocks" all 4 shocks should be matched by series. 7 Pair Packs, Air hose kit included.

8 Pair Packs. 40 Complete Assembled Unit.

53 Hardware from O.E. Part may need to be reused. 82 Use kit if listed, See Ref. C for optional Steering Stabilizer Boots.

84 Replacement damper for vehicles with the Gabriel Aftermarket mounting kit

APPLICATION GUIDE

Year	Fitment Notes										
		Ultra	Ready Mounts	Max Control\ LTV Severe Duty\ ProGuard\ Guardian	Strut Cushion\ Strut Mount\ Dampers\ Stabilizer	HiJackers\ Load Carrier\ Classic	Ultra	Ready Mounts	Max Control\ LTV Severe Duty\ ProGuard\ Guardian	Strut Cushion\ Strut Mount\ Dampers\ Stabilizer	HiJackers\ Load Carrier\ Classic

FORD

FORD

PICKUP 1/2 TON, F-150 (cont)

75-79	RWD		O	G63350	61518 81242	49173 ⁷
	RWD, RWD, 4WD Quad Suspension Rearward of Front Axle, Non Quad Suspension		O	G63386
	RWD, 4WD Quad Suspension Rearward of Front Axle		O	61521 ⁶ 81394 ⁶	34058 ⁸
	RWD, Standard Cab Pickup		O	43099 ⁸
79	Custom, Ranger, Ranger Lariat, 4WD, Quad Suspension Forward of Front Axle Non Quad Suspension		O	G63511 ⁶
78	Base, Custom, Northland, Ranger, Ranger Lariat, 4WD, Quad Suspension Forward of Front Axle Non Quad Suspension		O	G63511 ⁶
75-76	RWD, All models with factory frame bracket. Kit 143168 required to install to linkage.		O	6802SE ⁸⁴
75	4WD		O	49178 ⁷
	4WD		O	6803SE ⁸⁴

PICKUP 3/4 TON, F-250 / SUPERDUTY

17-22	4WD		O	14072
14-16	RWD		O	58807
13-16	4WD		O	G63886	61680 77951	14072
12-16	RWD, w/ Off Road Package		O	G63886	61682
11-16	RWD, Exc. Off Road		O	G63622	61713
13	RWD		O	58807 77807
11-12	RWD		O	58807 77807
08-12	4WD		O	G63886	61680 77951	14072
05-10	RWD		O	G63622	58807 77807	6828SE ⁸⁰
	RWD, Exc. Off Road		O	61713
05-07	4WD		O	G63886	61680 77951	61682
	4WD, Exc. OE Unit		O	6856SE ⁸⁶
99-04	4WD		O	G63809	58809 61655 77809	58810 61656 77810
	4WD, Exc. OE Unit		O	6850SE ⁸⁶
	4WD; Replacement Kit		O	6855SE ⁸²
	RWD		O	G63622	58807 77807	6828SE ⁸⁰
99-03	4WD; With OE Unit		O	6854SE ⁸⁰
97-99	4WD, Up through 8500# GVW		O	G63716	61613 77716 81914	61612 77715 81913
	4WD, Torsion Bar(FrontSpringType)		O	6861SE ⁸²

6 It is recommended that when replacing shocks on vehicles with "quad shocks" all 4 shocks should be matched by series.

8 Pair Packs.

82 Use kit if listed, See Ref. C for optional Steering Stabilizer Boots.



86 Exc. OE Unit

7 Pair Packs, Air hose kit included.

80 Mounting bracket not required, install on O.E. Shock Mounts. See Ref. C for optional Steering Stabilizer Boots

84 Replacement damper for vehicles with the Gabriel Aftermarket mounting kit

APPLICATION GUIDE

Year	Fitment Notes										
		Ultra	Ready Mounts	Max Control\ LTV Severe Duty\ ProGuard\ Guardian	Strut Cushion\ Strut Mount\ Dampers\ Stabilizer	HiJackers\ Load Carrier\ Classic	Ultra	Ready Mounts	Max Control\ LTV Severe Duty\ ProGuard\ Guardian	Strut Cushion\ Strut Mount\ Dampers\ Stabilizer	HiJackers\ Load Carrier\ Classic

FORD

FORD

PICKUP 3/4 TON, F-250 / SUPERDUTY (cont)

97-99	RWD, Up through 8500# GVW	I O	G63714	58714 61611 77714 81912	I O	G63778	61638 81892	49237 ⁷
98	4WD, Over 8500# GVW	O O	G63455	61614 77455	I O	G63461	61530 77461 81510
97	4WD, Over 8500# GVW	O O	G63455	61614 77455 81821	O O	G63461	61530 77461 81510
	RWD	O O	G63414	61520 ⁶ 77414 ⁶ 81490	6828SE ⁸⁰	O O	G63406	61547 77809 81082	43167 ⁸
	RWD, Over 8500# GVW	I O	G63414	61520 ⁶ 77414 ⁶ 81490	6828SE ⁸⁰	O O	G63406	61547 77809 81082	43167 ⁸
92-96	RWD	I O	G63414	61520 ⁶ 77414 ⁶ 81490	6828SE ⁸⁰	O O	G63406	61547 77809 81082	43167 ⁸
87-96	4WD	O O	G63455	61614 77455 81821	O O	G63461	61530 77461 81510
80-96	4WD; Single System Steering Stabilizer	O O	G63455	6802SE ⁸⁴	I O	G63461	61530 77461 81510
96	RWD, Up through 8500# GVW	I O	G63414	58714 61611 77714	I O	G63406	61547 77809 81082	43167 ⁸
80-91	RWD	I O	G63414	61520 ⁶ 77414 ⁶ 81490	O O	G63406	61547 77809 81082	43167 ⁸
86	4WD	O O	G63461	O O	G63461	81510
	4WD, Clevis Type Lower Front Mount; Exc. Dual Rear Wheels or Lift Kit	O O	G63461	O O	G63461	61530 77461
82-85	4WD, Clevis Type Lower Front Mount; Exc. Dual Rear Wheels or Lift Kit	O O	G63461	O O	G63461	61530 77461 81510
80-82	4WD, Standard Cab Pickup	I O	G63410	I O	G63410
82	4WD	I O	G63410	61546 ⁶	I O	G63410
80-81	4WD	I O	G63410	61546 ⁶	O O	G63461	61530 77461 81510
77-79	4WD; Standard Cab, Cab & Chassis; All From Serial No. Y20001	I O	G63387	I O	G63387	49178 ⁷
75-79	RWD	I O	G63386	I O	G63386
	RWD, Cab & Chassis	I O	G63350	I O	G63350	81242	43058 ⁸ 49127 ⁷
	RWD, Extended Cab Pickup	O O	G63377	O O	G63377	61519 81484	43058 ⁸ 49127 ⁷
	RWD, Standard Cab Pickup	I O	G63350	I O	G63350	81242	43099 ⁸ 49173 ⁷
	RWD; Exc. Extended & Crew Cab	I O	G63386	I O	G63386	61518
70-79	RWD, 4WD Quad Suspension Rearward of Front Axle	I O	G63386	61521 ⁶ 81394 ⁶	34058 ⁸	I O	G63386
78	4WD, Up through Serial No. Y20000	I I	G63386	I I	G63386	82034
75-77	4WD; Up through Serial No. Y20000	I I	G63386	O O	G63386	82147
	Single System Steering Stabilizer	O O	G63386	6803SE ⁸⁴	I O	G63386
71-74	RWD; Exc. Extended Cab & Chassis Cab	I O	G63386	I O	G63386	49173 ⁷

6 It is recommended that when replacing shocks on vehicles with "quad shocks" all 4 shocks should be matched by series.



8 Pair Packs.

84 Replacement damper for vehicles with the Gabriel Aftermarket mounting kit

7 Pair Packs, Air hose kit included.

80 Mounting bracket not required, install on O.E. Shock Mounts. See Ref. C for optional Steering Stabilizer Boots

APPLICATION GUIDE

Year	Fitment Notes										
		Ultra	Ready Mounts	Max Control\ LTV Severe Duty\ ProGuard\ Guardian	Strut Cushion\ Strut Mount\ Dampers\ Stabilizer	HiJackers\ Load Carrier\ Classic	Ultra	Ready Mounts	Max Control\ LTV Severe Duty\ ProGuard\ Guardian	Strut Cushion\ Strut Mount\ Dampers\ Stabilizer	HiJackers\ Load Carrier\ Classic

FORD

FORD

PICKUP 3/4 TON, F-250 / SUPERDUTY (cont)

70-74	RWD; Exc. Supercab						⊖			81242		
	RWD; Standard Cab Pickup						⊖					43099 ⁸
68-74	4WD; Up through Serial No. Y2000						⊖					82147
65-74	Exc. Supercab						⊖	G63350				
	RWD						⊖			61518		
	RWD, 4WD Quad Suspension Rearward of Front Axle, Non Quad Suspension	⊖	G63386									
	RWD; Supercab						⊖	G63377				
	Single System Steering Stabilizer	⊖				6803SE ⁸⁴						
	RWD						⊖					43058 ⁸
	RWD; Supercab						⊖			61519 81484		
74	4WD, Up through Serial No. Y20000	⊖										82034
68-73	4WD; Up through Serial No. Y20000	⊖										82034
65-69	Supercab						⊖					49127 ⁷
	RWD, 4WD Quad Suspension Rearward of Front Axle	⊖			61521 ⁸ 81394 ⁸							
66-67	4WD; Up through Serial No. Y2000	⊖					⊖					82147
65	4WD	⊖										82034
61-64	All	⊖			81147		⊖	G63405		61500		43048 ⁸
	4WD	⊖			81147		⊖	G63405		61500		43048 ⁸
	Single System Steering Stabilizer	⊖			81147	6803SE ⁸⁴	⊖	G63405		61500		43048 ⁸
60	All	⊖					⊖			81270		
	Single System Steering Stabilizer	⊖				6803SE ⁸⁴	⊖			81270		
53-55	All						⊖			81676		



PICKUP 1 TON, F-350 / SUPERDUTY

17-22	4WD	⊖				14072						
13-16	All	⊖			58807							
	4WD	⊖			61680 77951 58807	14072		⊖	G63888		77952	
	4WD, Exc. Off Road	⊖	G63886		58807							
	4WD, w/ Off Road Package	⊖			58807			⊖			61682	
	RWD	⊖	G63622		58807			⊖	G64010			
	RWD, Exc. Off Road	⊖			58807			⊖			61713	
11-12	RWD	⊖	G63622		58807 77807			⊖	G64010			
08-12	4WD	⊖	G63886		61680 77951	14072						
05-12	4WD; Single Rear Wheels; Exc. Cab & Chassis							⊖	G63888		61682 77952	
	RWD, Exc. Off Road							⊖			61713	

6 It is recommended that when replacing shocks on vehicles with "quad shocks" all 4 shocks should be matched by series.

7 Pair Packs, Air hose kit included.
84 Replacement damper for vehicles with the Gabriel Aftermarket mounting kit

APPLICATION GUIDE

Year	Fitment Notes										
		Ultra	Ready Mounts	Max Control\ LTV Severe Duty\ ProGuard\ Guardian	Strut Cushion\ Strut Mount\ Dampers\ Stabilizer	HiJackers\ Load Carrier\ Classic	Ultra	Ready Mounts	Max Control\ LTV Severe Duty\ ProGuard\ Guardian	Strut Cushion\ Strut Mount\ Dampers\ Stabilizer	HiJackers\ Load Carrier\ Classic

FORD

FORD

PICKUP 1 TON, F-350 / SUPERDUTY (cont)

05-10	RWD	I O	G63622	58807 77807	6828SE ⁸⁰	O O	G64010
05-07	4WD	I O	G63886	61680 77951
99-04	4WD	O O	G63809	58809 61655 77809	O O	G63810	58810 61656 77810
	4WD, Exc. OE Unit	O O	6850SE ⁸⁶
	4WD; Replacement Kit	O O	6855SE ⁸²
	RWD	I O	G63622	58807 77807	6828SE ⁸⁰	O O	G63808	58808 61654 77808
99-03	4WD; With OE Unit	O O	6854SE ⁸⁰
92-97	RWD	I O	G63414	61520 ⁶ 77414 ⁶ 81490	6828SE ⁸⁰
86-97	4WD	O O	G63455	61614 77455 81821
	4WD, Dual Rear Wheels		O O	G63461	61530 77461 81510
	4WD, Exc. Dual Rear Wheels		O O	G63456
80-97	RWD, Dual Rear Wheels		O O	G63409	61554 81710
	RWD, Exc. Dual Rear Wheels		O O	G63406	61547 77809 81082	43167 ⁸
92-96	RWD; Dual System Steering Stabilizer	O O	6802SE ⁸⁴
89-91	RWD; Single System Steering Stabilizer	O O	6802SE ⁸⁴
80-91	RWD	I O	G63414	61520 ⁶ 77414 ⁶ 81490
82-88	RWD; Single System Steering Stabilizer; w/o Anti-Sway Bar	O O	6802SE ⁸⁴
82-85	4WD, Clevis Type Lower Front Mount; Exc. Dual Rear Wheels or Lift Kit		O O	G63461	61530 77461 81510
80-81	4WD	I O	G63410	61546 ⁶	O O	G63461	61530 77461 81510
79-81	RWD; Dual System Steering Stabilizer	O O	6802SE ⁸⁴
75-79	RWD, RWD, 4WD Quad Suspension Rearward of Front Axle, Non Quad Suspension	I O	G63386
	RWD, Cab & Chassis		I O	43099 ⁸ 49173 ⁷
	RWD, Extended Cab Pickup		I O	G63350	61518	43099 ⁸ 49173 ⁷
	RWD, Standard Cab Pickup		O O	G63377	61519 81484	43058 ⁸
	RWD; Supercab		I O	81242
73-79	RWD, 4WD Quad Suspension Rearward of Front Axle	I O	61521 ⁶ 81394 ⁶	34058 ⁸	
	RWD; Standard Cab Pickup		O O	49127 ⁷
79	4WD		I O	G63387	49178 ⁷
75-78	Dual System Steering Stabilizer	O O	6802SE ⁸⁴

6 It is recommended that when replacing shocks on vehicles with "quad shocks" all 4 shocks should be matched by series.

8 Pair Packs.

82 Use kit if listed, See Ref. C for optional Steering Stabilizer Boots.



86 Exc. OE Unit

7 Pair Packs, Air hose kit included.

80 Mounting bracket not required, install on O.E. Shock Mounts. See Ref. C for optional Steering Stabilizer Boots

84 Replacement damper for vehicles with the Gabriel Aftermarket mounting kit

APPLICATION GUIDE

Year	Fitment Notes										
		Ultra	Ready Mounts	Max Control\ LTV Severe Duty\ ProGuard\ Guardian	Strut Cushion\ Strut Mount\ Dampers\ Stabilizer	HiJackers\ Load Carrier\ Classic	Ultra	Ready Mounts	Max Control\ LTV Severe Duty\ ProGuard\ Guardian	Strut Cushion\ Strut Mount\ Dampers\ Stabilizer	HiJackers\ Load Carrier\ Classic

FORD

FORD

PICKUP 1 TON, F-350 / SUPERDUTY (cont)

75-77	Single System Steering Stabilizer	○	6803SE ⁸⁴	
73-74	RWD; Supercab	○	G63377	
	RWD; Exc. Supercab	○	61519 81484	
	RWD; Supercab	○	43058 ⁸	
67-74	Extended Cab	○	G63350	
	RWD, 4WD Quad Suspension Rearward of Front Axle, Non Quad Suspension	○	G63386	
	Single System Steering Stabilizer	○	6803SE ⁸⁴	
	RWD, Extended Cab	○	61518	
	Single System Steering Stabilizer; w/ Twin I Beam Axle	○	6802SE ⁸⁴	
74	RWD, Extended Cab & Chassis Cab	○	49173 ⁷	
	RWD, Supercab	○	43099 ⁸	
67-72	RWD, 4WD Quad Suspension Rearward of Front Axle	○	61521 ⁶ 81394 ⁶	
65-66	Single System Steering Stabilizer; w/ Twin I Beam Axle	○	81147	6802SE ⁸⁴	G63405	61500	43048 ⁸
61-66	All	○	81147	G63405	61500	43048 ⁸
	Single System Steering Stabilizer	○	81147	6803SE ⁸⁴	G63405	61500	43048 ⁸
61-64	Single System Steering Stabilizer w/ I Beam Axle All models with factory frame bracket. Kit 143168 required to install to linkage.	○	81147	6802SE ⁸⁴	G63405	61500	43048 ⁸
60	All	○	81270
	Single System Steering Stabilizer	○	6803SE ⁸⁴	81270
	Single System Steering Stabilizer w/ I Beam Axle All models with factory frame bracket. Kit 143168 required to install to linkage.	○	6802SE ⁸⁴	81270
53-55	All	○	81676	

PICKUP P100

65-67	Single System Steering Stabilizer	○	6802SE ⁸⁴
-------	-----------------------------------	---	-------	-------	-------	----------------------	-------	-------	-------	-------	-------	-------

PICKUP P350

76	Up through 8000# GVW	○	G63405	61500	43048 ⁸
68-75	Up through 8000# GVW	○	G63405	61500 81147	43048 ⁸
68-73	Single System Steering Stabilizer	○	6802SE ⁸⁴

PICKUP P400

75-76	Up through 8000# GVW	○	G63405	61500 81147	43048 ⁸
-------	----------------------	---	--------	-------	-------	----------------	-------	--------------------	-------	-------	-------	-------



PICKUP, F-450 SUPERDUTY

21-22	4 X 4	○	14072
17-20	All	○	77967
	4 X 4	○	77967	14072
13-16	All	○	77967	77968

6 It is recommended that when replacing shocks on vehicles with "quad shocks" all 4 shocks should be matched by series.

7 Pair Packs, Air hose kit included.
84 Replacement damper for vehicles with the Gabriel Aftermarket mounting kit

APPLICATION GUIDE

Year	Fitment Notes										
		Ultra	Ready Mounts	Max Control\ LTV Severe Duty\ ProGuard\ Guardian	Strut Cushion\ Strut Mount\ Dampers\ Stabilizer	HiJackers\ Load Carrier\ Classic	Ultra	Ready Mounts	Max Control\ LTV Severe Duty\ ProGuard\ Guardian	Strut Cushion\ Strut Mount\ Dampers\ Stabilizer	HiJackers\ Load Carrier\ Classic

FORD

FORD

PICKUP, F-450 SUPERDUTY (cont)

13-16	4 X 4	I	77967	14072	O	77969	77968
09-12	All	O	58944	I
	4 X 4	O	58944	14072	I
07-08	All	I	G63969	58944	77967	O
08	4 X 4	O	G63969	58944	77967	14072	I
07	4 X 2	O	G63969	58944	77967	O	77968
	4 X 4	O	G63969	58944	77967	O	77969
05-06	All	O	G63969	77967	O
	4 X 2	O	G63969	77967	O	77968
	4 X 4	O	G63969	77967	O	77969
99-04	All	O	G63809	58809	61655	77809	O	77461
	4 X 4	O	G63809	58809	61655	77809	6854SE ⁸⁰	O	77461
97	All	O	G63692	O	G63409	61554	43167 ⁸

PICKUP, F-550 SUPERDUTY

21-22	4 X 4	O	14072	I
17-20	All	O	77967	I
	4 X 4	O	77967	14072	I
13-16	All	O	77967	O	77968
	4 X 4	O	77967	14072	O	77969	77968
10-12	All	O	58944	I
	4 X 4	O	58944	14072	I
08-09	4 X 4	O	14072	I
05-07	All	O	G63969	77967	O
	4 X 2	O	G63969	77967	O	77968
	4 X 4	O	G63969	77967	O	77969
99-04	All	O	G63809	58809	61655	77809	O	77461
	4 X 4	O	G63809	58809	61655	77809	6854SE ⁸⁰	O	77461

PINTO

74-80	Exc. Wagon & Hatchback	O	82128	I	82004
71-73	Sedan	O	82128	I	82004

POLICE INTERCEPTOR SEDAN

16-19	Left	I	G57744⁴⁰	I	70096
-------	------	---	------	----------------------------	------	------	------	---	-------	------	------	------	------	------





8 Pair Packs.

40 Complete Assembled Unit.

80 Mounting bracket not required, install on O.E. Shock Mounts. See Ref. C for optional Steering Stabilizer Boots

Bold Type - New / Future Part







APPLICATION GUIDE

Year	Fitment Notes										
		 Ultra	Ready Mounts	Max Control\ LTV Severe Duty\ ProGuard\ Guardian	Strut Cushion\ Strut Mount\ Dampers\ Stabilizer	Hijackers\ Load Carrier\ Classic	 Ultra	Ready Mounts	Max Control\ LTV Severe Duty\ ProGuard\ Guardian	Strut Cushion\ Strut Mount\ Dampers\ Stabilizer	Hijackers\ Load Carrier\ Classic



FORD

FORD













POLICE INTERCEPTOR SEDAN (cont)

16-19	Right		G57745⁴⁰		70096
13-15	Left		G57744⁴⁰	
	Right		G57745⁴⁰	











POLICE INTERCEPTOR UTILITY

16-19	Left		G57819⁴⁰		G51980
	Right		G57820⁴⁰		G51980
13-15	All			G51980









PROBE

93-97	All		142856 ⁵⁴		143057 ⁵¹
	Left		142856 ⁵⁴		142403 ⁵³ 143057 ⁵¹
	Right		142856 ⁵⁴		142404 ⁵³ 143057 ⁵¹
90-92	GT, Automatic		G55600 ⁹	142569 ⁶¹ 142852 ⁵⁴ 143057 ⁵¹		142196 ⁵³
89-92	All		G55600 ⁹	142852 ⁵⁴ 143057 ⁵¹		142196 ⁵³
89	GT		G55600 ⁹	142569 ⁶¹ 142852 ⁵⁴ 143057 ⁵¹		142196 ⁵³





RANCH WAGON

65-74	All		69675 ⁵	81446	34073 ⁸ 82126		69606	81495	43140 ⁸ 49205 ⁷
59-64	All		82099		82076
57-58	All		82099	
52-56	All		82026		81270	49105 ⁷
50-51	All		82026		82060

RANCHERO

72-79	All		81446	34073 ⁸		69606	81495	43140 ⁸ 49205 ⁷
66-71	All		82126		69606	81495
60-65	All		82126		81270	49105 ⁷
59	All		82099		82076

RANGER

07-11	RWD, Coil(FrontSpringType)		G63772	61626 77772 81916		G63773	61627 77525 81917	43167 ⁸
06-11	RWD, Torsion Bar(FrontSpringType)			G63775	61629 77524 81918

5 Use kit No. 140719 to replace O.E. hardware for lower shock absorber mounting when studs break or self-tapping screws are not longer useable.

8 Pair Packs.

40 Complete Assembled Unit.

53 Hardware from O.E. Part may need to be reused.

61 Mount Kit includes Upper Spring Seat. Hardware from O.E. Part may need to be reused.



7 Pair Packs, Air hose kit included.

9 See Ref. D for procedures to replace Elec Adj Susp with non-adj product.

51 Strut Cushion for use with the Strut/Cartridge/Shocks.

54 Kit with Mount and Bearing. Hardware from O.E. Part may need to be reused.

APPLICATION GUIDE

Year	Fitment Notes										
		Ultra	Ready Mounts	Max Control\ LTV Severe Duty\ ProGuard\ Guardian	Strut Cushion\ Strut Mount\ Dampers\ Stabilizer	HiJackers\ Load Carrier\ Classic	Ultra	Ready Mounts	Max Control\ LTV Severe Duty\ ProGuard\ Guardian	Strut Cushion\ Strut Mount\ Dampers\ Stabilizer	HiJackers\ Load Carrier\ Classic

FORD

FORD

RANGER (cont)

98-11	4WD			G63775	61629 77524 81918	
	Torsion Bar(FrontSpringType)	⊖	G63678	61623 77678 81893	
06	RWD, Coil(FrontSpringType)	⊖	G63772	61626 77772 81916	⊖	G63773	61627 77525 81917	43167 ⁸ 49223 ⁷
01-05	RWD, Exc. Edge, EV, Splash & Sport Models			⊖	G63773	61627 77525 81917	43167 ⁸ 49223 ⁷
	RWD; Coil (FrontSpringType); Exc. Sport, STX & Tremor models w/Torsion Bar	⊖	G63772	61626 77772 81916	
98-05	RWD, Torsion Bar(FrontSpringType)			⊖	G63775	
98-00	RWD, Exc. Edge, EV, Splash & Sport Models	⊖	G63772	61626 77772 81916	⊖	G63773	61627 77525 81917	43167 ⁸ 49223 ⁷
90-97	All	⊖	G63614	58929 61561 77614 81744 ⁴⁸	34076 ⁸		
	All models with factory frame bracket. Kit 143168 required to install to linkage.	⊖	G63614	58929 61561 77614 81744 ⁴⁸	6802SE ⁸⁴	34076 ⁸		
	4WD	⊖	G63614	58929 61561 77614 81744 ⁴⁸	34076 ⁸	⊖	G63524	61573 77524 81905
	RWD	⊖	G63614	58929 61561 77614 81744 ⁴⁸	34076 ⁸	⊖	G63525	61559 77525 81730	43167 ⁸ 49223 ⁷
87-89	All models with factory frame bracket. Kit 143168 required to install to linkage.	⊖	6802SE ⁸⁴	
	Exc. High Ryder Option	⊖	G63414	61520 ⁶ 77414 ⁶ 81490	34057 ⁸		
89	4WD		⊖	G63524	81540
	4WD, High Ryder Option		⊖	61573
	4WD, Mfg. from 2/89; Vehicles w/ 12mm bolt in rear lower mount		⊖	77524 81905
	RWD, Mfg. from 2/89; Vehicles w/ 12mm bolt in rear lower mount		⊖	G63525	61559 77525 81730	49223 ⁷
	RWD, Mfg. to 2/89; Vehicles w/ 10mm bolt in rear lower mount		⊖	61533
87-88	4WD		⊖	81540
	RWD		⊖	61533
83-86	All	⊖	G63414	61520 ⁶ 77414 ⁶ 81490	34057 ⁸		
	All models with factory frame bracket. Kit 143168 required to install to linkage.	⊖	G63414	61520 ⁶ 77414 ⁶ 81490	6802SE ⁸⁴	34057 ⁸		
	4WD	⊖	G63414	61520 ⁶ 77414 ⁶ 81490	34057 ⁸	⊖	81540
	RWD	⊖	G63414	61520 ⁶ 77414 ⁶ 81490	34057 ⁸	⊖	61533





6 It is recommended that when replacing shocks on vehicles with "quad shocks" all 4 shocks should be matched by series. 7 Pair Packs, Air hose kit included.

8 Pair Packs.

48 Installation Hardware Included

84 Replacement damper for vehicles with the Gabriel Aftermarket mounting kit







APPLICATION GUIDE

Year	Fitment Notes										
		 Ultra	Ready Mounts	Max Control\ LTV Severe Duty\ ProGuard\ Guardian	Strut Cushion\ Strut Mount\ Dampers\ Stabilizer	HiJackers\ Load Carrier\ Classic	 Ultra	Ready Mounts	Max Control\ LTV Severe Duty\ ProGuard\ Guardian	Strut Cushion\ Strut Mount\ Dampers\ Stabilizer	HiJackers\ Load Carrier\ Classic



FORD

FORD









SKYLINER

59	All		82099		82076
57-58	All		82099	
54-56	All		82026		81270	49105 ⁷





STARLINER

60	All		82099		82076
----	-----	-----------------------------------------------------------------------------------	------	------	------	------	-------	-----------------------------------------------------------------------------------	------	------	------	------	-------



































SUNLINER

60	All		82099		82076
59	All		82099	
57-58	All		82099		81270	49105 ⁷
52-56	All		82026		81270	49105 ⁷

SUPER DELUXE

47-48	All			49310 ⁷
	Direct Acting Shocks		82007		82156 49310 ⁷

TAURUS



18-19	All			70096
	Left		G57746 ⁴⁰		70096
	Left Police Interceptor		G57744⁴⁰		70096
	Right		G57747 ⁴⁰		70096
	Right Police Interceptor		G57745⁴⁰		70096
15-17	Left		G57746 ⁴⁰	
	Left Police Interceptor		G57744⁴⁰	
	Right		G57747 ⁴⁰	
	Right Police Interceptor		G57745⁴⁰	
	w/ Suspension Code A and B; Exc. SHO Models			70096
13-14	Left		G57746 ⁴⁰		143476 ⁵³
	Left Police Interceptor		G57744⁴⁰		143476 ⁵³
	Right		G57747 ⁴⁰		143476 ⁵³
	Right Police Interceptor		G57745⁴⁰		143476 ⁵³
10-14	All			143476 ⁵³
	w/ Suspension Code A and B; Exc. SHO Models			70096	143476 ⁵³
10-12	Left		G57497 ⁴⁰		143476 ⁵³

7 Pair Packs, Air hose kit included.

53 Hardware from O.E. Part may need to be reused.

40 Complete Assembled Unit.

APPLICATION GUIDE

Year	Fitment Notes										
		Ultra	Ready Mounts	Max Control\ LTV Severe Duty\ ProGuard\ Guardian	Strut Cushion\ Strut Mount\ Dampers\ Stabilizer	HiJackers\ Load Carrier\ Classic	Ultra	Ready Mounts	Max Control\ LTV Severe Duty\ ProGuard\ Guardian	Strut Cushion\ Strut Mount\ Dampers\ Stabilizer	HiJackers\ Load Carrier\ Classic

FORD

FORD

TAURUS (cont)

10-12	Left w/ Suspension Code A and B	G52398	143476 ⁵³
	Right	G57498 ⁴⁰	143476 ⁵³
	Right w/ Suspension Code A and B	G52399	143476 ⁵³
09	FWD, Left	G52129	G57497 ⁴⁰	G57449 ⁴⁰
	FWD, Right	G52130	G57498 ⁴⁰	G57450 ⁴⁰
08	FWD, Left	G52129	143415 ⁵³	G57449 ⁴⁰
	FWD, Right	G52130	143415 ⁵³	G57450 ⁴⁰
96-07	Left	G56934 ⁴⁰	142747 ⁵¹ 142845 ⁵⁴ 143059 ⁵¹
	Right	G56937 ⁴⁰	142747 ⁵¹ 142845 ⁵⁴ 143059 ⁵¹
	Sedan	G55901	G56936 ⁴⁰	M55901	143057 ⁵¹
96-05	Wagon	69962	81927
94-95	All	142746 ⁵⁷ 143059 ⁵¹
	Sedan	142746 ⁵⁷ 143059 ⁵¹	G55901	G56936 ⁴⁰	M55901	143057 ⁵¹
86-93	All	142746 ⁵⁷
	Sedan	142746 ⁵⁷	143059 ⁵¹
	Wagon	143059 ⁵¹ 142746 ⁵⁷

TAURUS X

09	Left	G57359 ⁴⁰
	Right	G57360 ⁴⁰
08	Left	G57359 ⁴⁰	143415 ⁵³
	Right	G57360 ⁴⁰	143415 ⁵³

TEMPO

86-94	All	142745 ⁵³ 143059 ⁵¹
84-85	All	143057 ⁵¹	142745 ⁵³ 143059 ⁵¹

THUNDERBIRD

92-97	Exc. Electronic Adjustable Suspension	G55579	69845
89-91	Exc. Electronic Adjustable Suspension	G55579
87-88	Position Rear	14039 ⁸⁵

40 Complete Assembled Unit.

53 Hardware from O.E. Part may need to be reused.

61 Mount Kit includes Upper Spring Seat. Hardware from O.E. Part may need to be reused.

67 Mount Kit. Hardware from O.E. Part may need to be reused.





51 Strut Cushion for use with the Strut/Cartridge/Shocks.

54 Kit with Mount and Bearing. Hardware from O.E. Part may need to be reused.

63 Mount Kit includes Isolator. Hardware from O.E. Part may need to be reused.

85 Rear Only

















APPLICATION GUIDE

Year	Fitment Notes										
		 Ultra	Ready Mounts	Max Control\ LTV Severe Duty\ ProGuard\ Guardian	Strut Cushion\ Strut Mount\ Dampers\ Stabilizer	Hijackers\ Load Carrier\ Classic	 Ultra	Ready Mounts	Max Control\ LTV Severe Duty\ ProGuard\ Guardian	Strut Cushion\ Strut Mount\ Dampers\ Stabilizer	Hijackers\ Load Carrier\ Classic











FORD

FORD



THUNDERBIRD (cont)

87-88	Non-ABS		143059 ⁵¹	
84-86	Position Rear		14039 ⁸⁵ 143059 ⁵¹	
80-86	All		143059 ⁵¹	
77-79	All		69675 ⁵	81446	34073 ⁸		69606	81495	43140 ⁸ 49205 ⁷
73-76	All		69675 ⁵	81446	34073 ⁸	
67-72	All		69675 ⁵	81446	34073 ⁸		69606	81495	43140 ⁸ 49205 ⁷
59-60	All		82099	
55-57	All		82026		81270	49105 ⁷



TORINO

74-76	Wagon		69675 ⁵	81446	34073 ⁸		69606	81495	43140 ⁸ 49205 ⁷
72-76	All		69675 ⁵	81446	34073 ⁸		69606	43140 ⁸ 49205 ⁷
68-71	All		82126		69606	49105 ⁷
71	Wagon		82126		69606	81495	49105 ⁷
68-70	Exc. Wagon		82126		69606	81270	49105 ⁷



TRANSIT

07-10	All			G64063
-------	-----	-------------------------------------------------------------------------------------	------	------	------	------	------	-------------------------------------------------------------------------------------	--------	------	------	------	------



TRANSIT CONNECT

10-13	All		143564 ⁸⁸	
-------	-----	-------------------------------------------------------------------------------------	------	------	------	----------------------	------	-------------------------------------------------------------------------------------	------	------	------	------	------



TRANSIT-150

15-22	All		G57816¹⁰		G64177
-------	-----	-------------------------------------------------------------------------------------	------	----------------------------	------	------	------	-------------------------------------------------------------------------------------	--------	------	------	------	------







TRANSIT-250

15-22	All		G57816¹⁰		G64177
-------	-----	-------------------------------------------------------------------------------------	------	----------------------------	------	------	------	-------------------------------------------------------------------------------------	--------	------	------	------	------

TRANSIT-350

15-22	All		G57816¹⁰		G64177
-------	-----	-------------------------------------------------------------------------------------	------	----------------------------	------	------	------	-------------------------------------------------------------------------------------	--------	------	------	------	------

VAN 1/2 TON, ECONOLINE / CLUB WAGON

12-14	All		G63622	81744 ⁴⁸	34076 ⁸		G63623	58623 61646 77623 81828	49178 ⁷
10-11	All		G63622	58929 61591 77608 81744 ⁴⁸	34076 ⁸		G63623	58623 61595 77623 81828	49178 ⁷
08-09	All		G63622	58929 61591 77608 81744 ⁴⁸	34076 ⁸		G63623	61595	49178 ⁷

5 Use kit No. 140719 to replace O.E. hardware for lower shock absorber mounting when studs break or self-tapping screws are not longer useable.

8 Pair Packs.

48 Installation Hardware Included

68 Mount Kit. Hardware from O.E. Part may need to be reused.;



7 Pair Packs, Air hose kit included.

40 Complete Assembled Unit.

51 Strut Cushion for use with the Strut/Cartridge/Shocks.

85 Rear Only









APPLICATION GUIDE

Year	Fitment Notes										
		Ultra	Ready Mounts	Max Control\ LTV Severe Duty\ ProGuard\ Guardian	Strut Cushion\ Strut Mount\ Dampers\ Stabilizer	HiJackers\ Load Carrier\ Classic	Ultra	Ready Mounts	Max Control\ LTV Severe Duty\ ProGuard\ Guardian	Strut Cushion\ Strut Mount\ Dampers\ Stabilizer	HiJackers\ Load Carrier\ Classic























FORD

FORD













VAN 1/2 TON, ECONOLINE / CLUB WAGON (cont)

92-07	All		G63929	58929 61591 77608 81744 ⁴⁸	34076 ⁸		G63624	61595 81833	49178 ⁷
75-91	All		81694		G63350	61518 81242	43099 ⁸ 49173 ⁷
69-74	All		82012		G63377	61519 81484	43058 ⁸ 49127 ⁷
	Single System Steering Stabilizer; with Twin I-Beam Axle		6802SE ⁸⁴	82012		G63377	61519 81484	43058 ⁸ 49127 ⁷

VAN 3/4 TON, ECONOLINE / CLUB WAGON / SUPERDUTY

05-14	All		G63622	58622 77614 81744 ⁴⁸	34076 ⁸		G63623	58623 61646 77623 81828	49178 ⁷
03-04	All		G63622	58622 77614 81744 ⁴⁸	6828SE ⁸⁰	34076 ⁸		G63623	58623 61646 77623 81828	49178 ⁷
96-02	All		G63622	58622 61591 77614 81744 ⁴⁸	6828SE ⁸⁰	34076 ⁸		G63623	58623 61646 77623 81828	49178 ⁷
92-95	All		G63622	58622 61591 77614 81744 ⁴⁸	34076 ⁸		G63623	58623 61646 77623 81828	49178 ⁷
75-91	All		81394		G63387	49178 ⁷
	RWD, 4WD Quad Suspension Rearward of Front Axle		81394	34058 ⁸		G63387	49178 ⁷
	RWD, 4WD Quad Suspension Rearward of Front Axle, Non Quad Suspension		G63386	61521 ⁶ 81394		G63387	49178 ⁷
75-79	QuadraVan Special		81394	6803SE ⁸⁴		G63387	49178 ⁷
69-74	All		82012		G63377	61519 81484	43058 ⁸ 49127 ⁷
	Single System Steering Stabilizer; with Twin I-Beam Axle		6802SE ⁸⁴	82012		G63377	61519 81484	43058 ⁸ 49127 ⁷
74	QuadraVan Special		6803SE ⁸⁴	82012		G63377	61519 81484	43058 ⁸ 49127 ⁷

VAN 1 TON, ECONOLINE / CLUB WAGON / SUPERDUTY

21-22	All		G63622	58622 77614 81744	6828SE ⁸⁰		G63623	58623 61646 77623 81828	49178 ⁷
15-19	All		G63622	58622 77614 81744	6828SE ⁸⁰	34076 ⁸		G63623	58623 61646 81828	49178 ⁷
	Exc. Cutaway Chassis		G63622	77614 58622 81744	6828SE ⁸⁰	34076 ⁸		G63623	58623 77623 81828 61646	49178 ⁷
13-14	All		G63622	58622 77614 81744 81744 ⁴⁸	6828SE ⁸⁰	34076 ⁸		G63623	58623 61646 81828	49178 ⁷
	Exc. Cutaway Chassis		G63622	77614 58622 81744 81744 ⁴⁸	6828SE ⁸⁰	34076 ⁸		G63623	58623 77623 81828 61646	49178 ⁷
12	All		G63622	58622 77614 81744 ⁴⁸	6828SE ⁸⁰	34076 ⁸		G63623	58623 61646 81828	49178 ⁷

6 It is recommended that when replacing shocks on vehicles with "quad shocks" all 4 shocks should be matched by series. 7 Pair Packs, Air hose kit included.



48 Installation Hardware Included

8 Pair Packs.

84 Replacement damper for vehicles with the Gabriel Aftermarket mounting kit

80 Mounting bracket not required, install on O.E. Shock Mounts. See Ref. C for optional Steering Stabilizer Boots











































APPLICATION GUIDE

Year	Fitment Notes										
		Ultra	Ready Mounts	Max Control\ LTV Severe Duty\ ProGuard\ Guardian	Strut Cushion\ Strut Mount\ Dampers\ Stabilizer	HiJackers\ Load Carrier\ Classic	Ultra	Ready Mounts	Max Control\ LTV Severe Duty\ ProGuard\ Guardian	Strut Cushion\ Strut Mount\ Dampers\ Stabilizer	HiJackers\ Load Carrier\ Classic

FORD

FORD

VAN 1 TON, ECONOLINE / CLUB WAGON / SUPERDUTY (cont)

12	Exc. Cutaway Chassis		G63622	77614 58622 81744 ⁴⁸	6828SE ⁸⁰	34076 ⁸		G63623	58623 77623 81828 61646	49178 ⁷
10-11	All		G63622	58622 61591 77614 81744 ⁴⁸	6828SE ⁸⁰	34076 ⁸		G63623	58623 61646 81828	49178 ⁷
08-11	Exc. Cutaway Chassis		G63622	58622 77614 61591 81744 ⁴⁸	6828SE ⁸⁰	34076 ⁸		G63623	58623 61646 77623 81828	49178 ⁷
09	All		G63622	58622 61591 77614 81744 ⁴⁸	6828SE ⁸⁰	34076 ⁸		G63623	58623 61646	49178 ⁷
07-08	All		G63622	58622 61591 77614 81744 ⁴⁸	6828SE ⁸⁰	34076 ⁸		G63623	58623 61646 77623	49178 ⁷
	Cutaway Chassis		G63622	58622 61591 77614 81744 ⁴⁸	6828SE ⁸⁰	34076 ⁸		G63623	58623 61646 77623	49178 ⁷
07	Exc. Cutaway Chassis		G63622	58622 77614 61591 81744 ⁴⁸	6828SE ⁸⁰	34076 ⁸		G63623	58623 61646 77623 81828	49178 ⁷
04-06	Exc. Cutaway Chassis		G63622	58622 61591 77614 81744 ⁴⁸	6828SE ⁸⁰	34076 ⁸		G63623	58623 61646 77623 81828	49178 ⁷
06	All		G63622	58622 61591 77614 81744 ⁴⁸	6828SE ⁸⁰	34076 ⁸		G63623	58623 61646	49178 ⁷
04-05	All		G63622	58622 61591 77614 81744 ⁴⁸	6828SE ⁸⁰	34076 ⁸		G63623	58623 61646 81828	49178 ⁷
92-05	Cutaway Chassis		G63622	58622 77614 61591 81744 ⁴⁸	6828SE ⁸⁰	34076 ⁸		G63623	58623 77623 61646 81828	49178 ⁷
99-03	All		G63622	58622 61591 77614 81744 ⁴⁸	6828SE ⁸⁰	34076 ⁸		G63623	58623 61646 77623 81828	49178 ⁷
03	Exc. Cutaway Chassis		G63622	58622 61591 77614 81744 ⁴⁸	6828SE ⁸⁰	34076 ⁸		G63623	77623 58623 61646 81828	49178 ⁷
92-98	All		61591 81744 ⁴⁸	6828SE ⁸⁰	34076 ⁸		61646 81828	49178 ⁷
77-91	All			49178 ⁷
	Cutaway Chassis			G63387	49178 ⁷
	Cutaway Chassis RWD, 4WD Quad Suspension Rearward of Front Axle, Non Quad Suspension		G63386		49178 ⁷
	Exc. Cutaway Chassis RWD, 4WD Quad Suspension Rearward of Front Axle		34058 ⁸		49178 ⁷
	Exc. Cutaway Chassis RWD, 4WD Quad Suspension Rearward of Front Axle, Non Quad Suspension		61521 ⁶ 81394		49178 ⁷
	RWD, 4WD Quad Suspension Rearward of Front Axle		34058 ⁸		49178 ⁷
75-91	Exc. Cutaway Chassis		81394		49178 ⁷

6 It is recommended that when replacing shocks on vehicles with "quad shocks" all 4 shocks should be matched by series.



7 Pair Packs, Air hose kit included.

8 Pair Packs.

48 Installation Hardware Included

80 Mounting bracket not required, install on O.E. Shock Mounts. See Ref. C for

APPLICATION GUIDE

Year	Fitment Notes										
		Ultra	Ready Mounts	Max Control\ LTV Severe Duty\ ProGuard\ Guardian	Strut Cushion\ Strut Mount\ Dampers\ Stabilizer	HiJackers\ Load Carrier\ Classic	Ultra	Ready Mounts	Max Control\ LTV Severe Duty\ ProGuard\ Guardian	Strut Cushion\ Strut Mount\ Dampers\ Stabilizer	HiJackers\ Load Carrier\ Classic

FORD

FORD

VAN 1 TON, ECONOLINE / CLUB WAGON / SUPERDUTY (cont)

75-76	Cutaway Chassis			G63387	
	Cutaway Chassis RWD, 4WD Quad Suspension Rearward of Front Axle, Non Quad Suspension	IO	G63386	
	Exc. Cutaway Chassis RWD, 4WD Quad Suspension Rearward of Front Axle	IO	34058 ⁸	
	Exc. Cutaway Chassis RWD, 4WD Quad Suspension Rearward of Front Axle, Non Quad Suspension	IO	61521 ⁶ 81394	
69-74	All	OO	82012	OO	G63377	61519 81484	43058 ⁸ 49127 ⁷

VICTORIA

60	All	IO	82099	IO	82076
59	All	IO	82099	IO
57-58	All	IO	82099	IO	81270	49105 ⁷
52-56	All	IO	82026	IO	81270	49105 ⁷
51	All	IO	82026	OO	49310 ⁷ 82156

WINDSTAR

95-03	All		G56935 ⁴⁰	143059 ⁵¹
	Coil(RearSpringType)		G56935 ⁴⁰	143059 ⁵¹	OO	G63676	61625 81882

FREIGHTLINER

FREIGHTLINER

SPRINTER 2500

07-18	All		G57802⁴⁰
02-06	All		G56778	OO	G63918

SPRINTER 3500

07-18	All		G57802⁴⁰
-------	-----	--	------	----------------------------	------	------	------	--	------	------	------	------	------

GEO

GEO

METRO

89-97	Non-ABS		143059 ⁵¹		G55772	143057 ⁵¹
-------	---------	--	------	------	------	------	----------------------	------	--	--------	------	------	----------------------	------

PRIZM

93-97	Left		G55999	143059 ⁵¹ 143281 ⁵³		G55661	G56949 ⁴⁰	143058 ⁵¹
	Right		G55999	143059 ⁵¹ 143281 ⁵³		G55662	G56950 ⁴⁰	143058 ⁵¹
89-92	All		G55591	143059 ⁵¹ 143281 ⁵³	143061 ⁵¹

SPECTRUM

89	All		143058 ⁵¹
----	-----	--	------	------	------	------	----------------------	------	--	------	------	------	------	------



6 It is recommended that when replacing shocks on vehicles with "quad shocks" all 4 shocks should be matched by series. 7 Pair Packs, Air hose kit included.

8 Pair Packs. 40 Complete Assembled Unit.

51 Strut Cushion for use with the Strut/Cartridge/Shocks. 53 Hardware from O.E. Part may need to be reused.

Bold Type - New / Future Part

APPLICATION GUIDE

Year	Fitment Notes										
		Ultra	Ready Mounts	Max Control\ LTV Severe Duty\ ProGuard\ Guardian	Strut Cushion\ Strut Mount\ Dampers\ Stabilizer	HiJackers\ Load Carrier\ Classic	Ultra	Ready Mounts	Max Control\ LTV Severe Duty\ ProGuard\ Guardian	Strut Cushion\ Strut Mount\ Dampers\ Stabilizer	HiJackers\ Load Carrier\ Classic

GEO

GEO

STORM

90-93	Non-ABS	↓	142317 ⁵³ 143058 ⁵¹	↓	143061 ⁵¹
-------	---------	---	------	------	------	----------------------------------------------	------	---	------	------	------	----------------------	------

TRACKER

89-97	All	↓	↓	G63799	61560 81904
	Non-ABS	↓	G56518	↓	G63799	61560 81904

GMC

GMC

ACADIA

17	All	↓	G57709 ⁴⁰	↓
13-16	All	↓	G57709 ⁴⁰	↓	G64040
07-12	All	↓	G52125	143366 ⁵³	↓	G64040
	AWD	↓	G52125	G57109 ⁴⁰	143366 ⁵³	↓	G64040
07-11	FWD	↓	G52125	G57314 ⁴⁰	143366 ⁵³	↓	G64040

ACADIA LIMITED

17	All	↓	↓	G64040
----	-----	---	------	------	------	------	------	---	--------	------	------	------	------

C3500HD

01-02	Solid Front Axle	↓	↓	61543
91-02	HD Solid Front Axle	↓	↓	58488

CANYON

23	Exc. ZR2	↓	G57748⁴⁰	↓
22	Exc. ZR2 Package	↓	↓	G63866
15-21	Exc. ZR2	↓	↓	G63866
15-20	Exc. ZR2	↓	G57748⁴⁰	↓
12	RWD	↓	↓	77422	43162 ⁸ 49213 ⁷
	RWD, Coil(FrontSpringType) D Standard Suspension; Exc. Z71 Off Road Package	↓	↓	G63882
	Torsion Bar(FrontSpringType)	↓	↓	G63879
09-11	Torsion Bar(FrontSpringType)	↓	G57282 ⁴⁰	↓	G63879
04-11	All	↓	G57282 ⁴⁰	↓
	RWD	↓	G57282 ⁴⁰	↓	77422	43162 ⁸ 49213 ⁷
	RWD, Coil(FrontSpringType) D Standard Suspension; Exc. Z71 Off Road Package	↓	G57282 ⁴⁰	↓	G63882
	RWD, Coil(FrontSpringType) Exc. Z71 Off Road Package	↓	G51850	G57282 ⁴⁰	↓
04-08	Torsion Bar(FrontSpringType)	↓	G63884	G57282 ⁴⁰	↓	G63879

7 Pair Packs, Air hose kit included.



40 Complete Assembled Unit.

53 Hardware from O.E. Part may need to be reused.

8 Pair Packs.

51 Strut Cushion for use with the Strut/Cartridge/Shocks.







APPLICATION GUIDE

Year	Fitment Notes										
		Ultra	Ready Mounts	Max Control\ LTV Severe Duty\ ProGuard\ Guardian	Strut Cushion\ Strut Mount\ Dampers\ Stabilizer	HiJackers\ Load Carrier\ Classic	Ultra	Ready Mounts	Max Control\ LTV Severe Duty\ ProGuard\ Guardian	Strut Cushion\ Strut Mount\ Dampers\ Stabilizer	HiJackers\ Load Carrier\ Classic



GMC

GMC



ENVOY

02-09	All		G51718 ⁴⁵	G57022 ⁴⁰	143241 ⁵³		61717
	Coil(RearSpringType)		G51718 ⁴⁵	G57022 ⁴⁰	143241 ⁵³		G63842	77971 61717
03-06	Air(RearSpringType)		G51718 ⁴⁵	G57022 ⁴⁰	143241 ⁵³		G64014	61717







































ENVOY XL

02-06	All		G51718 ⁴⁵		77971
-------	-----	-----------------------------------------------------------------------------------	----------------------	------	------	------	------	-------------------------------------------------------------------------------------	------	------	-------	------	------

ENVOY XUV

04-05	All		G51718 ⁴⁵		77971
-------	-----	-----------------------------------------------------------------------------------	----------------------	------	------	------	------	-------------------------------------------------------------------------------------	------	------	-------	------	------

JIMMY

05	4WD		G63423	58423 ⁶⁰ 61531 77423 81516	142316 ⁵³		G63422	58422 61528 77422 81482	43162 ⁸ 49213 ⁷
92-04	All		142316 ⁵³		G63422	58422 61528 77422 81482	43162 ⁸ 49213 ⁷
	4WD		G63423	58423 ⁶⁰ 61531 77423 81516	142316 ⁵³		G63422	58422 61528 77422 81482	43162 ⁸ 49213 ⁷
	RWD		G63421	58421 61504 81750	142316 ⁵³	34051 ⁸		G63422	58422 61528 77422 81482
87-91	Exc. Lift Kit			G63349	61524 81164	43111 ⁸
	Exc. Quad Suspension and Lift Kit			49155 ⁷
75-91	4WD; Quad Suspension Long Shock; Exc. Lift Kit		61522 ⁶ 81496 ⁶	
73-91	Replacement damper for vehicles w/ OE stabilizer		14017	
	Heavy Duty replacement damper for vehicles with OE stabilizer		6804SE ⁸⁰	
	Replacement Kit		6802SE ⁸⁴	
70-91	4WD; Exc. Lift Kit		G63347 ⁵⁰	
	4WD; Exc. Quad Suspension and Lift Kit		61516 81113 ⁶	
73-86	Exc. Lift Kit			G63349	61524 81164	43111 ⁸ 49155 ⁷
73-84	RWD		G63355	61525 81039	34036 ⁸	
73-74	4WD; Quad Suspension Long Shock; Exc. Lift Kit		61522 ⁶	
70-72	Coil(RearSpringType)			49107 ⁷
	4WD; K5 Dual System Steering Stabilizer		6802SE ⁸⁴	
	4WD; K5 Single System Steering Stabilizer		6803SE ⁸⁴	
	RWD		G63355	61525 81039	34036 ⁸		G63306	49162 ⁷ 82003

6 It is recommended that when replacing shocks on vehicles with "quad shocks" all 4 shocks should be matched by series.

8 Pair Packs.

45 Strut must be rotated to align notch with lower control arm.

53 Hardware from O.E. Part may need to be reused.

84 Replacement damper for vehicles with the Gabriel Aftermarket mounting kit

7 Pair Packs, Air hose kit included.

40 Complete Assembled Unit.

50 Bellows Kit No.141242 is recommended for use to protect piston rod from potentially harmful road debris.

80 Mounting bracket not required, install on O.E. Shock Mounts. See Ref. C for optional Steering Stabilizer Boots

APPLICATION GUIDE

Year	Fitment Notes										
		Ultra	Ready Mounts	Max Control\ LTV Severe Duty\ ProGuard\ Guardian	Strut Cushion\ Strut Mount\ Dampers\ Stabilizer	HiJackers\ Load Carrier\ Classic	Ultra	Ready Mounts	Max Control\ LTV Severe Duty\ ProGuard\ Guardian	Strut Cushion\ Strut Mount\ Dampers\ Stabilizer	HiJackers\ Load Carrier\ Classic

GMC

GMC

PICKUP

55-59	All		82047	
	Series 100, 150		82047		82060
	Single System Steering Stabilizer; with Beam Axle		6802SE ⁸⁴	82047	
53-54	All		81270
	1/2 and 3/4 Ton		81270	43140 ⁸ 82155
	Single System Steering Stabilizer; with Beam Axle		81270	6802SE ⁸⁴

PICKUP 1/2 TON, C15 / C1500

88-99	All		G63489	58489 61544 77489 81668	34073 ⁸		G63488	58488 61543 77488 81667	43163 ⁸ 49218 ⁷
73-86	All		G63355	61525 81039	34036 ⁸		G63349	61524 81164	43111 ⁸ 49155 ⁷
	Single System Steering Stabilizer		G63355	61525 81039	6802SE ⁸⁴	34036 ⁸		G63349	61524 81164	43111 ⁸ 49155 ⁷
68-72	RWD; Leaf(RearSpringType)		G63355	61525 81039	34036 ⁸		G63306
67-72	All		G63355	61525 81039	34036 ⁸	
	Coil(RearSpringType)		G63355	61525 81039	34036 ⁸		49107 ⁷ 82003
	Leaf(RearSpringType)		G63355	61525 81039	34036 ⁸		49162 ⁷
67	Leaf(RearSpringType)		G63355	61525 81039	34036 ⁸		G63306

PICKUP 1/2 TON, K15 / K1500

88-99	All		G63818	58901 77609		G63488	58488 ⁸⁰ 61543 77488 81667	43163 ⁸ 49218 ⁷
81-86	Quad Suspension Long Shock; Exc. Lift Kit		61522 ⁸ 81496 ⁸	14017
79-86	Exc. Lift Kit		14017		G63349	61524 81164	43111 ⁸
	Exc. Quad Suspension and Lift Kit		G63347	61516 81113 ⁸	14017	49155 ⁷
73-86	All		14017
	Dual System Steering Stabilizer		6802SE ⁸⁴ 14017
	Single System Steering Stabilizer		6804SE ⁸⁰ 14017
78	Exc. Lift Kit		14017		G63349	61524 81164
	Exc. Quad Suspension and Lift Kit		G63347	61516 81113 ⁸	14017	43111 ⁸ 49155 ⁷
75-77	Exc. Lift Kit		14017		G63349	61524 81164	43111 ⁸
73-77	Exc. Quad Suspension and Lift Kit		G63347	61516 81113 ⁸	14017	49155 ⁷
73-74	Exc. Lift Kit		14017		G63349	61524 81164
69-72	Exc. Quad Suspension and Lift Kit		G63347	61516 81113 ⁸
	Dual System Steering Stabilizer		6802SE ⁸⁴
	Single System Steering Stabilizer		6803SE ⁸⁴

6 It is recommended that when replacing shocks on vehicles with "quad shocks" all 4 shocks should be matched by series.

8 Pair Packs.



80 Mounting bracket not required, install on O.E. Shock Mounts. See Ref. C for

7 Pair Packs, Air hose kit included.

50 Bellows Kit No.141242 is recommended for use to protect piston rod from potentially harmful road debris.

84 Replacement damper for vehicles with the Gabriel Aftermarket mounting kit

APPLICATION GUIDE

Year	Fitment Notes										
		Ultra	Ready Mounts	Max Control\ LTV Severe Duty\ ProGuard\ Guardian	Strut Cushion\ Strut Mount\ Dampers\ Stabilizer	HiJackers\ Load Carrier\ Classic	Ultra	Ready Mounts	Max Control\ LTV Severe Duty\ ProGuard\ Guardian	Strut Cushion\ Strut Mount\ Dampers\ Stabilizer	HiJackers\ Load Carrier\ Classic

GMC

GMC

PICKUP 1/2 TON, R1500

87	All	○	G63355	61525 81039	34036 ⁸	○	G63349	61524 81164	43111 ⁸ 49155 ⁷
	Single System Steering Stabilizer	○	G63355	61525 81039	6802SE ⁸⁴	34036 ⁸	○	G63349	61524 81164	43111 ⁸ 49155 ⁷

PICKUP 1/2 TON, V1500

87	All	○	14017	○
	Exc. Lift Kit	○	G63347	14017	○	G63349	61524 81164	43111 ⁸
	Quad Suspension Long Shock; Exc. Lift Kit	○	61522 ⁶ 81496 ⁶	14017	○
	Quad Suspension Short Shock; Exc. Lift Kit	○	61516 81113 ⁶	14017	○
	Quad Suspension; Exc. Lift Kit	○	14017	○	49155 ⁷
	Dual System Steering Stabilizer	○	6802SE ⁸⁴ 14017	○
	Single System Steering Stabilizer	○	6804SE ⁸⁰ 14017	○

PICKUP 3/4 TON, C25 / C2500

88-00	All	○	G63489	58489 61544 77489 81668	34073 ⁸	○	G63488	58488 61543 77488 81667	43163 ⁸ 49218 ⁷
85-86	Crew Cab Pickup	○	81039	○	G63366	81164
83-86	All	○	81039	○	81164
	Cab & Chassis	○	81039	○	G63349	61524 81164	43111 ⁸ 49155 ⁷
	Exc. Extended Cab	○	G63355	61525 81039	34036 ⁸	○	81164
	Single System Steering Stabilizer	○	81039	6802SE ⁸⁴	○	81164
	Standard Cab Pickup	○	81039	○	G63349	61524 81164	43111 ⁸ 49155 ⁷
83	Crew Cab Pickup	○	81039	○	G63366	81164
79-82	Cab & Chassis	○	○	G63349	61524 81164	43111 ⁸ 49155 ⁷
	Exc. Extended Cab	○	G63355	61525 81039	34036 ⁸	○
	Standard Cab Pickup	○	○	G63349	61524 81164	43111 ⁸ 49155 ⁷
75-82	Crew Cab Pickup	○	○	G63366
	Single System Steering Stabilizer	○	6802SE ⁸⁴	○
75-78	Cab & Chassis	○	○	81164	49155 ⁷
	Exc. Extended Cab	○	G63355	61525 81039	34036 ⁸	○	G63349	61524	43111 ⁸
	Standard Cab Pickup	○	○	81164	49155 ⁷
73-74	All	○	G63355	61525 81039	34036 ⁸	○	43111 ⁸ 49155 ⁷
	Crew Cab Pickup	○	G63355	61525 81039	34036 ⁸	○	G63366	43111 ⁸ 49155 ⁷
	Exc. Crew Cab & Bonus Cab	○	G63355	61525 81039	34036 ⁸	○	G63349	61524	43111 ⁸ 49155 ⁷
	Single System Steering Stabilizer	○	G63355	61525 81039	6802SE ⁸⁴	34036 ⁸	○	43111 ⁸ 49155 ⁷
67-72	Leaf(RearSpringType)	○	G63355	61525 81039	34036 ⁸	○	G63306	49162 ⁷

6 It is recommended that when replacing shocks on vehicles with "quad shocks" all 4 shocks should be matched by series.



8 Pair Packs.

84 Replacement damper for vehicles with the Gabriel Aftermarket mounting kit

7 Pair Packs, Air hose kit included.

80 Mounting bracket not required, install on O.E. Shock Mounts. See Ref. C for optional Steering Stabilizer Boots

APPLICATION GUIDE

Year	Fitment Notes										
		Ultra	Ready Mounts	Max Control\ LTV Severe Duty\ ProGuard\ Guardian	Strut Cushion\ Strut Mount\ Dampers\ Stabilizer	HiJackers\ Load Carrier\ Classic	Ultra	Ready Mounts	Max Control\ LTV Severe Duty\ ProGuard\ Guardian	Strut Cushion\ Strut Mount\ Dampers\ Stabilizer	HiJackers\ Load Carrier\ Classic

GMC

GMC

PICKUP 3/4 TON, C25 / C2500 (cont)

72	All	○	G63355	61525 81039	34036 ⁸	○
	Coil(RearSpringType)	○	G63355	61525 81039	34036 ⁸	○	49107 ⁷ 82003
	Single System Steering Stabilizer	○	G63355	61525 81039	6802SE ⁸⁴	34036 ⁸	○
71	All	○	G63355	61525 81039	34036 ⁸	○	G63306
	Coil(RearSpringType)	○	G63355	61525 81039	34036 ⁸	○	G63306	49107 ⁷ 82003
	Single System Steering Stabilizer	○	G63355	61525 81039	6802SE ⁸⁴	34036 ⁸	○	G63306
67-70	All	○	G63355	61525 81039	34036 ⁸	○
	Coil(RearSpringType)	○	G63355	61525 81039	34036 ⁸	○	49107 ⁷ 82003
	Single System Steering Stabilizer	○	G63355	61525 81039	6802SE ⁸⁴	34036 ⁸	○

PICKUP 3/4 TON, K25 / K2500

99-00	9200# GVW with OE Unit - 15059138 15155638	○	G63609	58609 61542 77609 81726	6853SE ⁸²	○	G63488	58488 61543 77488 81667	43163 ⁸ 49218 ⁷
88-00	All	○	G63609	58609 61542 77609 81726	○	G63488	58488 61543 77488 81667	43163 ⁸ 49218 ⁷
81-86	Quad Suspension Long Shock; Exc. Lift Kit	○	61522 ⁵ 81496 ⁵	14017	○
73-86	All	○	14017	○
	Exc. Lift Kit	○	14017	○	G63349	61524 81164	43111 ⁸
	Exc. Quad Suspension and Lift Kit	○	G63347	61516 81113 ⁵	14017	○	49155 ⁷
	Dual System Steering Stabilizer	○	6802SE ⁸⁴ 14017	○
	Single System Steering Stabilizer	○	6804SE ⁸⁰ 14017	○
69-72	Exc. Quad Suspension and Lift Kit	○	G63347	61516 81113 ⁵	○
67-72	Dual System Steering Stabilizer	○	6802SE ⁸⁴	○
	Single System Steering Stabilizer	○	6803SE ⁸⁴	○

PICKUP 3/4 TON, R2500

87-89	Crew Cab Pickup	○	○	G63366
	Exc. Crew Cab & Bonus Cab	○	G63355	61525 81039	34036 ⁸	○	G63349	61524 81164	43111 ⁸ 49155 ⁷
	Single System Steering Stabilizer	○	6802SE ⁸⁴	○

PICKUP 3/4 TON, V2500

87	All	○	14017	○
	Exc. Lift Kit	○	G63347	14017	○	G63349	61524 81164	43111 ⁸ 49155 ⁷
	Quad Suspension Long Shock; Exc. Lift Kit	○	61522 ⁵ 81496 ⁵	14017	○
	Quad Suspension Short Shock; Exc. Lift Kit	○	61516 81113 ⁵	14017	○
	AN49	○	6802SE ⁸⁴ 14017	○

6 It is recommended that when replacing shocks on vehicles with "quad shocks" all 4 shocks should be matched by series.



8 Pair Packs.

7 Pair Packs, Air hose kit included.

80 Mounting bracket not required, install on O.E. Shock Mounts. See Ref. C for optional Steering Stabilizer Boots

84 Replacement damper for vehicles with the Gabriel Aftermarket mounting kit

APPLICATION GUIDE

Year	Fitment Notes										
		Ultra	Ready Mounts	Max Control\ LTV Severe Duty\ ProGuard\ Guardian	Strut Cushion\ Strut Mount\ Dampers\ Stabilizer	HiJackers\ Load Carrier\ Classic	Ultra	Ready Mounts	Max Control\ LTV Severe Duty\ ProGuard\ Guardian	Strut Cushion\ Strut Mount\ Dampers\ Stabilizer	HiJackers\ Load Carrier\ Classic

GMC

GMC

PICKUP 3/4 TON, V2500 (cont)

87	Single System Steering Stabilizer	○	6804SE ⁸⁰ 14017
----	-----------------------------------	---	------	------	------	-------------------------------	------	------	------	------	------

PICKUP 1 TON, C35/3500

99-00	Exc. HD Straight Front Axle	⊖	34073 ⁸	⊖	77488	49218 ⁷
92-00	Exc. HD Straight Front Axle	⊖	81668	34073 ⁸	⊖	77488
	Crew Cab Pickup Exc. HD Straight Front Axle	⊖	G63489	58489 61544 77489	34073 ⁸	⊖	G63488	77488
91-00	All	⊖	34073 ⁸	⊖	77488
	Extended Cab Pickup Exc. HD Straight Front Axle	⊖	G63489	58489 61544 77489	34073 ⁸	⊖	G63488	81667 77488
	Standard Cab Pickup Exc. HD Straight Front Axle	⊖	G63489	58489 61544 77489	34073 ⁸	⊖	G63488	81667 77488
00	HD Solid Front Axle	⊖	34073 ⁸	⊖	61543 77488	43163 ⁸
91-99	HD Solid Front Axle	⊖	34073 ⁸	⊖	58488 61543 77488	43163 ⁸
92-98	Cab & Chassis Exc. HD Straight Front Axle	⊖	34073 ⁸	⊖	77488	49218 ⁷
91	Exc. HD Straight Front Axle	⊖	81668	34073 ⁸	⊖	77488	49218 ⁷
	Cab & Chassis	⊖	81039	34073 ⁸	⊖	77488
	Cab & Chassis Exc. HD Solid Front Axle	⊖	34073 ⁸	⊖	G63366	77488
	Cab & Chassis HD Solid Front Axle	⊖	61525	34036 ⁸ 34073 ⁸	⊖	77488
89-90	Extended Cab Pickup Exc. HD Straight Front Axle	⊖	G63489	58489 61544 77489	34073 ⁸	⊖	G63488	77488 81667	43163 ⁸
88-90	All	⊖	34073 ⁸	⊖
	Exc. HD Straight Front Axle	⊖	81668	34073 ⁸	⊖	61543	49218 ⁷
	Cab & Chassis	⊖	81039	34073 ⁸	⊖
	Cab & Chassis Exc. HD Solid Front Axle	⊖	G63355	34073 ⁸	⊖	G63366
	Cab & Chassis HD Solid Front Axle	⊖	61525	34036 ⁸ 34073 ⁸	⊖
	HD Solid Front Axle	⊖	34073 ⁸	⊖	58488
88	Standard Cab Pickup Exc. HD Straight Front Axle	⊖	G63489	58489 61544 77489	34073 ⁸	⊖	G63488	77488 81667	43163 ⁸
88	Extended Cab Pickup Exc. HD Straight Front Axle	⊖	G63489	58489 61544 77489	34073 ⁸	⊖	G63488	77488	43163 ⁸
80-86	All	⊖	81039	⊖
	Crew Cab Pickup All models with factory frame bracket. Kit 143168 required to install to linkage.	⊖	81039	6802SE ⁸⁴	⊖
79	Crew Cab Pickup All models with factory frame bracket. Kit 143168 required to install to linkage.	⊖	6802SE ⁸⁴	⊖
75-78	Crew Cab Pickup All models with factory frame bracket. Kit 143168 required to install to linkage.	⊖	G63355	61525 81039	6802SE ⁸⁴	34036 ⁸	⊖	G63366
73-78	All	⊖	G63355	61525 81039	34036 ⁸	⊖	G63366
73-74	All models with factory frame bracket. Kit 143168 required to install to linkage.	⊖	G63355	61525 81039	6802SE ⁸⁴	34036 ⁸	⊖	G63366



7 Pair Packs, Air hose kit included.

80 Mounting bracket not required, install on O.E. Shock Mounts. See Ref. C for optional Steering Stabilizer Boots

8 Pair Packs.

84 Replacement damper for vehicles with the Gabriel Aftermarket mounting kit

APPLICATION GUIDE

Year	Fitment Notes										
		Ultra	Ready Mounts	Max Control\ LTV Severe Duty\ ProGuard\ Guardian	Strut Cushion\ Strut Mount\ Dampers\ Stabilizer	HiJackers\ Load Carrier\ Classic	Ultra	Ready Mounts	Max Control\ LTV Severe Duty\ ProGuard\ Guardian	Strut Cushion\ Strut Mount\ Dampers\ Stabilizer	HiJackers\ Load Carrier\ Classic

GMC

GMC

PICKUP 1 TON, C35/3500 (cont)

67-72	All	○	G63355	61525 81039	34036 ⁸	○
	Exc. 11,000# Rear Axle	○	G63355	61525 81039	34036 ⁸	○	G63306	49162 ⁷
72	All models with factory frame bracket. Kit 143168 required to install to linkage.	○	G63355	61525 81039	6802SE ⁵⁴	34036 ⁸	○

PICKUP 1 TON, K35 / K3500

88-00	All	○	G63609	58609 61542 77609 81726	○	G63488	58488 61543 77488 81667	43163 ⁸ 49218 ⁷
77-86	All	○	G63411	14017	○	G63675	58412 61642 77412 81921
73-74	All	○	14017	○

PICKUP 1 TON, R3500

87-91	All	○	G63355	61525 81039	34036 ⁸	○	G63366
-------	-----	---	--------	------	----------------	------	--------------------	---	--------	------	------	------	------

PICKUP 1 TON, V3000 / V3500

87-91	All	○	G63411	14017	○	G63675	58412 61642 77412 81921
87-88	Quad Suspension Long Shock; Exc. Lift Kit	○	G63411	81496 ⁸	14017	○	G63675	58412 61642 77412 81921

PICKUP 1000 SERIES

66	All	○	G63355	61525 81039	○
63-65	All	○	G63355	61525 81039	34036 ⁸	○	G63306	49162 ⁷
61-62	All	○	82035	○	82086

PICKUP 1500 SERIES

66	All	○	G63355	61525 81039	○
63-65	All	○	G63355	61525 81039	34036 ⁸	○	G63306	49162 ⁷
61-62	All	○	82035	○	82086

PICKUP 2500 SERIES

66	All	○	G63355	61525 81039	○
61-62	All	○	82035	○

S15 JIMMY

83-91	All	○	142316 ⁵³	○	G63422	58422 61528 77422 81482	43162 ⁸ 49213 ⁷
	4WD	○	G63423	58423 61531 77423 81516	142316 ⁵³	○	G63422	58422 61528 77422 81482	43162 ⁸ 49213 ⁷
	RWD	○	G63421	58421 61504 81750	142316 ⁵³	34051 ⁸	○	G63422	58422 61528 77422 81482	43162 ⁸ 49213 ⁷



6 It is recommended that when replacing shocks on vehicles with "quad shocks" all 4 shocks should be matched by series.

7 Pair Packs, Air hose kit included.

8 Pair Packs.

53 Hardware from O.E. Part may need to be reused.

APPLICATION GUIDE

Year	Fitment Notes										
		Ultra	Ready Mounts	Max Control\ LTV Severe Duty\ ProGuard\ Guardian	Strut Cushion\ Strut Mount\ Dampers\ Stabilizer	HiJackers\ Load Carrier\ Classic	Ultra	Ready Mounts	Max Control\ LTV Severe Duty\ ProGuard\ Guardian	Strut Cushion\ Strut Mount\ Dampers\ Stabilizer	HiJackers\ Load Carrier\ Classic

GMC

GMC

S15 JIMMY (cont)

83-91	Single system Steering Stabilizer; with a factory mounting hole in the steering linkage.	OO	6801SE ⁸⁰ 142316 ⁵³	OO	G63422	58422 61528 77422 81482	43162 ⁸ 49213 ⁷
-------	------------------------------------------------------------------------------------------	----	------	------	------	----------------------------------------------	------	----	--------	------	----------------------------------	------	------------------------------------------

SAFARI

90-05	All		OO	G63454	61539 77454 81581	49215 ⁷
	AWD	OO	G63818	58609 61542 77609 81726	OO	G63454	61539 77454 81581	49215 ⁷
	RWD	IO	G63375 ⁵	61555 77375 81713 ⁵	OO	G63454	61539 77454 81581	49215 ⁷
85-89	RWD	IO	G63375 ⁵	61555 77375 81713 ⁵	OO	G63454	61539 77454 81581	49215 ⁷

SAVANA 4500

15-20	All	IO	G63895	61685	OO	G63897	61687 77638
14	All	IO	G63895	61685	OO	G63897	61687
10-13	All		OO	G63897	61687



SIERRA 1500

22	All		OO	43181 ⁸ 49235 ⁷
19-21	All		OO	77412	43181 ⁸ 49235 ⁷
21	Exc. Classic Models and Electronic Adjustable Suspension		OO	G63959	61690 77412	43181 ⁸ 49235 ⁷
19-20	Exc. Payload Package		OO	G63959	77412	43181 ⁸ 49235 ⁷
	Exc. Classic Models and Electronic Adjustable Suspension		OO	61690 77412	43181 ⁸ 49235 ⁷
18	All		G51949	OO	61690	43181 ⁸
	Exc. Electronic Adjustable Suspension		G51949	OO	77412 61690	43181 ⁸
	4WD		G51949	G57000 ⁴⁰	OO	61690	49235 ⁷ 43181 ⁸
	Exc. Classic Models and Electronic Adjustable Suspension		G51949	OO	G63959	61690	43181 ⁸
	RWD, Exc. Electronic Ride Control		G51949	G57023 ⁴⁰	OO	61690	43181 ⁸
	RWD, Exc. Z55 Auto Ride Suspension		G51949	OO	61690	49235 ⁷ 43181 ⁸
14-17	All		G51949	OO	77976	43181 ⁸
	Exc. Electronic Adjustable Suspension		G51949	OO	77412 77976	43181 ⁸
	4WD		G51949	G57000 ⁴⁰	OO	77976	49235 ⁷ 43181 ⁸
	Exc. Classic Models and Electronic Adjustable Suspension		G51949	OO	G63959	61690 77976	43181 ⁸
	RWD, Exc. Electronic Ride Control		G51949	G57023 ⁴⁰	OO	77976	43181 ⁸
				G51949	OO	77976

5 Use kit No. 140719 to replace O.E. hardware for lower shock absorber mounting when studs break or self-tapping screws are not longer useable.
8 Pair Packs.
53 Hardware from O.E. Part may need to be reused.

7 Pair Packs, Air hose kit included.
40 Complete Assembled Unit.
80 Mounting bracket not required, install on O.E. Shock Mounts. See Ref. C for optional Steering Stabilizer Boots

APPLICATION GUIDE

Year	Fitment Notes										
		Ultra	Ready Mounts	Max Control\ LTV Severe Duty\ ProGuard\ Guardian	Strut Cushion\ Strut Mount\ Dampers\ Stabilizer	HiJackers\ Load Carrier\ Classic	Ultra	Ready Mounts	Max Control\ LTV Severe Duty\ ProGuard\ Guardian	Strut Cushion\ Strut Mount\ Dampers\ Stabilizer	HiJackers\ Load Carrier\ Classic

GMC

GMC

SIERRA 1500 (cont)

14-17	RWD, Exc. Z55 Auto Ride Suspension		G51949	77976	49235 ⁷ 43181 ⁸	
07-13	All		77976	43181 ⁸	
	Exc. Electronic Adjustable Suspension		77412 77976	43181 ⁸	
	4WD		G57000 ⁴⁰	77976	49235 ⁷ 43181 ⁸
	Exc. Classic Models and Electronic Adjustable Suspension		G51870	143316 ⁵³		G63959	61690 77976	43181 ⁸	
	RWD, Exc. Electronic Ride Control		G57023 ⁴⁰	77976	43181 ⁸
	RWD, Exc. Z55 Auto Ride Suspension		77976	49235 ⁷ 43181 ⁸
07	4WD; Classic and Old Body Style; Exc. Electronic Adjustable Suspension		G63803	58803 61643 77803 81922		G63675	58412 61642 77412 81921 77976	43181 ⁸	
	RWD; Classic Models Only; Exc. Electronic Adjustable Suspension		G63783	61641 77783 81920		G63662	58662 61600 77662 81873 77976	43181 ⁸	
	RWD; Classic Models Only; Exc. Z55 Auto Ride Suspension		77976	49235 ⁷ 43181 ⁸	
99-06	4WD; Classic and Old Body Style; Exc. Electronic Adjustable Suspension		G63803	58803 61643 77803 81922		G63675	58412 61642 77412 81921	
	RWD; Classic Models Only; Exc. Electronic Adjustable Suspension		G63783	61641 77783 81920		G63662	58662 61600 77662 81873	43181 ⁸	
	RWD; Classic Models Only; Exc. Z55 Auto Ride Suspension		49235 ⁷	
99-05	4WD, Exc. OE Unit		6853SE ⁸⁶	

SIERRA 1500 HD

05-06	All		G63817	58817 61663 77817 81925		G63675	58412 61642 77412 81921
01-03	All		G63817	58817 61663 77817 81925		G63675	58412 61642 77412 81921

SIERRA 1500 HD CLASSIC

07	All		G63817	58817 61663 77817 81925		G63675	58412 61642 77412 81921
----	-----	--	--------	------	----------------------------------	------	------	--	--------	------	----------------------------------	------	------

SIERRA 1500 LIMITED

19	All		61690 77412	43181 ⁸ 49235 ⁷
	Exc. Payload Package			G63959	61690 77412	43181 ⁸ 49235 ⁷

SIERRA 2500

99-04	All		58817		G63675	58412 61642 77412 81921
-------	-----	--	------	------	-------	------	------	--	--------	------	----------------------------------	------	------



7 Pair Packs, Air hose kit included.

40 Complete Assembled Unit.

8 Pair Packs.

53 Hardware from O.E. Part may need to be reused.







APPLICATION GUIDE

Year	Fitment Notes										
		Ultra	Ready Mounts	Max Control\ LTV Severe Duty\ ProGuard\ Guardian	Strut Cushion\ Strut Mount\ Dampers\ Stabilizer	HiJackers\ Load Carrier\ Classic	Ultra	Ready Mounts	Max Control\ LTV Severe Duty\ ProGuard\ Guardian	Strut Cushion\ Strut Mount\ Dampers\ Stabilizer	HiJackers\ Load Carrier\ Classic











GMC

GMC





SIERRA 2500 (cont)

99-04	4WD		G63817	61663 77817 81925 58817		G63675	58412 61642 77412 81921
	4WD; Up through 8600# GVW; Exc. OE Steering Stabilizer		58817	6853SE ⁸²		G63675	58412 61642 77412 81921
	RWD, Exc. Electronic Adjustable Suspension		G63783	61641 77783 81920 58817		G63675	58412 61642 77412 81921



SIERRA 2500 HD

22	All		G64148		G64121	43181 ⁸
11-21	All		G64148		G64121	77976	43181 ⁸
01-10	All		G63817	58817 61663 77817		G63675	58412 61642 77412 81921
01-09	9200# GVW with OE Unit - 15059138 15155638		G63817	58817 61663 77817	6853SE ⁸²		G63675	58412 61642 77412 81921
01-04	RWD		G63783	61641 77783 81920 58817 61663 77817		G63675	58412 61642 77412 81921



SIERRA 2500 HD CLASSIC

07	All			58412
	4WD			77412 58412









SIERRA 3500

01-06	All		G63817	58817 61663 77817		G63675	58412 61642 77412 81921
-------	-----	-------------------------------------------------------------------------------------	--------	------	-------------------------	------	------	---------------------------------------------------------------------------------------	--------	------	----------------------------------	------	------





SIERRA 3500 CLASSIC

07	All		58817 61663		58412 61642 77412
----	-----	-------------------------------------------------------------------------------------	------	------	----------------	------	------	---------------------------------------------------------------------------------------	------	------	-------------------------	------	------

SIERRA 3500 HD

22	All		G64148		G64121	43181 ⁸
11-21	All		G64148		G64121	77976	43181 ⁸
07-10	All			G63675	58412 61642 77412 81921
	Torsion Bar(FrontSpringType)		G63817	58817 61663 77817		G63675	58412 61642 77412 81921

SONOMA / S15 2WD



82-04	All			G63422	58422 61528 77422 81482	43162 ⁸ 49213 ⁷
	RWD		G63421	58421 61504 81750	34051 ⁸		G63422	58422 61528 77422 81482	43162 ⁸ 49213 ⁷

7 Pair Packs, Air hose kit included.

8 Pair Packs.

82 Use kit if listed, See Ref. C for optional Steering Stabilizer Boots.

APPLICATION GUIDE

Year	Fitment Notes										
		Ultra	Ready Mounts	Max Control\ LTV Severe Duty\ ProGuard\ Guardian	Strut Cushion\ Strut Mount\ Dampers\ Stabilizer	HiJackers\ Load Carrier\ Classic	Ultra	Ready Mounts	Max Control\ LTV Severe Duty\ ProGuard\ Guardian	Strut Cushion\ Strut Mount\ Dampers\ Stabilizer	HiJackers\ Load Carrier\ Classic

GMC

GMC

SONOMA / S15 2WD (cont)

91-93	Single system Steering Stabilizer; with a factory mounting hole in the steering linkage.	○	6801SE ⁸⁰	○	G63422	58422 61528 77422 81482	43162 ⁸ 49213 ⁷
82-93	Single System Steering Stabilizer	○	6802SE ⁸⁴	○	G63422	58422 61528 77422 81482	43162 ⁸ 49213 ⁷
82-90	RWD; Single system Steering Stabilizer; with a factory mounting hole in the steering linkage.	○	6801SE ⁸⁰	○	G63422	58422 61528 77422 81482	43162 ⁸ 49213 ⁷

SONOMA / S15 4WD

83-04	4WD	○	G63423	58423 61531 77423 81516	○	G63422	58422 61528 77422 81482	43162 ⁸ 49213 ⁷
82-04	All	○	○	G63422	58422 61528 77422 81482	43162 ⁸ 49213 ⁷
04	RWD	○	G63421	58421 61504 81750	○	G63422	58422 61528 77422 81482	43162 ⁸ 49213 ⁷
88-94	4WD, Torsion Bar(FrontSpringType)	○	142316 ⁵³	○	G63422	58422 61528 77422 81482	43162 ⁸ 49213 ⁷
91-93	Single system Steering Stabilizer; with a factory mounting hole in the steering linkage.	○	6801SE ⁸⁰	○	G63422	58422 61528 77422 81482	43162 ⁸ 49213 ⁷
82	RWD	○	34051 ⁸	○	G63422	58422 61528 77422 81482	43162 ⁸ 49213 ⁷

SPRINT / CABALLERO

78-87	All	○	61504	○
	RWD	○	G63421	58421 81750 61504	○	81492	43060 ⁸ 49334 ³⁰
71-77	All	○	G63421	58421 61504 81750	○	81492	43060 ⁸ 49152 ³⁰
	RWD	○	G63421	58421 61504 81750	○	81492	43060 ⁸ 49152 ³⁰

SUBURBAN 1/2 TON, C15 / C1500

93-99	All	○	G63489	58489 61544 77489 81668	○	G63896	58638 61565 77638	43180 ⁸ 49231 ⁷
92	All	○	G63489	58489 61544 77489 81668	○	58638 61565 77638	43180 ⁸ 49231 ⁷
	Old Body Style	○	G63489	58489 61544 77489 81668	○	G63896	58638 61565 77638	43180 ⁸ 49231 ⁷
75-86	All	○	G63355	61525 81039	○	G63349	61524 81164	43111 ⁸ 49155 ⁷
	Single System Steering Stabilizer	○	G63355	61525 81039	6802SE ⁸⁴	○	G63349	61524 81164	43111 ⁸ 49155 ⁷
73-74	All	○	G63355	81039	○	G63349	61524 81164	43111 ⁸ 49155 ⁷

7 Pair Packs, Air hose kit included.

30 For GM Vehicles equipped with factory installed leveling systems, see Ref A.



80 Mounting bracket not required, install on O.E. Shock Mounts. See Ref. C for

8 Pair Packs.

53 Hardware from O.E. Part may need to be reused.

84 Replacement damper for vehicles with the Gabriel Aftermarket mounting kit

APPLICATION GUIDE

Year	Fitment Notes										
		Ultra	Ready Mounts	Max Control\ LTV Severe Duty\ ProGuard\ Guardian	Strut Cushion\ Strut Mount\ Dampers\ Stabilizer	HiJackers\ Load Carrier\ Classic	Ultra	Ready Mounts	Max Control\ LTV Severe Duty\ ProGuard\ Guardian	Strut Cushion\ Strut Mount\ Dampers\ Stabilizer	HiJackers\ Load Carrier\ Classic

GMC

GMC

SUBURBAN 1/2 TON, C15 / C1500 (cont)

73-74	Coil (FrontSpringType)	OO	G63355	61525 81039	34036 ⁸	OO	G63349	61524 81164	43111 ⁸ 49155 ⁷
	Single System Steering Stabilizer	OO	G63355	81039	6802SE ⁸⁴	34036 ⁸	OO	G63349	61524 81164	43111 ⁸ 49155 ⁷
68-72	All	OO	G63355	34036 ⁸	
	Coil (FrontSpringType)	OO	G63355	61525 81039	34036 ⁸	
	Coil(RearSpringType)	OO	G63355	34036 ⁸	OO	49107 ⁷ 82003
	Single System Steering Stabilizer	OO	G63355	6802SE ⁸⁴	34036 ⁸	

SUBURBAN 1/2 TON, K15 / K1500

92-99	All	OO	G63609	58609 ⁵⁰ 61542 77609 81726	OO	G63638	58638 ⁵⁰ 61565 77638	43180 ⁸ 49231 ⁷
81-86	Quad Suspension Long Shock; Exc. Lift Kit	OO	61522 ⁶ 81496 ⁶	14017
73-86	All	OO	14017
	Exc. Lift Kit	OO	14017	OO	G63349	61524 81164	43111 ⁸
	Exc. Quad Suspension and Lift Kit	OO	G63347	61516 81113 ⁶	14017	OO	49155 ⁷
	Dual System Steering Stabilizer	OO	6802SE ⁸⁴ 14017
	Single System Steering Stabilizer	OO	6804SE ⁸⁰ 14017
69-72	Exc. Quad Suspension and Lift Kit	OO	G63347	61516 81113 ⁶
68-72	Dual System Steering Stabilizer	OO	6802SE ⁸⁴
	Single System Steering Stabilizer	OO	6803SE ⁸⁴

SUBURBAN 1/2 TON, R1500

87-91	All	OO	G63355	61525 81039	34036 ⁸	OO	G63349	61524 81164	43111 ⁸ 49155 ⁷
	Single System Steering Stabilizer	OO	G63355	61525 81039	6802SE ⁸⁴	34036 ⁸	OO	G63349	61524 81164	43111 ⁸ 49155 ⁷

SUBURBAN 1/2 TON, V1500

87-91	All	OO	14017
	Exc. Lift Kit	OO	G63347	14017	OO	G63349	61524 81164	43111 ⁸ 49155 ⁷
	Quad Suspension Long Shock; Exc. Lift Kit	OO	61522 ⁶ 81496 ⁶	14017
	Quad Suspension Short Shock; Exc. Lift Kit	OO	61516 81113 ⁶	14017
	Dual System Steering Stabilizer	OO	6802SE ⁸⁴ 14017
	Single System Steering Stabilizer	OO	6804SE ⁸⁰ 14017

SUBURBAN 3/4 TON, C25 / C2500

92-99	All	OO	G63489	58489 61544 77489 81668	34073 ⁸	OO	G63896	58638 61565 77638	43180 ⁸ 49231 ⁷
75-86	All	OO	G63355	61525 81039	34036 ⁸	OO	G63349	61524 81164	43111 ⁸ 49155 ⁷
	Single System Steering Stabilizer	OO	G63355	61525 81039	6802SE ⁸⁴	34036 ⁸	OO	G63349	61524 81164	43111 ⁸ 49155 ⁷

6 It is recommended that when replacing shocks on vehicles with "quad shocks" all 4 shocks should be matched by series.

8 Pair Packs.



80 Mounting bracket not required, install on O.E. Shock Mounts. See Ref. C for optional Steering Stabilizer Boots

7 Pair Packs, Air hose kit included.

50 Bellows Kit No. 141242 is recommended for use to protect piston rod from potentially harmful road debris.

84 Replacement damper for vehicles with the Gabriel Aftermarket mounting kit

APPLICATION GUIDE

Year	Fitment Notes										
		Ultra	Ready Mounts	Max Control\ LTV Severe Duty\ ProGuard\ Guardian	Strut Cushion\ Strut Mount\ Dampers\ Stabilizer	HiJackers\ Load Carrier\ Classic	Ultra	Ready Mounts	Max Control\ LTV Severe Duty\ ProGuard\ Guardian	Strut Cushion\ Strut Mount\ Dampers\ Stabilizer	HiJackers\ Load Carrier\ Classic

GMC

GMC

SUBURBAN 3/4 TON, C25 / C2500 (cont)

73-74	All	○	G63355	61525 81039	34036 ⁸	○	43111 ⁸ 49155 ⁷
	Exc. Crew Cab & Bonus Cab	○	G63355	61525 81039	34036 ⁸	○	G63349	61524 81164	43111 ⁸ 49155 ⁷
	Single System Steering Stabilizer	○	G63355	61525 81039	6802SE ⁸⁴	34036 ⁸	○	43111 ⁸ 49155 ⁷
68-72	All	○	G63355	61525 81039	34036 ⁸	○	49107 ⁷ 82003
	Single System Steering Stabilizer	○	G63355	61525 81039	6802SE ⁸⁴	34036 ⁸	○	49107 ⁷ 82003

SUBURBAN 3/4 TON, K25 / K2500

92-99	All	○	G63609	58609 61542 77609 81726	○	G63638	58638 61565 77638	43180 ⁸ 49231 ⁷
81-86	Quad Suspension Long Shock; Exc. Lift Kit	○	61522 ⁸ 81496 ⁸	14017	○
73-86	All	○	14017	○
	Exc. Lift Kit	○	14017	○	G63349	61524 81164	43111 ⁸
	Exc. Quad Suspension and Lift Kit	○	G63347	61516 81113 ⁸	14017	○	49155 ⁷
	Dual System Steering Stabilizer	○	6802SE ⁸⁴ 14017	○
	Single System Steering Stabilizer	○	6804SE ⁸⁰ 14017	○
69-72	Exc. Quad Suspension and Lift Kit	○	G63347	61516 81113 ⁸	○
68-72	Dual System Steering Stabilizer	○	6802SE ⁸⁴	○
	Single System Steering Stabilizer	○	6803SE ⁸⁴	○

SUBURBAN 3/4 TON, R2500

87-91	All	○	G63355	61525 81039	34036 ⁸	○	G63349	61524 81164	43111 ⁸ 49155 ⁷
	Single System Steering Stabilizer	○	G63355	61525 81039	6802SE ⁸⁴	34036 ⁸	○	G63349	61524 81164	43111 ⁸ 49155 ⁷

SUBURBAN 3/4 TON, V2500

87-91	All	○	14017	○
	Exc. Lift Kit	○	G63347	14017	○	G63349	61524 81164	43111 ⁸ 49155 ⁷
	Quad Suspension Long Shock; Exc. Lift Kit	○	61522 ⁸ 81496 ⁸	14017	○
	Quad Suspension Short Shock; Exc. Lift Kit	○	61516 81113 ⁸	14017	○
	Dual System Steering Stabilizer	○	6802SE ⁸⁴ 14017	○
	Single System Steering Stabilizer	○	6804SE ⁸⁰ 14017	○

SYCLONE



91	All	○	G63423	58423 61531 77423 81516	○	G63422	58422 61528 77422 81482	43162 ⁸ 49213 ⁷
	Single system Steering Stabilizer; with a factory mounting hole in the steering linkage.	○	G63423	58423 61531 77423 81516	6801SE ⁸⁰	○	G63422	58422 61528 77422 81482	43162 ⁸ 49213 ⁷

6 It is recommended that when replacing shocks on vehicles with "quad shocks" all 4 shocks should be matched by series.
8 Pair Packs.

7 Pair Packs, Air hose kit included.

80 Mounting bracket not required, install on O.E. Shock Mounts. See Ref. C for optional Steering Stabilizer Boots



APPLICATION GUIDE

Year	Fitment Notes										
		Ultra	Ready Mounts	Max Control\ LTV Severe Duty\ ProGuard\ Guardian	Strut Cushion\ Strut Mount\ Dampers\ Stabilizer	HiJackers\ Load Carrier\ Classic	Ultra	Ready Mounts	Max Control\ LTV Severe Duty\ ProGuard\ Guardian	Strut Cushion\ Strut Mount\ Dampers\ Stabilizer	HiJackers\ Load Carrier\ Classic























GMC

GMC

SYCLONE (cont)

91	Torsion Bar(FrontSpringType)		G63423	58423 61531 77423 81516	142316 ⁵³		G63422	58422 61528 77422 81482	43162 ⁸ 49213 ⁷
----	------------------------------	-----------------------------------------------------------------------------------	--------	------	----------------------------------	----------------------	------	-------------------------------------------------------------------------------------	--------	------	----------------------------------	------	------------------------------------------



TERRAIN

14-17	All			G64140
14-16	Left		G52127		G64140
	Left Exc. Models w/ 19" Wheels		G57197 ⁴⁰		G64140
	Right		G52128		G64140
	Right Exc. Models w/ 19" Wheels		G57198 ⁴⁰		G64140
10-13	All			G64015	61718
	Left		G52127		G64015	61718
	Left Exc. Models w/ 19" Wheels		G57197 ⁴⁰		G64015	61718
	Right		G52128		G64015	61718
	Right Exc. Models w/ 19" Wheels		G57198 ⁴⁰		G64015	61718
10-12	Left Models w/ 19" Wheels		G57322 ⁴⁰		G64015	61718
	Right Models w/ 19" Wheels		G57323 ⁴⁰		G64015	61718

















TRACKER

89-91	All			81904
-------	-----	--	------	------	------	------	------	---------------------------------------------------------------------------------------	------	------	-------	------	------

TYPHOON

92-93	All		G63423	58423 61531 77423 81516	142316 ⁵³		G63422	58422 61528 77422 81482	43162 ⁸ 49213 ⁷
-------	-----	-------------------------------------------------------------------------------------	--------	------	----------------------------------	----------------------	------	---------------------------------------------------------------------------------------	--------	------	----------------------------------	------	------------------------------------------



VAN 1/2 TON, G / SAVANA

12-14	AWD, Torsion Bar(FrontSpringType)		G63893	61683		G63896	58638	43180 ⁸ 49231 ⁷
08-14	All			G63896	58638	43180 ⁸ 49231 ⁷
	RWD			G63896	77638 58638	43180 ⁸ 49231 ⁷
	RWD, Coil(FrontSpringType)		G63894	61684		G63896	58638	43180 ⁸ 49231 ⁷
08-11	Exc. Upfitter Package and Cutaway Chassis			G63896	61565 58638	43180 ⁸ 49231 ⁷
	Torsion Bar (FrontSpringType)		G63893	61683		G63896	58638	43180 ⁸ 49231 ⁷
07	All			G63896	43180 ⁸ 49231 ⁷
	Exc. Upfitter Package and Cutaway Chassis			G63896	61565	43180 ⁸ 49231 ⁷
	RWD			G63896	77638	43180 ⁸ 49231 ⁷
	RWD, Coil(FrontSpringType)		G63894	61684		G63896	43180 ⁸ 49231 ⁷
	Torsion Bar (FrontSpringType)		G63893	61683		G63896	43180 ⁸ 49231 ⁷

7 Pair Packs, Air hose kit included.
40 Complete Assembled Unit.

8 Pair Packs.
53 Hardware from O.E. Part may need to be reused.

APPLICATION GUIDE

Year	Fitment Notes										
		Ultra	Ready Mounts	Max Control\ LTV Severe Duty\ ProGuard\ Guardian	Strut Cushion\ Strut Mount\ Dampers\ Stabilizer	HiJackers\ Load Carrier\ Classic	Ultra	Ready Mounts	Max Control\ LTV Severe Duty\ ProGuard\ Guardian	Strut Cushion\ Strut Mount\ Dampers\ Stabilizer	HiJackers\ Load Carrier\ Classic

GMC

GMC

VAN 1/2 TON, G / SAVANA (cont)

03-06	All		G63896	58638	43180 ⁶ 49231 ⁷
	Exc. Upfitter Package and Cutaway Chassis		G63896	61565 58638	43180 ⁶ 49231 ⁷
	RWD		G63896	77638 58638	43180 ⁶ 49231 ⁷
	RWD, Coil(FrontSpringType)	I	G63894	61684	G63896	58638	43180 ⁶ 49231 ⁷
	Torsion Bar (FrontSpringType)	I	G63893	61683	G63896	58638	43180 ⁶ 49231 ⁷
96-02	All	I	61555	G63896	58638 61565	43180 ⁶ 49231 ⁷
	Exc. 8600# GVW	I	61555	34073 ⁸	G63896	58638 61565	43180 ⁶ 49231 ⁷
	RWD	I	G63375 ⁵	77375 81713 ⁵ 61555	G63896	77638 58638 61565	43180 ⁶ 49231 ⁷
78-95	All	O	G63357	58357 61517	G63413	61522 81496	49212 ⁷
	Single System Steering Stabilizer	O	G63357	58357 61517	6802SE ⁸⁴	G63413	61522 81496	49212 ⁷
71-77	All	O	G63357	58357 61517	G63306	49162 ⁷
	Single System Steering Stabilizer	O	G63357	58357 61517	6802SE ⁸⁴	G63306	49162 ⁷
70	All	O	58357	G63306	49162 ⁷
	Independent Front Suspension	O	G63357	61517 58357	G63306	49162 ⁷
	Single System Steering Stabilizer	O	58357	6802SE ⁸⁴	G63306	49162 ⁷
67-69	All	O	G63306	49162 ⁷
64-66	All	O	82003

VAN 1/2 TON, P SERIES

74-80	All	O	G63355	61525 81039	34036 ⁸	G63366	77662
73	All	O	G63355	61525 81039	34036 ⁸	G63349	61524 81164	43111 ⁸ 49155 ⁷
68-72	All	O	G63355	61525 81039	34036 ⁸	82003
	Coil(RearSpringType)	O	G63355	61525 81039	34036 ⁸	49107 ⁷ 82003
67	All	O	G63355	61525 81039	34036 ⁸	G63306	49162 ⁷

VAN 3/4 TON, G / SAVANA



17-22	All	I	G63895	61685	G63897	61687 77638	43180 ⁶
03-16	All		G63897	61687 77638	43180 ⁶
	Coil(FrontSpringType)	I	G63895	61685	G63897	61687 77638	43180 ⁶
03-12	Torsion Bar (FrontSpringType)	I	G63893	61683	G63897	61687 77638	43180 ⁶
96-02	Exc. 8600# GVW	I	G63375 ⁵	61555 77375 81713 ⁵	34073 ⁸	G63638	58638 61565 77638	43180 ⁶ 49231 ⁷
78-95	Exc. 8600# GVW	O	G63357	58357 61517	G63413	61522 81496	49212 ⁷
	Single System Steering Stabilizer	O	6802SE ⁸⁴
71-77	All	O	G63357	58357 61517	G63306	49162 ⁷

5 Use kit No. 140719 to replace O.E. hardware for lower shock absorber mounting when studs break or self-tapping screws are not longer useable.

7 Pair Packs, Air hose kit included.

84 Replacement damper for vehicles with the Gabriel Aftermarket mounting kit

APPLICATION GUIDE

Year	Fitment Notes										
		Ultra	Ready Mounts	Max Control\ LTV Severe Duty\ ProGuard\ Guardian	Strut Cushion\ Strut Mount\ Dampers\ Stabilizer	HiJackers\ Load Carrier\ Classic	Ultra	Ready Mounts	Max Control\ LTV Severe Duty\ ProGuard\ Guardian	Strut Cushion\ Strut Mount\ Dampers\ Stabilizer	HiJackers\ Load Carrier\ Classic

GMC

GMC

VAN 3/4 TON, G / SAVANA (cont)

71-77	Single System Steering Stabilizer	○	G63357	58357 61517	6802SE ⁸⁴	○	G63306	49162 ⁷
67-70	All	○	○	G63306	49162 ⁷
70	Independent Front Suspension	○	G63357	58357 61517	○	G63306	49162 ⁷
	Single System Steering Stabilizer	○	6802SE ⁸⁴	○	G63306	49162 ⁷

VAN 3/4 TON, P SERIES

79-89	All	○	G63355	61525 81039	34036 ⁸	○	G63366
73-78	All	○	G63355	61525 81039	34036 ⁸	○	G63349	61524 81164	43111 ⁸ 49155 ⁷
68-72	All	○	G63355	61525 81039	34036 ⁸	○	G63306	49162 ⁷
67	All	○	82047	○

VAN 1 TON, G / SAVANA



17-22	All	⊖	G63895	61685	⊖	G63897	61687 77638	43180 ⁸
13-16	All	⊖	⊖	G63897	61687 77638	43180 ⁸
	Coil(FrontSpringType)	⊖	G63895	61685	⊖	G63897	61687 77638	43180 ⁸
04-12	All	⊖	⊖	77638	43180 ⁸
	Single Rear Wheels	⊖	⊖	G63897	61687 77638	43180 ⁸
	Torsion Bar (FrontSpringType)	⊖	G63893	⊖	77638	43180 ⁸
	Coil(FrontSpringType)	⊖	G63895	61685	77638	43180 ⁸
03	All	⊖	⊖	43180 ⁸
	Single Rear Wheels	⊖	⊖	G63897	61687	43180 ⁸
	Torsion Bar (FrontSpringType)	⊖	G63893	⊖	43180 ⁸
	Coil(FrontSpringType)	⊖	G63895	61685	43180 ⁸
97-02	All	⊖	G63375 ⁵	61555 77375 81713 ⁵	⊖	43180 ⁸ 49231 ⁷
	Exc. 8600# GVW	⊖	G63375 ⁵	61555 77375 81713 ⁵	34073 ⁸	⊖	G63638	58638 61565 77638	43180 ⁸ 49231 ⁷
96	All	⊖	G63375 ⁵	58357 61555 77375 81713 ⁵	⊖	43180 ⁸ 49231 ⁷
	7100, 7400 and 8600# GVW	⊖	G63375 ⁵	58357 61555 77375 81713 ⁵	⊖	77638	43180 ⁸ 49231 ⁷
	Exc. 8600# GVW	⊖	G63375 ⁵	58357 61555 77375 81713 ⁵	34073 ⁸	⊖	G63638	58638 61565 77638	43180 ⁸ 49231 ⁷
	Cutaway Van	⊖	G63375 ⁵	58357 61555 77375 81713 ⁵	⊖	G63671	43180 ⁸ 49231 ⁷
	Cutaway Van 9200# GVW	⊖	G63375 ⁵	58357 61555 77375 81713 ⁵	G63403	43180 ⁸ 49231 ⁷
			⊖							

5 Use kit No. 140719 to replace O.E. hardware for lower shock absorber mounting when studs break or self-tapping screws are not longer useable.
8 Pair Packs.

7 Pair Packs, Air hose kit included.

84 Replacement damper for vehicles with the Gabriel Aftermarket mounting kit

APPLICATION GUIDE

Year	Fitment Notes										
		Ultra	Ready Mounts	Max Control\ LTV Severe Duty\ ProGuard\ Guardian	Strut Cushion\ Strut Mount\ Dampers\ Stabilizer	HiJackers\ Load Carrier\ Classic	Ultra	Ready Mounts	Max Control\ LTV Severe Duty\ ProGuard\ Guardian	Strut Cushion\ Strut Mount\ Dampers\ Stabilizer	HiJackers\ Load Carrier\ Classic

GMC

GMC

VAN 1 TON, G / SAVANA (cont)

96	Exc. Cutaway Van		G63375 ⁵	...	58357 61555 77375 81713 ⁵		G63413	...	61522 ⁶ 81496	...	43180 ⁶ 49231 ⁷
94-95	Single System Steering Stabilizer; HD with Straight Front Axle & Tilt Hood		G63357	...	58357 61517	6804SE ⁸⁰
93-95	Cutaway Van 9200# GVW		G63357	...	58357 61517		G63403	...	77403
92-95	Cutaway Van		G63357	...	58357 61517		G63671	...	58403
79-95	Exc. Cutaway Van		G63357	...	58357 61517		G63413	...	61522 ⁶ 81496	...	49212 ⁷
78-95	All		G63357	...	58357 61517
	Single System Steering Stabilizer		G63357	...	58357 61517	6802SE ⁸⁴
92	Cutaway Van 9200# GVW		G63357	...	58357 61517	77403
79-91	Cutaway Van		G63357	...	58357 61517	58403
	Cutaway Van 9200# GVW		G63357	...	58357 61517		G63403	...	77403
78	Cutaway Van		G63357	...	58357 61517		G63413	...	61522 ⁶ 81496	...	49212 ⁷
76-77	All		G63357	...	58357 61517		G63306	49162 ⁷
	Single System Steering Stabilizer		G63357	...	58357 61517	6802SE ⁸⁴	...		G63306	49162 ⁷
75	110.0 / 279.4(WheelBase)		58357 61517		G63306	49162 ⁷
	125.0 / 317.5(WheelBase)		58357 61517		G63306	49162 ⁷
	146.0 / 370.8(WheelBase)		G63357
	Single System Steering Stabilizer		6802SE ⁸⁴
71-74	All		G63357	...	58357 61517		G63306
	Exc. 146" Wheelbase		G63357	...	58357 61517		G63306	49162 ⁷
	Single System Steering Stabilizer		G63357	...	58357 61517	6802SE ⁸⁴	...		G63306

VAN 1 TON, P SERIES

86-99	Motorhome Chassis w/ I-Beam Front Suspension		G63625		G63366	...	77662
85-99	Motorhome Chassis w/ Independent Front Suspension		G63394		G63366	...	77662
75-99	All			G63366	...	77662
75-90	Cutaway Chassis		G63355	...	61525 81039	...	34036 ⁸		G63366	...	77662
85	Motorhome Chassis w/ I-Beam Front Suspension		G63403	...	58403 77403		G63366	...	77662
75-84	Motorhome Chassis		G63394		G63366	...	77662
73-74	All			G63366
74	Cutaway Chassis		34036 ⁸		G63366
	Base, Cutaway Chassis		G63355	...	61525 81039		G63366	...	77662
	Motorhome		G63394		G63366	...	77662

5 Use kit No. 140719 to replace O.E. hardware for lower shock absorber mounting when studs break or self-tapping screws are not longer useable.

7 Pair Packs, Air hose kit included.



80 Mounting bracket not required, install on O.E. Shock Mounts. See Ref. C for

6 It is recommended that when replacing shocks on vehicles with "quad shocks" all 4 shocks should be matched by series.

8 Pair Packs.

84 Replacement damper for vehicles with the Gabriel Aftermarket mounting kit

APPLICATION GUIDE

Year	Fitment Notes										
		Ultra	Ready Mounts	Max Control\ LTV Severe Duty\ ProGuard\ Guardian	Strut Cushion\ Strut Mount\ Dampers\ Stabilizer	HiJackers\ Load Carrier\ Classic	Ultra	Ready Mounts	Max Control\ LTV Severe Duty\ ProGuard\ Guardian	Strut Cushion\ Strut Mount\ Dampers\ Stabilizer	HiJackers\ Load Carrier\ Classic

GMC

GMC

VAN 1 TON, P SERIES (cont)

73	Base, Cutaway Chassis	OO	G63355	61525 81039	34036 ⁸	OO	G63366	77662
68-72	All	OO	G63355	61525 81039	34036 ⁸	
	Exc. 11,000# Rear Axle	OO	G63355	61525 81039	34036 ⁸	OO	G63306	49162 ⁷
67	All	OO	82047	

VAN, PB 1000 SERIES

63-65	All	OO	G63355	61525 81039	34036 ⁸	OO	G63306	49162 ⁷
-------	-----	----	--------	------	----------------	------	--------------------	----	--------	------	------	------	--------------------

YUKON

15-20	4WD, Old Body Style		G57023 ⁴⁰
12-20	Old Body Style		OO	G64101	77975
12-14	Exc. Z55 or ZW7 Ride Suspension		G51891	G57125 ⁴⁰
07-14	Exc. Electronic Adjustable Suspension		143316 ⁵³
07-11	Exc. Z55 or ZW7 Ride Suspension		G51891	G57125 ⁴⁰	OO	G63866	58930 61675 77953 81930
00-11	4WD, Exc. Z55 Auto Ride Suspension		OO	49235 ⁷
	RWD		OO	49155 ⁷
00-06	Exc. Z55 Auto Ride Suspension		G63803	58803 61643 77803 81922	OO	G63866	58930 61675 77953 81930
00-05	4WD	OO	6853SE ⁸²
00	Denali		OO	G63896
92-99	All		OO	G63896	58638 61565 77638	43180 ⁸ 49231 ⁷
	RWD		G63489	58489 61544 77489 81668	34073 ⁸	OO	G63896	58638 61565 77638	43180 ⁸ 49231 ⁷
99	4WD	OO	G63609	58901 61542 77609 81726	6853SE ⁸²	OO	G63896	58638 61565 77638	43180 ⁸ 49231 ⁷
92-98	4WD	OO	G63609	58901 61542 77609 81726	OO	G63896	58638 61565 77638	43180 ⁸ 49231 ⁷

YUKON XL

19-20	4WD, Old Body Style		G57023 ⁴⁰
15-20	Old Body Style		OO	G64101	77975
15-18	4WD		G57023 ⁴⁰

YUKON XL 1/2 TON

12-14	All		OO	G64101
	Exc. Z55 Auto Ride Suspension		143316 ⁵³	OO	G64101

7 Pair Packs, Air hose kit included.



40 Complete Assembled Unit.

82 Use kit if listed, See Ref. C for optional Steering Stabilizer Boots.

8 Pair Packs.

53 Hardware from O.E. Part may need to be reused.













APPLICATION GUIDE

Year	Fitment Notes										
		Ultra	Ready Mounts	Max Control\ LTV Severe Duty\ ProGuard\ Guardian	Strut Cushion\ Strut Mount\ Dampers\ Stabilizer	HiJackers\ Load Carrier\ Classic	Ultra	Ready Mounts	Max Control\ LTV Severe Duty\ ProGuard\ Guardian	Strut Cushion\ Strut Mount\ Dampers\ Stabilizer	HiJackers\ Load Carrier\ Classic











GMC

GMC

YUKON XL 1/2 TON (cont)

12-14	Exc. Z55 or ZW7 Ride Suspension		G51891	G57125 ⁴⁰		G64101
07-11	Exc. Z55 Auto Ride Suspension		143316 ⁵³		G63866
	Exc. Z55 or ZW7 Ride Suspension		G51891	G57125 ⁴⁰		58930 61675 77953 81930
00-11	4WD, Exc. Z55 Auto Ride Suspension			49235 ⁷
	RWD			49155 ⁷
00-06	Exc. Z55 Auto Ride Suspension		G63803	58803 61643 77803 81922		G63866	58930 61675 77953 81930



























YUKON XL 3/4 TON

00-13	Exc. Z55 Auto Ride Suspension		81922	
00-11	Exc. Z55 Auto Ride Suspension and QuadraSteer			G63866	58930 61675 77953 81930
	4WD, Exc. Z55 Auto Ride Suspension			49235 ⁷
	RWD			49155 ⁷
00-06	Exc. Hydraulic Self-Leveling System		G63817	58817 61663 77817 81925	

HONDA

HONDA

ACCORD

15-17	All			G51892
13-14	Coupe			G511003
	Sedan			G51892
08-12	Left		G51877		G51892	G57419 ⁴⁰
	Right		G51878		G51892	G57419 ⁴⁰
	Automatic Left		G57207 ⁴⁰	
	Automatic Right		G57208 ⁴⁰	
	Manual Left		G57417 ⁴⁰	
	Manual Right		G57418 ⁴⁰	
03-12	Exc. Hybrid		142230 ⁵³		142230 ⁵³
03-07	Exc. Hybrid Models Left		G51737	G57054 ⁴⁰		G51738	G57056 ⁴⁰
	Exc. Hybrid Models Right		G51737	G57055 ⁴⁰		G51738	G57056 ⁴⁰
98-02	Left		G55870	G56991 ⁴⁰	M55870	142230 ⁵³ 143064 ⁵¹		G56943 ⁴⁰	M55871	142230 ⁵³ 142300 ⁶⁷ 143063 ⁵¹



7 Pair Packs, Air hose kit included.

51 Strut Cushion for use with the Strut/Cartridge/Shocks.

40 Complete Assembled Unit.

53 Hardware from O.E. Part may need to be reused.













APPLICATION GUIDE

Year	Fitment Notes										
		Ultra	Ready Mounts	Max Control\ LTV Severe Duty\ ProGuard\ Guardian	Strut Cushion\ Strut Mount\ Dampers\ Stabilizer	HiJackers\ Load Carrier\ Classic	Ultra	Ready Mounts	Max Control\ LTV Severe Duty\ ProGuard\ Guardian	Strut Cushion\ Strut Mount\ Dampers\ Stabilizer	HiJackers\ Load Carrier\ Classic





HONDA

HONDA





































ACCORD (cont)

98-02	Right		G55870	G56992 ⁴⁰	M55870	142230 ⁵³ 143064 ⁵¹		G56943 ⁴⁰	M55871	142230 ⁵³ 142300 ⁶⁷ 143063 ⁵¹
94-97	All		M55877	142230 ⁵³ 143064 ⁵¹		M55786	143063 ⁵¹
90-93	All		G55774	142230 ⁵³ 143064 ⁵¹		M55786	143063 ⁵¹
86-89	All		142230 ⁵³		143064 ⁵¹
82-85	All		142850 ⁵⁴		143059 ⁵¹
76-81	All		143059 ⁵¹	

CITY

10-12	Left		G52152		G51905
	Right		G52153		G51905

CIVIC

14-15	All			G511092
	Coupe Left		G57710 ⁴⁰		G511092
	Coupe Right		G57711 ⁴⁰		G511092
	Sedan Left w/ 14mm Lower Mounting Holes		G57712 ⁴⁰		G511092
	Sedan Right w/ 14mm Lower Mounting Holes		G57713 ⁴⁰		G511092
12-13	All			G511092	143530 ⁶⁷
	Coupe Left		G57710 ⁴⁰		G511092	143530 ⁶⁷
	Coupe Right		G57711 ⁴⁰		G511092	143530 ⁶⁷
	Sedan Left w/ 14mm Lower Mounting Holes		G57712 ⁴⁰		G511092	143530 ⁶⁷
	Sedan Right w/ 14mm Lower Mounting Holes		G57713 ⁴⁰		G511092	143530 ⁶⁷
06-11	All			G51807	143498 ⁶⁸
	Exc. GX & SI Models Left		G57390 ⁴⁰		G51807	143498 ⁶⁸
	Exc. GX & SI Models Right		G57391 ⁴⁰		G51807	143498 ⁶⁸
	Exc. SI and GX Left		G52038		G51807	143498 ⁶⁸
	Exc. SI and GX Right		G52039		G51807	143498 ⁶⁸
03-05	Left			G57061 ⁴⁰	142230 ⁵³
	Right			G57062 ⁴⁰	142230 ⁵³
	Coupe & Sedan Models Exc. Hybrid Left		G56677	

40 Complete Assembled Unit.

53 Hardware from O.E. Part may need to be reused.



67 Mount Kit. Hardware from O.E. Part may need to be reused.

51 Strut Cushion for use with the Strut/Cartridge/Shocks.

54 Kit with Mount and Bearing. Hardware from O.E. Part may need to be reused.

68 Mount Kit. Hardware from O.E. Part may need to be reused;















APPLICATION GUIDE

Year	Fitment Notes										
		Ultra	Ready Mounts	Max Control\ LTV Severe Duty\ ProGuard\ Guardian	Strut Cushion\ Strut Mount\ Dampers\ Stabilizer	HiJackers\ Load Carrier\ Classic	Ultra	Ready Mounts	Max Control\ LTV Severe Duty\ ProGuard\ Guardian	Strut Cushion\ Strut Mount\ Dampers\ Stabilizer	HiJackers\ Load Carrier\ Classic

HONDA

HONDA

CIVIC (cont)

03-05	Coupe & Sedan Models Exc. Hybrid Right		G56678
	Exc. Hybrid Models Left		G57049 ⁴⁰	143233 ⁶⁰	G51716
	Exc. Hybrid Models Right		G57050 ⁴⁰	143265 ⁶⁰	G51716
	Hybrid, Left		G56621	G57521 ⁴⁰	M56621
	Hybrid, Right		G56622	G57522 ⁴⁰	M56622
01-05	Base & Type S Models		143353 ⁵⁴
02	Left		G51700	G57032 ⁴⁰	142230 ⁵³
	Right		G51700	G57033 ⁴⁰	142230 ⁵³
	Exc. Hatchback Left		G56621	M56621
	Exc. Hatchback Right		G56622	M56622
	Exc. Hybrid Models Left		G57049 ⁴⁰	143233 ⁶⁰
	Exc. Hybrid Models Right		G57050 ⁴⁰	143265 ⁶⁰
01	Left		G56621	M56621	G51700	G57032 ⁴⁰	142230 ⁵³
	Right		G56622	M56622	G51700	G57033 ⁴⁰	142230 ⁵³
	Exc. Hybrid Models Left		G57049 ⁴⁰
	Exc. Hybrid Models Right		G57050 ⁴⁰
96-00	Left		G55909	G56996 ⁴⁰	142230 ⁵³	G55910	G56998 ⁴⁰	142230 ⁵³ 143064 ⁵¹
	Right		G55909	G56997 ⁴⁰	142230 ⁵³	G55910	G56998 ⁴⁰	142230 ⁵³ 143064 ⁵¹
92-95	Left		G56993 ⁴⁰	M55802 ⁴⁶	142230 ⁵³	G56995 ⁴⁰	M55803	142230 ⁵³ 142300 ⁶⁷ 143064 ⁵¹
	Right		G56994 ⁴⁰	M55802 ⁴⁶	142230 ⁵³	G56995 ⁴⁰	M55803	142230 ⁵³ 142300 ⁶⁷ 143064 ⁵¹
89-91	All		142230 ⁵³	142230 ⁵³ 142300 ⁶⁷ 143064 ⁵¹
88	All		142230 ⁵³	142230 ⁵³
85-87	4WD, Wagon		143057 ⁵¹

CIVIC DEL SOL

93-97	All		M55802 ⁴⁶	142230 ⁵³	M55803	142230 ⁵³ 142300 ⁶⁷ 143064 ⁵¹
-------	-----	-------------------------------------------------------------------------------------	------	------	----------------------	----------------------	------	------	------	------	--------	----------------------------------------------------------------------	------

40 Complete Assembled Unit.

51 Strut Cushion for use with the Strut/Cartridge/Shocks.

54 Kit with Mount and Bearing. Hardware from O.E. Part may need to be reused.



130 67 Mount Kit. Hardware from O.E. Part may need to be reused.

46 Upper Mount orientation may be required.

53 Hardware from O.E. Part may need to be reused.

60 Strut Mount Contains a Metal Bearing. Hardware from O.E. Part may need to be reused.



























APPLICATION GUIDE

Year	Fitment Notes										
		Ultra	Ready Mounts	Max Control\ LTV Severe Duty\ ProGuard\ Guardian	Strut Cushion\ Strut Mount\ Dampers\ Stabilizer	HiJackers\ Load Carrier\ Classic	Ultra	Ready Mounts	Max Control\ LTV Severe Duty\ ProGuard\ Guardian	Strut Cushion\ Strut Mount\ Dampers\ Stabilizer	HiJackers\ Load Carrier\ Classic



HONDA

CR-V





HONDA

15-16	AWD, Left		G57754⁴⁰		G51972	G57792⁴⁰
	AWD, Right		G57755⁴⁰		G51972	G57793⁴⁰
12-16	FWD, Left		G57479 ⁴⁰		G57597 ⁴⁰
	FWD, Right		G57480 ⁴⁰		G57598 ⁴⁰
13-14	Left		G52187		G51972
	Right		G52188		G51972
12-14	AWD, Left		G57601 ⁴⁰		G57599 ⁴⁰
	AWD, Right		G57602 ⁴⁰		G57600 ⁴⁰
12	Left		G52187		G51972	142230 ⁵³
	Right		G52188		G51972	142230 ⁵³
07-11	Left		G52187	G57331 ⁴⁰		G51879	G57416 ⁴⁰	142230 ⁵³
	Right		G52188	G57332 ⁴⁰		G51879	G57682 ⁴⁰	142230 ⁵³
03-06	Left		G56800		G51286	G57086 ⁴⁰	142230 ⁵³
	Right		G56799		G51286	G57087 ⁴⁰	142230 ⁵³
02-06	Automatic Left		G57084 ⁴⁰	
	Automatic Right		G57085 ⁴⁰	
	Base & Type S Models		143353 ⁵⁴	
02	Left		G56800		G51286	G57086 ⁴⁰
	Right		G56799		G51286	G57087 ⁴⁰
97-01	All		G51255	142230 ⁵³ 143064 ⁵¹		G51256	142230 ⁵³ 143064 ⁵¹





CR-Z

11-16	All			G511037
-------	-----	-------------------------------------------------------------------------------------	------	------	------	------	------	---------------------------------------------------------------------------------------	---------	------	------	------	------

CRX

89-91	All		142230 ⁵³ 143064 ⁵¹		M55803	142230 ⁵³
88	All		142230 ⁵³		142230 ⁵³ 143064 ⁵¹

ELEMENT

11	Left		G57222 ⁴⁰		G51858	G57424 ⁴⁰	142230 ⁵³
	Right		G57223 ⁴⁰		G51858	G57425 ⁴⁰	142230 ⁵³

40 Complete Assembled Unit.



53 Hardware from O.E. Part may need to be reused.

Bold Type - New / Future Part

51 Strut Cushion for use with the Strut/Cartridge/Shocks.

54 Kit with Mount and Bearing. Hardware from O.E. Part may need to be reused.













APPLICATION GUIDE

Year	Fitment Notes										
		Ultra	Ready Mounts	Max Control\ LTV Severe Duty\ ProGuard\ Guardian	Strut Cushion\ Strut Mount\ Dampers\ Stabilizer	HiJackers\ Load Carrier\ Classic	Ultra	Ready Mounts	Max Control\ LTV Severe Duty\ ProGuard\ Guardian	Strut Cushion\ Strut Mount\ Dampers\ Stabilizer	HiJackers\ Load Carrier\ Classic

















HONDA

HONDA



ELEMENT (cont)

11	Exc. SC Model Left		G52112	
	Exc. SC Model Right		G52113	
07-10	All		G51858	142230 ⁵³
	Exc. SC Model Left		G52112	G51858	142230 ⁵³
	Exc. SC Model Right		G52113	G51858	142230 ⁵³
	Exc. SC Submodel Left		G57222 ⁴⁰	G51858	G57424 ⁴⁰	142230 ⁵³
	Exc. SC Submodel Right		G57223 ⁴⁰	G51858	G57425 ⁴⁰	142230 ⁵³
03-06	Left		G57222 ⁴⁰	G51858	G57424 ⁴⁰	142230 ⁵³
	Right		G57223 ⁴⁰	G51858	G57425 ⁴⁰	142230 ⁵³
	Base & Type S Models		143353 ⁵⁴
	Exc. SC Model Left		G52112
	Exc. SC Model Right		G52113

FIT

15-16	Exc. EV Left		G52152
	Exc. EV Right		G52153
09-14	Exc. EV Left		G52152		G51905
	Exc. EV Right		G52153		G51905
09-13	Left		G57603 ⁴⁰
	Right		G57604 ⁴⁰
07-08	CAN Left		G52282
	CAN Right		G52283
	USA Left		G52282
	USA Right		G52283
06-08	Left		G57541 ⁴⁰		70060
	Right		G57542 ⁴⁰		70060



INSIGHT

10-14	Left		G52152	G57603 ⁴⁰
	Right		G52153	G57604 ⁴⁰

40 Complete Assembled Unit.

53 Hardware from O.E. Part may need to be reused.















APPLICATION GUIDE

Year	Fitment Notes										
		Ultra	Ready Mounts	Max Control\ LTV Severe Duty\ ProGuard\ Guardian	Strut Cushion\ Strut Mount\ Dampers\ Stabilizer	HiJackers\ Load Carrier\ Classic	Ultra	Ready Mounts	Max Control\ LTV Severe Duty\ ProGuard\ Guardian	Strut Cushion\ Strut Mount\ Dampers\ Stabilizer	HiJackers\ Load Carrier\ Classic





HONDA

ODYSSEY





















HONDA

12-17	From Chassis/VIN CB088499		143305 ⁵⁴	
08-10	Left		G52253	G57564 ⁴⁰	143305 ⁵⁴		70010
	Right		G52254	G57565 ⁴⁰	143305 ⁵⁴		70010
05-07	Left		G57137 ⁴⁰	143305 ⁵⁴		70010
	Right		G57138 ⁴⁰	143305 ⁵⁴		70010
99-04	Left		G57011 ⁴⁰	M56559	143061 ⁵¹ 143315 ⁵⁴		69909
	Right		G57012 ⁴⁰	M56558	143061 ⁵¹ 143315 ⁵⁴		69909
95-98	All		G57557 ⁴⁰	M55877	142230 ⁵³ 143064 ⁵¹		G55821	142230 ⁵³ 143063 ⁵¹









PASSPORT

98-02	All		G63611	61593 81872		G63710	81911
94-97	All		G63611	61593 81872		G63610	61592 81937



PILOT

10-15	Left		G52360	G57695 ⁴⁰		G64104	
	Right		G52361	G57696 ⁴⁰		G64104	
09	Left		G52360		G64104	
	Right		G52361		G64104	
06-08	FWD, Left		G57605 ⁴⁰		
	FWD, Right		G57606 ⁴⁰		
03-08	Left		G56759	143315 ⁵⁴		G64003	61704	49236 ⁷
	Right		G56758	143315 ⁵⁴		G64003	61704	49236 ⁷
	AWD, Left		G57119 ⁴⁰		
	AWD, Right		G57120 ⁴⁰		

PRELUDE

92-01	All		142230 ⁵³ 143064 ⁵¹		143064 ⁵¹
88-91	All		142230 ⁵³ 143064 ⁵¹	
83-87	All		142230 ⁵³ 143059 ⁵¹		143059 ⁵¹
79-82	All		143059 ⁵¹	

RIDGELINE

06-14	Left		G52150	G57333 ⁴⁰		G51880	G57414 ⁴⁰	142230 ⁵³
-------	------	-------------------------------------------------------------------------------------	--------	----------------------	------	------	------	---------------------------------------------------------------------------------------	--------	----------------------	------	----------------------	------

7 Pair Packs, Air hose kit included.





51 Strut Cushion for use with the Strut/Cartridge/Shocks.

54 Kit with Mount and Bearing. Hardware from O.E. Part may need to be reused.

40 Complete Assembled Unit.

53 Hardware from O.E. Part may need to be reused.



APPLICATION GUIDE

Year	Fitment Notes										
		 Ultra	Ready Mounts	Max Control\ LTV Severe Duty\ ProGuard\ Guardian	Strut Cushion\ Strut Mount\ Dampers\ Stabilizer	HiJackers\ Load Carrier\ Classic	 Ultra	Ready Mounts	Max Control\ LTV Severe Duty\ ProGuard\ Guardian	Strut Cushion\ Strut Mount\ Dampers\ Stabilizer	HiJackers\ Load Carrier\ Classic





HONDA

HONDA

RIDGELINE (cont)

06-14	Right		G52151	G57334 ⁴⁰		G51880	G57415 ⁴⁰	142230 ⁵³
-------	-------	-----------------------------------------------------------------------------------	--------	----------------------	------	------	------	-----------------------------------------------------------------------------------	--------	----------------------	------	----------------------	------



S2000

08-09	All			142230 ⁵³
00-07	All		142230 ⁵³		142230 ⁵³





HUMMER

HUMMER

H2

03-09	All		G63817	61663 77817		G64000
-------	-----	-----------------------------------------------------------------------------------	--------	------	----------------	------	------	-----------------------------------------------------------------------------------	--------	------	------	------	------



























H3

06-10	All		G64001		G63965
	w/ Off Road Package		G64001		G63965	77983







HYUNDAI

HYUNDAI

ACCENT

12-17	Left		G52353		70095
	Right		G52354		70095
06-11	Left		G52154	G57275 ⁴⁰	143409 ⁵⁴		70036	142419 ⁶⁸
	Right		G52155	G57276 ⁴⁰	143410 ⁵⁴		70036	142419 ⁶⁸
00-05	Left		G57268 ⁴⁰	143059 ⁵¹		G57278 ⁴⁰
	Right		G57269 ⁴⁰	143059 ⁵¹		G57279 ⁴⁰
98-05	All		143059 ⁵¹	
	Left Gas Charged Unit		143059 ⁵¹		G52333
	Right Gas Charged Unit		143059 ⁵¹		G52334
97	Left Gas Charged Unit			G52333
	Mfg. to 6/97			143059 ⁵¹
	Right Gas Charged Unit			G52334
95-96	All		143059 ⁵¹		143059 ⁵¹

AZERA

12-17	Left		G52437		70068
	Right		G52438		70068
11	All		G57149 ⁴⁰	143342 ⁶⁸		70013



40 Complete Assembled Unit.

53 Hardware from O.E. Part may need to be reused.

51 Strut Cushion for use with the Strut/Cartridge/Shocks.

54 Kit with Mount and Bearing. Hardware from O.E. Part may need to be reused.



APPLICATION GUIDE

Year	Fitment Notes										
		Ultra	Ready Mounts	Max Control\ LTV Severe Duty\ ProGuard\ Guardian	Strut Cushion\ Strut Mount\ Dampers\ Stabilizer	HiJackers\ Load Carrier\ Classic	Ultra	Ready Mounts	Max Control\ LTV Severe Duty\ ProGuard\ Guardian	Strut Cushion\ Strut Mount\ Dampers\ Stabilizer	HiJackers\ Load Carrier\ Classic

HYUNDAI

HYUNDAI

AZERA (cont)

06-10	All		G51806	G57149 ⁴⁰	143342 ⁶⁸		70013	143386 ⁶³
-------	-----	-----------------------------------------------------------------------------------	--------	----------------------	------	----------------------	------	-------------------------------------------------------------------------------------	-------	------	------	----------------------	------

ELANTRA



14-16	All			70098
	Limited, SE, Left Mfg. to 10/16		G57742 ⁴⁰		70098
	Limited, SE, Right Mfg. to 10/16		G57743 ⁴⁰		70098
12-13	Left		G52439		70098
	Right		G52440		70098
13	GLS, Limited, Left		G57742 ⁴⁰	
	GLS, Limited, Right		G57743 ⁴⁰	
12	Sedan Left		G57803 ⁴⁰	
	Sedan Right		G57804 ⁴⁰	
11	All		143477 ⁶⁸		70098
	Sedan Left		G57803 ⁴⁰	143477 ⁶⁸		70098
	Sedan Right		G57804 ⁴⁰	143477 ⁶⁸		70098
07-10	Left		G52156	G57393 ⁴⁰	143477 ⁶⁸	
	Right		G52157	G57394 ⁴⁰	143477 ⁶⁸	
	Exc. Touring Models			70037
01-06	Left		G56539	142625 ⁵³		G56640	G57167 ⁴⁰
	Right		G56540	142625 ⁵³		G56641	G57168 ⁴⁰
	Automatic Left		G57088 ⁴⁰	
	Automatic Right		G57089 ⁴⁰	
96-00	All		142625 ⁵³	
	Left Gas Charged Unit		142625 ⁵³		G52335
	Right Gas Charged Unit		142625 ⁵³		G52336
00	Left		142625 ⁵³		G57167 ⁴⁰
	Left Mfg. from 5/00		G56539	142625 ⁵³		G56640
	Right		142625 ⁵³		G57168 ⁴⁰
	Right Mfg. from 5/00		G56540	142625 ⁵³		G56641
	Automatic Left		G57088 ⁴⁰	142625 ⁵³	

40 Complete Assembled Unit.

53 Hardware from O.E. Part may need to be reused.

68 Mount Kit. Hardware from O.E. Part may need to be reused.;

APPLICATION GUIDE

Year	Fitment Notes										
		Ultra	Ready Mounts	Max Control\ LTV Severe Duty\ ProGuard\ Guardian	Strut Cushion\ Strut Mount\ Dampers\ Stabilizer	HiJackers\ Load Carrier\ Classic	Ultra	Ready Mounts	Max Control\ LTV Severe Duty\ ProGuard\ Guardian	Strut Cushion\ Strut Mount\ Dampers\ Stabilizer	HiJackers\ Load Carrier\ Classic

HYUNDAI

HYUNDAI

ELANTRA (cont)

00	Automatic Right	↓	G57089 ⁴⁰	142625 ⁵³	↓
92-95	Non-ABS	↓	142240 ⁵⁴ 143057 ⁵¹	↓	142419 ⁶⁸

ELANTRA GT

14-17	Left Models w/ 16" or 17" Wheels; Mfg to 10/16	↓	G57740 ⁴⁰	↓
	Right Models w/ 16" or 17" Wheels; Mfg to 10/16	↓	G57741 ⁴⁰	↓

ENTOURAGE

09	All	↓	143416 ⁵⁴	↓
07-08	Left	↓	G52257	G57487 ⁴⁰	143416 ⁵⁴	↓	G64071
	Right	↓	G52258	G57488 ⁴⁰	143416 ⁵⁴	↓	G64071

EXCEL

90-94	All	↓	143057 ⁵¹	↓
86-89	All	↓	143059 ⁵¹	↓

SANTA FE

13-16	Left	↓	G57756 ⁴⁰	↓
	Right	↓	G57757 ⁴⁰	↓
	FWD	↓	↓	G64143
10-11	All	↓	143416 ⁵⁴	↓
07-09	Left	↓	G52158	G57471 ⁴⁰	143416 ⁵⁴	↓	G64048
	Right	↓	G52159	G57472 ⁴⁰	143416 ⁵⁴	↓	G64048
05-06	Left	↓	G56562	G57139 ⁴⁰	↓	69907
	Right	↓	G56561	G57140 ⁴⁰	↓	69907
01-04	Left	↓	G56562	G57139 ⁴⁰	143087 ⁵³	↓	69907
	Right	↓	G56561	G57140 ⁴⁰	143087 ⁵³	↓	69907

SONATA

11-14	All	↓	↓	70068
11	Mfg. to 7/22/10 Exc. Hybrid Left	↓	G52329	↓	70068
	Mfg. to 7/22/10 Exc. Hybrid Right	↓	G52330	↓	70068
06-10	All	↓	G51806	143342 ⁶⁸	↓	70013	143386 ⁵³
	2.4L	↓	G51806	G57149 ⁴⁰	143342 ⁶⁸	↓	70013	143386 ⁵³



40 Complete Assembled Unit.

53 Hardware from O.E. Part may need to be reused.

51 Strut Cushion for use with the Strut/Cartridge/Shocks.

54 Kit with Mount and Bearing. Hardware from O.E. Part may need to be reused.



















APPLICATION GUIDE

Year	Fitment Notes										
		Ultra	Ready Mounts	Max Control\ LTV Severe Duty\ ProGuard\ Guardian	Strut Cushion\ Strut Mount\ Dampers\ Stabilizer	HiJackers\ Load Carrier\ Classic	Ultra	Ready Mounts	Max Control\ LTV Severe Duty\ ProGuard\ Guardian	Strut Cushion\ Strut Mount\ Dampers\ Stabilizer	HiJackers\ Load Carrier\ Classic







HYUNDAI

HYUNDAI











SONATA (cont)

01-05	Left		G51714	G57059 ⁴⁰	142419 ⁶⁸		G51713	G57090 ⁴⁰	142419 ⁶⁸
	Right		G51714	G57059 ⁴⁰	142419 ⁶⁸		G51713	G57091 ⁴⁰	142419 ⁶⁸
00	All		G56565	G57059 ⁴⁰	142419 ⁶⁸		142419 ⁶⁸
	Left		G56565	G57059 ⁴⁰	142419 ⁶⁸		G57090 ⁴⁰	142419 ⁶⁸
	Mfg. from 4/00		G56565	G57059 ⁴⁰	142419 ⁶⁸		G51713	142419 ⁶⁸
	Mfg. from 8/00		G51714	G57059 ⁴⁰	142419 ⁶⁸		142419 ⁶⁸
	Right		G56565	G57059 ⁴⁰	142419 ⁶⁸		G57091 ⁴⁰	142419 ⁶⁸
99	All		G56565	
89-94	All			143057 ⁵¹



TIBURON

03-08	Left		G56642	G57398 ⁴⁰	143397 ⁶⁸		G57400 ⁴⁰
	Right		G56643	G57399 ⁴⁰	143397 ⁶⁸		G57401 ⁴⁰
97-01	All		142625 ⁵³	





TUCSON

10-15	Left		G57758 ⁴⁰	
	Right		G57759 ⁴⁰	
	AWD			G64216
05-09	Left		G56819	G57218 ⁴⁰	143087 ⁵³		G56822	G57343 ⁴⁰
	Right		G56820	G57219 ⁴⁰	143087 ⁵³		G56821	G57344 ⁴⁰



VELOSTER

12-17	All			G70095
-------	-----	-------------------------------------------------------------------------------------	------	------	------	------	------	---------------------------------------------------------------------------------------	--------	------	------	------	------



VERACRUZ

12	All			G64048
07-11	All		143416 ⁵⁴		G64048

XG300

01	All		G51899		G51713	142419 ⁶⁸
----	-----	-------------------------------------------------------------------------------------	--------	------	------	------	------	---------------------------------------------------------------------------------------	--------	------	------	----------------------	------

XG350

02-05	All		G51899		G51713	142419 ⁶⁸
-------	-----	-------------------------------------------------------------------------------------	--------	------	------	------	------	---------------------------------------------------------------------------------------	--------	------	------	----------------------	------

40 Complete Assembled Unit.



53 Hardware from O.E. Part may need to be reused.

68 Mount Kit. Hardware from O.E. Part may need to be reused.;

51 Strut Cushion for use with the Strut/Cartridge/Shocks.

54 Kit with Mount and Bearing. Hardware from O.E. Part may need to be reused.

APPLICATION GUIDE

Year	Fitment Notes										
		Ultra	Ready Mounts	Max Control\ LTV Severe Duty\ ProGuard\ Guardian	Strut Cushion\ Strut Mount\ Dampers\ Stabilizer	HiJackers\ Load Carrier\ Classic	Ultra	Ready Mounts	Max Control\ LTV Severe Duty\ ProGuard\ Guardian	Strut Cushion\ Strut Mount\ Dampers\ Stabilizer	HiJackers\ Load Carrier\ Classic

INFINITI

FX35

03-08	All	↓	142937 ⁵⁴	↓
-------	-----	---	------	------	------	----------------------	------	---	------	------	------	------	------

FX45

03-08	All	↓	142937 ⁵⁴	↓
-------	-----	---	------	------	------	----------------------	------	---	------	------	------	------	------

G20

91-96	Left	↓	G56591	142547 ⁵³ 143057 ⁵¹	↓	G56512
	Right	↓	G56591	142547 ⁵³ 143057 ⁵¹	↓	G56513

G25

11-12	AWD, Left	↓	G511019	↓
	AWD, Right	↓	G511020	↓

G35

08	AWD, Left Exc. 4 Wheel Steer	↓	G511019	↓
	AWD, Right Exc. 4 Wheel Steer	↓	G511020	↓
07	All	↓	143455 ⁶⁸	↓
	AWD, Left Exc. 4 Wheel Steer	↓	G511019	143455 ⁶⁸	↓
	AWD, Right Exc. 4 Wheel Steer	↓	G511020	143455 ⁶⁸	↓
	Coupe Left Sport Suspension	↓	G51813	143455 ⁶⁸	↓
	Coupe Right Sport Suspension	↓	G51814	143455 ⁶⁸	↓
	Coupe Sport Suspension	↓	↓	G51812
05-06	AWD, Left	↓	G51979	143455 ⁶⁸	↓
	AWD, Right	↓	G51981	143455 ⁶⁸	↓
	Coupe Left Sport Suspension	↓	G51813	↓
	Coupe Right Sport Suspension	↓	G51814	↓
	Coupe Sport Suspension	↓	↓	G51812
03-04	All	↓	143455 ⁶⁸	↓
	Coupe Left Sport Suspension	↓	G51813	143455 ⁶⁸	↓
	Coupe Right Sport Suspension	↓	G51814	143455 ⁶⁸	↓
	Coupe Sport Suspension	↓	143455 ⁶⁸	↓	G51812



G37

09-13	AWD, Left Exc. 4 Wheel Steer	↓	G511019	↓
	AWD, Right Exc. 4 Wheel Steer	↓	G511020	↓

51 Strut Cushion for use with the Strut/Cartridge/Shocks.









53 Hardware from O.E. Part may need to be reused.

APPLICATION GUIDE









Year	Fitment Notes										
		Ultra	Ready Mounts	Max Control\ LTV Severe Duty\ ProGuard\ Guardian	Strut Cushion\ Strut Mount\ Dampers\ Stabilizer	HiJackers\ Load Carrier\ Classic	Ultra	Ready Mounts	Max Control\ LTV Severe Duty\ ProGuard\ Guardian	Strut Cushion\ Strut Mount\ Dampers\ Stabilizer	HiJackers\ Load Carrier\ Classic

INFINITI





I30

00-01	Left		G56683	G57165 ⁴⁰	142937 ⁵⁴		G51727	G57159 ⁴⁰
	Right		G56684	G57166 ⁴⁰	142937 ⁵⁴		G51727	G57160 ⁴⁰
96-99	Left		M55913	142546 ⁵⁴		G51087	G57057 ⁴⁰	142547 ⁵³
	Right		M55912	142546 ⁵⁴		G51087	G57058 ⁴⁰	142547 ⁵³





I35

04	Left		G56685	142937 ⁵⁴		G51727	G57159 ⁴⁰
	Right		G56686	142937 ⁵⁴		G51727	G57160 ⁴⁰
02-03	Left		G56685	G57157 ⁴⁰	142937 ⁵⁴		G51727	G57159 ⁴⁰
	Right		G56686	G57158 ⁴⁰	142937 ⁵⁴		G51727	G57160 ⁴⁰





M35

06-07	RWD, Left		G51925	143455 ⁵⁸	
	RWD, Right		G51926	143455 ⁵⁸	





















M45

06-07	Left		G51925	
	Right		G51926	

Q45

97-01	All			G51930
	Exc. Active Suspension		143210 ⁵³		G51930

QX4

02-03	Left		G56687	G57144 ⁴⁰	142938 ⁵³	
	Right		G56688	G57145 ⁴⁰	142938 ⁵³	
99-03	Mfg. from 12/98		142938 ⁵³		G63845
98-03	All		142938 ⁵³	
99-01	Left Mfg. from 12/98		G56615	142938 ⁵³	
	Right Mfg. from 12/98		G56616	142938 ⁵³	
98-99	Mfg. to 11/98 Left		G57037 ⁴⁰	142938 ⁵³	
	Mfg. to 11/98 Right		G57038 ⁴⁰	142938 ⁵³	
99	Mfg. to 12/98		142938 ⁵³		61609
97-98	Mfg. to 12/98		142938 ⁵³		G63712	61609 81910



40 Complete Assembled Unit.

54 Kit with Mount and Bearing. Hardware from O.E. Part may need to be reused.

53 Hardware from O.E. Part may need to be reused.

68 Mount Kit. Hardware from O.E. Part may need to be reused.;

APPLICATION GUIDE

Year	Fitment Notes										
		Ultra	Ready Mounts	Max Control\ LTV Severe Duty\ ProGuard\ Guardian	Strut Cushion\ Strut Mount\ Dampers\ Stabilizer	HiJackers\ Load Carrier\ Classic	Ultra	Ready Mounts	Max Control\ LTV Severe Duty\ ProGuard\ Guardian	Strut Cushion\ Strut Mount\ Dampers\ Stabilizer	HiJackers\ Load Carrier\ Classic

INFINITI

INFINITI

QX4 (cont)

97	All	⌄	142938 ⁵³	⊖	G63712	81910
	Mfg. to 11/98 Left	⌄	G57037 ⁴⁰	142938 ⁵³	⊖	G63712	81910
	Mfg. to 11/98 Right	⌄	G57038 ⁴⁰	142938 ⁵³	⊖	G63712	81910

QX56

04-10	All	⌄	G51715	143358 ⁵³ 143359 ⁶⁷	⊖
	4WD	⌄	G51715	G57092 ⁴⁰	143358 ⁵³ 143359 ⁶⁷	⊖
05-07	Exc. Air-Leveling Suspension	⌄	G51715	143358 ⁵³ 143359 ⁶⁷	⊖	G63875

QX60

16-20	All	⌄	⊖	G511043
-------	-----	---	------	------	------	------	------	---	---------	------	------	------	------

INTERNATIONAL

INTERNATIONAL

100

74	All models with factory frame bracket. Kit 143168 required to install to linkage.	⊖	6802SE ⁸⁴	⊖
----	-----------------------------------------------------------------------------------	---	------	------	------	----------------------	------	---	------	------	------	------	------

150

75	All models with factory frame bracket. Kit 143168 required to install to linkage.	⊖	6802SE ⁸⁴	⊖
----	-----------------------------------------------------------------------------------	---	------	------	------	----------------------	------	---	------	------	------	------	------

200

74-75	All models with factory frame bracket. Kit 143168 required to install to linkage.	⊖	6802SE ⁸⁴	⊖
-------	-----------------------------------------------------------------------------------	---	------	------	------	----------------------	------	---	------	------	------	------	------

908C

69	Single System Steering Stabilizer; 1/2 Ton, 3/4 Ton & Travelall	⊖	6802SE ⁸⁴	⊖
68	All	⊖	82007	⊖	G63405	61500 81147	43048 ⁸ 49310 ⁷
	Single System Steering Stabilizer; 1/2 Ton, 3/4 Ton & Travelall	⊖	6802SE ⁸⁴	82007	⊖	G63405	61500 81147	43048 ⁸ 49310 ⁷

1000C

68	All	⊖	⊖	61500 81147	43048 ⁸ 49310 ⁷
	Exc. 166" Wheelbase	⊖	⊖	G63405	61500 81147	43048 ⁸ 49310 ⁷
	Single System Steering Stabilizer; 1/2 Ton, 3/4 Ton & Travelall	⊖	6802SE ⁸⁴	⊖	61500 81147	43048 ⁸ 49310 ⁷

1000D

69-70	Single System Steering Stabilizer; 1/2 Ton, 3/4 Ton & Travelall	⊖	6802SE ⁸⁴	⊖
-------	-----------------------------------------------------------------	---	------	------	------	----------------------	------	---	------	------	------	------	------

1010

71-73	Single System Steering Stabilizer; 1/2 Ton, 3/4 Ton & Travelall	⊖	6802SE ⁸⁴	⊖
-------	-----------------------------------------------------------------	---	------	------	------	----------------------	------	---	------	------	------	------	------

1100C

68	All	⊖	82007	⊖
	Exc. 166" Wheelbase	⊖	G63405	61500 81147	43048 ⁸ 82007	⊖	G63405	61500 81147	43048 ⁸ 49310 ⁷

7 Pair Packs, Air hose kit included.

40 Complete Assembled Unit.



140 67 Mount Kit. Hardware from O.E. Part may need to be reused.

8 Pair Packs.

53 Hardware from O.E. Part may need to be reused.

84 Replacement damper for vehicles with the Gabriel Aftermarket mounting kit

APPLICATION GUIDE

Year	Fitment Notes										
		Ultra	Ready Mounts	Max Control\ LTV Severe Duty\ ProGuard\ Guardian	Strut Cushion\ Strut Mount\ Dampers\ Stabilizer	HiJackers\ Load Carrier\ Classic	Ultra	Ready Mounts	Max Control\ LTV Severe Duty\ ProGuard\ Guardian	Strut Cushion\ Strut Mount\ Dampers\ Stabilizer	HiJackers\ Load Carrier\ Classic

INTERNATIONAL

1100C (cont)

68	Single System Steering Stabilizer; 1/2 Ton, 3/4 Ton & Travelall	O	6802SE ⁸⁴	82007
----	-----------------------------------------------------------------	---	------	------	------	----------------------	-------	------	------	------	------	------

1100D

69-70	Single System Steering Stabilizer; 1/2 Ton, 3/4 Ton & Travelall	O	6802SE ⁸⁴
-------	-----------------------------------------------------------------	---	------	------	------	----------------------	------	------	------	------	------	------

1110

71-73	Single System Steering Stabilizer; 1/2 Ton, 3/4 Ton & Travelall	O	6802SE ⁸⁴
-------	-----------------------------------------------------------------	---	------	------	------	----------------------	------	------	------	------	------	------

1200C

68	Exc. 166" Wheelbase	O	G63405	61500 81147	43048 ⁸ 82007	O	G63405	61500 81147	43048 ⁸ 49310 ⁷
	Single System Steering Stabilizer; 1/2 Ton, 3/4 Ton & Travelall	O	6802SE ⁸⁴

1200D

69-70	Single System Steering Stabilizer; 1/2 Ton, 3/4 Ton & Travelall	O	6802SE ⁸⁴
-------	-----------------------------------------------------------------	---	------	------	------	----------------------	------	------	------	------	------	------

1210

71-73	Single System Steering Stabilizer; 1/2 Ton, 3/4 Ton & Travelall	O	6802SE ⁸⁴
-------	-----------------------------------------------------------------	---	------	------	------	----------------------	------	------	------	------	------	------

1300C

68	Exc. 166" Wheelbase	O	G63405	61500 81147	43048 ⁸ 82007	O	G63405	61500 81147	43048 ⁸ 49310 ⁷
	Single System Steering Stabilizer; 1/2 Ton, 3/4 Ton & Travelall	O	6802SE ⁸⁴

1300D

69-70	Single System Steering Stabilizer; 1/2 Ton, 3/4 Ton & Travelall	O	6802SE ⁸⁴
-------	-----------------------------------------------------------------	---	------	------	------	----------------------	------	------	------	------	------	------

1310

71-73	Single System Steering Stabilizer; 1/2 Ton, 3/4 Ton & Travelall	O	6802SE ⁸⁴
-------	-----------------------------------------------------------------	---	------	------	------	----------------------	------	------	------	------	------	------

M800

68-71	Single System Steering Stabilizer; 1/2 & 3/4 Ton with I-Beam Axle	O	6802SE ⁸⁴
-------	-------------------------------------------------------------------	---	------	------	------	----------------------	------	------	------	------	------	------

M1100 / M1200

68-72	All	O	81318	82007	O	G63405	61500 81147	43048 ⁸ 49310 ⁷
	Single System Steering Stabilizer; 1/2 & 3/4 Ton with I-Beam Axle	O	81318	6802SE ⁸⁴	82007	O	G63405	61500 81147	43048 ⁸ 49310 ⁷

M1400

69	All	O	82007	O	G63405	61500 81147	43048 ⁸ 49310 ⁷
	Single System Steering Stabilizer; 1/2 & 3/4 Ton with I-Beam Axle	O	6802SE ⁸⁴	82007	O	G63405	61500 81147	43048 ⁸ 49310 ⁷

SCOUT

69-71	Single System Steering Stabilizer	O	6803SE ⁸⁴	82007	I	82039
61-71	All	O	82007	I	82039
61-68	Single System Steering Stabilizer; 4WD; Scout 80, 800	O	6802SE ⁸⁴	82007	I	82039

SCOUT II



71-80	All	I	G63350	61518 81242	43099 ⁸
	Single System Steering Stabilizer	I	G63350	61518 81242	6803SE ⁸⁴	43099 ⁸

7 Pair Packs, Air hose kit included.

8 Pair Packs.

84 Replacement damper for vehicles with the Gabriel Aftermarket mounting kit

APPLICATION GUIDE

Year	Fitment Notes										
		Ultra	Ready Mounts	Max Control\ LTV Severe Duty\ ProGuard\ Guardian	Strut Cushion\ Strut Mount\ Dampers\ Stabilizer	HiJackers\ Load Carrier\ Classic	Ultra	Ready Mounts	Max Control\ LTV Severe Duty\ ProGuard\ Guardian	Strut Cushion\ Strut Mount\ Dampers\ Stabilizer	HiJackers\ Load Carrier\ Classic

INTERNATIONAL TRAVELALL

75	RWD. All models with factory frame bracket. Kit 143168 required to install to linkage.	○	6802SE ⁸⁴
	Single System Steering Stabilizer	○	6803SE ⁸⁴

INTERNATIONAL

ISUZU

ISUZU

AMIGO

98-00	All	○	G63611	61593 81872	○	G63710	81911
89-94	All	○	G63909	61508 77909 81507	○	G63928	61506 81318	49311 ⁷

ASCENDER

03-08	All	↓	G51718 ⁴⁵	G57022 ⁴⁰	143241 ⁵³	↓
	Coil(RearSpringType)	↓	G51718 ⁴⁵	G57022 ⁴⁰	143241 ⁵³	○	G63842	61717

AXIOM

02-04	All	○	G63611	61593 81872	○	G63710	81911
-------	-----	---	--------	------	----------------	------	------	---	--------	------	-------	------	------

HOMBRE

98-00	RWD, Exc. Sport Chassis	○	G63421	58421 61504 81750	34051 ⁸	○	G63422	58422 61528 77422 81482	43162 ⁸ 49213 ⁷
96-00	All	○	○	G63422	58422 61528 77422 81482	43162 ⁸ 49213 ⁷
00	Sport Chassis	○	58423	○	G63422	58422 61528 77422 81482	43162 ⁸ 49213 ⁷
	4WD	○	G63423	61531 77423 81516	○	G63422	58422 61528 77422 81482	43162 ⁸ 49213 ⁷
99	Sport Chassis	○	G63423	58423	○	G63422	58422 61528 77422 81482	43162 ⁸ 49213 ⁷
	4WD	○	61531 77423 81516	○	G63422	58422 61528 77422 81482	43162 ⁸ 49213 ⁷
96-98	Sport Chassis	○	G63423	58423 61531 77423 81516	○	G63422	58422 61528 77422 81482	43162 ⁸ 49213 ⁷
96-97	RWD, Exc. Sport Chassis	○	G63421	58421 61504 81750	○	G63422	58422 61528 77422 81482	43162 ⁸ 49213 ⁷
	RWD; Exc. Sport Chassis	○	34051 ⁸	○	G63422	58422 61528 77422 81482	43162 ⁸ 49213 ⁷

I-280

06	All	○	○	43162 ⁸ 49213 ⁷
	Torsion Bar (FrontSpringType)	○	○	G63879	43162 ⁸ 49213 ⁷
	Coil(FrontSpringType)	○	○	G63882	77422	43162 ⁸ 49213 ⁷

7 Pair Packs, Air hose kit included.

40 Complete Assembled Unit.



142 53 Hardware from O.E. Part may need to be reused.

8 Pair Packs.

45 Strut must be rotated to align notch with lower control arm.

84 Replacement damper for vehicles with the Gabriel Aftermarket mounting kit

APPLICATION GUIDE

Year	Fitment Notes										
		Ultra	Ready Mounts	Max Control\ LTV Severe Duty\ ProGuard\ Guardian	Strut Cushion\ Strut Mount\ Dampers\ Stabilizer	HiJackers\ Load Carrier\ Classic	Ultra	Ready Mounts	Max Control\ LTV Severe Duty\ ProGuard\ Guardian	Strut Cushion\ Strut Mount\ Dampers\ Stabilizer	HiJackers\ Load Carrier\ Classic

ISUZU

ISUZU

I-280 (cont)

06	RWD, Coil(FrontSpringType)	77422	43162 ⁸ 49213 ⁷
	RWD, Coil(FrontSpringType) Exc. Z71 Off Road Package	G51850	43162 ⁸ 49213 ⁷

I-290

07-08	All	43162 ⁸ 49213 ⁷
	Coil(FrontSpringType)	G63882	43162 ⁸ 49213 ⁷
	RWD, Coil(FrontSpringType) Exc. Z71 Off Road Package	G51850	43162 ⁸ 49213 ⁷

I-350

06	Torsion Bar(FrontSpringType)	G63884
----	------------------------------	--------	-------	-------	-------	-------	-------	-------	-------	-------	-------

I-370

07-08	All	43162 ⁸ 49213 ⁷
08	Coil(FrontSpringType)	G63882	43162 ⁸ 49213 ⁷
	RWD, Coil(FrontSpringType) Exc. Z71 Off Road Package	G51850	43162 ⁸ 49213 ⁷
07	RWD	G51850	43162 ⁸ 49213 ⁷

IMPULSE

90-92	All	143058 ⁵¹	143061 ⁵¹
	Exc. Lotus Suspension	142317 ⁵³ 143058 ⁵¹	143061 ⁵¹
83-89	All	81340	43140 ⁸

OASIS

96-99	All	G57557 ⁴⁰	M55877	142230 ⁵³ 143064 ⁵¹	G55821	142230 ⁵³ 143063 ⁵¹
-------	-----	-------	----------------------	--------	----------------------------------------------	-------	-------	--------	-------	-------	----------------------------------------------	-------

PICKUP

81-95	All	61506 81318	49311 ⁷
	4WD	G63909	61508 77909 81507	G63928	61506 81318	49311 ⁷
	RWD	G63902	61501 81478	G63492	61506 81318	49311 ⁷

RODEO

98-04	All	G63611	61593 81872	G63710	81911
91-97	All	G63611	61593 81872	G63610	61592 81937

STYLUS

91-93	All	143058 ⁵¹	143061 ⁵¹
	Exc. Lotus Suspension	142317 ⁵³ 143058 ⁵¹	143061 ⁵¹

TROOPER

92-02	All	G63707	G63708	61608
-------	-----	--------	-------	-------	-------	-------	-------	--------	-------	-------	-------	-------

7 Pair Packs, Air hose kit included.





40 Complete Assembled Unit.

53 Hardware from O.E. Part may need to be reused.

8 Pair Packs.

51 Strut Cushion for use with the Strut/Cartridge/Shocks.





APPLICATION GUIDE

Year	Fitment Notes										
		 Ultra	Ready Mounts	Max Control\ LTV Severe Duty\ ProGuard\ Guardian	Strut Cushion\ Strut Mount\ Dampers\ Stabilizer	HiJackers\ Load Carrier\ Classic	 Ultra	Ready Mounts	Max Control\ LTV Severe Duty\ ProGuard\ Guardian	Strut Cushion\ Strut Mount\ Dampers\ Stabilizer	HiJackers\ Load Carrier\ Classic



ISUZU

ISUZU

TROOPER (cont)

89-91	4WD		G63495	61593 81553	
84-91	Single System Steering Stabilizer		6802SE ⁸⁴	
87-88	4WD		G63495	61593 81553	82066	
84-86	4WD		G63909	61508 77909 81507	G63928	61506 81318	49311 ⁷



VEHICROSS

99-01	All		G63707		G63708	61608
-------	-----	-----------------------------------------------------------------------------------	--------	------	------	------	------	-----------------------------------------------------------------------------------	--------	------	-------	------	------



JAGUAR

JAGUAR



S TYPE

00-05	Mfg. to 6/02 Exc. Computer Active Technology Suspension			G51773
-------	---------------------------------------------------------	-----------------------------------------------------------------------------------	------	------	------	------	------	-----------------------------------------------------------------------------------	--------	------	------	------	------





X-TYPE

02-08	Exc. CATS Computer Active Technology Suspension		G52276	
-------	-------------------------------------------------	-----------------------------------------------------------------------------------	--------	------	------	------	------	-----------------------------------------------------------------------------------	------	------	------	------	------



XJ6

72-86	All		69677	
-------	-----	------------------------------------------------------------------------------------	-------	------	------	------	------	------------------------------------------------------------------------------------	------	------	------	------	------



XJ12

81-92	All		69677	
73-79	All		69677	

XJS

76-96	All		69677	
-------	-----	-------------------------------------------------------------------------------------	-------	------	------	------	------	-------------------------------------------------------------------------------------	------	------	------	------	------



















XKE

62-64	All			81270	49105 ⁷
-------	-----	-------------------------------------------------------------------------------------	------	------	------	------	------	-------------------------------------------------------------------------------------	------	------	-------	------	--------------------

JEEP

JEEP

CHEROKEE

14-17	FWD			G511038
84-01	All		G63424	61535 77424 81548	14040		G63425	61536 77425 81549	49226 ⁷
84-00	Single system Steering Stabilizer; with a factory mounting hole in the steering linkage.		G63424	61535 77424 81548	6801SE ⁸⁰ 14040		G63425	61536 77425 81549	49226 ⁷
76-83	All		G63377	61519 81484	43058 ⁸		G63377	61519 81484	43058 ⁸ 49127 ⁷
	Single System Steering Stabilizer		G63377	61519 81484	6804SE ⁸⁰	43058 ⁸		G63377	61519 81484	43058 ⁸ 49127 ⁷
75	All		G63377	61519 81484	43058 ⁸	
	Single System Steering Stabilizer		G63377	61519 81484	6804SE ⁸⁰	43058 ⁸	
74	All		G63377	61519 81484	43058 ⁸		81676
	Single System Steering Stabilizer		G63377	61519 81484	6804SE ⁸⁰	43058 ⁸		81676

7 Pair Packs, Air hose kit included.

80 Mounting bracket not required, install on O.E. Shock Mounts. See Ref. C for

8 Pair Packs.

84 Replacement damper for vehicles with the Gabriel Aftermarket mounting kit

APPLICATION GUIDE

Year	Fitment Notes										
		Ultra	Ready Mounts	Max Control\ LTV Severe Duty\ ProGuard\ Guardian	Strut Cushion\ Strut Mount\ Dampers\ Stabilizer	HiJackers\ Load Carrier\ Classic	Ultra	Ready Mounts	Max Control\ LTV Severe Duty\ ProGuard\ Guardian	Strut Cushion\ Strut Mount\ Dampers\ Stabilizer	HiJackers\ Load Carrier\ Classic

JEEP

JEEP

CJ3

61-66	Exc. 5 Leaf Front Springs & Lift Kit	○	○	○	○	○	○	○	○	○	○
59-66	All	○	○	○	○	○	○	○	○	○	○
65	Exc. Lift Kit	○	○	○	○	○	○	○	○	○	○

CJ5

82-83	All	○	○	○	○	○	○	○	○	○	○
	2" Lift Kit	○	○	○	○	○	○	○	○	○	○
	Exc. Lift Kit	○	○	○	○	○	○	○	○	○	○
	Single System Steering Stabilizer	○	○	○	○	○	○	○	○	○	○
72-81	All	○	○	○	○	○	○	○	○	○	○
	2 - 4" Lift Kit	○	○	○	○	○	○	○	○	○	○
	Exc. Lift Kit	○	○	○	○	○	○	○	○	○	○
	Single System Steering Stabilizer	○	○	○	○	○	○	○	○	○	○
69-71	All	○	○	○	○	○	○	○	○	○	○
	2 - 4" Lift Kit	○	○	○	○	○	○	○	○	○	○
	Exc. 5 Leaf Front Springs & Lift Kit	○	○	○	○	○	○	○	○	○	○
	Exc. Lift Kit	○	○	○	○	○	○	○	○	○	○
	Single System Steering Stabilizer	○	○	○	○	○	○	○	○	○	○
66-71	5 Leaf Front Springs; Exc. Lift Kit	○	○	○	○	○	○	○	○	○	○
66-68	All	○	○	○	○	○	○	○	○	○	○
	2 - 4" Lift Kit	○	○	○	○	○	○	○	○	○	○
	Exc. 5 Leaf Front Springs & Lift Kit	○	○	○	○	○	○	○	○	○	○
	Exc. Lift Kit	○	○	○	○	○	○	○	○	○	○
	Single System Steering Stabilizer	○	○	○	○	○	○	○	○	○	○
61-65	Exc. 5 Leaf Front Springs & Lift Kit	○	○	○	○	○	○	○	○	○	○
59-65	All	○	○	○	○	○	○	○	○	○	○
65	Exc. Lift Kit	○	○	○	○	○	○	○	○	○	○
59-60	Single System Steering Stabilizer	○	○	○	○	○	○	○	○	○	○

CJ6

72-75	All	○	○	○	○	○	○	○	○	○	○
	2 - 4" Lift Kit	○	○	○	○	○	○	○	○	○	○
	Exc. Lift Kit	○	○	○	○	○	○	○	○	○	○
	Single System Steering Stabilizer	○	○	○	○	○	○	○	○	○	○
69-71	All	○	○	○	○	○	○	○	○	○	○



7 Pair Packs, Air hose kit included.

50 Bellows Kit No.141242 is recommended for use to protect piston rod from potentially harmful road debris.

8 Pair Packs.

84 Replacement damper for vehicles with the Gabriel Aftermarket mounting kit

APPLICATION GUIDE

Year	Fitment Notes										
		Ultra	Ready Mounts	Max Control\ LTV Severe Duty\ ProGuard\ Guardian	Strut Cushion\ Strut Mount\ Dampers\ Stabilizer	HiJackers\ Load Carrier\ Classic	Ultra	Ready Mounts	Max Control\ LTV Severe Duty\ ProGuard\ Guardian	Strut Cushion\ Strut Mount\ Dampers\ Stabilizer	HiJackers\ Load Carrier\ Classic

JEEP

JEEP

CJ6 (cont)

69-71	2 - 4" Lift Kit	⊙	G63443 ⁵⁰	61500 81676	43048 ⁸ 49310 ⁷
	Exc. 5 Leaf Front Springs & Lift Kit	⊙	82007	61500 81676	43048 ⁸ 49310 ⁷
	Exc. Lift Kit	⊙	G63405	81147 61500 81676	43048 ⁸ 49310 ⁷
	Single System Steering Stabilizer	⊙	6802SE ⁸⁴	61500 81676	43048 ⁸ 49310 ⁷
66-71	5 Leaf Front Springs; Exc. Lift Kit	⊙	81676	81676 61500	43048 ⁸ 49310 ⁷
	All	⊙	81676	61500 81676	43048 ⁸ 49310 ⁷
66-68	All	⊙	81676	61500 81676	43048 ⁸ 49310 ⁷
	2 - 4" Lift Kit	⊙	G63443 ⁵⁰	81676	61500 81676	43048 ⁸ 49310 ⁷
	Exc. 5 Leaf Front Springs & Lift Kit	⊙	81676	82007	61500 81676	43048 ⁸ 49310 ⁷
	Exc. Lift Kit	⊙	81676	G63405	81147 61500 81676
59-65	All	⊙	81676	81676
	Exc. Lift Kit	⊙	81676	G63405	81676
59-60	Single System Steering Stabilizer	⊙	81676	6802SE ⁸⁴	81676

CJ7

82-86	All	⊙	43058 ⁸	
	2" Lift Kit	⊙	43058 ⁸	G63443 ⁵⁰	
	Exc. Lift Kit	⊙	G63377	61519 81484	43058 ⁸	G63405	61500 81147	43048 ⁸ 49310 ⁷
	Single System Steering Stabilizer	⊙	6802SE ⁸⁴	43058 ⁸	
76-81	All	⊙	81676	
	2 - 4" Lift Kit	⊙	G63443 ⁵⁰	81676	
	Exc. Lift Kit	⊙	G63299	81676	82007	G63405	61500 81147	43048 ⁸ 49310 ⁷
	Single System Steering Stabilizer	⊙	81676	6802SE ⁸⁴	

COMANCHE

86-92	All	⊙	G63424	61535 77424 81548	14040	G63492	61506 81318	49311 ⁷
	Single system Steering Stabilizer; with a factory mounting hole in the steering linkage.	⊙	G63424	61535 77424 81548	6801SE ⁸⁰ 14040	G63492	61506 81318	49311 ⁷

COMMANDER

06-10	All	⊙	G56807	143364 ⁵³	G64012	61715
	Exc. Performance	⊙	G56807	G57083 ⁴⁰	143364 ⁵³	G64012	61715

COMPASS

13-18	All	⊙	⊙	G57794 ⁴⁰
-------	-----	---	------	------	------	------	------	------	---	----------------------	------	------	------

7 Pair Packs, Air hose kit included.

40 Complete Assembled Unit.

53 Hardware from O.E. Part may need to be reused.



84 Replacement damper for vehicles with the Gabriel Aftermarket mounting kit

8 Pair Packs.

50 Bellows Kit No. 141242 is recommended for use to protect piston rod from potentially harmful road debris.

80 Mounting bracket not required, install on O.E. Shock Mounts. See Ref. C for optional Steering Stabilizer Boots

APPLICATION GUIDE

Year	Fitment Notes										
		Ultra	Ready Mounts	Max Control\ LTV Severe Duty\ ProGuard\ Guardian	Strut Cushion\ Strut Mount\ Dampers\ Stabilizer	HiJackers\ Load Carrier\ Classic	Ultra	Ready Mounts	Max Control\ LTV Severe Duty\ ProGuard\ Guardian	Strut Cushion\ Strut Mount\ Dampers\ Stabilizer	HiJackers\ Load Carrier\ Classic

JEEP

JEEP

COMPASS (cont)

11-12	All		G57794 ⁴⁰	143337 ⁶⁷
07-10	Left		G52081	G57464 ⁴⁰	143495 ⁵⁴		G51842	G57607 ⁴⁰	143337 ⁶⁷ 143496 ⁶⁷
	Right		G52082	G57463 ⁴⁰	143495 ⁵⁴		G51842	G57607 ⁴⁰	143337 ⁶⁷ 143496 ⁶⁷

DISPATCHER

61-67	All		81676	81676
-------	-----	--	------	------	-------	------	------	--	------	------	-------	------	------

DJ3

59-66	All		81676	81676
-------	-----	--	------	------	-------	------	------	--	------	------	-------	------	------

DJ5

66-74	2 - 4" Lift Kit		G63443 ⁵⁰	81676
	Exc. Lift Kit		G63299	81676	82007		G63405	61500 81147	43048 ⁸ 49310 ⁷
65-74	All		81676

DJ6

66-68	All		81676	82007		61500 81147	43048 ⁸ 49310 ⁷
	2 - 4" Lift Kit		G63443 ⁵⁰	81676	82007		61500 81147	43048 ⁸ 49310 ⁷
	Exc. Lift Kit		81676	82007		G63405	61500 81147	43048 ⁸ 49310 ⁷
65	All		81676

FC150

61-65	All		82007		81676
57-60	All		81676	82007		G63405	61500 81147	43048 ⁸ 49310 ⁷

FC170

63-65	All		G63405	61500 81147	43048 ⁸		G63405	61500 81147	43048 ⁸ 49310 ⁷
-------	-----	--	--------	------	----------------	------	--------------------	--	--------	------	----------------	------	------------------------------------------

GLADIATOR

67	All		81318	61519 81484	43058 ⁸ 49127 ⁷ 49311 ⁷
	Single System Steering Stabilizer		81318	6803SE ⁸⁴	61519 81484	43058 ⁸ 49127 ⁷ 49311 ⁷
66	All		81318	81147	49310 ⁷ 49311 ⁷
	Independent Front Suspension		81318		G63405	61500 81147	43048 ⁸ 49310 ⁷ 49311 ⁷
	Single System Steering Stabilizer		81318	6803SE ⁸⁴	81147	49310 ⁷ 49311 ⁷
64-65	All		81147	49310 ⁷
	Exc. Independent Front Suspension		81318	81147	49311 ⁷ 49310 ⁷
	Single System Steering Stabilizer		6803SE ⁸⁴	81147	49310 ⁷
63-65	Independent Front Suspension			G63405	61500 81147	43048 ⁸ 49310 ⁷
63	Single System Steering Stabilizer		6803SE ⁸⁴

7 Pair Packs, Air hose kit included.

40 Complete Assembled Unit.

54 Kit with Mount and Bearing. Hardware from O.E. Part may need to be reused.



84 Replacement damper for vehicles with the Gabriel Aftermarket mounting kit

8 Pair Packs.

50 Bellows Kit No.141242 is recommended for use to protect piston rod from potentially harmful road debris.

67 Mount Kit. Hardware from O.E. Part may need to be reused.

APPLICATION GUIDE

Year	Fitment Notes										
		Ultra	Ready Mounts	Max Control\ LTV Severe Duty\ ProGuard\ Guardian	Strut Cushion\ Strut Mount\ Dampers\ Stabilizer	HiJackers\ Load Carrier\ Classic	Ultra	Ready Mounts	Max Control\ LTV Severe Duty\ ProGuard\ Guardian	Strut Cushion\ Strut Mount\ Dampers\ Stabilizer	HiJackers\ Load Carrier\ Classic

JEEP

JEEP

GRAND CHEROKEE

11-15	Exc. Load Leveling Suspensions		↑	G511000
	Left		G57764⁴⁰	↓
	Right		G57765⁴⁰	↓
10	Left		G56807	G57764⁴⁰	143364 ⁵³	○	G64012	61715
	Right		G56807	G57765⁴⁰	143364 ⁵³	○	G64012	61715
	4WD; Exc. Performance 4.7L & 5.7L V8 Models		G57083 ⁴⁰
05-09	All		G56807	143364 ⁵³	○	G64012	61715
	4WD; Exc. Performance 4.7L & 5.7L V8 Models		G56807	G57083 ⁴⁰	143364 ⁵³	○	G64012	61715
99-04	All		81869	○	G63829	61676 77829 81926
	Exc. Up Country Suspension		G63847	61664 77847 81869	○	G63829	61676 77829 81926
	Single System Steering Damper		81869	14071	○	G63829	61676 77829 81926
95-98	All		G63424	61535 77424 81548	6853SE ⁸²	○	G63683	61575 77683 81891
93-94	All		G63424	61535 77424 81548	6853SE ⁸²	○	61575 77683 81891

GRAND WAGONEER

93	All		G63377	61519 81484	43058 ⁸	○	G63377	61519 81484	43058 ⁸ 49127 ⁷
84-91	All		G63377	61519 81484	43058 ⁸	○	G63377	61519 81484	43058 ⁸ 49127 ⁷
	Single System Steering Stabilizer		G63377	61519 81484	6804SE ⁸⁰	43058 ⁸	○	G63377	61519 81484	43058 ⁸ 49127 ⁷

J10 PICKUP

74-88	All		G63377	61519 81484	43058 ⁸	○	G63377	61519 81484	43058 ⁸ 49127 ⁷
	Single System Steering Stabilizer		G63377	61519 81484	6804SE ⁸⁰	43058 ⁸	○	G63377	61519 81484	43058 ⁸ 49127 ⁷

J20 PICKUP

74-88	All		G63377	61519 81484	43058 ⁸	○	G63377	61519 81484	43058 ⁸ 49127 ⁷
	Single System Steering Stabilizer		G63377	61519 81484	6804SE ⁸⁰	43058 ⁸	○	G63377	61519 81484	43058 ⁸ 49127 ⁷

J2500 PICKUP

68-73	All		81318	○	61519 81484	43058 ⁸ 49127 ⁷
-------	-----	--	------	------	-------	------	------	---	------	------	----------------	------	------------------------------------------

JEEPSTER

70-71	All		82007	○	G63405	61500 81147	43048 ⁸ 49310 ⁷
	Single System Steering Stabilizer		6802SE ⁸⁴	82007	○	G63405	61500 81147	43048 ⁸ 49310 ⁷

7 Pair Packs, Air hose kit included.

40 Complete Assembled Unit.

80 Mounting bracket not required, install on O.E. Shock Mounts. See Ref. C for optional Steering Stabilizer Boots





84 Replacement damper for vehicles with the Gabriel Aftermarket mounting kit

8 Pair Packs.

53 Hardware from O.E. Part may need to be reused.

82 Use kit if listed, See Ref. C for optional Steering Stabilizer Boots.





APPLICATION GUIDE

Year	Fitment Notes										
			Ultra	Ready Mounts	Max Control\ LTV Severe Duty\ ProGuard\ Guardian	Strut Cushion\ Strut Mount\ Dampers\ Stabilizer	HiJackers\ Load Carrier\ Classic		Ultra	Ready Mounts	Max Control\ LTV Severe Duty\ ProGuard\ Guardian















JEEP

JEEP

JEEPSTER (cont)

67-69	All		82007		82007
	Single System Steering Stabilizer		6802SE ⁸⁴	82007		82007
66	Single System Steering Stabilizer		6802SE ⁸⁴













LIBERTY

12	All		G51728		G63844
	Gas Left		G51728	G57007 ⁴⁰		G63844
	Gas Right		G51728	G57008 ⁴⁰		G63844
02-11	Left		G51728	143255 ⁵³		G63844
	Right		G51728	143266 ⁵³		G63844
	Gas Left		G57007 ⁴⁰	
	Gas Right		G57008 ⁴⁰	









M151

60-68	All		81676
-------	-----	-------------------------------------------------------------------------------------	------	------	------	-------	------	------	------	------	------	------	------







PATRIOT

13-17	All			G57794 ⁴⁰
11-12	All			G57794 ⁴⁰	143337 ⁶⁷
10	Left		G52081	G57464 ⁴⁰	143495 ⁵⁴		G51842	G57607 ⁴⁰	143337 ⁶⁷
	Right		G52082	G57463 ⁴⁰	143495 ⁵⁴		G51842	G57607 ⁴⁰	143337 ⁶⁷
07-09	Left		G52081	G57464 ⁴⁰	143495 ⁵⁴		G51842	G57607 ⁴⁰	143337 ⁶⁷ 143496 ⁶⁷
	Right		G52082	G57463 ⁴⁰	143495 ⁵⁴		G51842	G57607 ⁴⁰	143337 ⁶⁷ 143496 ⁶⁷

RENEGADE

15-18	AWD, Left			G57797 ⁴⁰
	AWD, Right			G57798 ⁴⁰
	FWD, Left		G57768 ⁴⁰		G57795 ⁴⁰
	FWD, Right		G57769 ⁴⁰		G57796 ⁴⁰

SCRAMBLER / CJ8

82-85	All		G63377	61519 81484		G63405	61500 81147	43048 ⁸ 49310 ⁷
	Single System Steering Stabilizer		G63377	61519 81484	6802SE ⁸⁴		G63405	61500 81147	43048 ⁸ 49310 ⁷
81	All		G63299	81676		G63405	61500 81147	43048 ⁸ 49310 ⁷

7 Pair Packs, Air hose kit included.

40 Complete Assembled Unit.

54 Kit with Mount and Bearing. Hardware from O.E. Part may need to be reused.

84 Replacement damper for vehicles with the Gabriel Aftermarket mounting kit



Bold Type - New / Future Part

8 Pair Packs.

53 Hardware from O.E. Part may need to be reused.

67 Mount Kit. Hardware from O.E. Part may need to be reused.

APPLICATION GUIDE

Year	Fitment Notes										
		Ultra	Ready Mounts	Max Control\ LTV Severe Duty\ ProGuard\ Guardian	Strut Cushion\ Strut Mount\ Dampers\ Stabilizer	Hijackers\ Load Carrier\ Classic	Ultra	Ready Mounts	Max Control\ LTV Severe Duty\ ProGuard\ Guardian	Strut Cushion\ Strut Mount\ Dampers\ Stabilizer	Hijackers\ Load Carrier\ Classic

JEEP

JEEP

SCRAMBLER / CJ8 (cont)

81	Single System Steering Stabilizer	<input type="radio"/>	<input type="radio"/>	G63299	81676	6802SE ⁸⁴	82007	<input type="radio"/>	<input type="radio"/>	G63405	61500 81147	43048 ⁸ 49310 ⁷
----	-----------------------------------	-----------------------	-----------------------	--------	------	-------	----------------------	-------	-----------------------	-----------------------	--------	------	----------------	------	------------------------------------------

TRUCK

56-66	All	<input type="radio"/>	<input type="radio"/>	81676	<input type="radio"/>	<input type="radio"/>
-------	-----	-----------------------	-----------------------	------	------	-------	------	------	-----------------------	-----------------------	------	------	------	------	------

UNIVERSAL

65-67	All	<input type="radio"/>	<input type="radio"/>	82007	<input type="radio"/>	<input type="radio"/>	61500 81147	43048 ⁸ 49310 ⁷
	2 - 4" Lift Kit	<input type="radio"/>	<input type="radio"/>	G63443 ⁵⁰	82007	<input type="radio"/>	<input type="radio"/>	61500 81147	43048 ⁸ 49310 ⁷
	5 Leaf Front Springs; Exc. Lift Kit	<input type="radio"/>	<input type="radio"/>	81676	82007	<input type="radio"/>	<input type="radio"/>	81676 61500 81147	43048 ⁸ 49310 ⁷
	Exc. Lift Kit	<input type="radio"/>	<input type="radio"/>	82007	<input type="radio"/>	<input type="radio"/>	G63405	61500 81147	43048 ⁸ 49310 ⁷
	Single System Steering Stabilizer	<input type="radio"/>	<input type="radio"/>	6802SE ⁸⁴	82007	<input type="radio"/>	<input type="radio"/>	61500 81147	43048 ⁸ 49310 ⁷
61-64	All	<input type="radio"/>	<input type="radio"/>	82007	<input type="radio"/>	<input type="radio"/>	G63405	61500 81147	43048 ⁸ 49310 ⁷
	5 Leaf Front Springs; Exc. Lift Kit	<input type="radio"/>	<input type="radio"/>	81676	82007	<input type="radio"/>	<input type="radio"/>	G63405	81676 61500 81147	43048 ⁸ 49310 ⁷
	Single System Steering Stabilizer	<input type="radio"/>	<input type="radio"/>	6802SE ⁸⁴	82007	<input type="radio"/>	<input type="radio"/>	G63405	61500 81147	43048 ⁸ 49310 ⁷

WAGONEER

84-90	All	<input type="radio"/>	<input type="radio"/>	G63424	61535 77424 81548	<input type="radio"/>	<input type="radio"/>	G63425	61536 77425 81549	49226 ⁷
76-83	All	<input type="radio"/>	<input type="radio"/>	G63377	61519 81484	43058 ⁸	<input type="radio"/>	<input type="radio"/>	G63377	61519 81484	43058 ⁸ 49127 ⁷
75	All	<input type="radio"/>	<input type="radio"/>	G63377	61519 81484	43058 ⁸	<input type="radio"/>	<input type="radio"/>
74	All	<input type="radio"/>	<input type="radio"/>	G63377	61519 81484	43058 ⁸	<input type="radio"/>	<input type="radio"/>	G63299	81676
71-73	All	<input type="radio"/>	<input type="radio"/>	G63492	81318	<input type="radio"/>	<input type="radio"/>	G63299	81676	49311 ⁷
68-70	All	<input type="radio"/>	<input type="radio"/>	G63492	81318	<input type="radio"/>	<input type="radio"/>	81676	49311 ⁷
66-67	All	<input type="radio"/>	<input type="radio"/>	G63492	81318	<input type="radio"/>	<input type="radio"/>	G63299	81676	49311 ⁷
	Exc. Independent Front Suspension	<input type="radio"/>	<input type="radio"/>	G63492	81318	6802SE ⁸⁴	<input type="radio"/>	<input type="radio"/>	G63299	81676	49311 ⁷
63-65	All	<input type="radio"/>	<input type="radio"/>	<input type="radio"/>	<input type="radio"/>	G63299	81676
	Exc. Independent Front Suspension	<input type="radio"/>	<input type="radio"/>	G63492	81318	<input type="radio"/>	<input type="radio"/>	G63299	81676	49311 ⁷
	Independent Front Suspension	<input type="radio"/>	<input type="radio"/>	81676	<input type="radio"/>	<input type="radio"/>	G63299	81676
	Exc. Independent Front Suspension	<input type="radio"/>	<input type="radio"/>	6802SE ⁸⁴	<input type="radio"/>	<input type="radio"/>	G63299	81676

WILLYS

43-58	All	<input type="radio"/>	<input type="radio"/>	81676	<input type="radio"/>	<input type="radio"/>	81676
-------	-----	-----------------------	-----------------------	------	------	-------	------	------	-----------------------	-----------------------	------	------	-------	------	------

WRANGLER

18	w/o Dust Boot	<input type="radio"/>	<input type="radio"/>	14040	<input type="radio"/>	<input type="radio"/>
	4WD, w/ Dust Boot	<input type="radio"/>	<input type="radio"/>	14074	<input type="radio"/>	<input type="radio"/>
16-17	Models w/ 17" Wheels; w/Heavy Duty Suspension	<input type="radio"/>	<input type="radio"/>	61711	<input type="radio"/>	<input type="radio"/>	G63967	61697
13-17	All	<input type="radio"/>	<input type="radio"/>	61711	<input type="radio"/>	<input type="radio"/>
	Exc. Models w/ 17" Wheels	<input type="radio"/>	<input type="radio"/>	61711	<input type="radio"/>	<input type="radio"/>	G63966	61696



7 Pair Packs, Air hose kit included.

50 Bellows Kit No.141242 is recommended for use to protect piston rod from

8 Pair Packs.

84 Replacement damper for vehicles with the Gabriel Aftermarket mounting kit

APPLICATION GUIDE

Year	Fitment Notes										
		Ultra	Ready Mounts	Max Control\ LTV Severe Duty\ ProGuard\ Guardian	Strut Cushion\ Strut Mount\ Dampers\ Stabilizer	HiJackers\ Load Carrier\ Classic	Ultra	Ready Mounts	Max Control\ LTV Severe Duty\ ProGuard\ Guardian	Strut Cushion\ Strut Mount\ Dampers\ Stabilizer	HiJackers\ Load Carrier\ Classic

JEEP

JEEP

WRANGLER (cont)

13-17	w/o Dust Boot		61711	14040
	4WD		61711	77973
	4WD, w/ Dust Boot		61711	14074
13-15	Models w/ 17" Wheels		61711	61697
	Models w/ 17" Wheels; w/Heavy Duty Suspension		61711	G63967
11-12	All		G64008	61711 77981
	Exc. Models w/ 17" Wheels		G64008	61711 77981	G63966	61696
	Models w/ 17" Wheels		G64008	61711 77981	G63967	61697
	w/o Dust Boot		G64008	61711 77981	14040
	4WD		G64008	61711 77981	77973
	4WD, w/ Dust Boot		G64008	61711 77981	14074
07-10	All		G64008	61711 77981	14040
	Exc. Models w/ 17" Wheels		G64008	61711 77981	14040	G63966	61696
	Models w/ 17" Wheels		G64008	61711 77981	14040	G63967	61697
	4WD		G64008	61711 77981	14040	77973
	4WD, w/ Dust Boot		G64008	61711 77981	14074 14040
06	All		77978	14040
	Single system Steering Stabilizer; with a factory mounting hole in the steering linkage.		77978	6801SE ⁸⁰ 14040
	TJ(MfrBodyCode)		G63721	61615 81936 77978	14040	G63722	61616 81929
97-05	All		77978
	Single system Steering Stabilizer; with a factory mounting hole in the steering linkage.		77978	6801SE ⁸⁰
	TJ(MfrBodyCode)		G63721	61615 81936 77978	G63722	61616 81929
94-95	Single system Steering Stabilizer; with a factory mounting hole in the steering linkage.		6801SE ⁸⁰
87-95	YJ(MfrBodyCode)		81691	G63490	61541 81583
	YJ(MfrBodyCode) 4WD Quad Suspension Forward of Front Axle Non Quad Suspension		G63511
93	Single System Steering Stabilizer; w/ factory mounting hole in the steering linkage.		6801SE ⁸⁰
87-92	Single system Steering Stabilizer; with a factory mounting hole in the steering linkage.		6801SE ⁸⁰

KIA

KIA





AMANTI

07-09	All		143342 ⁸⁰	G51994
-------	-----	--	------	------	------	----------------------	------	------	------	--------	------	------	------	------

68 Mount Kit. Hardware from O.E. Part may need to be reused.;

80 Mounting bracket not required, install on O.E. Shock Mounts. See Ref. C for optional Steering Stabilizer Boots



APPLICATION GUIDE

Year	Fitment Notes										
		 Ultra	Ready Mounts	Max Control\ LTV Severe Duty\ ProGuard\ Guardian	Strut Cushion\ Strut Mount\ Dampers\ Stabilizer	HiJackers\ Load Carrier\ Classic	 Ultra	Ready Mounts	Max Control\ LTV Severe Duty\ ProGuard\ Guardian	Strut Cushion\ Strut Mount\ Dampers\ Stabilizer	HiJackers\ Load Carrier\ Classic





KIA

KIA



AMANTI (cont)

04-06	All	 G51774	143419 ⁶⁷	...	 G51825	143419 ⁶⁷	...
-------	-----	------------------------------------------------------------------------------------------	-----	-----	----------------------	-----	------------------------------------------------------------------------------------------	-----	-----	----------------------	-----

CADENZA

14-16	Left	 G52437	 70068
	Right	 G52438	 70068

FORTE

14-18	Hatchback	 70208
11-13	Sedan	 70102









FORTE KOUP

14-17	All	 70208
-------	-----	-----	-----	-----	-----	-----	-----------------------------------------------------------------------------------------	-----	-----	-----	-----





















FORTE5

14-18	All	 70208
-------	-----	-----	-----	-----	-----	-----	-----------------------------------------------------------------------------------------	-----	-----	-----	-----

MAGENTIS

07-10	Left	 G52247	 70049
	Right	 G52248	 70049
01-06	Left	 G51714	 G51713	G57090 ⁴⁰	...	142419 ⁶⁸	...
	Right	 G51714	 G51713	G57091 ⁴⁰	...	142419 ⁶⁸	...



OPTIMA

16	Hybrid, Hybrid EX, Hybrid EX Premium, Hybrid LX	 70209
11-15	Exc. Hybrid Models	 70068
15	Hybrid EX, Hybrid LX	 70209
14	Hybrid EX, Hybrid EX Premium, Hybrid LX	 70209
13	Hybrid, Hybrid EX, Hybrid LX, Hybrid Premium	 70209
11-12	Hybrid	 70209
07-10	Left	 G52247	 70049
	Right	 G52248	 70049
01-06	Left	 G51714	G57059 ⁴⁰	 G51713	G57090 ⁴⁰	...	142419 ⁶⁸	...
	Right	 G51714	G57059 ⁴⁰	 G51713	G57091 ⁴⁰	...	142419 ⁶⁸	...
06	All	 G51714	G57059 ⁴⁰	 G51713	142419 ⁶⁸	...
	Left New Body Style	 G52247	G57059 ⁴⁰	 G51713	142419 ⁶⁸	...
	Right New Body Style	 G52248	G57059 ⁴⁰	 G51713	142419 ⁶⁸	...

40 Complete Assembled Unit.

67 Mount Kit. Hardware from O.E. Part may need to be reused.





























APPLICATION GUIDE

Year	Fitment Notes										
		Ultra	Ready Mounts	Max Control\ LTV Severe Duty\ ProGuard\ Guardian	Strut Cushion\ Strut Mount\ Dampers\ Stabilizer	HiJackers\ Load Carrier\ Classic	Ultra	Ready Mounts	Max Control\ LTV Severe Duty\ ProGuard\ Guardian	Strut Cushion\ Strut Mount\ Dampers\ Stabilizer	HiJackers\ Load Carrier\ Classic





KIA

KIA

















RIO

12-17	Left		G52353		70095
	Right		G52354		70095
06-11	Left		G52154	G57275 ⁴⁰	143409 ⁵⁴		70036	142419 ⁶⁸
	Right		G52155	G57276 ⁴⁰	143410 ⁵⁴		70036	142419 ⁶⁸
04-05	All			70001
	Left 3 Stud Top Mount from 07/01/2002		G57608 ⁴⁰		70001
	Right 3 Stud Top Mount from 07/01/2002		G57609 ⁴⁰		70001
	Sedan Left		143456 ⁵³		70001
	Sedan Right		143457 ⁵³		70001
01-03	Left		G56782	143227 ⁵³		69585
	Right		G56781	143227 ⁵³		69585
03	All		143227 ⁵³		69585
	Left 3 Stud Top Mount from 07/01/2002		G57608 ⁴⁰	143227 ⁵³		69585
	Right 3 Stud Top Mount from 07/01/2002		G57609 ⁴⁰	143227 ⁵³		69585





RONDO

07-11	Left		G52247		70049	143386 ⁵³
	Right		G52248		70049	143386 ⁵³

SEDONA

14	Left		G52257	G57487 ⁴⁰		G64071
	Right		G52258	G57488 ⁴⁰		G64071
12	Left		G52257	G57487 ⁴⁰		G64071
	Right		G52258	G57488 ⁴⁰		G64071
06-11	Left		G52257	G57487 ⁴⁰	143416 ⁵⁴		G64071
	Right		G52258	G57488 ⁴⁰	143416 ⁵⁴		G64071
02-05	Left		G57489 ⁴⁰	143458 ⁶⁸		70000
	Right		G57490 ⁴⁰	143458 ⁶⁸		70000

SEPHIA

01	Left Mfg. to 6/01			G56534
	Right Mfg. to 6/01			G56533



40 Complete Assembled Unit.

54 Kit with Mount and Bearing. Hardware from O.E. Part may need to be reused.

53 Hardware from O.E. Part may need to be reused.

68 Mount Kit. Hardware from O.E. Part may need to be reused.;

APPLICATION GUIDE

Year	Fitment Notes										
		Ultra	Ready Mounts	Max Control\ LTV Severe Duty\ ProGuard\ Guardian	Strut Cushion\ Strut Mount\ Dampers\ Stabilizer	HiJackers\ Load Carrier\ Classic	Ultra	Ready Mounts	Max Control\ LTV Severe Duty\ ProGuard\ Guardian	Strut Cushion\ Strut Mount\ Dampers\ Stabilizer	HiJackers\ Load Carrier\ Classic

KIA

KIA

SEPHIA (cont)

01	Mfg. to 6/01	↓	142856 ⁵³	↓
	Mfg. to 6/01; Non-ABS Left	↓	G56532	↓
	Non-ABS Right	↓	G56531	↓
00	All	↓	142856 ⁵⁴	↓
	Left Mfg. to 6/01	↓	142856 ⁵⁴	↓	G56534
	Right Mfg. to 6/01	↓	142856 ⁵⁴	↓	G56533
	Mfg. to 6/01; Non-ABS Left	↓	G56532	142856 ⁵⁴	↓
	Non-ABS Right	↓	G56531	142856 ⁵⁴	↓
98-99	Left	↓	142856 ⁵⁴	↓	G56534
	Right	↓	142856 ⁵⁴	↓	G56533
	Mfg. to 6/01; Non-ABS Left	↓	G56532	↓
	Non-ABS Right	↓	G56531	↓
94-97	Left	↓	G56570	142643 ⁵³	↓	G56637
	Right	↓	G56569	142643 ⁵³	↓	G56571



SORENTO

14-15	AWD	↓	↓	70213
	FWD	↓	↓	70210
11-13	AWD, Left	↓	G57689 ⁴⁰	↓	70203
	AWD, Right	↓	G57690 ⁴⁰	↓	70203
07-09	Exc. HPD (High Performance Dampers)	↓	↓	70078
	Left	↓	G57457 ⁴⁰	↓
	Left Exc. HPD (High Performance Dampers)	↓	G511054	↓
	Right	↓	G57458 ⁴⁰	↓
	Right Exc. HPD (High Performance Dampers)	↓	G511055	↓
03-06	All	↓	143226 ⁵³	↓
	Exc. Self-Leveling Suspension	↓	143226 ⁵³	↓	G64032
	Left	↓	G52036	G57457 ⁴⁰	143226 ⁵³	↓
	Right	↓	G52037	G57458 ⁴⁰	143226 ⁵³	↓

40 Complete Assembled Unit.

53 Hardware from O.E. Part may need to be reused.

APPLICATION GUIDE

Year	Fitment Notes										
		Ultra	Ready Mounts	Max Control\ LTV Severe Duty\ ProGuard\ Guardian	Strut Cushion\ Strut Mount\ Dampers\ Stabilizer	HiJackers\ Load Carrier\ Classic	Ultra	Ready Mounts	Max Control\ LTV Severe Duty\ ProGuard\ Guardian	Strut Cushion\ Strut Mount\ Dampers\ Stabilizer	HiJackers\ Load Carrier\ Classic











KIA

KIA











SOUL

14-19	All	 70036
-------	-----	-------	-------	-------	-------	-------	-------------------------------------------------------------------------------------------	-------	-------	-------	-------

SPECTRA

04-09	Left	 G52160	 G52162
	Right	 G52161	 G52163
02-03	Left	 G56892	 G52017
	Right	 G56893	 G52018
00-01	Left Mfg. to 6/01	 G56534
	Right Mfg. to 6/01	 G56533



SPORTAGE

11-16	AWD	 G64216
05-10	Left	 G56819	G57218 ⁴⁰	 G56822	G57343 ⁴⁰
	Right	 G56820	G57219 ⁴⁰	 G56821	G57344 ⁴⁰
00-02	Left	 G56787	 G63720
	Right	 G56786	 G63720
95-99	All	143064 ⁵¹	 G63720







LAND ROVER

LAND ROVER

DISCOVERY

94-99	Exc. Series II	 G63506	 G63694
-------	----------------	--------------------------------------------------------------------------------------------	-------	-------	-------	-------	----------------------------------------------------------------------------------------------	-------	-------	-------	-------



RANGE ROVER

95	All	 G63615
	Air(RearSpringType)	 G63506	 G63694
94	Air(RearSpringType)	 G63506	 G63694
	Coil(RearSpringType)	 G63615









LEXUS

LEXUS

ES250

90-91	All		143061 ⁵¹ 143281 ⁵³		142250 ⁵³ 143061 ⁵¹
-------	-----	-------------------------------------------------------------------------------------------	-------	-------	----------------------------------------------	-------	---------------------------------------------------------------------------------------------	-------	-------	----------------------------------------------	-------

ES300

03	Exc. Electronic Adjustable Suspension		143202 ⁵⁴	
	Left		G57041 ⁴⁰		G57043 ⁴⁰
	Right		G57042 ⁴⁰		G57044 ⁴⁰
02	All		143057 ⁵¹	



40 Complete Assembled Unit.

53 Hardware from O.E. Part may need to be reused.

51 Strut Cushion for use with the Strut/Cartridge/Shocks.

54 Kit with Mount and Bearing. Hardware from O.E. Part may need to be reused.

APPLICATION GUIDE

Year	Fitment Notes										
		Ultra	Ready Mounts	Max Control\ LTV Severe Duty\ ProGuard\ Guardian	Strut Cushion\ Strut Mount\ Dampers\ Stabilizer	HiJackers\ Load Carrier\ Classic	Ultra	Ready Mounts	Max Control\ LTV Severe Duty\ ProGuard\ Guardian	Strut Cushion\ Strut Mount\ Dampers\ Stabilizer	HiJackers\ Load Carrier\ Classic

LEXUS

LEXUS

ES300 (cont)

02	Exc. Electronic Adjustable Suspension	143202 ⁵⁴ 143057 ⁵¹	143057 ⁵¹	...
	Left	...	G57041 ⁴⁰	...	143057 ⁵¹	G57043 ⁴⁰
	Left Exc. Electronic Adjustable Suspension	143057 ⁵¹	...	G55675	G56932 ⁴⁰
	Right	...	G57042 ⁴⁰	...	143057 ⁵¹	G57044 ⁴⁰
	Right Exc. Electronic Adjustable Suspension	143057 ⁵¹	...	G55676	G56933 ⁴⁰
97-01	All	143057 ⁵¹	143057 ⁵¹	...
	Left Exc. Electronic Adjustable Suspension	G56506	G56930 ⁴⁰	M56506	142650 ⁵⁴ 143057 ⁵¹	...	G55675	G56932 ⁴⁰	...	143057 ⁵¹
	Right Exc. Electronic Adjustable Suspension	G56514	G56931 ⁴⁰	M56514	142649 ⁵⁴ 143057 ⁵¹	...	G55676	G56933 ⁴⁰	...	143057 ⁵¹
95-96	All	M56502	142836 ⁵⁴ 143057 ⁵¹	143057 ⁵¹	...
	Left	M56502	142836 ⁵⁴ 143057 ⁵¹	...	G55675	143057 ⁵¹
	Left Exc. Electronic Adjustable Suspension	M56502	142836 ⁵⁴ 143057 ⁵¹	G56932 ⁴⁰	...	143057 ⁵¹
	Right	M56502	142836 ⁵⁴ 143057 ⁵¹	...	G55676	143057 ⁵¹
	Right Exc. Electronic Adjustable Suspension	M56502	142836 ⁵⁴ 143057 ⁵¹	G56933 ⁴⁰	...	143057 ⁵¹
92-94	All	142561 ⁵⁴ 143057 ⁵¹	143057 ⁵¹	...
	Left Exc. Electronic Adjustable Suspension	142561 ⁵⁴ 143057 ⁵¹	G56932 ⁴⁰	...	143057 ⁵¹
	Left Sealed OE Struts	142561 ⁵⁴ 143057 ⁵¹	...	G55675	143057 ⁵¹
	Right Exc. Electronic Adjustable Suspension	142561 ⁵⁴ 143057 ⁵¹	G56933 ⁴⁰	...	143057 ⁵¹
	Right Sealed OE Struts	142561 ⁵⁴ 143057 ⁵¹	...	G55676	143057 ⁵¹

ES330

04-06	Exc. Adaptive Variable Suspension	143202 ⁵⁴
	Left	...	G57076 ⁴⁰	G57078 ⁴⁰
	Left Exc. Adaptive Variable Suspension	G56721	G56728
	Right	...	G57077 ⁴⁰	G57079 ⁴⁰
	Right Exc. Adaptive Variable Suspension	G56722	G56729



ES350

12	Left	G56888	G57190 ⁴⁰	G52103
	Right	G56889	G57191 ⁴⁰	G52104
10-11	Left	...	G57190 ⁴⁰	...	143402 ⁶⁸	...	G52103

40 Complete Assembled Unit.

51 Strut Cushion for use with the Strut/Cartridge/Shocks.







APPLICATION GUIDE

Year	Fitment Notes										
		Ultra	Ready Mounts	Max Control\ LTV Severe Duty\ ProGuard\ Guardian	Strut Cushion\ Strut Mount\ Dampers\ Stabilizer	HiJackers\ Load Carrier\ Classic	Ultra	Ready Mounts	Max Control\ LTV Severe Duty\ ProGuard\ Guardian	Strut Cushion\ Strut Mount\ Dampers\ Stabilizer	HiJackers\ Load Carrier\ Classic



LEXUS

LEXUS



ES350 (cont)

10-11	Right		G57191 ⁴⁰	143402 ⁶⁸		G52104
07-09	Left		G56888	G57190 ⁴⁰	143402 ⁶⁸		G52103
	Right		G56889	G57191 ⁴⁰	143402 ⁶⁸		G52104



GS300

98-05	All		G56598		143408 ⁶⁸
-------	-----	-----------------------------------------------------------------------------------	--------	-------	-------	-------	-------	-------------------------------------------------------------------------------------	-------	-------	-------	----------------------	-------









GS400

98-00	All		G56598		143408 ⁶⁸
-------	-----	-----------------------------------------------------------------------------------	--------	-------	-------	-------	-------	-------------------------------------------------------------------------------------	-------	-------	-------	----------------------	-------



GS430

01-05	All		G56598		143408 ⁶⁸
-------	-----	-----------------------------------------------------------------------------------	--------	-------	-------	-------	-------	-------------------------------------------------------------------------------------	-------	-------	-------	----------------------	-------









IS250

14-15	RWD, Left		G51920	
	RWD, Right		G51921	
06-13	RWD, Left		G51920		G51922
	RWD, Right		G51921		G51922











IS300

01-05	All			143408 ⁶⁸
-------	-----	-------------------------------------------------------------------------------------	-------	-------	-------	-------	-------	---------------------------------------------------------------------------------------	-------	-------	-------	----------------------	-------



IS350

14-15	RWD, Left		G51920	
	RWD, Right		G51921	
06-13	RWD, Left		G51920		G51922
	RWD, Right		G51921		G51922

LS400

96-00	All			G57420 ⁴⁰
	Exc. Rough Road Package		G57421 ⁴⁰		G57420 ⁴⁰
95	All		G57421 ⁴⁰		G57420 ⁴⁰
90-94	All		G57421 ⁴⁰	
	Exc. Auto-Leveling System		G57421 ⁴⁰		143197 ⁶³

LS430



01-06	All		G51832		G51833
-------	-----	-------------------------------------------------------------------------------------	--------	-------	-------	-------	-------	---------------------------------------------------------------------------------------	--------	-------	-------	-------	-------

40 Complete Assembled Unit.

68 Mount Kit. Hardware from O.E. Part may need to be reused.;

53 Hardware from O.E. Part may need to be reused.

APPLICATION GUIDE

Year	Fitment Notes										
		Ultra	Ready Mounts	Max Control\ LTV Severe Duty\ ProGuard\ Guardian	Strut Cushion\ Strut Mount\ Dampers\ Stabilizer	HiJackers\ Load Carrier\ Classic	Ultra	Ready Mounts	Max Control\ LTV Severe Duty\ ProGuard\ Guardian	Strut Cushion\ Strut Mount\ Dampers\ Stabilizer	HiJackers\ Load Carrier\ Classic

LEXUS

LEXUS

LX450

96-97	All		G63615		G63616
-------	-----	--	--------	------	------	------	------	--	--------	------	------	------	------

LX470

07	All		G63832		G63828
98-06	Torsion Bar(FrontSpringType)		G63832		G63828

NX200T

15-17	All			G64151
-------	-----	--	------	------	------	------	------	--	--------	------	------	------	------

RX300

99-03	Left		142650 ⁵⁴
	Right		142649 ⁵⁴
	AWD, Left		G57614 ⁴⁰	G57650 ⁴⁰
	AWD, Right		G57615 ⁴⁰	G57651 ⁴⁰
	FWD, Left			G56554	G57612 ⁴⁰
	FWD, Right		G57613 ⁴⁰

RX330

04-06	All		143202 ⁵⁴
	Left Exc. Air Suspension		G56730	143202 ⁵⁴	143387 ⁶⁸
	Right Exc. Air Suspension		G56731	143202 ⁵⁴	143388 ⁶⁸
	AWD, Left		G57150 ⁴⁰	143202 ⁵⁴
	AWD, Left Exc. Air Suspension		143202 ⁵⁴		G56732
	AWD, Left Non Japan built applications with a clevice mounting hole dimension of 15mm		143202 ⁵⁴	G57152 ⁴⁰
	AWD, Right		G57151 ⁴⁰	143202 ⁵⁴
	AWD, Right Exc. Air Suspension		143202 ⁵⁴		G56733
	AWD, Right Non Japan built applications with a clevice mounting hole dimension of 15mm		143202 ⁵⁴	G57153 ⁴⁰
	FWD, Left		143202 ⁵⁴	G57533 ⁴⁰
	FWD, Left Exc. Air Suspension		143202 ⁵⁴		G56734
	FWD, Right		143202 ⁵⁴	G57534 ⁴⁰
FWD, Right Exc. Air Suspension		143202 ⁵⁴		G56735	

RX350

15-17	All			G64163 ¹
-------	-----	--	------	------	------	------	------	--	---------------------	------	------	------	------



1 Future Part

54 Kit with Mount and Bearing. Hardware from O.E. Part may need to be reused.

40 Complete Assembled Unit.

68 Mount Kit. Hardware from O.E. Part may need to be reused.;

APPLICATION GUIDE

Year	Fitment Notes										
		Ultra	Ready Mounts	Max Control\ LTV Severe Duty\ ProGuard\ Guardian	Strut Cushion\ Strut Mount\ Dampers\ Stabilizer	HiJackers\ Load Carrier\ Classic	Ultra	Ready Mounts	Max Control\ LTV Severe Duty\ ProGuard\ Guardian	Strut Cushion\ Strut Mount\ Dampers\ Stabilizer	HiJackers\ Load Carrier\ Classic

LEXUS

LEXUS

RX350 (cont)

11-14	Left		G57562 ⁴⁰		G64163 ¹
	Right		G57563 ⁴⁰		G64163 ¹
10	Left		G57562 ⁴⁰
	Right		G57563 ⁴⁰
07-09	Left Exc. Air Suspension		G56730	143387 ⁶⁸
	Right Exc. Air Suspension		G56731	143388 ⁶⁸
	AWD, Left Non Japan built applications with a clevice mounting hole dimension of 15mm			G57152 ⁴⁰
	AWD, Right Non Japan built applications with a clevice mounting hole dimension of 15mm			G57153 ⁴⁰
	FWD, Left		G57150 ⁴⁰		G57533⁴⁰
	FWD, Left Exc. Air Suspension			G56734
	FWD, Right		G57151 ⁴⁰		G57534⁴⁰
	FWD, Right Exc. Air Suspension			G56735
07	AWD, Left Exc. Air Suspension			G56732
	AWD, Right Exc. Air Suspension			G56733

RX400H

08	Left		143387 ⁶⁸
	Right		143388 ⁶⁸
06-07	Left		143202 ⁵⁴	143387 ⁶⁸
	Right		143202 ⁵⁴	143388 ⁶⁸
06	FWD, Left			G57586 ⁴⁰
	FWD, Right			G57587 ⁴⁰

SC430

02-07	All		G56598
05	Mfg to 0/05; For Large Spring Seat Design 134MM or 5.275 Inches		G56598		G51995
02-04	For Large Spring Seat Design 134MM or 5.275 Inches		G56598		G51995

LINCOLN

LINCOLN

AVIATOR

03-05	All		G51836
-------	-----	--	--------	-------	-------	-------	-------	--	-------	-------	-------	-------	-------

1 Future Part





54 Kit with Mount and Bearing. Hardware from O.E. Part may need to be reused.

Bold Type - New / Future Part

40 Complete Assembled Unit.

68 Mount Kit. Hardware from O.E. Part may need to be reused.;







APPLICATION GUIDE

Year	Fitment Notes										
		 Ultra	Ready Mounts	Max Control\ LTV Severe Duty\ ProGuard\ Guardian	Strut Cushion\ Strut Mount\ Dampers\ Stabilizer	HiJackers\ Load Carrier\ Classic	 Ultra	Ready Mounts	Max Control\ LTV Severe Duty\ ProGuard\ Guardian	Strut Cushion\ Strut Mount\ Dampers\ Stabilizer	HiJackers\ Load Carrier\ Classic



LINCOLN

LINCOLN



CONTINENTAL

82-87	All		143059 ⁵¹	
70-80	All		69675 ⁵	81446	34073 ⁸		69606	81495	43140 ⁹ 49205 ⁷
61-69	All		82615	





LS

00-04	All		G51756	
-------	-----	-----------------------------------------------------------------------------------	--------	------	------	------	------	-----------------------------------------------------------------------------------	------	------	------	------	------











MARK III

68-71	All		69675 ⁵	81446	34073 ⁸		69606	81495	43140 ⁹ 49205 ⁷
-------	-----	-----------------------------------------------------------------------------------	--------------------	------	-------	------	--------------------	-----------------------------------------------------------------------------------	-------	------	-------	------	------------------------------------------



MARK IV

73-76	All		69675 ⁵	81446	34073 ⁸	
72	All		69675 ⁵	81446	34073 ⁸		69606	81495	43140 ⁹ 49205 ⁷



MARK LT

10-12	All			G64079
	AWD		G51864		G64079
06-08	All		143248 ⁵³	
	4WD		G51704	G57020 ⁴⁰	143248 ⁵³		G63867
	RWD		G51703	G57021 ⁴⁰	143248 ⁵³		G63870



MARK V

77-79	All		69675 ⁵	81446	34073 ⁸	
-------	-----	-------------------------------------------------------------------------------------	--------------------	------	-------	------	--------------------	-------------------------------------------------------------------------------------	------	------	------	------	------







MARK VI

80-83	All		69675 ⁵	81446	34073 ⁸		69606	81495	43140 ⁹ 49205 ⁷
-------	-----	-------------------------------------------------------------------------------------	--------------------	------	-------	------	--------------------	-------------------------------------------------------------------------------------	-------	------	-------	------	------------------------------------------



MARK VII

84-92	All		143059 ⁵¹	
-------	-----	-------------------------------------------------------------------------------------	------	------	------	----------------------	------	-------------------------------------------------------------------------------------	------	------	------	------	------





MKS

09-12	All			70096
	Left w/ Suspension Code A and B		G52398		70096
	Right w/ Suspension Code A and B		G52399		70096

MKT

10-17	All			G51996
-------	-----	-------------------------------------------------------------------------------------	------	------	------	------	------	-------------------------------------------------------------------------------------	--------	------	------	------	------

MKX

16-18	Left		G57752 ⁴⁰	
	Right		G57753 ⁴⁰	

5 Use kit No. 140719 to replace O.E. hardware for lower shock absorber mounting when studs break or self-tapping screws are not longer useable.



8 Pair Packs.

7 Pair Packs, Air hose kit included.

40 Complete Assembled Unit.

53 Hardware from O.E. Part may need to be reused.

















APPLICATION GUIDE

Year	Fitment Notes										
		Ultra	Ready Mounts	Max Control\ LTV Severe Duty\ ProGuard\ Guardian	Strut Cushion\ Strut Mount\ Dampers\ Stabilizer	HiJackers\ Load Carrier\ Classic	Ultra	Ready Mounts	Max Control\ LTV Severe Duty\ ProGuard\ Guardian	Strut Cushion\ Strut Mount\ Dampers\ Stabilizer	HiJackers\ Load Carrier\ Classic







LINCOLN

MKX (cont)



























LINCOLN

11-15	Left		G52351		G64111
	Right		G52352		G64111
11-14	FWD, Left		G57582 ⁴⁰	
	FWD, Right		G57583 ⁴⁰	
10	Left		G56840	143415 ⁵³	
	Right		G56841	143415 ⁵³	
07-09	Left		G56840	143415 ⁵³		G64037
	Right		G56841	143415 ⁵³		G64037

MKZ

10-12	Left		G51896	G57427 ⁴⁰	
	Right		G51897	G57427 ⁴⁰	
	FWD			G69591
07-09	All		G51859	
	FWD		G51859		G69591

NAVIGATOR

17-20	Exc. Adaptive Suspension		G57683⁴⁰	
17	Exc. Air Suspension			G51861	G57173 ⁴⁰	143393 ⁶⁸
14-16	All		143424 ⁶⁸	
	Exc. Adaptive Suspension		G57683⁴⁰	143424 ⁶⁸	
	Exc. Air Suspension		143424 ⁶⁸		G51861
	4WD, RWD, Exc. Air Suspension		143424 ⁶⁸		G57173 ⁴⁰	143393 ⁶⁸
11-13	Exc. Air Suspension		G51860	G57172 ⁴⁰	143424 ⁶⁸		G51861
	4WD, RWD, Exc. Air Suspension		G51860	143424 ⁶⁸		G57173 ⁴⁰	143393 ⁶⁸
07-13	All		G51860	143424 ⁶⁸	
10	Exc. Air Suspension		G51860	G57172 ⁴⁰	143424 ⁶⁸		G51861	143393 ⁶⁸
	4WD, RWD, Exc. Air Suspension		G51860	143424 ⁶⁸		G57173 ⁴⁰
07-09	Exc. Air Suspension		G51860	143424 ⁶⁸		G51861	143393 ⁶⁸
06	All		G57015 ⁴⁰		G51729	G57016 ⁴⁰



40 Complete Assembled Unit.

68 Mount Kit. Hardware from O.E. Part may need to be reused.;

Bold Type - New / Future Part

53 Hardware from O.E. Part may need to be reused.

APPLICATION GUIDE

Year	Fitment Notes										
		Ultra	Ready Mounts	Max Control\ LTV Severe Duty\ ProGuard\ Guardian	Strut Cushion\ Strut Mount\ Dampers\ Stabilizer	HiJackers\ Load Carrier\ Classic	Ultra	Ready Mounts	Max Control\ LTV Severe Duty\ ProGuard\ Guardian	Strut Cushion\ Strut Mount\ Dampers\ Stabilizer	HiJackers\ Load Carrier\ Classic

LINCOLN

LINCOLN

NAVIGATOR (cont)

03-05	All	↓	G57015 ⁴⁰	143244 ⁵³	↓	G51729	G57016 ⁴⁰
98-02	4WD, Air(RearSpringType)	↓	↓	G64002	61703
	Coil(FrontSpringType)	↓	61611	↓
	RWD	↓	G63714	58714 77714 81912	↓	G63717	61614 77717

TOWN CAR

03-11	Limo Models	↓	G51888	↓	69574
	Model Limo	↓	79901	↓
	Exc. Limo	↓	G51887	G57080 ⁴⁰	143357 ⁶⁸	↓	69575
03-06	Mfg to 12/05	↓	79900	↓
81-02	All	↓	69675 ⁵	81446	34073 ⁸	↓	69606	81495	43140 ⁸ 49205 ⁷

VERSAILLES

77-80	All	↓	81491	↓	82130
-------	-----	---	------	------	-------	------	------	---	------	------	------	------	-------

ZEPHYR

06	All	↓	G51859	↓	69591
----	-----	---	--------	------	------	------	------	---	-------	------	------	------	------

MAZDA

MAZDA

2

12-14	All	↓	143399 ⁵⁴	↓	70052
11	All	↓	143399 ⁵⁴	↓	70052	143400 ⁵³

3

14-17	All	↓	↓	70207
12-13	All	↓	↓	G51983
	Mazdaspeed; Exc. Turbo Left	↓	G52449	↓	G51983
	Mazdaspeed; Exc. Turbo Right	↓	G52450	↓	G51983
13	Exc. Mazdaspeed Left	↓	G52005	↓	G51983
	Exc. Mazdaspeed Right	↓	G52006	↓	G51983
12	Exc. Mazdaspeed Left	↓	G52005	143365 ⁶⁸	↓	G51983
	Exc. Mazdaspeed Right	↓	G52006	143365 ⁶⁸	↓	G51983
10-11	All	↓	↓	G51983	143531 ⁵³
	Exc. Mazdaspeed Left	↓	G52005	143365 ⁵³	↓	G51983	143531 ⁵³
	Exc. Mazdaspeed Right	↓	G52006	143365 ⁵³	↓	G51983	143531 ⁵³

5 Use kit No. 140719 to replace O.E. hardware for lower shock absorber mounting when studs break or self-tapping screws are not longer useable.

8 Pair Packs.



53 Hardware from O.E. Part may need to be reused.

7 Pair Packs, Air hose kit included.

40 Complete Assembled Unit.

54 Kit with Mount and Bearing. Hardware from O.E. Part may need to be reused.





























APPLICATION GUIDE

Year	Fitment Notes										
		Ultra	Ready Mounts	Max Control\ LTV Severe Duty\ ProGuard\ Guardian	Strut Cushion\ Strut Mount\ Dampers\ Stabilizer	HiJackers\ Load Carrier\ Classic	Ultra	Ready Mounts	Max Control\ LTV Severe Duty\ ProGuard\ Guardian	Strut Cushion\ Strut Mount\ Dampers\ Stabilizer	HiJackers\ Load Carrier\ Classic





MAZDA

MAZDA













3 (cont)

10-11	Mazdaspeed; Exc. Turbo Left		G52449		G51983	143531 ⁵³
	Mazdaspeed; Exc. Turbo Right		G52450		G51983	143531 ⁵³
07-09	All			143531 ⁵³
	Exc. Mazdaspeed		143365 ⁵³		70003	143531 ⁵³
	Exc. Mazdaspeed; Turbo w/17" Wheels Left		G52005		143531 ⁵³
	Exc. Mazdaspeed; Turbo w/17" Wheels Right		G52006		143531 ⁵³
	Mazdaspeed; Exc. Turbo w/17" Wheels Left		G52449		143531 ⁵³
	Mazdaspeed; Exc. Turbo w/17" Wheels Right		G52450		143531 ⁵³
05-06	All			70003	143531 ⁵³
	Exc. Mazdaspeed Left		G52005	143365 ⁵³		70003	143531 ⁵³
	Exc. Mazdaspeed Right		G52006	143365 ⁵³		70003	143531 ⁵³
04	All			70003	143531 ⁶⁷
	Exc. Mazdaspeed Left		G52005	143365 ⁵³		70003	143531 ⁶⁷
	Exc. Mazdaspeed Right		G52006	143365 ⁵³		70003	143531 ⁶⁷







5

06-10	Left		G52005	143365 ⁵⁸		70003	143531 ⁵³
	Right		G52006	143365 ⁵⁸		70003	143531 ⁵³

6

09-13	Left		G57455 ⁴⁰	
	Right		G57456 ⁴⁰	
	i, Left		G57594 ⁴⁰	
	i, Right		G57595 ⁴⁰	
03-08	Left		G51810	G57270 ⁴⁰		69591
	Right		G51811	G57270 ⁴⁰		69591

323

90-94	All		142854 ⁵⁴ 143057 ⁵¹		M55848
86-89	Exc. Electronic Adjustable Suspension		142183 ⁵³	
	FWD		143058 ⁵¹		143058 ⁵¹

40 Complete Assembled Unit.

53 Hardware from O.E. Part may need to be reused.



67 Mount Kit. Hardware from O.E. Part may need to be reused.

51 Strut Cushion for use with the Strut/Cartridge/Shocks.

54 Kit with Mount and Bearing. Hardware from O.E. Part may need to be reused.























68 Mount Kit. Hardware from O.E. Part may need to be reused.;

APPLICATION GUIDE



Year	Fitment Notes										
		Ultra	Ready Mounts	Max Control\ LTV Severe Duty\ ProGuard\ Guardian	Strut Cushion\ Strut Mount\ Dampers\ Stabilizer	HiJackers\ Load Carrier\ Classic	Ultra	Ready Mounts	Max Control\ LTV Severe Duty\ ProGuard\ Guardian	Strut Cushion\ Strut Mount\ Dampers\ Stabilizer	HiJackers\ Load Carrier\ Classic

MAZDA



626

98-02	Left		G56689	143218 ⁵³	
	Right		G56690	143218 ⁵³	
93-97	All		142856 ⁵⁴		143057 ⁵¹
	Left		142856 ⁵⁴		142403 ⁵³ 143057 ⁵¹
	Right		142856 ⁵⁴		142404 ⁵³ 143057 ⁵¹
88-92	Exc. Electronic Adjustable Suspension or 4 Wheel Steer		G55600 ⁹		142196 ⁵³ 143057 ⁵¹
	Automatic Exc. Electronic Adjustable Suspension or 4 Wheel Steer		142569 ⁶¹ 142852 ⁵⁴	
86-87	Automatic Exc. Electronic Adjustable Suspension		143057 ⁵¹		143057 ⁵¹
	Manual Exc. Electronic Adjustable Suspension		142855 ⁵⁴	
83-85	All		143057 ⁵¹		143057 ⁵¹
	Exc. Electronic Adjustable Suspension		142855 ⁵⁴ 143057 ⁵¹		143057 ⁵¹



808

72-77	Wagon Exc. Models w/ Tokico OE Struts			81270
-------	---------------------------------------	-------------------------------------------------------------------------------------	------	------	------	------	------	-------------------------------------------------------------------------------------	------	------	-------	------	------





B1600

72-76	All		G63421	58421 61504 81750		82125
-------	-----	-------------------------------------------------------------------------------------	--------	------	------	-------------------------	------	-------------------------------------------------------------------------------------	------	------	------	------	-------





B1800

77-78	All		G63421	58421 61504 81750		82125
-------	-----	-------------------------------------------------------------------------------------	--------	------	------	-------------------------	------	-------------------------------------------------------------------------------------	------	------	------	------	-------





B2000

86-87	RWD		G63495	61593 81553		G63907	61500 77907 81147	43048 ⁸ 49310 ⁷
79-84	All		G63421	58421 61504 81750		82125

B2200

87-93	RWD		G63495	61593 81553		G63907	61500 77907 81147	43048 ⁸ 49310 ⁷
82-84	All		G63421	58421 61504 81750		82125

B2300

07-09	RWD		G63772	61626 77772 81916		61627 77525
01-06	RWD		G63772	61626 77772 81916		G63773	61627 77525

7 Pair Packs, Air hose kit included.

9 See Ref. D for procedures to replace Elec Adj Susp with non-adj product.

53 Hardware from O.E. Part may need to be reused.





61 Mount Kit includes Upper Spring Seat. Hardware from O.E. Part may need to be

8 Pair Packs.

51 Strut Cushion for use with the Strut/Cartridge/Shocks.

54 Kit with Mount and Bearing. Hardware from O.E. Part may need to be reused.





APPLICATION GUIDE

Year	Fitment Notes										
		 Ultra	Ready Mounts	Max Control\ LTV Severe Duty\ ProGuard\ Guardian	Strut Cushion\ Strut Mount\ Dampers\ Stabilizer	HiJackers\ Load Carrier\ Classic	 Ultra	Ready Mounts	Max Control\ LTV Severe Duty\ ProGuard\ Guardian	Strut Cushion\ Strut Mount\ Dampers\ Stabilizer	HiJackers\ Load Carrier\ Classic







MAZDA

MAZDA



B2300 (cont)

94-97	All		G63614	58929 61561 77614 81744 ⁴⁸	34076 ⁸		
	RWD		G63614	58929 61561 77614 81744 ⁴⁸	34076 ⁸		G63525	61559 77525 81730	49223 ⁷
95-96	4WD		G63614	58929 61561 77614 81744 ⁴⁸	34076 ⁸		G63524	61573 77524 81905



























B2500

01	All			G63773
	Coil(FrontSpringType)			G63773	81917
	RWD		G63772	61626 77772 81916		G63773	61627 77525
98-00	All			G63773	81917
	RWD		G63772	61626 77772 81916		G63773	61627 77525 81917



B2600

87-93	4WD		G63635
	RWD		G63495	61593 81553		G63907	61500 77907 81147	43048 ⁸ 49310 ⁷

B3000

03-07	RWD, Coil(FrontSpringType)			81917
07	4WD		77678 81893		G63775	61629 77524
	4WD		G63678	61623		81918
	RWD		G63772	61626 77772 81916		61627 77525
98-06	RWD		G63772	61626 77772 81916		G63773	61627 77525
06	4WD			G63775
	4WD		G63678	61623 77678 81893		61629 77524 81918
05	4WD		G63678	61623 77678 81893		G63775	61629 77524 81918
04	4WD		61623 77678 81893		61629 77524 81918
03	4WD		G63678	61623 77678 81893		61629 77524 81918
98-02	4WD		77678 81893		G63775	61629 77524 81918
	4WD		G63678	61623	
02	RWD, Coil (FrontSpringType)			81917
98-01	RWD, Coil(FrontSpringType)			81917
94-97	All		G63614	61561 81744 ⁴⁸	34076 ⁸	

APPLICATION GUIDE

Year	Fitment Notes										
		Ultra	Ready Mounts	Max Control\ LTV Severe Duty\ ProGuard\ Guardian	Strut Cushion\ Strut Mount\ Dampers\ Stabilizer	HiJackers\ Load Carrier\ Classic	Ultra	Ready Mounts	Max Control\ LTV Severe Duty\ ProGuard\ Guardian	Strut Cushion\ Strut Mount\ Dampers\ Stabilizer	HiJackers\ Load Carrier\ Classic

MAZDA

MAZDA

B3000 (cont)

94-97	4WD		G63614	61561 81744 ⁴⁸	34076 ⁸		G63524	81905
	RWD		G63614	77614 61561 81744 ⁴⁸	34076 ⁸		G63525	61559 77525 81730

B4000

07-09	4WD		G63678	61623 77678 81893		G63775	61629 77524 81918
	RWD		61626 77772 81916	61627 77525
01-09	RWD, Coil (FrontSpringType)		81917
05-06	4WD		G63678	61623 77678 81893		G63775	61629 77524
98-06	RWD		G63772	61626 77772 81916		G63773	61627 77525
98-04	4WD		G63678	61623 77678 81893		G63775	61629 77524 81918
98-00	RWD, Coil(FrontSpringType)		81917
94-97	All		G63614	81744 ⁴⁸	34076 ⁸	
	4WD		G63614	81744 ⁴⁸	34076 ⁸		G63524	81905
	RWD		G63614	61561 77614 81744 ⁴⁸	34076 ⁸		G63525	61559 77525

CX-5

13-18	All			G511078
-------	-----	--	------	------	------	------	------	--	---------	------	------	------	------

CX-7

11-12	Left		G57361 ⁴⁰
	Right		G57362 ⁴⁰
07-10	Left		G52209	G57361 ⁴⁰		G64056
	Right		G52210	G57362 ⁴⁰		G64056

CX-9

10-15	Left		G52260	G57714 ⁴⁰
	Right		G52261	G57715 ⁴⁰
07-09	Left		G52260
	Right		G52261

GLC

84-85	All		143057 ⁵¹
	Hatchback		142183 ⁵³ 143059 ⁵¹	143057 ⁵¹
	Sedan		142183 ⁵³ 143059 ⁵¹	143057 ⁵¹





8 Pair Packs.

48 Installation Hardware Included

40 Complete Assembled Unit.









51 Strut Cushion for use with the Strut/Cartridge/Shocks.

APPLICATION GUIDE

Year	Fitment Notes										
		 Ultra	Ready Mounts	Max Control\ LTV Severe Duty\ ProGuard\ Guardian	Strut Cushion\ Strut Mount\ Dampers\ Stabilizer	HiJackers\ Load Carrier\ Classic	 Ultra	Ready Mounts	Max Control\ LTV Severe Duty\ ProGuard\ Guardian	Strut Cushion\ Strut Mount\ Dampers\ Stabilizer	HiJackers\ Load Carrier\ Classic











MAZDA

GLC (cont)



81-83	Hatchback		142183 ⁵³ 143059 ⁵¹		143057 ⁵¹
	Sedan		142183 ⁵³ 143059 ⁵¹		143057 ⁵¹
79-83	Wagon			81270	49105 ⁷
78	All			81270	49105 ⁷

MAZDA



MIATA

04-05	Base, LS			G56597
03	Base, LS, SE			G56597
99-01	All			G56597
91-97	Non-ABS			143064 ⁵¹
90	All			143064 ⁵¹



MPV

00-06	All		143061 ⁵¹		G63864
-------	-----	------------------------------------------------------------------------------------	------	------	------	----------------------	------	--------------------------------------------------------------------------------------	--------	------	------	------	------















MX-5

06-08	All		G51906	
-------	-----	-------------------------------------------------------------------------------------	--------	------	------	------	------	---------------------------------------------------------------------------------------	------	------	------	------	------





MX-5 MIATA

06-08	All		G51906	143412 ⁵⁷		143412 ⁵⁷
-------	-----	-------------------------------------------------------------------------------------	--------	------	------	----------------------	------	---------------------------------------------------------------------------------------	------	------	------	----------------------	------

MX6

93-97	All		142856 ⁵⁴		143057 ⁵¹
	Left		142856 ⁵⁴		142403 ⁵³ 143057 ⁵¹
	Right		142856 ⁵⁴		142404 ⁵³ 143057 ⁵¹
89-92	Automatic		142569 ⁵¹		143057 ⁵¹
88-92	All			143057 ⁵¹
	Exc. Electronic Adjustable Suspension or 4 Wheel Steer		G55600 ⁹		142196 ⁵³ 143057 ⁵¹
	Automatic Exc. Electronic Adjustable Suspension or 4 Wheel Steer		142852 ⁵⁴		143057 ⁵¹

NAVAJO

91-94	All		G63608	58929 61591 77608 81744 ⁴⁸	34076 ⁸		G63607	61590 77607 81823
	All models with factory frame bracket. Kit 143168 required to install to linkage.		G63608	58929 61591 77608 81744 ⁴⁸	6802SE ⁸⁴	34076 ⁸		G63607	61590 77607 81823

7 Pair Packs, Air hose kit included.

9 See Ref. D for procedures to replace Elec Adj Susp with non-adj product.

51 Strut Cushion for use with the Strut/Cartridge/Shocks.

54 Kit with Mount and Bearing. Hardware from O.E. Part may need to be reused.

67 Mount Kit. Hardware from O.E. Part may need to be reused.

8 Pair Packs.



48 Installation Hardware Included

53 Hardware from O.E. Part may need to be reused.

61 Mount Kit includes Upper Spring Seat. Hardware from O.E. Part may need to be reused.

84 Replacement damper for vehicles with the Gabriel Aftermarket mounting kit

APPLICATION GUIDE

Year	Fitment Notes										
		Ultra	Ready Mounts	Max Control\ LTV Severe Duty\ ProGuard\ Guardian	Strut Cushion\ Strut Mount\ Dampers\ Stabilizer	HiJackers\ Load Carrier\ Classic	Ultra	Ready Mounts	Max Control\ LTV Severe Duty\ ProGuard\ Guardian	Strut Cushion\ Strut Mount\ Dampers\ Stabilizer	HiJackers\ Load Carrier\ Classic

MAZDA

MAZDA

PROTG / PROTG5

02-03	Left	↓	143057 ⁵¹	↓	G56538	G57509 ⁴⁰	143058 ⁵¹
	Right	↓	143057 ⁵¹	↓	G56537	G57510 ⁴⁰	143058 ⁵¹
01-03	Exc. MP3 and Mazdaspeed Models Left	↓	143057 ⁵¹	↓	G56538	143058 ⁵¹
	Exc. MP3 and Mazdaspeed Models Right	↓	143057 ⁵¹	↓	G56537	143058 ⁵¹
00-03	All	↓	143057 ⁵¹	↓	143058 ⁵¹
	Left Mfg. from 10/00	↓	G56634	143057 ⁵¹	↓	143058 ⁵¹
	Right Mfg. from 10/00	↓	G56633	143057 ⁵¹	↓	143058 ⁵¹
99-00	Left	↓	143057 ⁵¹	↓	G56538	143058 ⁵¹
	Right	↓	143057 ⁵¹	↓	G56537	143058 ⁵¹
95-98	All	↓	142851 ⁵⁴ 143057 ⁵¹	↓	143058 ⁵¹
92-94	All	↓	143057 ⁵¹	↓	143058 ⁵¹
	FWD, Non-ABS	↓	142854 ⁵⁴ 143057 ⁵¹	↓	M55848	143058 ⁵¹
90-91	All	↓	142854 ⁵⁴ 143057 ⁵¹	↓
	FWD	↓	142854 ⁵⁴ 143057 ⁵¹	↓	143058 ⁵¹
	FWD, Non-ABS	↓	142854 ⁵⁴ 143057 ⁵¹	↓	M55848

RX3

75-76	Wagon	↓	↓	81270
	Wagon Exc. Models w/ Tokico OE Struts	↓	↓	49105 ⁷
74	All	↓	↓	49105 ⁷
	Wagon	↓	↓	81270	49105 ⁷
72-73	All	↓	↓	81270	49105 ⁷

RX4

74-78	All	↓	↓	81270	49105 ⁷
-------	-----	---	------	------	------	------	------	---	------	------	-------	------	--------------------

RX7

86-91	All	↓	143059 ⁵¹	↓	143063 ⁵¹
-------	-----	---	------	------	------	----------------------	------	---	------	------	------	----------------------	------

TRIBUTE

08-11	Left	↓	G56601	G57045 ⁴⁰	↓	G64047
	Right	↓	G56568	G57046 ⁴⁰	↓	G64047
01-06	Left	↓	G56601	G57045 ⁴⁰	↓	69900 G63862
	Right	↓	G56568	G57046 ⁴⁰	↓	69900 G63862



7 Pair Packs, Air hose kit included.

168 51 Strut Cushion for use with the Strut/Carrier/Shocks.

40 Complete Assembled Unit.

54 Kit with Mount and Bearing. Hardware from O.E. Part may need to be reused.

APPLICATION GUIDE

Year	Fitment Notes										
		Ultra	Ready Mounts	Max Control\ LTV Severe Duty\ ProGuard\ Guardian	Strut Cushion\ Strut Mount\ Dampers\ Stabilizer	HiJackers\ Load Carrier\ Classic	Ultra	Ready Mounts	Max Control\ LTV Severe Duty\ ProGuard\ Guardian	Strut Cushion\ Strut Mount\ Dampers\ Stabilizer	HiJackers\ Load Carrier\ Classic

MERCEDES-BENZ

190SL

62-63	All		82069
-------	-----	--	-------	------	------	------	------	------	------	------	-------

200D

68-73	All	
-------	-----	--	-------	------	------	------	------	------	------	------	------

220 / 220D

68-73	All	
-------	-----	--	-------	------	------	------	------	------	------	------	------

230

77-78	Exc. W115	IO	69996
74-78	All	
68-69	All	

240D

76-83	W123	IO	69996
74-83	All	

250

68-70	All	
-------	-----	--	-------	------	------	------	------	------	------	------	------

260E

87-89	Exc. Hydromat Suspension	IO	69996
-------	--------------------------	----	-------	------	------	------	------	------	------	------	------

280

76	All	IO	69996
----	-----	----	-------	------	------	------	------	------	------	------	------

280C

73-76	All	
76	Exc. W115	IO	69996

280CE / 280E / 280S / 280SE / 280SEL

77-81	All	IO	69996
75-80	Exc. Hydromat Suspension	IO	69996
73	Exc. Hydromat Suspension	IO	69996
72	Mfg. from 9/72; Exc. Hydromat Suspension	IO	69996

300CD

80-85	All	IO	69996
-------	-----	----	-------	------	------	------	------	------	------	------	------

300D

76-84	W123	IO	69996
75	W123	





300SD / 300SDL / 300SE / 300SEL / 300TD / 350SD / 350SDL / 350SL / 380SE / 380SEC / 380SEL

78-91	Exc. Hydromat Suspension	IO	69996
79-85	All	IO	69996
72	All	

380SL / 380SLC





81-85	All	
-------	-----	--	-------	------	------	------	------	------	------	------	------

APPLICATION GUIDE



Year	Fitment Notes										
		 Ultra	Ready Mounts	Max Control\ LTV Severe Duty\ ProGuard\ Guardian	Strut Cushion\ Strut Mount\ Dampers\ Stabilizer	HiJackers\ Load Carrier\ Classic	 Ultra	Ready Mounts	Max Control\ LTV Severe Duty\ ProGuard\ Guardian	Strut Cushion\ Strut Mount\ Dampers\ Stabilizer	HiJackers\ Load Carrier\ Classic

MERCEDES-BENZ

400E / 400SE / 400SEL / 420SEL / 450SE / 450SEL

86-91	Exc. Hydromat Suspension		69996		69766
73-80	Exc. Hydromat Suspension		69996		69766



450SL / 450SLC

74-80	All			69766
-------	-----	-----------------------------------------------------------------------------------	------	------	------	------	------	-----------------------------------------------------------------------------------	-------	------	------	------	------









500SEC / 500SEL / 500SEC / 560SEC / 560SEL

84-91	Exc. Hydromat Suspension		69996		69766
-------	--------------------------	-----------------------------------------------------------------------------------	-------	------	------	------	------	-----------------------------------------------------------------------------------	-------	------	------	------	------







C220

94-96	All		69877	
-------	-----	-----------------------------------------------------------------------------------	-------	------	------	------	------	-----------------------------------------------------------------------------------	------	------	------	------	------









C230

02-07	All			70033
	RWD; Exc. Sport Suspension		G56791		70033
	RWD; w/ Sport Suspension		G56792		70033
97-00	All		69877	











C240

01-05	RWD			70033
	RWD; Exc. Sport Suspension		G56791	
	RWD; w/ Sport Suspension		G56792	









C250

13-15	Exc. Electronic Suspension			70038
12	All			70038
	CGI(FuelDelSubType), Sedan		G52172		70038
10-11	All		G52172		70038

C280

08-09	All		G52172		70038
06-07	RWD			70033
	RWD; Exc. Sport Suspension		G56791	
	RWD; w/ Sport Suspension		G56792	
94-00	All		69877	

C300

08-11	All			70038
11	Elegance, Luxury		G52172		70038
10	Base, Classic, Elegance, Luxury		G52172		70038
08-09	Base, Luxury		G52172		70038

APPLICATION GUIDE

Year	Fitment Notes										
		Ultra	Ready Mounts	Max Control\ LTV Severe Duty\ ProGuard\ Guardian	Strut Cushion\ Strut Mount\ Dampers\ Stabilizer	HiJackers\ Load Carrier\ Classic	Ultra	Ready Mounts	Max Control\ LTV Severe Duty\ ProGuard\ Guardian	Strut Cushion\ Strut Mount\ Dampers\ Stabilizer	HiJackers\ Load Carrier\ Classic

MERCEDES-BENZ

C320

01-05	RWD	70033
	RWD Sedan & Wagon; Exc. Sport Suspension	↓	G56791
	RWD; w/ Sport Suspension	↓	G56792

C350

12	Base
	CGI(FuelDelSubType)	↓	70038
09-11	All	↓	70038
10	Base	↓	G52172	70038
09	Base, Elegance	↓	G52172	70038
08	All	↓	G52172	70038
	Base	↓	G52172	70038
06-07	Exc. AWD & Sport Suspension	↓	G56791
	RWD	↓	70033
	RWD; w/ Sport Suspension	↓	G56792

CLK320

03-05	All	70033
	RWD; Exc. Sport Suspension	↓	G56791	70033
	RWD; w/ Sport Suspension	↓	G56792	70033
98-02	All	↓	70064	70065
02	RWD; Exc. Sport Suspension	↓	G56791	70065
	RWD; w/ Sport Suspension	↓	G56792	70065





CLK350

06-09	All	70033
	RWD; Exc. Sport Suspension	↓	G56791	70033
	RWD; w/ Sport Suspension	↓	G56792	70033

CLK430



03	All	70033
	RWD; Exc. Sport Suspension	↓	G56791	70033
	RWD; w/ Sport Suspension	↓	G56792	70033
02	All	↓	70064
	Mfg. from 4/02	↓	70064	70033
	Mfg. to 4/02	↓	70064	70065
	RWD; Exc. Sport Suspension	↓	G56791

APPLICATION GUIDE

Year	Fitment Notes										
		 Ultra	Ready Mounts	Max Control\ LTV Severe Duty\ ProGuard\ Guardian	Strut Cushion\ Strut Mount\ Dampers\ Stabilizer	HiJackers\ Load Carrier\ Classic	 Ultra	Ready Mounts	Max Control\ LTV Severe Duty\ ProGuard\ Guardian	Strut Cushion\ Strut Mount\ Dampers\ Stabilizer	HiJackers\ Load Carrier\ Classic





MERCEDES-BENZ

CLK430 (cont)



02	RWD; w/ Sport Suspension		G56792			
99-01	All		70064		70065

MERCEDES-BENZ

CLK500

03-06	All			70033
	RWD; Exc. Sport Suspension		G56791		70033
	RWD; w/ Sport Suspension		G56792		70033





CLK550

07-09	All			70033
	RWD; Exc. Sport Suspension		G56791		70033



E55 AMG

00-02	All		69952
-------	-----	-----------------------------------------------------------------------------------	-------	-----	-----	-----	-----	-----	-----	--	-----	-----	-----	-----	-----





E300

99	Exc. 4 Matic			69966
	Exc. Sport Suspension		69952
96-98	All			69966
	Exc. Sport Suspension		69952		69966





E320

96-06	Exc. 4 Matic		143086 ⁵³
96-02	Sedan			69966
	Sedan Exc. Sport Suspension		69952

E420

97	All			69966
	Exc. 4 Matic		143086 ⁵³		69966
	Exc. 4 Matic & Sport Suspension		69952		69966

E430

98-02	All			69966
	Exc. 4 Matic		143086 ⁵³		69966
	Exc. 4 Matic & Sport Suspension		69952		69966

ML55 AMG

00-03	All		G64049
-------	-----	-------------------------------------------------------------------------------------	--------	-----	-----	-----	-----	-----	-----	--	-----	-----	-----	-----	-----



ML320

98-03	All		G64049
-------	-----	-------------------------------------------------------------------------------------	--------	-----	-----	-----	-----	-----	-----	--	-----	-----	-----	-----	-----

ML350

03-05	All		G64049
-------	-----	-------------------------------------------------------------------------------------	--------	-----	-----	-----	-----	-----	-----	--	-----	-----	-----	-----	-----

APPLICATION GUIDE

Year	Fitment Notes										
		Ultra	Ready Mounts	Max Control\ LTV Severe Duty\ ProGuard\ Guardian	Strut Cushion\ Strut Mount\ Dampers\ Stabilizer	HiJackers\ Load Carrier\ Classic	Ultra	Ready Mounts	Max Control\ LTV Severe Duty\ ProGuard\ Guardian	Strut Cushion\ Strut Mount\ Dampers\ Stabilizer	HiJackers\ Load Carrier\ Classic

MERCEDES-BENZ

ML430

99-01	All	I	G64049
-------	-----	---	--------	-----	-----	-----	-----	-----	-----	-----	-----	-----	-----

ML500

02-05	All	I	G64049
-------	-----	---	--------	-----	-----	-----	-----	-----	-----	-----	-----	-----	-----

S320 / S350 / S420 / S500 / S600

94-99	Exc. Electronic Ride Control		O	70024
-------	------------------------------	--	-----	-----	-----	-----	-----	---	-------	-----	-----	-----	-----

SLK230

98-04	All	I	70064	I	70065
-------	-----	---	-------	-----	-----	-----	-----	---	-------	-----	-----	-----	-----

SLK320

03-04	All	I	70064	I	70065
01-02	170.465(MfrBodyCode)	I	70064	I	70065

SPRINTER

07-10	All		O	G64089
04-06	All		G56778
	Exc. Dual Rear Wheels		G56778	O	G63918

SPRINTER 2500

10-18	All		...	G57802⁴⁰
-------	-----	--	-----	----------------------------	-----	-----	-----	--	-----	-----	-----	-----	-----

SPRINTER 3500

19-20	All		O	G64089
11-18	All		...	G57802⁴⁰	O	G64089
10	All		...	G57802⁴⁰

MERCURY

MERCURY

BOBCAT

75-80	All	I	82128	
	Sedan	I	82128	I	82004

BROUGHAM

67	All	I	69675 ⁵	...	81446	...	34073 ⁸	O	69606	...	81495	...	43140 ⁹ 49205 ⁷
----	-----	---	--------------------	-----	-------	-----	--------------------	---	-------	-----	-------	-----	------------------------------------------

CAPRI

91-93	All		143057 ⁵¹	143059 ⁵¹	...
84-86	Position Rear		14039 ⁸⁵ 143059 ⁵¹	...	I	49199 ⁷
79-86	All		143059 ⁵¹	...	I	49199 ⁷

COLONY PARK

87-91	All	I	69675 ⁵	...	81446	...	34073 ⁸	O	69606	...	81495	...	43140 ⁹ 49205 ⁷
-------	-----	---	--------------------	-----	-------	-----	--------------------	---	-------	-----	-------	-----	------------------------------------------

5 Use kit No. 140719 to replace O.E. hardware for lower shock absorber mounting when studs break or self-tapping screws are not longer useable.

8 Pair Packs.

51 Strut Cushion for use with the Strut/Cartridge/Shocks.





Bold Type - New / Future Part

7 Pair Packs, Air hose kit included.

40 Complete Assembled Unit.









85 Rear Only

APPLICATION GUIDE

Year	Fitment Notes										
		 Ultra	Ready Mounts	Max Control\ LTV Severe Duty\ ProGuard\ Guardian	Strut Cushion\ Strut Mount\ Dampers\ Stabilizer	HiJackers\ Load Carrier\ Classic	 Ultra	Ready Mounts	Max Control\ LTV Severe Duty\ ProGuard\ Guardian	Strut Cushion\ Strut Mount\ Dampers\ Stabilizer	HiJackers\ Load Carrier\ Classic













MERCURY

COLONY PARK (cont)











65-74	All		69675 ⁵	81446	34073 ⁸		69606	81495	43140 ⁶ 49205 ⁷
61-64	All		82099		82076
59-60	All		82099		81270	49105 ⁷
57-58	All		82099	

MERCURY





















COMET

71-77	All		81076		82130
68-69	All		82126		81270	49105 ⁷
66-67	All		82126	
	Exc. Wagon		82126		81270	49105 ⁷
	Wagon		82126		69606	81495	43140 ⁶ 49205 ⁷
60-65	All		82126		81270	49105 ⁷





COMMUTER

65-68	All		69675 ⁵	81446	34073 ⁸		69606	81495	43140 ⁶ 49205 ⁷
64	All		82099		82076
61-62	All		82099		82076
59-60	All		82099		81270	49105 ⁷
57-58	All		82099	



COUGAR

01-02	All		142843 ⁵⁴ 143061 ⁵¹		M55693	143058 ⁵¹
99-00	All		142843 ⁵⁴ 143061 ⁵¹		M55693	142402 ⁵³ 143058 ⁵¹
92-97	Exc. Electronic Adjustable Suspension		G55579		69845
89-91	Exc. Electronic Adjustable Suspension		G55579	
84-88	Position Rear		14039 ⁸⁵ 143059 ⁵¹	
80-88	All		143059 ⁵¹	
81-82	Base, GS & LS Models		143059 ⁵¹		49199 ⁷
74-79	All		69675 ⁵	81446	34073 ⁸		69606	81495	43140 ⁶ 49205 ⁷
71-73	All		81491		81270	49105 ⁷
67-70	All		81076		81270	49105 ⁷

COUNTRY CRUISER

63	All		82099		82076
59-60	All		82099		81270	49105 ⁷

CUSTOM

52-56	All		82026		82125
-------	-----	-------------------------------------------------------------------------------------	------	------	------	------	-------	-------------------------------------------------------------------------------------	------	------	------	------	-------

5 Use kit No. 140719 to replace O.E. hardware for lower shock absorber mounting when studs break or self-tapping screws are not longer useable.

8 Pair Packs.



53 Hardware from O.E. Part may need to be reused.

7 Pair Packs, Air hose kit included.

51 Strut Cushion for use with the Strut/Cartridge/Shocks.

54 Kit with Mount and Bearing. Hardware from O.E. Part may need to be reused.

APPLICATION GUIDE

Year	Fitment Notes										
		Ultra	Ready Mounts	Max Control\ LTV Severe Duty\ ProGuard\ Guardian	Strut Cushion\ Strut Mount\ Dampers\ Stabilizer	HiJackers\ Load Carrier\ Classic	Ultra	Ready Mounts	Max Control\ LTV Severe Duty\ ProGuard\ Guardian	Strut Cushion\ Strut Mount\ Dampers\ Stabilizer	HiJackers\ Load Carrier\ Classic

MERCURY

CYCLONE

68-71	All	I	82126	I	81270
-------	-----	---	------	------	------	------	-------	---	------	------	-------	------	------

GRAND MARQUIS

11	All	I	G51887	G57080 ⁴⁰	143357 ⁶⁷	I	G69575
03-10	All	I	G51887	G57080 ⁴⁰	143357 ⁶⁸	I	G69575
03-06	Mfg to 12/05	I	G51887	G57080 ⁴⁰	79900	143357 ⁶⁸	I	G69575
92-02	All	I	69675 ⁵	81446	I	G69606	81495	43140 ⁸ 49205 ⁷
	Exc. Hydraulic Self-Leveling System	I	69675 ⁵	81446	34073 ⁸	I	G69606	81495	43140 ⁸ 49205 ⁷
75-91	All	I	69675 ⁵	81446	34073 ⁸	I	G69606	81495	43140 ⁸ 49205 ⁷

LN7

82-83	All	I	143057 ⁵¹	I	143059 ⁵¹
-------	-----	---	------	------	------	----------------------	------	---	------	------	------	----------------------	------

LYNX

81-87	All	I	143057 ⁵¹	I	143059 ⁵¹
-------	-----	---	------	------	------	----------------------	------	---	------	------	------	----------------------	------

MARAUDER

03-04	All	I	G51888	G57080 ⁴⁰	79901	I	G69575
69-70	All	I	69675 ⁵	81446	34073 ⁸	I	G69606	81495	43140 ⁸ 49205 ⁷
65-67	All	I	69675 ⁵	81446	34073 ⁸	I	G69606	81495	43140 ⁸ 49205 ⁷
63-64	All	I	82099	I	82076

MARINER

08-11	Left	I	G56601	G57045 ⁴⁰	I	G64047
	Right	I	G56568	G57046 ⁴⁰	I	G64047
05-07	Left	I	G56601	G57045 ⁴⁰	I	G69900 G63862
	Right	I	G56568	G57046 ⁴⁰	I	G69900 G63862

MARQUIS

83-86	All	I	143059 ⁵¹	I	49199 ⁷
67-82	All	I	69675 ⁵	81446	34073 ⁸	I	G69606	81495	43140 ⁸ 49205 ⁷

MEDALIST

58	All	I	82099	I
56	All	I	82026	I	82125

MERCURY

52	All	I	I	49311 ⁷
----	-----	---	------	------	------	------	------	---	------	------	------	------	--------------------

5 Use kit No. 140719 to replace O.E. hardware for lower shock absorber mounting when studs break or self-tapping screws are not longer useable.

8 Pair Packs.

51 Strut Cushion for use with the Strut/Cartridge/Shocks.





68 Mount Kit. Hardware from O.E. Part may need to be reused.;

7 Pair Packs, Air hose kit included.

40 Complete Assembled Unit.



67 Mount Kit. Hardware from O.E. Part may need to be reused.

APPLICATION GUIDE

Year	Fitment Notes										
		 Ultra	Ready Mounts	Max Control\ LTV Severe Duty\ ProGuard\ Guardian	Strut Cushion\ Strut Mount\ Dampers\ Stabilizer	HiJackers\ Load Carrier\ Classic	 Ultra	Ready Mounts	Max Control\ LTV Severe Duty\ ProGuard\ Guardian	Strut Cushion\ Strut Mount\ Dampers\ Stabilizer	HiJackers\ Load Carrier\ Classic



MERCURY

MERCURY (cont)















49-51	All		82026		81318	49311 ⁷ 82125
-------	-----	-----------------------------------------------------------------------------------	------	------	------	------	-------	-----------------------------------------------------------------------------------	------	------	-------	------	-----------------------------

MERCURY



METEOR

62-63	All		82075		81270	49105 ⁷
-------	-----	-----------------------------------------------------------------------------------	------	------	------	------	-------	-----------------------------------------------------------------------------------	------	------	-------	------	--------------------











MILAN

10-11	Left		G51896	G57427 ⁴⁰	
	Right		G51897	G57427 ⁴⁰	
	FWD			69591
07-09	AWD		G51859	G57148 ⁴⁰	
	FWD		G51859		69591
06-09	All		G51859	
06	FWD		G51859	G57148 ⁴⁰		69591

















MONARCH

75-80	All		81491		82130
-------	-----	-------------------------------------------------------------------------------------	------	------	-------	------	------	-------------------------------------------------------------------------------------	------	------	------	------	-------







MONTCLAIR

65-68	All		69675 ⁵	81446	34073 ⁸		69606	81495	43140 ⁸ 49205 ⁷
64	All		82099		82076
59-60	All		82099		81270	49105 ⁷
57-58	All		82099	
55-56	All		82026		82125

MONTEGO

05-07	Left		143341 ⁵³		143390 ⁵³
	Right		143341 ⁵³		143391 ⁵³
	FWD			G51849
72-76	All		69675 ⁵	81446	34073 ⁸		69606	43140 ⁸ 49205 ⁷
	Wagon		69675 ⁵	81446	34073 ⁸		69606	81495	43140 ⁸ 49205 ⁷
68-71	All		82126		69606
	Exc. Wagon		82126		69606	81270	49105 ⁷
	Wagon		82126		69606	81495

MONTEREY

04-07	Mini Passenger Van		G56655	143246 ⁵³		G63873
65-74	All		69675 ⁵	81446	34073 ⁸		69606	81495	43140 ⁸ 49205 ⁷
61-64	All		82099		82076



5 Use kit No. 140719 to replace O.E. hardware for lower shock absorber mounting when studs break or self-tapping screws are not longer useable.

8 Pair Packs.

7 Pair Packs, Air hose kit included.









40 Complete Assembled Unit.

APPLICATION GUIDE

Year	Fitment Notes										
		Ultra	Ready Mounts	Max Control\ LTV Severe Duty\ ProGuard\ Guardian	Strut Cushion\ Strut Mount\ Dampers\ Stabilizer	HiJackers\ Load Carrier\ Classic	Ultra	Ready Mounts	Max Control\ LTV Severe Duty\ ProGuard\ Guardian	Strut Cushion\ Strut Mount\ Dampers\ Stabilizer	HiJackers\ Load Carrier\ Classic









MERCURY

MONTEREY (cont)



59-60	All		82099		81270	49105 ⁷
57-58	All		82099	
52-56	All		82026		82125
50-51	All		82026		81318	49311 ⁷ 82125

MERCURY









MOUNTAINEER

06-10	All		G56838	G57095 ⁴⁰	143360 ⁵³		G56839	G57096 ⁴⁰	143361 ⁵³ 143362 ⁵⁷
04-05	All		G51723	G57019 ⁴⁰	143318 ⁵³		G51724	G57018 ⁴⁰	143319 ⁵³
02-03	All		G51722	G57017 ⁴⁰	143318 ⁵³		G51724	G57018 ⁴⁰	143319 ⁵³
97-01	Exc. Electronic Adjustable Suspension		G63678	61623 77678 81893		G63679	61624 77679 81890	43171 ⁸ 49232 ⁷





















MYSTIQUE

95-00	All		142843 ⁵⁴		M55693	142402 ⁵³
-------	-----	-----------------------------------------------------------------------------------	------	------	------	----------------------	------	-------------------------------------------------------------------------------------	------	------	--------	----------------------	------



PARKLANE

65-68	All		69675 ⁵	81446	34073 ⁸		69606	81495	43140 ⁸ 49205 ⁷
64	All		82099		82076
59-60	All		82099		81270	49105 ⁷
58	All		82099	

SABLE

08-09	FWD, Left		G52129	143415 ⁵³		G57449 ⁴⁰
	FWD, Right		G52130	143415 ⁵³		G57450 ⁴⁰
96-05	Left		G56934 ⁴⁰	142747 ⁵¹ 142845 ⁵⁴ 143059 ⁵¹	
	Right		G56937 ⁴⁰	142747 ⁵¹ 142845 ⁵⁴ 143059 ⁵¹	
	Sedan			G55901	G56936 ⁴⁰	M55901	143057 ⁵¹
	Wagon			69962	81927
94-95	Sedan		142746 ⁵⁷ 143059 ⁵¹		G55901	G56936 ⁴⁰	M55901	143057 ⁵¹
91-95	All		143059 ⁵¹	
91-93	Sedan		142746 ⁵⁷ 143059 ⁵¹	
86-90	All		142746 ⁵⁷ 143059 ⁵¹	

TOPAZ

92-94	All			142745 ⁵³ 143059 ⁵¹
-------	-----	-------------------------------------------------------------------------------------	------	------	------	------	------	---------------------------------------------------------------------------------------	------	------	------	----------------------------------------------	------

5 Use kit No. 140719 to replace O.E. hardware for lower shock absorber mounting when studs break or self-tapping screws are not longer useable.

8 Pair Packs.

51 Strut Cushion for use with the Strut/Cartridge/Shocks.

54 Kit with Mount and Bearing. Hardware from O.E. Part may need to be reused.

63 Mount Kit includes Isolator. Hardware from O.E. Part may need to be reused.

7 Pair Packs, Air hose kit included.



40 Complete Assembled Unit.

53 Hardware from O.E. Part may need to be reused.

61 Mount Kit includes Upper Spring Seat. Hardware from O.E. Part may need to be reused.

67 Mount Kit. Hardware from O.E. Part may need to be reused.

APPLICATION GUIDE

Year	Fitment Notes										
		Ultra	Ready Mounts	Max Control\ LTV Severe Duty\ ProGuard\ Guardian	Strut Cushion\ Strut Mount\ Dampers\ Stabilizer	HiJackers\ Load Carrier\ Classic	Ultra	Ready Mounts	Max Control\ LTV Severe Duty\ ProGuard\ Guardian	Strut Cushion\ Strut Mount\ Dampers\ Stabilizer	HiJackers\ Load Carrier\ Classic

MERCURY

TOPAZ (cont)

87-91	All	↓	143059 ⁵¹	↓	142745 ⁶³ 143059 ⁵¹
86	All	↓	↓	142745 ⁶³ 143059 ⁵¹
84-85	All	↓	143057 ⁵¹	↓	142745 ⁶³ 143059 ⁵¹

MERCURY

TRACER

97-99	FWD	↓	143061 ⁵¹	↓	M55848
91-96	FWD	↓	142854 ⁵⁴ 143057 ⁵¹	↓	M55848	143058 ⁵¹
87-89	FWD	↓	142183 ⁶³	↓	143058 ⁵¹

TURNPIKE CRUISER

57	All	↓	82099	↓
----	-----	---	------	------	------	------	-------	---	------	------	------	------	------

VILLAGER

99-02	Left	↓	G56785	↓
	Right	↓	G56784	↓
97-02	Non-ABS	↓	↓	G63299
93-98	Left	↓	M55920	143057 ⁵¹	↓
	Right	↓	M55921	143057 ⁵¹	↓
93-96	4-Wheel ABS	↓	↓	G63299
65-67	All	↓	69675 ⁵	81446	34073 ⁸	↓	69606	81495	43140 ⁶ 49205 ⁷
62-64	All	↓	82099	↓	82076

VOYAGER

66-67	All	↓	69675 ⁵	81446	34073 ⁸	↓	69606	81495	43140 ⁶ 49205 ⁷
59	All	↓	82099	↓	81270
57-58	All	↓	82099	↓

ZEPHYR

78-83	All	↓	143059 ⁵¹	↓	49199 ⁷
-------	-----	---	------	------	------	----------------------	------	---	------	------	------	------	--------------------

MINI

MINI

COOPER

13	Left	↓	G52297	↓	G51934
	Right	↓	G52298	↓	G51934
12	Left	↓	G52297	143491 ⁵³	↓	G51934
	Right	↓	G52298	143491 ⁵³	↓	G51934

5 Use kit No. 140719 to replace O.E. hardware for lower shock absorber mounting when studs break or self-tapping screws are not longer useable.

8 Pair Packs.



53 Hardware from O.E. Part may need to be reused.

7 Pair Packs, Air hose kit included.

51 Strut Cushion for use with the Strut/Cartridge/Shocks.

54 Kit with Mount and Bearing. Hardware from O.E. Part may need to be reused.

APPLICATION GUIDE

Year	Fitment Notes										
		Ultra	Ready Mounts	Max Control\ LTV Severe Duty\ ProGuard\ Guardian	Strut Cushion\ Strut Mount\ Dampers\ Stabilizer	HiJackers\ Load Carrier\ Classic	Ultra	Ready Mounts	Max Control\ LTV Severe Duty\ ProGuard\ Guardian	Strut Cushion\ Strut Mount\ Dampers\ Stabilizer	HiJackers\ Load Carrier\ Classic

MINI

COOPER (cont)

07-11	Left	G52297	143405 ⁶⁷ 143491 ⁵³	G51934
	Right	G52298	143405 ⁶⁷ 143491 ⁵³	G51934
02-06	Left	G52164	143404 ⁵³ 143405 ⁶⁷	G51881
	Right	G52165	143404 ⁵³ 143405 ⁶⁷	G51881

MINI

MITSUBISHI

3000GT

91-99	All	142419 ⁶⁸
-------	-----	------	------	------	------	------	------	------	----------------------	------

MITSUBISHI

CORDIA

83-88	All	143059 ⁵¹
-------	-----	------	------	------	----------------------	------	------	------	------	------

DIAMANTE

04	All	143087 ⁵³	142419 ⁶⁸
97-03	All	143087 ⁵³	G51772	142419 ⁶⁸

ECLIPSE

06-12	Right	G52167
00-05	All	143059 ⁵¹ 143087 ⁵³	G51712	142419 ⁶⁸ 143059 ⁵¹
95-99	All	142419 ⁶⁸ 143059 ⁵¹	142419 ⁶⁸ 143059 ⁵¹
	AWD	142419 ⁶⁸ 143059 ⁵¹	G51712	142419 ⁶⁸ 143059 ⁵¹
	FWD	142419 ⁶⁸ 143059 ⁵¹	G51254	142419 ⁶⁸ 143059 ⁵¹
90-94	All	142219 ⁵³ 143057 ⁵¹	142419 ⁶⁸ 143064 ⁵¹

ENDEAVOR

10-11	AWD	G51933
11	Left	G52293
	Right	G52294
10	Left	G52293	143398 ⁵⁴
	Right	G52294	143398 ⁵⁴
09	Left	G52293
	Right	G52294
04-08	Left	G52293	143398 ⁵⁴
	Right	G52294	143398 ⁵⁴

51 Strut Cushion for use with the Strut/Cartridge/Shocks.



54 Kit with Mount and Bearing. Hardware from O.E. Part may need to be reused.

68 Mount Kit. Hardware from O.E. Part may need to be reused.;

53 Hardware from O.E. Part may need to be reused.

67 Mount Kit. Hardware from O.E. Part may need to be reused.

APPLICATION GUIDE

Year	Fitment Notes										
		Ultra	Ready Mounts	Max Control\ LTV Severe Duty\ ProGuard\ Guardian	Strut Cushion\ Strut Mount\ Dampers\ Stabilizer	HiJackers\ Load Carrier\ Classic	Ultra	Ready Mounts	Max Control\ LTV Severe Duty\ ProGuard\ Guardian	Strut Cushion\ Strut Mount\ Dampers\ Stabilizer	HiJackers\ Load Carrier\ Classic

MITSUBISHI

ENDEAVOR (cont)

04-08	AWD	G51933
-------	-----	-----	-----	-----	-----	-----	--------	-----	-----	-----	-----

EXPO

92-95	All	143057 ⁵¹	...	G69462	142419 ⁶⁸	...
-------	-----	-----	-----	-----	----------------------	-----	--------	-----	-----	----------------------	-----

GALANT

12	SE, Left	G52168	G51883
	SE, Right	G52169	G51883
11	Exc. GT, LS, Sport, Ralliart Models Left	G52168	G51883
	Exc. GT, LS, Sport, Ralliart Models Right	G52169	G51883
08-10	All	143398 ⁵⁴
	Exc. GT, LS, Sport, Ralliart Models Left	G52168	143398 ⁵⁴	...	G51883
	Exc. GT, LS, Sport, Ralliart Models Right	G52169	143398 ⁵⁴	...	G51883
04-07	All	143398 ⁵⁴	142419 ⁶⁸	...
	Exc. GT, LS, Sport, Ralliart Models Left	G52168	143398 ⁵⁴	...	G51883	142419 ⁶⁸	...
	Exc. GT, LS, Sport, Ralliart Models Right	G52169	143398 ⁵⁴	...	G51883	142419 ⁶⁸	...
04-06	LS	143398 ⁵⁴	...	G51969	142419 ⁶⁸	...
99-03	Left	G56636	143087 ⁵³	...	G51254	142419 ⁶⁸	...
	Right	G56635	143087 ⁵³	...	G51254	142419 ⁶⁸	...
	GTZ	G57075 ⁴⁰
94-98	All	G55820	142419 ⁶⁸ 143057 ⁵¹	142419 ⁶⁸ 143057 ⁵¹	...	
93	All	142543 ⁵³ 143057 ⁵¹	142419 ⁶⁸ 143063 ⁵¹	...	
90-92	All	142543 ⁵³ 143057 ⁵¹	142419 ⁶⁸	...	
	AWD	142543 ⁵³ 143057 ⁵¹	143063 ⁵¹ 142419 ⁶⁸	...	
89	All	143057 ⁵¹	142419 ⁶⁸ 143063 ⁵¹	...	
	FWD	142543 ⁵³ 143057 ⁵¹	142419 ⁶⁸ 143063 ⁵¹	...	
85-88	All	143064 ⁵¹	...	
	Exc. Electronic Adjustable Suspension	142419 ⁶⁸ 143064 ⁵¹	...	

LANCER

11	DE, ES	G51908
----	--------	-----	-----	-----	-----	-----	--------	-----	-----	-----	-----



40 Complete Assembled Unit.

53 Hardware from O.E. Part may need to be reused.

51 Strut Cushion for use with the Strut/Cartridge/Shocks.

54 Kit with Mount and Bearing. Hardware from O.E. Part may need to be reused.

APPLICATION GUIDE

Year	Fitment Notes										
		Ultra	Ready Mounts	Max Control\ LTV Severe Duty\ ProGuard\ Guardian	Strut Cushion\ Strut Mount\ Dampers\ Stabilizer	HiJackers\ Load Carrier\ Classic	Ultra	Ready Mounts	Max Control\ LTV Severe Duty\ ProGuard\ Guardian	Strut Cushion\ Strut Mount\ Dampers\ Stabilizer	HiJackers\ Load Carrier\ Classic

MITSUBISHI

MONTERO (cont)

90-91	Single System Steering Stabilizer		G63418	61529	6802SE ⁸⁴		
86-89	Single System Steering Stabilizer		G63418	61529	6802SE ⁸⁴		G63492	81318	49311 ⁷
83-89	All		G63418	61529		G63492	81318	49311 ⁷
89	3.0L 6Cyl		G63418	61529		G63604 G63492	81318	49311 ⁷
83-88	2.6L 4Cyl		G63418	61529		G63492	61506 81318	49311 ⁷

MITSUBISHI

MONTERO SPORT

00-04	All		G64027		G64028
97-99	All		G63782 ⁹		G63492	61506	49311 ⁷

OUTLANDER

12-13	SE, XLS & GT Models w/ 3rd Row Seating Left		G52299		G511004
	SE, XLS & GT Models w/ 3rd Row Seating Right		G52300		G511004
09-11	SE, XLS & GT Models w/ 3rd Row Seating Left		G52299		G511004	143394 ⁶⁷
	SE, XLS & GT Models w/ 3rd Row Seating Right		G52300		G511004	143394 ⁶⁷
08-11	All		143394 ⁶⁷
08	XLS, Left		G52299		G511004	143394 ⁶⁷
	XLS, Right		G52300		G511004	143394 ⁶⁷
07	Left		G52299		G511004	143394 ⁶⁷
	Right		G52300		G511004	143394 ⁶⁷
05-06	All		143088 ⁵³	143394 ⁶⁷
03-04	All		143088 ⁵³		G51838	143394 ⁶⁷

PRECIS

90-94	All		143057 ⁵¹
87-89	All		143059 ⁵¹

RAIDER

06-09	All		G51815	143385 ⁶⁸
	4WD		G51815	G57146 ⁴⁰	143385 ⁶⁸		G63891
	RWD		G51815	G57409 ⁴⁰	143385 ⁶⁸		G63890

SIGMA

89-90	Non-ABS		143064 ⁵¹
	Non-ABS Exc. Auto-Leveling System		142419 ⁶⁸

7 Pair Packs, Air hose kit included.

40 Complete Assembled Unit.

53 Hardware from O.E. Part may need to be reused.

182 68 Mount Kit. Hardware from O.E. Part may need to be reused.;





9 See Ref. D for procedures to replace Elec Adj Susp with non-adj product.

51 Strut Cushion for use with the Strut/Cartridge/Shocks.









67 Mount Kit. Hardware from O.E. Part may need to be reused.

84 Replacement damper for vehicles with the Gabriel Aftermarket mounting kit

APPLICATION GUIDE



Year	Fitment Notes										
		 Ultra	Ready Mounts	Max Control\ LTV Severe Duty\ ProGuard\ Guardian	Strut Cushion\ Strut Mount\ Dampers\ Stabilizer	HiJackers\ Load Carrier\ Classic	 Ultra	Ready Mounts	Max Control\ LTV Severe Duty\ ProGuard\ Guardian	Strut Cushion\ Strut Mount\ Dampers\ Stabilizer	HiJackers\ Load Carrier\ Classic

MITSUBISHI STARION



87-89	All		143057 ⁵¹		143058 ⁵¹
86	LE		143058 ⁵¹		143058 ⁵¹
84-85	LE, LS		143058 ⁵¹		143058 ⁵¹
83	All		143058 ⁵¹		143058 ⁵¹

MITSUBISHI

TREDIA

83-88	All		143059 ⁵¹	
-------	-----	-----------------------------------------------------------------------------------	------	------	------	----------------------	------	-------------------------------------------------------------------------------------	------	------	------	------	------





VAN

87-90	All		G63904	61593 81872		G63907	61500 77907 81147	43048 ⁹ 49310 ⁷
-------	-----	-----------------------------------------------------------------------------------	--------	------	----------------	------	------	-------------------------------------------------------------------------------------	--------	------	-------------------------	------	------------------------------------------



NISSAN

NISSAN



200SX

95-98	All		143057 ⁵¹	
80-88	All		143059 ⁵¹	



210

79-82	All		143059 ⁵¹	
-------	-----	-------------------------------------------------------------------------------------	------	------	------	----------------------	------	---------------------------------------------------------------------------------------	------	------	------	------	------





240SX

89-94	All		143059 ⁵¹		143064 ⁵¹
-------	-----	-------------------------------------------------------------------------------------	------	------	------	----------------------	------	---------------------------------------------------------------------------------------	------	------	------	----------------------	------



240Z

70-73	All		142241 ⁶⁷		143059 ⁵¹
-------	-----	-------------------------------------------------------------------------------------	------	------	------	----------------------	------	---------------------------------------------------------------------------------------	------	------	------	----------------------	------



260Z

74-75	All			143059 ⁵¹
74	Mfg. 9/74		142241 ⁶⁷		143059 ⁵¹







280Z

75-78	All		142241 ⁶⁷		143059 ⁵¹
-------	-----	-------------------------------------------------------------------------------------	------	------	------	----------------------	------	---------------------------------------------------------------------------------------	------	------	------	----------------------	------



280ZX

79-83	All		142241 ⁶⁷ 143059 ⁵¹	
-------	-----	-------------------------------------------------------------------------------------	------	------	------	----------------------------------------------	------	---------------------------------------------------------------------------------------	------	------	------	------	------

300ZX

90-96	2+2		143057 ⁵¹		143064 ⁵¹
87-89	All		142241 ⁶⁷		69757
84-86	All		142241 ⁶⁷ 143057 ⁵¹		69757

APPLICATION GUIDE

Year	Fitment Notes										
		Ultra	Ready Mounts	Max Control\ LTV Severe Duty\ ProGuard\ Guardian	Strut Cushion\ Strut Mount\ Dampers\ Stabilizer	HiJackers\ Load Carrier\ Classic	Ultra	Ready Mounts	Max Control\ LTV Severe Duty\ ProGuard\ Guardian	Strut Cushion\ Strut Mount\ Dampers\ Stabilizer	HiJackers\ Load Carrier\ Classic

NISSAN

310

79-82	All		143059 ⁵¹
-------	-----	--	------	------	------	----------------------	------	--	------	------	------	------	------

350Z

09	All			G51955
07-08	All		143455 ⁶⁸		G51955
06	All		143455 ⁶⁸
03-05	Left		G51813	143455 ⁶⁸
	Right		G51814	143455 ⁶⁸
	Sport Suspension			G51812

410

64-65	All		69600	81494	43140 ⁶ 82155
-------	-----	--	-------	------	-------	------	------	--	------	------	------	------	-----------------------------

411

64-67	All		69600	81494	43140 ⁶ 82155
-------	-----	--	-------	------	-------	------	------	--	------	------	------	------	-----------------------------

510

78-81	All		143059 ⁵¹
	Wagon		143059 ⁵¹	49310 ⁷ 82156
72	All		81340	43140 ⁶

521 PICKUP

69-72	All		G63902	61501 81478
-------	-----	--	--------	------	----------------	------	------	--	------	------	------	------	------

610

75-76	All		142241 ⁶⁷
	Wagon		142241 ⁶⁷		69604	81492	49152 ⁷
73-74	All		142241 ⁶⁷		69604	49152 ⁷
	Wagon		142241 ⁶⁷		69604	81492	49152 ⁷

620 PICKUP

72-79	All		G63902	61501 81478
-------	-----	--	--------	------	----------------	------	------	--	------	------	------	------	------

710

74-77	All		43140 ⁶
	Exc. Wagon		81340	43140 ⁶
	Wagon			69604	81492	43060 ⁶ 49152 ⁷ 43140 ⁶

720 PICKUP

82-86	4WD		G63902	61501 81478		G63492	61506 81318	49311 ⁷
-------	-----	--	--------	------	----------------	------	------	--	--------	------	----------------	------	--------------------





7 Pair Packs, Air hose kit included.

51 Strut Cushion for use with the Strut/Cartridge/Shocks.

8 Pair Packs.

67 Mount Kit. Hardware from O.E. Part may need to be reused.



APPLICATION GUIDE

Year	Fitment Notes										
		 Ultra	Ready Mounts	Max Control\ LTV Severe Duty\ ProGuard\ Guardian	Strut Cushion\ Strut Mount\ Dampers\ Stabilizer	HiJackers\ Load Carrier\ Classic	 Ultra	Ready Mounts	Max Control\ LTV Severe Duty\ ProGuard\ Guardian	Strut Cushion\ Strut Mount\ Dampers\ Stabilizer	HiJackers\ Load Carrier\ Classic







NISSAN

NISSAN



720 PICKUP (cont)

80-86	All		G63902	61501 81478
82	Single System Steering Stabilizer		G63902	61501 81478	6802SE ⁸⁴



810

81	All		142241 ⁶⁷ 143059 ⁵¹		
78-80	Wagon		142241 ⁶⁷		69604	81492	43060 ⁸ 49152 ⁷
77-80	All		142241 ⁶⁷	
77	Wagon		142241 ⁶⁷		81492

































1600

66-70	All			82130
-------	-----	-----------------------------------------------------------------------------------	------	------	------	------	------	-------------------------------------------------------------------------------------	------	------	------	------	-------

2000

68-70	All			82130
-------	-----	-----------------------------------------------------------------------------------	------	------	------	------	------	-------------------------------------------------------------------------------------	------	------	------	------	-------

ALTIMA

19-20	w/Rebound Spring			G51874
17-18	Left		G57817 ⁴⁰		G51874
	Right		G57818 ⁴⁰		G51874
14-16	Left		G57545 ⁴⁰		G51874
	Right		G57546 ⁴⁰		G51874
07-13	All			G51874
	Exc. Hybrid Models Left		G52121	G57161 ⁴⁰		G51874
13	Exc. Hybrid Models Right		G52122		G51874
07-12	Exc. Hybrid Models Right		G52122	G57162 ⁴⁰		G51874
07-11	Hybrid, Left		G57367 ⁴⁰		G51874
	Hybrid, Right		G57368 ⁴⁰		G51874
02-06	Left		G56671	G57030 ⁴⁰	142937 ⁵⁴		G51725
	Right		G56672	G57031 ⁴⁰	142937 ⁵⁴		G51725
00-01	Left		G57558 ⁴⁰	143057 ⁵¹		143059 ⁵¹
	Right		G57559 ⁴⁰	143057 ⁵¹		143059 ⁵¹
93-99	All		143277 ⁵³	

7 Pair Packs, Air hose kit included.

40 Complete Assembled Unit.

53 Hardware from O.E. Part may need to be reused.

67 Mount Kit. Hardware from O.E. Part may need to be reused.



8 Pair Packs.

51 Strut Cushion for use with the Strut/Cartridge/Shocks.

54 Kit with Mount and Bearing. Hardware from O.E. Part may need to be reused.

84 Replacement damper for vehicles with the Gabriel Aftermarket mounting kit

APPLICATION GUIDE

Year	Fitment Notes										
		Ultra	Ready Mounts	Max Control\ LTV Severe Duty\ ProGuard\ Guardian	Strut Cushion\ Strut Mount\ Dampers\ Stabilizer	Hijackers\ Load Carrier\ Classic	Ultra	Ready Mounts	Max Control\ LTV Severe Duty\ ProGuard\ Guardian	Strut Cushion\ Strut Mount\ Dampers\ Stabilizer	Hijackers\ Load Carrier\ Classic

NISSAN

NISSAN

ARMADA

12-15	Exc. Auto-Leveling System		G51715		G63875
	4WD, Exc. Auto-Leveling System		G57092 ⁴⁰
10-11	4WD, Exc. Auto-Leveling System		G57092 ⁴⁰	143358 ⁵³ 143359 ⁶⁷
05-11	All		143358 ⁵³ 143359 ⁶⁷
	Exc. Auto-Leveling System		G51715	143358 ⁵³ 143359 ⁶⁷		G63875
05-09	4WD		G57092 ⁴⁰	143358 ⁵³ 143359 ⁶⁷

AXCESS

90-94	All		142241 ⁶⁷ 143059 ⁵¹	143059 ⁵¹
-------	-----	--	------	------	------	----------------------------------------------	------	--	------	------	------	----------------------	------

B210

74-78	All		143059 ⁵¹
-------	-----	--	------	------	------	----------------------	------	------	------	------	------	------	------

CUBE

09-14	Left		G57202 ⁴⁰
	Right		G57203 ⁴⁰

F10

76-78	All		143059 ⁵¹
	Wagon		143059 ⁵¹	82125

FRONTIER

20-21	Exc. Nismo Off Road		G51766		G64031
	4WD		G57647 ⁴⁰
	RWD		G57646 ⁴⁰
18-19	All		G51766
	4WD		G51766	G57647 ⁴⁰
	Exc. Nismo Off-Road		G51766		G64031
	RWD		G51766	G57646 ⁴⁰
05-17	4WD		G57647 ⁴⁰
	Exc. Nismo Off-Road			G64031
	Mfg. to 12/12; Exc. Nismo Off-Road		G51766
	RWD		G57646 ⁴⁰
98-04	4WD		G63813	61662		G63492	61506 81318	49311 ⁷



7 Pair Packs, Air hose kit included.

51 Strut Cushion for use with the Strut/Cartridge/Shocks.

40 Complete Assembled Unit.

53 Hardware from O.E. Part may need to be reused.

APPLICATION GUIDE

Year	Fitment Notes										
		Ultra	Ready Mounts	Max Control\ LTV Severe Duty\ ProGuard\ Guardian	Strut Cushion\ Strut Mount\ Dampers\ Stabilizer	HiJackers\ Load Carrier\ Classic	Ultra	Ready Mounts	Max Control\ LTV Severe Duty\ ProGuard\ Guardian	Strut Cushion\ Strut Mount\ Dampers\ Stabilizer	HiJackers\ Load Carrier\ Classic

NISSAN

NISSAN

FRONTIER (cont)

98-04	RWD, Exc. Desert Runner	⊥	G63909	61508 77909 81507	⊥	G63907	61500 77907 81147	43048 ⁹ 49310 ⁷
	RWD; Crew Cab with Desert Runner	⊥	G63813	61662	⊥	G63492	61506 81318	49311 ⁷

JUKE

14-16	CVT Transmission	⊥	⊥	G51122
	Manual	⊥	⊥	G51123

MAXIMA

15	Left	⊥	G57493 ⁴⁰	⊥
	Right	⊥	G57494 ⁴⁰	⊥
09-14	Left	⊥	G52382	G57493 ⁴⁰	⊥	70089
	Right	⊥	G52383	G57494 ⁴⁰	⊥	70089
04-08	Left	⊥	G56671	G57030 ⁴⁰	142937 ⁵⁴	⊥	G51802
	Right	⊥	G56672	G57031 ⁴⁰	142937 ⁵⁴	⊥	G51802
02-03	Left	⊥	G56685	G57157 ⁴⁰	142937 ⁵⁴	⊥	G51727	G57159 ⁴⁰	142949 ⁵³
	Right	⊥	G56686	G57158 ⁴⁰	142937 ⁵⁴	⊥	G51727	G57160 ⁴⁰	142949 ⁵³
00-01	Left	⊥	G56683	G57165 ⁴⁰	142937 ⁵⁴	⊥	G51727	G57159 ⁴⁰	142949 ⁵³
	Right	⊥	G56684	G57166 ⁴⁰	142937 ⁵⁴	⊥	G51727	G57160 ⁴⁰	142949 ⁵³
95-99	Left	⊥	M55913	142546 ⁵⁴	⊥	G51087	G57057 ⁴⁰	142547 ⁵³
	Right	⊥	M55912	142546 ⁵⁴	⊥	G51087	G57058 ⁴⁰	142547 ⁵³
89-94	All	⊥	143059 ⁵¹	⊥	143057 ⁵¹
	Exc. Electronic Adjustable Suspension	⊥	142241 ⁵⁷ 143059 ⁵¹	⊥	143057 ⁵¹
86-88	Sedan	⊥	⊥	143059 ⁵¹
85	All	⊥	⊥	143059 ⁵¹
83-84	Wagon	⊥	143059 ⁵¹	⊥	49310 ⁷ 82156
82-84	All	⊥	143059 ⁵¹	⊥
	Exc. Electronic Adjustable Suspension	⊥	142241 ⁵⁷ 143059 ⁵¹	⊥

MULTI

87-88	CAN	⊥	⊥	143057 ⁵¹
-------	-----	---	------	------	------	------	------	---	------	------	------	----------------------	------

7 Pair Packs, Air hose kit included.

40 Complete Assembled Unit.

53 Hardware from O.E. Part may need to be reused.

67 Mount Kit. Hardware from O.E. Part may need to be reused.

8 Pair Packs.

51 Strut Cushion for use with the Strut/Cartridge/Shocks.

54 Kit with Mount and Bearing. Hardware from O.E. Part may need to be reused.

APPLICATION GUIDE

Year	Fitment Notes										
		Ultra	Ready Mounts	Max Control\ LTV Severe Duty\ ProGuard\ Guardian	Strut Cushion\ Strut Mount\ Dampers\ Stabilizer	HiJackers\ Load Carrier\ Classic	Ultra	Ready Mounts	Max Control\ LTV Severe Duty\ ProGuard\ Guardian	Strut Cushion\ Strut Mount\ Dampers\ Stabilizer	HiJackers\ Load Carrier\ Classic

NISSAN

NISSAN

MURANO

19	All		G51884
18	Left		G52524	G57772 ⁴⁰	G51884
	Right		G52525	G57773 ⁴⁰	G51884
15-17	Left		G52524	G57772 ⁴⁰
	Right		G52525	G57773 ⁴⁰
14-17	Exc. CrossCabriolet		G51884
14	Left		G57772 ⁴⁰
	Right		G57773 ⁴⁰
08-13	Mfg. to 12/12 Left		G52170	G51884
	Mfg. to 12/12 Right		G52171	G51884
08-12	All		G51884
03-07	Left		G52008	G57163 ⁴⁰	142937 ⁵⁴	G51798	143396 ⁶⁸
	Right		G52009	G57164 ⁴⁰	142937 ⁵⁴	G51798	143396 ⁶⁸

NOTE

14-16	All		G51990
-------	-----	--	------	------	------	------	------	------	------	------	--------	------	------	------	------

NV200

13-19	All		G64146
-------	-----	--	------	------	------	------	------	------	------	------	--------	------	------	------	------

NV1500

12-19	All		G64164
-------	-----	--	------	------	------	------	------	------	------	------	--------	------	------	------	------

NV2500

12-19	All		G64164
-------	-----	--	------	------	------	------	------	------	------	------	--------	------	------	------	------

NV3500

12-19	All		G64164
-------	-----	--	------	------	------	------	------	------	------	------	--------	------	------	------	------

NX

91-93	All		143057 ⁵¹
-------	-----	--	------	------	------	----------------------	------	------	------	------	------	------	------	------	------

PATHFINDER

13-20	Left		G52524	G57772 ⁴⁰	G511043
	Right		G52525	G57773 ⁴⁰	G511043
05-13	Mfg. to 9/12		G64033
05-12	Mfg. to 8/12		G51765
05-11	4WD		G57118 ⁴⁰
04	All		G63845



40 Complete Assembled Unit.

51 Strut Cushion for use with the Strut/Cartridge/Shocks.

188 54 Kit with Mount and Bearing. Hardware from O.E. Part may need to be reused.

68 Mount Kit. Hardware from O.E. Part may need to be reused.;

APPLICATION GUIDE

Year	Fitment Notes										
		Ultra	Ready Mounts	Max Control\ LTV Severe Duty\ ProGuard\ Guardian	Strut Cushion\ Strut Mount\ Dampers\ Stabilizer	HiJackers\ Load Carrier\ Classic	Ultra	Ready Mounts	Max Control\ LTV Severe Duty\ ProGuard\ Guardian	Strut Cushion\ Strut Mount\ Dampers\ Stabilizer	HiJackers\ Load Carrier\ Classic

NISSAN

NISSAN

PATHFINDER (cont)

04	Left	G57144 ⁴⁰	○	G63845
	Left w/ OE 543034W925 or 543034W926	G56687	○	G63845
	Right	G57145 ⁴⁰	○	G63845
	Right w/ OE 543034W925 or 543034W926	G56688	○	G63845
02-03	All	142938 ⁵³	○	G63845
	Left	G57144 ⁴⁰	142938 ⁵³	○	G63845
	Left w/ OE 543034W925 or 543034W926	G56687	142938 ⁵³	○	G63845
	Right	G57145 ⁴⁰	142938 ⁵³	○	G63845
99-01	Left Mfg. from 12/98; w/ OE543034W985	G56615	142938 ⁵³	○
	Mfg. from 12/98	142938 ⁵³	○	G63845
	Right Mfg. from 12/98; w/ OE543034W985	G56616	142938 ⁵³	○
96-01	All	142938 ⁵³	○
01	Left w/ OE 543034W925 or 543034W926	G56687	142938 ⁵³	○
	Right w/ OE 543034W925 or 543034W926	G56688	142938 ⁵³	○
96-99	Mfg. to 11/98 Left	G57037 ⁴⁰	142938 ⁵³	○
	Mfg. to 11/98 Right	G57038 ⁴⁰	142938 ⁵³	○
	Mfg. to 12/98	142938 ⁵³	○	G63712	61609 81910
87-95	All	81872	○
	Exc. Electronic Adjustable Suspension	G63904 ⁹	61593 ⁹ 81872	○	G63492 ⁹	61506 ⁹ 81318 ⁹	49311 ⁷

PATHFINDER ARMADA

04	All	G51715	G57092 ⁴⁰	○	G63875
----	-----	--------	----------------------	-------	-------	-------	---	--------	-------	-------	-------	-------

PICKUP

87-97	4WD	G63902	61501 81478	○	G63492	61506 81318	49311 ⁷
	RWD	G63909	61508 77909 81507	○	G63907	61500 77907 81147	43048 ⁸ 49310 ⁷
86	4WD, Mfg. from 8/86	G63902	61501 81478	○	G63492	61506 81318	49311 ⁷
	RWD, Mfg. from 8/86	G63909	61508 77909 81507	○	G63907	61500 77907 81147	43048 ⁸ 49310 ⁷

7 Pair Packs, Air hose kit included.



9 See Ref. D for procedures to replace Elec Adj Susp with non-adj product.

53 Hardware from O.E. Part may need to be reused.

8 Pair Packs.

40 Complete Assembled Unit.





APPLICATION GUIDE

Year	Fitment Notes										
		Ultra	Ready Mounts	Max Control\ LTV Severe Duty\ ProGuard\ Guardian	Strut Cushion\ Strut Mount\ Dampers\ Stabilizer	HiJackers\ Load Carrier\ Classic	Ultra	Ready Mounts	Max Control\ LTV Severe Duty\ ProGuard\ Guardian	Strut Cushion\ Strut Mount\ Dampers\ Stabilizer	HiJackers\ Load Carrier\ Classic





















NISSAN

NISSAN



















PULSAR / PULSAR NX

86-90	All		143057 ⁵¹		143059 ⁵¹
83-85	All		142241 ⁶⁷ 143057 ⁵¹	





QUEST

14-17	Left		G52906	
	Right		G52907	
11-13	Left		G52355	
	Right		G52356	
04-09	Left		G52032	G57184 ⁴⁰	142937 ⁵⁴		G51803	143396 ⁶⁸
	Right		G52033	G57185 ⁴⁰	142937 ⁵⁴		G51803	143396 ⁶⁸
99-02	Left		G56785	142241 ⁶⁷		G63299
	Right		G56784	142241 ⁶⁷		G63299
93-98	Left		M55920	142241 ⁶⁷ 143057 ⁵¹		G63299
	Right		M55921	142241 ⁶⁷ 143057 ⁵¹		G63299



ROGUE

14-20	Left		G52410	G57774 ⁴⁰		G64050
	Right		G52411	G57775 ⁴⁰		G64050
13-15	Left w/ OE #E4302JM00A		G57778 ⁴⁰		G64050
	Right w/ OE #E4302JM00A		G57779 ⁴⁰		G64050
08-15	All			G64050
08-12	Left w/ OE# E4303JM00A		G52173		G64050
	Right w/ OE# E4303JM00A		G52174		G64050
08-10	Left		G57473 ⁴⁰		G64050
	Right		G57474 ⁴⁰		G64050

ROGUE SELECT

14-15	Left		G57776⁴⁰		G64050
	Right		G57777⁴⁰		G64050

SENTRA

13-15	All			G511044
-------	-----	-------------------------------------------------------------------------------------	------	------	------	------	------	-------------------------------------------------------------------------------------	---------	------	------	------	------

40 Complete Assembled Unit.



54 Kit with Mount and Bearing. Hardware from O.E. Part may need to be reused.

68 Mount Kit. Hardware from O.E. Part may need to be reused.;

51 Strut Cushion for use with the Strut/Cartridge/Shocks.

67 Mount Kit. Hardware from O.E. Part may need to be reused.



















APPLICATION GUIDE

Year	Fitment Notes										
		Ultra	Ready Mounts	Max Control\ LTV Severe Duty\ ProGuard\ Guardian	Strut Cushion\ Strut Mount\ Dampers\ Stabilizer	HiJackers\ Load Carrier\ Classic	Ultra	Ready Mounts	Max Control\ LTV Severe Duty\ ProGuard\ Guardian	Strut Cushion\ Strut Mount\ Dampers\ Stabilizer	HiJackers\ Load Carrier\ Classic





NISSAN

NISSAN







SENTRA (cont)

11-12	Right		G57201 ⁴⁰
08-12	Left		G57200 ⁴⁰
07-12	Base, S and SL Models Left		G52094	○	70027
	Base, S and SL Models Right		G52095	○	70027
08-10	Right		G57201 ⁴⁰	143378 ⁶⁸
07	Right		143378 ⁶⁸
	Exc. SE & SE-R Models Left		G57200 ⁴⁰
	Exc. SE & SE-R Models Right		G57201 ⁴⁰
02-06	All			G51279	G57036 ⁴⁰	143209 ⁵³
	Exc. SE-R & SE-R Spec V Models Left		G57034 ⁴⁰		G51279	G57036 ⁴⁰	143209 ⁵³
	Exc. SE-R & SE-R Spec V Models Right		G57035 ⁴⁰		G51279	G57036 ⁴⁰	143209 ⁵³
00-01	All			G51279	143209 ⁵³
91-99	All		143057 ⁵¹
87-90	FWD		143057 ⁵¹
82-86	All		143057 ⁵¹

STANZA

90-92	All		143059 ⁵¹ 143277 ⁵³
87-89	Sedan			143057 ⁵¹
86	Sedan		143058 ⁵¹
82-85	All		143058 ⁵¹

TITAN

17-22	All		G51715
	Exc. Off Road		G51715	G57092 ⁴⁰
	4WD		G51715	○	G63878
	RWD		G51715	○	G63883
12-15	All		G51715
	4WD		G51715	○	G63878
	4WD, Exc. Off Road		G51715	G57092 ⁴⁰



40 Complete Assembled Unit.

53 Hardware from O.E. Part may need to be reused.

51 Strut Cushion for use with the Strut/Cartridge/Shocks.

68 Mount Kit. Hardware from O.E. Part may need to be reused.;

APPLICATION GUIDE

Year	Fitment Notes										
		Ultra	Ready Mounts	Max Control\ LTV Severe Duty\ ProGuard\ Guardian	Strut Cushion\ Strut Mount\ Dampers\ Stabilizer	HiJackers\ Load Carrier\ Classic	Ultra	Ready Mounts	Max Control\ LTV Severe Duty\ ProGuard\ Guardian	Strut Cushion\ Strut Mount\ Dampers\ Stabilizer	HiJackers\ Load Carrier\ Classic

NISSAN

NISSAN

TITAN (cont)

12-15	RWD		G51715	G57092 ⁴⁰		G63883
07-11	All		G51715	143358 ⁵³ 143359 ⁶⁷
	4WD		G51715	143358 ⁵³ 143359 ⁶⁷		G63878
	4WD, Exc. Off Road		G51715	G57092 ⁴⁰	143358 ⁵³ 143359 ⁶⁷
	RWD		G51715	G57092 ⁴⁰	143358 ⁵³ 143359 ⁶⁷		G63883
04-06	All		G51715	G57092 ⁴⁰	143358 ⁵³ 143359 ⁶⁷
	4WD		G51715	G57092 ⁴⁰	143358 ⁵³ 143359 ⁶⁷		G63878
	RWD		G51715	G57092 ⁴⁰	143358 ⁵³ 143359 ⁶⁷		G63883

TITAN XD

16-22	4WD; Exc. Pro 4-X			G63878
-------	-------------------	--	------	------	------	------	------	--	--------	------	------	------	------

VERSA

13-20	All			G51990
12	All			70041
07-11	Models S and SL			70041
	S & SL Models Left		G57202 ⁴⁰
	S & SL Models Right		G57203 ⁴⁰
09	Right		G57203 ⁴⁰

VERSA NOTE

17-19	All			G51990
-------	-----	--	------	------	------	------	------	--	--------	------	------	------	------

X-TRAIL

19-20	Left		G52410		G64050
	Right		G52411		G64050
10-12	Left		G52173		G64050
	Right		G52174		G64050
08	Left		G52173		G64050
	Right		G52174		G64050
02-07	All		143346 ⁵³



XTERRA

14-15	All		G51765
	4WD		G51765	G57413 ⁴⁰

40 Complete Assembled Unit.

53 Hardware from O.E. Part may need to be reused.















APPLICATION GUIDE

Year	Fitment Notes										
		Ultra	Ready Mounts	Max Control\ LTV Severe Duty\ ProGuard\ Guardian	Strut Cushion\ Strut Mount\ Dampers\ Stabilizer	HiJackers\ Load Carrier\ Classic	Ultra	Ready Mounts	Max Control\ LTV Severe Duty\ ProGuard\ Guardian	Strut Cushion\ Strut Mount\ Dampers\ Stabilizer	HiJackers\ Load Carrier\ Classic

NISSAN

NISSAN





























XTERRA (cont)

14-15	4WD; Mfg. to 12/12		G51765		69595
	RWD; Mfg. to 12/12		G51765		69594
05-13	4WD		G57413 ⁴⁰	
	4WD; Mfg. to 12/12			69595
	Mfg. to 12/12		G51765	
	RWD; Mfg. to 12/12			69594
00-04	All		G63813	61662		G63492	61506	49311 ⁷





OLDSMOBILE

OLDSMOBILE

88 SERIES

97-99	All		G56718 ⁹	M56718 ⁹	142524 ⁵⁷ 142530 ⁵⁴ 142751 ⁵⁷	
	Coil(RearSpringType) Exc. Electronic Adjustable Suspension		G56718 ⁹	M56718 ⁹	142524 ⁵⁷ 142530 ⁵⁴ 142751 ⁵⁷		G56726 ⁴³
92-96	All		G56718 ⁹	M56718 ⁹	142227 ⁵⁷ 142751 ⁵⁷	
	Coil(RearSpringType) Exc. Electronic Adjustable Suspension		G56718 ⁹	M56718 ⁹	142227 ⁵⁷ 142751 ⁵⁷		G56726 ⁴³
90-91	All		142227 ⁵⁷ 142751 ⁵⁷	
	Late Design Front Strut without Spring Guard		G56718 ⁹	M56718 ⁹	142227 ⁵⁷ 142751 ⁵⁷	
	Coil(RearSpringType)		142227 ⁵⁷ 142751 ⁵⁷		G56726 ⁴³
90	Early Design Front Strut w/ Spring Guard		G56701	143061 ⁵¹ 142227 ⁵⁷ 142751 ⁵⁷	
86-89	All		142227 ⁵⁷ 142752 ⁵⁷	
	Early Design Front Strut w/ Spring Guard		G56701	143061 ⁵¹ 142227 ⁵⁷ 142752 ⁵⁷	
	Coil(RearSpringType)		142227 ⁵⁷ 142752 ⁵⁷		G56726 ⁴³
71-85	All		69675 ⁵	81446	34073 ⁸		69724	81514	43049 ⁹ 49131 ³⁰
65-70	All		82110		69724	81514	43049 ⁹ 49128 ³⁰
57-64	All		82079	

98

92-96	Air(RearSpringType), Coil(FrontSpringType) Standard Equipment; Exc. Electronic Adjustable Suspension		142751 ⁵⁷	
91-96	CCR Computer Command Ride		G56718 ⁹	M56718 ⁹	

5 Use kit No. 140719 to replace O.E. hardware for lower shock absorber mounting when studs break or self-tapping screws are not longer useable.

8 Pair Packs.

30 For GM Vehicles equipped with factory installed leveling systems, see Ref A.

43 Does not include springs due to vehicle design. See Ref. D for procedures to replace Elec Adj Susp with non-adj product.

54 Kit with Mount and Bearing. Hardware from O.E. Part may need to be reused.

7 Pair Packs, Air hose kit included.



9 See Ref. D for procedures to replace Elec Adj Susp with non-adj product.

40 Complete Assembled Unit.

51 Strut Cushion for use with the Strut/Cartridge/Shocks.

67 Mount Kit. Hardware from O.E. Part may need to be reused.

APPLICATION GUIDE

Year	Fitment Notes										
		Ultra	Ready Mounts	Max Control\ LTV Severe Duty\ ProGuard\ Guardian	Strut Cushion\ Strut Mount\ Dampers\ Stabilizer	HiJackers\ Load Carrier\ Classic	Ultra	Ready Mounts	Max Control\ LTV Severe Duty\ ProGuard\ Guardian	Strut Cushion\ Strut Mount\ Dampers\ Stabilizer	HiJackers\ Load Carrier\ Classic

OLDSMOBILE

98 (cont)

91-96	Exc. Soft Ride Susp (FE1) and Elec. Ride & Handling (FW1)	↓	142227 ⁶⁷	↓
	Air(RearSpringType) Conventional Type Replacement	↓	↓	G56726 ⁴³
91	Standard Equipment; Exc. Electronic Adjustable Suspension	↓	142751 ⁶⁷	↓
85-90	All	↓	G56701	142227 ⁶⁷ 142752 ⁶⁷ 143061 ⁵¹	↓
	Air(RearSpringType) Conventional Type Replacement	↓	G56701	142227 ⁶⁷ 142752 ⁶⁷ 143061 ⁵¹	↓	G56726 ⁴³
71-84	All	⊕	69675 ⁵	81446	34073 ⁸	⊕	69724	81514	43049 ⁸ 49131 ³⁰
65-70	All	⊕	82110	⊕	69724	81514	49128 ³⁰
58-64	All	⊕	82079	⊕
56	All	⊕	⊕	49310 ⁷ 82156
55	All	⊕	82026	⊕	49310 ⁷ 82156
51-54	All	⊕	⊕	49310 ⁷ 82156

OLDSMOBILE

ACHIEVA

95-98	Exc. Electronic Adjustable Suspension	↓	142227 ⁶⁷ 143059 ⁵¹	⊕	81790
92-98	All	↓	143059 ⁵¹	⊕
92-94	Exc. Electronic Adjustable Suspension	↓	142227 ⁶⁷ 143059 ⁵¹	⊕
	Exc. FE3 and Electronic Ride Control	↓	142224 ⁵⁴ 143059 ⁵¹	⊕

ALERO

99-04	All	↓	G56927 ⁴⁰	M55974	↓	G56928 ⁴⁰	M56501	143057 ⁵¹
-------	-----	---	------	----------------------	--------	------	------	---	------	----------------------	--------	----------------------	------

AURORA

01-03	All	↓	G56509	↓
	Exc. Electronic Adjustable Suspension	↓	G56509	G57051 ⁴⁰	↓
	With OE Style air fitting	↓	G56509	⊕	49255 ⁷
	Without OE Style air fitting	↓	G56509	⊕	49228 ³⁰
98-99	All	↓	G56509	↓
	Exc. Electronic Adjustable Suspension	↓	G56509	G57051 ⁴⁰	↓
	With OE Style air fitting	↓	G56509	⊕	49255 ⁷
	Without OE Style air fitting	↓	G56509	⊕	49228 ³⁰

5 Use kit No. 140719 to replace O.E. hardware for lower shock absorber mounting when studs break or self-tapping screws are not longer useable.

8 Pair Packs.

40 Complete Assembled Unit.

51 Strut Cushion for use with the Strut/Cartridge/Shocks.

194 67 Mount Kit. Hardware from O.E. Part may need to be reused.



7 Pair Packs, Air hose kit included.

30 For GM Vehicles equipped with factory installed leveling systems, see Ref A.

43 Does not include springs due to vehicle design. See Ref. D for procedures to replace Elec Adj Susp with non-adj product.

54 Kit with Mount and Bearing. Hardware from O.E. Part may need to be reused.

APPLICATION GUIDE

Year	Fitment Notes										
		Ultra	Ready Mounts	Max Control\ LTV Severe Duty\ ProGuard\ Guardian	Strut Cushion\ Strut Mount\ Dampers\ Stabilizer	HiJackers\ Load Carrier\ Classic	Ultra	Ready Mounts	Max Control\ LTV Severe Duty\ ProGuard\ Guardian	Strut Cushion\ Strut Mount\ Dampers\ Stabilizer	HiJackers\ Load Carrier\ Classic

OLDSMOBILE

AURORA (cont)

97	All	142524 ⁶⁷ 142529 ⁶⁴
	With OE Style air fitting	142524 ⁶⁷ 142529 ⁶⁴	49255 ⁷
	Without OE Style air fitting	142524 ⁶⁷ 142529 ⁶⁴	49228 ³⁰
95-96	All	G56718 ⁹	M56718 ⁹	142227 ⁶⁷ 142751 ⁶⁷
	With OE Style air fitting	G56718 ⁹	M56718 ⁹	142227 ⁶⁷ 142751 ⁶⁷	49255 ⁷
	Without OE Style air fitting	G56718 ⁹	M56718 ⁹	142227 ⁶⁷ 142751 ⁶⁷	49228 ³⁰

OLDSMOBILE

BRAVADA

02-04	All	G51718 ⁴⁵	G57022 ⁴⁰	143241 ⁵³	61717
	Coil(RearSpringType)	G51718 ⁴⁵	G57022 ⁴⁰	143241 ⁵³	G63842	61717
96-01	All	G63423	58423 61531 77423 81516	G63422	58422 61528 77422 81482
	All	G63423	58423 61531 77423 81516	G63422	58422 61528 77422 81482
91-94	All	G63423	58423 61531 77423 81516	G63422	58422 61528 77422 81482
	Torsion Bar(FrontSpringType)	G63423	58423 61531 77423 81516	142316 ⁵³	G63422	58422 61528 77422 81482

CUSTOM CRUISER

77-92	All	69675 ⁵	81446	34073 ⁸	69604	81492	43060 ⁸ 49152 ³⁰
71-76	All	69675 ⁵	81446	34073 ⁸	69604	81492

CUTLASS / CUTLASS SUPREME

99	All	G56927 ⁴⁰	M55974	M56501	143057 ⁵¹
98	All	G56927 ⁴⁰	143057 ⁵¹
	First Design with Rear Strut Lower Mounting Holes at 3.2" Apart	G56927 ⁴⁰	M55975	143057 ⁵¹
	Rear Strut Lower Mounting holes at 2.4" Apart	G56927 ⁴⁰	M55974	143057 ⁵¹
	Second Design with Rear Strut Lower Mounting holes at 2.4" apart	G56927 ⁴⁰	M56501	143057 ⁵¹
97	All	G44459 ³⁵	G56927 ⁴⁰	M55974	143057 ⁵¹
	Exc. Heavy Duty Suspension	G44459 ³⁵	G56927 ⁴⁰	M55974	142144 ⁵³	143057 ⁵¹
	Exc. Rear Strut Lower Mounting holes at 3.2" apart	G44459 ³⁵	G56927 ⁴⁰	M55974	M56708	143057 ⁵¹
	First Design with Rear Strut Lower Mounting Holes at 3.2" Apart	G44459 ³⁵	G56927 ⁴⁰	M55974	M55975	143057 ⁵¹

5 Use kit No. 140719 to replace O.E. hardware for lower shock absorber mounting when studs break or self-tapping screws are not longer useable.

8 Pair Packs.

30 For GM Vehicles equipped with factory installed leveling systems, see Ref A.

40 Complete Assembled Unit.

51 Strut Cushion for use with the Strut/Cartridge/Shocks.

54 Kit with Mount and Bearing. Hardware from O.E. Part may need to be reused.

7 Pair Packs, Air hose kit included.

9 See Ref. D for procedures to replace Elec Adj Susp with non-adj product.





36 Requires special strut installation tool.

45 Strut must be rotated to align notch with lower control arm.

53 Hardware from O.E. Part may need to be reused.

67 Mount Kit. Hardware from O.E. Part may need to be reused.













































APPLICATION GUIDE

Year	Fitment Notes										
		 Ultra	Ready Mounts	Max Control\ LTV Severe Duty\ ProGuard\ Guardian	Strut Cushion\ Strut Mount\ Dampers\ Stabilizer	HiJackers\ Load Carrier\ Classic	 Ultra	Ready Mounts	Max Control\ LTV Severe Duty\ ProGuard\ Guardian	Strut Cushion\ Strut Mount\ Dampers\ Stabilizer	HiJackers\ Load Carrier\ Classic



OLDSMOBILE

OLDSMOBILE



CUTLASS / CUTLASS SUPREME (cont)

88-96	All	 G44459 ³⁶		M56708
	Exc. Heavy Duty Suspension	 G44459 ³⁶	142144 ⁵³		M56708
85-87	All	 69600	81494	34051 ⁸		69604	81492	43060 ⁸ 49334 ³⁰ 49334 ⁷
79-84	All	 69600	81494	34051 ⁸		69604	81492	43060 ⁸ 49334 ³⁰
78-79	Vista Cruiser	 69600	81494	34051 ⁸		69604	81492	49334 ³⁰ 43060 ⁸
76-78	All	 69600	81494	34051 ⁸		69604	81492	43060 ⁸
76-77	Coupe	 69600	81494	34051 ⁸		69604	81492	49152 ³⁰ 43060 ⁸
	Sedan	 69600	81494	34051 ⁸		69604	81492	49152 ³⁰ 43060 ⁸
	Wagon	 69600	81494	34051 ⁸		69604	81492	49334 ³⁰ 43060 ⁸
73-75	All	 69600	81494	34051 ⁸		69604	81492	43060 ⁸ 49152 ³⁰
71-72	All	 69600	81494	34051 ⁸		69604	81492	43060 ⁸
68-72	Heavy Duty Suspension	 69600	81494	34051 ⁸		69604	81492	43060 ⁸
72	Base, S	 69600	81494	34051 ⁸		69604	81492	49152 ³⁰ 43060 ⁸
	Exc. Cruiser	 69600	81494	34051 ⁸		69604	81492	43060 ⁸
71	Exc. Vista Cruiser	 69600	81494	34051 ⁸		69604	81492	49152 ³⁰ 43060 ⁸
68-70	All	 69600	81494	34051 ⁸		81492	43060 ⁸
	Exc. Vista Cruiser	 69600	81494	34051 ⁸		81492	49152 ³⁰ 43060 ⁸
66-67	Exc. Heavy Duty Suspension		69724	81514	43049 ⁸
	Base, Exc. Heavy Duty Suspension		49131 ³⁰
64-67	Heavy Duty Suspension; Exc. Vista Cruiser		49152 ³⁰
	Base, Holiday	 69600	82138	
67	Heavy Duty Suspension		81492	43060 ⁸
	Turnpike Cruiser	 69600	82110		49128 ⁷
64-66	Heavy Duty Suspension		69604	81492	43060 ⁸
64-65	Exc. Heavy Duty Suspension		69724	81514	43049 ⁸ 49131 ³⁰





CUTLASS CALAIS

80-84	All	 69600		69604
-------	-----	-------------------------------------------------------------------------------------------	------	------	------	------	-------------------------------------------------------------------------------------	-------	------	------	------	------



CUTLASS CLASSIC / CUTLASS CRUISER

80-83	All	 69600	81494	34051 ⁸		69604	81492	43060 ⁸ 49334 ³⁰
-------	-----	-------------------------------------------------------------------------------------------	------	-------	------	--------------------	-------------------------------------------------------------------------------------	-------	------	-------	------	-------------------------------------------

DYNAMIC 88

65-66	All	 69600	82110		69724	81514	49128 ³⁰
58-64	All	 69600	82079	

F85

68-72	All	 69600	81494		69604	81492	43060 ⁸ 49152 ³⁰
-------	-----	-------------------------------------------------------------------------------------------	------	-------	------	------	-------------------------------------------------------------------------------------	-------	------	-------	------	-------------------------------------------



7 Pair Packs, Air hose kit included.

30 For GM Vehicles equipped with factory installed leveling systems, see Ref A.

8 Pair Packs.

36 Requires special strut installation tool.

APPLICATION GUIDE

Year	Fitment Notes										
		Ultra	Ready Mounts	Max Control\ LTV Severe Duty\ ProGuard\ Guardian	Strut Cushion\ Strut Mount\ Dampers\ Stabilizer	HiJackers\ Load Carrier\ Classic	Ultra	Ready Mounts	Max Control\ LTV Severe Duty\ ProGuard\ Guardian	Strut Cushion\ Strut Mount\ Dampers\ Stabilizer	HiJackers\ Load Carrier\ Classic

OLDSMOBILE

F85 (cont)

64-67	Exc. Heavy Duty Suspension		82138		69724	81514	43049 ⁸ 49131 ³⁰
	Heavy Duty Suspension		82138		69604	81492	43060 ⁸ 49152 ³⁰
61-67	All		82138	
61-63	Exc. Heavy Duty Suspension		82138		69724	81514
	Heavy Duty Suspension		82138		69604	81492

OLDSMOBILE

FIESTA

57-63	All		82079	
-------	-----	--	------	------	------	------	-------	--	------	------	------	------	------

INTRIGUE

98-02	All		G55948	G57060 ⁴⁰	142524 ⁶⁷ 142526 ⁶⁴		G55949	143061 ⁵¹
	Left		G55948	G57060 ⁴⁰	142524 ⁶⁷ 142526 ⁶⁴		G55949	G56924 ⁴⁰	143073 ⁵³ 143061 ⁵¹
	Right		G55948	G57060 ⁴⁰	142524 ⁶⁷ 142526 ⁶⁴		G55949	G56925 ⁴⁰	143074 ⁵³ 143061 ⁵¹

JETFIRE

62-63	All		82079	
-------	-----	--	------	------	------	------	-------	--	------	------	------	------	------

LSS

96-99	All		G56718 ⁸	M56718 ⁹	142524 ⁶⁷ 142530 ⁶⁴ 142751 ⁶⁷
	Coil(RearSpringType) Conventional Type Replacement for Air Assist Rear Suspension		G56718 ⁸	M56718 ⁹	142524 ⁶⁷ 142530 ⁶⁴ 142751 ⁶⁷	G56726 ⁴³

OMEGA

78-79	All		69600	81494	34051 ⁸		82093
74-77	All		69600	81494	82093
73	Exc. Heavy Duty Suspension		69600	81494	82093

REGENCY

97-98	All		G56718 ⁹	M56718 ⁹	142524 ⁶⁷ 142530 ⁶⁴ 142751 ⁶⁷
	Coil(RearSpringType)		G56718 ⁹	M56718 ⁹	142524 ⁶⁷ 142530 ⁶⁴ 142751 ⁶⁷	G56726 ⁴³

SILHOUETTE

02-04	AWD, FWD		G55948	G57060 ⁴⁰	142524 ⁶⁷ 142526 ⁶⁴		G63776	61659 81924
	FWD		G55948	G57060 ⁴⁰	142524 ⁶⁷ 142526 ⁶⁴	49230 ⁷
97-04	All		G55948	G57060 ⁴⁰	142524 ⁶⁷ 142526 ⁶⁴
97-01	FWD		G55948	G57060 ⁴⁰	142524 ⁶⁷ 142526 ⁶⁴		G63776	61659 81924	49230 ⁷

STARFIRE

65-66	All		82110		69724	81514	43049 ⁸ 49128 ³⁰
-------	-----	--	------	------	------	------	-------	--	-------	------	-------	------	-------------------------------------------

7 Pair Packs, Air hose kit included.

9 See Ref. D for procedures to replace Elec Adj Susp with non-adj product.

40 Complete Assembled Unit.

51 Strut Cushion for use with the Strut/Cartridge/Shocks.

54 Kit with Mount and Bearing. Hardware from O.E. Part may need to be reused.

8 Pair Packs.



30 For GM Vehicles equipped with factory installed leveling systems, see Ref. A.

43 Does not include springs due to vehicle design. See Ref. D for procedures to replace Elec Adj Susp with non-adj product.

53 Hardware from O.E. Part may need to be reused.

67 Mount Kit. Hardware from O.E. Part may need to be reused.

APPLICATION GUIDE

Year	Fitment Notes										
		Ultra	Ready Mounts	Max Control\ LTV Severe Duty\ ProGuard\ Guardian	Strut Cushion\ Strut Mount\ Dampers\ Stabilizer	HiJackers\ Load Carrier\ Classic	Ultra	Ready Mounts	Max Control\ LTV Severe Duty\ ProGuard\ Guardian	Strut Cushion\ Strut Mount\ Dampers\ Stabilizer	HiJackers\ Load Carrier\ Classic

OLDSMOBILE

STARFIRE (cont)

61-64	All	⊕	82079	⊕
57	All	⊕	82079	⊕

OLDSMOBILE

TORONADO

90-92	All	⊕	142227 ⁶⁷	...	⊕
71-78	All	⊕	82010	⊕	69604	...	81492	...	43060 ⁸ 49152 ³⁰
67-70	Vertically Mounted	⊕	82010	⊕	82034
66	Vertically Mounted	⊕	82010	⊕	49122 ⁷
	Vertically Mounted; Single Leaf Rear Springs	⊕	⊕	82040

VISTA CRUISER

73-75	All	⊕	69600	⊕
68-72	All	⊕	69600	⊕	69606	...	81495	...	43140 ⁸ 49205 ⁷
64-67	All	⊕	⊕	69606	...	81495	...	43140 ⁸ 49205 ⁷

OPEL

OPEL

69-73	All	⊕	⊕	82039
-------	-----	---	-----	-----	-----	-----	-----	---	-----	-----	-----	-----	-------

OPEL

PEUGEOT

403

59-66	All	⊕	⊕	82125
-------	-----	---	-----	-----	-----	-----	-----	---	-----	-----	-----	-----	-------

PEUGEOT

404

61-67	All	⊕	⊕	82125
-------	-----	---	-----	-----	-----	-----	-----	---	-----	-----	-----	-----	-------

504 / 505 / 604

91	All	⊕	143061 ⁵¹	...	⊕
86-90	Sedan	⊕	143061 ⁵¹	...	⊕

PLYMOUTH

ACCLAIM

89-95	All	⊕	G55526	142567 ⁶⁷ 142933 ⁶⁸ 142940 ⁶⁶ 143059 ⁵¹	...	⊕	69632	...	81459	...	49369 ⁷
-------	-----	---	--------	-----	-----	----------------------------------------------------------------------------------------------	-----	---	-------	-----	-------	-----	--------------------

PLYMOUTH

ARROW

76-80	All	⊕	143059 ⁵¹	...	⊕	81676
-------	-----	---	-----	-----	-----	----------------------	-----	---	-----	-----	-------	-----	-----

BARRACUDA

70-74	All	⊕	82090	⊕	49106 ⁷ 82131
64-69	All	⊕	82090	⊕	81469	...	49110 ⁷

7 Pair Packs, Air hose kit included.

30 For GM Vehicles equipped with factory installed leveling systems, see Ref A.



66 Upper Spring Seat with Spacer. Hardware from O.E. Part may need to be reused.

8 Pair Packs.

51 Strut Cushion for use with the Strut/Cartridge/Shocks.

67 Mount Kit. Hardware from O.E. Part may need to be reused.

APPLICATION GUIDE

Year	Fitment Notes										
		Ultra	Ready Mounts	Max Control\ LTV Severe Duty\ ProGuard\ Guardian	Strut Cushion\ Strut Mount\ Dampers\ Stabilizer	HiJackers\ Load Carrier\ Classic	Ultra	Ready Mounts	Max Control\ LTV Severe Duty\ ProGuard\ Guardian	Strut Cushion\ Strut Mount\ Dampers\ Stabilizer	HiJackers\ Load Carrier\ Classic

PLYMOUTH

BELVEDERE

62-70	All	○	82090	○	49106 ⁷ 82131
57-61	All	○	82072	○	81469	49110 ⁷
53-56	All	○	○	81469	49110 ⁷

PLYMOUTH

BREEZE

99-00	Exc. JA Mfr Body Code	○	G51267
00	Left	○	G57431 ⁴⁰	143064 ⁵¹	○	G51268	G57025 ⁴⁰	143063 ⁵¹
	Right	○	G57432 ⁴⁰	143064 ⁵¹	○	G51268	G57025 ⁴⁰	143063 ⁵¹
99	Left	○	G57431 ⁴⁰	143030 ⁵³ 143064 ⁵¹	○	G51268	G57025 ⁴⁰	143063 ⁵¹
	Right	○	G57432 ⁴⁰	143030 ⁵³ 143064 ⁵¹	○	G51268	G57025 ⁴⁰	143063 ⁵¹
96-98	All	○	143030 ⁵³ 143064 ⁵¹	○	G57437 ⁴⁰	143063 ⁵¹
	Convertible	○	143030 ⁵³ 143064 ⁵¹	○	G57422 ⁴⁰ G57437 ⁴⁰	143063 ⁵¹

CAMBRIDGE

51-53	All	○	○	81469	49110 ⁷
-------	-----	---	-------	-------	-------	-------	-------	---	-------	-------	-------	-------	-------	--------------------

CARAVELLE

88	All	○	G55526	142567 ⁵⁷ 142933 ⁵⁸	○
	Mfg. from 1/2/86	○	G55526	142940 ⁶⁶ 142567 ⁵⁷ 142933 ⁵⁸	○
	FWD	○	G55526	142567 ⁵⁷ 142933 ⁵⁸	○	69632	81459	49369 ⁷
86-87	All	○	G55526	142567 ⁵⁷ 142933 ⁵⁸	○	69632	81459	49369 ⁷
	Mfg. from 1/2/86	○	G55526	142940 ⁶⁶ 142567 ⁵⁷ 142933 ⁵⁸	○	69632	81459	49369 ⁷
83-85	All	○	○	69632	81459	49369 ⁷	

CHAMP

79-82	All	○	143059 ⁵¹	○
-------	-----	---	-------	-------	-------	-------	----------------------	-------	---	-------	-------	-------	-------	-------

COLT

94	All	○	○	142419 ⁶⁸
	Sedan	○	G55911	142329 ⁵³	○	G51063	142419 ⁶⁸
	Wagon	○	○	69462	142419 ⁶⁸
92-93	All	○	143057 ⁵¹	○	142419 ⁶⁸
	Wagon	○	143057 ⁵¹	○	69462	142419 ⁶⁸
93	Sedan	○	G55911	142329 ⁵³ 143057 ⁵¹	○	G51063	142419 ⁶⁸

7 Pair Packs, Air hose kit included.

51 Strut Cushion for use with the Strut/Cartridge/Shocks.

66 Upper Spring Seat with Spacer. Hardware from O.E. Part may need to be reused.



68 Mount Kit. Hardware from O.E. Part may need to be reused.;

40 Complete Assembled Unit.

53 Hardware from O.E. Part may need to be reused.

67 Mount Kit. Hardware from O.E. Part may need to be reused.

APPLICATION GUIDE

Year	Fitment Notes										
		Ultra	Ready Mounts	Max Control\ LTV Severe Duty\ ProGuard\ Guardian	Strut Cushion\ Strut Mount\ Dampers\ Stabilizer	HiJackers\ Load Carrier\ Classic	Ultra	Ready Mounts	Max Control\ LTV Severe Duty\ ProGuard\ Guardian	Strut Cushion\ Strut Mount\ Dampers\ Stabilizer	HiJackers\ Load Carrier\ Classic

PLYMOUTH

COLT (cont)

90-91	FWD, Hatchback	⌘	142240 ⁵⁴ 143057 ⁵¹	⌘	142419 ⁶⁸
89-91	All	⌘	⌘	142419 ⁶⁸
	Vista, Wagon	⌘	143059 ⁵¹	⌘	142419 ⁶⁸
89	FWD, Hatchback	⌘	143057 ⁵¹	⌘	142419 ⁶⁸
	Hatchback	⌘	142240 ⁵⁴	⌘	142419 ⁶⁸
84-88	Vista, Wagon	⌘	143059 ⁵¹	⌘
81-83	Hatchback	⌘	143059 ⁵¹	⌘
80	All	⊙	⊙	43048 ⁸ 49310 ⁷ 82156
	Hatchback	⌘	143059 ⁵¹	⊙	43048 ⁸ 49310 ⁷ 82156
76-79	All	⌘	⊙	81676	43048 ⁸ 49310 ⁷ 82156
	Sedan	⌘	143059 ⁵¹	⊙	81676	43048 ⁸ 49310 ⁷ 82156
	Wagon	⌘	143059 ⁵¹	⊙	81676	43048 ⁸ 49310 ⁷ 82156

CONCORD

51-52	All	⊙	⊙	81469	49110 ⁷
-------	-----	---	------	------	------	------	------	---	------	------	-------	------	--------------------

CRANBROOK

51-53	All	⊙	⊙	81469	49110 ⁷
-------	-----	---	------	------	------	------	------	---	------	------	-------	------	--------------------

CUSTOM

58-61	All	⊙	82072	⊙	81469	49110 ⁷
-------	-----	---	------	------	------	------	-------	---	------	------	-------	------	--------------------

DUSTER

70-76	All	⊙	82090	⊙	81469	49110 ⁷
-------	-----	---	------	------	------	------	-------	---	------	------	-------	------	--------------------

EXPO

87-89	All	⌘	143057 ⁵¹	⌘	142173 ⁵³ 143059 ⁵¹
-------	-----	---	------	------	------	----------------------	------	---	------	------	------	----------------------------------------------	------

FLEET SPECIAL

62-63	All	⊙	82090	⊙	49106 ⁷ 82131
60-61	All	⊙	82072	⊙	81469	49110 ⁷

FURY

77-78	All	⊙	81153	⊙
	Police Package	⊙	81153	⊙	49106 ⁷ 82131
75-76	All	⊙	81153	⊙	49106 ⁷ 82131
74	All	⊙	⊙	49106 ⁷ 82131

7 Pair Packs, Air hose kit included.

51 Strut Cushion for use with the Strut/Cartridge/Shocks.





200 54 Kit with Mount and Bearing. Hardware from O.E. Part may need to be reused.

8 Pair Packs.

53 Hardware from O.E. Part may need to be reused.



















68 Mount Kit. Hardware from O.E. Part may need to be reused.;

APPLICATION GUIDE

Year	Fitment Notes										
		 Ultra	Ready Mounts	Max Control\ LTV Severe Duty\ ProGuard\ Guardian	Strut Cushion\ Strut Mount\ Dampers\ Stabilizer	HiJackers\ Load Carrier\ Classic	 Ultra	Ready Mounts	Max Control\ LTV Severe Duty\ ProGuard\ Guardian	Strut Cushion\ Strut Mount\ Dampers\ Stabilizer	HiJackers\ Load Carrier\ Classic













PLYMOUTH

FURY (cont)





73	All		82011		81091
	Exc. Wagon		82011		81091
	Exc. Wagon		82011		81091	49149 ⁷
	Wagon		82011		81091	49106 ⁷ 82131
70-72	All		82011		81091	49149 ⁷
65-69	All		82011		49106 ⁷ 82131
62-64	All		82090		49106 ⁷ 82131
57-61	All		82072		81469	49110 ⁷
56	All			81469	49110 ⁷

PLYMOUTH







GRAN FURY

80-81	All		81153	
74-77	All			49106 ⁷ 82131
73	All		82011	
	Hardtop		82011		81091	49149 ⁷
	Wagon		82011		49106 ⁷ 82131
72	All		82011		81091	49149 ⁷



GTX

71	All			49106 ⁷ 82131
67-70	All		82090		49106 ⁷ 82131







HORIZON

90	All			142173 ⁵³
	Hatchback		143059 ⁵¹		142173 ⁵³
78-89	All		143057 ⁵¹		142173 ⁵³



LASER

90-94	All		142219 ⁵³ 143057 ⁵¹		142419 ⁵⁸ 143064 ⁵¹
-------	-----	-------------------------------------------------------------------------------------	------	------	------	----------------------------------------------	------	---------------------------------------------------------------------------------------	------	------	------	----------------------------------------------	------

NEON

00-01	Left		G55892	G56975 ⁴⁰	M55892	142932 ⁵⁸		G56973 ⁴⁰	143256 ⁵³
	Right		G55892	G56975 ⁴⁰	M55892	142932 ⁵⁸		G56974 ⁴⁰	143256 ⁵³
95-99	All		142840 ⁵⁴ 143057 ⁵¹		143059 ⁵¹

PICKUP

79-82	All		G63950	61556		G63907	61500 77907 81147	43048 ⁸ 49310 ⁷
-------	-----	-------------------------------------------------------------------------------------	--------	------	-------	------	------	---------------------------------------------------------------------------------------	--------	------	-------------------------	------	------------------------------------------

7 Pair Packs, Air hose kit included.

40 Complete Assembled Unit.

53 Hardware from O.E. Part may need to be reused.





68 Mount Kit. Hardware from O.E. Part may need to be reused.;

8 Pair Packs.

51 Strut Cushion for use with the Strut/Cartridge/Shocks.



54 Kit with Mount and Bearing. Hardware from O.E. Part may need to be reused.

APPLICATION GUIDE





Year	Fitment Notes										
		 Ultra	Ready Mounts	Max Control\ LTV Severe Duty\ ProGuard\ Guardian	Strut Cushion\ Strut Mount\ Dampers\ Stabilizer	Hijackers\ Load Carrier\ Classic	 Ultra	Ready Mounts	Max Control\ LTV Severe Duty\ ProGuard\ Guardian	Strut Cushion\ Strut Mount\ Dampers\ Stabilizer	Hijackers\ Load Carrier\ Classic

PLYMOUTH







PICKUP (cont)

79-82	All models with factory frame bracket. Kit 143168 required to install to linkage.	 G63950	61556	6802SE ⁸⁴	 G63907	61500 77907 81147	43048 ⁸ 49310 ⁷
-------	-----------------------------------------------------------------------------------	------------------------------------------------------------------------------------------	------	-------	----------------------	------	------------------------------------------------------------------------------------------	------	-------------------------	------	------------------------------------------





PLAZA

57-58	All		82072		81469	49110 ⁷
54-56	All			81469	49110 ⁷



RELIANT

86-89	All	 G55526	14256 ⁶⁷ 142933 ⁶⁸ 142940 ⁶⁶	 69632	81459	49369 ⁷
84-85	All		 69632	81459	49369 ⁷
81-83	All		143057 ⁵¹	 69632	81459	49369 ⁷





ROAD RUNNER

73-75	All		81153		49106 ⁷ 82131
68-72	All		82090		49106 ⁷ 82131







SAPPORO

78-83	All		143059 ⁵¹	
-------	-----	------------------------------------------------------------------------------------------	------	------	----------------------	------	------------------------------------------------------------------------------------------	------	------	------	------





SATELLITE

73-74	All		81153		49106 ⁷ 82131
65-72	All		82090		49106 ⁷ 82131



SAVOY

62-64	All		82090		49106 ⁷ 82131
57-61	All		82072		81469	49110 ⁷
53-56	All			81469	49110 ⁷





SCAMP

83	All		143057 ⁵¹	
71-76	All		82090		81469	49110 ⁷



SPORT WAGON

60-61	All		82072		81469	49110 ⁷
-------	-----	------------------------------------------------------------------------------------------	------	------	------	-------	------------------------------------------------------------------------------------------	------	-------	------	--------------------



SUBURBAN

57-61	All		82072		81469	49110 ⁷
51-56	All			81469	49110 ⁷

SUNDANCE

87-94	All	 G55526	14256 ⁶⁷ 142933 ⁶⁸ 142940 ⁶⁶	 69632	81459	49369 ⁷
-------	-----	--------------------------------------------------------------------------------------------	------	------	---------------------------------------------------------------------	------	-------------------------------------------------------------------------------------------	------	-------	------	--------------------

SUPERBIRD

70	All		82090		49106 ⁷ 82131
----	-----	------------------------------------------------------------------------------------------	------	------	------	-------	------------------------------------------------------------------------------------------	------	------	------	-----------------------------

7 Pair Packs, Air hose kit included.

51 Strut Cushion for use with the Strut/Cartridge/Shocks.



67 Mount Kit. Hardware from O.E. Part may need to be reused.

8 Pair Packs.

66 Upper Spring Seat with Spacer. Hardware from O.E. Part may need to be reused.



































68 Mount Kit. Hardware from O.E. Part may need to be reused.;

APPLICATION GUIDE





Year	Fitment Notes										
		Ultra	Ready Mounts	Max Control\ LTV Severe Duty\ ProGuard\ Guardian	Strut Cushion\ Strut Mount\ Dampers\ Stabilizer	HiJackers\ Load Carrier\ Classic	Ultra	Ready Mounts	Max Control\ LTV Severe Duty\ ProGuard\ Guardian	Strut Cushion\ Strut Mount\ Dampers\ Stabilizer	HiJackers\ Load Carrier\ Classic

PLYMOUTH TRAILDUSTER



PLYMOUTH

81	All		34052 ⁸		49149 ⁷
	4WD		G63183	61632 81825	34052 ⁸		81342	49149 ⁷
	Dual System Steering Stabilizer; Exc. Vacuum Servo Mounted on Drivers Side of Axle		6802SE ⁸⁴	34052 ⁸		49149 ⁷
	RWD		G63359 ³⁵	58359 ³⁵ 61523 ³⁵ 81096 ³⁵	34052 ⁸		G63353	81091	49149 ⁷
	Single System Steering Stabilizer		6803SE ⁸⁴	34052 ⁸		49149 ⁷
76-80	All			49149 ⁷
	4WD		G63183	61632 81825		81342	49149 ⁷
	Dual System Steering Stabilizer; Exc. Vacuum Servo Mounted on Drivers Side of Axle		6802SE ⁸⁴		49149 ⁷
	Single System Steering Stabilizer		6803SE ⁸⁴		49149 ⁷
75-80	RWD		G63359 ³⁵	58359 ³⁵ 61523 ³⁵ 81096 ³⁵	34052 ⁸		G63353	81091	49149 ⁷
75	All			G63353	49149 ⁷
	4WD		G63183	61632 81825		G63353	49149 ⁷
	Dual System Steering Stabilizer; Exc. Vacuum Servo Mounted on Drivers Side of Axle		6802SE ⁸⁴		G63353	49149 ⁷
	Single System Steering Stabilizer		6803SE ⁸⁴		G63353	49149 ⁷
74	All		G63183	61632 81825		G63353	81091	49149 ⁷
	Dual System Steering Stabilizer; Exc. Vacuum Servo Mounted on Drivers Side of Axle		G63183	61632 81825	6802SE ⁸⁴		G63353	81091	49149 ⁷
	Single System Steering Stabilizer		G63183	61632 81825	6803SE ⁸⁴		G63353	81091	49149 ⁷



TURISMO

85	All		143057 ⁵¹		142173 ⁵³
83	All		143057 ⁵¹		142173 ⁵³



VALIANT

60-76	All		82090		81469	49110 ⁷
-------	-----	-------------------------------------------------------------------------------------	------	------	------	------	-------	---------------------------------------------------------------------------------------	------	------	-------	------	--------------------





VAN 1/2 TON, PB SERIES

74-83	All		G63359 ³⁵	58359 ³⁵ 61523 ³⁵ 81096 ³⁵	34052 ⁸		G63413	61522 ⁶ 81496	43085 ⁵ 49212 ⁷
-------	-----	-------------------------------------------------------------------------------------	----------------------	------	-------------------------------------------------------------------	------	--------------------	---------------------------------------------------------------------------------------	--------	------	-----------------------------	------	------------------------------------------

VAN 3/4 TON, PB SERIES

74-83	All		G63359 ³⁵	58359 ³⁵ 61523 ³⁵ 81096 ³⁵	34052 ⁸		G63413	61522 ⁶ 81496	43085 ⁵ 49212 ⁷
-------	-----	-------------------------------------------------------------------------------------	----------------------	------	-------------------------------------------------------------------	------	--------------------	---------------------------------------------------------------------------------------	--------	------	-----------------------------	------	------------------------------------------

VAN 1 TON, PB SERIES

74-83	All			G63413	61522 ⁶ 81496	43085 ⁵ 49212 ⁷
	4000# Front Axle		G63360 ³⁵	81834		G63413	61522 ⁶ 81496	43085 ⁵ 49212 ⁷

6 It is recommended that when replacing shocks on vehicles with "quad shocks" all 4 shocks should be matched by series.

8 Pair Packs.

51 Strut Cushion for use with the Strut/Cartridge/Shocks.



84 Replacement damper for vehicles with the Gabriel Aftermarket mounting kit

7 Pair Packs, Air hose kit included.

35 Sight grinding of control arm opening is required to install product made before Aug 1988.

53 Hardware from O.E. Part may need to be reused.



APPLICATION GUIDE

Year	Fitment Notes										
		Ultra	Ready Mounts	Max Control\ LTV Severe Duty\ ProGuard\ Guardian	Strut Cushion\ Strut Mount\ Dampers\ Stabilizer	HiJackers\ Load Carrier\ Classic	Ultra	Ready Mounts	Max Control\ LTV Severe Duty\ ProGuard\ Guardian	Strut Cushion\ Strut Mount\ Dampers\ Stabilizer	HiJackers\ Load Carrier\ Classic



PLYMOUTH

PLYMOUTH











VAN 1 TON, PB SERIES (cont)

74-83	Exc. 4000# Front Axle		G63359 ³⁵	58359 ³⁵ 61523 ³⁵ 81096 ³⁵	34052 ⁸		G63413	61522 ⁸ 81496	43085 ⁸ 49212 ⁷
-------	-----------------------	-----------------------------------------------------------------------------------	----------------------	------	-------------------------------------------------------------------	------	--------------------	-----------------------------------------------------------------------------------	--------	------	-----------------------------	------	------------------------------------------

VIP

67	All		82011		49106 ⁷ 82131
----	-----	-----------------------------------------------------------------------------------	------	------	------	------	-------	-----------------------------------------------------------------------------------	------	------	------	------	-----------------------------



VOYAGER / GRAND VOYAGER

96-00	All		G55697	M55697	143059 ⁵¹	
	Exc. Hydraulic Self-Leveling System		G55697	M55697	143059 ⁵¹		G63690 ¹⁰	61605 ³⁴ 81878
	Non-ABS		G55697	M55697	143059 ⁵¹		49236 ⁷
86-95	All		142567 ⁶⁷ 142933 ⁶⁸ 143059 ⁵¹		G63426	49236 ⁷
84-85	All		143059 ⁵¹		G63426	49236 ⁷







PONTIAC

PONTIAC



















ACADIAN

76-87	All			81340	43140 ⁸
-------	-----	------------------------------------------------------------------------------------	------	------	------	------	------	------------------------------------------------------------------------------------	------	------	-------	------	--------------------

AZTEK

01-05	All		G57274 ⁴⁰	142526 ⁵⁴	
	AWD		G57274 ⁴⁰	142526 ⁵⁴		G63868	61777
	FWD		G57274 ⁴⁰	142526 ⁵⁴		G63869

BONNEVILLE

00-05	All		G56509	
	Exc. Electronic Adjustable Suspension		G56509	G57051 ⁴⁰	
	Without OE Style air fitting		G56509		49228 ³⁰
00-04	With OE Style air fitting		G56509		49255 ⁷
97-99	All		142530 ⁵⁴ 142751 ⁶⁷	
	Exc. CCR Computer Command Ride		G56718 ⁹	M56718 ⁹	142530 ⁵⁴ 142751 ⁶⁷	
	Coil(RearSpringType) Exc. Electronic Adjustable Suspension		142530 ⁵⁴ 142751 ⁶⁷		G56726 ⁴³
94-96	All		142227 ⁶⁷ 142751 ⁶⁷	
	Exc. CCR Computer Command Ride		G56718 ⁹	M56718 ⁹	142227 ⁶⁷ 142751 ⁶⁷	

6 It is recommended that when replacing shocks on vehicles with "quad shocks" all 4 shocks should be matched by series.

8 Pair Packs.

10 The Nivomat leveling shocks are on the rear only. If suspension spring contacts units, rotate suspension spring 180 degrees.

34 If suspension spring contacts this unit, rotate suspension spring 180 degrees.

40 Complete Assembled Unit.

51 Strut Cushion for use with the Strut/Cartridge/Shocks.

67 Mount Kit. Hardware from O.E. Part may need to be reused.

7 Pair Packs, Air hose kit included.

9 See Ref. D for procedures to replace Elec Adj Susp with non-adj product.

30 For GM Vehicles equipped with factory installed leveling systems, see Ref A.



35 Sight grinding of control arm opening is required to install product made before Aug 1988.

43 Does not include springs due to vehicle design. See Ref. D for procedures to replace Elec Adj Susp with non-adj product.

54 Kit with Mount and Bearing. Hardware from O.E. Part may need to be reused.

68 Mount Kit. Hardware from O.E. Part may need to be reused.;

APPLICATION GUIDE

Year	Fitment Notes										
		Ultra	Ready Mounts	Max Control\ LTV Severe Duty\ ProGuard\ Guardian	Strut Cushion\ Strut Mount\ Dampers\ Stabilizer	HiJackers\ Load Carrier\ Classic	Ultra	Ready Mounts	Max Control\ LTV Severe Duty\ ProGuard\ Guardian	Strut Cushion\ Strut Mount\ Dampers\ Stabilizer	HiJackers\ Load Carrier\ Classic

PONTIAC

PONTIAC

BONNEVILLE (cont)

94-96	Coil(RearSpringType) Exc. Electronic Adjustable Suspension	⌄	142227 ⁶⁷ 142751 ⁶⁷	⌄	G56726 ⁴³
91-93	All	⌄	G56718 ⁸	M56718 ⁹	142227 ⁶⁷ 142751 ⁶⁷	⌄
	Coil(RearSpringType) Exc. Electronic Adjustable Suspension	⌄	G56718 ⁸	M56718 ⁹	142227 ⁶⁷ 142751 ⁶⁷	⌄	G56726 ⁴³
90	All	⌄	142227 ⁶⁷ 142751 ⁶⁷	⌄
	Early Design Front Strut w/ Spring Guard	⌄	G56701	142227 ⁶⁷ 142751 ⁶⁷	⌄
	Late Design Front Strut without Spring Guard	⌄	G56718 ⁸	M56718 ⁹	142227 ⁶⁷ 142751 ⁶⁷	⌄
	Coil(RearSpringType)	⌄	142227 ⁶⁷ 142751 ⁶⁷	⌄	G56726 ⁴³
87-89	All	⌄	142227 ⁶⁷ 142752 ⁶⁷ 143061 ⁵¹	⌄
	Early Design Front Strut w/ Spring Guard	⌄	G56701	142227 ⁶⁷ 142752 ⁶⁷ 143061 ⁵¹	⌄
	Coil(RearSpringType)	⌄	142227 ⁶⁷ 142752 ⁶⁷ 143061 ⁵¹	⌄	G56726 ⁴³
82-86	All	⌄	69600	81494	34051 ⁸	⌄	69604	81492	43060 ⁹ 49334 ³⁰
71-81	All	⌄	69675 ⁵	81446	34073 ⁸	⌄	69724	81514	43049 ⁹ 49131 ³⁰
65-70	All	⌄	82110	⌄	69724	81514	43049 ⁹ 49128 ³⁰
63-64	All	⌄	82099	⌄	69724	81514	43049 ⁹ 49128 ³⁰
61-62	All	⌄	82099	⌄
58-60	All	⌄	82099	⌄	81318	49310 ⁷ 82156
57	All	⌄	82026	⌄	81318	49310 ⁷ 82156

CATALINA

77-81	Wagon	⌄	69675 ⁵	81446	34073 ⁸	⌄	69604	81492	49152 ³⁰
71-81	All	⌄	69675 ⁵	81446	34073 ⁸	⌄
	Exc. Wagon	⌄	69675 ⁵	81446	34073 ⁸	⌄	69724	81514	43049 ⁹ 49131 ³⁰
74-75	Wagon	⌄	69675 ⁵	81446	34073 ⁸	⌄	69604	81492	49152 ³⁰
71-73	Wagon	⌄	69675 ⁵	81446	34073 ⁸	⌄	69604	81492
	Wagon Wagon	⌄	69675 ⁵	81446	34073 ⁸	⌄	49152 ³⁰
65-70	All	⌄	82110	⌄	69724	81514	43049 ⁹ 49128 ³⁰
63-64	All	⌄	82099	⌄	69724	81514	43049 ⁹ 49128 ³⁰
61-62	All	⌄	82099	⌄
58-60	All	⌄	82099	⌄	81318	49310 ⁷ 82156
50-57	All	⌄	82026	⌄	49310 ⁷ 82156

5 Use kit No. 140719 to replace O.E. hardware for lower shock absorber mounting when studs break or self-tapping screws are not longer useable.

8 Pair Packs.

30 For GM Vehicles equipped with factory installed leveling systems, see Ref A.

51 Strut Cushion for use with the Strut/Cartridge/Shocks.



7 Pair Packs, Air hose kit included.

9 See Ref. D for procedures to replace Elec Adj Susp with non-adj product.

43 Does not include springs due to vehicle design. See Ref. D for procedures to replace Elec Adj Susp with non-adj product.

67 Mount Kit. Hardware from O.E. Part may need to be reused.

APPLICATION GUIDE

Year	Fitment Notes										
		Ultra	Ready Mounts	Max Control\ LTV Severe Duty\ ProGuard\ Guardian	Strut Cushion\ Strut Mount\ Dampers\ Stabilizer	HiJackers\ Load Carrier\ Classic	Ultra	Ready Mounts	Max Control\ LTV Severe Duty\ ProGuard\ Guardian	Strut Cushion\ Strut Mount\ Dampers\ Stabilizer	HiJackers\ Load Carrier\ Classic

PONTIAC

CHIEFTAIN

58	All	⊕	82099	⊕	81318	49310 ⁷ 82156
49-57	All	⊕	82026	⊕	49310 ⁷ 82156

PONTIAC

EXECUTIVE

67-70	All	⊕	82110	⊕	69724	81514	43049 ⁸ 49128 ³⁰
-------	-----	---	------	------	------	------	-------	---	-------	------	-------	------	-------------------------------------------

FIERO

84-88	All	⊕	⊕	143059 ⁵¹
-------	-----	---	------	------	------	------	------	---	------	------	------	----------------------	------

FIREBIRD

93-02	Left	⊕	G57107 ⁴⁰	⊕	69676	75676 81481	49203 ⁷
	Right	⊕	G57108 ⁴⁰	⊕	69676	75676 81481	49203 ⁷
82-92	All	⊕	G56700	⊕	69676	75676 81481	49203 ⁷
70-81	All	⊕	69675 ⁵	81446	34073 ⁸	⊕	69624	81095	49135 ³⁰
68-69	All	⊕	69600	81494	34051 ⁸	⊕	69606	81495
	Multi-Leaf Springs	⊕	69600	81494	34051 ⁸	⊕	69606	81495	43140 ⁸
	Single Leaf Spring	⊕	69600	81494	34051 ⁸	⊕	69606	81495	49122 ⁷
67	All	⊕	69600	81494	34051 ⁸	⊕
	Multi-Leaf Springs	⊕	69600	81494	34051 ⁸	⊕	43140 ⁸
	Single Leaf Rear Springs	⊕	69600	81494	34051 ⁸	⊕	82040
	Single Leaf Spring	⊕	69600	81494	34051 ⁸	⊕	49122 ⁷

FIREFLY

95-99	All	⊕	⊕	G55772
94-99	CAN	⊕	143059 ⁵¹	⊕	G55772	143057 ⁵¹
89-91	CAN	⊕	143059 ⁵¹	⊕	G55772	143057 ⁵¹

G3

09-10	Left	⊕	G56886	G57130 ⁴⁰	143239 ⁵³	⊕
	Right	⊕	G56887	G57131 ⁴⁰	143239 ⁵³	⊕
07-08	Left	⊕	G56886	⊕
	Right	⊕	G56887	⊕

G5

07-09	Left	⊕	G56810	G57047 ⁴⁰	143323 ⁵³	⊕	69587
	Right	⊕	G56810	G57048 ⁴⁰	143323 ⁵³	⊕	69587

5 Use kit No. 140719 to replace O.E. hardware for lower shock absorber mounting when studs break or self-tapping screws are not longer useable.

8 Pair Packs.



40 Complete Assembled Unit.

7 Pair Packs, Air hose kit included.

30 For GM Vehicles equipped with factory installed leveling systems, see Ref A.

51 Strut Cushion for use with the Strut/Cartridge/Shocks.















APPLICATION GUIDE

Year	Fitment Notes										
		Ultra	Ready Mounts	Max Control\ LTV Severe Duty\ ProGuard\ Guardian	Strut Cushion\ Strut Mount\ Dampers\ Stabilizer	HiJackers\ Load Carrier\ Classic	Ultra	Ready Mounts	Max Control\ LTV Severe Duty\ ProGuard\ Guardian	Strut Cushion\ Strut Mount\ Dampers\ Stabilizer	HiJackers\ Load Carrier\ Classic













PONTIAC

G6





PONTIAC

06-10	Left		G57121 ⁴⁰	143354 ⁵³		69590
	Right		G57122 ⁴⁰	143355 ⁵³		69590
05-10	Exc. Convertible and 4Cyl Left		G57069 ⁴⁰	
	Exc. Convertible and 4Cyl Right		G57070 ⁴⁰	
	Maxx Models			143425 ⁶⁸
05	Left		143354 ⁵³		69590
	Right		143355 ⁵³		69590





















GRAND AM

99-05	All		G56927 ⁴⁰	M55974		G56928 ⁴⁰	M56501	143057 ⁵¹
95-98	Exc. Electronic Adjustable Suspension		142227 ⁶⁷	143059 ⁵¹		81790
92-94	Exc. Electronic Adjustable Suspension		142224 ⁵⁴	143059 ⁵¹	
	SE, Exc. FE3 and Electronic Ride Control		142227 ⁶⁷	
78-80	All		69600	81494	34051 ⁸		69604	81492	43060 ⁸ 49334 ³⁰
73-75	All		69600	81494	34051 ⁸		69604	81492	43060 ⁸ 49152 ³⁰

GRAND LEMANS

78-83	All		69600	81494	34051 ⁸		69604	81492	43060 ⁸ 49334 ³⁰
75-77	All		69600	81494	34051 ⁸		69604	81492	43060 ⁸ 49152 ³⁰

GRAND PRIX

04-08	All		G57141 ⁴⁰	142524 ⁶⁷	142526 ⁵⁴	
	Exc. Models w/ 17" Wheels		G57141 ⁴⁰	142524 ⁶⁷	142526 ⁵⁴		G55949
	Left		G57141 ⁴⁰	142524 ⁶⁷	142526 ⁵⁴		143073 ⁵³
	Left Models w/ 16" Wheels		G57141 ⁴⁰	142524 ⁶⁷	142526 ⁵⁴		G56924 ⁴⁰
	Models w/ 17" or 18" Wheels		G57141 ⁴⁰	142524 ⁶⁷	142526 ⁵⁴		G52244
	Right		G57141 ⁴⁰	142524 ⁶⁷	142526 ⁵⁴		143074 ⁵³
	Right Models w/ 16" Wheels		G57141 ⁴⁰	142524 ⁶⁷	142526 ⁵⁴		G56925 ⁴⁰
97-03	All		G55948	G57060 ⁴⁰	142524 ⁶⁷	142526 ⁵⁴	
	Exc. Models w/ 17" Wheels		G55948	G57060 ⁴⁰	142524 ⁶⁷	142526 ⁵⁴		G55949
	Left		G55948	G57060 ⁴⁰	142524 ⁶⁷	142526 ⁵⁴		143073 ⁵³

8 Pair Packs.

40 Complete Assembled Unit.

53 Hardware from O.E. Part may need to be reused.

67 Mount Kit. Hardware from O.E. Part may need to be reused.





30 For GM Vehicles equipped with factory installed leveling systems, see Ref. A.

51 Strut Cushion for use with the Strut/Cartridge/Shocks.

54 Kit with Mount and Bearing. Hardware from O.E. Part may need to be reused.

68 Mount Kit. Hardware from O.E. Part may need to be reused.;



















APPLICATION GUIDE

Year	Fitment Notes										
		 Ultra	Ready Mounts	Max Control\ LTV Severe Duty\ ProGuard\ Guardian	Strut Cushion\ Strut Mount\ Dampers\ Stabilizer	HiJackers\ Load Carrier\ Classic	 Ultra	Ready Mounts	Max Control\ LTV Severe Duty\ ProGuard\ Guardian	Strut Cushion\ Strut Mount\ Dampers\ Stabilizer	HiJackers\ Load Carrier\ Classic



PONTIAC

PONTIAC



GRAND PRIX (cont)

97-03	Left Models w/ 16" Wheels	 G55948	G57060 ⁴⁰	142524 ⁶⁷ 142526 ⁵⁴		G56924 ⁴⁰
	Right	 G55948	G57060 ⁴⁰	142524 ⁶⁷ 142526 ⁵⁴		143074 ⁵³
	Right Models w/ 16" Wheels	 G55948	G57060 ⁴⁰	142524 ⁶⁷ 142526 ⁵⁴		G56925 ⁴⁰
90-96	Exc. Heavy Duty Suspension	 G44459 ³⁶	142144 ⁵³		M56708
88-96	All	 G44459 ³⁶		M56708
69-87	All	 69600	81494	34051 ⁸	 69604	81492	43060 ⁸ 49334 ³⁰
65-68	All		82110	 69724	81514	49128 ³⁰
63-64	All		82099	 69724	81514	49128 ³⁰
62	All		82099	











GRAND SAFARI

71-78	All	 69675 ⁵	81446	34073 ⁸	 69604	81492	43060 ⁸ 49152 ³⁰
-------	-----	------------------------------------------------------------------------------------------------------	------	-------	------	--------------------	-----------------------------------------------------------------------------------------	------	-------	------	-------------------------------------------





GRANDVILLE

71-75	All	 69600	81494	34051 ⁸	 69604	81492	43060 ⁸ 49152 ³⁰
-------	-----	-------------------------------------------------------------------------------------------	------	-------	------	--------------------	-------------------------------------------------------------------------------------------	------	-------	------	-------------------------------------------











GTO

04-06	All		143459 ⁶⁸	
68-73	All	 69600	81494	 69604	81492	43060 ⁸ 49152 ³⁰
64-67	All		82138	
	Exc. Heavy Duty Suspension		82138	 69724	81514	43049 ⁸ 49131 ³⁰
	Heavy Duty Suspension		82138	 69604	81492	43060 ⁸ 49152 ³⁰



LAURENTIAN

76-81	All	 69675 ⁵	81446	34073 ⁸	 69724	43049 ⁸ 49131 ³⁰
	CAN	 69675 ⁵	81446	34073 ⁸	 69724	81514	43049 ⁸ 49131 ³⁰

LEMANS

88-93	All	 G44903 ⁹⁸	143057 ⁵¹	
68-81	All	 69600	81494	34051 ⁸	 69604	81492	43060 ⁸ 49334 ³⁰
64-67	All		82138	
	Exc. Heavy Duty Suspension		82138	 69724	81514	43049 ⁸ 49131 ³⁰
	Heavy Duty Suspension		82138	 69604	81492	43060 ⁸ 49152 ³⁰

MONTANA

07-09	CAN		142526 ⁵⁴	 G63776
-------	-----	------------------------------------------------------------------------------------------	------	------	----------------------	------	--------------------------------------------------------------------------------------------	------	------	------	------

5 Use kit No. 140719 to replace O.E. hardware for lower shock absorber mounting when studs break or self-tapping screws are not longer useable.

30 For GM Vehicles equipped with factory installed leveling systems, see Ref A.

40 Complete Assembled Unit.

53 Hardware from O.E. Part may need to be reused.

67 Mount Kit. Hardware from O.E. Part may need to be reused.

98 Notice: The level of difficulty to install this product is moderately high. Please

8 Pair Packs.



36 Requires special strut installation tool.

51 Strut Cushion for use with the Strut/Cartridge/Shocks.

54 Kit with Mount and Bearing. Hardware from O.E. Part may need to be reused.

68 Mount Kit. Hardware from O.E. Part may need to be reused.;

APPLICATION GUIDE

Year	Fitment Notes										
		Ultra	Ready Mounts	Max Control\ LTV Severe Duty\ ProGuard\ Guardian	Strut Cushion\ Strut Mount\ Dampers\ Stabilizer	HiJackers\ Load Carrier\ Classic	Ultra	Ready Mounts	Max Control\ LTV Severe Duty\ ProGuard\ Guardian	Strut Cushion\ Strut Mount\ Dampers\ Stabilizer	HiJackers\ Load Carrier\ Classic

PONTIAC

PONTIAC

MONTANA (cont)

06-09	All	↓	142526 ⁵⁴	
	SV6, Exc. Self-Leveling Suspension	↓	G52025	142526 ⁵⁴	
	SV6, FWD	↓	G57142 ⁴⁰	142526 ⁵⁴	
06	FWD, Exc. Air-Leveling Suspension	↓	142526 ⁵⁴	○	G63776
04-05	All	↓	142524 ⁵⁷ 142526 ⁵⁴	
	Exc. Air-Leveling Suspension	↓	142524 ⁵⁷ 142526 ⁵⁴	○	G63776	61659 81924
	Base	↓	G55948	G57060 ⁴⁰	142524 ⁵⁷ 142526 ⁵⁴	
	FWD, Exc. Air-Leveling Suspension & Independent Rear Suspension	↓	142524 ⁵⁷ 142526 ⁵⁴	○	49230 ⁷
05	SV6, Exc. Self-Leveling Suspension	↓	G52025	142524 ⁵⁷ 142526 ⁵⁴	
	SV6, FWD	↓	G57142 ⁴⁰	142524 ⁵⁷ 142526 ⁵⁴	
02-03	All	↓	142526 ⁵⁴	
	Exc. Air-Leveling Suspension	↓	142526 ⁵⁴	○	G63776	61659 81924
	Base	↓	G55948	G57060 ⁴⁰	142526 ⁵⁴	
	FWD, Exc. Air-Leveling Suspension & Independent Rear Suspension	↓	142526 ⁵⁴	○	49230 ⁷
	Mini Passenger Van	↓	142524 ⁵⁷ 142526 ⁵⁴	
99-01	All	↓	142524 ⁵⁷ 142526 ⁵⁴	
	Exc. Air-Leveling Suspension	↓	142524 ⁵⁷ 142526 ⁵⁴	○	G63776	61659 81924
	Base	↓	G55948	G57060 ⁴⁰	142524 ⁵⁷ 142526 ⁵⁴	
	FWD, Exc. Air-Leveling Suspension & Independent Rear Suspension	↓	142524 ⁵⁷ 142526 ⁵⁴	○	49230 ⁷

PARISIENNE

76-86	All	↓	69675 ⁵	81446	34073 ⁸	
	Sedan	↓	69675 ⁵	81446	34073 ⁸	○	69724	81514	43049 ⁸ 49131 ³⁰
	Wagon	↓	69675 ⁵	81446	34073 ⁸	○	69604	81492	43060 ⁸ 49152 ³⁰

PHOENIX

77-79	All	↓	69600	81494	34051 ⁸	○	82093
-------	-----	---	-------	------	-------	------	--------------------	---	------	------	------	-------

PURSUIT

05-06	Left	↓	G56810	G57047 ⁴⁰	143323 ⁵³	○	69587
-------	------	---	--------	----------------------	------	----------------------	------	---	-------	------	------	------

5 Use kit No. 140719 to replace O.E. hardware for lower shock absorber mounting when studs break or self-tapping screws are not longer useable.

8 Pair Packs.

40 Complete Assembled Unit.

54 Kit with Mount and Bearing. Hardware from O.E. Part may need to be reused.





7 Pair Packs, Air hose kit included.

30 For GM Vehicles equipped with factory installed leveling systems, see Ref A.

53 Hardware from O.E. Part may need to be reused.



67 Mount Kit. Hardware from O.E. Part may need to be reused.

APPLICATION GUIDE

Year	Fitment Notes										
		 Ultra	Ready Mounts	Max Control\ LTV Severe Duty\ ProGuard\ Guardian	Strut Cushion\ Strut Mount\ Dampers\ Stabilizer	HiJackers\ Load Carrier\ Classic	 Ultra	Ready Mounts	Max Control\ LTV Severe Duty\ ProGuard\ Guardian	Strut Cushion\ Strut Mount\ Dampers\ Stabilizer	HiJackers\ Load Carrier\ Classic



PONTIAC

PURSUIT (cont)



05-06	Right	 G56810	G57048 ⁴⁰	143323 ⁵³	 69587
-------	-------	------------------------------------------------------------------------------------------	----------------------	------	----------------------	------	-----------------------------------------------------------------------------------------	------	------	------	------

PONTIAC











SAFARI

87-89	All	 69675 ⁵	81446	34073 ⁸	 69604	81492	43060 ⁸ 49152 ³⁰
-------	-----	------------------------------------------------------------------------------------------------------	------	-------	------	--------------------	-----------------------------------------------------------------------------------------	------	-------	------	-------------------------------------------



SOLSTICE

06-09	All	 G51935	
-------	-----	------------------------------------------------------------------------------------------	------	------	------	------	-----------------------------------------------------------------------------------	------	------	------	------



STAR CHIEF

65-66	All		82110	 69724	81514	49128 ³⁰
63-64	All		82099	 69724	81514	49128 ³⁰
61-62	All		82099	
58-60	All		82099		81318	49310 ⁷ 82156
54-57	All		82026		49310 ⁷ 82156





STREAMLINER

49-52	All		82026		49310 ⁷ 82156
-------	-----	------------------------------------------------------------------------------------------	------	------	------	-------	------------------------------------------------------------------------------------	------	------	------	-----------------------------





SUNBURST

85-88	CAN		143058 ⁵¹	
-------	-----	-------------------------------------------------------------------------------------------	------	------	----------------------	------	-------------------------------------------------------------------------------------	------	------	------	------





SUNFIRE

99-05	All	 G55698	G56951 ⁴⁰	143057 ⁵¹	 G55825	G56938 ⁴⁰
95-98	All	 G55698	G56939 ⁴⁰	142227 ⁶⁷ 143057 ⁵¹	 G55825	G56938 ⁴⁰



SUNRUNNER

94-97	All		 G63799	61560 81904
	CAN Non-ABS	 G56518	 G63799	61560 81904









SUPER CHIEF

58	All		82099		81318	49310 ⁷ 82156
57	All		82026		49310 ⁷ 82156

T1000

81-87	All			81340	43140 ⁸
-------	-----	-------------------------------------------------------------------------------------------	------	------	------	------	-------------------------------------------------------------------------------------	------	-------	------	--------------------

TEMPEST

68-70	All	 69600	81494	 69604	81492	43060 ⁸ 49152 ³⁰
64-67	All		82138	
	Exc. Heavy Duty Suspension		82138	 69724	81514	43049 ⁸ 49131 ³⁰
	Heavy Duty Suspension		82138	 69604	81492	43060 ⁸ 49152 ³⁰

5 Use kit No. 140719 to replace O.E. hardware for lower shock absorber mounting when studs break or self-tapping screws are not longer useable.

8 Pair Packs.

40 Complete Assembled Unit.



7 Pair Packs, Air hose kit included.

30 For GM Vehicles equipped with factory installed leveling systems, see Ref A.

51 Strut Cushion for use with the Strut/Cartridge/Shocks.

67 Mount Kit. Hardware from O.E. Part may need to be reused.

APPLICATION GUIDE

Year	Fitment Notes										
		Ultra	Ready Mounts	Max Control\ LTV Severe Duty\ ProGuard\ Guardian	Strut Cushion\ Strut Mount\ Dampers\ Stabilizer	HiJackers\ Load Carrier\ Classic	Ultra	Ready Mounts	Max Control\ LTV Severe Duty\ ProGuard\ Guardian	Strut Cushion\ Strut Mount\ Dampers\ Stabilizer	HiJackers\ Load Carrier\ Classic

PONTIAC

PONTIAC

TORRENT

07-09	All	○	G64015	61718
	Left Exc. Models w/ 19" Wheels	↓	G57197 ⁴⁰	○	G64015	61718
	Left Exc. Sport Suspension	↓	G52127	○	G64015	61718
	Left Models w/ 19" Wheels	↓	G57322 ⁴⁰	○	G64015	61718
	Right Exc. Models w/ 19" Wheels	↓	G57198 ⁴⁰	○	G64015	61718
	Right Exc. Sport Suspension	↓	G52128	○	G64015	61718
	Right Models w/ 19" Wheels	↓	G57323 ⁴⁰	○	G64015	61718
06	Left	↓	G56773	G57535 ⁴⁰	143363 ⁵³	○	G64015	61718
	Right	↓	G56774	G57536 ⁴⁰	143363 ⁵³	○	G64015	61718

TRANS SPORT

99	All	↓	G55948	G57060 ⁴⁰	142524 ⁶⁷ 142526 ⁶⁴	○	G63776
97-98	All	↓	G55948	G57060 ⁴⁰	142524 ⁶⁷ 142526 ⁶⁴	○	G63776	61659 81924	49230 ⁷

VENTURA

73-77	All	⊖	69600	81494	34051 ⁸	⊖	82093
73	Heavy Duty Suspension	⊖	69600	81494	34051 ⁸	⊖	69724	81514	49157 ⁷ 82093
71-72	All	⊖	69600	81494	⊖	43049 ⁸
	Leaf(RearSpringType)	⊖	69600	81494	⊖	69724	81514	43049 ⁸
	Multi-Leaf Rear Spring	⊖	69600	81494	⊖	49157 ⁷ 43049 ⁸
	Single Leaf Rear Springs	⊖	69600	81494	⊖	82093 43049 ⁸
61	All	⊖	82099	⊖
60	All	⊖	82099	⊖	81318	49310 ⁷ 82156

VIBE

09-10	Left	↓	G52245	↓
	Right	↓	G52246	↓
	AWD, Left	↓	G57329 ⁴⁰	↓
	AWD, Right	↓	G57330 ⁴⁰	↓
	FWD, Left	↓	G57566 ⁴⁰	↓	G51898
	FWD, Right	↓	G57567 ⁴⁰	↓	G51898
03-08	All	↓	143093 ⁵³	↓	143094 ⁵³
	FWD, Left	↓	G52013	G57357 ⁴⁰	143093 ⁵³	↓	G51736	G57067 ⁴⁰	143094 ⁵³

7 Pair Packs, Air hose kit included.

40 Complete Assembled Unit.



54 Kit with Mount and Bearing. Hardware from O.E. Part may need to be reused.

8 Pair Packs.

53 Hardware from O.E. Part may need to be reused.









67 Mount Kit. Hardware from O.E. Part may need to be reused.

APPLICATION GUIDE

Year	Fitment Notes										
		Ultra	Ready Mounts	Max Control\ LTV Severe Duty\ ProGuard\ Guardian	Strut Cushion\ Strut Mount\ Dampers\ Stabilizer	HiJackers\ Load Carrier\ Classic	Ultra	Ready Mounts	Max Control\ LTV Severe Duty\ ProGuard\ Guardian	Strut Cushion\ Strut Mount\ Dampers\ Stabilizer	HiJackers\ Load Carrier\ Classic





PONTIAC

VIBE (cont)

03-08	FWD, Right		G52014	G57358 ⁴⁰	143093 ⁵³		G51736	G57068 ⁴⁰	143094 ⁵³
08	Left		G52013	143093 ⁵³		143094 ⁵³
03-06	AWD, Left		G57183 ⁴⁰	143093 ⁵³		G51768	143094 ⁵³
	AWD, Right		G57182 ⁴⁰	143093 ⁵³		G51768	143094 ⁵³





PONTIAC

WAVE

05-08	Left		G56886	G57130 ⁴⁰	143239 ⁵³	
	Right		G56887	G57131 ⁴⁰	143239 ⁵³	



PORSCHE

924

87-88	All		143058 ⁵¹	
77-82	All		143058 ⁵¹	













PORSCHE

944

83-88	All		143058 ⁵¹	
-------	-----	-------------------------------------------------------------------------------------	------	------	------	----------------------	------	-------------------------------------------------------------------------------------	------	------	------	------	------











RAM

1500 CLASSIC









21-22	Old Body Style			58412
19-20	All			77412
	Old Body Style			58412 77412
	4WD			G64044	77412
	4WD, Old Body Style		G51856	G57147 ⁴⁰		77412
	RWD, Old Body Style		G64043		77412

RAM

1500 (SEE DODGE RAM 1500)

16-18	4WD, Exc. Air Suspension		G51856	G57147 ⁴⁰		G64044	58412 77412
	RWD, Exc. Air Suspension		G64043		G64044	58412 77412
11-18	All			G64044	58412 77412
11-15	4WD		G51856	G57147 ⁴⁰		G64044	58412 77412
	RWD		G64043		G64044	58412 77412



2500 (SEE DODGE RAM 2500)

15-18	Power Wagon		77948	
	Power Wagon, 4WD		G64009	
14-15	RWD		77949	
	RWD, Standard Cab Pickup		G64043	

40 Complete Assembled Unit.

51 Strut Cushion for use with the Strut/Cartridge/Shocks.





APPLICATION GUIDE

Year	Fitment Notes										
		Ultra	Ready Mounts	Max Control\ LTV Severe Duty\ ProGuard\ Guardian	Strut Cushion\ Strut Mount\ Dampers\ Stabilizer	HiJackers\ Load Carrier\ Classic	Ultra	Ready Mounts	Max Control\ LTV Severe Duty\ ProGuard\ Guardian	Strut Cushion\ Strut Mount\ Dampers\ Stabilizer	HiJackers\ Load Carrier\ Classic









RAM

RAM



2500 (SEE DODGE RAM 2500) (cont)

14	4WD		G64009	77948
11-13	All		77950
	4WD		G64009	77948	G64013	61716 77950
	RWD, Standard Cab Pickup		G64043	77949	77950



3500 (SEE DODGE RAM 3500)

16-20	4WD		G63673	G64121	77976	43181 ⁸
14-15	4WD		G63673	77948	G64121	77976	43181 ⁸
	RWD		77949
	RWD, Standard Cab Pickup		G64043
11-13	All		77950
	4WD		G63673	77948	77950
	RWD		77949	77950
	RWD, Standard Cab Pickup		G64043	77950



C/V

12-15	All		G57206 ⁴⁰
	Exc. Load Leveling		G57206 ⁴⁰	G64042



DAKOTA

11	4WD		G63891
	RWD		G63890



PROMASTER 1500

14-22	Left		G57800 ⁴⁰
	Right		G57801 ⁴⁰

PROMASTER 2500

14-22	Left		G57800 ⁴⁰
	Right		G57801 ⁴⁰





PROMASTER 3500

14-22	Left		G57800 ⁴⁰
	Right		G57801 ⁴⁰



SAAB

SAAB

9-3

03-11	Left		G52175
	Right		G52176
	FWD		70039
99-02	Exc. Viggen		70020

APPLICATION GUIDE

Year	Fitment Notes										
		Ultra	Ready Mounts	Max Control\ LTV Severe Duty\ ProGuard\ Guardian	Strut Cushion\ Strut Mount\ Dampers\ Stabilizer	HiJackers\ Load Carrier\ Classic	Ultra	Ready Mounts	Max Control\ LTV Severe Duty\ ProGuard\ Guardian	Strut Cushion\ Strut Mount\ Dampers\ Stabilizer	HiJackers\ Load Carrier\ Classic

SAAB

SAAB

9-7X

05-09	All		G51718 ⁴⁵	G57022 ⁴⁰	143241 ⁵³		G63842	61717
-------	-----	--	----------------------	----------------------	------	----------------------	------	--	--------	------	-------	------	------

93

56-57	All		81676
-------	-----	--	------	------	------	------	------	--	------	------	-------	------	------

93B

58-59	All		81676
-------	-----	--	------	------	------	------	------	--	------	------	-------	------	------

99

69-78	All		81270	49105 ⁷
-------	-----	--	------	------	------	------	------	--	------	------	-------	------	--------------------

900

94-98	All		143057 ⁵¹ 143207 ⁵³
	Turbocharged(Eng Asp)		G44461 ⁹⁸	143057 ⁵¹ 143207 ⁵³
86-93	All		143057 ⁵¹
93	Turbocharged(Eng Asp) Mfg. from 6/30/93		G44461 ⁹⁸	143057 ⁵¹

9000

88-98	All		143061 ⁵¹
86-87	All		143058 ⁵¹

GT750

58-59	All		81676
-------	-----	--	------	------	------	------	------	--	------	------	-------	------	------

GT850

63	All		81676
----	-----	--	------	------	------	------	------	--	------	------	-------	------	------

SATURN

SATURN

ASTRA

08-09	All			69587
-------	-----	--	------	------	------	------	------	--	-------	------	------	------	------

AURA

08-09	XE, Left		G57121 ⁴⁰
07-09	Left		143354 ⁵³
	Right		143355 ⁵³
	4Cyl: Exc. Hybrid Models Right		G57122 ⁴⁰
	Exc. Hybrid Models			69590
	Maxx Models		143425 ⁶⁸
09	4Cyl: Exc. Classic and Hybrid Models Left		G57121 ⁴⁰
07-08	4Cyl: Exc. Hybrid Models Left		G57121 ⁴⁰

7 Pair Packs, Air hose kit included.

45 Strut must be rotated to align notch with lower control arm.

53 Hardware from O.E. Part may need to be reused.



98 Notice: The level of difficulty to install this product is moderately high. Please

40 Complete Assembled Unit.

51 Strut Cushion for use with the Strut/Cartridge/Shocks.

68 Mount Kit. Hardware from O.E. Part may need to be reused.;



APPLICATION GUIDE

Year	Fitment Notes										
		Ultra	Ready Mounts	Max Control\ LTV Severe Duty\ ProGuard\ Guardian	Strut Cushion\ Strut Mount\ Dampers\ Stabilizer	HiJackers\ Load Carrier\ Classic	Ultra	Ready Mounts	Max Control\ LTV Severe Duty\ ProGuard\ Guardian	Strut Cushion\ Strut Mount\ Dampers\ Stabilizer	HiJackers\ Load Carrier\ Classic









SATURN

SATURN



AURA (cont)

07-08	Exc. Hybrid Models & 4Cyl Left		G57069 ⁴⁰
	Exc. Hybrid Models & 4Cyl Right		G57070 ⁴⁰







ION

04-07	Left		G56809	G57099 ⁴⁰	143089 ⁵³		69587
	Right		G56809	G57100 ⁴⁰	143089 ⁵³		69587
03	Left		G56809	G57099 ⁴⁰	143089 ⁵⁴		69587
	Right		G56809	G57100 ⁴⁰	143089 ⁵⁴		69587













L / LS / LW SERIES

00-05	All			G51759
-------	-----	-----------------------------------------------------------------------------------	------	------	------	------	------	-------------------------------------------------------------------------------------	--------	------	------	------	------



OUTLOOK

07-10	All		G52125	143366 ⁵³		G64040
	AWD		G52125	G57109 ⁴⁰	143366 ⁵³		G64040
	FWD		G52125	G57314 ⁴⁰	143366 ⁵³		G64040













RELAY

05-07	Air-Leveling Suspension, Exc. Independent Rear Suspension			49230 ⁷
	Exc. Auto-Leveling System		G52025	
	FWD		142526 ⁵⁴	
	FWD, Exc. Air-Leveling Suspension			G63776
07	1, 2, 3, FWD		G57142 ⁴⁰	
05-06	2, 3, FWD		G57142 ⁴⁰	

SC / SL / SW SERIES

91-02	All		G57013 ⁴⁰	142244 ⁵⁴ 143057 ⁵¹		G57014 ⁴⁰	142245 ⁵³ 143059 ⁵¹
-------	-----	-------------------------------------------------------------------------------------	------	----------------------	------	----------------------------------------------	------	---------------------------------------------------------------------------------------	------	----------------------	------	----------------------------------------------	------

VUE

08-10	All			G63872
	Left		G52127		G63872
	Left Exc. Models w/ 19" Wheels		G57197 ⁴⁰		G63872
	Left Models w/ 19" Wheels		G57322 ⁴⁰		G63872
	Right		G52128		G63872
	Right Exc. Models w/ 19" Wheels		G57198 ⁴⁰		G63872

7 Pair Packs, Air hose kit included.





51 Strut Cushion for use with the Strut/Cartridge/Shocks.

54 Kit with Mount and Bearing. Hardware from O.E. Part may need to be reused.

40 Complete Assembled Unit.















53 Hardware from O.E. Part may need to be reused.

APPLICATION GUIDE

Year	Fitment Notes										
		 Ultra	Ready Mounts	Max Control\ LTV Severe Duty\ ProGuard\ Guardian	Strut Cushion\ Strut Mount\ Dampers\ Stabilizer	HiJackers\ Load Carrier\ Classic	 Ultra	Ready Mounts	Max Control\ LTV Severe Duty\ ProGuard\ Guardian	Strut Cushion\ Strut Mount\ Dampers\ Stabilizer	HiJackers\ Load Carrier\ Classic

SATURN





VUE (cont)

08-10	Right Models w/ 19" Wheels		G57323 ⁴⁰		G63872
02-07	Left		G52026		G63872
	Right		G52027		G63872
	4Cyl Left		G57101 ⁴⁰	
	4Cyl Right		G57102 ⁴⁰	
	6Cyl Left		G57311 ⁴⁰	
	6Cyl Right		G57312 ⁴⁰	

SATURN



SCION

TC





05-10	Left		G52096	G57369 ⁴⁰	143406 ⁵³		G51852	G57428 ⁴⁰	143094 ⁵³
	Right		G52097	G57370 ⁴⁰	143406 ⁵³		G51852	G57429 ⁴⁰	143094 ⁵³

SCION



XA

04-06	All		G52098		70028
-------	-----	-------------------------------------------------------------------------------------	--------	------	------	------	------	-------------------------------------------------------------------------------------	-------	------	------	------	------

XB



08-15	Left		G52264	G57722 ⁴⁰		70053
	Right		G52265	G57723 ⁴⁰		70053
04-06	All		G52098		70028

XD

08-10	All			70055
-------	-----	-------------------------------------------------------------------------------------	------	------	------	------	------	-------------------------------------------------------------------------------------	-------	------	------	------	------



STUDEBAKER

AVANTI



63-64	All		82087		82103
-------	-----	-------------------------------------------------------------------------------------	------	------	------	------	-------	-------------------------------------------------------------------------------------	------	------	------	------	-------

STUDEBAKER



CHAMPION

57-58	All		82087		82151
-------	-----	-------------------------------------------------------------------------------------	------	------	------	------	-------	-------------------------------------------------------------------------------------	------	------	------	------	-------



COMMANDER

57-58	All		82087		82151
-------	-----	-------------------------------------------------------------------------------------	------	------	------	------	-------	-------------------------------------------------------------------------------------	------	------	------	------	-------



GOLDEN HAWK

57-58	All		82087		82151
-------	-----	-------------------------------------------------------------------------------------	------	------	------	------	-------	-------------------------------------------------------------------------------------	------	------	------	------	-------



HAWK

60-62	All		82087		82151
-------	-----	-------------------------------------------------------------------------------------	------	------	------	------	-------	-------------------------------------------------------------------------------------	------	------	------	------	-------

LARK

59-62	All		82087		82151
-------	-----	-------------------------------------------------------------------------------------	------	------	------	------	-------	-------------------------------------------------------------------------------------	------	------	------	------	-------

APPLICATION GUIDE

Year	Fitment Notes										
		Ultra	Ready Mounts	Max Control\ LTV Severe Duty\ ProGuard\ Guardian	Strut Cushion\ Strut Mount\ Dampers\ Stabilizer	HiJackers\ Load Carrier\ Classic	Ultra	Ready Mounts	Max Control\ LTV Severe Duty\ ProGuard\ Guardian	Strut Cushion\ Strut Mount\ Dampers\ Stabilizer	HiJackers\ Load Carrier\ Classic

STUDEBAKER

POWER HAWK

56	All		82026		82060
----	-----	--	------	------	------	------	-------	--	------	------	------	------	-------

PRESIDENT

57-58	All		82087		82151
55-56	All		82026		82060

SILVER HAWK

57-59	All		82087		82151
-------	-----	--	------	------	------	------	-------	--	------	------	------	------	-------

SKY HAWK

56	All		82026		82060
----	-----	--	------	------	------	------	-------	--	------	------	------	------	-------

SUBARU

B9 TRIBECA

06-07	Left		G52270
	Right		G52271

BAJA

03-06	All			G51767	143140 ⁵³
-------	-----	--	------	------	------	------	------	--	--------	------	------	----------------------	------

BRAT

80-87	All		143061 ⁵¹
-------	-----	--	------	------	------	----------------------	------	--	------	------	------	------	------

DL

85-89	All		143061 ⁵¹
-------	-----	--	------	------	------	----------------------	------	--	------	------	------	------	------

FORESTER



11-13	Left		G52374	G57704 ⁴⁰	143492 ⁵³		G51961	G57706 ⁴⁰
	Right		G52375	G57705 ⁴⁰	143492 ⁵³		G51961	G57706 ⁴⁰
09-10	Left		G52374	143492 ⁵³		G51961	G57706 ⁴⁰
	Right		G52375	143492 ⁵³		G51961	G57706 ⁴⁰
	AWD, Left		G57628 ⁴⁰
	AWD, Right		G57629 ⁴⁰
07-08	Manual Left		G57477 ⁴⁰	143492 ⁵³		G52182
	Manual Right		G57478 ⁴⁰	143492 ⁵³		G52183
06	All		143205 ⁵³
	Manual Left		G57477 ⁴⁰	143492 ⁵³		G52182	143205 ⁵³
	Manual Right		G57478 ⁴⁰	143492 ⁵³		G52183	143205 ⁵³
04-05	2.5L Left		G57459 ⁴⁰	143492 ⁵³	143205 ⁵³

40 Complete Assembled Unit.

53 Hardware from O.E. Part may need to be reused.

51 Strut Cushion for use with the Strut/Cartridge/Shocks.

APPLICATION GUIDE

Year	Fitment Notes										
		Ultra	Ready Mounts	Max Control\ LTV Severe Duty\ ProGuard\ Guardian	Strut Cushion\ Strut Mount\ Dampers\ Stabilizer	HiJackers\ Load Carrier\ Classic	Ultra	Ready Mounts	Max Control\ LTV Severe Duty\ ProGuard\ Guardian	Strut Cushion\ Strut Mount\ Dampers\ Stabilizer	HiJackers\ Load Carrier\ Classic

SUBARU

SUBARU

FORESTER (cont)

04-05	2.5L Right		G57460 ⁴⁰	143492 ⁵³	143205 ⁵³
03-05	All		143492 ⁵³	143205 ⁵³
98-02	All		142330 ⁵³ 143057 ⁵¹ 143492 ⁵³	143057 ⁵¹

GL

85-89	Hatchback		143061 ⁵¹
-------	-----------	--	------	------	------	----------------------	------	--	------	------	------	------	------

IMPREZA

12-14	All		G57703 ⁴⁰
	Exc. Sti		143492 ⁵³	G57703 ⁴⁰
	Sport, Left		G57701 ⁴⁰	G57703 ⁴⁰
	Sport, Right		G57702 ⁴⁰	G57703 ⁴⁰
08-11	Left		G57644 ⁴⁰	143492 ⁵³	G57703 ⁴⁰
	Right		G57645 ⁴⁰	143492 ⁵³	G57703 ⁴⁰
	Sport, Left		G57701 ⁴⁰
	Sport, Right		G57702 ⁴⁰
07	Left Exc. Sti		G57640 ⁴⁰	143492 ⁵³	G57642 ⁴⁰
	Right Exc. Sti		G57641 ⁴⁰	143492 ⁵³	G57643 ⁴⁰
04-06	Left Exc. Sti		G57640 ⁴⁰	143492 ⁵³	G57642 ⁴⁰	143205 ⁵³
	Right Exc. Sti		G57641 ⁴⁰	143492 ⁵³	G57643 ⁴⁰	143205 ⁵³
02-03	Left		143492 ⁵³	143465 ⁵³
	Right		143492 ⁵³	143466 ⁵³
	RS, Left		G57634 ⁴⁰
	RS, Right		G57635 ⁴⁰
93-01	All		143492 ⁵³
	Non-ABS		142330 ⁵³ 143492 ⁵³



LEGACY

10-13	All		143492 ⁵³
10-12	Exc. GT Submodel Left		G57673 ⁴⁰	143492 ⁵³	G57675 ⁴⁰
	Exc. GT Submodel Right		G57674 ⁴⁰	143492 ⁵³	G57675 ⁴⁰

40 Complete Assembled Unit.

51 Strut Cushion for use with the Strut/Cartridge/Shocks.

APPLICATION GUIDE

Year	Fitment Notes										
		Ultra	Ready Mounts	Max Control\ LTV Severe Duty\ ProGuard\ Guardian	Strut Cushion\ Strut Mount\ Dampers\ Stabilizer	HiJackers\ Load Carrier\ Classic	Ultra	Ready Mounts	Max Control\ LTV Severe Duty\ ProGuard\ Guardian	Strut Cushion\ Strut Mount\ Dampers\ Stabilizer	HiJackers\ Load Carrier\ Classic

SUBARU

SUBARU

LEGACY (cont)

05-09	Left		G52023	G57345 ⁴⁰	143492 ⁵³	G57423 ⁴⁰	143140 ⁵³
	Right		G52024	G57346 ⁴⁰	143492 ⁵³	G57423 ⁴⁰	143140 ⁵³
03-04	Left		G57515 ⁴⁰	142330 ⁵³ 143492 ⁵³	143140 ⁵³
	Right		G57516 ⁴⁰	142330 ⁵³ 143492 ⁵³	143140 ⁵³
00-02	Left		G57365 ⁴⁰	142330 ⁵³ 143492 ⁵³	G57430 ⁴⁰	143140 ⁵³
	Right		G57366 ⁴⁰	142330 ⁵³ 143492 ⁵³	G57430 ⁴⁰	143140 ⁵³
90-99	All		142330 ⁵³ 143057 ⁵¹ 143492 ⁵³	143057 ⁵¹

LOYALE

90-94	All		143061 ⁵¹	143064 ⁵¹
-------	-----	--	------	------	------	----------------------	------	--	------	------	------	----------------------	------

OUTBACK

15-16	All		G57799 ⁴⁰
13-14	Left		G57780⁴⁰	143492 ⁵³	G57799 ⁴⁰
	Right		G57781⁴⁰	143492 ⁵³	G57799 ⁴⁰
10-12	Left		G52272	143492 ⁵³
	Right		G52273	143492 ⁵³
06-09	Left		G52272	G57339 ⁴⁰	143492 ⁵³		G51910
	Right		G52273	G57340 ⁴⁰	143492 ⁵³		G51910
05	Left		G52272	G57339 ⁴⁰	143492 ⁵³		G51910	143140 ⁵³
	Right		G52273	G57340 ⁴⁰	143492 ⁵³		G51910	143140 ⁵³
00-04	Left		G57341 ⁴⁰	143492 ⁵³		G51767	143140 ⁵³
	Right		G57342 ⁴⁰	143492 ⁵³		G51767	143140 ⁵³
	AWD, Right		G56814

TRIBECA

08-14	Left		G52270
	Right		G52271

XT

85-91	FWD, Coil(RearSpringType)		143064 ⁵¹
-------	---------------------------	--	------	------	------	------	------	--	------	------	------	----------------------	------



40 Complete Assembled Unit.

53 Hardware from O.E. Part may need to be reused.

Bold Type - New / Future Part

51 Strut Cushion for use with the Strut/Cartridge/Shocks.

APPLICATION GUIDE

Year	Fitment Notes										
		Ultra	Ready Mounts	Max Control\ LTV Severe Duty\ ProGuard\ Guardian	Strut Cushion\ Strut Mount\ Dampers\ Stabilizer	HiJackers\ Load Carrier\ Classic	Ultra	Ready Mounts	Max Control\ LTV Severe Duty\ ProGuard\ Guardian	Strut Cushion\ Strut Mount\ Dampers\ Stabilizer	HiJackers\ Load Carrier\ Classic

SUZUKI

SUZUKI

AERIO

04-07	All	↓	143401 ⁶⁸	↓	143418 ⁵³
02-07	Right	↓	143401 ⁶⁸	↓	G52022	143418 ⁵³
02-03	Left	↓	G52019	143401 ⁶⁸	↓	143418 ⁵³

EQUATOR

09-12	All	↓	G51765	G57413 ⁴⁰	↓	G64031
-------	-----	---	--------	----------------------	------	------	------	---	--------	------	------	------	------

ESTEEM

95-02	All	↓	143057 ⁵¹	↓	143057 ⁵¹
-------	-----	---	------	------	------	----------------------	------	---	------	------	------	----------------------	------

FORENZA

04-08	Left	↓	G57126 ⁴⁰	143349 ⁶⁸	↓	G57128 ⁴⁰	143350 ⁵³
	Right	↓	G57127 ⁴⁰	143349 ⁶⁸	↓	G57129 ⁴⁰	143350 ⁵³

GRAND VITARA

06-13	Left	↓	G52184	↓	G64052
	Right	↓	G52185	↓	G64052
05	All	↓	↓	G63799	61560 81904
	Non-ABS	↓	G56518	↓	G63799	61560 81904
99-04	All	↓	143204 ⁵³	↓	G63799	61560 81904
	Non-ABS	↓	G56518	143204 ⁵³	↓	G63799	61560 81904

RENO

05-08	Left	↓	G57126 ⁴⁰	143349 ⁶⁸	↓	G57128 ⁴⁰	143350 ⁵³
	Right	↓	G57127 ⁴⁰	143349 ⁶⁸	↓	G57129 ⁴⁰	143350 ⁵³

SAMURAI

86-95	All	↓	81675	↓	61550 81676
	Single System Steering Stabilizer	↓	81675	6802SE ⁸⁴	↓	61550 81676

SIDEKICK

89-98	Non-ABS	↓	G56518	↓	G63799	61560 81904
-------	---------	---	--------	------	------	------	------	---	--------	------	----------------	------	------

SWIFT

07-09	Left	↓	G56886	G57130 ⁴⁰	143059 ⁵¹	↓
	Right	↓	G56887	G57131 ⁴⁰	143059 ⁵¹	↓
04-06	Left	↓	G56886	G57130 ⁴⁰	↓



40 Complete Assembled Unit.

53 Hardware from O.E. Part may need to be reused.

51 Strut Cushion for use with the Strut/Cartridge/Shocks.

68 Mount Kit. Hardware from O.E. Part may need to be reused.;



APPLICATION GUIDE

Year	Fitment Notes										
		Ultra	Ready Mounts	Max Control\ LTV Severe Duty\ ProGuard\ Guardian	Strut Cushion\ Strut Mount\ Dampers\ Stabilizer	HiJackers\ Load Carrier\ Classic	Ultra	Ready Mounts	Max Control\ LTV Severe Duty\ ProGuard\ Guardian	Strut Cushion\ Strut Mount\ Dampers\ Stabilizer	HiJackers\ Load Carrier\ Classic



SUZUKI

SUZUKI



SWIFT (cont)

04-06	Right		G56887	G57131 ⁴⁰			
89-01	All		143059 ⁵¹		G55772	143057 ⁵¹



















VITARA

99-04	Non-ABS		G56518	143204 ⁵³		G63799	61560 81904
-------	---------	-----------------------------------------------------------------------------------	--------	------	------	----------------------	------	-------------------------------------------------------------------------------------	--------	------	----------------	------	------

X-90

96-98	All			G63799	61560 81904
-------	-----	-----------------------------------------------------------------------------------	------	------	------	------	------	-------------------------------------------------------------------------------------	--------	------	----------------	------	------























XL-7

07-09	Exc. 3rd Row Seating			G64015	61718
	Left		G52127	
	Left Exc. Models w/ 19" Wheels		G57197 ⁴⁰	
	Left Models w/ 19" Wheels		G57322 ⁴⁰	
	Right		G52128	
	Right Exc. Models w/ 19" Wheels		G57198 ⁴⁰	
	Right Models w/ 19" Wheels		G57323 ⁴⁰	
02-06	All		143204 ⁵³		G64105
	Non-ABS		G56518	143204 ⁵³		G64105

TOYOTA

TOYOTA

4RUNNER

17-18	All		G51739	143383 ⁵⁸	
	RWD, Left Exc. Kinetic Suspension		G51739	G57133 ⁴⁰	143383 ⁵⁸		G63885
	RWD, Right Exc. Kinetic Suspension		G51739	G57134 ⁴⁰	143383 ⁵⁸		G63885
13-16	All		G51739	143383 ⁵⁸		G63885
	Left Exc. X-Reas Suspension; Exc. Sport Models		G51739	G57133 ⁴⁰	143383 ⁵⁸		G63885
	Right Exc. X-Reas Suspension; Exc. Sport Models		G51739	G57134 ⁴⁰	143383 ⁵⁸		G63885
03-12	All		G51739	143383 ⁵⁸	
	Left Exc. X-Reas Suspension; Exc. Sport Models		G51739	G57133 ⁴⁰	143383 ⁵⁸	
	Right Exc. X-Reas Suspension; Exc. Sport Models		G51739	G57134 ⁴⁰	143383 ⁵⁸	
	Exc. X-REAS Suspension; Exc. Sport Models		G51739	143383 ⁵⁸		G63885
96-02	Left		G57065 ⁴⁰		G63726	77726	49387 ⁷

7 Pair Packs, Air hose kit included.



51 Strut Cushion for use with the Strut/Cartridge/Shocks.

68 Mount Kit. Hardware from O.E. Part may need to be reused.;

40 Complete Assembled Unit.

53 Hardware from O.E. Part may need to be reused.

APPLICATION GUIDE

Year	Fitment Notes										
		Ultra	Ready Mounts	Max Control\ LTV Severe Duty\ ProGuard\ Guardian	Strut Cushion\ Strut Mount\ Dampers\ Stabilizer	HiJackers\ Load Carrier\ Classic	Ultra	Ready Mounts	Max Control\ LTV Severe Duty\ ProGuard\ Guardian	Strut Cushion\ Strut Mount\ Dampers\ Stabilizer	HiJackers\ Load Carrier\ Classic

TOYOTA

TOYOTA

4RUNNER (cont)

96-02	Right	↓	G57066 ⁴⁰	↓	G63726	77726	49387 ⁷
	4WD	↓	G51077	143325 ⁵³	↓
90-95	All	↓	G63547	61552 77479 81870	↓	G63548	77726	49388 ⁷
86-89	All	↓	G63479	61552 77479 81870	↓	G63494	61510 77494 81871
84-85	All	↓	G63404	↓	G63494	61510 77494 81871
	Single System Steering Stabilizer	↓	G63404	6803SE ⁸⁴	↓	G63494	61510 77494 81871

AVALON

12	Left	↓	G57539 ⁴⁰	↓
	Right	↓	G57540 ⁴⁰	↓
07-11	Left	↓	G56888	G57539 ⁴⁰	143402 ⁶⁸	↓	G57192 ⁴⁰
	Left Mfg. from 1/06	↓	143402 ⁶⁸	↓	G52103
	Right	↓	G56889	G57540 ⁴⁰	143402 ⁶⁸	↓	G57193 ⁴⁰
	Right Mfg. from 1/06	↓	143402 ⁶⁸	↓	G52104
06-11	All	↓	143402 ⁶⁸	↓
06	Left Mfg. from 1/06	↓	G56888	G57539 ⁴⁰	143402 ⁶⁸	↓	G52103	G57192 ⁴⁰
	Left Mfg. to 1/06	↓	143402 ⁶⁸	↓	G52367
	Right Mfg. from 1/06	↓	G56889	G57540 ⁴⁰	143402 ⁶⁸	↓	G52104	G57193 ⁴⁰
	Right Mfg. to 1/06	↓	143402 ⁶⁸	↓	G52368
05	Left Mfg. to 1/06	↓	↓	G52367
	Right Mfg. to 1/06	↓	↓	G52368
04	All	↓	142556 ⁶⁷	↓
	Left	↓	G52376	142650 ⁵⁴ 142556 ⁶⁷	↓
	Right	↓	G52377	142649 ⁵⁴ 142556 ⁶⁷	↓
97-03	All	↓	142556 ⁶⁷ 143057 ⁵¹	↓	143057 ⁵¹
	Left	↓	G56506	G56930 ⁴⁰	M56506	142650 ⁵⁴ 142556 ⁶⁷ 143057 ⁵¹	↓	G55675	G56932 ⁴⁰	143057 ⁵¹
	Right	↓	G56514	G56931 ⁴⁰	M56514	142649 ⁵⁴ 142556 ⁶⁷ 143057 ⁵¹	↓	G55676	G56933 ⁴⁰	143057 ⁵¹

7 Pair Packs, Air hose kit included.

51 Strut Cushion for use with the Strut/Cartridge/Shocks.

54 Kit with Mount and Bearing. Hardware from O.E. Part may need to be reused.

222 68 Mount Kit. Hardware from O.E. Part may need to be reused.;



40 Complete Assembled Unit.

53 Hardware from O.E. Part may need to be reused.

67 Mount Kit. Hardware from O.E. Part may need to be reused.





84 Replacement damper for vehicles with the Gabriel Aftermarket mounting kit

APPLICATION GUIDE

Year	Fitment Notes										
		Ultra	Ready Mounts	Max Control\ LTV Severe Duty\ ProGuard\ Guardian	Strut Cushion\ Strut Mount\ Dampers\ Stabilizer	HiJackers\ Load Carrier\ Classic	Ultra	Ready Mounts	Max Control\ LTV Severe Duty\ ProGuard\ Guardian	Strut Cushion\ Strut Mount\ Dampers\ Stabilizer	HiJackers\ Load Carrier\ Classic

TOYOTA

AVALON (cont)

95-96	Left		M56502	142556 ⁶⁷ 142836 ⁵⁴ 143057 ⁵¹		G55675	G56932 ⁴⁰	142439 ⁵³ 143057 ⁵¹
	Right		M56502	142556 ⁶⁷ 142836 ⁵⁴ 143057 ⁵¹		G55676	G56933 ⁴⁰	142439 ⁵³ 143057 ⁵¹

TOYOTA

CAMRY

14-17	SE, Left			G57499 ⁴⁰
	SE, Right			G57500 ⁴⁰
12-13	Left			G57499 ⁴⁰
	Right			G57500 ⁴⁰
07-11	Left		G56888	G57190 ⁴⁰	143402 ⁶⁸		G52103	G57192 ⁴⁰	143413 ⁶⁸
	Right		G56889	G57191 ⁴⁰	143402 ⁶⁸		G52104	G57193 ⁴⁰	143414 ⁶⁸
06	Left		G56721	143202 ⁵⁴		G56728	G57078 ⁴⁰	143413 ⁶⁸
	Right		G56722	143202 ⁵⁴		G56729	G57079 ⁴⁰	143414 ⁶⁸
	4Cyl Left		G57076 ⁴⁰	
	4Cyl Right		G57077 ⁴⁰	
05	Left		G56721	G57076 ⁴⁰	143202 ⁵⁴		G56728	G57078 ⁴⁰
	Right		G56722	G57077 ⁴⁰	143202 ⁵⁴		G56729	G57079 ⁴⁰
04	Left		G56721	143202 ⁵⁴		G56728	G57078 ⁴⁰
	Right		G56722	143202 ⁵⁴		G56729	G57079 ⁴⁰
	4Cyl Left		G57076 ⁴⁰	
	4Cyl Right		G57077 ⁴⁰	
02-03	Left		G57041 ⁴⁰	143202 ⁵⁴		G57043 ⁴⁰
	Right		G57042 ⁴⁰	143202 ⁵⁴		G57044 ⁴⁰
97-01	All		142556 ⁶⁷ 143057 ⁵¹		143057 ⁵¹
	Left		G56506	G56930 ⁴⁰	M56506	142650 ⁵⁴ 142556 ⁶⁷ 143057 ⁵¹		G55675	G56932 ⁴⁰	143057 ⁵¹
	Right		G56514	G56931 ⁴⁰	M56514	142649 ⁵⁴ 142556 ⁶⁷ 143057 ⁵¹		G55676	G56933 ⁴⁰	143057 ⁵¹
95-96	Left		M56502	142556 ⁶⁷ 142836 ⁵⁴ 143057 ⁵¹		G55675	G56932 ⁴⁰	142439 ⁵³ 143057 ⁵¹
	Right		M56502	142556 ⁶⁷ 142836 ⁵⁴ 143057 ⁵¹		G55676	G56933 ⁴⁰	142439 ⁵³ 143057 ⁵¹
92-94	All		142561 ⁵⁴ 143057 ⁵¹		142439 ⁵³ 143057 ⁵¹

40 Complete Assembled Unit.

53 Hardware from O.E. Part may need to be reused.





67 Mount Kit. Hardware from O.E. Part may need to be reused.

51 Strut Cushion for use with the Strut/Cartridge/Shocks.

54 Kit with Mount and Bearing. Hardware from O.E. Part may need to be reused.

68 Mount Kit. Hardware from O.E. Part may need to be reused.;













APPLICATION GUIDE

Year	Fitment Notes										
		 Ultra	Ready Mounts	Max Control\ LTV Severe Duty\ ProGuard\ Guardian	Strut Cushion\ Strut Mount\ Dampers\ Stabilizer	HiJackers\ Load Carrier\ Classic	 Ultra	Ready Mounts	Max Control\ LTV Severe Duty\ ProGuard\ Guardian	Strut Cushion\ Strut Mount\ Dampers\ Stabilizer	HiJackers\ Load Carrier\ Classic



TOYOTA

TOYOTA























CAMRY (cont)

92-94	Left Sealed OE Struts		142561 ⁵⁴ 143057 ⁵¹		G55675	G56932 ⁴⁰	142439 ⁵³ 143057 ⁵¹
	Right Sealed OE Struts		142561 ⁵⁴ 143057 ⁵¹		G55676	G56933 ⁴⁰	142439 ⁵³ 143057 ⁵¹
	FWD, Rebuildable OE Struts		G44999 ⁹⁸	142561 ⁵⁴ 143057 ⁵¹		142439 ⁵³ 143057 ⁵¹
87-91	All		143057 ⁵¹		143057 ⁵¹
	FWD		143057 ⁵¹		142250 ⁵³ 143057 ⁵¹
83-86	All		142134 ⁵³ 143058 ⁵¹	















CARINA

72-73	All		143059 ⁵¹	
-------	-----	-----------------------------------------------------------------------------------	------	------	------	----------------------	------	-----------------------------------------------------------------------------------	------	------	------	------	------

CELICA

00-05	All		143201 ⁵³		143094 ⁵³
94-99	Left		G56573	142556 ⁶⁷	
	Right		G56576	142556 ⁶⁷	
92-93	All			143057 ⁵¹
	GT, GTS, ST		143059 ⁵¹		143057 ⁵¹
90-91	AWD		143059 ⁵¹		143059 ⁵¹
88-89	All		143059 ⁵¹	
	GT, GTS, ST		143059 ⁵¹		142249 ⁵³
86-87	All		143059 ⁵¹		142249 ⁵³
78-85	All		143057 ⁵¹		81416
75-77	All		143057 ⁵¹	

COROLLA

14-17	Left		G57543 ⁴⁰		G51898
	Right		G57544 ⁴⁰		G51898
13	Left		G52245		G51898
	Right		G52246		G51898
09-12	Left		G52245	G57329 ⁴⁰		G51898
	Right		G52246	G57330 ⁴⁰		G51898
09-10	XRS, Left			G57451 ⁴⁰

40 Complete Assembled Unit.

53 Hardware from O.E. Part may need to be reused.



67 Mount Kit. Hardware from O.E. Part may need to be reused.

51 Strut Cushion for use with the Strut/Cartridge/Shocks.

54 Kit with Mount and Bearing. Hardware from O.E. Part may need to be reused.

98 Notice: The level of difficulty to install this product is moderately high. Please review the installation instructions carefully before proceeding

APPLICATION GUIDE

Year	Fitment Notes										
		Ultra	Ready Mounts	Max Control\ LTV Severe Duty\ ProGuard\ Guardian	Strut Cushion\ Strut Mount\ Dampers\ Stabilizer	HiJackers\ Load Carrier\ Classic	Ultra	Ready Mounts	Max Control\ LTV Severe Duty\ ProGuard\ Guardian	Strut Cushion\ Strut Mount\ Dampers\ Stabilizer	HiJackers\ Load Carrier\ Classic

TOYOTA

COROLLA (cont)

TOYOTA

09-10	XRS, Left AWD	G57572 ⁴⁰	
	XRS, Right	G57452 ⁴⁰	
	XRS, Right AWD	G57573 ⁴⁰	
03-08	Left	G56661	G57114 ⁴⁰	143201 ⁵³	G51736	G57067 ⁴⁰	143094 ⁵³
	Right	G56660	G57115 ⁴⁰	143201 ⁵³	G51736	G57068 ⁴⁰	143094 ⁵³
98-02	Left	G55999	G56948 ⁴⁰	143057 ⁵¹ 143059 ⁵¹ 143281 ⁵³	G55661	G56949 ⁴⁰
	Right	G55999	G56948 ⁴⁰	143057 ⁵¹ 143059 ⁵¹ 143281 ⁵³	G55662	G56950 ⁴⁰
93-97	Left	G55999	143057 ⁵¹ 143059 ⁵¹ 143281 ⁵³	G55661	G56949 ⁴⁰
	Right	G55999	143057 ⁵¹ 143059 ⁵¹ 143281 ⁵³	G55662	G56950 ⁴⁰
	Exc. LE Model	143280 ⁵³
89-92	All	143059 ⁵¹ 143281 ⁵³
	FWD	G55591	143059 ⁵¹ 143281 ⁵³	143058 ⁵¹
88	All	143281 ⁵³
	DLX, GTS, LE, SR5	143059 ⁵¹ 143281 ⁵³
	FWD	G55591	143281 ⁵³	143058 ⁵¹
	FX Models only	142134 ⁵³ 143281 ⁵³
	FX, FX16	143057 ⁵¹ 143281 ⁵³
87	All	142134 ⁵³ 143057 ⁵¹	142249 ⁵³
	FWD	142134 ⁵³ 143057 ⁵¹	143058 ⁵¹ 142249 ⁵³
84-86	All	143057 ⁵¹	142249 ⁵³
	FWD	143057 ⁵¹	143058 ⁵¹ 142249 ⁵³
82-83	All	143057 ⁵¹
	Wagon	143057 ⁵¹	81416
80-81	All	143057 ⁵¹	43140 ⁸
	Wagon	143057 ⁵¹	81416	43140 ⁸
76-79	Coupe	81340	43140 ⁸
75-79	Wagon	143057 ⁵¹	81416	43140 ⁸
72-79	All	43140 ⁸



8 Pair Packs.

51 Strut Cushion for use with the Strut/Cartridge/Shocks.

40 Complete Assembled Unit.

53 Hardware from O.E. Part may need to be reused.

APPLICATION GUIDE

Year	Fitment Notes										
		Ultra	Ready Mounts	Max Control\ LTV Severe Duty\ ProGuard\ Guardian	Strut Cushion\ Strut Mount\ Dampers\ Stabilizer	HiJackers\ Load Carrier\ Classic	Ultra	Ready Mounts	Max Control\ LTV Severe Duty\ ProGuard\ Guardian	Strut Cushion\ Strut Mount\ Dampers\ Stabilizer	HiJackers\ Load Carrier\ Classic

TOYOTA

TOYOTA

COROLLA (cont)

72-79	Sedan		81340	43140 ⁸
75-78	Hardtop		81340	43140 ⁸
72-74	Coupe		81340	43140 ⁸
74	Mfg. from 8/74	⌋	143057 ⁵¹	43140 ⁸
	Mfg. from 8/74; Wagon		81416	43140 ⁸



CORONA

79-82	All	⌋	143059 ⁵¹
	Exc. Wagon	⌋	143059 ⁵¹	81416
79-81	Wagon	⌋	143059 ⁵¹	81340
78	All	⊖	69600	81494
	Wagon	⊖	69600	81494	49310 ⁷ 82156
74-77	Wagon	⊖	81494	49310 ⁷ 82156
73-77	Mfg. from 8/73	⊖	69600	81494
67-77	All	⊖	81494
74-76	Exc. Wagon	⊖	81494	81340	82155
72-73	Exc. Wagon	⊖	81494	81340	43140 ⁸ 82155
73	Wagon	⊖	81494	49310 ⁷
	Wagon Mfg. from 8/73	⊖	81494	82156
69-72	Mark II	⊖	69600	81494
68-71	Exc. Wagon	⊖	81494	43140 ⁸ 82155
71	Mark II, Wagon	⊖	81494	49310 ⁷
	Mark II, Wagon Exc. Wagon	⊖	81494	82156
69-70	Mark II, Wagon	⊖	81494	49310 ⁷ 82156

CRESSIDA









78-92	All	⌋	143059 ⁵¹
85-88	Sedan Exc. Electronic Adjustable Suspension	⌋	143059 ⁵¹	81440
81-87	Wagon	⌋	143059 ⁵¹	81416
83-84	Sedan	⌋	143059 ⁵¹	81440
81-82	Sedan Exc. Electronic Adjustable Suspension	⌋	143059 ⁵¹	81440
79-80	Wagon	⌋	143059 ⁵¹	81340	43140 ⁸
78-80	Sedan	⌋	143059 ⁵¹	81440
78	Wagon	⌋	143059 ⁵¹	81340

APPLICATION GUIDE

Year	Fitment Notes										
		Ultra	Ready Mounts	Max Control\ LTV Severe Duty\ ProGuard\ Guardian	Strut Cushion\ Strut Mount\ Dampers\ Stabilizer	HiJackers\ Load Carrier\ Classic	Ultra	Ready Mounts	Max Control\ LTV Severe Duty\ ProGuard\ Guardian	Strut Cushion\ Strut Mount\ Dampers\ Stabilizer	HiJackers\ Load Carrier\ Classic





TOYOTA

CROWN















67	Mfg. to 9/67		82099	
65-66	All		82099	
	Wagon		82099		49310 ⁷
	Wagon Wagon		82099		82156

TOYOTA





























ECHO

00-05	All		G56572	G57397 ⁴⁰		69450
	Only fits OE P/N's 48609-52011 & 48609-52050		G56572	G57397 ⁴⁰	143194 ⁵³		69450

FJ CRUISER

13-14	Left		G51739	G57133 ⁴⁰	
	Right		G51739	G57134 ⁴⁰	
11-14	4WD			G64030
07-14	RWD			G64029
07-12	Left		G51739	G57133 ⁴⁰	143383 ⁵⁸	
	Right		G51739	G57134 ⁴⁰	143383 ⁵⁸	
07-09	4WD			G64030

HIGHLANDER

14-18	Left		G57782⁴⁰		G64186
	Right		G57783⁴⁰		G64186
11-13	AWD, Left		143402 ⁵⁸		G57658 ⁴⁰
	AWD, Right		143402 ⁵⁸		G57659 ⁴⁰
	FWD, Left		G57720⁴⁰		G52203	G57790⁴⁰
	FWD, Right		G57721⁴⁰		G52204	G57791⁴⁰
08-10	Left		G52201	143402 ⁵⁸	
	Right		G52202	143402 ⁵⁸	
	AWD, Left w/o 3rd Row Seat			G57658 ⁴⁰
	AWD, Right w/o 3rd Row Seat			G57659 ⁴⁰
	AWD; Exc. 3.5L Left		G57481 ⁴⁰	
	AWD; Exc. 3.5L Right		G57482 ⁴⁰	
	FWD, Left			G52203	G57483 ⁴⁰
	FWD, Right			G52204	G57484 ⁴⁰

7 Pair Packs, Air hose kit included.



53 Hardware from O.E. Part may need to be reused.

Bold Type - New / Future Part

40 Complete Assembled Unit.

68 Mount Kit. Hardware from O.E. Part may need to be reused;

APPLICATION GUIDE

Year	Fitment Notes										
		Ultra	Ready Mounts	Max Control\ LTV Severe Duty\ ProGuard\ Guardian	Strut Cushion\ Strut Mount\ Dampers\ Stabilizer	HiJackers\ Load Carrier\ Classic	Ultra	Ready Mounts	Max Control\ LTV Severe Duty\ ProGuard\ Guardian	Strut Cushion\ Strut Mount\ Dampers\ Stabilizer	HiJackers\ Load Carrier\ Classic

TOYOTA

TOYOTA

HIGHLANDER (cont)

04-07	Left	↑	G56730	143202 ⁵⁴	↑	143387 ⁶⁸
	Right	↑	G56731	143202 ⁵⁴	↑	143388 ⁶⁸
	AWD, Left	↑	↑	G56732	G57152 ⁴⁰
	AWD, Right	↑	↑	G56733	G57153 ⁴⁰
	FWD, Left	↑	↑	G56734	G57533 ⁴⁰
	FWD, Right	↑	↑	G56735	G57534 ⁴⁰
01-03	Left	↑	G56679	143202 ⁵⁴	↑
	Right	↑	G56680	143202 ⁵⁴	↑
	AWD, Left	↑	G57648 ⁴⁰	↑	G57650 ⁴⁰
	AWD, Right	↑	G57649 ⁴⁰	↑	G57651 ⁴⁰

LAND CRUISER

98-07	All	↑	G63832	↑	G63828	
93-97	All	↑	G63615	↑	G63616	
91-92	All	↑	G63615	↑	
	FJ80(MfrBodyCode)	↑	G63615	↑	G63616	
88-90	All	↑	G63432	↑	G63510	
84-87	All	↑	↑	49311 ⁷	
81-87	Sport Utility, FJ60(MfrBodyCode)	↑	G63432	↑	G63492	61506 81318	49311 ⁷	
80-83	All	↑	↑	G63492	61506 81318	49311 ⁷	
	FJ40(MfrBodyCode)	↑	G63299	82007	↑	G63492	61506 81318	49311 ⁷	
76-79	FJ40(MfrBodyCode)	↑	G63299	82007	↑	G63492	61506 81318	43140 ⁶ 49311 ⁷	
	Sport Utility, FJ55(MfrBodyCode)	↑	81340	↑	G63492	61506 81318	43140 ⁶ 49311 ⁷	
79	All	↑	↑	G63492	81318	43140 ⁶ 49311 ⁷	
76-78	All	↑	↑	G63492	61506 81318	43140 ⁶ 49311 ⁷	
75	All	↑	↑	81318	43140 ⁶	
	Mfg. from 1/75	↑	↑	G63492	81318	49311 ⁷ 43140 ⁶	
	FJ40(MfrBodyCode) Mfg. from 1/75	↑	↑	61506 81318	43140 ⁶	
	FJ40(MfrBodyCode) Mfg. to 2/75	↑	G63299	82007	↑	81318	43140 ⁶	
	Sport Utility, FJ55(MfrBodyCode)	↑	81340	↑	81318	43140 ⁶
	Sport Utility, FJ55(MfrBodyCode) Mfg. from 1/75	↑	↑	61506 81318	43140 ⁶
69-74	All	↑	G63299	81340	82007	↑	G63492	43140 ⁶	

7 Pair Packs, Air hose kit included.



40 Complete Assembled Unit.

68 Mount Kit. Hardware from O.E. Part may need to be reused.;

8 Pair Packs.

54 Kit with Mount and Bearing. Hardware from O.E. Part may need to be reused.

APPLICATION GUIDE

Year	Fitment Notes										
		Ultra	Ready Mounts	Max Control\ LTV Severe Duty\ ProGuard\ Guardian	Strut Cushion\ Strut Mount\ Dampers\ Stabilizer	HiJackers\ Load Carrier\ Classic	Ultra	Ready Mounts	Max Control\ LTV Severe Duty\ ProGuard\ Guardian	Strut Cushion\ Strut Mount\ Dampers\ Stabilizer	HiJackers\ Load Carrier\ Classic

TOYOTA

TOYOTA

LAND CRUISER (cont)

69-74	Exc. Wagon	OO	G63299	81340	82007	OO	G63492	61500	49310 ⁷ 43140 ⁹
	Wagon	OO	G63299	81340	82007	OO	G63492	81318	49311 ⁷ 43140 ⁹
67-68	All	OO	G63299	82007	OO	61500 81147	49310 ⁷

MATRIX

09-14	Left		G52245
	Right		G52246
14	FWD			G51898
09-13	AWD, Left		G57329 ⁴⁰
	AWD, Right		G57330 ⁴⁰
	FWD, Left		G57566 ⁴⁰		G51898	G57451 ⁴⁰
	FWD, Right		G57567 ⁴⁰		G51898	G57452 ⁴⁰
	S, AWD, Left		G57572 ⁴⁰
	S, AWD, Right		G57573 ⁴⁰
03-08	Left		G52013	143093 ⁵³	143094 ⁵³
	Right		G52014	143093 ⁵³	143094 ⁵³
	FWD, Left		G57357 ⁴⁰		G51736	G57067 ⁴⁰
	FWD, Right		G57358 ⁴⁰		G51736	G57068 ⁴⁰
03-06	AWD, Left		G57183 ⁴⁰		G51768
	AWD, Right		G57182 ⁴⁰		G51768

MR2

92-95	All		143059 ⁵¹	OO	G44997 ⁹⁸
85-89	All		143059 ⁵¹

PASEO

95-99	All		G55879	143059 ⁵¹		G51252	143064 ⁵¹
92-94	All		143059 ⁵¹		G55804	143064 ⁵¹

PICKUP

93-95	RWD, Exc. 1 Ton	I	G63903	61509 81541	OO	G63907	61500 77907 81147	49310 ⁷
86-95	4WD, Exc. Lift Kit	OO	G63479	61552 77479 81870	OO	G63494	61510 77494 81871

7 Pair Packs, Air hose kit included.

40 Complete Assembled Unit.



53 Hardware from O.E. Part may need to be reused.

8 Pair Packs.

51 Strut Cushion for use with the Strut/Cartridge/Shocks.

98 Notice: The level of difficulty to install this product is moderately high. Please review the installation instructions carefully before proceeding

APPLICATION GUIDE

Year	Fitment Notes										
		Ultra	Ready Mounts	Max Control\ LTV Severe Duty\ ProGuard\ Guardian	Strut Cushion\ Strut Mount\ Dampers\ Stabilizer	HiJackers\ Load Carrier\ Classic	Ultra	Ready Mounts	Max Control\ LTV Severe Duty\ ProGuard\ Guardian	Strut Cushion\ Strut Mount\ Dampers\ Stabilizer	HiJackers\ Load Carrier\ Classic

TOYOTA

TOYOTA

PICKUP (cont)

85-95	RWD		43048 ⁸
79-95	Single System Steering Stabilizer	⊖	6802SE ⁸⁴
85-92	RWD, 1 Ton	⊖	61509	G63492	61506 81318	49311 ⁷
	RWD, Exc. 1 Ton	⊖	G63903	81541	G63907	61500 77907 81147	49310 ⁷
84-85	4WD, Exc. Lift Kit	⊖	G63404	G63494	61510 77494 81871
80-85	4WD; Single System Steering Stabilizer; with OE Shock Mounts	⊖	6803SE ⁸⁴
84	RWD	⊖	G63903	61509 81541	77907	43048 ⁸ 49310 ⁷
	RWD, Exc. 1 Ton	⊖	81147
	RWD; Mojave	⊖	G63907	61500
80-83	4WD, Exc. Lift Kit	⊖	G63404	G63492	61506 81318	49311 ⁷
75-83	RWD	⊖
73-83	RWD; Mojave	⊖	61504 81750	G63907	61500 77907 81147	43048 ⁸
70-72	RWD	⊖	43048 ⁸
	RWD; Mojave	⊖	61504 81750	G63907	61500 77907 81147

PREVIA

91-97	All	⊖	143061 ⁵¹	G63620
-------	-----	---	------	------	------	----------------------	------	--------	------	------	------	------	------	------

PRIUS

11-15	Right	⊖	G57739 ⁴⁰
	Mfg. to 12/11 Left	⊖	G52331	⊖	70053
	Mfg. to 12/11 Right	⊖	G52332	⊖	70053
10-15	Left	⊖	G57738 ⁴⁰
10	Right	⊖	G52332	G57739 ⁴⁰
	Mfg. to 12/11	⊖	⊖	70053
	Mfg. to 12/11 Left	⊖	G52331
04-09	Left	⊖	G57404 ⁴⁰	143201 ⁵³	⊖	G51795	G57568 ⁴⁰	143094 ⁵³
	Right	⊖	G57405 ⁴⁰	143201 ⁵³	⊖	G51795	G57569 ⁴⁰	143094 ⁵³
01-03	All	⊖	⊖	G57444 ⁴⁰	143094 ⁵³

PRIUS C

17	All	⊖	⊖	70055
15-16	Models w/ 15" or 16" Wheels	⊖	⊖	70055

7 Pair Packs, Air hose kit included.

40 Complete Assembled Unit.



53 Hardware from O.E. Part may need to be reused.

8 Pair Packs.

51 Strut Cushion for use with the Strut/Cartridge/Shocks.

84 Replacement damper for vehicles with the Gabriel Aftermarket mounting kit

APPLICATION GUIDE

Year	Fitment Notes										
		Ultra	Ready Mounts	Max Control\ LTV Severe Duty\ ProGuard\ Guardian	Strut Cushion\ Strut Mount\ Dampers\ Stabilizer	HiJackers\ Load Carrier\ Classic	Ultra	Ready Mounts	Max Control\ LTV Severe Duty\ ProGuard\ Guardian	Strut Cushion\ Strut Mount\ Dampers\ Stabilizer	HiJackers\ Load Carrier\ Classic

TOYOTA

TOYOTA

PRIUS C (cont)

12-14	All	I/O	70055
-------	-----	-------	------	------	------	------	-----	-------	------	------	------	------

RAV4

13-17	All	O/O	G64151
	Left Exc. Japan Manufactured	G57784 ⁴⁰	O/O	G64151
	Right Exc. Japan Manufactured	G57785 ⁴⁰	O/O	G64151
06-12	All	O/O	G64026
	Left	G57204 ⁴⁰	O/O	G64026
	Left	G52004	O/O	G64026
	Right	G57205 ⁴⁰	O/O	G64026
	Right	G52007	O/O	G64026
06-11	4WD	143343 ⁵³	O/O	G64026
01-05	Left	G56582	143367 ⁵³	I/O	69813 G63860
	Right	G56581	143367 ⁵³	I/O	69813 G63860
	AWD, Automatic Left Mfg. from 5/00	G57105 ⁴⁰
	AWD, Automatic Right Mfg. from 5/00	G57106 ⁴⁰
	FWD, Left	G57349 ⁴⁰
	FWD, Right	G57350 ⁴⁰
00	All	143367 ⁵³	I/O	G63860
	Left Mfg. from 5/00	G56582	143367 ⁵³	I/O	G63860
	Mfg. from 5/00	143367 ⁵³	I/O	69813 G63860
	Mfg. to 5/00	143367 ⁵³	I/O	G63860	61651
	Right Mfg. from 5/00	G56581	143367 ⁵³	I/O	G63860
	AWD, Automatic Left Mfg. from 5/00	G57105 ⁴⁰	143367 ⁵³	I/O	G63860
	AWD, Automatic Right Mfg. from 5/00	G57106 ⁴⁰	143367 ⁵³	I/O	G63860
96-99	All	143367 ⁵³	I/O	G63860	61651

SEQUOIA



12-17	Exc. Air Suspension	G51937	143339 ⁵⁸
12-16	All	G51937
12-15	Left	G51937	G57454 ⁴⁰

40 Complete Assembled Unit.

68 Mount Kit. Hardware from O.E. Part may need to be reused.;

53 Hardware from O.E. Part may need to be reused.

APPLICATION GUIDE

Year	Fitment Notes										
		Ultra	Ready Mounts	Max Control\ LTV Severe Duty\ ProGuard\ Guardian	Strut Cushion\ Strut Mount\ Dampers\ Stabilizer	HiJackers\ Load Carrier\ Classic	Ultra	Ready Mounts	Max Control\ LTV Severe Duty\ ProGuard\ Guardian	Strut Cushion\ Strut Mount\ Dampers\ Stabilizer	HiJackers\ Load Carrier\ Classic

TOYOTA

TOYOTA

SEQUOIA (cont)

12-15	Right	G51937	G57453 ⁴⁰
08-11	All	G51937	143340 ⁶⁷
	Exc. Air Suspension	G51937	143339 ⁵³	143340 ⁶⁷
	Left	G51937	G57454 ⁴⁰	143340 ⁶⁷
	Right	G51937	G57453 ⁴⁰	143340 ⁶⁷
01-07	All	G51477	G57027 ⁴⁰	143325 ⁵³	G64087

SIENNA

15-18	AWD	G51805
	FWD	G51804
11-14	2.7L 4Cyl Left	G57730⁴⁰
	2.7L 4Cyl Right	G57731⁴⁰
	2.7L 4Cyl; AWD	G511007
	AWD, Left	G57734⁴⁰	G51805
	AWD, Right	G57735⁴⁰	G51805
	FWD, Left	G57732 ⁴⁰	G51992¹
	FWD, Right	G57733 ⁴⁰	G51992¹
09-10	Left 8 Passenger	G52105
	Right 8 Passenger	G52106
	AWD	G51805
	AWD, Left w/ 8 Passenger Seating	G57375 ⁴⁰
	AWD, Right w/ 8 Passenger Seating	G57376 ⁴⁰
	FWD, 7 Passenger	G51804
	FWD, 8 Passenger	G51805
	FWD, Left w/ 7 Passenger Seating	G52107	G57663 ⁴⁰
	FWD, Left w/ 8 Passenger Seating	G57665 ⁴⁰
	FWD, Right w/ 7 Passenger Seating	G52108	G57664 ⁴⁰
FWD, Right w/ 8 Passenger Seating	G57666 ⁴⁰	
07-08	AWD, Left w/ 8 Passenger Seating	G57375 ⁴⁰	143202 ⁵⁴
	AWD, Right w/ 8 Passenger Seating	G57376 ⁴⁰	143202 ⁵⁴

1 Future Part



53 Hardware from O.E. Part may need to be reused.

67 Mount Kit. Hardware from O.E. Part may need to be reused.

40 Complete Assembled Unit.

54 Kit with Mount and Bearing. Hardware from O.E. Part may need to be reused.

APPLICATION GUIDE

Year	Fitment Notes										
		Ultra	Ready Mounts	Max Control\ LTV Severe Duty\ ProGuard\ Guardian	Strut Cushion\ Strut Mount\ Dampers\ Stabilizer	HiJackers\ Load Carrier\ Classic	Ultra	Ready Mounts	Max Control\ LTV Severe Duty\ ProGuard\ Guardian	Strut Cushion\ Strut Mount\ Dampers\ Stabilizer	HiJackers\ Load Carrier\ Classic

TOYOTA

TOYOTA



SIENNA (cont)

07-08	FWD, Left w/ 7 Passenger Seating	G52107	G57663 ⁴⁰	143202 ⁵⁴
	FWD, Left w/ 8 Passenger Seating	G57665 ⁴⁰	143202 ⁵⁴
	FWD, Right w/ 7 Passenger Seating	G52108	G57664 ⁴⁰	143202 ⁵⁴
	FWD, Right w/ 8 Passenger Seating	G57666 ⁴⁰	143202 ⁵⁴
06-08	Left 8 Passenger	G52105	143202 ⁵⁴
	Right 8 Passenger	G52106	143202 ⁵⁴
04-08	All	143202 ⁵⁴
	AWD	143202 ⁵⁴	I/O	G51805
	FWD, 7 Passenger	143202 ⁵⁴	I/O	G51804
	FWD, 8 Passenger	143202 ⁵⁴	I/O	G51805
05-06	FWD, Left Mfg from 7/05 w/ 7 Passenger Seating	G57663 ⁴⁰	143202 ⁵⁴
	FWD, Left Mfg to 6/05 w/ 7 Passenger Seating	G56798	G57372 ⁴⁰	143202 ⁵⁴
	FWD, Right Mfg from 7/05 w/ 7 Passenger Seating	G57664 ⁴⁰	143202 ⁵⁴
	FWD, Right Mfg to 6/05 w/ 7 Passenger Seating	G56797	G57373 ⁴⁰	143202 ⁵⁴
06	FWD, Left w/ 7 Passenger Seating	G52107	143202 ⁵⁴
	FWD, Right w/ 7 Passenger Seating	G52108	143202 ⁵⁴
05	Left Mfg. from 7/05; w/ 8 Passenger Seating	G52105	143202 ⁵⁴
	Right Mfg. from 7/05; w/ 8 Passenger Seating	G52106	143202 ⁵⁴
	FWD, Left Mfg. from 7/05; w/ 7 Passenger Seating	G52107	143202 ⁵⁴
	FWD, Right Mfg. from 7/05; w/ 7 Passenger Seating	G52108	143202 ⁵⁴
04	FWD, Left w/ 7 Passenger Seating	G56798	G57372 ⁴⁰	143202 ⁵⁴
	FWD, Right w/ 7 Passenger Seating	G56797	G57373 ⁴⁰	143202 ⁵⁴
98-03	Left	G55993	142650 ⁵⁴	I/O	G63610	61592 81937
	Right	G55994	I/O	G63610	61592 81937
	Mfg. to 12/02 Left	G57097 ⁴⁰
	Mfg. to 12/02 Right	G57098 ⁴⁰	142649 ⁵⁴

SOLARA

07-08	Left	G56721	G57076 ⁴⁰	143202 ⁵⁴
-------	------	--------	----------------------	------	----------------------	------	------	------	------	------

APPLICATION GUIDE

Year	Fitment Notes										
		Ultra	Ready Mounts	Max Control\ LTV Severe Duty\ ProGuard\ Guardian	Strut Cushion\ Strut Mount\ Dampers\ Stabilizer	HiJackers\ Load Carrier\ Classic	Ultra	Ready Mounts	Max Control\ LTV Severe Duty\ ProGuard\ Guardian	Strut Cushion\ Strut Mount\ Dampers\ Stabilizer	HiJackers\ Load Carrier\ Classic

TOYOTA

TOYOTA

SOLARA (cont)

07-08	Right	↓	G56722	G57077 ⁴⁰	143202 ⁵⁴	↓
04-06	Left	↓	G56721	G57076 ⁴⁰	143202 ⁵⁴	↓	G56728	G57078 ⁴⁰
	Right	↓	G56722	G57077 ⁴⁰	143202 ⁵⁴	↓	G56729	G57079 ⁴⁰
99-03	All	↓	143057 ⁵¹	↓
	Left	↓	G56506	G56930 ⁴⁰	M56506	142650 ⁵⁴ 143057 ⁵¹	↓	G55675	G56932 ⁴⁰
	Right	↓	G56514	G56931 ⁴⁰	M56514	142649 ⁵⁴ 143057 ⁵¹	↓	G55676	G56933 ⁴⁰

STARLET

81-84	All	↓	143059 ⁵¹	↓	81440
-------	-----	---	------	------	------	----------------------	------	---	------	------	-------	------	------

SUPRA

87-91	All	↓	↓	143057 ⁵¹
86	All	↓	143057 ⁵¹	↓	143057 ⁵¹

T100

93-98	4WD	↓	G63479	61552 77479 81870	↓	61582
	RWD	↓	G63903	61509 81541	↓	G63173	61506



TACOMA

18-21	4WD	↓	G51739	G57786 ⁴⁰	↓
21	Edicion Especial, Limited, Nightshade, SR, Sport, TRD Off-Road, TRD Sport, Trail, 4WD	↓	↓	G64006
18-20	Edicion Especial, Limited, SR, Sport, TRD Off-Road, TRD Sport, 4WD	↓	↓	G64006
17	4WD; Exc. TRD Pro Model	↓	G51739	↓	G64006
16	4WD	↓	G51739	↓
	4WD; Exc. TRD Pro Model	↓	↓	G64006
14-15	4WD, Exc. Off Road	↓	G51739	↓	G64006
13-15	4WD, Left Exc. Off Road & Sport Models	↓	G57133 ⁴⁰	↓
	4WD, Right Exc. Off Road & Sport Models	↓	G57134 ⁴⁰	↓
	Base, Pre Runner, RWD	↓	↓	G63889
	Pre Runner, Left 4WD	↓	G51739	G57133 ⁴⁰	↓
	Pre Runner, Right 4WD	↓	G51739	G57134 ⁴⁰	↓
	RWD; Base & Pre-Runner Left	↓	G51853	↓
	RWD; Base & Pre-Runner Right	↓	G51854	↓

40 Complete Assembled Unit.

51 Strut Cushion for use with the Strut/Cartridge/Shocks.

APPLICATION GUIDE

Year	Fitment Notes										
		Ultra	Ready Mounts	Max Control\ LTV Severe Duty\ ProGuard\ Guardian	Strut Cushion\ Strut Mount\ Dampers\ Stabilizer	HiJackers\ Load Carrier\ Classic	Ultra	Ready Mounts	Max Control\ LTV Severe Duty\ ProGuard\ Guardian	Strut Cushion\ Strut Mount\ Dampers\ Stabilizer	HiJackers\ Load Carrier\ Classic

TOYOTA

TOYOTA

TACOMA (cont)



13	4WD	↓	G51739	
	4WD, Exc. Off Road	↓	
10-12	RWD; Base & Pre-Runner Left	↓	G51853	143383 ⁶⁸	
	RWD; Base & Pre-Runner Right	↓	G51854	143383 ⁶⁸	
05-12	All	↓	143383 ⁶⁸	
	4WD	↓	G51739	143383 ⁶⁸	
	4WD, Left Exc. Off Road & Sport Models	↓	G57133 ⁴⁰	143383 ⁶⁸	
	4WD, Right Exc. Off Road & Sport Models	↓	G57134 ⁴⁰	143383 ⁶⁸	
	Base, Pre Runner, RWD	↓	143383 ⁶⁸	
	Pre Runner, Left 4WD	↓	G51739	G57133 ⁴⁰	143383 ⁶⁸
	Pre Runner, Right 4WD	↓	G51739	G57134 ⁴⁰	143383 ⁶⁸
05-09	RWD; Base & X-Runner Models Left	↓	G51853	143383 ⁶⁸	
	RWD; Base & X-Runner Models Right	↓	G51854	143383 ⁶⁸	
01-04	Pre Runner, Left	↓	G63937	61606	
	Pre Runner, Right	↓	G63937	61606	
	S-Runner	↓	G63937	61606	
98-04	4WD	↓	143325 ⁵³	
	Pre Runner, 4WD, RWD, Exc. Heavy Duty Upgrade	↓	
04	Base, 4WD	↓	
	Base, RWD	↓	G63937	61606	
	Pre Runner, 4WD, RWD	↓	G51077	G57010 ⁴⁰	
	Pre Runner, RWD	↓	
98-03	Pre Runner, 4WD, RWD	↓	G51077	G57010 ⁴⁰	
95-03	DLX, 4WD	↓	
	DLX, RWD	↓	G63937	61606	
98-00	Limited	↓	
	Pre Runner, Left	↓	
	Pre Runner, Right	↓	
	SR5, 4WD	↓	
95-97	4WD	↓	G51077	G57010 ⁴⁰	143325 ⁵³	
	4WD, Exc. Heavy Duty Upgrade	↓	

40 Complete Assembled Unit.

53 Hardware from O.E. Part may need to be reused.

68 Mount Kit. Hardware from O.E. Part may need to be reused.;

APPLICATION GUIDE

Year	Fitment Notes										
		Ultra	Ready Mounts	Max Control\ LTV Severe Duty\ ProGuard\ Guardian	Strut Cushion\ Strut Mount\ Dampers\ Stabilizer	HiJackers\ Load Carrier\ Classic	Ultra	Ready Mounts	Max Control\ LTV Severe Duty\ ProGuard\ Guardian	Strut Cushion\ Strut Mount\ Dampers\ Stabilizer	HiJackers\ Load Carrier\ Classic

TOYOTA

TERCEL

TOYOTA

95-99	All		G55879	143059 ⁵¹		G51252	143064 ⁵¹
91-94	All		143059 ⁵¹		G55804	143064 ⁵¹
87-90	All		143059 ⁵¹
	Hatchback		142248 ⁵³ 143059 ⁵¹	143064 ⁵¹
	Sedan		142248 ⁵³ 143059 ⁵¹	143064 ⁵¹
88	Wagon		142247 ⁵³ 143059 ⁵¹	143057 ⁵¹
87	FWD		G44748	143059 ⁵¹
	Wagon		142247 ⁵³ 143059 ⁵¹	142249 ⁵³ 143057 ⁵¹
83-86	All		143059 ⁵¹	142249 ⁵³
	FWD		G44748	143059 ⁵¹	142249 ⁵³
	Wagon		142247 ⁵³ 143059 ⁵¹	143057 ⁵¹ 142249 ⁵³
80-82	All		143059 ⁵¹

TUNDRA

21	4WD		49237 ⁷
19-20	RWD, Right		G51855	G57124 ⁴¹		G64038
07-20	All		G51855		G64038
	4WD, Left		G51855	G57220 ⁴⁰		G64038	49237 ⁷
	4WD, Right		G51855	G57221 ⁴⁰		G64038	49237 ⁷
	RWD, Left		G51855	G57123 ⁴⁰		G64038
07-18	RWD, Right		G51855	G57124 ⁴⁰		G64038
07-16	w/ Off Road Package		G51855		G64038	143340 ⁶⁷
00-06	All		G57027 ⁴⁰	143325 ⁵³		G63815	77815
	Exc. Air Suspension		G51477	G57027 ⁴⁰	143325 ⁵³		G63815	77815

VAN

84-89	RWD		61529
84-88	Leaf(RearSpringType)			G63907	61500 77907 81147	43048 ⁸ 49310 ⁷

VAN WAGON

88	All		43048 ⁸ 49310 ⁷
----	-----	--	------	------	------	------	------	--	------	------	------	------	------------------------------------------

7 Pair Packs, Air hose kit included.

40 Complete Assembled Unit.

51 Strut Cushion for use with the Strut/Cartridge/Shocks.





236 67 Mount Kit. Hardware from O.E. Part may need to be reused.

8 Pair Packs.

41 Complete Assembled Unit. See Ref. D for procedures to replace Elec Adj Susp with non-adj product.

53 Hardware from O.E. Part may need to be reused.







APPLICATION GUIDE

Year	Fitment Notes										
		 Ultra	Ready Mounts	Max Control\ LTV Severe Duty\ ProGuard\ Guardian	Strut Cushion\ Strut Mount\ Dampers\ Stabilizer	HiJackers\ Load Carrier\ Classic	 Ultra	Ready Mounts	Max Control\ LTV Severe Duty\ ProGuard\ Guardian	Strut Cushion\ Strut Mount\ Dampers\ Stabilizer	HiJackers\ Load Carrier\ Classic

















TOYOTA

TOYOTA









VAN WAGON (cont)

88	Leaf(RearSpringType)		 G63907	61500 77907	43048 ⁸ 49310 ⁷
	RWD		61529		43048 ⁸ 49310 ⁷
	RWD; Leaf(RearSpringType)			81147	43048 ⁸ 49310 ⁷

VENZA

12-14	Left		G57676 ⁴⁰	
	Right		G57677 ⁴⁰	
09-14	AWD, Left			G57658 ⁴⁰
	AWD, Right			G57659 ⁴⁰
	FWD, Left			G57483 ⁴⁰
	FWD, Right			G57484 ⁴⁰
09-11	Left		G57676 ⁴⁰	143402 ⁶⁸	
	Right		G57677 ⁴⁰	143402 ⁶⁸	

















YARIS

06-14	All		 70055
07-11	Exc. Dust Boot		 G51783 70055
	Left		G56842	G57353 ⁴⁰	 70055
	Right		G56843	G57354 ⁴⁰	 70055



VOLKSWAGEN

VOLKSWAGEN

BEETLE

12-13	4Cyl		G57277 ⁴⁰	
98-10	All		G56606	G57039 ⁴⁰	142651 ⁵⁴	 69945	81934
67-77	All		14004	82005		49307 ⁷ 82001
66	All		14004		49307 ⁷
	Exc. 1300 and 1500		14004	82001		49307 ⁷
	1300 & 1500		14004	82005		49307 ⁷
59-65	All		14004	82001		49307 ⁷ 82001
52-58	All		82001		49307 ⁷ 82001

BORA

06-09	All		G56899	 G51799
-------	-----	-------------------------------------------------------------------------------------	--------	------	------	------	------	----------------------------------------------------------------------------------------------	------	------	------	------

7 Pair Packs, Air hose kit included.



40 Complete Assembled Unit.

68 Mount Kit. Hardware from O.E. Part may need to be reused.;

8 Pair Packs.

54 Kit with Mount and Bearing. Hardware from O.E. Part may need to be reused.

APPLICATION GUIDE

Year	Fitment Notes										
		Ultra	Ready Mounts	Max Control\ LTV Severe Duty\ ProGuard\ Guardian	Strut Cushion\ Strut Mount\ Dampers\ Stabilizer	Hijackers\ Load Carrier\ Classic	Ultra	Ready Mounts	Max Control\ LTV Severe Duty\ ProGuard\ Guardian	Strut Cushion\ Strut Mount\ Dampers\ Stabilizer	Hijackers\ Load Carrier\ Classic

VOLKSWAGEN CABRIOLET

85-93	All		142091 ⁵⁴ 143058 ⁵¹				142252 ⁵³
-------	-----	--	------	------	------	----------------------------------------------	------	--	--	--	----------------------	------

CC

09-17	All		G56899	G57156 ⁴⁰	143344 ⁵³				G51799	143345 ⁵³
-------	-----	--	--------	----------------------	------	----------------------	------	--	--	--	--------	------	------	------	----------------------	------

CORRADO

93-94	VR6		142444 ⁵⁴
90-92	All		143061 ⁵¹	142252 ⁵³ 143063 ⁵¹
92	VR6		142444 ⁵⁴ 143061 ⁵¹	142252 ⁵³ 143063 ⁵¹

EOS

12-14	All		G56899
07-11	All		G56899	143344 ⁵³	143345 ⁵³
	4Cyl		G56899	G57277 ⁴⁰	143344 ⁵³	143345 ⁵³

FASTBACK

69-73	All		82001				49307 ⁷ 82001
66-68	All		82001				82001

FOX

87-93	All		143057 ⁵¹	143063 ⁵¹
-------	-----	--	------	------	------	----------------------	------	--	--	--	------	------	------	------	----------------------	------

GOLF

12-14	Exc. R Models		G56899				G51799
12	4Cyl		G57277 ⁴⁰
10-11	All		143344 ⁵³	143345 ⁵³
	4Cyl		G57277 ⁴⁰	143344 ⁵³	143345 ⁵³
11	Exc. R Models		G56899	143344 ⁵³				G51799	143345 ⁵³
99-06	All		G57039 ⁴⁰
	A4(MfrBodyCode)		G56606	G57039 ⁴⁰	142651 ⁵⁴				69945	81934
97-98	All		G57006 ⁴⁰	142444 ⁵⁴ 143058 ⁵¹	142252 ⁵³ 142573 ⁶⁷ 143063 ⁵¹
	From Chassis # 08774; VR6		G55991	G57006 ⁴⁰	142444 ⁵⁴ 143058 ⁵¹	142252 ⁵³ 142573 ⁶⁷ 143063 ⁵¹
93-96	All		G57005 ⁴⁰	142444 ⁵⁴ 143058 ⁵¹	142252 ⁵³ 142573 ⁶⁷ 143063 ⁵¹
	From Chassis # 08774; VR6		G55991	G57005 ⁴⁰	142444 ⁵⁴ 143058 ⁵¹	142252 ⁵³ 142573 ⁶⁷ 143063 ⁵¹

7 Pair Packs, Air hose kit included.

51 Strut Cushion for use with the Strut/Cartridge/Shocks.





238 54 Kit with Mount and Bearing. Hardware from O.E. Part may need to be reused.

40 Complete Assembled Unit.

53 Hardware from O.E. Part may need to be reused.







67 Mount Kit. Hardware from O.E. Part may need to be reused.

APPLICATION GUIDE

Year	Fitment Notes										
		 Ultra	Ready Mounts	Max Control\ LTV Severe Duty\ ProGuard\ Guardian	Strut Cushion\ Strut Mount\ Dampers\ Stabilizer	HiJackers\ Load Carrier\ Classic	 Ultra	Ready Mounts	Max Control\ LTV Severe Duty\ ProGuard\ Guardian	Strut Cushion\ Strut Mount\ Dampers\ Stabilizer	HiJackers\ Load Carrier\ Classic





VOLKSWAGEN

GOLF (cont)







































93-96	Up to Chassis # 08773		G55990	G57005 ⁴⁰	142444 ⁵⁴ 143058 ⁵¹		142252 ²³ 142573 ⁹⁷ 143063 ⁵¹
85-92	All		G57005 ⁴⁰	143058 ⁵¹		142252 ²³ 142573 ⁹⁷ 143063 ⁵¹
	Sealed Struts		G55990	G57005 ⁴⁰	143058 ⁵¹		142252 ²³ 142573 ⁹⁷ 143063 ⁵¹

VOLKSWAGEN

GTI

10-14	All		G56899	G57680 ⁴⁰	143344 ⁵³		G51799	143345 ⁵³
06-09	All		G56899	143344 ⁵³		G51799	143345 ⁵³

JETTA

12-17	All		143344 ⁵³		143345 ⁵³
12-14	Wagon		G56899 ⁴⁹	143344 ⁵³		143345 ⁵³
10-11	All		G56899 ⁴⁹	143344 ⁵³		143345 ⁵³
10	GLI		G56899 ⁴⁹	G57277 ⁴⁰	143344 ⁵³		143345 ⁵³
06-09	All		G56899 ⁴⁹	143344 ⁵³		G51799	143345 ⁵³
	GLI		G56899 ⁴⁹	G57277 ⁴⁰	143344 ⁵³		G51799	143345 ⁵³
01-05	All		G57039 ⁴⁰	
	Sedan		G56606	G57039 ⁴⁰	142651 ⁵⁴		69945	81934
99-00	All		G56606	G57039 ⁴⁰	142651 ⁵⁴		69945
97-98	All		G57006 ⁴⁰ G57392 ⁴⁰	142444 ⁵⁴ 143058 ⁵¹		142252 ²³ 142573 ⁹⁷ 143063 ⁵¹
	VR6 from Chassis # 08774		G55991	G57006 ⁴⁰ G57392 ⁴⁰	142444 ⁵⁴ 143058 ⁵¹		142252 ²³ 142573 ⁹⁷ 143063 ⁵¹
	VR6 up to Chassis # 08773		G55990	G57006 ⁴⁰ G57392 ⁴⁰	142444 ⁵⁴ 143058 ⁵¹		142252 ²³ 142573 ⁹⁷ 143063 ⁵¹
94-96	All		G57005 ⁴⁰	142444 ⁵⁴ 143058 ⁵¹		142252 ²³ 142573 ⁹⁷ 143063 ⁵¹
	VR6 from Chassis # 08774		G55991	G57005 ⁴⁰	142444 ⁵⁴ 143058 ⁵¹		142252 ²³ 142573 ⁹⁷ 143063 ⁵¹
	VR6 up to Chassis # 08773		G55990	G57005 ⁴⁰	142444 ⁵⁴ 143058 ⁵¹		142252 ²³ 142573 ⁹⁷ 143063 ⁵¹
85-93	All		G57005 ⁴⁰	143058 ⁵¹		142252 ²³ 142573 ⁹⁷ 143063 ⁵¹
93	VR6 from Chassis # 08774		G55991	G57005 ⁴⁰	143058 ⁵¹		142252 ²³ 142573 ⁹⁷ 143063 ⁵¹
	VR6 up to Chassis # 08773		G55990	G57005 ⁴⁰	143058 ⁵¹		142252 ²³ 142573 ⁹⁷ 143063 ⁵¹
85-92	Sealed Struts		G55990	G57005 ⁴⁰	143058 ⁵¹		142252 ²³ 142573 ⁹⁷ 143063 ⁵¹

40 Complete Assembled Unit.

51 Strut Cushion for use with the Strut/Cartridge/Shocks.



54 Kit with Mount and Bearing. Hardware from O.E. Part may need to be reused.

49 55mm Outer Tube

53 Hardware from O.E. Part may need to be reused.

67 Mount Kit. Hardware from O.E. Part may need to be reused.

APPLICATION GUIDE

Year	Fitment Notes										
		Ultra	Ready Mounts	Max Control\ LTV Severe Duty\ ProGuard\ Guardian	Strut Cushion\ Strut Mount\ Dampers\ Stabilizer	HiJackers\ Load Carrier\ Classic	Ultra	Ready Mounts	Max Control\ LTV Severe Duty\ ProGuard\ Guardian	Strut Cushion\ Strut Mount\ Dampers\ Stabilizer	HiJackers\ Load Carrier\ Classic

VOLKSWAGEN

JETTA (cont)

80-84	All	↓	142091 ⁵⁴ 143058 ⁵¹	↓	142252 ⁵³
-------	-----	---	------	------	------	----------------------------------------------	------	---	------	------	------	----------------------	------

KARMANN GHIA

67-74	All	↓	82005	↓	82001
-------	-----	---	------	------	------	------	-------	---	------	------	------	------	-------

PASSAT

12-17	All	↓	G57156 ⁴⁰	↓
12-13	Mfg to 10/12	↓	G57156 ⁴⁰	↓	143345 ⁵³
10	All	↓	G56899	G57156 ⁴⁰	143344 ⁵³	↓	G51799	143345 ⁵³
	Mfg to 10/12	↓	G56899	G57156 ⁴⁰	143344 ⁵³	↓	G51799	143345 ⁵³
06-09	All	↓	G56899	143344 ⁵³	↓	G51799	143345 ⁵³
	2.0T	↓	G56899	G57156 ⁴⁰	143344 ⁵³	↓	G51799	143345 ⁵³
02-05	Left	↓	G57135 ⁴⁰	↓
	Right	↓	G57136 ⁴⁰	↓
	FWD	↓	↓	143380 ⁵³
	FWD, From VIN# 3B300001 through VIN# 3B300000	↓	↓	69946
01-05	AWD, Exc. VIN# 3B300001 through VIN# 3B300000	↓	↓	G51742
01	Left	↓	G57135 ⁴⁰	143058 ⁵¹	↓	142653 ⁵³ 143063 ⁵¹
	Right	↓	G57136 ⁴⁰	143058 ⁵¹	↓	142653 ⁵³ 143063 ⁵¹
	FWD, From VIN# 3B300001 through VIN# 3B300000	↓	G51097	↓	69946
99-00	AWD, Exc. VIN# 3B300001 through VIN# 3B300000	↓	143058 ⁵¹	↓	G51742	142653 ⁵³ 143063 ⁵¹
98-00	All	↓	143058 ⁵¹	↓	142653 ⁵³ 143063 ⁵¹
	FWD, From VIN# 3B300001 through VIN# 3B300000	↓	G51097	143058 ⁵¹	↓	69946	142653 ⁵³ 143063 ⁵¹
98	AWD; Exc. VIN# 3B300001 through VIN# 3B300000	↓	143058 ⁵¹	↓	G51742	142653 ⁵³ 143063 ⁵¹
90-97	All	↓	142444 ⁵⁴ 143058 ⁵¹	↓
	Rebuildable OE Front Struts	↓	G44986 ⁹⁸	142444 ⁵⁴ 143058 ⁵¹	↓

QUANTUM

82-88	All	↓	142195 ⁵³ 143057 ⁵¹	↓	143063 ⁵¹
-------	-----	---	------	------	------	----------------------------------------------	------	---	------	------	------	----------------------	------

R32

08	All	↓	143344 ⁵³	↓	143345 ⁵³
----	-----	---	------	------	------	----------------------	------	---	------	------	------	----------------------	------

40 Complete Assembled Unit.





53 Hardware from O.E. Part may need to be reused.

98 Notice: The level of difficulty to install this product is moderately high. Please

51 Strut Cushion for use with the Strut/Cartridge/Shocks.





54 Kit with Mount and Bearing. Hardware from O.E. Part may need to be reused.

APPLICATION GUIDE



Year	Fitment Notes										
			Ultra	Ready Mounts	Max Control\ LTV Severe Duty\ ProGuard\ Guardian	Strut Cushion\ Strut Mount\ Dampers\ Stabilizer	HiJackers\ Load Carrier\ Classic		Ultra	Ready Mounts	Max Control\ LTV Severe Duty\ ProGuard\ Guardian

VOLKSWAGEN





RABBIT

06-09	All		G56899	143344 ⁵³		G51799	143345 ⁵³
75-84	All		142091 ⁵⁴ 143058 ⁵¹		142252 ⁵³



RABBIT PICKUP

80-83	All		143058 ⁵¹	
-------	-----	-----------------------------------------------------------------------------------	------	------	------	----------------------	------	-------------------------------------------------------------------------------------	------	------	------	------	------



ROUTAN

09-14	All		G57206 ⁴⁰	143463 ⁶⁸	
	Exc. Self-Leveling Suspension		G52131	G57206 ⁴⁰	143463 ⁶⁸		G64042













SCIROCCO

75-89	All		142091 ⁵⁴ 143058 ⁵¹		142252 ⁵³ 143063 ⁵¹
-------	-----	-----------------------------------------------------------------------------------	------	------	------	----------------------------------------------	------	-------------------------------------------------------------------------------------	------	------	------	----------------------------------------------	------



SQUAREBACK

66-73	All		82001		49307 ⁷ 82001
-------	-----	-----------------------------------------------------------------------------------	------	------	------	------	-------	-------------------------------------------------------------------------------------	------	------	------	------	-----------------------------





SUPER BEETLE

76-79	All		142251 ⁵³ 143057 ⁵¹		49307 ⁷ 82001
74-75	All		14005 142251 ⁵³ 143057 ⁵¹		49307 ⁷ 82001
73	All		14005 142251 ⁵³ 143057 ⁵¹	
	3 Bolt Flange-Type Lower Mount		14005 142251 ⁵³ 143057 ⁵¹		49307 ⁷ 82001
71-72	All		14005 143057 ⁵¹	
	3 Bolt Flange-Type Lower Mount		14005 143057 ⁵¹		49307 ⁷ 82001

THING

73-74	All		14004	82005		49307 ⁷ 82001
-------	-----	-------------------------------------------------------------------------------------	------	------	------	-------	-------	---------------------------------------------------------------------------------------	------	------	------	------	-----------------------------





TIGUAN

12-17	All			G51993	143345 ⁵³
09-11	All		G52301	143344 ⁵³		G51993	143345 ⁵³





TIGUAN LIMITED

18	All			G51993	143345 ⁵³
----	-----	-------------------------------------------------------------------------------------	------	------	------	------	------	---------------------------------------------------------------------------------------	--------	------	------	----------------------	------

TOUAREG

04-10	Left Exc. Air Suspension		G52348		G51928
	Right Exc. Air Suspension		G52349		G51928

TRANSPORTER

70-79	All			82032
68-69	All		82001		82032

7 Pair Packs, Air hose kit included.

51 Strut Cushion for use with the Strut/Cartridge/Shocks.



54 Kit with Mount and Bearing. Hardware from O.E. Part may need to be reused.

40 Complete Assembled Unit.

53 Hardware from O.E. Part may need to be reused.

68 Mount Kit. Hardware from O.E. Part may need to be reused.;

APPLICATION GUIDE

Year	Fitment Notes										
		Ultra	Ready Mounts	Max Control\ LTV Severe Duty\ ProGuard\ Guardian	Strut Cushion\ Strut Mount\ Dampers\ Stabilizer	HiJackers\ Load Carrier\ Classic	Ultra	Ready Mounts	Max Control\ LTV Severe Duty\ ProGuard\ Guardian	Strut Cushion\ Strut Mount\ Dampers\ Stabilizer	HiJackers\ Load Carrier\ Classic

VOLKSWAGEN

TRANSPORTER (cont)

56-67	All		82001		82001
-------	-----	--	------	------	------	------	-------	--	------	------	------	------	-------

VOLKSWAGEN

VANAGON

86-89	4WD			G63454	61539 81581	49215 ⁷
-------	-----	--	------	------	------	------	------	--	--------	------	----------------	------	--------------------

VOLVO

122

VOLVO

59-68	All		82026		81270	49105 ⁷
-------	-----	--	------	------	------	------	-------	--	------	------	-------	------	--------------------

142 / 144 / 145 / 164

75	All		69600	81494		69787 ³¹
68-74	All		69600	81494

240 / 242 / 244 / 245 / 262 / 264 / 265

75-93	All		143057 ⁵¹		69787 ³¹
-------	-----	--	------	------	------	----------------------	------	--	---------------------	------	------	------	------

740 / 745 / 760 / 780

84-92	All		143058 ⁵¹
-------	-----	--	------	------	------	----------------------	------	--	------	------	------	------	------

850

93-97	Exc. Hydraulic Self Leveling System		G57040 ⁴⁰	143191 ⁵³		69901	142941 ⁵³
-------	-------------------------------------	--	------	----------------------	------	----------------------	------	--	-------	------	------	----------------------	------

940

91-95	Exc. Hydraulic Self Leveling System		143058 ⁵¹
-------	-------------------------------------	--	------	------	------	----------------------	------	--	------	------	------	------	------

960

92-95	All		143058 ⁵¹
-------	-----	--	------	------	------	----------------------	------	--	------	------	------	------	------

1800

61-73	All		82026	
-------	-----	--	------	------	------	------	-------	--	------	------	------	------	------

C30

07-13	Left		G52274		70056
	Right		G52275		70056

C70

08-13	Left		G52274
	Right		G52275
06-07	Left		G52274	143191 ⁵³
	Right		G52275	143191 ⁵³
98-04	All		G57040 ⁴⁰	143191 ⁵³		69901	142941 ⁵³

DL

84	Exc. Hydraulic Self-Leveling System			69787 ³¹
----	-------------------------------------	--	------	------	------	------	------	--	---------------------	------	------	------	------



7 Pair Packs, Air hose kit included.

40 Complete Assembled Unit.

31 With Nivomat Self-Leveling Suspension replace spring with Volvo No. 1229052/4.

51 Strut Cushion for use with the Strut/Cartridge/Shocks.

APPLICATION GUIDE

Year	Fitment Notes										
		Ultra	Ready Mounts	Max Control\ LTV Severe Duty\ ProGuard\ Guardian	Strut Cushion\ Strut Mount\ Dampers\ Stabilizer	HiJackers\ Load Carrier\ Classic	Ultra	Ready Mounts	Max Control\ LTV Severe Duty\ ProGuard\ Guardian	Strut Cushion\ Strut Mount\ Dampers\ Stabilizer	HiJackers\ Load Carrier\ Classic















VOLVO

VOLVO











GLE

84	Exc. Hydraulic Self-Leveling System	69787 ³¹
----	-------------------------------------	-------	-------	-------	-------	-------	---------------------	-------	-------	-------	-------



S40

05-12	Left		G52274		70056
	Right		G52275		70056
00-04	All			143422 ⁶⁷
	Mfg. from 4/00			G51841	143422 ⁶⁷
04	Mfg to 04/00			70056	143422 ⁶⁷
	T5, Left		G52274		143422 ⁶⁷
	T5, Right Mfg. to 4/00		G52275		143422 ⁶⁷

















S60

08-09	All		G56802	
	FWD		G56802		70040
04-07	All		G56802	143191 ⁵³	
	FWD		G56802	143191 ⁵³		70040
01-03	All		G56802	143191 ⁵³		70040





S70

98-00	All		G57040 ⁴⁰	143191 ⁵³		69901	142941 ⁵³
-------	-----	-------------------------------------------------------------------------------------	-------	----------------------	-------	----------------------	-------	---------------------------------------------------------------------------------------	-------	-------	-------	----------------------	-------

S80

07-15	Left		G57337 ⁴⁰	
	Right		G57338 ⁴⁰	
99-06	All		G56802		70040
	Exc. Nivomat Rear Suspension		G56802	143191 ⁵³		70040
06	Left Mfg. from 3/06		G56802	G57337 ⁴⁰		70040
	Right Mfg. from 3/06		G56802	G57338 ⁴⁰		70040
99-05	Left		G56802	G57335 ⁴⁰		70040
	Right		G56802	G57336 ⁴⁰		70040



V40

00-04	All			143422 ⁶⁷
	Mfg. from 4/00			G51841	143422 ⁶⁷

31 With Nivomat Self-Leveling Suspension replace spring with Volvo No. 1229052/4.
53 Hardware from O.E. Part may need to be reused.

40 Complete Assembled Unit.
67 Mount Kit. Hardware from O.E. Part may need to be reused.





APPLICATION GUIDE

Year	Fitment Notes										
		Ultra	Ready Mounts	Max Control\ LTV Severe Duty\ ProGuard\ Guardian	Strut Cushion\ Strut Mount\ Dampers\ Stabilizer	HiJackers\ Load Carrier\ Classic	Ultra	Ready Mounts	Max Control\ LTV Severe Duty\ ProGuard\ Guardian	Strut Cushion\ Strut Mount\ Dampers\ Stabilizer	HiJackers\ Load Carrier\ Classic











VOLVO

VOLVO









V50

05-11	Left		G52274		70056
	Right		G52275		70056

V70

01-07	Exc. Electronic Suspension / Nivomat			70040
	Exc. XC70, XC Cross Country and Exc. Auto-Leveling System		143191 ⁵³	
00-06	Mfg. from 3/00 and Exc. XC70, XC Cross Country and Auto Leveling		G56802	
98-00	Exc. XC70, XC Cross Country and Exc. Auto-Leveling System		143191 ⁵³		142941 ⁵³
	Mfg. to 3/00 and Exc. XC70, XC Cross Country		G57040 ⁴⁰		69901

XC90

07-08	All		G52295	
04-06	All		G52295	143191 ⁵³	
03	All		G52295	
	AWD		G52295	143191 ⁵³	

Numerical listing

Shock	POP	Alternative No.	MTG Acc. Supplied
Pos.	Year	Application	

Steering Stabilizer

Shock	POP	Alternative No.	MTG Acc. Supplied
Pos.	Year	Application	
6801SE A 500498,142037			
F	83-94	CHEVROLET BLAZER, S MODELS All Single System Steering Stabilizer; w/ factory mounting hole in the steering linkage.	
F	79-82	LUV PICKUP 4WD Single System Steering Stabilizer; w/ factory mounting hole in the steering linkage.	
F	83-04	S10 4WD Single System Steering Stabilizer; w/ factory mounting hole in the steering linkage.	
F	83-91	GMC S15 JIMMY All Single System Steering Stabilizer; w/ factory mounting hole in the steering linkage.	
F	91-93	SONOMA / S15 All Single System Steering Stabilizer; w/ factory mounting hole in the steering linkage.	
F	82-90	SONOMA / S15 RWD Single System Steering Stabilizer; w/ factory mounting hole in the steering linkage.	
F	91	SYCLONE All Single System Steering Stabilizer; w/ factory mounting hole in the steering linkage.	
F	84-00	JEEP CHEROKEE All Single System Steering Stabilizer; w/ factory mounting hole in the steering linkage.	
F	86-92	COMANCHE All Single System Steering Stabilizer; w/ factory mounting hole in the steering linkage.	
F	97-06	WRANGLER TJ (MfrBodyCode) Single System Steering Stabilizer; w/ factory mounting hole in the steering linkage.	
F	87-95	WRANGLER YJ (MfrBodyCode) Single System Steering Stabilizer; w/ factory mounting hole in the steering linkage.	
6802SE B 141998			
F	79-86	CHEVROLET BLAZER 4WD Dual System Steering Stabilizer All models with factory frame bracket. Kit 143168 required to install to linkage.	
F	79-84	BLAZER RWD Dual System Steering Stabilizer All models with factory frame bracket. Kit 143168 required to install to linkage.	
F	50-58	PICKUP Truck Single System Steering Stabilizer; w/ I-Beam Axle All models with factory frame bracket. Kit 143168 required to install to linkage.	
F	73-86	PICKUP 1/2 TON, C10 All Single System Steering Stabilizer All models with factory frame bracket. Kit 143168 required to install to linkage.	
F	67-86	PICKUP 1/2 TON, K10 All Dual System Steering Stabilizer All models with factory frame bracket. Kit 143168 required to install to linkage.	
F	87	PICKUP 1/2 TON, R10 All Single System Steering Stabilizer All models with factory frame bracket. Kit 143168 required to install to linkage.	
F	87	PICKUP 1/2 TON, V10 All Dual System Steering Stabilizer All models with factory frame bracket. Kit 143168 required to install to linkage.	
F	82-86	PICKUP 1 TON, C30 6.2L 8Cyl V (379), 3.98 101.0(Bore)3.82 97.0(Stroke) Single System Steering Stabilizer; w/ Cooler All models with factory frame bracket. Kit 143168 required to install to linkage.	
F	75-86	PICKUP 1 TON, C30 4.8L 6Cyl L (292), 3.88 98.4(Bore)4.13 104.8(Stroke) Single System Steering Stabilizer; w/ Cooler All models with factory frame bracket. Kit 143168 required to install to linkage.	

Steering Stabilizer

Shock	POP	Alternative No.	MTG Acc. Supplied
Pos.	Year	Application	

6802SE B (cont) 141998			
F	75-86	PICKUP 1 TON, C30 5.7L 8Cyl V (350), 4.00 101.6(Bore)3.48 88.5(Stroke) Single System Steering Stabilizer; w/ Cooler All models with factory frame bracket. Kit 143168 required to install to linkage.	
F	80	PICKUP 1 TON, C30 4.1L 6Cyl L (250), 3.68 93.5(Bore)3.91 99.3(Stroke) Single System Steering Stabilizer; w/ Cooler All models with factory frame bracket. Kit 143168 required to install to linkage.	
F	79	PICKUP 1 TON, C30 4.1L 6Cyl L (250) Single System Steering Stabilizer; w/ Cooler All models with factory frame bracket. Kit 143168 required to install to linkage.	
F	76-78	PICKUP 1 TON, C30 6.6L 8Cyl V (400), 4.13 104.8(Bore)3.76 95.5(Stroke) Single System Steering Stabilizer; w/ Cooler All models with factory frame bracket. Kit 143168 required to install to linkage.	
F	78	PICKUP 1 TON, C30 4.1L 6Cyl L (250), 3.68 93.5(Bore)3.91 99.3(Stroke) Single System Steering Stabilizer; w/ Cooler All models with factory frame bracket. Kit 143168 required to install to linkage.	
F	78	PICKUP 1 TON, C30 5.0L 8Cyl V (305), 3.74 94.9(Bore)3.48 88.4(Stroke) Single System Steering Stabilizer; w/ Cooler All models with factory frame bracket. Kit 143168 required to install to linkage.	
F	75	PICKUP 1 TON, C30 4.1L 6Cyl L (250), 3.68 93.5(Bore)3.91 99.3(Stroke) Single System Steering Stabilizer; w/ Cooler All models with factory frame bracket. Kit 143168 required to install to linkage.	
F	73-74	PICKUP 1 TON, C30 All Single System Steering Stabilizer; w/ Cooler All models with factory frame bracket. Kit 143168 required to install to linkage.	
F	61-72	PICKUP 1 TON, C30 All Single System Steering Stabilizer All models with factory frame bracket. Kit 143168 required to install to linkage.	
F	77-86	PICKUP 1 TON, K30 All Dual System Steering Stabilizer All models with factory frame bracket. Kit 143168 required to install to linkage.	
F	87-88	PICKUP 1 TON, R30 4.8L 6Cyl L (292), 3.88 98.4(Bore)4.13 104.8(Stroke) Single System Steering Stabilizer; w/ Cooler All models with factory frame bracket. Kit 143168 required to install to linkage.	
F	87-88	PICKUP 1 TON, R30 5.7L 8Cyl V (350), 4.00 101.6(Bore)3.48 88.5(Stroke) Single System Steering Stabilizer; w/ Cooler All models with factory frame bracket. Kit 143168 required to install to linkage.	
F	87-88	PICKUP 1 TON, R30 6.2L 8Cyl V (379), 3.98 101.0(Bore)3.82 97.0(Stroke) Single System Steering Stabilizer; w/ Cooler All models with factory frame bracket. Kit 143168 required to install to linkage.	
F	89-91	PICKUP 1 TON, R3500 5.7L 8Cyl V (350), 4.00 101.6(Bore)3.48 88.5(Stroke) Single System Steering Stabilizer; w/ Cooler All models with factory frame bracket. Kit 143168 required to install to linkage.	
F	63-86	PICKUP 3/4 TON, C20 All Single System Steering Stabilizer All models with factory frame bracket. Kit 143168 required to install to linkage.	
F	67-86	PICKUP 3/4 TON, K20 All Dual System Steering Stabilizer All models with factory frame bracket. Kit 143168 required to install to linkage.	

Numerical listing

Shock	POP	Alternative No.	MTG Acc. Supplied
Pos.	Year	Application	

6802SE B (cont) 141998			
F	87-88	PICKUP 3/4 TON, R20 All Single System Steering Stabilizer All models with factory frame bracket. Kit 143168 required to install to linkage.	
F	89	PICKUP 3/4 TON, R2500 All Single System Steering Stabilizer All models with factory frame bracket. Kit 143168 required to install to linkage.	
F	87	PICKUP 3/4 TON, V20 All Dual System Steering Stabilizer All models with factory frame bracket. Kit 143168 required to install to linkage.	
F	82-03	S10 RWD Single System Steering Stabilizer All models with factory frame bracket. Kit 143168 required to install to linkage.	
F	68-86	SUBURBAN 1/2 TON, C10 All Single System Steering Stabilizer All models with factory frame bracket. Kit 143168 required to install to linkage.	
F	68-86	SUBURBAN 1/2 TON, K10 All Dual System Steering Stabilizer All models with factory frame bracket. Kit 143168 required to install to linkage.	
F	87-88	SUBURBAN 1/2 TON, R10 All Dual System Steering Stabilizer All models with factory frame bracket. Kit 143168 required to install to linkage.	
F	89-91	SUBURBAN 1/2 TON, R1500 All Single System Steering Stabilizer All models with factory frame bracket. Kit 143168 required to install to linkage.	
F	68-86	SUBURBAN 3/4 TON, C20 All Single System Steering Stabilizer All models with factory frame bracket. Kit 143168 required to install to linkage.	
F	68-86	SUBURBAN 3/4 TON, K20 All Dual System Steering Stabilizer All models with factory frame bracket. Kit 143168 required to install to linkage.	
F	87-88	SUBURBAN 3/4 TON, R20 All Single System Steering Stabilizer All models with factory frame bracket. Kit 143168 required to install to linkage.	
F	89-91	SUBURBAN 3/4 TON, R2500 All Single System Steering Stabilizer All models with factory frame bracket. Kit 143168 required to install to linkage.	
F	87-88	SUBURBAN 3/4 TON, V20 All Dual System Steering Stabilizer All models with factory frame bracket. Kit 143168 required to install to linkage.	
F	89-91	SUBURBAN 3/4 TON, V2500 All Dual System Steering Stabilizer All models with factory frame bracket. Kit 143168 required to install to linkage.	
F	70-95	VAN 1/2 TON, G / EXPRESS All Single System Steering Stabilizer All models with factory frame bracket. Kit 143168 required to install to linkage.	
F	71-95	VAN 1 TON, G / EXPRESS All Single System Steering Stabilizer All models with factory frame bracket. Kit 143168 required to install to linkage.	
F	70-95	VAN 3/4 TON, G / EXPRESS All Single System Steering Stabilizer All models with factory frame bracket. Kit 143168 required to install to linkage.	
F	70	DODGE A100 TRUCK All Dual System Steering Stabilizer; w/ I-Beam Axle All models with factory frame bracket. Kit 143168 required to install to linkage.	
F	64-69	A100 TRUCK All Dual System Steering Stabilizer All models with factory frame bracket. Kit 143168 required to install to linkage.	

Numerical listing

Shock	POP	Alternative No.	MTG Acc. Supplied
Pos.	Year	Application	
6802SE	B (cont)		141998
F	79-82	D50 RWD Single System Steering Stabilizer All models with factory frame bracket. Kit 143168 required to install to linkage.	
F	86-89	PICKUP 1/2 TON, D100 SERIES All Single System Steering Stabilizer All models with factory frame bracket. Kit 143168 required to install to linkage.	
F	72-79	PICKUP 1/2 TON, D100 SERIES All Single System Steering Stabilizer All models with factory frame bracket. Kit 143168 required to install to linkage.	
F	60-71	PICKUP 1/2 TON, D100 SERIES All Single System Steering Stabilizer; w/ I-Beam Axle All models with factory frame bracket. Kit 143168 required to install to linkage.	
F	90-93	PICKUP 1/2 TON, W100 SERIES All Single System Steering Stabilizer All models with factory frame bracket. Kit 143168 required to install to linkage.	
F	60-86	PICKUP 1/2 TON, W100 SERIES All Dual System Steering Stabilizer; Exc. Vacuum Servo Mounted on Drivers Side of Axle All models with factory frame bracket. Kit 143168 required to install to linkage.	
F	75-93	PICKUP 1 TON, D300 SERIES All Single System Steering Stabilizer All models with factory frame bracket. Kit 143168 required to install to linkage.	
F	72-74	PICKUP 1 TON, D300 SERIES All Single System Steering Stabilizer; w/ Coil Spring Front Suspension All models with factory frame bracket. Kit 143168 required to install to linkage.	
F	60-71	PICKUP 1 TON, D300 SERIES All Single System Steering Stabilizer; w/ I-Beam Axle All models with factory frame bracket. Kit 143168 required to install to linkage.	
F	90-93	PICKUP 1 TON, W300 SERIES All Single System Steering Stabilizer All models with factory frame bracket. Kit 143168 required to install to linkage.	
F	60-86	PICKUP 1 TON, W300 SERIES All Dual System Steering Stabilizer; Exc. Vacuum Servo Mounted on Drivers Side of Axle All models with factory frame bracket. Kit 143168 required to install to linkage.	
F	73-93	PICKUP 3/4 TON, D200 SERIES All Single System Steering Stabilizer All models with factory frame bracket. Kit 143168 required to install to linkage.	
F	60-71	PICKUP 3/4 TON, D200 SERIES All Single System Steering Stabilizer; w/ I-Beam Axle All models with factory frame bracket. Kit 143168 required to install to linkage.	
F	90-93	PICKUP 3/4 TON, W200 SERIES All Single System Steering Stabilizer All models with factory frame bracket. Kit 143168 required to install to linkage.	
F	60-86	PICKUP 3/4 TON, W200 SERIES All Dual System Steering Stabilizer; Exc. Vacuum Servo Mounted on Drivers Side of Axle All models with factory frame bracket. Kit 143168 required to install to linkage.	
F	83-93	PICKUP, RAM 50 RWD Single System Steering Stabilizer All models with factory frame bracket. Kit 143168 required to install to linkage.	
F	87-89	RAIDER All Single System Steering Stabilizer All models with factory frame bracket. Kit 143168 required to install to linkage.	
F	87-93	RAMCHARGER RWD Single System Steering Stabilizer All models with factory frame bracket. Kit 143168 required to install to linkage.	

Steering Stabilizer

Shock	POP	Alternative No.	MTG Acc. Supplied
Pos.	Year	Application	
6802SE	B (cont)		141998
F	74-86	RAMCHARGER All Dual System Steering Stabilizer; Exc. Vacuum Servo Mounted on Drivers Side of Axle All models with factory frame bracket. Kit 143168 required to install to linkage.	
F	71	VAN 1/2 TON, A / B SERIES / RAM All Single System Steering Stabilizer; w/ I-Beam Axle All models with factory frame bracket. Kit 143168 required to install to linkage.	
F	71	VAN 1 TON, A / B SERIES / RAM All Single System Steering Stabilizer; w/ I-Beam Axle All models with factory frame bracket. Kit 143168 required to install to linkage.	
F	71	VAN 3/4 TON, A / B SERIES / RAM All Single System Steering Stabilizer; w/ I-Beam Axle All models with factory frame bracket. Kit 143168 required to install to linkage.	
F	92-96	FORD BRONCO All Single System Steering Stabilizer All models with factory frame bracket. Kit 143168 required to install to linkage.	
F	78-91	BRONCO All Dual System Steering Stabilizer; Exc. Sway Bar All models with factory frame bracket. Kit 143168 required to install to linkage.	
F	84-90	BRONCO II All Single System Steering Stabilizer All models with factory frame bracket. Kit 143168 required to install to linkage.	
F	61-67	ECONOLINE VAN Van All models with factory frame bracket. Kit 143168 required to install to linkage.	
F	91-94	EXPLORER All All models with factory frame bracket. Kit 143168 required to install to linkage.	
F	89-91	F59 All Single System Steering Stabilizer; Superduty Motorhome All models with factory frame bracket. Kit 143168 required to install to linkage.	
F	89-91	MOTORHOME CHASSIS / F53 All Single System Steering Stabilizer; Motorhome All models with factory frame bracket. Kit 143168 required to install to linkage.	
F	80-83	PICKUP 1/2 TON, F-100 All Single System Steering Stabilizer All models with factory frame bracket. Kit 143168 required to install to linkage.	
F	77-79	PICKUP 1/2 TON, F-100 All Dual System Steering Stabilizer; Exc. Sway Bar All models with factory frame bracket. Kit 143168 required to install to linkage.	
F	77-79	PICKUP 1/2 TON, F-100 All Single System Steering Stabilizer; w/ Twin I-Beam Axle All models with factory frame bracket. Kit 143168 required to install to linkage.	
F	75-76	PICKUP 1/2 TON, F-100 4WD Dual System Steering Stabilizer; Exc. Sway Bar All models with factory frame bracket. Kit 143168 required to install to linkage.	
F	75-76	PICKUP 1/2 TON, F-100 RWD Single System Steering Stabilizer; w/ Twin I-Beam Axle All models with factory frame bracket. Kit 143168 required to install to linkage.	
F	73-74	PICKUP 1/2 TON, F-100 RWD Single System Steering Stabilizer w/ Twin I Beam Axle All models with factory frame bracket. Kit 143168 required to install to linkage.	
F	65-72	PICKUP 1/2 TON, F-100 All RWD; Single System Steering Stabilizer w/ Twin I Beam Axle All models with factory frame bracket. Kit 143168 required to install to linkage.	
F	61-64	PICKUP 1/2 TON, F-100 All RWD; Single Steering Stabilizer; w/ I Beam Axle All models with factory frame bracket. Kit 143168 required to install to linkage.	
F	60	PICKUP 1/2 TON, F-100 All Single Steering Stabilizer; w/ I Beam Axle All models with factory frame bracket. Kit 143168 required to install to linkage.	

Numerical listing

Shock	POP	Alternative No.	MTG Acc. Supplied
Pos.	Year	Application	
6802SE	B (cont)		141998
F	94-96	PICKUP 1/2 TON, F-150 4WD Single System Steering Stabilizer; w/ Twin Traction Beam All models with factory frame bracket. Kit 143168 required to install to linkage.	
F	90-93	PICKUP 1/2 TON, F-150 All Single System Steering Stabilizer All models with factory frame bracket. Kit 143168 required to install to linkage.	
F	80-89	PICKUP 1/2 TON, F-150 All All models with factory frame bracket. Kit 143168 required to install to linkage.	
F	77-79	PICKUP 1/2 TON, F-150 All Dual System Steering Stabilizer; Exc. Sway Bar All models with factory frame bracket. Kit 143168 required to install to linkage.	
F	75-76	PICKUP 1/2 TON, F-150 RWD All models with factory frame bracket. Kit 143168 required to install to linkage.	
F	90-92	PICKUP 1/2 TON, F SUPERDUTY All All models with factory frame bracket. Kit 143168 required to install to linkage.	
F	92-96	PICKUP 1 TON, F-350 / SUPERDUTY RWD Dual System Steering Stabilizer All models with factory frame bracket. Kit 143168 required to install to linkage.	
F	89-91	PICKUP 1 TON, F-350 / SUPERDUTY RWD Single System Steering Stabilizer All models with factory frame bracket. Kit 143168 required to install to linkage.	
F	82-88	PICKUP 1 TON, F-350 / SUPERDUTY RWD Single System Steering Stabilizer; Exc. Anti-Sway Bar All models with factory frame bracket. Kit 143168 required to install to linkage.	
F	79-81	PICKUP 1 TON, F-350 / SUPERDUTY RWD Dual System Steering Stabilizer All models with factory frame bracket. Kit 143168 required to install to linkage.	
F	75-78	PICKUP 1 TON, F-350 / SUPERDUTY All Dual System Steering Stabilizer All models with factory frame bracket. Kit 143168 required to install to linkage.	
F	65-74	PICKUP 1 TON, F-350 / SUPERDUTY All Single System Steering Stabilizer; w/ Twin I Beam Axle All models with factory frame bracket. Kit 143168 required to install to linkage.	
F	60-64	PICKUP 1 TON, F-350 / SUPERDUTY All Single System Steering Stabilizer w/ I Beam Axle All models with factory frame bracket. Kit 143168 required to install to linkage.	
F	80-96	PICKUP 3/4 TON, F-250 / SUPERDUTY 4WD Single System Steering Stabilizer All models with factory frame bracket. Kit 143168 required to install to linkage.	
F	75-79	PICKUP 3/4 TON, F-250 / SUPERDUTY RWD Single System Steering Stabilizer All models with factory frame bracket. Kit 143168 required to install to linkage.	
F	65-67	PICKUP P100 All Single System Steering Stabilizer All models with factory frame bracket. Kit 143168 required to install to linkage.	
F	68-73	PICKUP P350 All Single System Steering Stabilizer All models with factory frame bracket. Kit 143168 required to install to linkage.	
F	83-97	RANGER All All models with factory frame bracket. Kit 143168 required to install to linkage.	
F	69-74	VAN 1/2 TON, ECONOLINE / CLUB WAGON All Single System Steering Stabilizer; w/ Twin I-Beam Axle All models with factory frame bracket. Kit 143168 required to install to linkage.	

Numerical listing

Shock	POP	Alternative No.	MTG Acc. Supplied
Pos.	Year	Application	
6802SE	B (cont)	141998	
F	69-74	VAN 3/4 TON, ECONOLINE / CLUB WAGON / SUPERDUTY All Single System Steering Stabilizer; w/ Twin I-Beam Axle All models with factory frame bracket. Kit 143168 required to install to linkage.	
F	73-91	GMC JIMMY All Replacement damper for vehicles w/ Gabriel aftermarket mounting kit All models with factory frame bracket. Kit 143168 required to install to linkage.	
F	70-72	JIMMY All K5 Dual System Steering Stabilizer All models with factory frame bracket. Kit 143168 required to install to linkage.	
F	57-59	PICKUP All Single System Steering Stabilizer; w/ I-Beam Axle All models with factory frame bracket. Kit 143168 required to install to linkage.	
F	53-56	PICKUP Truck Single System Steering Stabilizer; w/ I-Beam Axle All models with factory frame bracket. Kit 143168 required to install to linkage.	
F	73-86	PICKUP 1/2 TON, C15 / C1500 All Single System Steering Stabilizer All models with factory frame bracket. Kit 143168 required to install to linkage.	
F	69-86	PICKUP 1/2 TON, K15 / K1500 All Dual System Steering Stabilizer All models with factory frame bracket. Kit 143168 required to install to linkage.	
F	87	PICKUP 1/2 TON, R1500 All Single System Steering Stabilizer All models with factory frame bracket. Kit 143168 required to install to linkage.	
F	87	PICKUP 1/2 TON, V1500 All Dual System Steering Stabilizer All models with factory frame bracket. Kit 143168 required to install to linkage.	
F	75-86	PICKUP 1 TON, C35/3500 Crew Cab Pickup All models with factory frame bracket. Kit 143168 required to install to linkage.	
F	72-74	PICKUP 1 TON, C35/3500 All All models with factory frame bracket. Kit 143168 required to install to linkage.	
F	67-86	PICKUP 3/4 TON, C25 / C2500 All Single System Steering Stabilizer All models with factory frame bracket. Kit 143168 required to install to linkage.	
F	67-86	PICKUP 3/4 TON, K25 / K2500 All Dual System Steering Stabilizer All models with factory frame bracket. Kit 143168 required to install to linkage.	
F	87-89	PICKUP 3/4 TON, R2500 All Single System Steering Stabilizer All models with factory frame bracket. Kit 143168 required to install to linkage.	
F	87	PICKUP 3/4 TON, V2500 All AN49 All models with factory frame bracket. Kit 143168 required to install to linkage.	
F	82-93	SONOMA / S15 RWD Single System Steering Stabilizer All models with factory frame bracket. Kit 143168 required to install to linkage.	
F	68-86	SUBURBAN 1/2 TON, C15 / C1500 All Single System Steering Stabilizer All models with factory frame bracket. Kit 143168 required to install to linkage.	
F	68-86	SUBURBAN 1/2 TON, K15 / K1500 All Dual System Steering Stabilizer All models with factory frame bracket. Kit 143168 required to install to linkage.	
F	87-91	SUBURBAN 1/2 TON, R1500 All Single System Steering Stabilizer All models with factory frame bracket. Kit 143168 required to install to linkage.	

Steering Stabilizer

Shock	POP	Alternative No.	MTG Acc. Supplied
Pos.	Year	Application	
6802SE	B (cont)	141998	
F	87-91	SUBURBAN 1/2 TON, V1500 All Dual System Steering Stabilizer All models with factory frame bracket. Kit 143168 required to install to linkage.	
F	68-86	SUBURBAN 3/4 TON, C25 / C2500 All Single System Steering Stabilizer All models with factory frame bracket. Kit 143168 required to install to linkage.	
F	68-86	SUBURBAN 3/4 TON, K25 / K2500 All Dual System Steering Stabilizer All models with factory frame bracket. Kit 143168 required to install to linkage.	
F	87-91	SUBURBAN 3/4 TON, R2500 All Single System Steering Stabilizer All models with factory frame bracket. Kit 143168 required to install to linkage.	
F	87-91	SUBURBAN 3/4 TON, V2500 All Dual System Steering Stabilizer All models with factory frame bracket. Kit 143168 required to install to linkage.	
F	70-95	VAN 1/2 TON, G / SAVANA All Single System Steering Stabilizer All models with factory frame bracket. Kit 143168 required to install to linkage.	
F	71-95	VAN 1 TON, G / SAVANA All Single System Steering Stabilizer All models with factory frame bracket. Kit 143168 required to install to linkage.	
F	70-95	VAN 3/4 TON, G / SAVANA All Single System Steering Stabilizer All models with factory frame bracket. Kit 143168 required to install to linkage.	
F	74	INTERNATIONAL 100 All All models with factory frame bracket. Kit 143168 required to install to linkage.	
F	75	150 All All models with factory frame bracket. Kit 143168 required to install to linkage.	
F	74-75	200 All All models with factory frame bracket. Kit 143168 required to install to linkage.	
F	68-69	908C All Single System Steering Stabilizer; 1/2 Ton, 3/4 Ton & Travelall All models with factory frame bracket. Kit 143168 required to install to linkage.	
F	68	1000C All Single System Steering Stabilizer; 1/2 Ton, 3/4 Ton & Travelall All models with factory frame bracket. Kit 143168 required to install to linkage.	
F	69-70	1000D All Single System Steering Stabilizer; 1/2 Ton, 3/4 Ton & Travelall All models with factory frame bracket. Kit 143168 required to install to linkage.	
F	71-73	1010 All Single System Steering Stabilizer; 1/2 Ton, 3/4 Ton & Travelall All models with factory frame bracket. Kit 143168 required to install to linkage.	
F	68	1100C All Single System Steering Stabilizer; 1/2 Ton, 3/4 Ton & Travelall All models with factory frame bracket. Kit 143168 required to install to linkage.	
F	69-70	1100D All Single System Steering Stabilizer; 1/2 Ton, 3/4 Ton & Travelall All models with factory frame bracket. Kit 143168 required to install to linkage.	
F	71-73	1110 All Single System Steering Stabilizer; 1/2 Ton, 3/4 Ton & Travelall All models with factory frame bracket. Kit 143168 required to install to linkage.	
F	68	1200C All Single System Steering Stabilizer; 1/2 Ton, 3/4 Ton & Travelall All models with factory frame bracket. Kit 143168 required to install to linkage.	

Numerical listing

Shock	POP	Alternative No.	MTG Acc. Supplied
Pos.	Year	Application	
6802SE	B (cont)	141998	
F	69-70	1200D All Single System Steering Stabilizer; 1/2 Ton, 3/4 Ton & Travelall All models with factory frame bracket. Kit 143168 required to install to linkage.	
F	71-73	1210 All Single System Steering Stabilizer; 1/2 Ton, 3/4 Ton & Travelall All models with factory frame bracket. Kit 143168 required to install to linkage.	
F	68	1300C All Single System Steering Stabilizer; 1/2 Ton, 3/4 Ton & Travelall All models with factory frame bracket. Kit 143168 required to install to linkage.	
F	69-70	1300D All Single System Steering Stabilizer; 1/2 Ton, 3/4 Ton & Travelall All models with factory frame bracket. Kit 143168 required to install to linkage.	
F	71-73	1310 All Single System Steering Stabilizer; 1/2 Ton, 3/4 Ton & Travelall All models with factory frame bracket. Kit 143168 required to install to linkage.	
F	68-71	M800 All Single System Steering Stabilizer; 1/2 and 3/4 Ton I-Beam Axle All models with factory frame bracket. Kit 143168 required to install to linkage.	
F	68-72	M1100 / M1200 All Single System Steering Stabilizer; 1/2 and 3/4 Ton I-Beam Axle All models with factory frame bracket. Kit 143168 required to install to linkage.	
F	69	M1400 All Single System Steering Stabilizer; 1/2 and 3/4 Ton I-Beam Axle All models with factory frame bracket. Kit 143168 required to install to linkage.	
F	61-68	SCOUT All Single System Steering Stabilizer; 4WD; Scout 80, 800 All models with factory frame bracket. Kit 143168 required to install to linkage.	
F	75	TRAVELALL RWD All models with factory frame bracket. Kit 143168 required to install to linkage.	
F	84-91	ISUZU TROOPER 4WD Single System Steering Stabilizer All models with factory frame bracket. Kit 143168 required to install to linkage.	
F	66-83	JEEP CJ5 All Single System Steering Stabilizer All models with factory frame bracket. Kit 143168 required to install to linkage.	
F	59-60	CJ5 All Single System Steering Stabilizer All models with factory frame bracket. Kit 143168 required to install to linkage.	
F	66-75	CJ6 All Single System Steering Stabilizer All models with factory frame bracket. Kit 143168 required to install to linkage.	
F	59-60	CJ6 All Single System Steering Stabilizer All models with factory frame bracket. Kit 143168 required to install to linkage.	
F	76-86	CJ7 All Single System Steering Stabilizer All models with factory frame bracket. Kit 143168 required to install to linkage.	
F	66-71	JEEP STER All Single System Steering Stabilizer All models with factory frame bracket. Kit 143168 required to install to linkage.	
F	81-85	SCRAMBLER / CJ8 All Single System Steering Stabilizer All models with factory frame bracket. Kit 143168 required to install to linkage.	
F	61-67	UNIVERSAL All Single System Steering Stabilizer All models with factory frame bracket. Kit 143168 required to install to linkage.	
F	63-67	WAGONEER All Exc. Independent Front Suspension All models with factory frame bracket. Kit 143168 required to install to linkage.	
F	91-94	MAZDA NAVAJO All All models with factory frame bracket. Kit 143168 required to install to linkage.	

Numerical listing

Shock	POP	Alternative No.	MTG Acc. Supplied
Pos.	Year	Application	
6802SE	B (cont)	141998	
F	95-96	MITSUBISHI MIGHTY MAX All Single System Steering Stabilizer All models with factory frame bracket. Kit 143168 required to install to linkage.	
F	83-94	MIGHTY MAX RWD Single System Steering Stabilizer All models with factory frame bracket. Kit 143168 required to install to linkage.	
F	86-95	MONTERO All Single System Steering Stabilizer All models with factory frame bracket. Kit 143168 required to install to linkage.	
F	82	NISSAN 720 PICKUP All Single System Steering Stabilizer All models with factory frame bracket. Kit 143168 required to install to linkage.	
F	79-82	PLYMOUTH PICKUP All All models with factory frame bracket. Kit 143168 required to install to linkage.	
F	74-81	TRAILDUSTER All Dual System Steering Stabilizer; Exc. Vacuum Servo Mounted on Drivers Side of Axle All models with factory frame bracket. Kit 143168 required to install to linkage.	
F	86-95	SUZUKI SAMURAI All Single System Steering Stabilizer All models with factory frame bracket. Kit 143168 required to install to linkage.	
F	86-95	TOYOTA PICKUP All Single System Steering Stabilizer All models with factory frame bracket. Kit 143168 required to install to linkage.	
F	79-85	PICKUP RWD Single System Steering Stabilizer All models with factory frame bracket. Kit 143168 required to install to linkage.	
6803SE	W	141998	
F	69-72	CHEVROLET BLAZER All Single System Steering Stabilizer	
F	60	PICKUP Truck Dana 60 Axle up to 3 1/2" O.D. or Napco axle up to 3 3/8" O.D.	
F	57-58	PICKUP Truck Dana 60 Axle up to 3 1/2" O.D. or Napco axle up to 3 3/8" O.D.	
F	61-72	PICKUP 1/2 TON, K10 All Single System Steering Stabilizer	
F	61-72	PICKUP 3/4 TON, K20 All Single System Steering Stabilizer	
F	01-09	PICKUP 3/4 TON, SILVERADO 2500 HD All 9200# GVW w/o OE Unit - 15059138 15155638	
F	68-72	SUBURBAN 1/2 TON, K10 All Single System Steering Stabilizer	
F	68-72	SUBURBAN 3/4 TON, K20 All Single System Steering Stabilizer	
F	70	DODGE A100 TRUCK All Single System Steering Stabilizer; w/ I-Beam Axle	
F	60-89	PICKUP 1/2 TON, W100 SERIES All Single System Steering Stabilizer	
F	60-89	PICKUP 1 TON, W300 SERIES All Single System Steering Stabilizer	
F	69-89	PICKUP 3/4 TON, W200 SERIES All Single System Steering Stabilizer	
F	60-67	PICKUP 3/4 TON, W200 SERIES All Single System Steering Stabilizer	
F	75-93	RAMCHARGER 4WD Single System Steering Stabilizer	
F	74	RAMCHARGER All Single System Steering Stabilizer	
F	71-87	VAN 1/2 TON, A / B SERIES / RAM All Single System Steering Stabilizer	
F	71-87	VAN 1 TON, A / B SERIES / RAM All Single System Steering Stabilizer	
F	80-87	VAN 3/4 TON, A / B SERIES / RAM All Single System Steering Stabilizer	
F	78-79	VAN 3/4 TON, A / B SERIES / RAM All Van Charger Special	
F	71-77	VAN 3/4 TON, A / B SERIES / RAM All Single System Steering Stabilizer	
F	70-79	FORD BRONCO All Single System Steering Stabilizer	
F	77-79	PICKUP 1/2 TON, F-100 All 4WD; Single System Steering Stabilizer	
F	73-76	PICKUP 1/2 TON, F-100 4WD Single System Steering Stabilizer	

Steering Stabilizer

Shock	POP	Alternative No.	MTG Acc. Supplied
Pos.	Year	Application	
6803SE	W (cont)	141998	
F	70-72	PICKUP 1/2 TON, F-100 4WD 4WD; Single System Steering Stabilizer	
F	60-69	PICKUP 1/2 TON, F-100 All 4WD; Single System Steering Stabilizer	
F	76-79	PICKUP 1/2 TON, F-150 4WD Single System Steering Stabilizer	
F	75	PICKUP 1/2 TON, F-150 All 4WD	
F	75-77	PICKUP 1 TON, F-350 / SUPERDUTY Manual Steering Single System Steering Stabilizer	
F	60-74	PICKUP 1 TON, F-350 / SUPERDUTY All Single System Steering Stabilizer	
F	75-77	PICKUP 3/4 TON, F-250 / SUPERDUTY 4WD, Manual Steering Single System Steering Stabilizer	
F	60-74	PICKUP 3/4 TON, F-250 / SUPERDUTY All Single System Steering Stabilizer	
F	74-79	VAN 3/4 TON, ECONOLINE / CLUB WAGON / SUPERDUTY All QuadraVan Special	
F	71-72	GMC JIMMY 4WD 4WD; K-5 Single System Steering Stabilizer	
F	70	JIMMY All K-5 Single System Steering Stabilizer	
F	69-72	PICKUP 1/2 TON, K15 / K1500 All Single System Steering Stabilizer	
F	67-72	PICKUP 3/4 TON, K25 / K2500 All Single System Steering Stabilizer	
F	68-72	SUBURBAN 1/2 TON, K15 / K1500 All Single System Steering Stabilizer	
F	68-72	SUBURBAN 3/4 TON, K25 / K2500 All Single System Steering Stabilizer	
F	69-71	INTERNATIONAL SCOUT All Single System Steering Stabilizer	
F	71-80	SCOUT II All Single System Steering Stabilizer	
F	75	TRAVELALL 4WD Single System Steering Stabilizer	
F	63-67	JEEP GLADIATOR All Single System Steering Stabilizer	
F	75-81	PLYMOUTH TRAILDUSTER 4WD Single System Steering Stabilizer	
F	74	TRAILDUSTER All Single System Steering Stabilizer	
F	84-85	TOYOTA 4RUNNER All Single System Steering Stabilizer	
F	80-85	PICKUP 4WD Single System Steering Stabilizer; w/ OE Stock Mounts	
6804SE	A	500498,141397	
F	80-88	AMERICAN MOTORS EAGLE All	
F	75-86	CHEVROLET BLAZER All Single System Steering Stabilizer	
F	73-86	PICKUP 1/2 TON, K10 All Single System Steering Stabilizer	
F	87	PICKUP 1/2 TON, V10 All Single System Steering Stabilizer	
F	77-86	PICKUP 1 TON, K30 All Single System Steering Stabilizer	
F	73-86	PICKUP 3/4 TON, K20 All Single System Steering Stabilizer	
F	87	PICKUP 3/4 TON, V20 All Single System Steering Stabilizer	
F	73-86	SUBURBAN 1/2 TON, K10 All Single System Steering Stabilizer	
F	87-88	SUBURBAN 1/2 TON, R10 All Single System Steering Stabilizer	
F	73-86	SUBURBAN 3/4 TON, K20 All Single System Steering Stabilizer	
F	87-88	SUBURBAN 3/4 TON, V20 All Single System Steering Stabilizer	
F	89-91	SUBURBAN 3/4 TON, V2500 All Single System Steering Stabilizer	
F	94-95	VAN 1 TON, G / EXPRESS All Single System Steering Stabilizer; HD w/ Straight Front Axle & Tilt Hood	
F	85-93	VAN 1 TON, P SERIES All Single System Steering Stabilizer; w/ I-Beam Front Suspension	
F	87-94	DODGE DAKOTA 4WD Single System Steering Stabilizer	
F	94-97	PICKUP 1/2 TON, RAM 1500 (SEE RAM 1500) 4WD With OEM 52038276	
F	94-97	PICKUP 1 TON, RAM 3500 (SEE RAM 3500) 4WD With OEM 52038276	

Numerical listing

Shock	POP	Alternative No.	MTG Acc. Supplied
Pos.	Year	Application	
6804SE	A (cont)	500498,141397	
F	94-97	PICKUP 1 TON, RAM 3500 (SEE RAM 3500) RWD w/ OEM 52038276 Solid Front Axle	
F	94-97	PICKUP 3/4 TON, RAM 2500 (SEE RAM 2500) 4WD With OEM 52038276	
F	66-69	FORD BRONCO All Single System Steering Stabilizer	
F	73-91	GMC JIMMY All Heavy Duty replacement damper for vehicles w/ OE stabilizer	
F	73-86	PICKUP 1/2 TON, K15 / K1500 All Single System Steering Stabilizer	
F	87	PICKUP 1/2 TON, V1500 All Single System Steering Stabilizer	
F	73-86	PICKUP 3/4 TON, K25 / K2500 All Single System Steering Stabilizer	
F	87	PICKUP 3/4 TON, V2500 All Single System Steering Stabilizer	
F	73-86	SUBURBAN 1/2 TON, K15 / K1500 All Single System Steering Stabilizer	
F	87-91	SUBURBAN 1/2 TON, V1500 All Single System Steering Stabilizer	
F	73-86	SUBURBAN 3/4 TON, K25 / K2500 All Single System Steering Stabilizer	
F	87-91	SUBURBAN 3/4 TON, V2500 All Single System Steering Stabilizer	
F	94-95	VAN 1 TON, G / SAVANA All Single System Steering Stabilizer; HD w/ Straight Front Axle & Tilt Hood	
F	75-83	JEEP CHEROKEE 4WD Single System Steering Stabilizer	
F	74	CHEROKEE All Single System Steering Stabilizer	
F	84-91	GRAND WAGONEER All Single System Steering Stabilizer	
F	74-88	J10 PICKUP All Single System Steering Stabilizer	
F	74-88	J20 PICKUP All Single System Steering Stabilizer	
6828SE	W	142718	
F	00-02	FORD E-450 ECONOLINE SUPER DUTY All	
F	02	E-550 ECONOLINE SUPER DUTY All	
F	03	E-550 SUPER DUTY All	
F	96-99	ECONOLINE SUPER DUTY All	
F	99-10	PICKUP 1 TON, F-350 / SUPERDUTY RWD	
F	92-97	PICKUP 1 TON, F-350 / SUPERDUTY RWD	
F	99-10	PICKUP 3/4 TON, F-250 / SUPERDUTY RWD	
F	92-97	PICKUP 3/4 TON, F-250 / SUPERDUTY RWD	
F	21-22	VAN 1 TON, ECONOLINE / CLUB WAGON / SUPERDUTY All	
F	92-19	VAN 1 TON, ECONOLINE / CLUB WAGON / SUPERDUTY All	
F	96-04	VAN 3/4 TON, ECONOLINE / CLUB WAGON / SUPERDUTY All	
6847SE	C	143081	
F	00-07	DODGE PICKUP 1/2 TON, RAM 1500 (SEE RAM 1500) 4WD With OEM # 52106909AB, AC, AD	
F	00-07	PICKUP 1 TON, RAM 3500 (SEE RAM 3500) 4WD With OEM # 52106909AB, AC, AD	
F	00-07	PICKUP 1 TON, RAM 3500 (SEE RAM 3500) RWD With OEM # 52106909AB, AC, AD and Solid Front Axle	
F	00-07	PICKUP 3/4 TON, RAM 2500 (SEE RAM 2500) 4WD With OEM # 52106909AB, AC, AD	
6850SE	W	143168	
F	99-04	FORD PICKUP 1 TON, F-350 / SUPERDUTY 4WD Exc. OE Unit	
F	99-04	PICKUP 3/4 TON, F-250 / SUPERDUTY 4WD Exc. OE Unit	
6853SE	A	143155	
F	92-99	CHEVROLET PICKUP 1/2 TON, C15 / C1500 All Exc. OE Unit	
F	92-97	PICKUP 1/2 TON, K15 / K1500 All Exc. OE Unit	
F	95-00	PICKUP 1 TON, K35 / K3500 All Exc. OE Unit	
F	92-99	PICKUP 3/4 TON, C25 / C2500 All Exc. OE Unit	
F	99-00	PICKUP 3/4 TON, K25 / K2500 All Exc. OE Unit	

Numerical listing

Shock	POP	Alternative No.	MTG Acc. Supplied
Pos.	Year	Application	
6853SE	A	(cont)	143155
F 01-09	PICKUP 3/4 TON, SILVERADO	2500 HD 4WD 9200# GVW w/ OE Unit - 15059138 15155638	
F 00-05	SUBURBAN 1/2 TON, 1500 4WD	Exc. OE Unit	
F 00-05	SUBURBAN 3/4 TON, 2500 4WD	Exc. OE Unit	
F 95-99	SUBURBAN 3/4 TON, K25 / K2500	All Exc. OE Unit	
F 01-05	TAHOE 4WD New Body Style; Exc. Z55 Auto Ride Suspension		
F 95-00	TAHOE 4WD Old Body Style		
F 99-00	GMC PICKUP 3/4 TON, K25 / K2500	4WD 9200# GVW w/ OE Unit - 15059138 15155638	
F 99-05	SIERRA 1500 4WD Exc. OE Unit		
F 99-04	SIERRA 2500 4WD Up through 8600# GVW; Exc. OE Steering Stabilizer		
F 01-09	SIERRA 2500 HD 4WD 9200# GVW w/ OE Unit - 15059138 15155638		
F 99-05	YUKON 4WD		
F 93-98	JEEP GRAND CHEROKEE All		
6854SE	C		142718
F 00-05	FORD EXCURSION 4WD With OE Unit		
F 99-03	PICKUP 1 TON, F-350 / SUPERDUTY 4WD With OE Unit		
F 99-03	PICKUP 3/4 TON, F-250 / SUPERDUTY 4WD With OE Unit		
F 99-04	PICKUP, F-450 SUPERDUTY 4 X 4		
F 99-04	PICKUP, F-550 SUPERDUTY 4 X 4		
6855SE	D		143154
F 99-04	FORD PICKUP 1 TON, F-350 / SUPERDUTY 4WD Replacement Kit		
F 99-04	PICKUP 3/4 TON, F-250 / SUPERDUTY 4WD Replacement Kit		
6856SE	W		143156,143077
F 05-07	FORD PICKUP 3/4 TON, F-250 / SUPERDUTY 4WD Exc. OE Unit		
6861SE	W		143160
F 97-02	FORD EXPEDITION 4WD, Torsion Bar (FrontSpringType)		
F 98-03	LOBO 4WD		
F 97-03	PICKUP 1/2 TON, F-150 4WD		
F 97-99	PICKUP 3/4 TON, F-250 / SUPERDUTY 4WD, Torsion Bar (FrontSpringType)		

Axle Shaft Damper

14039	A		
F 84-04	FORD MUSTANG / MUSTANG II All Position Rear		
F 84-88	THUNDERBIRD All Position Rear		
F 84-86	MERCURY CAPRI All Position Rear		
F 84-88	COUGAR All Position Rear		

Steering Dampers

14004	C		
F 59-77	VOLKSWAGEN BEETLE All		
F 73-74	THING All		
14005	B		
F 71-75	VOLKSWAGEN SUPER BEETLE All		
14017	B		142387
F 87-91	CHEVROLET BLAZER 4WD		
F 75-86	BLAZER All		
F 73-86	PICKUP 1/2 TON, K10 All		
F 87	PICKUP 1/2 TON, V10 All		
F 77-86	PICKUP 1 TON, K30 All		
F 73-74	PICKUP 1 TON, K30 All		
F 89-91	PICKUP 1 TON, R3500 All		
F 87-88	PICKUP 1 TON, V30 All		
F 89-91	PICKUP 1 TON, V3000 / V3500 All		
F 73-86	PICKUP 3/4 TON, K20 All		
F 87	PICKUP 3/4 TON, V20 All		
F 73-86	SUBURBAN 1/2 TON, K10 All		
F 87-88	SUBURBAN 1/2 TON, R10 All		
F 73-86	SUBURBAN 3/4 TON, K20 All		
F 87-88	SUBURBAN 3/4 TON, V20 All		
F 89-91	SUBURBAN 3/4 TON, V2500 All		
F 73-91	GMC JIMMY All Replacement damper for vehicles w/ OE stabilizer		
F 73-86	PICKUP 1/2 TON, K15 / K1500 All		
F 87	PICKUP 1/2 TON, V1500 All		
F 77-86	PICKUP 1 TON, K35 / K3500 All		
F 73-74	PICKUP 1 TON, K35 / K3500 All		
F 87-91	PICKUP 1 TON, V3000 / V3500 All		

Shock	POP	Alternative No.	MTG Acc. Supplied
Pos.	Year	Application	
14017	B	(cont)	142387
F 73-86	PICKUP 3/4 TON, K25 / K2500 All		
F 87	PICKUP 3/4 TON, V2500 All		
F 73-86	SUBURBAN 1/2 TON, K15 / K1500 All		
F 87-91	SUBURBAN 1/2 TON, V1500 All		
F 73-86	SUBURBAN 3/4 TON, K25 / K2500 All		
F 87-91	SUBURBAN 3/4 TON, V2500 All		
14018	A		141264
F 76-79	CADILLAC SEVILLE All		
14040	A		500498
F 84-01	JEEP CHEROKEE All		
F 86-92	COMANCHE All		
F 11-18	WRANGLER All w/o Dust Boot		
F 06-10	WRANGLER All		
14071	D		
F 99-04	JEEP GRAND CHEROKEE All Single System Steering Damper		
14072	D		
F 08-22	FORD PICKUP 1 TON, F-350 / SUPERDUTY 4WD		
F 08-22	PICKUP 3/4 TON, F-250 / SUPERDUTY 4WD		
F 08-22	PICKUP, F-450 SUPERDUTY 4 X 4		
F 08-22	PICKUP, F-550 SUPERDUTY 4 X 4		
14074	B		
F 07-18	JEEP WRANGLER 4WD w/ Dust Boot		

Front Load Carrier

34036	A		140357
F 75-84	CHEVROLET BLAZER RWD		
F 69-74	BLAZER All RWD		
F 63-86	PICKUP 1/2 TON, C10 All		
F 87	PICKUP 1/2 TON, R10 All		
F 63-86	PICKUP 1 TON, C30 All		
F 88-91	PICKUP 1 TON, C35/3500 Cab & Chassis Exc. HD Solid Front Axle		
F 87-88	PICKUP 1 TON, R30 All		
F 89	PICKUP 1 TON, R3500 Standard Cab Pickup		
F 75-86	PICKUP 3/4 TON, C20 Crew Cab Pickup		
F 75-86	PICKUP 3/4 TON, C20 Standard Cab Pickup		
F 63-74	PICKUP 3/4 TON, C20 All		
F 87-88	PICKUP 3/4 TON, R20 Crew Cab Pickup		
F 89	PICKUP 3/4 TON, R2500 All		
F 63-66	SUBURBAN 1/2 TON, 1500 All		
F 67-86	SUBURBAN 1/2 TON, C10 All		
F 87-88	SUBURBAN 1/2 TON, R10 All		
F 89-91	SUBURBAN 1/2 TON, R1500 All		
F 67-86	SUBURBAN 3/4 TON, C20 All		
F 87-88	SUBURBAN 3/4 TON, R20 All		
F 89-91	SUBURBAN 3/4 TON, R2500 All		
F 63-80	VAN 1/2 TON, P SERIES All		
F 73-90	VAN 1 TON, P SERIES All Cutaway Chassis		
F 68-72	VAN 1 TON, P SERIES All		
F 68-89	VAN 3/4 TON, P SERIES All		
F 75-84	GMC JIMMY RWD		
F 70-74	JIMMY All RWD		
F 67-86	PICKUP 1/2 TON, C15 / C1500 All		
F 87	PICKUP 1/2 TON, R1500 All		
F 88-91	PICKUP 1 TON, C35/3500 Cab & Chassis HD Solid Front Axle		
F 67-78	PICKUP 1 TON, C35/3500 All		
F 87-91	PICKUP 1 TON, R3500 All		
F 75-86	PICKUP 3/4 TON, C25 / C2500 Cab & Chassis		
F 75-86	PICKUP 3/4 TON, C25 / C2500 Crew Cab Pickup		
F 75-86	PICKUP 3/4 TON, C25 / C2500 Standard Cab Pickup		
F 67-74	PICKUP 3/4 TON, C25 / C2500 All		
F 87-89	PICKUP 3/4 TON, R2500 All Exc. Crew Cab & Bonus Cab		
F 63-65	PICKUP 1000 SERIES All		
F 63-65	PICKUP 1500 SERIES All		
F 68-86	SUBURBAN 1/2 TON, C15 / C1500 All		
F 87-91	SUBURBAN 1/2 TON, R1500 All		
F 68-86	SUBURBAN 3/4 TON, C25 / C2500 All		
F 87-91	SUBURBAN 3/4 TON, R2500 All		
F 67-80	VAN 1/2 TON, P SERIES All		
F 74-90	VAN 1 TON, P SERIES All Cutaway Chassis		

Numerical listing

Shock	POP	Alternative No.	MTG Acc. Supplied
Pos.	Year	Application	
34036	A	(cont)	140357
F 73	VAN 1 TON, P SERIES Base Cutaway Chassis		
F 68-72	VAN 1 TON, P SERIES All		
F 68-89	VAN 3/4 TON, P SERIES All		
F 63-65	VAN, PB 1000 SERIES All		
34051	A		140455
F 73-75	BUICK APOLLO All		
F 73-81	CENTURY All		
F 73-87	REGAL All		
F 75-79	SKYLARK All		
F 69-72	SKYLARK All		
F 68	SKYLARK All Heavy Duty Suspension		
F 68-69	SPECIAL All		
F 68-72	SPORTWAGON All		
F 76-79	CADILLAC SEVILLE All		
F 05	CHEVROLET BLAZER Base, RWD		
F 96-04	BLAZER LS, RWD		
F 95-02	BLAZER LT, RWD		
F 95-99	BLAZER Base, RWD		
F 95-97	BLAZER Deluxe, RWD		
F 83-94	BLAZER, S MODELS RWD		
F 67-69	CAMARO All		
F 68-73	CHEVELLE All		
F 68-87	EL CAMINO All		
F 73-83	MALIBU All		
F 70-88	MONTE CARLO All		
F 69-79	NOVA All		
F 94-03	S10 LS, RWD		
F 83-03	S10 Base, RWD		
F 92-93	S10 EL, RWD		
F 83-92	S10 Tahoe, RWD		
F 88-90	S10 Durango, RWD		
F 83-86	S10 Durango, RWD		
F 82	S10 Base		
F 82	S10 Durango		
F 92-04	GMC JIMMY RWD		
F 83-91	S15 JIMMY RWD		
F 04	SONOMA / S15 All RWD		
F 83-03	SONOMA / S15 RWD		
F 82	SONOMA / S15 All		
F 71-87	SPRINT / CABALLERO All		
F 98-00	ISUZU HOMBRE RWD Exc. Sport Chassis		
F 96-97	HOMBRE All Exc. Sport Chassis		
F 68-87	OLDSMOBILE CUTLASS / CUTLASS SUPREME All		
F 80-83	CUTLASS CLASSIC / CUTLASS CRUISER All		
F 78-79	OMEGA All		
F 82-86	PONTIAC BONNEVILLE All		
F 67-69	FIREBIRD All		
F 78-80	GRAND AM All		
F 73-75	GRAND AM All		
F 75-83	GRAND LEMANS All		
F 69-87	GRAND PRIX All		
F 71-75	GRANDVILLE All		
F 68-81	LEMANS All		
F 77-79	PHOENIX All		
F 73-77	VENTURA All		
F 75-83	TOYOTA PICKUP RWD		
34052	B		140126
F 84-86	DODGE MINI RAM All		
F 72-93	PICKUP 1/2 TON, D100 SERIES All		
F 06-08	PICKUP 1/2 TON, RAM 1500 (SEE RAM 1500) RWD Exc. Mega Cab		
F 02-05	PICKUP 1/2 TON, RAM 1500 (SEE RAM 1500) RWD		
F 72-93	PICKUP 3/4 TON, D200 SERIES All Exc. Heavy Duty Package		
F 75-93	RAMCHARGER RWD		
F 99-03	VAN 1/2 TON, A / B SERIES / RAM 109.3 / 277.6 (WheelBase) Exc. 7000# GVW		
F 82-98	VAN 1/2 TON, A / B SERIES / RAM 109.6 / 278.4 (WheelBase) Exc. 7000# GVW		
F 71-80	VAN 1/2 TON, A / B SERIES / RAM All		
F 99-03	VAN 1 TON, A / B SERIES / RAM All		
F 71-98	VAN 1 TON, A / B SERIES / RAM All Exc. 4000# Front Axle		
F 71-03	VAN 3/4 TON, A / B SERIES / RAM All		
F 78-80	VAN, CB300 All Exc. 4000# Front Axle		
F 74-77	VAN, CB300 All Up through 8300# GVW		
F 81	PLYMOUTH TRAILDUSTER All		
F 75-80	TRAILDUSTER RWD		
F 74-83	VAN 1/2 TON, PB SERIES All		

Numerical listing

Shock	POP	Alternative No.	MTG Acc. Supplied
Pos.	Year	Application	
34052		B (cont)	140126
F	74-83	VAN 1 TON, PB SERIES All Exc. 4000# Front Axle	
F	74-83	VAN 3/4 TON, PB SERIES All	
34057		A	140780
F	80-96	FORD BRONCO All Rearward of Front Axle; Exc. Lift Kit	
F	89	BRONCO II All Mfg. to 2/89; Vehicles w/ 10mm & 12mm bolt in rear lower mount	
F	84-88	BRONCO II All w/ 10mm Bolt In Rear Lower Mount	
F	80-83	PICKUP 1/2 TON, F-100 RWD	
F	80-96	PICKUP 1/2 TON, F-150 4WD Rearward of Front Axle; Exc. Lift Kit	
F	80-96	PICKUP 1/2 TON, F-150 RWD	
F	87-89	RANGER All Exc. High Ryder Option	
F	83-86	RANGER All	
34058		B	140780
F	66-77	FORD BRONCO All From Serial #830001; Exc. Lift Kit RWD, 4WD Quad Suspension Rearward of Front Axle	
F	65-79	PICKUP 1/2 TON, F-100 All Quad Suspension Rearward of Front Axle	
F	75-79	PICKUP 1/2 TON, F-150 All Quad Suspension Rearward of Front Axle	
F	73-79	PICKUP 1 TON, F-350 / SUPERDUTY All Quad Suspension Rearward of Front Axle	
F	70-79	PICKUP 3/4 TON, F-250 / SUPERDUTY All Quad Suspension Rearward of Front Axle	
F	77-91	VAN 1 TON, ECONOLINE / CLUB WAGON / SUPERDUTY All RWD, 4WD Quad Suspension Rearward of Front Axle	
F	75-91	VAN 1 TON, ECONOLINE / CLUB WAGON / SUPERDUTY All Exc. Cutaway Chassis RWD, 4WD Quad Suspension Rearward of Front Axle	
F	75-91	VAN 3/4 TON, ECONOLINE / CLUB WAGON / SUPERDUTY All RWD, 4WD Quad Suspension Rearward of Front Axle	
34073		A	141041
F	71-73	BUICK CENTURION All	
F	91-96	COMMERCIAL CHASSIS All	
F	85-89	ELECTRA Estate Wagon	
F	71-84	ELECTRA All	
F	71-83	ESTATE WAGON All	
F	88-89	LESABRE All	
F	71-85	LESABRE All	
F	71-78	RIVIERA All	
F	91-96	ROADMASTER All	
F	87-92	CADILLAC BROUGHAM All	
F	92-96	COMMERCIAL CHASSIS RWD	
F	77-84	COMMERCIAL CHASSIS All	
F	77-84	DEVILLE All	
F	93-96	FLEETWOOD All	
F	85-86	FLEETWOOD RWD	
F	77-84	FLEETWOOD All	
F	81	CHEVROLET BEL AIR Sedan Exc. Police and Taxi Models	
F	65-75	BEL AIR Sedan Exc. Police and Taxi Models	
F	65-72	BISCAYNE All	
F	69-72	BROOKWOOD All	
F	70-81	CAMARO All	
F	66-96	CAPRICE All	
F	94-96	IMPALA All	
F	65-85	IMPALA All	
F	69-72	KINGSWOOD All	
F	88-99	PICKUP 1/2 TON, C15 / C1500 All	
F	92-00	PICKUP 1 TON, C35/3500 All Exc. Straight Front Axle	
F	88-91	PICKUP 1 TON, C35/3500 Extended Cab Pickup Exc. Straight Front Axle	
F	88-91	PICKUP 1 TON, C35/3500 Standard Cab Pickup Exc. Straight Front Axle	
F	88-00	PICKUP 3/4 TON, C25 / C2500 All	
F	92-99	SUBURBAN 1/2 TON, C15 / C1500 All	
F	92-99	SUBURBAN 3/4 TON, C25 / C2500 All	
F	96-00	TAHOE RWD Old Body Style	
F	95	TAHOE RWD	
F	69-72	TOWNSMAN All	
F	96-02	VAN 1/2 TON, G / EXPRESS All Exc. 8600# GVW	

Front Load Carrier, Rear Load Carrier

Shock	POP	Alternative No.	MTG Acc. Supplied
Pos.	Year	Application	
34073		A (cont)	141041
F	96-02	VAN 1 TON, G / EXPRESS All Exc. 8600# GVW	
F	96-02	VAN 3/4 TON, G / EXPRESS All Exc. 8600# GVW	
F	65-74	FORD COUNTRY SEDAN All	
F	87-91	COUNTRY SQUIRE All	
F	65-74	COUNTRY SQUIRE All	
F	92-02	CROWN VICTORIA All Exc. Hydraulic Self-Leveling System	
F	65-72	CUSTOM All	
F	68-77	CUSTOM 500 All	
F	65-67	GALAXIE All	
F	68-74	GALAXIE 500 All	
F	01-02	GRAND MARQUIS All	
F	87-91	LTD / COUNTRY SEDAN / COUNTRY SQUIRE / CROWN VICTORIA All	
F	67-82	LTD / COUNTRY SEDAN / COUNTRY SQUIRE / CROWN VICTORIA All	
F	77-79	LTD II All	
F	72-79	RANCHERO All	
F	65-74	RANCH WAGON All	
F	67-79	THUNDERBIRD All	
F	72-76	TORINO All	
F	88-99	GMC PICKUP 1/2 TON, C15 / C1500 All	
F	88-00	PICKUP 1 TON, C35/3500 All	
F	88-00	PICKUP 3/4 TON, C25 / C2500 All	
F	92-99	SUBURBAN 1/2 TON, C15 / C1500 All	
F	92-99	SUBURBAN 3/4 TON, C25 / C2500 All	
F	96-02	VAN 1/2 TON, G / SAVANA All Exc. 8600# GVW	
F	96-02	VAN 1 TON, G / SAVANA All Exc. 8600# GVW	
F	96-02	VAN 3/4 TON, G / SAVANA All Exc. 8600# GVW	
F	92-99	YUKON RWD	
F	70-80	LINCOLN CONTINENTAL All	
F	68-71	MARK III All	
F	72-76	MARK IV All	
F	77-79	MARK V All	
F	80-83	MARK VI All	
F	81-02	TOWN CAR All	
F	67	MERCURY BROUGHAM All	
F	87-91	COLONY PARK All	
F	65-74	COLONY PARK All	
F	65-68	COMMUTER All	
F	74-79	COUGAR All	
F	92-02	GRAND MARQUIS All Exc. Hydraulic Self-Leveling System	
F	75-91	GRAND MARQUIS All	
F	69-70	MARAUDER All	
F	65-67	MARAUDER All	
F	67-82	MARQUIS All	
F	65-68	MONTCLAIR All	
F	72-76	MONTEGO All	
F	65-74	MONTEREY All	
F	65-68	PARKLANE All	
F	65-67	VILLAGER All	
F	66-67	VOYAGER All	
F	71-85	OLDSMOBILE 88 SERIES All	
F	71-84	98 All	
F	71-92	CUSTOM CRUISER All	
F	71-81	PONTIAC BONNEVILLE All	
F	71-81	CATALINA All	
F	70-81	FIREBIRD All	
F	71-78	GRAND SAFARI All	
F	76-81	LAURENTIAN All	
F	76-86	PARISIENNE All	
F	87-89	SAFARI All	
34076		B	140780
F	91-94	FORD EXPLORER All	
F	90-97	RANGER All	
F	92-14	VAN 1/2 TON, ECONOLINE / CLUB WAGON All	
F	92-19	VAN 1 TON, ECONOLINE / CLUB WAGON / SUPERDUTY All	
F	92-14	VAN 3/4 TON, ECONOLINE / CLUB WAGON / SUPERDUTY All	
F	94-97	MAZDA B2300 All	
F	94-97	B3000 All	
F	94-97	B4000 All	
F	91-94	NAVAJO All	
Rear Load Carrier			
43048		A	
R	75-80	CHEVROLET LUV PICKUP All	
R	72-74	LUV PICKUP All	
F	55-56	PICKUP 3800	
F	55	PICKUP 3100	

Numerical listing

Shock	POP	Alternative No.	MTG Acc. Supplied
Pos.	Year	Application	
43048		A (cont)	
R	75-80	DODGE COLT Wagon	
R	71-74	COLT All	
R	79-82	D50 RWD	
R	87-93	PICKUP, RAM 50 RWD	
R	83-86	PICKUP, RAM 50 All	
R	61-64	FORD PICKUP 1/2 TON, F-100 All	
R	61-66	PICKUP 1 TON, F-350 / SUPERDUTY All	
R	61-64	PICKUP 3/4 TON, F-250 / SUPERDUTY All	
F	68-76	PICKUP P350 All Up through 8000# GVW	
F	75-76	PICKUP P400 All Up through 8000# GVW	
R	68	INTERNATIONAL 908C All	
R	68	1000C All	
F	68	1100C All Exc. 166" Wheelbase	
R	68	1100C All Exc. 166" Wheelbase	
F	68	1200C All Exc. 166" Wheelbase	
R	68	1200C All Exc. 166" Wheelbase	
F	68	1300C All Exc. 166" Wheelbase	
R	68	1300C All Exc. 166" Wheelbase	
R	68-72	M1100 / M1200 All	
R	69	M1400 All	
R	72-83	JEEP CJ5 All Exc. Lift Kit	
R	66-71	CJ5 All	
R	72-75	CJ6 All Exc. Lift Kit	
R	66-71	CJ6 All	
R	76-86	CJ7 All Exc. Lift Kit	
R	66-74	DJ5 All Exc. Lift Kit	
R	66-68	DJ6 All	
R	57-60	FC150 All	
F	63-65	FC170 All	
R	63-65	FC170 All	
R	63-66	GLADIATOR All Independent Front Suspension	
R	70-71	JEEPSTER All	
R	81-85	SCRAMBLER / CJ8 All	
R	61-67	UNIVERSAL All	
R	86-87	MAZDA B2000 RWD	
R	87-93	B2200 RWD	
R	87-93	B2600 RWD	
R	95-96	MITSUBISHI MIGHTY MAX All	
R	83-94	MIGHTY MAX RWD	
R	87-90	VAN All	
R	98-04	NISSAN FRONTIER RWD Exc. Desert Runner	
R	87-97	PICKUP RWD	
R	86	PICKUP RWD Mfg. from 8/86	
R	76-80	PLYMOUTH COLT All	
R	79-82	PICKUP All	
R	84-95	TOYOTA PICKUP RWD	
R	75-83	PICKUP RWD Mojave	
R	70-74	PICKUP All RWD	
R	84-88	VAN Leaf (RearSpringType)	
R	88	VAN WAGON All	
43049		A	140630
R	71-73	BUICK CENTURION All	
R	92-96	COMMERCIAL CHASSIS All	
R	71-84	ELECTRA All	
R	71-85	LESABRE All	
R	71-78	RIVIERA All	
R	92-96	ROADMASTER Sedan	
R	64-67	SKYLARK All Exc. Heavy Duty Suspension	
R	64-67	SPECIAL All Exc. Heavy Duty Suspension	
R	87-92	CADILLAC BROUGHAM All	
R	92-96	COMMERCIAL CHASSIS RWD	
R	77-84	COMMERCIAL CHASSIS All	
R	77-84	DEVILLE All	
R	93-96	FLEETWOOD RWD	
R	77-86	FLEETWOOD RWD	
R	81	CHEVROLET BEL AIR Sedan	
R	75	BEL AIR Sedan	
R	65-74	BEL AIR All	
R	65-72	BISCAYNE All	
R	69-70	BROOKWOOD All	
R	81-96	CAPRICE Sedan Police and Taxi Models	
R	76-80	CAPRICE Sedan Exc. Wagon	
R	75-80	CAPRICE Coupe Exc. Wagon	
R	75	CAPRICE Convertible Exc. Wagon	
R	75	CAPRICE Sedan	
R	73-74	CAPRICE Sedan Police and Taxi Models	
R	71-72	CAPRICE All Police and Taxi Models	
R	66-70	CAPRICE All	
R	64-67	CHEVELLE All Exc. Heavy Duty Suspension	
R	68	CHEVY II All	
R	64-67	EL CAMINO All	
R	94-96	IMPALA All	

Numerical listing

Shock	POP	Alternative No.	MTG Acc. Supplied
Pos.	Year	Application	
43049		A (cont)	140630
R	83-85	IMPALA All	
R	65-82	IMPALA Sedan	
R	74-81	IMPALA Coupe	
R	73	IMPALA Hardtop	
R	69-70	KINGSWOOD All	
R	64-67	MALIBU All Exc. Heavy Duty Suspension	
R	69-72	NOVA All	
R	69-70	TOWNSMAN All	
R	65-85	OLDSMOBILE 88 SERIES All	
R	71-84	98 All	
R	64-67	CUTLASS / CUTLASS SUPREME All Exc. Heavy Duty Suspension	
R	64-67	F85 All Exc. Heavy Duty Suspension	
R	65-66	STARFIRE All	
R	63-81	PONTIAC BONNEVILLE All	
R	75-81	CATALINA Coupe	
R	71-81	CATALINA Sedan	
R	71-74	CATALINA Hardtop	
R	63-70	CATALINA All	
R	67-70	EXECUTIVE All	
R	64-67	GTO All Exc. Heavy Duty Suspension	
R	76-81	LAURENTIAN All	
R	64-67	LEMANS All Exc. Heavy Duty Suspension	
R	76-86	PARISIENNE Sedan	
R	64-67	TEMPEST All Exc. Heavy Duty Suspension	
R	71-72	VENTURA All	
43058		C	140739
R	78-79	FORD BRONCO All Exc. Lift Kit	
R	66-77	BRONCO All From Serial #830001; Exc. Lift Kit	
R	65-69	PICKUP 1/2 TON, F-100 All RWD	
R	75-79	PICKUP 1 TON, F-350 / SUPERDUTY Standard Cab Pickup, RWD	
R	73-74	PICKUP 1 TON, F-350 / SUPERDUTY Standard Cab Pickup RWD	
R	75-79	PICKUP 3/4 TON, F-250 / SUPERDUTY Cab & Chassis, RWD	
R	75-79	PICKUP 3/4 TON, F-250 / SUPERDUTY Extended Cab Pickup, RWD	
R	73-74	PICKUP 3/4 TON, F-250 / SUPERDUTY RWD	
R	65-72	PICKUP 3/4 TON, F-250 / SUPERDUTY All RWD	
R	69-74	VAN 1/2 TON, ECONOLINE / CLUB WAGON All	
R	69-74	VAN 1 TON, ECONOLINE / CLUB WAGON / SUPERDUTY All	
R	69-74	VAN 3/4 TON, ECONOLINE / CLUB WAGON / SUPERDUTY All	
R	76-83	JEEP CHEROKEE All	
F	74-83	CHEROKEE All	
F	82-83	CJ5 All	
F	82-86	CJ7 All	
F	67	GLADIATOR All	
F	93	GRAND WAGONEER All	
R	93	GRAND WAGONEER All	
F	84-91	GRAND WAGONEER All	
R	84-91	GRAND WAGONEER All	
F	74-88	J10 PICKUP All	
R	74-88	J10 PICKUP All	
F	74-88	J20 PICKUP All	
R	74-88	J20 PICKUP All	
R	68-73	J2500 PICKUP All	
R	76-83	WAGONEER All	
F	74-83	WAGONEER All	
43060		A	140630
R	73-81	BUICK CENTURY All	
R	71-83	ESTATE WAGON All	
R	65-67	GRAN SPORT All	
R	68-72	GS / GS350 / GS400 / GS455 All	
R	73-87	REGAL All	
R	91-96	ROADMASTER Wagon	
R	68-72	SKYLARK All	
R	64-67	SKYLARK All Heavy Duty Suspension	
R	68-69	SPECIAL All	
R	64-67	SPECIAL All Heavy Duty Suspension	
R	70-72	SPORTWAGON All	
R	77-96	CHEVROLET CAPRICE Wagon	
R	68-73	CHEVELLE All	
R	64-67	CHEVELLE All Heavy Duty Suspension	
R	68-87	EL CAMINO All	

Rear Load Carrier

Shock	POP	Alternative No.	MTG Acc. Supplied
Pos.	Year	Application	
43060		A (cont)	140630
R	71-82	IMPALA Wagon	
R	73-83	MALIBU All	
R	64-67	MALIBU All Heavy Duty Suspension	
R	70-88	MONTE CARLO All	
R	78-87	GMC SPRINT / CABALLERO RWD	
R	71-77	SPRINT / CABALLERO All	
R	74-77	NISSAN 710 Wagon	
R	78-80	810 Wagon	
R	77-92	OLDSMOBILE CUSTOM CRUISER All	
R	68-87	CUTLASS / CUTLASS SUPREME All	
R	64-67	CUTLASS / CUTLASS SUPREME All Heavy Duty Suspension	
R	80-83	CUTLASS CLASSIC / CUTLASS CRUISER All	
R	68-72	F85 All	
R	64-67	F85 All Heavy Duty Suspension	
R	71-78	TORONADO All	
R	82-86	PONTIAC BONNEVILLE All	
R	78-80	GRAND AM All	
R	73-75	GRAND AM All	
R	75-83	GRAND LEMANS All	
R	69-87	GRAND PRIX All	
R	71-78	GRAND SAFARI All	
R	71-75	GRANDVILLE All	
R	68-73	GTO All	
R	64-67	GTO All Heavy Duty Suspension	
R	68-81	LEMANS All	
R	64-67	LEMANS All Heavy Duty Suspension	
R	80-86	PARISIENNE Wagon	
R	76-79	PARISIENNE All Wagon	
R	87-89	SAFARI All	
R	68-70	TEMPEST All	
R	64-67	TEMPEST All Heavy Duty Suspension	
43085		D	140724
R	84-86	DODGE MINI RAM All	
R	99-03	VAN 1/2 TON, A / B SERIES / RAM 109.3 / 277.6 (WheelBase) Exc. 7000# GVW	
R	81-98	VAN 1/2 TON, A / B SERIES / RAM 109.6 / 278.4 (WheelBase) Exc. 7000# GVW	
R	71-80	VAN 1/2 TON, A / B SERIES / RAM All	
R	99-03	VAN 1 TON, A / B SERIES / RAM All	
R	95-98	VAN 1 TON, A / B SERIES / RAM All Exc. 4000# Front Axle	
R	71-94	VAN 1 TON, A / B SERIES / RAM All	
R	71-03	VAN 3/4 TON, A / B SERIES / RAM All	
R	74-80	VAN, CB300 All	
R	74-83	PLYMOUTH WAGON 1/2 TON, PB SERIES All	
R	74-83	VAN 1 TON, PB SERIES All	
R	74-83	VAN 3/4 TON, PB SERIES All	
43099		A	140126
R	62-67	CHEVROLET CHEVY II All	
R	66	FORD BRONCO All Thru Serial #830000	
R	75-79	PICKUP 1/2 TON, F-100 RWD	
R	70-74	PICKUP 1/2 TON, F-100 All Exc. Supercab	
R	75-79	PICKUP 1/2 TON, F-150 Standard Cab Pickup, RWD	
R	75-79	PICKUP 1 TON, F-350 / SUPERDUTY Cab & Chassis, RWD	
R	75-79	PICKUP 1 TON, F-350 / SUPERDUTY Extended Cab Pickup, RWD	
R	74	PICKUP 1 TON, F-350 / SUPERDUTY RWD Supercab	
R	75-79	PICKUP 3/4 TON, F-250 / SUPERDUTY Standard Cab Pickup, RWD	
R	73-74	PICKUP 3/4 TON, F-250 / SUPERDUTY RWD Standard Cab Pickup	
R	70-72	PICKUP 3/4 TON, F-250 / SUPERDUTY All RWD; Standard Cab Pickup	
R	75-91	VAN 1/2 TON, ECONOLINE / CLUB WAGON All	
F	71-80	INTERNATIONAL SCOUT II All	
43111		C	140702
R	87-91	CHEVROLET BLAZER 4WD Full Size; Exc. Lift Kit	
R	85-86	BLAZER 4WD Exc. Lift Kit	
R	73-84	BLAZER All Exc. Lift Kit	

Numerical listing

Shock	POP	Alternative No.	MTG Acc. Supplied
Pos.	Year	Application	
43111		C (cont)	140702
R	73-86	PICKUP 1/2 TON, C10 All	
R	73-86	PICKUP 1/2 TON, K10 All Exc. Lift Kit	
R	87	PICKUP 1/2 TON, R10 All	
R	87	PICKUP 1/2 TON, V10 All Exc. Lift Kit	
R	75-86	PICKUP 3/4 TON, C20 Standard Cab Pickup	
R	73-74	PICKUP 3/4 TON, C20 All Standard Cab Pickup	
R	73-86	PICKUP 3/4 TON, K20 All Exc. Lift Kit	
R	87	PICKUP 3/4 TON, R20 Standard Cab Pickup	
R	87	PICKUP 3/4 TON, V20 All Exc. Quad Suspension and Lift Kit	
R	73-86	SUBURBAN 1/2 TON, C10 All	
R	73-86	SUBURBAN 1/2 TON, K10 All Exc. Lift Kit	
R	87-88	SUBURBAN 1/2 TON, R10 All	
R	89-91	SUBURBAN 1/2 TON, R1500 All	
R	89-91	SUBURBAN 1/2 TON, V1500 All Exc. Lift Kit	
R	73-86	SUBURBAN 3/4 TON, C20 All	
R	73-86	SUBURBAN 3/4 TON, K20 All Exc. Lift Kit	
R	87-88	SUBURBAN 3/4 TON, R20 All	
R	89-91	SUBURBAN 3/4 TON, R2500 All	
R	87-88	SUBURBAN 3/4 TON, V20 All Exc. Quad Suspension and Lift Kit	
R	89-91	SUBURBAN 3/4 TON, V2500 All Exc. Lift Kit	
R	73	VAN 1/2 TON, P SERIES All	
R	73-78	VAN 3/4 TON, P SERIES All	
R	73-91	GMC JIMMY All Exc. Lift Kit	
R	73-86	PICKUP 1/2 TON, C15 / C1500 All	
R	79-86	PICKUP 1/2 TON, K15 / K1500 All Exc. Lift Kit	
R	78	PICKUP 1/2 TON, K15 / K1500 All Exc. Quad Suspension and Lift Kit	
R	75-77	PICKUP 1/2 TON, K15 / K1500 All Exc. Lift Kit	
R	87	PICKUP 1/2 TON, R1500 All	
R	87	PICKUP 1/2 TON, V1500 All Exc. Lift Kit	
R	75-86	PICKUP 3/4 TON, C25 / C2500 Cab & Chassis	
R	75-86	PICKUP 3/4 TON, C25 / C2500 Standard Cab Pickup	
R	73-74	PICKUP 3/4 TON, C25 / C2500 All	
R	73-86	PICKUP 3/4 TON, K25 / K2500 All Exc. Lift Kit	
R	88-89	PICKUP 3/4 TON, R2500 All Exc. Crew Cab & Bonus Cab	
R	87	PICKUP 3/4 TON, R2500 Cab & Chassis Exc. Crew Cab & Bonus Cab	
R	87	PICKUP 3/4 TON, R2500 Standard Cab Pickup Exc. Crew Cab & Bonus Cab	
R	87	PICKUP 3/4 TON, V2500 All Exc. Lift Kit	
R	73-86	SUBURBAN 1/2 TON, C15 / C1500 All	
R	73-86	SUBURBAN 1/2 TON, K15 / K1500 All Exc. Lift Kit	
R	87-91	SUBURBAN 1/2 TON, R1500 All	
R	87-91	SUBURBAN 1/2 TON, V1500 All Exc. Lift Kit	
R	73-86	SUBURBAN 3/4 TON, C25 / C2500 All	
R	73-86	SUBURBAN 3/4 TON, K25 / K2500 All Exc. Lift Kit	
R	87-91	SUBURBAN 3/4 TON, R2500 All	
R	87-91	SUBURBAN 3/4 TON, V2500 All Exc. Lift Kit	
R	73	VAN 1/2 TON, P SERIES All	
R	73-78	VAN 3/4 TON, P SERIES All	
43140		A	141150
R	67-74	AMERICAN MOTORS AMBASSADOR All	
R	59-68	AMERICAN All	
R	68-70	AMX All	
R	80-88	EAGLE All	
R	68-74	JAVELIN All	
R	67	MARLIN All	
R	71-78	MATADOR All	
R	69	RAMBLER All	
R	59-60	RAMBLER All	
R	59-60	BUICK ELECTRA All Exc. Air Suspension	
R	59-60	INVICTA All Exc. Air Suspension	
R	60	LESABRE All	

Numerical listing

Shock	POP	Alternative No.	MTG Acc. Supplied
Pos.	Year	Application	
43140	A (cont)		141150
R	59	LESABRE All Exc.	Air Suspension
R	61-63	SKYLARK All	
R	61-63	SPECIAL All	
R	64-69	SPORTWAGON All	
R	51-54	CHEVROLET BEL AIR All	
R	50	BEL AIR All Exc.	Air Suspension
R	67-69	CAMARO All Multi-Leaf Springs	
R	76-87	CHEVETTE All	
R	60-62	CORVETTE All	
R	53-54	ONE-FIFTY SERIES All	
R	55-58	PICKUP 3800	
R	54	PICKUP All	
R	49-52	STYLELINE DELUXE All	
R	49-52	STYLELINE SPECIAL All	
R	53-54	TWO-TEN SERIES All	
R	61-62	VAN 1 TON, P SERIES All	
R	61-62	VAN 3/4 TON, P SERIES All	
R	66-67	FIAT 1100 All Exc.	Wagon
R	64-67	1500 All Exc.	Wagon
R	65-74	FORD COUNTRY SEDAN All	
R	87-91	COUNTRY SQUIRE All	
R	65-74	COUNTRY SQUIRE All	
R	94-02	CROWN VICTORIA All	
R	93	CROWN VICTORIA All Exc.	Hydraulic Self-Leveling System
R	92	CROWN VICTORIA All	
R	65-72	CUSTOM All	
R	68-77	CUSTOM 500 All	
R	75-76	ELITE All	
R	66-70	FALCON All Wagon	
R	65-67	GALAXIE All	
R	68-74	GALAXIE 500 All	
R	01-02	GRAND MARQUIS All	
R	87-91	LTD / COUNTRY SEDAN / COUNTRY SQUIRE / CROWN VICTORIA All	
R	67-82	LTD / COUNTRY SEDAN / COUNTRY SQUIRE / CROWN VICTORIA All	
R	77-79	LTD II All	
R	72-79	RANCHERO All	
R	65-74	RANCH WAGON All	
R	77-79	THUNDERBIRD All	
R	67-72	THUNDERBIRD All	
R	72-76	TORINO All	
R	53-54	GMC PICKUP All 1/2 and 3/4 Ton	
R	83-89	ISUZU IMPULSE All	
R	70-80	LINCOLN CONTINENTAL All	
R	68-71	MARK III All	
R	72	MARK IV All	
R	80-83	MARK VI All	
R	81-02	TOWN CAR All	
R	67	MERCURY BROUGHAM All	
R	87-91	COLONY PARK All	
R	65-74	COLONY PARK All	
R	66-67	COMET Wagon	
R	65-68	COMMUTER All	
R	74-79	COUGAR All	
R	75-02	GRAND MARQUIS All	
R	69-70	MARAUDER All	
R	65-67	MARAUDER All	
R	67-82	MARQUIS All	
R	65-68	MONTECLAIR All	
R	72-76	MONTEGO All	
R	65-74	MONTEREY All	
R	65-68	PARKLANE All	
R	65-67	VILLAGER All	
R	66-67	VOYAGER All	
R	64-65	NISSAN 410 All	
R	64-67	411 All	
R	72	510 All	
R	74-77	710 All	
R	64-72	OLDSMOBILE VISTA CRUISER All	
R	76-87	PONTIAC ACADIAN All	
R	67-69	FIREBIRD All Multi-Leaf Springs	
R	81-87	T1000 All	
R	72-81	TOYOTA COROLLA All	
R	68-73	CORONA All	
R	79-80	CRESSIDA Wagon	
R	69-79	LAND CRUISER All	
43162	A		
R	05	CHEVROLET BLAZER Base, 4WD	
R	05	BLAZER Base, RWD	
R	96-04	BLAZER LS, 4WD	
R	96-04	BLAZER LS, RWD	
R	95-02	BLAZER LT, RWD	
R	95-01	BLAZER LT, 4WD	
R	95-99	BLAZER Base, 4WD	
R	95-99	BLAZER Base, RWD	
R	95-97	BLAZER Deluxe, RWD	
R	83-94	BLAZER, S MODELS All	
R	04-12	COLORADO Torsion Bar (FrontSpringType)	

Rear Load Carrier, Ultra Cartridge, HiJackers

Shock	POP	Alternative No.	MTG Acc. Supplied
Pos.	Year	Application	
43162	A (cont)		
R	94-04	S10 LS, 4WD	
R	99-03	S10 Base, RWD	
R	99-03	S10 LS, RWD	
R	83-03	S10 Base, 4WD	
R	92-93	S10 EL, 4WD	
R	83-92	S10 Tahoe, 4WD	
R	88-90	S10 Durango, 4WD	
R	83-86	S10 Durango, 4WD	
R	04-12	GMC CANYON RWD	
R	05	JIMMY 4WD	
R	92-04	JIMMY All	
R	83-91	S15 JIMMY All	
R	82-04	SONOMA / S15 All	
R	91	SYCLONE All	
R	92-93	TYPHOON All	
R	96-00	ISUZU HOMBRE All	
R	06	I-280 All	
R	07-08	I-290 All	
R	07-08	I-370 All	
R	96-01	OLDSMOBILE BRAVADA All	
R	91-94	BRAVADA All	
43163	A		
R	91-02	CHEVROLET C3500HD All Solid Front Axle	
R	88-99	PICKUP 1/2 TON, C15 / C1500 All	
R	88-99	PICKUP 1/2 TON, K15 / K1500 All	
R	88-90	PICKUP 1 TON, C35/3500 Extended Cab Pickup Exc. HD Straight Front Axle	
R	88-90	PICKUP 1 TON, C35/3500 Standard Cab Pickup Exc. HD Straight Front Axle	
R	88-00	PICKUP 1 TON, K35 / K3500 All	
R	88-00	PICKUP 3/4 TON, C25 / C2500 All	
R	88-00	PICKUP 3/4 TON, K25 / K2500 All	
R	88-99	GMC PICKUP 1/2 TON, C15 / C1500 All	
R	88-99	PICKUP 1/2 TON, K15 / K1500 All	
R	91-00	PICKUP 1 TON, C35/3500 All HD Solid Front Axle	
R	88-90	PICKUP 1 TON, C35/3500 Extended Cab Pickup Exc. HD Straight Front Axle	
R	88-90	PICKUP 1 TON, C35/3500 Standard Cab Pickup Exc. HD Straight Front Axle	
R	88-00	PICKUP 1 TON, K35 / K3500 All	
R	88-00	PICKUP 3/4 TON, C25 / C2500 All	
R	88-00	PICKUP 3/4 TON, K25 / K2500 All	
43167	A		
R	80-96	FORD BRONCO All Exc. Lift Kit	
R	97	F-250 HD RWD	
R	80-83	PICKUP 1/2 TON, F-100 All	
R	80-96	PICKUP 1/2 TON, F-150 RWD	
R	88-97	PICKUP 1/2 TON, F SUPERDUTY All	
R	80-97	PICKUP 1 TON, F-350 / SUPERDUTY RWD Exc. Dual Rear Wheels	
R	97	PICKUP 3/4 TON, F-250 / SUPERDUTY RWD Over 8500# GVW	
R	80-96	PICKUP 3/4 TON, F-250 / SUPERDUTY RWD	
R	97	PICKUP, F-450 SUPERDUTY All	
R	06-11	RANGER RWD, Coil (FrontSpringType)	
R	98-05	RANGER XL, RWD	
R	98-05	RANGER XLT, RWD	
R	05	RANGER STX, RWD	
R	04	RANGER Tremor, RWD	
R	02	RANGER Postal, RWD	
R	90-97	RANGER RWD	
43171	B		140719
R	95-01	FORD EXPLORER All Exc. Adjustable Suspension	
R	01-05	EXPLORER SPORT TRAC All	
R	97-01	MERCURY MOUNTAINEER All Exc. Electronic Adjustable Suspension	
43180	A		
R	99-00	CADILLAC ESCALADE All	
R	92-94	CHEVROLET BLAZER 4WD Full Size	
R	92-99	SUBURBAN 1/2 TON, C15 / C1500 All	
R	92-99	SUBURBAN 1/2 TON, K15 / K1500 All	
R	92-99	SUBURBAN 3/4 TON, C25 / C2500 All	

Numerical listing

Shock	POP	Alternative No.	MTG Acc. Supplied
Pos.	Year	Application	
43180	A (cont)		
R	92-99	SUBURBAN 3/4 TON, K25 / K2500 All	
R	95-00	TAHOE All Old Body Style	
R	96-14	VAN 1/2 TON, G / EXPRESS All	
R	96-22	VAN 1 TON, G / EXPRESS All	
R	03-22	VAN 3/4 TON, G / EXPRESS All	
R	96-02	VAN 3/4 TON, G / EXPRESS All Exc. 8600# GVW	
R	92-99	GMC SUBURBAN 1/2 TON, C15 / C1500 All	
R	92-99	SUBURBAN 1/2 TON, K15 / K1500 All	
R	92-99	SUBURBAN 3/4 TON, C25 / C2500 All	
R	92-99	SUBURBAN 3/4 TON, K25 / K2500 All	
R	96-14	VAN 1/2 TON, G / SAVANA All	
R	96-22	VAN 1 TON, G / SAVANA All	
R	03-22	VAN 3/4 TON, G / SAVANA All	
R	96-02	VAN 3/4 TON, G / SAVANA All Exc. 8600# GVW	
R	92-99	YUKON All	
43181	A		
R	07-22	CHEVROLET PICKUP 1/2 TON, SILVERADO 1500 All	
R	99-07	PICKUP 1/2 TON, SILVERADO 1500 RWD Exc. Electronic Adjustable Suspension	
R	11-22	PICKUP 1 TON, SILVERADO 3500 HD All	
R	11-22	PICKUP 3/4 TON, SILVERADO 2500 HD All	
R	19	SILVERADO 1500 LD All	
R	94-01	DODGE PICKUP 1/2 TON, RAM 1500 (SEE RAM 1500) All	
R	94-02	PICKUP 1 TON, RAM 3500 (SEE RAM 3500) RWD Exc. Solid Front Axle	
R	07-22	GMC SIERRA 1500 All	
R	99-07	SIERRA 1500 RWD Exc. Electronic Adjustable Suspension	
R	19	SIERRA 1500 LIMITED All	
R	11-22	SIERRA 2500 HD All	
R	11-22	SIERRA 3500 HD All	
R	14-20	RAM 3500 (SEE DODGE RAM 3500) 4WD	
Ultra Cartridge			
G44459	D		141934
F	88-96	BUICK REGAL All	
F	90-01	CHEVROLET LUMINA All	
F	95-99	MONTE CARLO All	
F	88-97	OLDSMOBILE CUTLASS / CUTLASS SUPREME All	
F	88-96	PONTIAC GRAND PRIX All	
G44461	W		140804
F	94-98	SAAB 900 Turbocharged (Eng Asp)	
F	93	900 Turbocharged (Eng Asp) Mfg. from 6/30/93	
G44493	W		
F	92-95	BMW 525I All Exc. Electronic Adjustable Suspension	
G44748	W		141028
F	83-87	TOYOTA TERCEL FWD	
G44903	W		141070
F	93	ASUNA GT, SE All	
F	99-02	DAEWOO LANOS All	
F	88-93	PONTIAC LEMANS All	
G44986	W		142717
F	90-97	VOLKSWAGEN PASSAT All Rebuildable OE Front Struts	
G44997	W		141039
R	92-95	TOYOTA MR2 All	
G44999	W		141039
F	92-94	TOYOTA CAMRY FWD Rebuildable OE Struts	
HiJackers			
49105	A		140121,141099
R	75-80	AMERICAN MOTORS PACER All	
R	52-59	FORD COUNTRY SEDAN All	
R	52-56	COUNTRY SQUIRE All	
R	54-56	COURIER SEDAN DELIVERY All	
R	52-54	CRESTLINE All	
R	57	CUSTOM All	
R	52	CUSTOM All	

Numerical listing

Shock	POP	Alternative No.	MTG Acc. Supplied
Pos.	Year	Application	
49105	A (cont)	140121,141099	
R 58	CUSTOM 300 All		
R 52-56	CUSTOMLINE All		
R 62-70	FAIRLANE All		
R 55-58	FAIRLANE All		
R 60-70	FALCON All		
R 52-56	MAINLINE All		
R 65-73	MUSTANG / MUSTANG II All		
R 60-65	RANCHERO All		
R 52-56	RANCH WAGON All		
R 54-56	SKYLINER All		
R 52-58	SUNLINER All		
R 55-57	THUNDERBIRD All		
R 68-71	TORINO All		
R 52-58	VICTORIA All		
R 62-64	JAGUAR XKE All		
R 79-83	MAZDA GLC Wagon		
R 78	GLC All		
R 75-76	RX3 Wagon Exc. Models w/ Tokico OE Struts		
R 72-74	RX3 All		
R 74-78	RX4 All		
R 59-60	MERCURY COLONY PARK All		
R 68-69	COMET All		
R 66-67	COMET Convertible		
R 66-67	COMET Hardtop		
R 66-67	COMET Sedan		
R 60-65	COMET All		
R 59-60	COMMUTER All		
R 67-73	COUGAR All		
R 59-60	COUNTRY CRUISER All		
R 62-63	METEOR All		
R 59-60	MONTCLAIR All		
R 68-71	MONTEGO All		
R 59-60	MONTEREY All		
R 59-60	PARKLANE All		
R 69-78	SAAB 99 All		
R 59-68	VOLVO 122 All		
49106	B	141099	
R 65-69	CHRYSLER 300 All		
R 75-76	CORDOBA All		
R 74-75	IMPERIAL All		
R 74-78	NEWPORT All		
R 65-69	NEWPORT All		
R 74-78	NEW YORKER All		
R 65-69	NEW YORKER All		
R 74-78	TOWN & COUNTRY All		
R 65-70	TOWN & COUNTRY All		
R 63-64	DODGE 330 All		
R 63-64	440 All		
R 65	880 All		
R 70-74	CHALLENGER All		
R 66-76	CHARGER All		
R 65-76	CORONET All		
R 62	DART All		
R 74-78	MONACO All		
R 73	MONACO All Exc. Wagon		
R 72	MONACO All		
R 65-70	MONACO All		
R 73	POLARA All Exc. Wagon		
R 72	POLARA All		
R 62-70	POLARA All		
R 75-77	ROYAL MONACO All		
R 70-74	PLYMOUTH BARRACUDA All		
R 62-70	BELVEDERE All		
R 62-63	FLEET SPECIAL All		
R 77-78	FURY All Police Package		
R 74-76	FURY All		
R 73	FURY Wagon		
R 62-69	FURY All		
R 74-77	GRAN FURY All		
R 73	GRAN FURY Wagon		
R 67-71	GTX All		
R 68-75	ROAD RUNNER All		
R 65-74	SATELLITE All		
R 62-64	SAVOY All		
R 70	SUPERBIRD All		
R 67	VIP All		
49107	D	141099	
R 69-72	CHEVROLET BLAZER All Coil(RearSpringType)		
R 67-72	PICKUP 1/2 TON, C10 All Coil(RearSpringType)		
R 67-72	PICKUP 3/4 TON, C20 All Coil(RearSpringType)		
R 68-72	SUBURBAN 1/2 TON, C10 All		
R 68-72	SUBURBAN 3/4 TON, C20 All		
R 67-72	VAN 1/2 TON, P SERIES All		
R 70-72	GMC JIMMY All Coil(RearSpringType)		
R 67-72	PICKUP 1/2 TON, C15 / C1500 All Coil(RearSpringType)		

HiJackers

Shock	POP	Alternative No.	MTG Acc. Supplied
Pos.	Year	Application	
49107	D (cont)	141099	
R 67-72	PICKUP 3/4 TON, C25 / C2500 All Coil(RearSpringType)		
R 68-72	SUBURBAN 1/2 TON, C15 / C1500 All Coil(RearSpringType)		
R 68-72	SUBURBAN 3/4 TON, C25 / C2500 All		
R 68-72	VAN 1/2 TON, P SERIES All Coil(RearSpringType)		
49110	C	140377,141099	
R 57-64	CHRYSLER 300 All		
R 57-66	IMPERIAL All		
R 55	IMPERIAL All		
R 55-56	NASSAU All		
R 51-64	NEWPORT All		
R 51-64	NEW YORKER All		
R 57-60	SARATOGA All		
R 51-52	SARATOGA All		
R 55-56	ST REGIS All		
R 51-64	TOWN & COUNTRY All		
R 51-61	WINDSOR All		
R 62-64	DODGE 880 All		
R 64-70	A100 TRUCK All		
R 51-59	CORONET All		
R 54-61	CUSTOM All		
R 63-76	DART All		
R 60-61	DART All		
R 61-62	LANCER All		
R 51-54	MEADOWBROOK All		
R 60-61	POLARA All		
R 64-70	VAN 1/2 TON, A / B SERIES / RAM All		
R 58-59	EDSEL CORSAIR All Exc. Wagon		
R 58-59	RANGER All Exc. Wagon		
R 58-59	VILLAGER All Exc. Wagon		
R 64-69	PLYMOUTH BARRACUDA All		
R 53-61	BELVEDERE All		
R 51-53	CAMBRIDGE All		
R 51-52	CONCORD All		
R 51-53	CRANBROOK All		
R 58-61	CUSTOM All		
R 70-76	DUSTER All		
R 60-61	FLEET SPECIAL All		
R 56-61	FURY All		
R 54-58	PLAZA All		
R 53-61	SAVOY All		
R 71-76	SCAMP All		
R 60-61	SPORT WAGON All		
R 51-61	SUBURBAN All		
R 60-76	VALIANT All		
49122	B	140523,141099	
R 68-70	CADILLAC ELDORADO All Vertically Mounted		
R 68-69	CHEVROLET CAMARO All Single Leaf Rear Springs		
R 67	CAMARO All Single Leaf Spring		
R 66	OLDSMOBILE TORONADO All Vertically Mounted		
R 67-69	PONTIAC FIREBIRD All Single Leaf Spring		
49127	D	140739,141137,141099	
R 78-79	FORD BRONCO All Exc. Lift Kit		
R 67-77	BRONCO All From Serial #830001; Exc. Lift Kit		
R 65-69	PICKUP 1/2 TON, F-100 All RWD		
R 75-79	PICKUP 1 TON, F-350 / SUPERDUTY Standard Cab Pickup, RWD		
R 73-74	PICKUP 1 TON, F-350 / SUPERDUTY Standard Cab Pickup RWD		
R 75-79	PICKUP 3/4 TON, F-250 / SUPERDUTY Cab & Chassis, RWD		
R 75-79	PICKUP 3/4 TON, F-250 / SUPERDUTY Extended Cab Pickup, RWD		
R 65-69	PICKUP 3/4 TON, F-250 / SUPERDUTY All Supercab		
R 69-74	VAN 1/2 TON, ECONOLINE / CLUB WAGON All		
R 69-74	VAN 1 TON, ECONOLINE / CLUB WAGON / SUPERDUTY All		
R 69-74	VAN 3/4 TON, ECONOLINE / CLUB WAGON / SUPERDUTY All		
R 76-83	JEEP CHEROKEE All		
R 67	GLADIATOR All		
R 93	GRAND WAGONEER All		
R 84-91	GRAND WAGONEER All		
R 74-88	J10 PICKUP All		
R 74-88	J20 PICKUP All		
R 68-73	J2500 PICKUP All		
R 76-83	WAGONEER All		

Numerical listing

Shock	POP	Alternative No.	MTG Acc. Supplied
Pos.	Year	Application	
49128	W	140644,141099	
R 70	BUICK ESTATE WAGON All		
R 65-70	OLDSMOBILE 88 SERIES All		
R 65-70	98 All		
R 67	CUTLASS / CUTLASS SUPREME Turnpike Cruiser		
R 65-66	DYNAMIC 88 All		
R 65-66	STARFIRE All		
R 63-70	PONTIAC BONNEVILLE All		
R 63-70	CATALINA All		
R 67-70	EXECUTIVE All		
R 63-68	GRAND PRIX All		
R 63-66	STAR CHIEF All		
49131	A	140630,141099	
R 70	AMERICAN MOTORS GREMLIN All		
R 70	HORNET All		
R 71-73	BUICK CENTURION All		
R 71-84	ELECTRA All		
R 71-85	LESABRE All		
R 71-78	RIVIERA All		
R 92-96	ROADMASTER Sedan		
R 64-67	SKYLARK All Exc. Heavy Duty Suspension		
R 64-67	SPECIAL All Exc. Heavy Duty Suspension		
R 87-92	CADILLAC BROUGHAM All		
R 92-96	COMMERCIAL CHASSIS RWD		
R 77-84	COMMERCIAL CHASSIS All		
R 77-84	DEVILLE All		
R 93-96	FLEETWOOD RWD		
R 77-86	FLEETWOOD RWD		
R 81	CHEVROLET BEL AIR Sedan		
R 75	BEL AIR Sedan		
R 58-74	BEL AIR All		
R 58-72	BISCAIYNE All		
R 69-70	BROOKWOOD All		
R 81-96	CAPRICE Sedan Police and Taxi Models		
R 75-80	CAPRICE Coupe		
R 75-80	CAPRICE Sedan		
R 75	CAPRICE Convertible		
R 73-74	CAPRICE Sedan Police and Taxi Models		
R 71-72	CAPRICE Hardtop Police and Taxi Models		
R 66-70	CAPRICE All		
R 64-67	CHEVELLE All Exc. Heavy Duty Suspension		
R 58	DEL RAY All		
R 64-67	EL CAMINO All Exc. Heavy Duty Suspension		
R 59-60	EL CAMINO All		
R 94-96	IMPALA All		
R 59-85	IMPALA All		
R 69-70	KINGSWOOD All		
R 64-67	MALIBU All Exc. Heavy Duty Suspension		
R 69-70	TOWNSMAN All		
R 71-85	OLDSMOBILE 88 SERIES All		
R 71-84	98 All		
R 66-67	CUTLASS / CUTLASS SUPREME Base Exc. Heavy Duty Suspension		
R 64-65	CUTLASS / CUTLASS SUPREME All Exc. Heavy Duty Suspension		
R 64-67	F85 All Exc. Heavy Duty Suspension		
R 71-81	PONTIAC BONNEVILLE All		
R 75-81	CATALINA Coupe		
R 71-81	CATALINA Sedan		
R 72-74	CATALINA Hardtop		
R 64-67	GTO All Exc. Heavy Duty Suspension		
R 76-81	LAURENTIAN All		
R 64-67	LEMANS All Exc. Heavy Duty Suspension		
R 76-86	PARISIENNE Sedan		
R 64-67	TEMPEST All Exc. Heavy Duty Suspension		
49135	A	140523,141099	
R 70-81	CHEVROLET CAMARO All		
R 70-81	PONTIAC FIREBIRD All		
49149	W	141099	
R 70-71	CHRYSLER 300 All		
R 67-73	IMPERIAL All		
R 70-73	NEWPORT All		
R 70-73	NEW YORKER All		
R 71-73	TOWN & COUNTRY All		
R 73	DODGE MONACO All		
R 71	MONACO All		
R 72-93	PICKUP 1/2 TON, D100 SERIES All		
R 72-93	PICKUP 1 TON, D300 SERIES All		

Numerical listing

Shock	POP	Alternative No.	MTG Acc. Supplied
Pos.	Year	Application	
49149	W (cont)	141099	
R	82-93	PICKUP 3/4 TON, D200 SERIES All	
R	81	PICKUP 3/4 TON, D200 SERIES All	
		Exc. Heavy Duty Package	
R	72-80	PICKUP 3/4 TON, D200 SERIES All	
R	73	POLARA All	
R	71	POLARA All	
R	76-93	RAMCHARGER RWD	
R	74-75	RAMCHARGER All	
R	73	PLYMOUTH FURY All Exc. Wagon	
R	70-72	FURY All	
R	73	GRAN FURY Hardtop	
R	72	GRAN FURY All	
R	74-81	TRAILDUSTER All	
49152	A	140630,141099	
R	73-77	BUICK CENTURY All	
R	71-83	ESTATE WAGON All	
R	65-67	GRAN SPORT All	
R	68-72	GS / GS350 / GS400 / GS455 All	
R	73-77	REGAL All	
R	91-96	ROADMASTER Wagon	
R	68-72	SKYLARK All	
R	64-67	SKYLARK All Heavy Duty	
		Suspension	
R	68-69	SPECIAL All	
R	64-67	SPECIAL All Heavy Duty	
		Suspension	
R	70-72	SPORTWAGON All	
R	71-96	CHEVROLET CAPRICE Wagon	
R	68-73	CHEVELLE All	
R	64-67	CHEVELLE All Heavy Duty	
		Suspension	
R	68-77	EL CAMINO All	
R	71-82	IMPALA Wagon	
R	73-77	MALIBU All	
R	64-67	MALIBU All Heavy Duty Suspension	
R	70-72	MONTE CARLO All	
R	71-77	GMC SPRINT / CABALLERO All	
R	75-76	NISSAN 610 Wagon	
R	73-74	610 All	
R	74-77	710 Wagon	
R	78-80	810 Wagon	
R	77-92	OLDSMOBILE CUSTOM CRUISER All	
R	76-77	CUTLASS / CUTLASS SUPREME	
		Coupe	
R	76-77	CUTLASS / CUTLASS SUPREME	
		Sedan	
R	73-75	CUTLASS / CUTLASS SUPREME	
		All	
R	72	CUTLASS / CUTLASS SUPREME	
		Base	
R	72	CUTLASS / CUTLASS SUPREME S	
R	68-71	CUTLASS / CUTLASS SUPREME	
		All Exc. Vista Cruiser	
R	64-67	CUTLASS / CUTLASS SUPREME	
		All Heavy Duty Suspension; Exc. Vista Cruiser	
R	68-72	F85 All	
R	64-67	F85 All Heavy Duty Suspension	
R	71-78	TORONADO All	
R	77-81	PONTIAC CATALINA Wagon	
R	74-75	CATALINA Wagon	
R	71-73	CATALINA Wagon Wagon	
R	73-75	GRAND AM All	
R	75-77	GRAND LEMANS All	
R	71-78	GRAND SAFARI All	
R	71-75	GRANDVILLE All	
R	68-73	GTO All	
R	64-67	GTO All Heavy Duty Suspension	
R	64-67	LEMANS All Heavy Duty	
		Suspension	
R	80-86	PARISIENNE Wagon	
R	76-79	PARISIENNE All Wagon	
R	87-89	SAFARI All	
R	68-70	TEMPEST All	
R	64-67	TEMPEST All Heavy Duty	
		Suspension	
49155	A	140702,141099	
R	02-13	CADILLAC ESCALADE RWD Exc.	
		Electronic Ride Control	
R	02-13	CHEVROLET AVALANCHE 1500	
		RWD	
R	04-06	AVALANCHE 2500 All RWD	
R	02-03	AVALANCHE 2500 RWD	
R	87-91	BLAZER 4WD Full Size; Exc. Quad	
		Suspension and Lift Kit	
R	77-86	BLAZER 4WD Exc. Lift Kit	
R	73-76	BLAZER All Exc. Lift Kit	
R	73-86	PICKUP 1/2 TON, C10 All	
R	81-86	PICKUP 1/2 TON, K10 All Standard	
		Suspension; Exc. Lift Kit	

HiJackers

Shock	POP	Alternative No.	MTG Acc. Supplied
Pos.	Year	Application	
49155	A (cont)	140702,141099	
R	73-80	PICKUP 1/2 TON, K10 All Exc. Lift	
		Kit	
R	87	PICKUP 1/2 TON, R10 RWD	
R	87	PICKUP 1/2 TON, V10 All	
R	75-86	PICKUP 3/4 TON, C20 Standard	
		Cab Pickup	
R	73-74	PICKUP 3/4 TON, C20 All Standard	
		Cab Pickup	
R	81-86	PICKUP 3/4 TON, K20 All Standard	
		Suspension; Exc. Lift Kit	
R	73-80	PICKUP 3/4 TON, K20 All Exc. Lift	
		Kit	
R	87	PICKUP 3/4 TON, R20 Standard	
		Cab Pickup	
R	87	PICKUP 3/4 TON, V20 All	
R	00-11	SUBURBAN 1/2 TON, 1500 RWD	
R	73-86	SUBURBAN 1/2 TON, C10 All	
R	81-86	SUBURBAN 1/2 TON, K10 All	
		Standard Suspension; Exc. Lift Kit	
R	73-80	SUBURBAN 1/2 TON, K10 All Exc.	
		Lift Kit	
R	87-88	SUBURBAN 1/2 TON, R10 RWD	
R	89-91	SUBURBAN 1/2 TON, R1500 RWD	
R	89-91	SUBURBAN 1/2 TON, V1500 All	
R	00-11	SUBURBAN 3/4 TON, 2500 RWD	
R	73-86	SUBURBAN 3/4 TON, C20 All	
R	81-86	SUBURBAN 3/4 TON, K20 All	
		Standard Suspension; Exc. Lift Kit	
R	73-80	SUBURBAN 3/4 TON, K20 All Exc.	
		Lift Kit	
R	87-88	SUBURBAN 3/4 TON, R20 RWD	
R	89-91	SUBURBAN 3/4 TON, R1500 RWD	
R	87-88	SUBURBAN 3/4 TON, V20 All	
R	89-91	SUBURBAN 3/4 TON, V2500 All	
R	02-11	TAHOE RWD	
R	00-01	TAHOE RWD Old Body Style	
R	73	VAN 1/2 TON, P SERIES All	
R	73-78	VAN 3/4 TON, P SERIES All	
R	87-91	GMC JIMMY All Exc. Quad	
		Suspension and Lift Kit	
R	73-86	JIMMY All Exc. Lift Kit	
R	73-86	PICKUP 1/2 TON, C15 / C1500 All	
R	73-86	PICKUP 1/2 TON, K15 / K1500 All	
		Exc. Quad Suspension and Lift Kit	
R	87	PICKUP 1/2 TON, R1500 All	
R	87	PICKUP 1/2 TON, V1500 All Quad	
		Suspension; Exc. Lift Kit	
R	75-86	PICKUP 3/4 TON, C25 / C2500 Cab	
		& Chassis	
R	75-86	PICKUP 3/4 TON, C25 / C2500	
		Standard Cab Pickup	
R	73-74	PICKUP 3/4 TON, C25 / C2500 All	
R	73-86	PICKUP 3/4 TON, K25 / K2500 All	
		Exc. Quad Suspension and Lift Kit	
R	88-89	PICKUP 3/4 TON, R2500 All Exc.	
		Crew Cab & Bonus Cab	
R	87	PICKUP 3/4 TON, R2500 Cab &	
		Chassis Exc. Crew Cab & Bonus Cab	
R	87	PICKUP 3/4 TON, R2500 Standard	
		Cab Pickup Exc. Crew Cab & Bonus Cab	
R	87	PICKUP 3/4 TON, V2500 All Exc. Lift	
		Kit	
R	73-86	SUBURBAN 1/2 TON, C15 / C1500	
		All	
R	73-86	SUBURBAN 1/2 TON, K15 / K1500	
		All Exc. Quad Suspension and Lift Kit	
R	87-91	SUBURBAN 1/2 TON, R1500 All	
R	87-91	SUBURBAN 1/2 TON, V1500 All	
		Exc. Lift Kit	
R	73-86	SUBURBAN 3/4 TON, C25 / C2500	
		All	
R	73-86	SUBURBAN 3/4 TON, K25 / K2500	
		All Exc. Quad Suspension and Lift Kit	
R	87-91	SUBURBAN 3/4 TON, R2500 All	
R	87-91	SUBURBAN 3/4 TON, V2500 All	
		Exc. Lift Kit	
R	73	VAN 1/2 TON, P SERIES All	
R	73-78	VAN 3/4 TON, P SERIES All	
R	00-11	YUKON RWD	
R	00-11	YUKON XL 1/2 TON RWD	
R	00-11	YUKON XL 3/4 TON RWD	
49157	C (cont)	140629,141099	
R	73	PONTIAC VENTURA All Heavy	
		Duty Suspension	
R	71-72	VENTURA All Multi-Leaf Rear	
		Spring	
49162	W	141058,141099	
R	69-72	CHEVROLET BLAZER All	
		Leaf(RearSpringType)	
R	63-72	PICKUP 1/2 TON, C10 All	
		Leaf(RearSpringType)	
R	67-72	PICKUP 1 TON, C30 All Exc.	
		11,000# Rear Axle	
R	67-72	PICKUP 3/4 TON, C20 All	
		Leaf(RearSpringType)	
R	63-66	PICKUP 3/4 TON, C20 All	
R	63-66	SUBURBAN 1/2 TON, 1500 All	
R	67-77	VAN 1/2 TON, G / EXPRESS All	
R	63-66	VAN 1/2 TON, P SERIES All	
R	76-77	VAN 1 TON, G / EXPRESS All	
R	75	VAN 1 TON, G / EXPRESS 110.0 /	
		279.4 (WheelBase)	
R	75	VAN 1 TON, G / EXPRESS 125.0 /	
		317.5 (WheelBase)	
R	71-74	VAN 1 TON, G / EXPRESS All	
R	68-72	VAN 1 TON, P SERIES All Exc.	
		11,000# Rear Axle	
R	67-77	VAN 3/4 TON, G / EXPRESS All	
R	68-72	VAN 3/4 TON, P SERIES All	
R	70-72	GMC JIMMY All RWD	
R	67-72	PICKUP 1/2 TON, C15 / C1500 All	
		Leaf(RearSpringType)	
R	67-72	PICKUP 1 TON, C35/3500 All Exc.	
		11,000# Rear Axle	
R	67-72	PICKUP 3/4 TON, C25 / C2500 All	
		Leaf(RearSpringType)	
R	63-65	PICKUP 1000 SERIES All	
R	63-65	PICKUP 1500 SERIES All	
R	67-77	VAN 1/2 TON, G / SAVANA All	
R	67	VAN 1/2 TON, P SERIES All	
R	76-77	VAN 1 TON, G / SAVANA All	
R	75	VAN 1 TON, G / SAVANA 110.0 /	
		279.4 (WheelBase)	
R	75	VAN 1 TON, G / SAVANA 125.0 /	
		317.5 (WheelBase)	
R	71-74	VAN 1 TON, G / SAVANA All Exc.	
		146" Wheelbase	
R	68-72	VAN 1 TON, P SERIES All Exc.	
		11,000# Rear Axle	
R	67-77	VAN 3/4 TON, G / SAVANA All	
R	68-72	VAN 3/4 TON, P SERIES All	
R	63-65	VAN, PB 1000 SERIES All	
49173	W	140126,141099	
R	62-67	CHEVROLET CHEVY II All	
R	66	FORD BRONCO All Thru Serial	
		#830000	
R	75-79	PICKUP 1/2 TON, F-100 RWD	
R	70-74	PICKUP 1/2 TON, F-100 All	
R	75-79	PICKUP 1/2 TON, F-150 RWD	
R	75-79	PICKUP 1 TON, F-350 /	
		SUPERDUTY Cab & Chassis, RWD	
R	75-79	PICKUP 1 TON, F-350 /	
		SUPERDUTY Extended Cab Pickup, RWD	
R	74	PICKUP 1 TON, F-350 /	
		SUPERDUTY RWD Extended Cab & Chassis Cab	
R	75-79	PICKUP 3/4 TON, F-250 /	
		SUPERDUTY Standard Cab Pickup, RWD	
R	71-74	PICKUP 3/4 TON, F-250 /	
		SUPERDUTY All RWD; Exc. Extended Cab & Chassis Cab	
R	75-91	VAN 1/2 TON, ECONOLINE / CLUB WAGON All	
49178	B	140126,141099	
R	75-76	FORD PICKUP 1/2 TON, F-100	
		4WD	
R	70-74	PICKUP 1/2 TON, F-100 All	
R	76-79	PICKUP 1/2 TON, F-150 4WD	
R	75	PICKUP 1/2 TON, F-150 All 4WD	
R	79	PICKUP 1 TON, F-350 /	
		SUPERDUTY 4WD	
R	77-79	PICKUP 3/4 TON, F-250 /	
		SUPERDUTY Cab & Chassis, 4WD All From Serial No. Y20001	
R	77-79	PICKUP 3/4 TON, F-250 /	
		SUPERDUTY Standard Cab Pickup, 4WD All From Serial No. Y20001	
R	92-14	VAN 1/2 TON, ECONOLINE / CLUB WAGON All	
R	21-22	VAN 1 TON, ECONOLINE / CLUB WAGON / SUPERDUTY All	

Numerical listing

Numerical listing

Shock	POP	Alternative No.	MTG Acc. Supplied
Pos.	Year	Application	
49178	B (cont)	140126,141099	
R	77-19	VAN 1 TON, ECONOLINE / CLUB WAGON / SUPERDUTY All	
R	07	VAN 1 TON, ECONOLINE / CLUB WAGON / SUPERDUTY All Exc. Cutaway Chassis	
R	75-91	VAN 1 TON, ECONOLINE / CLUB WAGON / SUPERDUTY All Exc. Cutaway Chassis	
R	75-14	VAN 3/4 TON, ECONOLINE / CLUB WAGON / SUPERDUTY All	
49199	W	141282,141099	
R	78-83	FORD FAIRMONT All	
R	81-82	GRANADA All	
R	83-86	LTD / COUNTRY SEDAN / COUNTRY SQUIRE / CROWN VICTORIA All	
R	84-93	MUSTANG / MUSTANG II LX, 2.3L 4Cyl L (140), 3.78 96.0(Bore)3.13 79.4(Stroke)	
R	84-86	MUSTANG / MUSTANG II LX, 3.8L 6Cyl V (232), 3.81 96.8(Bore)3.39 86.0(Stroke)	
R	82-83	MUSTANG / MUSTANG II GL	
R	82-83	MUSTANG / MUSTANG II GLX	
R	82-83	MUSTANG / MUSTANG II L	
R	82	MUSTANG / MUSTANG II Ghia	
R	79-81	MUSTANG / MUSTANG II All	
R	79-86	MERCURY CAPRI All	
R	81-82	COUGAR Base	
R	82	COUGAR GS	
R	82	COUGAR LS	
R	83-86	MARQUIS All	
R	78-83	ZEPHYR All	
49203	C	142261,141099	
R	82-02	CHEVROLET CAMARO All	
R	82-02	PONTIAC FIREBIRD All	
49205	C	141150,141099	
R	67-69	AMERICAN MOTORS AMBASSADOR All	
R	61-68	AMERICAN All	
R	68-69	JAVELIN All	
R	67	MARLIN All	
R	69	RAMBLER All	
R	59-60	RAMBLER All	
R	61-63	BUICK SKYLARK All	
R	61-63	SPECIAL All	
R	64-69	SPORTWAGON All	
R	68-69	CHEVROLET CAMARO All	
R	65-74	FORD COUNTRY SEDAN All	
R	87-91	COUNTRY SQUIRE All	
R	65-74	COUNTRY SQUIRE All	
R	92-02	CROWN VICTORIA All Rear Air Springs	
R	65-72	CUSTOM All	
R	68-77	CUSTOM 500 All	
R	75-76	ELITE All	
R	66-70	FALCON All Wagon	
R	65-67	GALAXIE All	
R	68-74	GALAXIE 500 All	
R	01-02	GRAND MARQUIS All	
R	87-91	LTD / COUNTRY SEDAN / COUNTRY SQUIRE / CROWN VICTORIA All	
R	67-82	LTD / COUNTRY SEDAN / COUNTRY SQUIRE / CROWN VICTORIA All	
R	77-79	LTD II All	
R	72-79	RANCHERO All	
R	65-74	RANCH WAGON All	
R	77-79	THUNDERBIRD All	
R	67-72	THUNDERBIRD All	
R	72-76	TORINO All	
R	70-80	LINCOLN CONTINENTAL All	
R	68-71	MARK III All	
R	72	MARK IV All	
R	80-83	MARK VI All	
R	81-02	TOWN CAR All	
R	67	MERCURY BROUGHAM All	
R	87-91	COLONY PARK All	
R	65-74	COLONY PARK All	
R	66-67	COMET Wagon	
R	65-68	COMMUTER All	
R	74-79	COUGAR All	
R	75-02	GRAND MARQUIS All	
R	69-70	MARAUDER All	
R	65-67	MARAUDER All	
R	67-82	MARQUIS All	
R	65-68	MONTCLAIR All	
R	72-76	MONTEGO All	
R	65-74	MONTEREY All	
R	65-68	PARKLANE All	

HiJackers

Shock	POP	Alternative No.	MTG Acc. Supplied
Pos.	Year	Application	
49205	C (cont)	141150,141099	
R	65-67	VILLAGER All	
R	66-67	VOYAGER All	
R	64-72	OLDSMOBILE VISTA CRUISER All	
R	98-03	TOYOTA SIENNA All	
49212	B	141099	
R	78-95	CHEVROLET VAN 1/2 TON, G / EXPRESS All	
R	78-95	VAN 1 TON, G / EXPRESS Cutaway Van	
R	78-95	VAN 3/4 TON, G / EXPRESS All Exc. 8600# GVW	
R	84-86	DODGE MINI RAM All	
R	99-03	VAN 1/2 TON, A / B SERIES / RAM 109.3 / 277.6 (WheelBase) Exc. 7000# GVW	
R	82-98	VAN 1/2 TON, A / B SERIES / RAM 109.6 / 278.4 (WheelBase) Exc. 7000# GVW	
R	71-80	VAN 1/2 TON, A / B SERIES / RAM All	
R	99-03	VAN 1 TON, A / B SERIES / RAM All Exc. 4000# Front Axle	
R	95-98	VAN 1 TON, A / B SERIES / RAM All	
R	71-94	VAN 1 TON, A / B SERIES / RAM All	
R	71-03	VAN 3/4 TON, A / B SERIES / RAM All	
R	78-80	VAN, CB300 All	
R	77	VAN, CB300 All Over 8300# GVW	
R	75-76	VAN, CB300 All	
R	74	VAN, CB300 All Over 8300# GVW	
R	78-95	GMC VAN 1/2 TON, G / SAVANA All	
R	85-95	VAN 1 TON, G / SAVANA Extended Cargo Van	
R	85-95	VAN 1 TON, G / SAVANA Extended Passenger Van	
R	79-95	VAN 1 TON, G / SAVANA Standard Cargo Van	
R	79-95	VAN 1 TON, G / SAVANA Standard Passenger Van	
R	78	VAN 1 TON, G / SAVANA Cutaway Van	
R	78-95	VAN 3/4 TON, G / SAVANA All Exc. 8600# GVW	
R	74-83	PLYMOUTH VAN 1/2 TON, PB SERIES All	
R	74-83	VAN 1 TON, PB SERIES All	
R	74-83	VAN 3/4 TON, PB SERIES All	
49213	A	141099	
R	05	CHEVROLET BLAZER Base, 4WD	
R	05	BLAZER Base, RWD	
R	96-04	BLAZER LS, 4WD	
R	96-04	BLAZER LS, RWD	
R	95-02	BLAZER LT, RWD	
R	95-01	BLAZER LT, 4WD	
R	95-99	BLAZER Base, 4WD	
R	95-99	BLAZER Base, RWD	
R	95-97	BLAZER Deluxe, RWD	
R	83-94	BLAZER, S MODELS All	
R	04-12	COLORADO Torsion Bar (FrontSpringType)	
R	99-04	S10 LS, 4WD	
R	99-03	S10 Base, 4WD	
R	99-03	S10 Base, RWD	
R	99-03	S10 LS, RWD	
R	94-98	S10 LS	
R	82-98	S10 Base	
R	92-93	S10 EL	
R	83-92	S10 Tahoe	
R	88-90	S10 Durango	
R	82-86	S10 Durango	
R	04-12	GMC CANYON RWD	
R	05	JIMMY 4WD	
R	92-04	JIMMY All	
R	83-91	S15 JIMMY All	
R	82-04	SONOMA / S15 All	
R	91	SYCLONE All	
R	92-93	TYPHOON All	
R	96-00	ISUZU HOMBRE All	
R	06	I-280 All	
R	07-08	I-290 All	
R	07-08	I-370 All	
R	96-01	OLDSMOBILE BRAVADA All	
R	91-94	BRAVADA All	
49215	C	141099	
R	90-05	CHEVROLET ASTRO All	
R	85-89	ASTRO RWD	
R	90-05	GMC SAFARI All	
R	85-89	SAFARI RWD	
R	86-89	VOLKSWAGEN VANAGON 4WD	

Numerical listing

Shock	POP	Alternative No.	MTG Acc. Supplied
Pos.	Year	Application	
49218	A	141099	
R	88-99	CHEVROLET PICKUP 1/2 TON, C15 / C1500 All	
R	88-99	PICKUP 1/2 TON, K15 / K1500 All	
R	91-00	PICKUP 1 TON, C35/3500 All	
R	88-90	PICKUP 1 TON, C35/3500 Extended Cab Pickup	
R	88-90	PICKUP 1 TON, C35/3500 Standard Cab Pickup	
R	88-00	PICKUP 1 TON, K35 / K3500 All	
R	88-00	PICKUP 3/4 TON, C25 / C2500 All	
R	88-00	PICKUP 3/4 TON, K25 / K2500 All	
R	88-99	GMC PICKUP 1/2 TON, C15 / C1500 All	
R	88-99	PICKUP 1/2 TON, K15 / K1500 All	
R	92-00	PICKUP 1 TON, C35/3500 Cab & Chassis Exc. HD Straight Front Axle	
R	88-91	PICKUP 1 TON, C35/3500 All Exc. HD Straight Front Axle	
R	88-00	PICKUP 1 TON, K35 / K3500 All	
R	88-00	PICKUP 3/4 TON, C25 / C2500 All	
R	88-00	PICKUP 3/4 TON, K25 / K2500 All	
49221	W	141099	
R	89-97	FORD AEROSTAR All	
49223	D	141099	
R	90	FORD BRONCO II All	
R	89	BRONCO II All Mfg. from 2/89; Vehicles w/ 12mm bolt in rear lower mount	
R	06	RANGER RWD, Coil (FrontSpringType)	
R	98-05	RANGER XL, RWD	
R	98-05	RANGER XLT, RWD	
R	05	RANGER STX, RWD	
R	04	RANGER Tremor, RWD	
R	02	RANGER Postal, RWD	
R	90-97	RANGER RWD	
R	89	RANGER RWD Mfg. from 2/89; Vehicles w/ 12mm bolt in rear lower mount	
R	94-97	MAZDA B2300 RWD	
49226	W	141099	
R	84-01	JEEP CHEROKEE All	
R	84-90	WAGONEER All	
49228	A	143331,141248,141099	
R	00-05	BUICK LESABRE All Without OE Style air fitting	
R	06-11	LUCERNE All Exc. Magnetic Ride Control Suspension	
R	97-05	PARK AVENUE All Without OE Style air fitting	
R	95-99	RIVIERA All Without OE Style air fitting	
R	00-05	CADILLAC DEVILLE All Exc. Electronic Adjustable Suspension	
R	06-11	DTS All Exc. Magnetic Ride Control Suspension	
R	98-04	SEVILLE All Without OE Style air fitting	
R	01-03	OLDSMOBILE AURORA All Without OE Style air fitting	
R	95-99	AURORA All Without OE Style air fitting	
R	00-05	PONTIAC BONNEVILLE All Without OE Style air fitting	
49230	A	141099	
R	05-07	BUICK TERRAZA FWD Exc. Air-Leveling Suspension	
R	05-08	CHEVROLET UPLANDER FWD Exc. Auto-Leveling System & Independent Rear Suspension	
R	97-05	VENTURE FWD	
R	97-04	OLDSMOBILE SILHOUETTE FWD	
R	99-05	PONTIAC MONTANA FWD Exc. Air-Leveling Suspension & Independent Rear Suspension	
R	97-98	TRANS SPORT All	
R	05-07	SATURN RELAY All Air-Leveling Suspension, Exc. Independent Rear Suspension	
49231	A	141099	
R	99-00	CADILLAC ESCALADE All	
R	92-94	CHEVROLET BLAZER 4WD Full Size	
R	92-99	SUBURBAN 1/2 TON, C15 / C1500 All	
R	92-99	SUBURBAN 1/2 TON, K15 / K1500 All	
R	92-99	SUBURBAN 3/4 TON, C25 / C2500 All	

Numerical listing

Shock	POP	Alternative No.	MTG Acc. Supplied
Pos.	Year	Application	
49231	A (cont)		141099
R	92-99	SUBURBAN 3/4 TON, K25 / K2500 All	
R	95-00	TAHOE All Old Body Style	
R	96-14	VAN 1/2 TON, G / EXPRESS All	
R	96-02	VAN 1 TON, G / EXPRESS All	
R	96-02	VAN 3/4 TON, G / EXPRESS All Exc. 8600# GVW	
R	92-99	GMC SUBURBAN 1/2 TON, C15 / C1500 All	
R	92-99	SUBURBAN 1/2 TON, K15 / K1500 All	
R	92-99	SUBURBAN 3/4 TON, C25 / C2500 All	
R	92-99	SUBURBAN 3/4 TON, K25 / K2500 All	
R	96-14	VAN 1/2 TON, G / SAVANA All	
R	96-02	VAN 1 TON, G / SAVANA All	
R	96-02	VAN 3/4 TON, G / SAVANA All Exc. 8600# GVW	
R	92-99	YUKON All	
49232	W		140719,141099
R	95-01	FORD EXPLORER All Exc. Adjustable Suspension	
R	01-05	EXPLORER SPORT TRAC All	
R	97-01	MERCURY MOUNTAINEER All Exc. Electronic Adjustable Suspension	
49233	D		141099
R	95-03	FORD WINDSTAR Coil (RearSpringType)	
49234	D		140126,141099
R	03-04	FORD MUSTANG / MUSTANG II Mach 1	
R	94-04	MUSTANG / MUSTANG II Base	
R	94-04	MUSTANG / MUSTANG II GT	
R	04	MUSTANG / MUSTANG II GT Base	
R	04	MUSTANG / MUSTANG II GT Equipado	
R	01	MUSTANG / MUSTANG II GT Bullitt	
R	95	MUSTANG / MUSTANG II GTS	
49235	A		141099
R	02-13	CADILLAC ESCALADE AWD Exc. Z55 Auto Ride Suspension	
R	02-13	CHEVROLET AVALANCHE 1500 4WD Exc. Z55 Auto Ride Suspension	
R	02-06	AVALANCHE 2500 4WD Exc. Z55 Auto Ride Suspension	
R	07-22	PICKUP 1/2 TON, SILVERADO 1500 All	
R	07	PICKUP 1/2 TON, SILVERADO 1500 All Exc. Z55 Auto Ride Suspension	
R	99-06	PICKUP 1/2 TON, SILVERADO 1500 RWD Exc. Z55 Auto Ride Suspension	
R	19	SILVERADO 1500 LD All	
R	00-11	SUBURBAN 1/2 TON, 1500 4WD Exc. Z55 Auto Ride Suspension	
R	00-11	SUBURBAN 3/4 TON, 2500 4WD Exc. Z55 Auto Ride Suspension	
R	00-11	TAHOE 4WD Exc. Z55 Auto Ride Suspension	
R	94-01	DODGE PICKUP 1/2 TON, RAM 1500 (SEE RAM 1500) All	
R	94-02	PICKUP 1 TON, RAM 3500 (SEE RAM 3500) RWD Exc. Solid Front Axle	
R	94-02	PICKUP 3/4 TON, RAM 2500 (SEE RAM 2500) All Exc. 8800# GVW	
R	19-22	GMC SIERRA 1500 All	
R	07-18	SIERRA 1500 4WD	
R	99-18	SIERRA 1500 RWD Exc. Z55 Auto Ride Suspension	
R	19	SIERRA 1500 LIMITED All	
R	00-11	YUKON 4WD Exc. Z55 Auto Ride Suspension	
R	00-11	YUKON XL 1/2 TON 4WD Exc. Z55 Auto Ride Suspension	
R	00-11	YUKON XL 3/4 TON 4WD Exc. Z55 Auto Ride Suspension	
49236	B		141099
R	90-07	CHRYSLER TOWN & COUNTRY All	
R	00-03	VOYAGER / GRAND VOYAGER All Exc. Hydraulic Self-Leveling System	
R	00-02	VOYAGER / GRAND VOYAGER All	
R	96-07	DODGE CARAVAN / GRAND CARAVAN All Exc. Hydraulic Self-Leveling System	

HiJackers

Shock	POP	Alternative No.	MTG Acc. Supplied
Pos.	Year	Application	
49236	B (cont)		141099
R	84-95	CARAVAN / GRAND CARAVAN All	
R	87-88	MINI RAM All	
R	03-08	HONDA PILOT All	
R	96-00	PLYMOUTH VOYAGER / GRAND VOYAGER Non-ABS	
R	84-95	VOYAGER / GRAND VOYAGER All	
49237	W		142700,141099
R	00-03	FORD LOBO Harley-Davidson Edition, RWD	
R	00-03	LOBO XLT, RWD	
R	00	LOBO Base, RWD	
R	00	LOBO Lariat, RWD	
R	97-98	LOBO RWD	
R	04	PICKUP 1/2 TON, F-150 RWD	
R	00-03	PICKUP 1/2 TON, F-150 Harley-Davidson Edition, RWD	
R	99-03	PICKUP 1/2 TON, F-150 Lariat, RWD	
R	99-03	PICKUP 1/2 TON, F-150 XL, RWD	
R	99-03	PICKUP 1/2 TON, F-150 XLT, RWD	
R	00	PICKUP 1/2 TON, F-150 Base, RWD	
R	97-98	PICKUP 1/2 TON, F-150 RWD	
R	97-99	PICKUP 3/4 TON, F-250 / SUPERDUTY RWD Up through 8500# GVW	
R	07-21	TOYOTA TUNDRA 4WD	
49254	A		141099, 141572
R	97-02	CADILLAC ELDORADO All Exc. Electronic Ride Control	
49255	D		141099,143331
R	00-05	BUICK LESABRE All With OE Style air fitting	
R	97-05	PARK AVENUE All With OE Style air fitting	
R	95-99	RIVIERA All With OE Style air fitting	
R	00-05	CADILLAC DEVILLE All w/ OE Style air fitting Exc. Electronic Adjustable Suspension	
R	98-04	SEVILLE All w/ OE Style air fitting Exc. Electronic Adjustable Suspension	
R	01-03	OLDSMOBILE AURORA All With OE Style air fitting	
R	95-99	AURORA All With OE Style air fitting	
R	00-04	PONTIAC BONNEVILLE All With OE Style air fitting	
49304	A		140733,141099
R	63-82	CHEVROLET CORVETTE All	
49307	A		141099
R	52-77	VOLKSWAGEN BEETLE All	
R	69-73	FASTBACK All	
R	66-73	SQUAREBACK All	
R	74-79	SUPER BEETLE All	
R	71-73	SUPER BEETLE All 3 Bolt Flange-Type Lower Mount	
R	73-74	THING All	
49310	C		140788,141099
R	57-58	BUICK CENTURY All	
R	58	LIMITED All	
R	57-58	ROADMASTER All Exc. Air Suspension	
R	57-58	SPECIAL All Exc. Air Suspension	
R	57-58	SUPER All Exc. Air Suspension	
R	75-80	DODGE COLT Wagon	
R	71-74	COLT All	
R	79-82	D50 RWD	
R	87-93	PICKUP, RAM 50 RWD	
R	83-86	PICKUP, RAM 50 All	
R	67	FIAT 124 Wagon	
R	66	124 All Wagon	
R	66-67	1100 All Wagon	
R	64-67	1500 All Wagon	
R	50-51	FORD COUNTRY SEDAN All	
R	50-51	CRESTLINE All	
R	50-51	CUSTOM All	
R	47-51	DELUXE All Direct Acting Shocks	
R	61-64	PICKUP 1/2 TON, F-100 All	
R	47-48	SUPER DELUXE All	
R	51	VICTORIA All	
R	68	INTERNATIONAL 908C All	
R	68	1000C All	
R	68	1100C All Exc. 166" Wheelbase	
R	68	1200C All Exc. 166" Wheelbase	
R	68	1300C All Exc. 166" Wheelbase	
R	68-72	M1100 / M1200 All	
R	69	M1400 All	
R	72-83	JEEP CJ5 All Exc. Lift Kit	
R	66-71	CJ5 All	

Numerical listing

Shock	POP	Alternative No.	MTG Acc. Supplied
Pos.	Year	Application	
49310	C (cont)		140788,141099
R	72-75	CJ6 All Exc. Lift Kit	
R	66-71	CJ6 All	
R	76-86	CJ7 All Exc. Lift Kit	
R	66-74	DJ5 All Exc. Lift Kit	
R	66-68	DJ6 All	
R	57-60	FC150 All	
R	63-65	FC170 All	
R	64-66	GLADIATOR All	
R	63	GLADIATOR All Independent Front Suspension	
R	70-71	JEEPSTER All	
R	81-85	SCRAMBLER / CJ8 All	
R	61-67	UNIVERSAL All	
R	86-87	MAZDA B2000 RWD	
R	87-93	B2200 RWD	
R	87-93	B2600 RWD	
R	95-96	MINI MIGHTY MAX All	
R	83-94	MIGHTY MAX RWD	
R	87-90	VAN All	
R	78-81	NISSAN 510 Wagon	
R	98-04	FRONTIER RWD Exc. Desert Runner	
R	83-84	MAXIMA Wagon	
R	87-97	PICKUP RWD	
R	86	PICKUP RWD Mfg. from 8/86	
R	51-56	OLDSMOBILE 98 All	
R	76-80	PLYMOUTH COLT All	
R	79-82	PICKUP All	
R	57-60	PONTIAC BONNEVILLE All	
R	50-60	CATALINA All	
R	49-58	CHIEFTAIN All	
R	54-60	STAR CHIEF All	
R	49-52	STREAMLINER All	
R	57-58	SUPER CHIEF All	
R	60	VENTURA All	
R	73-78	TOYOTA CORONA Wagon	
R	69-71	CORONA Mark II, Wagon	
R	65-66	CROWN Wagon	
R	69-74	LAND CRUISER All Exc. Wagon	
R	67-68	LAND CRUISER All	
R	85-95	PICKUP RWD Exc. 1 Ton	
R	84	PICKUP RWD	
R	84-88	VAN Leaf (RearSpringType)	
R	88	VAN WAGON All	
49311	B		141099
R	81-82	CHEVROLET LUV PICKUP All	
R	55	PICKUP 3100	
R	55	PICKUP All 3124 2nd Series	
R	87-89	DODGE RAIDER 2.6L 4Cyl L (156)	
R	61-67	FORD ECONOLINE All	
R	89-94	ISUZU AMIGO All	
R	81-95	PICKUP All	
R	84-86	TROOPER 4WD	
R	86-92	JEEP COMANCHE All	
R	66-67	GLADIATOR All	
R	64-65	GLADIATOR All Exc. Independent Front Suspension	
R	66-73	WAGONEER All	
R	63-65	WAGONEER All Exc. Independent Front Suspension	
R	49-52	MERCURY MERCURY All	
R	50-51	MONTEREY All	
R	83-89	MINI MONTERO All	
R	97-99	MONTERO SPORT All	
R	82-86	NISSAN 720 PICKUP 4WD	
R	00-04	FRONTIER Crew Cab Pickup, RWD w/ Desert Runner	
R	98-04	FRONTIER 4WD	
R	98-99	FRONTIER RWD Crew Cab; w/ Desert Runner Package	
R	87-95	PATHFINDER All Exc. Electronic Adjustable Suspension	
R	87-97	PICKUP 4WD	
R	86	PICKUP 4WD Mfg. from 8/86	
R	00-04	XTERRA All	
R	76-87	TOYOTA LAND CRUISER All	
R	75	LAND CRUISER All Mfg. from 1/75	
R	69-74	LAND CRUISER All Wagon	
R	85-92	PICKUP RWD 1 Ton	
R	80-83	PICKUP 4WD Exc. Lift Kit	
49334	A		140630,141099
R	78-81	BUICK CENTURY All	
R	78-87	REGAL All	
R	78-87	CHEVROLET EL CAMINO All	
R	78-83	MALIBU All	
R	73-88	MONTE CARLO All	
R	78-87	GMC SPRINT / CABALLERO RWD	
R	79-87	OLDSMOBILE CUTLASS / CUTLASS SUPREME All	
R	78-79	CUTLASS / CUTLASS SUPREME Vista Cruiser	

Numerical listing

Shock	POP	Alternative No.	MTG Acc. Supplied
Pos.	Year	Application	
49334	A (cont)	140630,141099	
R	76-77	CUTLASS / CUTLASS SUPREME Wagon	
R	80-83	CUTLASS CLASSIC / CUTLASS CRUISER All	
R	82-86	PONTIAC BONNEVILLE All	
R	78-80	GRAND AM All	
R	78-83	GRAND LEMANS All	
R	69-87	GRAND PRIX All	
R	68-81	LEMANS All	
49369	W	141099	
R	84-93	CHRYSLER DAYTONA All	
R	83-84	E CLASS All	
R	85	EXECUTIVE LIMOUSINE All	
R	83-84	EXECUTIVE SEDAN All	
R	90-93	IMPERIAL All Exc. Hydraulic Self-Leveling System	
R	84-86	LASER All	
R	82-95	LEBARON All	
R	81	LEBARON All Exc. M Body	
R	88-93	NEW YORKER All Exc. Hydraulic Self-Leveling System	
R	83-87	NEW YORKER All	
R	82-88	TOWN & COUNTRY All	
R	82-83	DODGE 400 All	
R	83-88	600 All	
R	81-89	ARIES All	
R	89-93	DAYTONA ES	
R	89-90	DAYTONA ES Turbo	
R	87-88	DAYTONA Pacifica	
R	86	DAYTONA Turbo Z	
R	84-85	DAYTONA Turbo	
R	85-89	LANCER All	
R	87-94	SHADOW All	
R	89-95	SPIRIT All	
R	89-95	PLYMOUTH ACCLAIM All	
R	88	CARAVELLE FWD	
R	83-87	CARAVELLE All	
R	81-89	RELIANT All	
R	87-94	SUNDANCE All	
49387	C	140921,141099	
R	96-02	TOYOTA 4RUNNER All	
49388	W	140921,141099	
R	90-95	TOYOTA 4RUNNER All	
Ultra Struts			
G51077	W	142106	
F	96-02	TOYOTA 4RUNNER 4WD	
F	98-04	TACOMA Pre Runner, RWD	
F	95-04	TACOMA 4WD	
G51087	W	142106	
R	96-99	INFINITI I30 All	
R	95-99	NISSAN MAXIMA All	
G51097	W	142106	
F	96-99	AUDI A4 Base Exc. Sport Suspension	
F	96-00	A4 QUATTRO Base Mfg. to 11/00; Exc. Sport Suspension	
F	98-01	VOLKSWAGEN PASSAT FWD From VIN# 3B300001 through VIN# 3B300000	
G51252	W	142094	
R	95-99	TOYOTA PASEO All	
R	95-99	TERCEL All	
G51255	W	141544	
F	97-01	HONDA CR-V All	
G51256	W	141544	
R	97-01	HONDA CR-V All	
G51267	W	141544	
F	99-00	CHRYSLER CIRRUS J2 (MfrBodyCode)	
F	01-06	SEBRING JR (MfrBodyCode), Convertible	
F	01-05	SEBRING JR (MfrBodyCode), Sedan	
F	99-00	SEBRING Convertible	
F	99-06	DODGE STRATUS Sedan	
F	99-00	PLYMOUTH BREEZE All	
G51268	W	141544	
R	99-00	CHRYSLER CIRRUS All	
R	01-06	SEBRING JR (MfrBodyCode), Convertible	
R	01-06	SEBRING JR (MfrBodyCode), Sedan	
R	99-00	SEBRING Convertible	
R	99-06	DODGE STRATUS Sedan	

HiJackers, Ultra Struts

Shock	POP	Alternative No.	MTG Acc. Supplied
Pos.	Year	Application	
G51268	W (cont)	142094	
R	99-00	PLYMOUTH BREEZE All	
G51279	W	142094	
R	00-06	NISSAN SENTRA All	
G51286	W	141544	
R	02-06	HONDA CR-V All	
G51477	W	143008	
F	01-07	TOYOTA SEQUOIA All	
F	00-06	TUNDRA All Exc. Air Suspension	
G51700	W	141544	
R	01-03	ACURA EL All	
R	01-02	HONDA CIVIC All	
G51703	W	142874	
F	04-08	FORD LOBO RWD	
F	04-08	PICKUP 1/2 TON, F-150 RWD	
F	06-08	LINCOLN MARK LT RWD	
G51704	W	142874	
F	04-08	FORD LOBO 4WD	
F	04-08	PICKUP 1/2 TON, F-150 4WD	
F	06-08	LINCOLN MARK LT 4WD	
G51712	W	142094	
R	95-98	EAGLE TALON AWD	
R	00-05	MITSUBISHI ECLIPSE All	
R	95-99	ECLIPSE AWD	
G51713	W	141544	
R	01-05	HYUNDAI SONATA All	
R	00	SONATA All Mfg. from 4/00	
R	01	XG300 All	
R	02-05	XG350 All	
R	01-06	KIA MAGENTIS All	
R	01-06	OPTIMA All	
G51714	W	141544	
F	01-05	HYUNDAI SONATA All	
F	00	SONATA All Mfg. from 8/00	
F	01-06	KIA MAGENTIS All	
F	01-06	OPTIMA All	
G51715	W	141544	
F	04-10	INFINITI QX56 All	
F	05-15	NISSAN ARMADA All Exc. Auto-Leveling System	
F	04	PATHFINDER ARMADA All	
F	17-22	TITAN All	
F	04-15	TITAN All	
G51716	W	141544	
R	04-05	HONDA CIVIC Value Package	
R	03-05	CIVIC DX	
R	03-05	CIVIC EX	
R	03-05	CIVIC GX	
R	03-05	CIVIC HX	
R	03-05	CIVIC LX	
R	03-05	CIVIC Si	
R	05	CIVIC EX Special Edition	
R	05	CIVIC LX Special Edition	
R	05	CIVIC Reverb	
R	03-04	CIVIC SiR	
G51718	B	141544	
F	04-07	BUICK RAINIER All	
F	03-06	CHEVROLET SSR All	
F	06-09	TRAILBLAZER LT	
F	06-08	TRAILBLAZER Base	
F	06-07	TRAILBLAZER A	
F	06-07	TRAILBLAZER B	
F	06-07	TRAILBLAZER LS	
F	02-05	TRAILBLAZER All	
F	02-06	TRAILBLAZER EXT All	
F	02-09	GMC ENVOY All	
F	02-06	ENVOY XL All	
F	04-05	ENVOY XUV All	
F	03-08	ISUZU ASCENDER All	
F	02-04	OLDSMOBILE BRAVADA All	
F	05-09	SAAB 9-7X All	
G51719	W	141544	
F	03-06	FORD EXPEDITION RWD	
G51722	W	141544	
F	02-03	FORD EXPLORER Eddie Bauer	
F	02-03	EXPLORER Limited	
F	02-03	EXPLORER Postal	
F	02-03	EXPLORER XLS	
F	02-03	EXPLORER XLT	
F	02-03	MERCURY MOUNTAINEER All	
G51723	W	141544	
F	04-05	FORD EXPLORER Eddie Bauer	

Numerical listing

Shock	POP	Alternative No.	MTG Acc. Supplied
Pos.	Year	Application	
G51723	W (cont)	141544	
F	04-05	EXPLORER Limited	
F	04-05	EXPLORER XLS	
F	04-05	EXPLORER XLT	
F	04	EXPLORER NBX	
F	04-05	MERCURY MOUNTAINEER All	
G51724	W	141544	
R	02-05	FORD EXPLORER Eddie Bauer	
R	02-05	EXPLORER Limited	
R	02-05	EXPLORER XLS	
R	02-05	EXPLORER XLT	
R	04	EXPLORER NBX	
R	02-03	EXPLORER Postal	
R	02-05	MERCURY MOUNTAINEER All	
G51727	W	141544	
R	00-01	INFINITI I30 All	
R	02-04	I35 All	
R	00-03	NISSAN MAXIMA All	
G51728	W	141544	
F	07-11	DODGE NITRO All	
F	02-12	JEEP LIBERTY All	
G51729	C	141544	
R	03-06	FORD EXPEDITION All	
R	03-06	LINCOLN NAVIGATOR All	
G51736	D	141544	
R	03-08	PONTIAC VIBE FWD	
R	03-08	TOYOTA COROLLA All	
R	03-08	MATRIX FWD	
G51737	W	141544	
F	04-08	ACURA TL All	
F	04-08	TSX All	
F	06-07	HONDA ACCORD Value Package	
F	03-07	ACCORD EX	
F	03-07	ACCORD LX	
F	03-05	ACCORD DX	
F	05	ACCORD SE	
F	03	ACCORD Coupe	
G51738	W	141544	
R	04-08	ACURA TL All	
R	06-07	HONDA ACCORD Value Package	
R	03-07	ACCORD EX	
R	03-07	ACCORD LX	
R	03-05	ACCORD DX	
R	05	ACCORD SE	
R	03	ACCORD Coupe	
G51739	W	141544	
F	03-18	TOYOTA 4RUNNER All	
F	07-14	FJ CRUISER All	
F	16-21	TACOMA 4WD	
F	14-15	TACOMA 4WD Exc. Off Road	
F	05-15	TACOMA Pre Runner 4WD	
F	05-13	TACOMA 4WD	
G51740	W	141544	
F	00-08	AUDI A4 All	
F	05-08	A4 QUATTRO Elite Mfg. from 11/00; Exc. Sport Suspension	
F	04-08	A4 QUATTRO Cabriolet Mfg. from 11/00; Exc. Sport Suspension	
F	00-08	A4 QUATTRO Base Mfg. from 11/00; Exc. Sport Suspension	
F	08	A4 QUATTRO S Line Mfg. from 11/00; Exc. Sport Suspension	
F	08	A4 QUATTRO Trendy Mfg. from 11/00; Exc. Sport Suspension	
F	06-07	A4 QUATTRO DTM Mfg. from 11/00; Exc. Sport Suspension	
F	05-06	A4 QUATTRO S Line Mfg. from 11/00; Exc. Sport Suspension	
F	06	A4 QUATTRO Vanguard Mfg. from 11/00; Exc. Sport Suspension	
F	02-05	A4 QUATTRO Luxury Mfg. from 11/00; Exc. Sport Suspension	
F	01	A4 QUATTRO Confort Mfg. from 11/00; Exc. Sport Suspension	
G51742	W	141544	
R	95-04	AUDI A6 QUATTRO All	
R	84-86	QUATTRO All	
R	99-05	VOLKSWAGEN PASSAT AWD Exc. VIN# 3B300001 through VIN# 3B300000	
R	98	PASSAT All AWD; Exc. VIN# 3B300001 through VIN# 3B300000	
G51746	W	141544	
F	03-07	CADILLAC CTS All Exc. Magnetic Ride Control Suspension	

Numerical listing

Shock	POP	Alternative No.	MTG Acc. Supplied
Pos.	Year	Application	
G51756	W		
F	00-04	LINCOLN LS All	
G51758	W		
F	06-08	DODGE PICKUP 1/2 TON, RAM 1500 (SEE RAM 1500) 4WD Exc. Mega Cab	
G51759	W		
R	00-05	SATURN L / LS / LW SERIES All	
G51760	W		
F	05-10	CHRYSLER 300 RWD Right Exc. Performance Suspension	
F	06-10	DODGE CHARGER RWD Right Exc. Police Models	
F	05-08	MAGNUM RWD Right Exc. Performance Suspension	
G51761	W		
F	05-10	CHRYSLER 300 RWD Left Exc. Performance Suspension	
F	06-10	DODGE CHARGER RWD Left Exc. Police Models	
F	05-08	MAGNUM RWD Left Exc. Performance Suspension	
G51765	W		
F	12	NISSAN PATHFINDER All Mfg. to 8/12	
F	05-11	PATHFINDER All	
F	13-15	XTERRA All	
F	12	XTERRA All Mfg. to 12/12	
F	05-11	XTERRA All	
F	09-12	SUZUKI EQUATOR All	
G51766	W		
F	20-21	NISSAN FRONTIER All Exc. Nismo Off Road	
F	17-19	FRONTIER All	
F	13-16	FRONTIER PRO-4X	
F	13-16	FRONTIER SL	
F	11-16	FRONTIER S	
F	11-16	FRONTIER SV	
F	13-15	FRONTIER LE	
F	05-15	FRONTIER XE	
F	12	FRONTIER LE Mfg. to 12/12	
F	12	FRONTIER PRO-4X Mfg. to 12/12	
F	12	FRONTIER SL Mfg. to 12/12	
F	09-11	FRONTIER PRO-4X	
F	05-11	FRONTIER LE	
F	11	FRONTIER SL	
F	05-10	FRONTIER SE	
G51767	D		
R	03-06	SUBARU BAJA All	
R	00-04	OUTBACK All	
G51768	W		
R	03-06	PONTIAC VIBE AWD	
R	03-06	TOYOTA MATRIX AWD	
G51772	W		
R	97-03	MITSUBISHI DIAMANTE All	
G51773	W		
R	00-05	JAGUAR S TYPE All Mfg. to 6/02 Exc. Computer Active Technology Suspension	
G51774	W		
F	04-06	KIA AMANTI All	
G51794	W		
R	02-07	MITSUBISHI LANCER LS	
R	07	LANCER LS Diamond	
R	04-06	LANCER Ralliart	
R	02-06	LANCER OZ Rally	
R	06	LANCER DE	
R	06	LANCER SE	
R	04	LANCER DE	
R	04	LANCER Sportback	
G51795	W		
R	04-09	TOYOTA PRIUS All	
G51806	D		
F	06-10	HYUNDAI AZERA All	
F	06-10	SONATA All	
G51810	W		
F	03-08	MAZDA 6 All Left	
G51811	W		
F	03-08	MAZDA 6 All Right	

Ultra Struts

Shock	POP	Alternative No.	MTG Acc. Supplied
Pos.	Year	Application	
G51813	W		
F	03-07	INFINITI G35 Coupe Left Sport Suspension	
F	03-05	NISSAN 350Z All Left	
G51814	W		
F	03-07	INFINITI G35 Coupe Right Sport Suspension	
F	03-05	NISSAN 350Z All Right	
G51815	D		
F	05-09	DODGE DAKOTA All	
F	06-09	MITSUBISHI RAIDER All	
G51825	W		
R	04-06	KIA AMANTI All	
G51832	W		
F	01-06	LEXUS LS430 All	
G51833	W		
R	01-06	LEXUS LS430 All	
G51836	W		
F	03-05	LINCOLN AVIATOR All	
G51838	W		
R	03-04	MITSUBISHI OUTLANDER All	
G51842	W		
R	07-12	DODGE CALIBER All	
R	07-10	JEEP COMPASS All	
R	07-10	PATRIOT All	
G51847	W		
R	04-08	ACURA TSX All	
G51848	W		
R	09-10	DODGE JOURNEY FWD	
G51849	W		
R	05-07	FORD FIVE HUNDRED FWD	
R	05-07	MERCURY MONTEGO FWD	
G51850	W		
F	04-12	CHEVROLET COLORADO RWD, Coil (FrontSpringType) D Standard Suspension; Exc. Z71 Off Road Package	
F	04-11	GMC CANYON RWD, Coil (FrontSpringType) Exc. Z71 Off Road Package	
F	06	ISUZU I-280 RWD, Coil (FrontSpringType) Exc. Z71 Off Road Package	
F	07-08	I-290 RWD, Coil (FrontSpringType) Exc. Z71 Off Road Package	
F	08	I-370 RWD, Coil (FrontSpringType) Exc. Z71 Off Road Package	
F	07	I-370 RWD	
G51852	W		
R	05-10	SCION TC All	
G51853	W		
F	05-15	TOYOTA TACOMA Base, RWD Left	
F	05-15	TACOMA Pre Runner, RWD Left	
G51854	W		
F	05-15	TOYOTA TACOMA Base, RWD Right	
F	05-15	TACOMA Pre Runner, RWD Right	
G51855	W		
F	07-20	TOYOTA TUNDRA All	
G51856	D		
F	09-10	DODGE PICKUP 1/2 TON, RAM 1500 (SEE RAM 1500) 4WD	
F	16-18	RAM 1500 (SEE DODGE RAM 1500) 4WD Exc. Air Suspension	
F	11-15	1500 (SEE DODGE RAM 1500) 4WD	
F	19-20	1500 CLASSIC 4WD Old Body Style	
G51858	W		
R	03-11	HONDA ELEMENT All	
G51859	W		
F	06-09	FORD FUSION All	
F	07-09	LINCOLN MKZ All	
F	06	ZEPHYR All	
F	06-09	MERCURY MILAN All	
G51860	W		
F	07-13	FORD EXPEDITION Coil (RearSpringType) Exc. Air Suspension	

Numerical listing

Shock	POP	Alternative No.	MTG Acc. Supplied
Pos.	Year	Application	
G51860	W (cont)		
F	07-13	LINCOLN NAVIGATOR All	
G51861	W		
R	17-21	FORD EXPEDITION All	
R	07-16	EXPEDITION Coil (FrontSpringType) Exc. Air Suspension	
R	07-17	LINCOLN NAVIGATOR All Exc. Air Suspension	
G51863	D		
R	14	CHRYSLER 200 All	
R	11-13	200 All Standard Suspension	
R	07-10	SEBRING All	
R	08-14	DODGE AVENGER All	
G51864	W		
F	09-13	FORD LOBO 4WD	
F	09-13	PICKUP 1/2 TON, F-150 4WD	
F	10-12	LINCOLN MARK LT AWD	
G51865	W		
F	09-13	FORD LOBO RWD	
F	09-13	PICKUP 1/2 TON, F-150 RWD	
G51870	B		
F	08-13	CHEVROLET PICKUP 1/2 TON, SILVERADO 1500 All Exc. Electronic Adjustable Suspension	
F	07	PICKUP 1/2 TON, SILVERADO 1500 Base Exc. Electronic Adjustable Suspension	
F	07	PICKUP 1/2 TON, SILVERADO 1500 LT Exc. Electronic Adjustable Suspension	
F	07	PICKUP 1/2 TON, SILVERADO 1500 LTZ Exc. Electronic Adjustable Suspension	
F	07	PICKUP 1/2 TON, SILVERADO 1500 WT Exc. Electronic Adjustable Suspension	
F	08-13	GMC SIERRA 1500 All Exc. Electronic Adjustable Suspension	
F	07	SIERRA 1500 SLE Exc. Electronic Adjustable Suspension	
F	07	SIERRA 1500 SLT Exc. Electronic Adjustable Suspension	
F	07	SIERRA 1500 WT Exc. Electronic Adjustable Suspension	
G51877	W		
F	08-12	HONDA ACCORD All Left	
G51878	W		
F	08-12	HONDA ACCORD All Right	
G51879	W		
R	07-11	HONDA CR-V All	
G51880	W		
R	06-14	HONDA RIDGELINE All	
G51881	W		
R	02-06	MINI COOPER All	
G51883	W		
R	10-12	MITSUBISHI GALANT SE	
R	04-11	GALANT ES	
R	04-08	GALANT DE	
R	05-07	GALANT SE	
G51887	W		
F	10-11	FORD CROWN VICTORIA Base	
F	07-11	CROWN VICTORIA LX	
F	03-08	CROWN VICTORIA Base	
F	04-06	CROWN VICTORIA LX Sport	
F	05	CROWN VICTORIA Special Edition	
F	03	CROWN VICTORIA LWB	
F	03	CROWN VICTORIA S	
F	03-11	LINCOLN TOWN CAR All Exc. Limo	
F	03-11	MERCURY GRAND MARQUIS All	
G51888	W		
F	03-11	FORD CROWN VICTORIA Police Interceptor	
F	03-11	LINCOLN TOWN CAR All Limo Models	
F	03-04	MERCURY MARAUDER All	
G51891	C		
F	07-13	CHEVROLET AVALANCHE 1500 All Exc. Z55 or ZW7 Ride Suspension	
F	07-14	SUBURBAN 1/2 TON, 1500 All Exc. Z55 or ZW7 Ride Suspension	

Numerical listing

Shock	POP	Alternative No.	MTG Acc. Supplied
Pos.	Year	Application	
G51891 C (cont)			
F	07-14	TAHOE All Exc. Z55 or ZW7 Ride Suspension	
F	07-14	GMC YUKON All Exc. Z55 or ZW7 Ride Suspension	
F	07-14	YUKON XL 1/2 TON All Exc. Z55 or ZW7 Ride Suspension	
G51892 W			
R	15-17	HONDA ACCORD All	
R	13-14	ACCORD Sedan	
R	08-12	ACCORD All	
G51896 W			
F	10-12	FORD FUSION All Left	
F	10-12	LINCOLN MKZ All Left	
F	10-11	MERCURY MILAN All Left	
G51897 W			
F	10-12	FORD FUSION All Right	
F	10-12	LINCOLN MKZ All Right	
F	10-11	MERCURY MILAN All Right	
G51898 W			
R	09-10	PONTIAC VIBE FWD	
R	09-17	TOYOTA COROLLA All	
R	09-14	MATRIX FWD	
G51899 W			
F	01	HYUNDAI XG300 All	
F	02-05	XG350 All	
G51900 W			
R	04-08	BMW 525I All	
R	04-08	530I All	
G51901 W			
F	08-11	CADILLAC CTS All Exc. Magnetic Ride Control Suspension	
G51906 W			
F	06-08	MAZDA MX-5 All	
F	06-08	MX-5 MIATA All	
G51908 D			
R	08-11	MITSUBISHI LANCER DE	
R	08-11	LANCER ES	
G51910 W			
R	05-09	SUBARU OUTBACK All	
G51911 D			
F	05-12	ACURA RL All	
G51914 W			
R	05-06	ACURA RSX All	
G51916 W			
R	10-15	CHEVROLET CAMARO 3.6L 6Cyl V (217)	
G51917 W			
F	09-14	ACURA TL All Left	
G51918 W			
F	09-14	ACURA TL All Right	
G51919 W			
R	09-14	ACURA TL All	
R	09-14	TSX All	
G51920 W			
F	06-15	LEXUS IS250 RWD Left	
F	06-15	IS350 RWD Left	
G51921 W			
F	06-15	LEXUS IS250 RWD Right	
F	06-15	IS350 RWD Right	
G51922 W			
R	06-13	LEXUS IS250 RWD	
R	06-13	IS350 RWD	
G51925 W			
F	06-07	INFINITI M35 RWD Left	
F	06-07	M45 All Left	
G51926 W			
F	06-07	INFINITI M35 RWD Right	
F	06-07	M45 All Right	
G51928 W			
R	04-10	VOLKSWAGEN TOUAREG All Exc. Air Suspension	
G51933 W			
R	10-11	MITSUBISHI ENDEAVOR AWD	
R	04-08	ENDEAVOR AWD	

Ultra Struts

Shock	POP	Alternative No.	MTG Acc. Supplied
Pos.	Year	Application	
G51934 W			
R	07-13	MINI COOPER All	
G51935 W			
F	06-09	PONTIAC SOLSTICE All	
G51937 W			
F	17	TOYOTA SEQUOIA All Exc. Air Suspension	
F	08-16	SEQUOIA All	
G51947 W			
F	05-10	CHRYSLER 300 RWD Left Performance Suspension	
F	08-10	DODGE CHALLENGER All Left	
F	06-10	CHARGER RWD Left Police Package	
F	05-08	MAGNUM RWD Left Performance Suspension	
G51948 W			
F	05-10	CHRYSLER 300 RWD Right Performance Suspension	
F	08-10	DODGE CHALLENGER All Right	
F	06-10	CHARGER RWD Right Police Package	
F	05-08	MAGNUM RWD Right Performance Suspension	
G51949 D			
F	14-18	CHEVROLET PICKUP 1/2 TON, SILVERADO 1500 All	
F	14-18	GMC SIERRA 1500 All	
G51961 W			
R	09-13	SUBARU FORESTER All	
G51969 W			
R	04-06	MITSUBISHI GALANT LS	
G51979 W			
F	05-06	INFINITI G35 AWD Left	
G51981 W			
F	05-06	INFINITI G35 AWD Right	
G51995 B			
R	05	LEXUS SC430 All Mfg to 0/05; For Large Spring Seat Design 134MM or 5.275 Inches	
R	02-04	SC430 All For Large Spring Seat Design 134MM or 5.275 Inches	
G52004 W			
F	06-12	TOYOTA RAV4 All Left	
G52005 W			
F	12-13	MAZDA 3 GS-SKY Left	
F	10-13	3 GT Left	
F	10-13	3 GX Left	
F	10-13	3 i Left	
F	10-13	3 S Left	
F	13	3 Grand Touring Left	
F	13	3 I Touring Left	
F	10-12	3 GS Left	
F	11	3 Sport GS Left	
F	11	3 Sport GT Left	
F	11	3 Sport GX Left	
F	08-09	3 GS Left Exc. Turbo, Exc. Models w/ 17" Wheels	
F	08-09	3 GT Left Exc. Turbo, Exc. Models w/ 17" Wheels	
F	08-09	3 GX Left Exc. Turbo, Exc. Models w/ 17" Wheels	
F	07-09	3 i Left Exc. Turbo, Exc. Models w/ 17" Wheels	
F	07-09	3 S Left Exc. Turbo, Exc. Models w/ 17" Wheels	
F	04-06	3 All Left	
F	06-10	5 All Left	
G52006 W			
F	12-13	MAZDA 3 GS-SKY Right	
F	10-13	3 GT Right	
F	10-13	3 GX Right	
F	10-13	3 i Right	
F	10-13	3 S Right	
F	13	3 Grand Touring Right	
F	13	3 I Touring Right	
F	10-12	3 GS Right	
F	11	3 Sport GS Right	
F	11	3 Sport GT Right	
F	11	3 Sport GX Right	
F	08-09	3 GS Right Exc. Turbo, Exc. Models w/ 17" Wheels	
F	08-09	3 GT Right Exc. Turbo, Exc. Models w/ 17" Wheels	

Numerical listing

Shock	POP	Alternative No.	MTG Acc. Supplied
Pos.	Year	Application	
G52006 W (cont)			
F	08-09	3 GX Right Exc. Turbo, Exc. Models w/ 17" Wheels	
F	07-09	3 i Right Exc. Turbo, Exc. Models w/ 17" Wheels	
F	07-09	3 S Right Exc. Turbo, Exc. Models w/ 17" Wheels	
F	04-06	3 All Right	
F	06-10	5 All Right	
G52007 W			
F	06-12	TOYOTA RAV4 All Right	
G52008 W			
F	03-07	NISSAN MURANO All Left	
G52009 W			
F	03-07	NISSAN MURANO All Right	
G52013 W			
F	03-08	PONTIAC VIBE FWD Left	
F	08	VIBE All Left	
F	03-08	TOYOTA MATRIX All Left	
G52014 W			
F	03-08	PONTIAC VIBE FWD Right	
F	03-08	TOYOTA MATRIX All Right	
G52017 W			
R	02-03	KIA SPECTRA All Left	
G52018 W			
R	02-03	KIA SPECTRA All Right	
G52019 W			
F	02-03	SUZUKI AERIO All Left	
G52022 W			
R	02-07	SUZUKI AERIO All Right	
G52023 W			
F	05-09	SUBARU LEGACY All Left	
G52024 W			
F	05-09	SUBARU LEGACY All Right	
G52025 W			
F	05-07	BUICK TERRAZA All Exc. Auto-Leveling System	
F	05-09	CHEVROLET UPLANDER All Exc. Auto-Leveling System	
F	05-09	PONTIAC MONTANA SV6 Exc. Self-Leveling Suspension	
F	05-07	SATURN RELAY All Exc. Auto-Leveling System	
G52026 W			
F	02-07	SATURN VUE All Left	
G52027 W			
F	02-07	SATURN VUE All Right	
G52032 W			
F	04-09	NISSAN QUEST All Left	
G52033 W			
F	04-09	NISSAN QUEST All Right	
G52036 W			
F	03-06	KIA SORENTO All Left	
G52037 W			
F	03-06	KIA SORENTO All Right	
G52038 W			
F	06-11	ACURA CSX All Left	
F	10-11	HONDA CIVIC EX-L Left	
F	10-11	CIVIC LX-S Left	
F	08-11	CIVIC DX-G Left	
F	06-11	CIVIC DX Left	
F	06-11	CIVIC EX Left	
F	06-11	CIVIC Hybrid Left	
F	06-11	CIVIC LX Left	
F	11	CIVIC Base Left	
F	09-10	CIVIC Sport Left	
F	08	CIVIC EX-L Left	
F	06-07	CIVIC EXS Left	
F	06-07	CIVIC LXS Left	
G52039 W			
F	06-11	ACURA CSX All Right	
F	10-11	HONDA CIVIC EX-L Right	
F	10-11	CIVIC Hybrid-L Right	
F	10-11	CIVIC LX-S Right	
F	08-11	CIVIC DX-G Right	
F	06-11	CIVIC DX Right	
F	06-11	CIVIC EX Right	
F	06-11	CIVIC Hybrid Right	

Numerical listing

Shock	POP	Alternative No.	MTG Acc. Supplied
Pos.	Year	Application	
G52039	W	(cont)	
F	06-11	CIVIC LX Right	
F	11	CIVIC Base Right	
F	09-10	CIVIC Sport Right	
F	08	CIVIC EX-L Right	
F	06-07	CIVIC EXS Right	
F	06-07	CIVIC LXS Right	
G52081	W		
F	07-12	DODGE CALIBER All Left	
F	07-10	JEEP COMPASS All Left	
F	07-10	PATRIOT All Left	
G52082	W		
F	07-12	DODGE CALIBER All Right	
F	07-10	JEEP COMPASS All Right	
F	07-10	PATRIOT All Right	
G52094	W		
F	07-12	NISSAN SENTRA Base Left	
F	07-12	SENTRA S Left	
F	07-12	SENTRA SL Left	
G52095	W		
F	07-12	NISSAN SENTRA Base Right	
F	07-12	SENTRA S Right	
F	07-12	SENTRA SL Right	
G52096	W		
F	05-10	SCION TC All Left	
G52097	W		
F	05-10	SCION TC All Right	
G52098	W		
F	04-06	SCION XA All	
F	04-06	XB All	
G52103	W		
R	07-12	LEXUS ES350 All Left	
R	06-11	TOYOTA AVALON All Left Mfg. from 1/06	
R	07-11	CAMRY All Left	
G52104	W		
R	07-12	LEXUS ES350 All Right	
R	06-11	TOYOTA AVALON All Right Mfg. from 1/06	
R	07-11	CAMRY All Right	
G52105	W		
F	06-10	TOYOTA SIENNA All Left 8 Passenger	
F	05	SIENNA All Left Mfg. from 7/05; w/ 8 Passenger Seating	
G52106	W		
F	06-10	TOYOTA SIENNA All Right 8 Passenger	
F	05	SIENNA All Right Mfg. from 7/05; w/ 8 Passenger Seating	
G52107	W		
F	06-10	TOYOTA SIENNA FWD Left w/ 7 Passenger Seating	
F	05	SIENNA FWD Left Mfg. from 7/05; w/ 7 Passenger Seating	
G52108	W		
F	06-10	TOYOTA SIENNA FWD Right w/ 7 Passenger Seating	
F	05	SIENNA FWD Right Mfg. from 7/05; w/ 7 Passenger Seating	
G52110	W		
F	05-07	FORD FREESTYLE All Left	
G52111	W		
F	05-07	FORD FREESTYLE All Right	
G52112	W		
F	11	HONDA ELEMENT All Left	
F	04-10	ELEMENT LX Left	
F	03-10	ELEMENT EX Left	
F	03-04	ELEMENT DX Left	
G52113	W		
F	11	HONDA ELEMENT All Right	
F	04-10	ELEMENT LX Right	
F	03-10	ELEMENT EX Right	
F	03-04	ELEMENT DX Right	
G52116	W		
F	06-11	BUICK LUCERNE All Exc. Magnetic Ride Control Suspension	
F	06-11	CADILLAC DTS All Exc. Magnetic Ride Control Suspension	

Ultra Struts

Shock	POP	Alternative No.	MTG Acc. Supplied
Pos.	Year	Application	
G52117	W		
F	11-14	CHRYSLER 200 All Left	
F	08-10	SEBRING All Left	
F	08-14	DODGE AVENGER All Left	
G52118	W		
F	14	CHRYSLER 200 All Right	
F	11-13	200 All Right Standard Suspension	
F	08-10	SEBRING All Right	
F	08-14	DODGE AVENGER All Right	
G52121	W		
F	07-13	NISSAN ALTIMA Base Left	
F	07-13	ALTIMA S Left	
F	07-13	ALTIMA SL Left	
F	13	ALTIMA Advance Left	
F	13	ALTIMA Exclusive Left	
F	13	ALTIMA Sense Left	
F	13	ALTIMA SV Left	
F	10-12	ALTIMA SR Left	
F	08-09	ALTIMA Coupe Left	
F	07-09	ALTIMA SE Left	
G52122	W		
F	07-13	NISSAN ALTIMA Base Right	
F	07-13	ALTIMA S Right	
F	07-13	ALTIMA SL Right	
F	13	ALTIMA Advance Right	
F	13	ALTIMA Exclusive Right	
F	13	ALTIMA Sense Right	
F	13	ALTIMA SV Right	
F	10-12	ALTIMA SR Right	
F	08-09	ALTIMA Coupe Right	
F	07-09	ALTIMA SE Right	
G52125	C		
F	08-12	BUICK ENCLAVE All	
F	09-12	CHEVROLET TRAVERSE All	
F	07-12	GMC ACADIA All	
F	07-10	SATURN OUTLOOK All	
G52127	D		
F	07-17	CHEVROLET EQUINOX All Left Exc. Sport Suspension	
F	10-16	GMC TERRAIN All Left	
F	07-09	PONTIAC TORRENT All Left Exc. Sport Suspension	
F	08-10	SATURN VUE All Left	
F	07-09	SUZUKI XL-7 All Left	
G52128	D		
F	07-17	CHEVROLET EQUINOX All Right Exc. Sport Suspension	
F	10-16	GMC TERRAIN All Right	
F	07-09	PONTIAC TORRENT All Right Exc. Sport Suspension	
F	08-10	SATURN VUE All Right	
F	07-09	SUZUKI XL-7 All Right	
G52129	W		
F	08-09	FORD TAURUS FWD Left	
F	08-09	MERCURY SABLE FWD Left	
G52130	W		
F	08-09	FORD TAURUS FWD Right	
F	08-09	MERCURY SABLE FWD Right	
G52131	D		
F	15-16	CHRYSLER TOWN & COUNTRY Touring Piel	
F	13-16	TOWN & COUNTRY Li	
F	13-16	TOWN & COUNTRY Limited	
F	13-16	TOWN & COUNTRY LX	
F	13-16	TOWN & COUNTRY Touring	
F	13-16	TOWN & COUNTRY Touring L	
F	16	TOWN & COUNTRY Limited Platinum	
F	16	TOWN & COUNTRY Premium	
F	14	TOWN & COUNTRY 30th Anniversary Edition	
F	14	TOWN & COUNTRY Base	
F	08-12	TOWN & COUNTRY All Exc. Self-Leveling Suspension	
F	18-20	DODGE CARAVAN / GRAND CARAVAN Canada Value Package	
F	18-20	CARAVAN / GRAND CARAVAN Crew	
F	18-20	CARAVAN / GRAND CARAVAN Crew Plus	
F	17-20	CARAVAN / GRAND CARAVAN SXT Plus	
F	13-20	CARAVAN / GRAND CARAVAN SE	
F	12-20	CARAVAN / GRAND CARAVAN SXT	
F	20	CARAVAN / GRAND CARAVAN Premium Plus	

Numerical listing

Shock	POP	Alternative No.	MTG Acc. Supplied
Pos.	Year	Application	
G52131	D	(cont)	
F	20	CARAVAN / GRAND CARAVAN SE Plus	
F	18-19	CARAVAN / GRAND CARAVAN SXT Premium Plus	
F	14-16	CARAVAN / GRAND CARAVAN American Value Package	
F	14-16	CARAVAN / GRAND CARAVAN SE Plus	
F	12-14	CARAVAN / GRAND CARAVAN Crew	
F	12-14	CARAVAN / GRAND CARAVAN Crew Plus	
F	14	CARAVAN / GRAND CARAVAN 30th Anniversary Edition	
F	14	CARAVAN / GRAND CARAVAN SE 30th Anniversary Edition	
F	14	CARAVAN / GRAND CARAVAN SE Canada Value Package	
F	14	CARAVAN / GRAND CARAVAN SXT 30th Anniversary Edition	
F	14	CARAVAN / GRAND CARAVAN SXT Plus	
F	13	CARAVAN / GRAND CARAVAN Canada Value Package	
F	12	CARAVAN / GRAND CARAVAN Canada Value Package Exc. Self-Leveling Suspension	
F	12	CARAVAN / GRAND CARAVAN SE Exc. Self-Leveling Suspension	
F	08-11	CARAVAN / GRAND CARAVAN All Exc. Self-Leveling Suspension	
F	09-14	VOLKSWAGEN ROUTAN All Exc. Self-Leveling Suspension	
G52140	W		
F	03-06	ACURA MDX All Left	
G52141	W		
F	03-06	ACURA MDX All Right	
G52142	D		
F	08-13	BMW 128i All Left Exc. Sport Suspension	
F	08-13	135i All Left Exc. Sport Suspension	
F	07-11	323i All Left Exc. Sport Suspension	
F	06	325i All Left Mfg. to 9/01; Sport Suspension	
F	07-13	328i All Left	
F	06	330i All Left	
F	09-11	335D All Left	
F	07-13	335i All Left	
F	11-13	335iS All Left	
G52143	D		
F	08-13	BMW 128i All Right Exc. Sport Suspension	
F	08-13	135i All Right Exc. Sport Suspension	
F	07-11	323i All Right Exc. Sport Suspension	
F	06	325i All Right Mfg. to 9/01; Sport Suspension	
F	07-13	328i All Right	
F	06	330i All Right	
F	09-11	335D All Right	
F	07-13	335i All Right	
F	11-13	335iS All Right	
G52144	W		
F	00-06	BMW X5 Coil (FrontSpringType) Left	
G52145	W		
F	00-06	BMW X5 Coil (FrontSpringType) Right	
G52148	D		
F	20	DODGE JOURNEY All Left	
F	18-19	JOURNEY Sport Left	
F	17-19	JOURNEY Canada Value Package Left	
F	17-19	JOURNEY Crossroad Left	
F	17-19	JOURNEY SE Left	
F	17-19	JOURNEY SXT Left	
F	19	JOURNEY SE Blacktop Left	
F	19	JOURNEY SE Plus Left	
F	19	JOURNEY Sport Plus Left	
F	17-18	JOURNEY SXT Lujo Left	
F	17	JOURNEY SE Plus Left	
F	17	JOURNEY SXT Sport Left	
F	09-16	JOURNEY All Left	
G52149	D		
F	20	DODGE JOURNEY All Right	
F	18-19	JOURNEY Sport Right	

Numerical listing

Shock	POP	Alternative No.	MTG Acc. Supplied
Pos.	Year	Application	
G52149 D (cont)			
F	17-19	JOURNEY	Canada Value Package Right
F	17-19	JOURNEY	Crossroad Right
F	17-19	JOURNEY	SE Right
F	17-19	JOURNEY	SXT Right
F	19	JOURNEY	SE Blacktop Right
F	19	JOURNEY	SE Plus Right
F	19	JOURNEY	Sport Plus Right
F	17-18	JOURNEY	SXT Lujo Right
F	17	JOURNEY	SE Plus Right
F	17	JOURNEY	SXT Sport Right
F	09-16	JOURNEY	All Right
G52150 W			
F	06-14	HONDA RIDGELINE	All Left
G52151 W			
F	06-14	HONDA RIDGELINE	All Right
G52152 W			
F	10-12	HONDA CITY	All Left
F	15-16	FIT	All Left
F	13-14	FIT	DX Left
F	13-14	FIT	EX Left
F	13-14	FIT	LX Left
F	13-14	FIT	Sport Left
F	13	FIT	Base Left
F	09-12	FIT	All Left
F	10-14	INSIGHT	All Left
G52153 W			
F	10-12	HONDA CITY	All Right
F	15-16	FIT	All Right
F	13-14	FIT	DX Right
F	13-14	FIT	EX Right
F	13-14	FIT	LX Right
F	13-14	FIT	Sport Right
F	13	FIT	Base Right
F	09-12	FIT	All Right
F	10-14	INSIGHT	All Right
G52154 W			
F	06-11	DODGE ATTITUDE	All Left
F	06-11	HYUNDAI ACCENT	All Left
F	06-11	KIA RIO	All Left
F	06-11	RIO	All Left
G52155 W			
F	06-11	DODGE ATTITUDE	All Right
F	06-11	HYUNDAI ACCENT	All Right
F	06-11	KIA RIO	All Right
F	06-11	RIO	All Right
G52156 W			
F	07-10	HYUNDAI ELANTRA	All Left
G52157 W			
F	07-10	HYUNDAI ELANTRA	All Right
G52158 W			
F	07-09	HYUNDAI SANTA FE	All Left
G52159 W			
F	07-09	HYUNDAI SANTA FE	All Right
G52160 W			
F	05-09	KIA SPECTRA	All Left
F	04-09	SPECTRA	All Left
G52161 W			
F	05-09	KIA SPECTRA	All Right
F	04-09	SPECTRA	All Right
G52162 W			
R	05-09	KIA SPECTRA	All Left
R	04-09	SPECTRA	All Left
G52163 W			
R	05-09	KIA SPECTRA	All Right
R	04-09	SPECTRA	All Right
G52164 W			
F	02-06	MINI COOPER	All Left
G52165 W			
F	02-06	MINI COOPER	All Right
G52167 W			
F	06-12	mitsubishi Eclipse	All Right
G52168 W			
F	10-12	MITSUBISHI GALANT	SE Left
F	04-11	GALANT	ES Left
F	04-08	GALANT	DE Left
F	05-07	GALANT	SE Left

Ultra Struts

Shock	POP	Alternative No.	MTG Acc. Supplied
Pos.	Year	Application	
G52169 W			
F	10-12	MITSUBISHI GALANT	SE Right
F	04-11	GALANT	ES Right
F	04-08	GALANT	DE Right
F	05-07	GALANT	SE Right
G52170 W			
F	13	NISSAN MURANO	All Left
F	12	MURANO	All Left Mfg. to 12/12
F	08-11	MURANO	All Left
G52171 W			
F	13	NISSAN MURANO	All Right
F	12	MURANO	All Right Mfg. to 12/12
F	08-11	MURANO	All Right
G52172 W			
F	12	MERCEDES-BENZ C250 Sedan, CGI (FuelDelSubType)	
F	10-11	C250	All
F	08-09	C280	All
F	10-11	C300 Elegance	
F	08-11	C300 Luxury	
F	08-10	C300 Base	
F	10	C300 Classic	
F	12	C350 Base	
F	08-10	C350 Base	
F	09	C350 Elegance	
F	08	C350 All	
G52173 D			
F	08-12	NISSAN ROGUE	All Left w/ OE# E4303JM00A
F	10-12	X-TRAIL	All Left
F	08	X-TRAIL	All Left
G52174 D			
F	08-12	NISSAN ROGUE	All Right w/ OE# E4302JM00A
F	10-12	X-TRAIL	All Right
F	08	X-TRAIL	All Right
G52175 D			
F	03-11	SAAB 9-3	All Left
G52176 D			
F	03-11	SAAB 9-3	All Right
G52182 W			
R	06-08	SUBARU FORESTER	Manual Left
G52183 W			
R	06-08	SUBARU FORESTER	Manual Right
G52184 D			
F	06-13	SUZUKI GRAND VITARA	All Left
G52185 D			
F	06-13	SUZUKI GRAND VITARA	All Right
G52187 W			
F	07-12	ACURA RDX	All Left
F	07-14	HONDA CR-V	All Left
G52188 W			
F	07-12	ACURA RDX	All Right
F	07-14	HONDA CR-V	All Right
G52199 W			
F	04-10	BMW X3	All Left
G52200 W			
F	04-10	BMW X3	All Right
G52201 W			
F	08-10	TOYOTA HIGHLANDER	All Left
G52202 W			
F	08-10	TOYOTA HIGHLANDER	All Right
G52203 W			
R	08-13	TOYOTA HIGHLANDER	FWD Left
G52204 W			
R	08-13	TOYOTA HIGHLANDER	FWD Right
G52209 W			
F	07-10	MAZDA CX-7	All Left
G52210 W			
F	07-10	MAZDA CX-7	All Right
G52237 W			
F	00	BMW 323CI	Coupe Left Exc. Sport Suspension
F	00	323i	Sedan Left Exc. Sport Suspension

Numerical listing

Shock	POP	Alternative No.	MTG Acc. Supplied
Pos.	Year	Application	
G52237 W (cont)			
F	01-06	325CI	All Left Exc. Sport Suspension
F	01-05	325i	Sedan Left Exc. Sport Suspension
F	00	328CI	Coupe Left Exc. Sport Suspension
F	01-06	330CI	All Left Exc. Sport Suspension
G52238 W			
F	00	BMW 323CI	Coupe Right Exc. Sport Suspension
F	00	323i	Sedan Right Exc. Sport Suspension
F	01-06	325CI	All Right Exc. Sport Suspension
F	01-05	325i	Sedan Right Exc. Sport Suspension
F	00	328CI	Coupe Right Exc. Sport Suspension
F	01-06	330CI	All Right Exc. Sport Suspension
G52244 W			
R	05-09	BUICK ALLURE	All Models w/ 17" or 18" Wheels
R	05-09	LACROSSE	All Models w/ 17" or 18" Wheels
R	04-11	CHEVROLET IMPALA	All Models w/ 17" or 18" Wheels
R	05-07	MONTE CARLO	All Models w/ 17" or 18" Wheels
R	04-08	PONTIAC GRAND PRIX	All Models w/ 17" or 18" Wheels
G52245 W			
F	09-10	PONTIAC VIBE	All Left
F	09-13	TOYOTA COROLLA	All Left
F	09-14	MATRIX	All Left
G52246 W			
F	09-10	PONTIAC VIBE	All Right
F	09-13	TOYOTA COROLLA	All Right
F	09-14	MATRIX	All Right
G52247 W			
F	07-10	KIA MAGENTIS	All Left
F	07-10	OPTIMA	All Left
F	06	OPTIMA	All Left New Body Style
F	07-11	RONDO	All Left
G52248 W			
F	07-10	KIA MAGENTIS	All Right
F	07-10	OPTIMA	All Right
F	06	OPTIMA	All Right New Body Style
F	07-11	RONDO	All Right
G52249 W			
F	07-13	ACURA MDX	All Left Exc. Active Suspension
F	10-13	ZDX	All Left Exc. Electronic Suspension
G52250 W			
F	07-13	ACURA MDX	All Right Exc. Active Suspension
F	10-13	ZDX	All Right Exc. Electronic Suspension
G52253 W			
F	08-10	HONDA ODYSSEY	All Left
G52254 W			
F	08-10	HONDA ODYSSEY	All Right
G52255 W			
F	11-13	FORD FIESTA	All Left
G52256 W			
F	11-13	FORD FIESTA	All Right
G52257 W			
F	07-08	HYUNDAI ENTOURAGE	All Left
F	14	KIA SEDONA	All Left
F	06-12	SEDONA	All Left
G52258 W			
F	07-08	HYUNDAI ENTOURAGE	All Right
F	14	KIA SEDONA	All Right
F	06-12	SEDONA	All Right
G52260 W			
F	07-15	MAZDA CX-9	All Left
G52261 W			
F	07-15	MAZDA CX-9	All Right

Numerical listing

Shock	POP	Alternative No.	MTG Acc. Supplied
Pos.	Year	Application	
G52264	W		
F	08-15	SCION XB	All Left
G52265	W		
F	08-15	SCION XB	All Right
G52270	W		
F	06-07	SUBARU B9	TRIBECA All Left
F	08-14	TRIBECA	All Left
G52271	W		
F	06-07	SUBARU B9	TRIBECA All Right
F	08-14	TRIBECA	All Right
G52272	W		
F	05-12	SUBARU	OUTBACK All Left
G52273	W		
F	05-12	SUBARU	OUTBACK All Right
G52274	W		
F	07-13	VOLVO C30	All Left
F	06-13	C70	All Left
F	05-12	S40	All Left
F	04	S40 T5	Left
F	05-11	V50	All Left
G52275	W		
F	07-13	VOLVO C30	All Right
F	06-13	C70	All Right
F	05-12	S40	All Right
F	04	S40 T5	Right Mfg. to 4/00
F	05-11	V50	All Right
G52276	W		
F	02-08	JAGUAR X-TYPE	All Exc. CATS Computer Active Technology Suspension
G52278	W		
F	10	BUICK ALLURE	FWD Left Exc. Electronic Suspension
F	10-16	LACROSSE	FWD Left Exc. Electronic Suspension
G52279	W		
F	10	BUICK ALLURE	FWD Right Exc. Electronic Suspension
F	10-16	LACROSSE	FWD Right Exc. Electronic Suspension
G52280	W		
F	10-13	CHEVROLET CAMARO	3.6L 6Cyl V (217) Left
G52281	W		
F	10-13	CHEVROLET CAMARO	3.6L 6Cyl V (217) Right
G52282	W		
F	07-08	HONDA FIT	CAN Left
F	07-08	FIT	USA Left
G52283	W		
F	07-08	HONDA FIT	CAN Right
F	07-08	FIT	USA Right
G52293	W		
F	04-11	MINI COOPER	All Left
G52294	W		
F	04-11	MINI COOPER	All Right
G52295	W		
F	03-08	VOLVO XC90	All
G52297	W		
F	07-13	MINI COOPER	All Left
G52298	W		
F	07-13	MINI COOPER	All Right
G52299	W		
F	09-13	MITSUBISHI OUTLANDER	SE Left w/ 3rd Row Seating
F	09-13	OUTLANDER XLS	Left w/ 3rd Row Seating
F	10-12	OUTLANDER GT	Left w/ 3rd Row Seating
F	08	OUTLANDER XLS	Left
F	07	OUTLANDER	All Left
G52300	W		
F	10-13	MITSUBISHI OUTLANDER	GT Right w/ 3rd Row Seating
F	09-13	OUTLANDER SE	Right w/ 3rd Row Seating

Ultra Struts

Shock	POP	Alternative No.	MTG Acc. Supplied
Pos.	Year	Application	
G52300	W (cont)		
F	09-13	OUTLANDER XLS	Right w/ 3rd Row Seating
F	08	OUTLANDER XLS	Right
F	07	OUTLANDER	All Right
G52301	W		
F	09-11	VOLKSWAGEN TIGUAN	All
G52314	W		
F	04-07	BMW 525i	All
F	08-10	528i	All
F	04-07	530i	All
F	08-10	535i	All
F	04-05	545i	All
F	06-10	550i	All
G52329	W		
F	11	HYUNDAI SONATA	2.0T Left Mfg. to 7/22/10
F	11	SONATA	2.0T Limited Left Mfg. to 7/22/10
F	11	SONATA GL	Left Mfg. to 7/22/10
F	11	SONATA GLS	Left Mfg. to 7/22/10
F	11	SONATA	Limited Left Mfg. to 7/22/10
F	11	SONATA SE	Left Mfg. to 7/22/10
G52330	W		
F	11	HYUNDAI SONATA	2.0T Limited Right Mfg. to 7/22/10
F	11	SONATA	2.0T Right Mfg. to 7/22/10
F	11	SONATA GL	Right Mfg. to 7/22/10
F	11	SONATA GLS	Right Mfg. to 7/22/10
F	11	SONATA	Limited Right Mfg. to 7/22/10
F	11	SONATA SE	Right Mfg. to 7/22/10
G52331	W		
F	12-15	TOYOTA PRIUS	All Left
F	11	PRIUS	All Left Mfg. to 12/11
F	10	PRIUS	All Left
G52332	W		
F	13-15	TOYOTA PRIUS	All Right
F	11-12	PRIUS	All Right Mfg. to 12/11
F	10	PRIUS	All Right
G52333	W		
R	97-05	HYUNDAI ACCENT	All Left Gas Charged Unit
G52334	W		
R	97-05	HYUNDAI ACCENT	All Right Gas Charged Unit
G52335	W		
R	96-00	HYUNDAI ELANTRA	All Left Gas Charged Unit
G52336	W		
R	96-00	HYUNDAI ELANTRA	All Right Gas Charged Unit
G52348	W		
F	04-10	VOLKSWAGEN TOUAREG	All Left Exc. Air Suspension
G52349	W		
F	04-10	VOLKSWAGEN TOUAREG	All Right Exc. Air Suspension
G52351	W		
F	11-14	FORD EDGE	All Left
F	11-15	LINCOLN MKX	All Left
G52352	W		
F	11-14	FORD EDGE	All Right
F	11-15	LINCOLN MKX	All Right
G52353	D		
F	12-14	DODGE ATTITUDE	All Left
F	12-17	HYUNDAI ACCENT	All Left
F	12-17	KIA RIO	All Left
G52354	D		
F	12-14	DODGE ATTITUDE	All Right
F	12-17	HYUNDAI ACCENT	All Right
F	12-17	KIA RIO	All Right
G52355	W		
F	11-13	NISSAN QUEST	All Left
G52356	W		
F	11-13	NISSAN QUEST	All Right
G52360	W		
F	09-15	HONDA PILOT	All Left

Numerical listing

Shock	POP	Alternative No.	MTG Acc. Supplied
Pos.	Year	Application	
G52361	W		
F	09-15	HONDA PILOT	All Right
G52367	W		
R	05-06	TOYOTA AVALON	All Left Mfg. to 1/06
G52368	W		
R	05-06	TOYOTA AVALON	All Right Mfg. to 1/06
G52374	W		
F	09-13	SUBARU FORESTER	All Left
G52375	W		
F	09-13	SUBARU FORESTER	All Right
G52376	W		
F	04	TOYOTA AVALON	All Left
G52377	W		
F	04	TOYOTA AVALON	All Right
G52382	W		
F	09-14	NISSAN MAXIMA	All Left
G52383	W		
F	09-14	NISSAN MAXIMA	All Right
G52395	W		
F	10-15	CHEVROLET CAMARO	SS Left
G52396	W		
F	10-15	CHEVROLET CAMARO	SS Right
G52398	W		
F	10-12	FORD TAURUS	All Left w/ Suspension Code A and B
F	09-12	LINCOLN MKS	All Left w/ Suspension Code A and B
G52399	W		
F	10-12	FORD TAURUS	All Right w/ Suspension Code A and B
F	09-12	LINCOLN MKS	All Right w/ Suspension Code A and B
G52406	W		
F	11-14	FORD MUSTANG / MUSTANG II	All
G52410	C		
F	14-20	NISSAN ROGUE	All Left
F	19-20	X-TRAIL	All Left
G52411	C		
F	14-20	NISSAN ROGUE	All Right
F	19-20	X-TRAIL	All Right
G52435	W		
F	17	BUICK REGAL	FWD Left Exc. Active Suspension
F	11-16	REGAL	All Left Exc. Active Suspension
G52436	W		
F	17	BUICK REGAL	FWD Right Exc. Active Suspension
F	11-16	REGAL	All Right Exc. Active Suspension
G52437	C		
F	12-17	HYUNDAI AZERA	All Left
F	14-16	KIA CADENZA	All Left
G52438	C		
F	12-17	HYUNDAI AZERA	All Right
F	14-16	KIA CADENZA	All Right
G52439	W		
F	12-13	HYUNDAI ELANTRA	All Left
G52440	W		
F	12-13	HYUNDAI ELANTRA	All Right
G52449	W		
F	10-13	MAZDA 3	Mazdaspeed Left Exc. Turbo
F	07-09	3 Mazdaspeed	Left Exc. Turbo, Exc. Models w/ 17" Wheels
G52450	W		
F	10-13	MAZDA 3	Mazdaspeed Right Exc. Turbo
F	07-09	3 Mazdaspeed	Right Exc. Turbo, Exc. Models w/ 17" Wheels
G52494	W		
F	13-22	BUICK ENCORE	All Left

Numerical listing

Shock	POP	Alternative No.	MTG Acc. Supplied
Pos.	Year	Application	
G52494 W (cont)			
F	13-22	CHEVROLET TRAX	All Left
G52495 W			
F	13-22	BUICK ENCORE	All Right
F	13-22	CHEVROLET TRAX	All Right
G52524 W			
F	15-18	NISSAN MURANO	All Left
F	13-20	PATHFINDER	All Left
G52525 W			
F	15-18	NISSAN MURANO	All Right
F	13-20	PATHFINDER	All Right
G52906 W			
F	14-17	NISSAN QUEST	All Left
G52907 W			
F	14-17	NISSAN QUEST	All Right
G55526 W			
F	86-93	CHRYSLER DAYTONA	All
F	88-93	DYNASTY	All Exc. Hydraulic Self-Leveling System
F	90-93	IMPERIAL	All Exc. Hydraulic Self-Leveling System
F	86	LASER	All
F	86-95	LEBARON	All
F	86-93	NEW YORKER	All
F	86-88	TOWN & COUNTRY	All
F	86-88	DODGE 600	All
F	86-89	ARIES	All
F	89-93	DAYTONA ES	
F	91	DAYTONA	Iroc
F	89-90	DAYTONA ES	Turbo
F	87-88	DAYTONA	Pacifica
F	86	DAYTONA	All
F	88-93	DYNASTY	All Exc. Hydraulic Self-Leveling System
F	86-89	LANCER	All
F	87-94	SHADOW	All
F	89-95	SPIRIT	All
F	89-95	PLYMOUTH ACCLAIM	All
F	86-88	CARAVELLE	All
F	86-89	RELIANT	All
F	87-94	SUNDANCE	All
G55551 W 141306			
F	84-93	FORD MUSTANG / MUSTANG II	GT, 5.0L 8Cyl V (302), 4.00 101.6(Bore)3.00 76.2(Stroke)
G55579 W 141730			
F	89-97	FORD THUNDERBIRD	All Exc. Electronic Adjustable Suspension
F	89-97	MERCURY COUGAR	All Exc. Electronic Adjustable Suspension
G55591 W 142024			
F	89-92	GEO PRIZM	All
F	88-92	TOYOTA COROLLA	FWD
G55600 W 141715			
F	89-92	FORD PROBE	All
F	88-92	MAZDA 626	All Exc. Electronic Adjustable Suspension or 4 Wheel Steer
F	88-92	MX6	All Exc. Electronic Adjustable Suspension or 4 Wheel Steer
G55615 W 141711			
F	94-97	FORD ASPIRE	Non-ABS
F	88-93	FESTIVA	All
G55661 W			
R	98-02	CHEVROLET PRIZM	All Left
R	93-97	GEO PRIZM	All Left
R	93-02	TOYOTA COROLLA	All Left
G55662 W			
R	98-02	CHEVROLET PRIZM	All Right
R	93-97	GEO PRIZM	All Right
R	93-02	TOYOTA COROLLA	All Right
G55675 W			
R	97-02	LEXUS ES300	All Left Exc. Electronic Adjustable Suspension
R	95-96	ES300	All Left
R	92-94	ES300	All Left Sealed OE Struts
R	95-03	TOYOTA AVALON	All Left
R	95-01	CAMRY	All Left
R	92-94	CAMRY	All Left Sealed OE Struts
R	99-03	SOLARA	All Left

Ultra Struts

Shock	POP	Alternative No.	MTG Acc. Supplied
Pos.	Year	Application	
G55676 W			
R	97-02	LEXUS ES300	All Right Exc. Electronic Adjustable Suspension
R	95-96	ES300	All Right
R	92-94	ES300	All Right Sealed OE Struts
R	95-03	TOYOTA AVALON	All Right
R	95-01	CAMRY	All Right
R	92-94	CAMRY	All Right Sealed OE Struts
R	99-03	SOLARA	All Right
G55681 W			
F	03-04	FORD MUSTANG / MUSTANG II	Mach 1
F	94-04	MUSTANG / MUSTANG II	Base
F	94-04	MUSTANG / MUSTANG II	GT
F	04	MUSTANG / MUSTANG II	GT Base
F	04	MUSTANG / MUSTANG II	GT Equipado
F	01	MUSTANG / MUSTANG II	GT Bullitt
F	95	MUSTANG / MUSTANG II	GTS
G55697 W 143004			
F	96-00	CHRYSLER TOWN & COUNTRY	All
F	00	VOYAGER / GRAND VOYAGER	All
F	00	VOYAGER / GRAND VOYAGER	Non-ABS
F	96-00	DODGE CARAVAN / GRAND CARAVAN	All Exc. Hydraulic Self-Leveling System
F	96-00	PLYMOUTH VOYAGER / GRAND VOYAGER	All
G55698 W			
F	95-05	CHEVROLET CAVALIER	All
F	95-05	PONTIAC SUNFIRE	All
G55772 W			
R	98-01	CHEVROLET METRO	Non-ABS
R	89-91	SPRINT	All
R	89-97	GEO METRO	Non-ABS
R	95-99	PONTIAC FIREFLY	All
R	94	FIREFLY CAN	
R	89-91	FIREFLY CAN	
R	89-01	SUZUKI SWIFT	All
G55774 W 141544			
F	90-93	HONDA ACCORD	All
G55804 W 142099			
R	92-94	TOYOTA PASEO	All
R	91-94	TERCEL	All
G55820 W 142094			
F	95-00	CHRYSLER SEBRING	Coupe
F	95-00	DODGE AVENGER	All
F	94-98	MITSUBISHI GALANT	All
G55821 W 142372			
R	95-98	HONDA ODYSSEY	All
R	96-99	ISUZU OASIS	All
G55825 W 142609			
R	95-05	CHEVROLET CAVALIER	All
R	95-05	PONTIAC SUNFIRE	All
G55856 W			
R	99-04	CHRYSLER 300M	All
R	98-04	CONCORDE	All
R	98-04	INTREPID	All
R	99-01	LHS	All
R	98-04	DODGE INTREPID	All
G55870 W 141544			
F	01-03	ACURA CL	All
F	99-03	TL	All
F	98-02	HONDA ACCORD	All
G55879 W 142780			
F	95-99	TOYOTA PASEO	All
F	95-99	TERCEL	All
G55892 W			
F	00-02	CHRYSLER NEON	All
F	03-05	DODGE NEON	SXT
F	00-05	NEON	SE
F	01-04	NEON	R/T
F	00-03	NEON	LE
F	01-02	NEON	ACR
F	01-02	NEON	Base
F	00-02	NEON	ES
F	00-02	NEON	LX
F	00	NEON	High Line
F	00-01	PLYMOUTH NEON	All
G55896 W			
F	01-10	CHRYSLER PT CRUISER	All

Numerical listing

Shock	POP	Alternative No.	MTG Acc. Supplied
Pos.	Year	Application	
G55901 W 142169			
R	94-07	FORD TAURUS	Sedan
R	94-05	MERCURY SABLE	Sedan
G55909 W 141544			
F	97-00	ACURA EL	All
F	96-00	HONDA CIVIC	All
G55910 W 141544			
R	97-00	ACURA EL	All
R	96-00	HONDA CIVIC	All
G55911 W 142462			
F	93-95	DODGE COLT	All
F	93-96	EAGLE SUMMIT	Coupe
F	93-96	SUMMIT	Sedan
F	96	MITSUBISHI MIRAGE	All Mfg. to 5/96
F	93-95	MIRAGE	All
F	93-94	PLYMOUTH COLT	Sedan
G55948 B 142169			
F	05-09	BUICK ALLURE	All
F	97-05	CENTURY	All
F	05-09	LACROSSE	All
F	97-04	REGAL	All
F	05-06	TERRAZO	AWD
F	00-13	CHEVROLET IMPALA	All
F	14-16	IMPALA LIMITED	All
F	00-07	MONTE CARLO	All
F	02-05	VENTURE	All
F	97-01	VENTURE	FWD
F	98-02	OLDSMOBILE INTRIGUE	All
F	97-04	SILHOUETTE	All
F	97-03	PONTIAC GRAND PRIX	All
F	99-05	MONTANA	Base
F	97-99	TRANS SPORT	All
G55949 B 142169			
R	05-09	BUICK ALLURE	All Exc. Models w/ 17" Wheels
R	97-05	CENTURY	All
R	05-09	LACROSSE	All Exc. Models w/ 17" Wheels
R	97-04	REGAL	All
R	00-16	CHEVROLET IMPALA	All Exc. Models w/ 17" Wheels
R	14-16	IMPALA LIMITED	All Exc. Models w/ 17" Wheels
R	00-07	MONTE CARLO	All Exc. Models w/ 17" Wheels
R	98-02	OLDSMOBILE INTRIGUE	All
R	97-08	PONTIAC GRAND PRIX	All Exc. Models w/ 17" Wheels
G55990 W			
F	93-96	VOLKSWAGEN GOLF	All Up to Chassis # 08773
F	85-92	GOLF	All Sealed Struts
F	94-98	JETTA VR6	VR6; Up to Chassis # 08773
F	94	JETTA VR6	Up to Chassis # 08773
F	93	JETTA	All VR6; Up to Chassis # 08773
F	85-92	JETTA	All Sealed Struts
G55991 W			
F	93-98	VOLKSWAGEN GOLF	2.0L 4Cyl L (121), 3.25 82.5(Bore)3.65 92.8(Stroke) From Chassis # 08774; VR6
F	96-98	JETTA	2.8L 6Cyl V (2771), 3.25 82.5(Bore)3.40 86.4(Stroke) From Chassis # 08774; VR6
F	93-95	JETTA	2.0L 4Cyl L (121), 3.25 82.5(Bore)3.65 92.8(Stroke) From Chassis # 08774; VR6
G55993 W			
F	98-03	TOYOTA SIENNA	All Left
G55994 W			
F	98-03	TOYOTA SIENNA	All Right
G55999 W 141309			
F	98-02	CHEVROLET PRIZM	All
F	93-97	GEO PRIZM	All
F	93-02	TOYOTA COROLLA	All
G56506 W			
F	97-01	LEXUS ES300	All Left Exc. Electronic Adjustable Suspension
F	97-03	TOYOTA AVALON	All Left
F	97-01	CAMRY	All Left
F	99-03	SOLARA	All Left

Numerical listing

Shock	POP	Alternative No.	MTG Acc. Supplied
Pos.	Year	Application	
G56509	C		141572
F	00-05	BUICK LESABRE	All
F	00-05	CADILLAC DEVILLE	All Exc. Electronic Adjustable Suspension
F	98-04	SEVILLE	All Exc. Electronic Adjustable Suspension
F	01-03	OLDSMOBILE AURORA	All
F	98-99	AURORA	All
F	00-05	PONTIAC BONNEVILLE	All
G56512	W		
R	91-96	INFINITI G20	All Left
G56513	W		
R	91-96	INFINITI G20	All Right
G56514	W		
F	97-01	LEXUS ES300	All Right Exc. Electronic Adjustable Suspension
F	97-03	TOYOTA AVALON	All Right
F	97-01	CAMRY	All Right
F	99-03	SOLARA	All Right
G56516	W		
F	00-05	FORD FOCUS	All Left
G56517	W		141682
F	00-05	FORD FOCUS	All Right
G56518	C		141309
F	92-93	ASUNA SUNRUNNER	All Non-ABS
F	98-04	CHEVROLET TRACKER	Non-ABS
F	89-97	GEO TRACKER	Non-ABS
F	94-97	PONTIAC SUNRUNNER	CAN Non-ABS
F	99-05	SUZUKI GRAND VITARA	All Non-ABS
F	89-98	SIDEKICK	Non-ABS
F	99-04	VITARA	Non-ABS
F	06	XL-7	All Non-ABS
F	02-05	XL-7	Non-ABS
G56529	W		141682
F	98-02	MINI COOPER	1.8L 4Cyl L (112), 3.19 81.0(Bore)3.50 88.8(Stroke) Right w/ 6" or 7" Spring
F	97	MIRAGE	1.8L 4Cyl L (112), 3.19 81.0(Bore)3.50 88.8(Stroke) Right Mfg. from 4/97; w/ 6" or 7" Spring
G56530	W		141682
F	98-02	MINI COOPER	1.8L 4Cyl L (112), 3.19 81.0(Bore)3.50 88.8(Stroke) Left w/ 6" or 7" Spring
F	97	MIRAGE	1.8L 4Cyl L (112), 3.19 81.0(Bore)3.50 88.8(Stroke) Left Mfg. from 4/97; w/ 6" or 7" Spring
G56531	W		142078
F	98-01	MINI COOPER	Non-ABS Right
G56532	W		142078
F	00-01	MINI COOPER	Non-ABS Left Mfg. to 6/01
F	98-99	MINI COOPER	Non-ABS Left
G56533	W		
R	00-01	MINI COOPER	All Right Mfg. to 6/01
R	98-99	MINI COOPER	All Right
R	00-01	SPECTRA	All Right Mfg. to 6/01
G56534	W		
R	00-01	MINI COOPER	All Left Mfg. to 6/01
R	98-99	MINI COOPER	All Left
R	00-01	SPECTRA	All Left Mfg. to 6/01
G56537	W		141682
R	02-03	MAZDA PROT5 / PROT5	All Right
R	02-03	PROT5 / PROT5	SE Right
R	01-03	PROT5 / PROT5	DX Right
R	01-03	PROT5 / PROT5	ES Right
R	01-03	PROT5 / PROT5	LX Right
R	99-00	PROT5 / PROT5	All Right
G56538	W		141682
R	02-03	MAZDA PROT5 / PROT5	All Left
R	02-03	PROT5 / PROT5	SE Left
R	01-03	PROT5 / PROT5	DX Left
R	01-03	PROT5 / PROT5	ES Left
R	01-03	PROT5 / PROT5	LX Left
R	99-00	PROT5 / PROT5	All Left
G56539	W		
F	01-06	HYUNDAI ELANTRA	All Left
F	00	ELANTRA	All Left Mfg. from 5/00

Ultra Struts

Shock	POP	Alternative No.	MTG Acc. Supplied
Pos.	Year	Application	
G56540	W		
F	01-06	HYUNDAI ELANTRA	All Right
F	00	ELANTRA	All Right Mfg. from 5/00
G56554	W		141309
R	99-03	LEXUS RX300	FWD Left
G56561	W		141682
F	01-06	HYUNDAI SANTA FE	All Right
G56562	W		141682
F	01-06	HYUNDAI SANTA FE	All Left
G56565	W		141716
F	99-00	HYUNDAI SONATA	All
G56568	W		
F	01-12	FORD ESCAPE	All Right
F	08-11	MAZDA TRIBUTE	All Right
F	01-06	TRIBUTE	All Right
F	05-11	MERCURY MARINER	All Right
G56569	W		
F	94-97	KIA SEPHIA	All Right
G56570	W		
F	94-97	KIA SEPHIA	All Left
G56571	W		
R	94-97	KIA SEPHIA	All Right
G56572	W		141682
F	00-05	TOYOTA ECHO	All
G56573	W		
F	94-99	TOYOTA CELICA	All Left
G56576	W		
F	94-99	TOYOTA CELICA	All Right
G56581	W		141309
F	01-05	TOYOTA RAV4	All Right
F	00	RAV4	All Right Mfg. from 5/00
G56582	W		141309
F	01-05	TOYOTA RAV4	All Left
F	00	RAV4	All Left Mfg. from 5/00
G56591	W		
F	91-96	INFINITI G20	All
G56597	W		
R	03-05	MAZDA MIATA	Base
R	03-05	MIATA	LS
R	03	MIATA	SE
R	99-01	MIATA	All
G56598	C		
F	98-05	LEXUS GS300	All
F	98-00	GS400	All
F	01-05	GS430	All
F	02-07	SC430	All
G56601	W		
F	01-12	FORD ESCAPE	All Left
F	08-11	MAZDA TRIBUTE	All Left
F	01-06	TRIBUTE	All Left
F	05-11	MERCURY MARINER	All Left
G56606	W		
F	98-10	VOLKSWAGEN BEETLE	All
F	99-06	GOLF A4	(MfrBodyCode)
F	01-05	JETTA	Sedan
F	99-00	JETTA	All
G56608	W		
F	01-03	BMW 525i	Sedan Exc. Electronic Adjustable Suspension
F	97-00	528i	Sedan
F	01-03	530i	All Exc. Electronic Adjustable Suspension
G56615	W		141682
F	99-01	INFINITI QX4	All Left Mfg. from 12/98
F	99-01	NISSAN PATHFINDER	All Left Mfg. from 12/98; w/ OE543034W985
G56616	W		141682
F	99-01	INFINITI QX4	All Right Mfg. from 12/98
F	99-01	NISSAN PATHFINDER	All Right Mfg. from 12/98; w/ OE543034W985
G56620	W		143004
F	01-07	CHRYSLER TOWN & COUNTRY	All
F	01-07	VOYAGER / GRAND VOYAGER	All

Numerical listing

Shock	POP	Alternative No.	MTG Acc. Supplied
Pos.	Year	Application	
G56620	W (cont)		143004
F	01-07	DODGE CARAVAN / GRAND CARAVAN	All
G56621	W		141682
F	01-03	ACURA EL	All Left
F	03-05	HONDA CIVIC	Hybrid Left
F	02	CIVIC	Coupe Left
F	02	CIVIC	Sedan Left
F	01	CIVIC	All Left
G56622	W		141682
F	01-03	ACURA EL	All Right
F	03-05	HONDA CIVIC	Hybrid Right
F	02	CIVIC	Coupe Right
F	02	CIVIC	Sedan Right
F	01	CIVIC	All Right
G56633	W		141682
F	00-03	MAZDA PROT5 / PROT5	All Right Mfg. from 10/00
G56634	W		141682
F	00-03	MAZDA PROT5 / PROT5	All Left Mfg. from 10/00
G56635	W		
F	99-03	MINI COOPER	All Right
G56636	W		141682
F	99-03	MINI COOPER	All Left
G56637	W		
R	94-97	KIA SEPHIA	All Left
G56640	W		141682
R	01-06	HYUNDAI ELANTRA	All Left
R	00	ELANTRA	All Left Mfg. from 5/00
G56641	W		141682
R	01-06	HYUNDAI ELANTRA	All Right
R	00	ELANTRA	All Right Mfg. from 5/00
G56642	W		141682
F	03-08	HYUNDAI TIBURON	All Left
G56643	W		141682
F	03-08	HYUNDAI TIBURON	All Right
G56655	W		142098
F	04-07	FORD FREESTAR	All
F	04-07	MERCURY MONTEREY	Mini Passenger Van
G56660	W		
F	03-08	TOYOTA COROLLA	All Right
G56661	W		141309
F	03-08	TOYOTA COROLLA	All Left
G56664	W		
R	98-99	CADILLAC DEVILLE	Coil (RearSpringType) Exc. Electronic Adjustable Suspension
R	94-97	DEVILLE	Air (RearSpringType) Exc. Electronic Adjustable Suspension
G56671	W		
F	02-06	NISSAN ALTIMA	All Left
F	04-08	MAXIMA	All Left
G56672	W		
F	02-06	NISSAN ALTIMA	All Right
F	04-08	MAXIMA	All Right
G56677	W		
F	04-05	HONDA CIVIC	Value Package, Sedan Left
F	03-05	CIVIC	DX, Sedan Left
F	03-05	CIVIC	EX, Sedan Left
F	03-05	CIVIC	GX, Sedan Left
F	03-05	CIVIC	HX, Coupe Left
F	03-05	CIVIC	LX, Sedan Left
F	03-05	CIVIC	Si, Sedan Left
F	05	CIVIC	EX Special Edition, Sedan Left
G56678	W		
F	04-05	HONDA CIVIC	Value Package, Sedan Right
F	03-05	CIVIC	DX, Sedan Right
F	03-05	CIVIC	EX, Sedan Right
F	03-05	CIVIC	GX, Sedan Right
F	03-05	CIVIC	HX, Coupe Right
F	03-05	CIVIC	LX, Sedan Right
F	03-05	CIVIC	Si, Sedan Right
F	05	CIVIC	EX Special Edition Right

Numerical listing

Shock	POP	Alternative No.	MTG Acc. Supplied
Pos.	Year	Application	
G56678	W (cont)		
F 05		CIVIC LX Special Edition, Sedan Right	
G56679	W		
F 01-03		TOYOTA HIGHLANDER All Left	
G56680	W		
F 01-03		TOYOTA HIGHLANDER All Right	
G56683	W		
F 00-01		INFINITI I30 All Left	
F 00-01		NISSAN MAXIMA All Left	
G56684	W		
F 00-01		INFINITI I30 All Right	
F 00-01		NISSAN MAXIMA All Right	
G56685	W		
F 02-04		INFINITI I35 All Left	
F 02-03		NISSAN MAXIMA All Left	
G56686	W		
F 02-04		INFINITI I35 All Right	
F 02-03		NISSAN MAXIMA All Right	
G56687	W		141682
F 02-03		INFINITI QX4 All Left	
F 01-04		NISSAN PATHFINDER All Left w/ OE 543034W925 or 543034W926	
G56688	W		141682
F 02-03		INFINITI QX4 All Right	
F 01-04		NISSAN PATHFINDER All Right w/ OE 543034W925 or 543034W926	
G56689	W		
F 98-02		MAZDA 626 All Left	
G56690	W		
F 98-02		MAZDA 626 All Right	
G56700	B		141156
F 82-92		CHEVROLET CAMARO All	
F 82-92		PONTIAC FIREBIRD All	
G56701	W		141313
F 85-90		BUICK ELECTRA All	
F 90		LESABRE All Early Design Front Strut w/ Spring Guard	
F 86-89		LESABRE All	
F 85-90		CADILLAC COMMERCIAL CHASSIS All	
F 85-90		DEVILLE All	
F 85-90		FLEETWOOD All	
F 86-90		OLDSMOBILE 88 SERIES All Early Design Front Strut w/ Spring Guard	
F 85-90		98 All	
F 87-90		PONTIAC BONNEVILLE All Early Design Front Strut w/ Spring Guard	
G56718	W		141683
F 91-99		BUICK LESABRE All	
F 90		LESABRE All Late Design Front Strut without Spring Guard	
F 91-96		PARK AVENUE All	
F 95-96		RIVIERA All	
F 93		CADILLAC 60 SPECIAL All	
F 92-93		COMMERCIAL CHASSIS FWD	
F 91		COMMERCIAL CHASSIS All	
F 91-93		DEVILLE All Exc. Electronic Adjustable Suspension	
F 91-93		FLEETWOOD All	
F 92-99		OLDSMOBILE 88 SERIES All	
F 90-91		88 SERIES All Late Design Front Strut without Spring Guard	
F 91-96		98 All CCR Computer Command Ride	
F 95-96		AURORA All	
F 96-99		LSS All	
F 97-98		REGENCY All	
F 94-99		PONTIAC BONNEVILLE All Exc. CCR Computer Command Ride	
F 91-93		BONNEVILLE All	
F 90		BONNEVILLE All Late Design Front Strut without Spring Guard	
G56721	W		141309
F 04-06		LEXUS ES330 All Left Exc. Adaptive Variable Suspension	
F 04-06		TOYOTA CAMRY All Left	
F 04-08		SOLARA All Left	
G56722	W		141309
F 04-06		LEXUS ES330 All Right Exc. Adaptive Variable Suspension	
F 04-06		TOYOTA CAMRY All Right	

Ultra Struts

Shock	POP	Alternative No.	MTG Acc. Supplied
Pos.	Year	Application	
G56722	W (cont)		141309
F 04-08		SOLARA All Right	
G56728	W		
R 04-06		LEXUS ES330 All Left Exc. Adaptive Variable Suspension	
R 04-06		TOYOTA CAMRY All Left	
R 04-06		SOLARA All Left	
G56729	W		
R 04-06		LEXUS ES330 All Right Exc. Adaptive Variable Suspension	
R 04-06		TOYOTA CAMRY All Right	
R 04-06		SOLARA All Right	
G56730	W		
F 04-06		LEXUS RX330 All Left Exc. Air Suspension	
F 07-09		RX350 All Left Exc. Air Suspension	
F 04-07		TOYOTA HIGHLANDER All Left	
G56731	W		
F 04-06		LEXUS RX330 All Right Exc. Air Suspension	
F 07-09		RX350 All Right Exc. Air Suspension	
F 04-07		TOYOTA HIGHLANDER All Right	
G56732	W		
R 04-06		LEXUS RX330 AWD Left Exc. Air Suspension	
R 07		RX350 AWD Left Exc. Air Suspension	
R 04-07		TOYOTA HIGHLANDER AWD Left	
G56733	W		
R 04-06		LEXUS RX330 AWD Right Exc. Air Suspension	
R 07		RX350 AWD Right Exc. Air Suspension	
R 04-07		TOYOTA HIGHLANDER AWD Right	
G56734	W		
R 04-06		LEXUS RX330 FWD Left Exc. Air Suspension	
R 07-09		RX350 FWD Left Exc. Air Suspension	
R 04-07		TOYOTA HIGHLANDER FWD Left	
G56735	W		
R 04-06		LEXUS RX330 FWD Right Exc. Air Suspension	
R 07-09		RX350 FWD Right Exc. Air Suspension	
R 04-07		TOYOTA HIGHLANDER FWD Right	
G56750	W		
F 00		BMW 323i Wagon Left Exc. Sport Suspension	
F 01-05		325i Wagon Left Mfg. to 9/01; Sport Suspension	
F 01		330Ci Convertible Left Sport Suspension	
G56751	W		
F 00		BMW 323i Wagon Right Exc. Sport Suspension	
F 01-05		325i Wagon Right Mfg. to 9/01; Sport Suspension	
F 01		330Ci Convertible Right Sport Suspension	
G56758	W		
F 01-02		ACURA MDX All Right	
F 03-08		HONDA PILOT All Right	
G56759	W		
F 01-02		ACURA MDX All Left	
F 03-08		HONDA PILOT All Left	
G56772	W		
F 04-08		CHRYSLER PACIFICA All	
G56773	W		141309
F 05-06		CHEVROLET EQUINOX All Left	
F 06		PONTIAC TORRENT All Left	
G56774	W		
F 05-06		CHEVROLET EQUINOX All Right	
F 06		PONTIAC TORRENT All Right	
G56778	W		143172
F 03-06		DODGE SPRINTER 2500 All	
F 03-06		SPRINTER 3500 All	
F 02-06		FREIGHTLINER SPRINTER 2500 All	

Numerical listing

Shock	POP	Alternative No.	MTG Acc. Supplied
Pos.	Year	Application	
G56778	W (cont)		143172
F 04-06		MERCEDES-BENZ SPRINTER All	
G56781	W		141120
F 01-03		KIA RIO All Right	
G56782	W		
F 01-03		KIA RIO All Left	
G56784	W		
F 99-02		MERCURY VILLAGER All Right	
F 99-02		NISSAN QUEST All Right	
G56785	W		
F 99-02		MERCURY VILLAGER All Left	
F 99-02		NISSAN QUEST All Left	
G56786	W		
F 00-02		KIA SPORTAGE All Right	
G56787	W		
F 00-02		KIA SPORTAGE All Left	
G56791	W		
F 06-07		MERCEDES-BENZ C230 All Exc. Sport Suspension	
F 03-05		C230 Coupe Exc. Sport Suspension	
F 02		C230 Coupe, RWD Exc. Sport Suspension	
F 01-05		C240 RWD Exc. Sport Suspension	
F 06-07		C280 RWD Exc. Sport Suspension	
F 01-05		C320 Sedan, RWD Exc. Sport Suspension	
F 02-04		C320 Wagon, RWD Exc. Sport Suspension	
F 06-07		C350 RWD Exc. Sport Suspension	
F 02-05		CLK320 RWD Exc. Sport Suspension	
F 06-09		CLK350 RWD Exc. Sport Suspension	
F 02-03		CLK430 RWD Exc. Sport Suspension	
F 03-06		CLK500 RWD Exc. Sport Suspension	
F 07-09		CLK550 Coupe, RWD Exc. Sport Suspension	
G56792	W		
F 06-07		MERCEDES-BENZ C230 RWD Sport Suspension	
F 02-05		C230 Coupe Sport Suspension	
F 01-05		C240 RWD Sport Suspension	
F 06-07		C280 RWD Sport Suspension	
F 01-05		C320 RWD Sport Suspension	
F 06-07		C350 RWD Sport Suspension	
F 02-05		CLK320 RWD Sport Suspension	
F 06-09		CLK350 RWD Sport Suspension	
F 02-03		CLK430 RWD Sport Suspension	
F 03-06		CLK500 RWD Sport Suspension	
G56797	W		141118
F 05-06		TOYOTA SIENNA FWD Right Mfg to 6/05 w/ 7 Passenger Seating	
F 04		SIENNA FWD Right w/ 7 Passenger Seating	
G56798	W		141118
F 05-06		TOYOTA SIENNA FWD Left Mfg to 6/05 w/ 7 Passenger Seating	
F 04		SIENNA FWD Left w/ 7 Passenger Seating	
G56799	W		141198
F 02-06		HONDA CR-V All Right	
G56800	W		141198
F 02-06		HONDA CR-V All Left	
G56802	W		142098
F 01-09		VOLVO S60 All	
F 99-06		S80 All	
F 05-06		V70 R Mfg. from 3/00 and Exc. XC70, XC Cross Country and Auto-Leveling	
F 04-06		V70 2.4 Mfg. from 3/00 and Exc. XC70, XC Cross Country and Auto-Leveling	
F 04-06		V70 2.5T Mfg. from 3/00 and Exc. XC70, XC Cross Country and Auto-Leveling	
F 00-05		V70 T5 Mfg. from 3/00 and Exc. XC70, XC Cross Country and Auto-Leveling	
F 04		V70 2.5T AWD Mfg. from 3/00 and Exc. XC70, XC Cross Country and Auto-Leveling	

Numerical listing

Shock	POP	Alternative No.	MTG Acc. Supplied
Pos.	Year	Application	
G56802	W	(cont)	142098
F	00-03	V70 2.4T Mfg. from 3/00 and Exc. XC70, XC Cross Country and Auto-Leveling	
F	00-03	V70 Base Mfg. from 3/00 and Exc. XC70, XC Cross Country and Auto-Leveling	
F	00	V70 2.4T SE Mfg. from 3/00 and Exc. XC70, XC Cross Country and Auto-Leveling	
F	00	V70 GLT Mfg. from 3/00 and Exc. XC70, XC Cross Country and Auto-Leveling	
F	00	V70 GLT SE Mfg. from 3/00 and Exc. XC70, XC Cross Country and Auto-Leveling	
G56807	A		141727
F	06-10	JEEP COMMANDER All	
F	05-10	GRAND CHEROKEE All	
G56809	W		141156
F	03-07	SATURN ION All	
G56810	W		
F	05-10	CHEVROLET COBALT LS	
F	05-10	COBALT LT	
F	10	COBALT Base	
F	10	COBALT LT Team Canada	
F	06-07	COBALT LTZ	
F	05	COBALT Base	
F	11	HHR All	
F	08-10	HHR LS Panel	
F	08-10	HHR LT Panel	
F	06-10	HHR LS	
F	06-10	HHR LT	
F	06-08	HHR Comfort LT	
F	06-08	HHR Elegance LT	
F	07	HHR Edicion Especial	
F	07-09	PONTIAC G5 All	
F	05-06	PURSUIT All	
G56814	W		
F	00-04	SUBARU OUTBACK AWD Right	
G56817	W		142169
F	05-10	FORD MUSTANG / MUSTANG II All	
G56819	W		
F	05-09	HYUNDAI TUCSON All Left	
F	05-10	KIA SPORTAGE All Left	
G56820	W		
F	05-09	HYUNDAI TUCSON All Right	
F	05-10	KIA SPORTAGE All Right	
G56821	W		
R	05-09	HYUNDAI TUCSON All Right	
R	05-10	KIA SPORTAGE All Right	
G56822	W		
R	05-09	HYUNDAI TUCSON All Left	
R	05-10	KIA SPORTAGE All Left	
G56836	W		142081
F	06-11	FORD FOCUS All Left	
G56837	W		142081
F	06-11	FORD FOCUS All Right	
G56838	W		141727
F	06-10	FORD EXPLORER All	
F	06-10	MERCURY MOUNTAINEER All	
G56839	W		141727
R	06-10	FORD EXPLORER All	
R	06-10	MERCURY MOUNTAINEER All	
G56840	W		142169
F	07-10	FORD EDGE All Left	
F	07-10	LINCOLN MKX All Left	
G56841	W		142169
F	07-10	FORD EDGE All Right	
F	07-10	LINCOLN MKX All Right	
G56842	W		
F	07-11	TOYOTA YARIS All Left	
G56843	W		
F	07-11	TOYOTA YARIS All Right	
G56886	W		
F	09-11	CHEVROLET AVEO All Left	
F	04-11	AVEO All Left	
F	07-10	PONTIAC G3 All Left	
F	05-08	WAVE All Left	
F	04-09	SUZUKI SWIFT All Left	

Ultra Struts, Guardian Struts

Shock	POP	Alternative No.	MTG Acc. Supplied
Pos.	Year	Application	
G56887	W		
F	09-11	CHEVROLET AVEO All Right	
F	04-11	AVEO All Right	
F	07-10	PONTIAC G3 All Right	
F	05-08	WAVE All Right	
F	04-09	SUZUKI SWIFT All Right	
G56888	W		
F	12	LEXUS ES350 All Left	
F	07-09	ES350 All Left	
F	07-11	TOYOTA AVALON All Left	
F	06	AVALON All Left Mfg. from 1/06	
F	07-11	CAMRY All Left	
G56889	W		
F	12	LEXUS ES350 All Right	
F	07-09	ES350 All Right	
F	07-11	TOYOTA AVALON All Right	
F	06	AVALON All Right Mfg. from 1/06	
F	07-11	CAMRY All Right	
G56892	W		
F	02-03	KIA SPECTRA All Left	
G56893	W		
F	02-03	KIA SPECTRA All Right	
G56894	W		
F	02-07	MITSUBISHI LANCER LS	
F	07	LANCER LS Diamond	
F	04-06	LANCER Ralliart	
F	02-06	LANCER OZ Rally	
F	06	LANCER DE	
F	06	LANCER SE	
F	04	LANCER DE	
F	04	LANCER Sportback	
G56899	W		
F	06-09	VOLKSWAGEN BORA All	
F	09-17	CC All	
F	07-14	EOS All	
F	12-14	GOLF Comfortline TDI	
F	12-14	GOLF Highline TDI	
F	11-14	GOLF Base	
F	11-14	GOLF Comfortline	
F	11-14	GOLF TDI	
F	11-14	GOLF Trendline	
F	14	GOLF Trendline TDI	
F	11-13	GOLF Sportline	
F	13	GOLF GTI	
F	11-12	GOLF Highline	
F	11	GOLF TDI Comfortline	
F	06-14	GTI All	
F	12-14	JETTA Wagon	
F	06-11	JETTA All	
F	06-10	PASSAT All	
F	06-09	RABBIT All	
G511003	W		
R	13-14	HONDA ACCORD Coupe	
G511019	W		
F	11-12	INFINITI G25 AWD Left	
F	07-08	G35 AWD Left Exc. 4 Wheel Steer	
F	09-13	G37 AWD Left Exc. 4 Wheel Steer	
G511020	W		
F	11-12	INFINITI G25 AWD Right	
F	07-08	G35 AWD Right Exc. 4 Wheel Steer	
F	09-13	G37 AWD Right Exc. 4 Wheel Steer	
G511054	W		
F	07-09	KIA SORENTO All Left Exc. HPD (High Performance Dampers)	
G511055	W		
F	07-09	KIA SORENTO All Right Exc. HPD (High Performance Dampers)	
Guardian Struts			
M55693	W		141682
R	95-00	FORD CONTOUR All	
R	99-02	MERCURY COUGAR All	
R	95-00	MYSTIQUE All	
M55697	W		143004
F	96-00	CHRYSLER TOWN & COUNTRY All	
F	00	VOYAGER / GRAND VOYAGER All	
F	00	VOYAGER / GRAND VOYAGER Non-ABS	
F	96-00	DODGE CARAVAN / GRAND CARAVAN All Exc. Hydraulic Self-Leveling System	
F	96-00	PLYMOUTH VOYAGER / GRAND VOYAGER All	

Numerical listing

Shock	POP	Alternative No.	MTG Acc. Supplied
Pos.	Year	Application	
M55786	W		141544
R	97-99	ACURA CL All	
R	90-97	HONDA ACCORD All	
M55802	W		141544
F	97-01	ACURA INTEGRA GS	
F	94-01	INTEGRA GS-R	
F	94-01	INTEGRA LS	
F	95-96	INTEGRA Special Edition	
F	92-95	HONDA CIVIC All	
F	93-97	CIVIC DEL SOL All	
M55803	W		142128
R	97-01	ACURA INTEGRA GS	
R	94-01	INTEGRA GS-R	
R	94-01	INTEGRA LS	
R	95-96	INTEGRA Special Edition	
R	92-95	HONDA CIVIC All	
R	93-97	CIVIC DEL SOL All	
R	89-91	CRX All	
M55848	W		
R	91-03	FORD ESCORT All	
R	90-94	MAZDA 323 All	
R	90-94	PROTG / PROTG5 FWD, Non-ABS	
R	91-99	MERCURY TRACER FWD	
M55870	W		141544
F	01-03	ACURA CL All	
F	99-03	TL All	
F	98-02	HONDA ACCORD All	
M55871	W		141544
R	01-03	ACURA CL All	
R	99-03	TL All	
R	98-02	HONDA ACCORD All	
M55877	W		141544
F	97-99	ACURA CL All	
F	94-97	HONDA ACCORD All	
F	95-98	ODYSSEY All	
F	96-99	ISUZU OASIS All	
M55892	W		
F	00-02	CHRYSLER NEON All	
F	03-05	DODGE NEON SXT	
F	00-05	NEON SE	
F	01-04	NEON R/T	
F	00-03	NEON LE	
F	01-02	NEON ACR	
F	01-02	NEON Base	
F	00-02	NEON ES	
F	00-02	NEON LX	
F	00	NEON High Line	
F	00-01	PLYMOUTH NEON All	
M55896	W		
F	01-10	CHRYSLER PT CRUISER All	
M55901	W		142169
R	94-07	FORD TAURUS Sedan	
R	94-05	MERCURY SABLE Sedan	
M55912	W		142081
F	96-99	INFINITI I30 All Right	
F	95-99	NISSAN MAXIMA All Right	
M55913	W		142081
F	96-99	INFINITI I30 All Left	
F	95-99	NISSAN MAXIMA All Left	
M55920	W		142081
F	93-98	MERCURY VILLAGER All Left	
F	93-98	NISSAN QUEST All Left	
M55921	W		142081
F	93-98	MERCURY VILLAGER All Right	
F	93-98	NISSAN QUEST All Right	
M55974	W		142169
F	04-05	CHEVROLET CLASSIC All	
F	97-03	MALIBU All	
F	99-04	OLDSMOBILE ALERO All	
F	99	CUTLASS / CUTLASS SUPREME All	
F	98	CUTLASS / CUTLASS SUPREME All Rear Strut Lower Mounting holes at 2.4" Apart	
F	97	CUTLASS / CUTLASS SUPREME All	
F	99-05	PONTIAC GRAND AM All	
M55975	W		142169
R	97-98	CHEVROLET MALIBU All Rear Strut Lower Mounting holes at 3.2" Apart	

Numerical listing

Shock	POP	Alternative No.	MTG Acc. Supplied
Pos.	Year	Application	
M55975	W	(cont)	142169
R	97-98	OLDSMOBILE CUTLASS / CUTLASS SUPREME All First Design with Rear Strut Lower Mounting Holes at 3.2" Apart	
M56501	W		142169
R	04-05	CHEVROLET CLASSIC All	
R	98-03	MALIBU All Rear Strut Lower Mounting holes at 2.4" Apart	
R	99-04	OLDSMOBILE ALERO All	
R	99	CUTLASS / CUTLASS SUPREME All	
R	98	CUTLASS / CUTLASS SUPREME All Second Design with Rear Strut Lower Mounting holes at 2.4" apart	
R	99-05	PONTIAC GRAND AM All	
M56502	W		
F	95-96	LEXUS ES300 All	
F	95-96	TOYOTA AVALON All	
F	95-96	CAMRY All	
M56506	W		
F	97-01	LEXUS ES300 All Left Exc. Electronic Adjustable Suspension	
F	97-03	TOYOTA AVALON All Left	
F	97-01	CAMRY All Left	
F	99-03	SOLARA All Left	
M56514	W		
F	97-01	LEXUS ES300 All Right Exc. Electronic Adjustable Suspension	
F	97-03	TOYOTA AVALON All Right	
F	97-01	CAMRY All Right	
F	99-03	SOLARA All Right	
M56516	W		
F	00-05	FORD FOCUS All Left	
M56517	W		141682
F	00-05	FORD FOCUS All Right	
M56558	W		
F	99-04	HONDA ODYSSEY All Right	
M56559	W		
F	99-04	HONDA ODYSSEY All Left	
M56621	W		
F	01-03	ACURA EL All Left	
F	03-05	HONDA CIVIC Hybrid Left	
F	02	CIVIC Coupe Left	
F	02	CIVIC Sedan Left	
F	01	CIVIC All Left	
M56622	W		
F	01-03	ACURA EL All Right	
F	03-05	HONDA CIVIC Hybrid Right	
F	02	CIVIC Coupe Right	
F	02	CIVIC Sedan Right	
F	01	CIVIC All Right	
M56708	W		
R	88-96	BUICK REGAL All	
R	90-94	CHEVROLET LUMINA All	
R	97	OLDSMOBILE CUTLASS / CUTLASS SUPREME All Exc. Rear Strut Lower Mounting holes at 3.2" apart	
R	88-96	CUTLASS / CUTLASS SUPREME All	
R	88-96	PONTIAC GRAND PRIX All	
M56718	W		
F	91-99	BUICK LESABRE All	
F	90	LESABRE All Late Design Front Strut without Spring Guard	
F	91-96	PARK AVENUE All	
F	95-96	RIVIERA All	
F	93	CADILLAC 60 SPECIAL All	
F	91-93	COMMERCIAL CHASSIS FWD	
F	91-93	DEVILLE All Exc. Electronic Adjustable Suspension	
F	91-93	FLEETWOOD All	
F	92-99	OLDSMOBILE 88 SERIES All	
F	90-91	88 SERIES All Late Design Front Strut without Spring Guard	
F	91-96	98 All CCR Computer Command Ride	
F	95-96	AURORA All	
F	96-99	LSS All	
F	97-98	REGENCY All	
F	94-99	PONTIAC BONNEVILLE All Exc. CCR Computer Command Ride	
F	91-93	BONNEVILLE All	

Guardian Struts, Ultra ReadyMount

Shock	POP	Alternative No.	MTG Acc. Supplied
Pos.	Year	Application	
M56718	W	(cont)	
F	90	BONNEVILLE All Late Design Front Strut without Spring Guard	
Ultra ReadyMount			
G56726	W		
R	85-90	BUICK ELECTRA Air (RearSpringType) Conventional Replacement for Air Assist Rear Susp. Strut w/Upper Mount	
R	86-99	LESABRE Coil (RearSpringType)	
R	91-96	PARK AVENUE Air (RearSpringType) Conventional Replacement for Air Assist Susp.; Exc. Elec. Adj. Susp.	
R	93	CADILLAC 60 SPECIAL Coil (RearSpringType) Conventional Type Replacement for Air Assist Rear Suspension	
R	85-93	DEVILLE Air (RearSpringType) Conventional Type Replacement for Air Assist Rear Suspension	
R	85-93	FLEETWOOD All Conventional Type Replacement for Air Assist Rear Suspension	
R	92-99	OLDSMOBILE 88 SERIES Coil (RearSpringType) Exc. Electronic Adjustable Suspension	
R	86-91	88 SERIES Coil (RearSpringType)	
R	85-96	98 Air (RearSpringType) Conventional Type Replacement	
R	96-99	LSS Coil (RearSpringType) Conventional Type Replacement for Air Assist Rear Suspension	
R	97-98	REGENCY Coil (RearSpringType)	
R	91-99	PONTIAC BONNEVILLE Coil (RearSpringType) Exc. Electronic Adjustable Suspension	
R	87-90	BONNEVILLE Coil (RearSpringType)	
G56924	A		
R	05-09	BUICK ALLURE All Left Models w/ 16" Wheels	
R	97-05	CENTURY All Left	
R	05-09	LACROSSE All Left Models w/ 16" Wheels	
R	97-04	REGAL All Left	
R	00-16	CHEVROLET IMPALA All Left Models w/ 16" Wheels	
R	00-07	MONTE CARLO All Left Models w/ 16" Wheels	
R	98-02	OLDSMOBILE INTRIGUE All Left	
R	97-08	PONTIAC GRAND PRIX All Left Models w/ 16" Wheels	
G56925	A		
R	05-09	BUICK ALLURE All Right Models w/ 16" Wheels	
R	97-05	CENTURY All Right	
R	05-09	LACROSSE All Right Models w/ 16" Wheels	
R	97-04	REGAL All Right	
R	00-16	CHEVROLET IMPALA All Right Models w/ 16" Wheels	
R	00-07	MONTE CARLO All Right Models w/ 16" Wheels	
R	98-02	OLDSMOBILE INTRIGUE All Right	
R	97-08	PONTIAC GRAND PRIX All Right Models w/ 16" Wheels	
G56927	C		
F	04-05	CHEVROLET CLASSIC All	
F	97-03	MALIBU All	
F	99-04	OLDSMOBILE ALERO All	
F	97-99	CUTLASS / CUTLASS SUPREME All	
F	99-05	PONTIAC GRAND AM All	
G56928	D		
R	04-05	CHEVROLET CLASSIC All	
R	98-03	MALIBU All Rear Strut Lower Mounting holes at 2.4" Apart	
R	99-04	OLDSMOBILE ALERO All	
R	99-05	PONTIAC GRAND AM All	
G56929	W		
F	98-05	BUICK PARK AVENUE All	
F	98-99	RIVIERA All	
G56930	A		
F	97-01	LEXUS ES300 All Left Exc. Electronic Adjustable Suspension	
F	97-03	TOYOTA AVALON All Left	
F	97-01	CAMRY All Left	

Numerical listing

Shock	POP	Alternative No.	MTG Acc. Supplied
Pos.	Year	Application	
G56930	A	(cont)	
F	99-03	SOLARA All Left	
G56931	A		
F	97-01	LEXUS ES300 All Right Exc. Electronic Adjustable Suspension	
F	97-03	TOYOTA AVALON All Right	
F	97-01	CAMRY All Right	
F	99-03	SOLARA All Right	
G56932	A		
R	92-02	LEXUS ES300 All Left Exc. Electronic Adjustable Suspension	
R	95-03	TOYOTA AVALON All Left	
R	95-01	CAMRY All Left	
R	92-94	CAMRY All Left Sealed OE Struts	
R	99-03	SOLARA All Left	
G56933	A		
R	92-02	LEXUS ES300 All Right Exc. Electronic Adjustable Suspension	
R	95-03	TOYOTA AVALON All Right	
R	95-01	CAMRY All Right	
R	92-94	CAMRY All Right Sealed OE Struts	
R	99-03	SOLARA All Right	
G56934	B		
F	96-07	FORD TAURUS All Left	
F	96-05	MERCURY SABLE All Left	
G56935	W		
F	95-03	FORD WINDSTAR All	
G56936	C		
R	94-07	FORD TAURUS Sedan	
R	94-05	MERCURY SABLE Sedan	
G56937	B		
F	96-07	FORD TAURUS All Right	
F	96-05	MERCURY SABLE All Right	
G56938	W		
R	95-05	CHEVROLET CAVALIER All	
R	95-05	PONTIAC SUNFIRE All	
G56939	W		
F	95-98	CHEVROLET CAVALIER All	
F	95-98	PONTIAC SUNFIRE All	
G56943	C		
R	01-03	ACURA CL All	
R	99-03	TL Base	
R	98-02	HONDA ACCORD All	
G56948	W		
F	98-02	CHEVROLET PRIZM All	
F	98-02	TOYOTA COROLLA All	
G56949	C		
R	98-02	CHEVROLET PRIZM All Left	
R	93-97	GEO PRIZM All Left	
R	93-02	TOYOTA COROLLA All Left	
G56950	C		
R	98-02	CHEVROLET PRIZM All Right	
R	93-97	GEO PRIZM All Right	
R	93-02	TOYOTA COROLLA All Right	
G56951	D		143035
F	99-05	CHEVROLET CAVALIER All	
F	99-05	PONTIAC SUNFIRE All	
G56956	A		
F	01-07	CHRYSLER TOWN & COUNTRY All Left	
F	01-07	VOYAGER / GRAND VOYAGER All Left	
F	01-07	DODGE CARAVAN / GRAND CARAVAN All Left	
G56957	A		
F	01-07	CHRYSLER TOWN & COUNTRY All Right	
F	01-07	VOYAGER / GRAND VOYAGER All Right	
F	01-07	DODGE CARAVAN / GRAND CARAVAN All Right	
G56962	W		
F	99-04	CHRYSLER 300M All Left	
F	98-04	CONCORDE All Left	
F	98-04	INTREPID All Left	
F	99-01	LHS All Left	
F	98-04	DODGE INTREPID All Left	
G56963	W		
F	99-04	CHRYSLER 300M All Right	
F	98-04	CONCORDE All Right	

Numerical listing

Shock	POP	Alternative No.	MTG Acc. Supplied
Pos.	Year	Application	
G56963 W (cont)			
F	98-04	INTREPID	All Right
F	99-01	LHS	All Right
F	98-04	DODGE INTREPID	All Right
G56964 W			
R	99-04	CHRYSLER 300M	All
R	98-04	CONCORDE	All
R	99-01	LHS	All
R	98-04	DODGE INTREPID	All
G56965 W			
F	01-10	CHRYSLER PT CRUISER	All
G56973 W			
R	00-02	CHRYSLER NEON	All Left
R	03-05	DODGE NEON SXT	Left
R	00-05	NEON SE	Left
R	01-04	NEON R/T	Left
R	00-03	NEON LE	Left
R	01-02	NEON ACR	Left
R	01-02	NEON Base	Left
R	00-02	NEON ES	Left
R	00-02	NEON LX	Left
R	00	NEON High Line	Left
R	00-01	PLYMOUTH NEON	All Left
G56974 W			
R	00-02	CHRYSLER NEON	All Right
R	03-05	DODGE NEON SXT	Right
R	00-05	NEON SE	Right
R	01-04	NEON R/T	Right
R	00-03	NEON LE	Right
R	01-02	NEON ACR	Right
R	01-02	NEON Base	Right
R	00-02	NEON ES	Right
R	00-02	NEON LX	Right
R	00	NEON High Line	Right
R	00-01	PLYMOUTH NEON	All Right
G56975 W			
F	00-02	CHRYSLER NEON	All
F	03-05	DODGE NEON SXT	
F	00-05	NEON SE	
F	01-04	NEON R/T	
F	00-03	NEON LE	
F	01-02	NEON ACR	
F	01-02	NEON Base	
F	00-02	NEON ES	
F	00-02	NEON LX	
F	00	NEON High Line	
F	00-01	PLYMOUTH NEON	All
G56991 B			
F	01-03	ACURA CL	All Left
F	99-03	TL	All Left
F	98-02	HONDA ACCORD 2.3L 4Cyl L (2254), 3.39 86.0(Bore)3.82 97.0(Stroke) Left	
G56992 B			
F	01-03	ACURA CL	All Right
F	99-03	TL	All Right
F	98-02	HONDA ACCORD 2.3L 4Cyl L (2254), 3.39 86.0(Bore)3.82 97.0(Stroke) Right	
G56993 C			
F	97-01	ACURA INTEGRA	GS Left
F	94-01	INTEGRA	GS-R Left
F	94-01	INTEGRA	LS Left
F	94-98	INTEGRA	RS Left
F	95-96	INTEGRA	Special Edition Left
F	92-95	HONDA CIVIC	All Left
G56994 C			
F	97-01	ACURA INTEGRA	GS Right
F	94-01	INTEGRA	GS-R Right
F	94-01	INTEGRA	LS Right
F	94-98	INTEGRA	RS Right
F	95-96	INTEGRA	Special Edition Right
F	92-95	HONDA CIVIC	All Right
G56995 C			
R	97-01	ACURA INTEGRA	GS
R	94-01	INTEGRA	GS-R
R	94-01	INTEGRA	LS
R	94-98	INTEGRA	RS
R	95-96	INTEGRA	Special Edition
R	92-95	HONDA CIVIC	All
G56996 W			
F	97-00	ACURA EL	All Left
F	96-00	HONDA CIVIC	All Left
G56997 W			
F	97-00	ACURA EL	All Right

Ultra ReadyMount

Shock	POP	Alternative No.	MTG Acc. Supplied
Pos.	Year	Application	
G56997 W (cont)			
F	96-00	HONDA CIVIC	All Right
G56998 D			
R	97-00	ACURA EL	All
R	96-00	HONDA CIVIC	All
G57000 C			
F	07-18	CHEVROLET PICKUP 1/2 TON, SILVERADO 1500 4WD	
F	19	SILVERADO 1500 LD 4WD	
F	07-18	GMC SIERRA 1500 4WD	
G57005 W			
F	85-96	VOLKSWAGEN GOLF	All
F	85-96	JETTA	All
G57006 W			
F	97-98	VOLKSWAGEN GOLF 2.0L 4Cyl L (121), 3.25 82.5(Bore)3.65 92.8(Stroke)	
F	97-98	JETTA 2.0L 4Cyl L (121), 3.25 82.5(Bore)3.65 92.8(Stroke)	
G57007 A			
F	07-11	DODGE NITRO	All Left
F	07-12	JEEP LIBERTY	All Left
F	05-06	LIBERTY GAS	Left
F	02-04	LIBERTY	All Left
G57008 A			
F	07-11	DODGE NITRO	All Right
F	07-12	JEEP LIBERTY	All Right
F	05-06	LIBERTY GAS	Right
F	02-04	LIBERTY	All Right
G57010 C			
F	98-04	TOYOTA TACOMA	Pre Runner, RWD
F	95-04	TACOMA	4WD
G57011 D			
F	99-04	HONDA ODYSSEY	All Left
G57012 D			
F	99-04	HONDA ODYSSEY	All Right
G57013 W			
F	91-02	SATURN SC / SL / SW	SERIES All
G57014 W			
R	91-02	SATURN SC / SL / SW	SERIES All
G57015 W			
F	03-06	FORD EXPEDITION	4WD
F	03-06	LINCOLN NAVIGATOR	All
G57016 D			
R	03-06	FORD EXPEDITION	All
R	03-06	LINCOLN NAVIGATOR	All
G57017 W			
F	02-03	FORD EXPLORER	Eddie Bauer
F	02-03	EXPLORER	Limited
F	02-03	EXPLORER	Postal
F	02-03	EXPLORER XLS	
F	02-03	EXPLORER XLT	
F	02-03	MERCURY MOUNTAINEER	All
G57018 C			
R	02-05	FORD EXPLORER	Eddie Bauer
R	02-05	EXPLORER	Limited
R	02-05	EXPLORER XLS	
R	02-05	EXPLORER XLT	
R	04	EXPLORER	NBX
R	02-03	EXPLORER	Postal
R	02-05	MERCURY MOUNTAINEER	All
G57019 D			
F	04-05	FORD EXPLORER	Eddie Bauer
F	04-05	EXPLORER	Limited
F	04-05	EXPLORER XLS	
F	04-05	EXPLORER XLT	
F	04	EXPLORER	NBX
F	04-05	MERCURY MOUNTAINEER	All
G57020 B			
F	04-08	FORD LOBO	4WD
F	04-08	PICKUP 1/2 TON, F-150	4WD
F	06-08	LINCOLN MARK LT	4WD
G57021 B			
F	04-08	FORD LOBO	RWD
F	04-08	PICKUP 1/2 TON, F-150	RWD
F	06-08	LINCOLN MARK LT	RWD
G57022 A			
F	04-07	BUICK RAINIER	All

Numerical listing

Shock	POP	Alternative No.	MTG Acc. Supplied
Pos.	Year	Application	
G57022 A (cont)			
F	06-09	CHEVROLET TRAILBLAZER	LT
F	06-08	TRAILBLAZER	Base
F	06-07	TRAILBLAZER	A
F	06-07	TRAILBLAZER	B
F	06-07	TRAILBLAZER	LS
F	02-05	TRAILBLAZER	All
F	02-09	GMC ENVOY	All
F	03-08	ISUZU ASCENDER	All
F	02-04	OLDSMOBILE BRAVADA	All
F	05-09	SAAB 9-7X	All
G57023 A			
F	07-18	CHEVROLET PICKUP 1/2 TON, SILVERADO 1500 RWD Exc. Electronic Ride Control	
F	19	SILVERADO 1500 LD RWD Exc. Electronic Ride Control	
F	20	SUBURBAN 1/2 TON, 1500 4WD Old Body Style	
F	15-19	SUBURBAN 1/2 TON, 1500 4WD	
F	15-19	TAHOE	4WD
F	07-18	GMC SIERRA 1500 RWD Exc. Electronic Ride Control	
F	15-20	YUKON	4WD Old Body Style
F	19-20	YUKON XL	4WD Old Body Style
F	15-18	YUKON XL	4WD
G57025 W			
R	99-00	CHRYSLER CIRRUS	All
R	99-00	DODGE STRATUS	All
R	99-00	PLYMOUTH BREEZE	All
G57026 C			
R	01-06	CHRYSLER SEBRING JR (MfrBodyCode), Sedan	
R	01-06	DODGE STRATUS	Sedan
G57027 C			
F	01-07	TOYOTA SEQUOIA	All
F	00-06	TUNDRA	All
G57030 C			
F	02-06	NISSAN ALTIMA	All Left
F	04-08	MAXIMA	All Left
G57031 C			
F	02-06	NISSAN ALTIMA	All Right
F	04-08	MAXIMA	All Right
G57032 W			
R	01-02	HONDA CIVIC	All Left
G57033 W			
R	01-02	HONDA CIVIC	All Right
G57034 W			
F	04-06	NISSAN SENTRA	Base Left
F	04-06	SENTRA	S Left
F	02-06	SENTRA	GXE Left
F	02-06	SENTRA	GXE Sport Left
F	02-06	SENTRA	XE Left
F	06	SENTRA	XE SE Edicion Especial Left
F	06	SENTRA	XE SE Left
F	03-04	SENTRA	LE Left
F	03	SENTRA	Limited Edition Left
F	02	SENTRA	CA Left
G57035 W			
F	04-06	NISSAN SENTRA	Base Right
F	04-06	SENTRA	GXE Right
F	04-06	SENTRA	S Right
F	02-06	SENTRA	GXE Sport Right
F	02-06	SENTRA	XE Right
F	06	SENTRA	XE SE Edicion Especial Right
F	03-04	SENTRA	LE Right
F	03	SENTRA	Limited Edition Right
F	02	SENTRA	CA Right
G57036 W			
R	02-06	NISSAN SENTRA	All
G57037 C			
F	99	INFINITI QX4	All Left
F	98	QX4	All Left Mfg. to 11/98
F	97	QX4	All Left
F	99	NISSAN PATHFINDER	All Left
F	98	PATHFINDER	All Left Mfg. to 11/98
F	96-97	PATHFINDER	All Left
G57038 C			
F	99	INFINITI QX4	All Right
F	98	QX4	All Right Mfg. to 11/98
F	97	QX4	All Right
F	99	NISSAN PATHFINDER	All Right

Numerical listing

Shock	POP	Alternative No.	MTG Acc. Supplied
Pos.	Year	Application	
G57038 C (cont)			
F	98	PATHFINDER	All Right Mfg. to 11/98
F	96-97	PATHFINDER	All Right
G57039 B			
F	98-10	VOLKSWAGEN BEETLE	All
F	99-06	GOLF	All
F	99-05	JETTA	All
G57040 C			
F	93-97	VOLVO 850	All Exc. Hydraulic Self-Leveling System
F	98-04	C70	All
F	98-00	S70	All
F	99-00	V70	R AWD Mfg. to 3/00; Exc XC Cross Country
F	98-00	V70	Base Mfg. to 3/00; Exc XC Cross Country
F	98-00	V70	GLT Mfg. to 3/00; Exc XC Cross Country
F	98-00	V70	T5 Mfg. to 3/00; Exc XC Cross Country
F	00	V70	2.4T Mfg. to 3/00; Exc XC Cross Country
F	00	V70	GLT SE Mfg. to 3/00; Exc XC Cross Country
F	98-99	V70	AWD Mfg. to 3/00; Exc XC Cross Country
F	98	V70	R Mfg. to 3/00; Exc XC Cross Country
G57041 C			
F	02-03	LEXUS ES300	All Left
F	02-03	TOYOTA CAMRY	All Left
G57042 C			
F	02-03	LEXUS ES300	All Right
F	02-03	TOYOTA CAMRY	All Right
G57043 C			
R	02-03	LEXUS ES300	All Left
R	02-03	TOYOTA CAMRY	All Left
G57044 C			
R	02-03	LEXUS ES300	All Right
R	02-03	TOYOTA CAMRY	All Right
G57045 A			
F	01-12	FORD ESCAPE	All Left
F	08-11	MAZDA TRIBUTE	All Left
F	01-06	TRIBUTE	All Left
F	05-11	MERCURY MARINER	All Left
G57046 A			
F	01-12	FORD ESCAPE	All Right
F	08-11	MAZDA TRIBUTE	All Right
F	01-06	TRIBUTE	All Right
F	05-11	MERCURY MARINER	All Right
G57047 A			
F	05-10	CHEVROLET COBALT	LS Left
F	05-10	COBALT	LT Left
F	10	COBALT	Base Left
F	10	COBALT	LT Team Canada Left
F	06-07	COBALT	LTZ Left
F	05	COBALT	Base Left
F	11	HHR	All Left
F	08-10	HHR	LS Panel Left
F	08-10	HHR	LT Panel Left
F	06-10	HHR	LS Left
F	06-10	HHR	LT Left
F	06-08	HHR	Comfort LT Left
F	06-08	HHR	Elegance LT Left
F	07	HHR	Edicion Especial Left
F	07-09	PONTIAC G5	All Left
F	05-06	PURSUIT	All Left
G57048 A			
F	05-10	CHEVROLET COBALT	LS Right
F	05-10	COBALT	LT Right
F	10	COBALT	Base Right
F	10	COBALT	LT Team Canada Right
F	06-07	COBALT	LTZ Right
F	05	COBALT	Base Right
F	11	HHR	All Right
F	08-10	HHR	LS Panel Right
F	08-10	HHR	LT Panel Right
F	06-10	HHR	LS Right
F	06-10	HHR	LT Right
F	06-08	HHR	Comfort LT Right
F	06-08	HHR	Elegance LT Right
F	07	HHR	Edicion Especial Right
F	07-09	PONTIAC G5	All Right
F	05-06	PURSUIT	All Right

Ultra ReadyMount

Shock	POP	Alternative No.	MTG Acc. Supplied
Pos.	Year	Application	
G57049 C			
F	04-05	HONDA CIVIC	Value Package Left
F	01-05	CIVIC	DX Left
F	01-05	CIVIC	EX Left
F	01-05	CIVIC	GX Left
F	01-05	CIVIC	HX Left
F	01-05	CIVIC	LX Left
F	05	CIVIC	EX Special Edition Left
F	05	CIVIC	LX Special Edition Left
F	05	CIVIC	Reverb Left
F	02-04	CIVIC	Si, Hatchback Left
G57050 C			
F	04-05	HONDA CIVIC	Value Package Right
F	01-05	CIVIC	DX Right
F	01-05	CIVIC	EX Right
F	01-05	CIVIC	GX Right
F	01-05	CIVIC	HX Right
F	01-05	CIVIC	LX Right
F	05	CIVIC	EX Special Edition Right
F	05	CIVIC	LX Special Edition Right
F	05	CIVIC	Reverb Right
F	02-04	CIVIC	Si, Hatchback Right
G57051 A			
F	00-05	BUICK LESABRE	All Exc. Electronic Adjustable Suspension
F	00-05	CADILLAC DEVILLE	All Exc. Electronic Adjustable Suspension
F	98-04	SEVILLE	All Exc. Electronic Adjustable Suspension
F	01-03	OLDSMOBILE AURORA	All Exc. Electronic Adjustable Suspension
F	98-99	AURORA	All Exc. Electronic Adjustable Suspension
F	00-05	PONTIAC BONNEVILLE	All Exc. Electronic Adjustable Suspension
G57053 W			
F	06-08	DODGE PICKUP	1/2 TON, RAM 1500 (SEE RAM 1500) 4WD Exc. Mega Cab
G57054 C			
F	03-07	HONDA ACCORD	All Left
G57055 C			
F	03-07	HONDA ACCORD	All Right
G57056 C			
R	04-08	ACURA TL	All
R	06-07	HONDA ACCORD	Value Package
R	05-07	ACCORD	EX
R	05-07	ACCORD	LX
R	07	ACCORD	LX SE
R	07	ACCORD	Special Edition
R	06	ACCORD	LX Special Edition
R	05	ACCORD	DX
R	05	ACCORD	SE
R	03-04	ACCORD	All
G57057 D			
R	96-99	INFINITI I30	All Left
R	95-99	NISSAN MAXIMA	All Left
G57058 D			
R	96-99	INFINITI I30	All Right
R	95-99	NISSAN MAXIMA	All Right
G57059 W			
F	00-05	HYUNDAI SONATA	All
F	01-06	KIA OPTIMA	All
G57060 A			
F	05-09	BUICK ALLURE	All
F	97-05	CENTURY	All
F	05-09	LACROSSE	All
F	97-04	REGAL	All
F	00-13	CHEVROLET IMPALA	All
F	14-16	IMPALA LIMITED	All Classic Body Style
F	00-07	MONTE CARLO	All
F	05	VENTURE	All
F	97-04	VENTURE	FWD
F	98-02	OLDSMOBILE INTRIGUE	All
F	97-04	SILHOUETTE	All
F	97-03	PONTIAC GRAND PRIX	All
F	99-05	MONTANA	Base
F	97-99	TRANS SPORT	All
G57061 W			
R	03-05	HONDA CIVIC	All Left
G57062 W			
R	03-05	HONDA CIVIC	All Right

Numerical listing

Shock	POP	Alternative No.	MTG Acc. Supplied
Pos.	Year	Application	
G57063 D			
F	00-05	FORD FOCUS	All Left
G57064 D			
F	00-05	FORD FOCUS	All Right
G57065 A			
F	96-02	TOYOTA 4RUNNER	All Left
G57066 A			
F	96-02	TOYOTA 4RUNNER	All Right
G57067 C			
R	03-08	PONTIAC VIBE	FWD Left
R	03-08	TOYOTA COROLLA	All Left
R	03-08	MATRIX	FWD Left
G57068 C			
R	03-08	PONTIAC VIBE	FWD Right
R	03-08	TOYOTA COROLLA	All Right
R	03-08	MATRIX	FWD Right
G57069 A			
F	11-12	CHEVROLET MALIBU	All Left
F	08-10	MALIBU	LS, 3.5L 6Cyl V (213), 3.90 99.0(Bore)2.99 76.0(Stroke) Left
F	08-10	MALIBU	L TZ, 3.6L 6Cyl V (217), 3.70 94.0(Bore)3.37 85.6(Stroke) Left
F	10	MALIBU	LT, 3.6L 6Cyl V (217), 3.70 94.0(Bore)3.37 85.6(Stroke) Left
F	09	MALIBU	LT, 3.5L 6Cyl V (213), 3.90 99.0(Bore)2.99 76.0(Stroke) Left
F	08	MALIBU	Classic LS, 3.5L 6Cyl V (213), 3.90 99.0(Bore)2.99 76.0(Stroke) Left
F	08	MALIBU	Classic LT, 3.5L 6Cyl V (213), 3.90 99.0(Bore)2.99 76.0(Stroke) Left
F	08	MALIBU	LT, 3.5L 6Cyl V (213), 3.70 94.0(Bore)3.31 84.0(Stroke) Left
F	06-07	MALIBU	L TZ Left
F	06-07	MALIBU	SS Left
F	04-07	MALIBU	Base Left
F	04-07	MALIBU	LS Left
F	04-07	MALIBU	LT Left
F	04-07	MALIBU	Maxx LS Left
F	04-07	MALIBU	Maxx LT Left
F	04	MALIBU	Maxx Left
F	07-10	PONTIAC G6	Sedan, 3.5L 6Cyl V (213), 3.90 99.0(Bore)2.99 76.0(Stroke) Left
F	07-09	G6	Coupe, 3.5L 6Cyl V (213), 3.90 99.0(Bore)2.99 76.0(Stroke) Left
F	06-09	G6	Coupe, 3.9L 6Cyl V (237), 3.90 99.0(Bore)3.31 84.0(Stroke) Left
F	05-09	G6	Sedan, 3.5L 6Cyl V (213), 3.70 94.0(Bore)3.31 84.0(Stroke) Left
F	07-08	SATURN AURA	XE, 3.5L 6Cyl V (213), 3.90 99.0(Bore)2.99 76.0(Stroke) Left
G57070 A			
F	11-12	CHEVROLET MALIBU	All Right
F	08-10	MALIBU	LS, 3.5L 6Cyl V (213), 3.90 99.0(Bore)2.99 76.0(Stroke) Right
F	08-10	MALIBU	L TZ, 3.6L 6Cyl V (217), 3.70 94.0(Bore)3.37 85.6(Stroke) Right
F	10	MALIBU	LT, 3.6L 6Cyl V (217), 3.70 94.0(Bore)3.37 85.6(Stroke) Right
F	09	MALIBU	LT, 3.5L 6Cyl V (213), 3.90 99.0(Bore)2.99 76.0(Stroke) Right
F	08	MALIBU	Classic LS, 3.5L 6Cyl V (213), 3.90 99.0(Bore)2.99 76.0(Stroke) Right
F	08	MALIBU	Classic LT, 3.5L 6Cyl V (213), 3.90 99.0(Bore)2.99 76.0(Stroke) Right
F	08	MALIBU	LT, 3.5L 6Cyl V (213), 3.70 94.0(Bore)3.31 84.0(Stroke) Right
F	06-07	MALIBU	L TZ Right
F	06-07	MALIBU	Maxx LTZ Right
F	06-07	MALIBU	SS Right
F	04-07	MALIBU	Base Right
F	04-07	MALIBU	LS Right
F	04-07	MALIBU	LT Right
F	04-07	MALIBU	Maxx LS Right
F	04-07	MALIBU	Maxx LT Right
F	04	MALIBU	Maxx Right
F	07-10	PONTIAC G6	Sedan, 3.5L 6Cyl V (213), 3.90 99.0(Bore)2.99 76.0(Stroke) Right
F	07-09	G6	Coupe, 3.5L 6Cyl V (213), 3.90 99.0(Bore)2.99 76.0(Stroke) Right

Numerical listing

Shock	POP	Alternative No.	MTG Acc. Supplied
Pos.	Year	Application	
G57070	A (cont)		
F	06-09	G6 Coupe, 3.9L 6Cyl V (237), 3.90 99.0(Bore)3.31 84.0(Stroke) Right	
F	05-09	G6 Sedan, 3.5L 6Cyl V (213), 3.70 94.0(Bore)3.31 84.0(Stroke) Right	
F	07-08	SATURN AURA XE, 3.5L 6Cyl V (213), 3.90 99.0(Bore)2.99 76.0(Stroke) Right	
G57071	B		
F	05-10	CHRYSLER 300 RWD, 5.7L 8Cyl V (345), 3.92 99.57(Bore)3.58 90.93(Stroke) Left	
F	06-10	DODGE CHARGER RWD, 5.7L 8Cyl V (345), 3.92 99.57(Bore)3.58 90.93(Stroke) Left	
F	05-08	MAGNUM RWD, 5.7L 8Cyl V (345), 3.92 99.57(Bore)3.58 90.93(Stroke) Left	
G57072	B		
F	05-10	CHRYSLER 300 RWD, 5.7L 8Cyl V (345), 3.92 99.57(Bore)3.58 90.93(Stroke) Right	
F	06-10	DODGE CHARGER RWD, 5.7L 8Cyl V (345), 3.92 99.57(Bore)3.58 90.93(Stroke) Right	
F	05-08	MAGNUM RWD, 5.7L 8Cyl V (345), 3.92 99.57(Bore)3.58 90.93(Stroke) Right	
G57075	W		
R	01-05	CHRYSLER SEBRING ST (MfrBodyCode), Coupe	
R	99-00	SEBRING Coupe	
R	01-05	DODGE STRATUS Coupe	
R	99-03	MINISUBISHI GALANT GTZ	
G57076	B		
F	04-06	LEXUS ES330 All Left	
F	04-06	TOYOTA CAMRY 2.4L 4Cyl L (2362), 3.48 88.5(Bore)3.78 96.0(Stroke) Left	
F	04-08	SOLARA 2.4L 4Cyl L (2362), 3.48 88.5(Bore)3.78 96.0(Stroke) Left	
G57077	B		
F	04-06	LEXUS ES330 All Right	
F	04-06	TOYOTA CAMRY 2.4L 4Cyl L (2362), 3.48 88.5(Bore)3.78 96.0(Stroke) Right	
F	04-08	SOLARA 2.4L 4Cyl L (2362), 3.48 88.5(Bore)3.78 96.0(Stroke) Right	
G57078	B		
R	04-06	LEXUS ES330 All Left	
R	04-06	TOYOTA CAMRY All Left	
R	04-06	SOLARA All Left	
G57079	B		
R	04-06	LEXUS ES330 All Right	
R	04-06	TOYOTA CAMRY All Right	
R	04-06	SOLARA All Right	
G57080	D		
F	10-11	FORD CROWN VICTORIA Base	
F	03-11	CROWN VICTORIA LX	
F	03-08	CROWN VICTORIA Base	
F	06	CROWN VICTORIA LX Sport	
F	05	CROWN VICTORIA S	
F	03	CROWN VICTORIA LWB	
F	03	CROWN VICTORIA S	
F	03-11	LINCOLN TOWN CAR All Exc. Limo	
F	03-11	MERCURY GRAND MARQUIS All	
F	03-04	MARAUDER All	
G57081	D		
F	06-11	FORD FOCUS All Left	
G57082	D		
F	06-11	FORD FOCUS All Right	
G57083	W		
F	06-10	JEEP COMMANDER 3.7L 6Cyl V (226) Exc. Performance	
F	05-10	GRAND CHEROKEE AWD, 5.7L 8Cyl V (345), 3.92 99.57(Bore)3.58 90.93(Stroke) Exc. Performance	
G57084	D		
F	02-06	HONDA CR-V Automatic Left	
G57085	D		
F	02-06	HONDA CR-V Automatic Right	

Ultra ReadyMount

Shock	POP	Alternative No.	MTG Acc. Supplied
Pos.	Year	Application	
G57086	D		
R	02-06	HONDA CR-V All Left	
G57087	D		
R	02-06	HONDA CR-V All Right	
G57088	W		
F	00-06	HYUNDAI ELANTRA Automatic Left	
G57089	W		
F	00-06	HYUNDAI ELANTRA Automatic Right	
G57090	W		
R	00-05	HYUNDAI SONATA All Left	
R	01-06	KIA MAGENTIS All Left	
R	01-06	OPTIMA All Left	
G57091	W		
R	00-05	HYUNDAI SONATA All Right	
R	01-06	KIA MAGENTIS All Right	
R	01-06	OPTIMA All Right	
G57092	A		
F	04-10	INFINITI QX56 4WD	
F	10-15	NISSAN ARMADA 4WD Exc. Auto-Leveling System	
F	05-09	ARMADA 4WD	
F	04	PATHFINDER ARMADA All	
F	17-22	TITAN All Exc. Off Road	
F	07-15	TITAN 4WD Exc. Off Road	
F	07-15	TITAN RWD	
F	04-06	TITAN All	
G57095	W		
F	06-10	FORD EXPLORER All	
F	06-10	MERCURY MOUNTAINEER All	
G57096	W		
R	06-10	FORD EXPLORER All	
R	06-10	MERCURY MOUNTAINEER All	
G57097	C		
F	03	TOYOTA SIENNA All Left	
F	02	SIENNA All Left Mfg. to 12/02	
F	98-01	SIENNA All Left	
G57098	C		
F	03	TOYOTA SIENNA All Right	
F	02	SIENNA All Right Mfg. to 12/02	
F	98-01	SIENNA All Right	
G57099	D		
F	03-07	SATURN ION All Left	
G57100	D		
F	03-07	SATURN ION All Right	
G57101	W		
F	02-07	SATURN VUE 2.2L 4Cyl L (134), 3.39 86.0(Bore)3.72 94.6(Stroke) Left	
G57102	W		
F	02-07	SATURN VUE 2.2L 4Cyl L (134), 3.39 86.0(Bore)3.72 94.6(Stroke) Right	
G57103	C		
F	09-13	FORD LOBO Extended Cab Pickup, 4WD Exc. Sport Suspension	
F	09-13	PICKUP 1/2 TON, F-150 Extended Cab Pickup, 4WD Exc. Sport Suspension	
G57105	W		
F	00-05	TOYOTA RAV4 AWD, Automatic Left Mfg. from 5/00	
G57106	W		
F	00-05	TOYOTA RAV4 AWD, Automatic Right Mfg. from 5/00	
G57107	A		
F	93-02	CHEVROLET CAMARO All Left	
F	93-02	PONTIAC FIREBIRD All Left	
G57108	A		
F	93-02	CHEVROLET CAMARO All Right	
F	93-02	PONTIAC FIREBIRD All Right	
G57109	A		
F	08-12	BUICK ENCLAVE AWD	
F	09-12	CHEVROLET TRAVERSE AWD	
F	07-12	GMC ACADIA AWD	
F	07-10	SATURN OUTLOOK AWD	

Numerical listing

Shock	POP	Alternative No.	MTG Acc. Supplied
Pos.	Year	Application	
G57110	B		
F	05-06	CHEVROLET EQUINOX All Left	
G57111	B		
F	05-06	CHEVROLET EQUINOX All Right	
G57112	W		
F	04-08	CHRYSLER PACIFICA All Left	
G57113	W		
F	04-08	CHRYSLER PACIFICA All Right	
G57114	C		
F	03-08	TOYOTA COROLLA All Left	
G57115	C		
F	03-08	TOYOTA COROLLA All Right	
G57118	D		
F	05-11	NISSAN PATHFINDER 4WD	
G57119	D		
F	01-02	ACURA MDX All Left	
F	03-08	HONDA PILOT AWD Left	
G57120	D		
F	01-02	ACURA MDX All Right	
F	03-08	HONDA PILOT AWD Right	
G57121	D		
F	08-10	CHEVROLET MALIBU LS, 2.4L 4Cyl L (145), 3.46 88.0(Bore)3.86 98.0(Stroke) Left	
F	08-10	MALIBU LT, 2.4L 4Cyl L (145), 3.46 88.0(Bore)3.86 98.0(Stroke) Left	
F	08-10	MALIBU LTZ, 2.4L 4Cyl L (145), 3.46 88.0(Bore)3.86 98.0(Stroke) Left	
F	09	MALIBU Base, 2.4L 4Cyl L (145), 3.46 88.0(Bore)3.86 98.0(Stroke) Left	
F	06-10	PONTIAC G6 2.4L 4Cyl L (145), 3.46 88.0(Bore)3.86 98.0(Stroke) Left	
F	08-09	SATURN AURA XE, 2.4L 4Cyl L (145), 3.46 88.0(Bore)3.86 98.0(Stroke) Left	
F	09	AURA XR, 2.4L 4Cyl L (145), 3.46 88.0(Bore)3.86 98.0(Stroke) Left	
F	07-08	AURA Green Line Left	
G57122	D		
F	08-10	CHEVROLET MALIBU LS, 2.4L 4Cyl L (145), 3.46 88.0(Bore)3.86 98.0(Stroke) Right	
F	08-10	MALIBU LT, 2.4L 4Cyl L (145), 3.46 88.0(Bore)3.86 98.0(Stroke) Right	
F	08-10	MALIBU LTZ, 2.4L 4Cyl L (145), 3.46 88.0(Bore)3.86 98.0(Stroke) Right	
F	09	MALIBU Base, 2.4L 4Cyl L (145), 3.46 88.0(Bore)3.86 98.0(Stroke) Right	
F	06-10	PONTIAC G6 2.4L 4Cyl L (145), 3.46 88.0(Bore)3.86 98.0(Stroke) Right	
F	08-09	SATURN AURA XE, 2.4L 4Cyl L (145), 3.46 88.0(Bore)3.86 98.0(Stroke) Right	
F	09	AURA XR, 2.4L 4Cyl L (145), 3.46 88.0(Bore)3.86 98.0(Stroke) Right	
F	07-08	AURA Green Line Right	
G57123	D		
F	07-20	TOYOTA TUNDRA RWD Left	
G57124	D		
F	07-20	TOYOTA TUNDRA RWD Right	
G57125	B		
F	07-13	CHEVROLET AVALANCHE 1500 All Exc. Z55 or ZW7 Ride Suspension	
F	07-14	SUBURBAN 1/2 TON, 1500 All Exc. Z55 or ZW7 Ride Suspension	
F	07-14	TAHOE All Exc. Z55 or ZW7 Ride Suspension	
F	07-14	GMC YUKON All Exc. Z55 or ZW7 Ride Suspension	
F	07-14	YUKON XL 1/2 TON All Exc. Z55 or ZW7 Ride Suspension	
G57126	D		
F	04-08	SUZUKI FORENZA All Left	
F	05-08	RENO All Left	
G57127	D		
F	04-08	SUZUKI FORENZA All Right	

Numerical listing

Shock	POP	Alternative No.	MTG Acc. Supplied
Pos.	Year	Application	
G57127	D	(cont)	
F	05-08	RENO	All Right
G57128	W		
R	04-08	SUZUKI FORENZA	All Left
R	05-08	RENO	All Left
G57129	W		
R	04-08	SUZUKI FORENZA	All Right
R	05-08	RENO	All Right
G57130	B		
F	06-11	CHEVROLET AVEO	All Left
F	04-11	AVEO	All Left
F	09-10	PONTIAC G3	All Left
F	05-08	WAVE	All Left
F	04-09	SUZUKI SWIFT	All Left
G57131	B		
F	06-11	CHEVROLET AVEO	All Right
F	04-11	AVEO	All Right
F	09-10	PONTIAC G3	All Right
F	05-08	WAVE	All Right
F	04-09	SUZUKI SWIFT	All Right
G57132	W		
F	09-13	FORD LOBO	RWD
F	09-13	PICKUP 1/2 TON, F-150	RWD
G57133	B		
F	17-18	TOYOTA 4RUNNER	RWD Left Exc. Kinetic Suspension
F	03-16	4RUNNER	All Left Exc. X-Reas Suspension; Exc. Sport Models
F	07-14	FJ CRUISER	All Left
F	05-15	TACOMA	4WD Left Exc. Off Road & Sport Models
F	05-15	TACOMA	Pre Runner Left 4WD
G57134	B		
F	17-18	TOYOTA 4RUNNER	RWD Right Exc. Kinetic Suspension
F	03-16	4RUNNER	All Right Exc. X-Reas Suspension; Exc. Sport Models
F	07-14	FJ CRUISER	All Right
F	05-15	TACOMA	4WD Right Exc. Off Road & Sport Models
F	05-15	TACOMA	Pre Runner Right 4WD
G57135	C		
F	00-04	AUDI A6	All Left Exc. Sport Suspension
F	00-04	A6 QUATTRO	All Left Exc. Sport Suspension
F	01-05	VOLKSWAGEN PASSAT	All Left
G57136	C		
F	00-04	AUDI A6	All Right Exc. Sport Suspension
F	00-04	A6 QUATTRO	All Right Exc. Sport Suspension
F	01-05	VOLKSWAGEN PASSAT	All Right
G57137	B		
F	05-07	HONDA ODYSSEY	All Left
G57138	B		
F	05-07	HONDA ODYSSEY	All Right
G57139	C		
F	01-06	HYUNDAI SANTA FE	All Left
G57140	C		
F	01-06	HYUNDAI SANTA FE	All Right
G57141	W		
F	04-08	PONTIAC GRAND PRIX	All
G57142	W		
F	05-07	BUICK TERRAZA	FWD
F	05-09	CHEVROLET UPLANDER	FWD Exc. Auto-Leveling System
F	05-09	PONTIAC MONTANA SV6	FWD
F	05-07	SATURN RELAY 2	FWD
F	05-07	RELAY 3	FWD
F	07	RELAY 1	FWD
G57144	D		
F	02-03	INFINITI QX4	All Left
F	02-04	NISSAN PATHFINDER	All Left
G57145	D		
F	02-03	INFINITI QX4	All Right
F	02-04	NISSAN PATHFINDER	All Right
G57146	D		
F	05-09	DODGE DAKOTA	4WD
F	06-09	MITSUBISHI RAIDER	4WD

Ultra ReadyMount

Shock	POP	Alternative No.	MTG Acc. Supplied
Pos.	Year	Application	
G57147	A		
F	09-10	DODGE PICKUP 1/2 TON, RAM 1500 (SEE RAM 1500) 4WD	
F	16-18	RAM 1500 (SEE DODGE RAM 1500) 4WD Exc. Air Suspension	
F	11-15	1500 (SEE DODGE RAM 1500) 4WD	
F	19-20	1500 CLASSIC 4WD Old Body Style	
G57148	W		
F	06-09	FORD FUSION	All
F	07-09	MERCURY MILAN	AWD
F	06	MILAN	FWD
G57149	D		
F	06-11	HYUNDAI AZERA	All
F	06-10	SONATA 2.4L 4Cyl L (2359), 3.46 88.0(Bore)3.82 97.0(Stroke)	
G57150	C		
F	04-06	LEXUS RX330	AWD Left
F	07-09	RX350	FWD Left
G57151	C		
F	04-06	LEXUS RX330	AWD Right
F	07-09	RX350	FWD Right
G57152	D		
R	04-06	LEXUS RX330	AWD Left Non Japan built applications with a clevis mounting hole dimension of 15mm
R	07-09	RX350	AWD Left Non Japan built applications with a clevis mounting hole dimension of 15mm
R	04-07	TOYOTA HIGHLANDER	AWD Left
G57153	D		
R	04-06	LEXUS RX330	AWD Right Non Japan built applications with a clevis mounting hole dimension of 15mm
R	07-09	RX350	AWD Right Non Japan built applications with a clevis mounting hole dimension of 15mm
R	04-07	TOYOTA HIGHLANDER	AWD Right
G57156	A		
F	09-17	VOLKSWAGEN CC	All
F	12-17	PASSAT	All
F	10	PASSAT	All
F	06-09	PASSAT 2.0T	
G57157	W		
F	02-03	INFINITI I35	All Left
F	02-03	NISSAN MAXIMA	All Left
G57158	W		
F	02-03	INFINITI I35	All Right
F	02-03	NISSAN MAXIMA	All Right
G57159	D		
R	00-01	INFINITI I30	All Left
R	02-04	I35	All Left
R	00-03	NISSAN MAXIMA	All Left
G57160	D		
R	00-01	INFINITI I30	All Right
R	02-04	I35	All Right
R	00-03	NISSAN MAXIMA	All Right
G57161	C		
F	13	NISSAN ALTIMA	Coupe Left
F	10-12	ALTIMA	SR Left
F	07-12	ALTIMA	Base Left
F	07-12	ALTIMA	S Left
F	07-12	ALTIMA	SL Left
F	08-09	ALTIMA	Coupe Left
F	07-09	ALTIMA	SE Left
G57162	C		
F	10-12	NISSAN ALTIMA	SR Right
F	07-12	ALTIMA	Base Right
F	07-12	ALTIMA	S Right
F	07-12	ALTIMA	SL Right
F	08-09	ALTIMA	Coupe Right
F	07-09	ALTIMA	SE Right
G57163	W		
F	03-07	NISSAN MURANO	All Left
G57164	W		
F	03-07	NISSAN MURANO	All Right
G57165	W		
F	00-01	INFINITI I30	All Left

Numerical listing

Shock	POP	Alternative No.	MTG Acc. Supplied
Pos.	Year	Application	
G57165	W	(cont)	
F	00-01	NISSAN MAXIMA	All Left
G57166	W		
F	00-01	INFINITI I30	All Right
F	00-01	NISSAN MAXIMA	All Right
G57167	W		
R	00-06	HYUNDAI ELANTRA	All Left
G57168	W		
R	00-06	HYUNDAI ELANTRA	All Right
G57172	W		
F	07-13	FORD EXPEDITION	All Exc. Air Suspension
F	10-13	LINCOLN NAVIGATOR	All Exc. Air Suspension
G57173	D		
R	17	FORD EXPEDITION	All Exc. Air Suspension
R	15-16	EXPEDITION 4WD Exc. Air Suspension	
R	15-16	EXPEDITION RWD Exc. Air Suspension	
R	07-14	EXPEDITION	All Exc. Air Suspension
R	17	LINCOLN NAVIGATOR	All Exc. Air Suspension
R	10-16	NAVIGATOR 4WD Exc. Air Suspension	
R	10-16	NAVIGATOR RWD Exc. Air Suspension	
G57176	B		
F	07-12	DODGE CALIBER	All Left
G57177	B		
F	07-12	DODGE CALIBER	All Right
G57178	D		
R	07-12	DODGE CALIBER	All
G57182	W		
F	03-06	PONTIAC VIBE	AWD Right
F	03-06	TOYOTA MATRIX	AWD Right
G57183	W		
F	03-06	PONTIAC VIBE	AWD Left
F	03-06	TOYOTA MATRIX	AWD Left
G57184	W		
F	04-09	NISSAN QUEST	All Left
G57185	W		
F	04-09	NISSAN QUEST	All Right
G57190	C		
F	07-12	LEXUS ES350	All Left
F	07-11	TOYOTA CAMRY	All Left
G57191	C		
F	07-12	LEXUS ES350	All Right
F	07-11	TOYOTA CAMRY	All Right
G57192	C		
R	07-11	TOYOTA AVALON	All Left
R	06	AVALON	All Left Mfg. from 1/06
R	07-11	CAMRY	All Left
G57193	C		
R	07-11	TOYOTA AVALON	All Right
R	06	AVALON	All Right Mfg. from 1/06
R	07-11	CAMRY	All Right
G57194	W		
F	06-10	CHRYSLER 300	RWD, 3.5L 6Cyl V (215), 3.78 96.0(Bore)3.19 81.0(Stroke) Left
F	06-10	DODGE CHARGER	RWD, 3.5L 6Cyl V (215), 3.78 96.0(Bore)3.19 81.0(Stroke) Left
F	05-08	MAGNUM	RWD, 3.5L 6Cyl V (215), 3.78 96.0(Bore)3.19 81.0(Stroke) Left
G57195	W		
F	06-10	CHRYSLER 300	RWD, 3.5L 6Cyl V (215), 3.78 96.0(Bore)3.19 81.0(Stroke) Right
F	06-10	DODGE CHARGER	RWD, 3.5L 6Cyl V (215), 3.78 96.0(Bore)3.19 81.0(Stroke) Right
F	05-08	MAGNUM	RWD, 3.5L 6Cyl V (215), 3.78 96.0(Bore)3.19 81.0(Stroke) Right

Numerical listing

Shock	POP	Alternative No.	MTG Acc. Supplied
Pos.	Year	Application	
G57197 B			
F	07-17	CHEVROLET EQUINOX	All Left Exc. Models w/ 19" Wheels
F	10-16	GMC TERRAIN	All Left Exc. Models w/ 19" Wheels
F	07-09	PONTIAC TORRENT	All Left Exc. Models w/ 19" Wheels
F	08-10	SATURN VUE	All Left Exc. Models w/ 19" Wheels
F	07-09	SUZUKI XL-7	All Left Exc. Models w/ 19" Wheels
G57198 B			
F	07-17	CHEVROLET EQUINOX	All Right Exc. Models w/ 19" Wheels
F	10-16	GMC TERRAIN	All Right Exc. Models w/ 19" Wheels
F	07-09	PONTIAC TORRENT	All Right Exc. Models w/ 19" Wheels
F	08-10	SATURN VUE	All Right Exc. Models w/ 19" Wheels
F	07-09	SUZUKI XL-7	All Right Exc. Models w/ 19" Wheels
G57200 A			
F	07-12	NISSAN SENTRA	All Left
G57201 A			
F	07-12	NISSAN SENTRA	All Right
G57202 W			
F	09-14	NISSAN CUBE	All Left
F	09-11	VERSA S	Left
F	09-11	VERSA SL	Left
F	07-08	VERSA	All Left
G57203 W			
F	09-14	NISSAN CUBE	All Right
F	09-11	VERSA S	Right
F	09-11	VERSA SL	Right
F	07-08	VERSA	All Right
G57204 B			
F	09-12	TOYOTA RAV4	All Left w/o 3rd Row Seat
F	06-08	RAV4	All Left
G57205 B			
F	09-12	TOYOTA RAV4	All Right w/o 3rd Row Seat
F	06-08	RAV4	All Right
G57206 A			
F	08-16	CHRYSLER TOWN & COUNTRY	All
F	08-20	DODGE CARAVAN / GRAND CARAVAN	All
F	12-15	RAM C/V	All
F	09-14	VOLKSWAGEN ROUTAN	All
G57207 W			
F	08-12	HONDA ACCORD	Automatic Left
G57208 W			
F	08-12	HONDA ACCORD	Automatic Right
G57212 W			
F	03-06	FORD EXPEDITION	RWD
G57218 C			
F	05-09	HYUNDAI TUCSON	All Left
F	05-10	KIA SPORTAGE	All Left
G57219 C			
F	05-09	HYUNDAI TUCSON	All Right
F	05-10	KIA SPORTAGE	All Right
G57220 D			
F	07-20	TOYOTA TUNDRA	4WD Left
G57221 D			
F	07-20	TOYOTA TUNDRA	4WD Right
G57222 A			
F	11	HONDA ELEMENT	All Left
F	07-10	ELEMENT EX	Left
F	07-10	ELEMENT LX	Left
F	03-06	ELEMENT	All Left
G57223 A			
F	11	HONDA ELEMENT	All Right
F	07-10	ELEMENT EX	Right
F	07-10	ELEMENT LX	Right
F	03-06	ELEMENT	All Right
G57266 A			
F	20	DODGE JOURNEY	All Left
F	18-19	JOURNEY Sport	FWD Left

Ultra ReadyMount

Shock	POP	Alternative No.	MTG Acc. Supplied
Pos.	Year	Application	
G57266 A (cont)			
F	14-19	JOURNEY	Canada Value Package, FWD Left
F	14-19	JOURNEY	Crossroad, FWD Left
F	14-19	JOURNEY	SE Plus, FWD Left
F	14-19	JOURNEY	SE, FWD Left
F	14-19	JOURNEY	SXT, FWD Left
F	19	JOURNEY	SE Blacktop, FWD Left
F	19	JOURNEY	Sport Plus, FWD Left
F	17-18	JOURNEY	SXT Lujo, FWD Left
F	17	JOURNEY	SXT Sport, FWD Left
F	14-15	JOURNEY	Limited, FWD Left
F	15	JOURNEY	AVP, FWD Left
F	14	JOURNEY	Base, FWD Left
F	09-13	JOURNEY	All Left
G57267 A			
F	20	DODGE JOURNEY	All Right
F	18-19	JOURNEY Sport	FWD Right
F	14-19	JOURNEY	Canada Value Package, FWD Right
F	14-19	JOURNEY	Crossroad, FWD Right
F	14-19	JOURNEY	SE Plus, FWD Right
F	14-19	JOURNEY	SE, FWD Right
F	14-19	JOURNEY	SXT, FWD Right
F	19	JOURNEY	SE Blacktop, FWD Right
F	19	JOURNEY	Sport Plus, FWD Right
F	17-18	JOURNEY	SXT Lujo, FWD Right
F	17	JOURNEY	SXT Sport, FWD Right
F	14-15	JOURNEY	Limited, FWD Right
F	15	JOURNEY	AVP, FWD Right
F	14	JOURNEY	Base, FWD Right
F	09-13	JOURNEY	All Right
G57268 W			
F	00-05	HYUNDAI ACCENT	All Left
G57269 W			
F	00-05	HYUNDAI ACCENT	All Right
G57270 W			
F	03-08	MAZDA 6	All
G57271 C			
F	05-10	FORD MUSTANG / MUSTANG II	All
G57274 W			
F	02-07	BUICK RENDEZVOUS	All
F	01-05	PONTIAC AZTEK	All
G57275 W			
F	06-11	HYUNDAI ACCENT	All Left
F	06-11	KIA RIO	All Left
G57276 W			
F	06-11	HYUNDAI ACCENT	All Right
F	06-11	KIA RIO	All Right
G57277 W			
F	06-13	AUDI A3	All
F	04-13	A3 QUATTRO	All
F	12-13	VOLKSWAGEN BEETLE	All
F	07-11	EOS	All
F	10-12	GOLF	All
F	06-10	JETTA	GLI
G57278 W			
R	00-05	HYUNDAI ACCENT	All Left
G57279 W			
R	00-05	HYUNDAI ACCENT	All Right
G57282 W			
F	04-12	CHEVROLET COLORADO	All
F	04-11	GMC CANYON	All
G57311 D			
F	06-07	SATURN VUE	3.5L 6Cyl V (3471), 3.50 89.0(Bore)3.66 93.0(Stroke) Left
F	04-05	VUE	3.5L 6Cyl V (3474), 3.54 90.0(Bore)3.58 91.0(Stroke) Left
F	04	VUE	3.5L 6Cyl V (3475), 3.50 89.0(Bore)3.66 93.0(Stroke) Left
F	02-03	VUE	3.0L 6Cyl V (181), 3.39 86.0(Bore)3.35 85.0(Stroke) Left
G57312 D			
F	06-07	SATURN VUE	3.5L 6Cyl V (3471), 3.50 89.0(Bore)3.66 93.0(Stroke) Right
F	04-05	VUE	3.5L 6Cyl V (3474), 3.54 90.0(Bore)3.58 91.0(Stroke) Right
F	04	VUE	3.5L 6Cyl V (3475), 3.50 89.0(Bore)3.66 93.0(Stroke) Right
F	02-03	VUE	3.0L 6Cyl V (181), 3.39 86.0(Bore)3.35 85.0(Stroke) Right

Numerical listing

Shock	POP	Alternative No.	MTG Acc. Supplied
Pos.	Year	Application	
G57314 B			
F	08-11	BUICK ENCLAVE	FWD
F	09-11	CHEVROLET TRAVERSE	FWD
F	07-11	GMC ACADIA	FWD
F	07-10	SATURN OUTLOOK	FWD
G57322 C			
F	07-12	CHEVROLET EQUINOX	All Left Models w/ 19" Wheels
F	10-12	GMC TERRAIN	All Left Models w/ 19" Wheels
F	07-09	PONTIAC TORRENT	All Left Models w/ 19" Wheels
F	08-10	SATURN VUE	All Left Models w/ 19" Wheels
F	07-09	SUZUKI XL-7	All Left Models w/ 19" Wheels
G57323 C			
F	07-12	CHEVROLET EQUINOX	All Right Models w/ 19" Wheels
F	10-12	GMC TERRAIN	All Right Models w/ 19" Wheels
F	07-09	PONTIAC TORRENT	All Right Models w/ 19" Wheels
F	08-10	SATURN VUE	All Right Models w/ 19" Wheels
F	07-09	SUZUKI XL-7	All Right Models w/ 19" Wheels
G57324 C			
F	06-11	BUICK LUCERNE	All
F	06-11	CADILLAC DTS	All Exc. Magnetic Ride Control Suspension
G57329 C			
F	09-10	PONTIAC VIBE	AWD Left
F	09-12	TOYOTA COROLLA	All Left
F	09-13	MATRIX	AWD Left
G57330 C			
F	09-10	PONTIAC VIBE	AWD Right
F	09-12	TOYOTA COROLLA	All Right
F	09-13	MATRIX	AWD Right
G57331 A			
F	07-11	HONDA CR-V	All Left
G57332 A			
F	07-11	HONDA CR-V	All Right
G57333 C			
F	06-14	HONDA RIDGELINE	All Left
G57334 C			
F	06-14	HONDA RIDGELINE	All Right
G57335 C			
F	99-05	VOLVO S80	All Left
G57336 C			
F	99-05	VOLVO S80	All Right
G57337 W			
F	07-15	VOLVO S80	All Left
F	06	S80	All Left Mfg. from 3/06
G57338 W			
F	07-15	VOLVO S80	All Right
F	06	S80	All Right Mfg. from 3/06
G57339 D			
F	05-09	SUBARU OUTBACK	All Left
G57340 D			
F	05-09	SUBARU OUTBACK	All Right
G57341 W			
F	00-04	SUBARU OUTBACK	All Left
G57342 W			
F	00-04	SUBARU OUTBACK	All Right
G57343 W			
R	05-09	HYUNDAI TUCSON	All Left
R	05-10	KIA SPORTAGE	All Left
G57344 W			
R	05-09	HYUNDAI TUCSON	All Right
R	05-10	KIA SPORTAGE	All Right
G57345 W			
F	05-09	SUBARU LEGACY	All Left
G57346 W			
F	05-09	SUBARU LEGACY	All Right

Numerical listing

Shock	POP	Alternative No.	MTG Acc. Supplied
Pos.	Year	Application	
G57349	D		
F	01-05	TOYOTA RAV4	FWD Left
G57350	D		
F	01-05	TOYOTA RAV4	FWD Right
G57353	W		
F	07-11	TOYOTA YARIS	All Left
G57354	W		
F	07-11	TOYOTA YARIS	All Right
G57357	D		
F	03-08	PONTIAC VIBE	FWD Left
F	03-08	TOYOTA MATRIX	FWD Left
G57358	D		
F	03-08	PONTIAC VIBE	FWD Right
F	03-08	TOYOTA MATRIX	FWD Right
G57359	B		
F	08-09	FORD TAURUS X	All Left
G57360	B		
F	08-09	FORD TAURUS X	All Right
G57361	W		
F	07-12	MAZDA CX-7	All Left
G57362	W		
F	07-12	MAZDA CX-7	All Right
G57363	C		
F	08-13	BMW 128i	All Left Exc. Sport Suspension
F	08-13	135i	All Left Exc. Sport Suspension
F	06	325i	All Left Exc. Sport Suspension
F	07-13	328i	All Left Exc. Sport Suspension
F	06	330i	All Left Exc. Sport Suspension
F	07-13	335i	All Left Exc. Sport Suspension
G57364	C		
F	08-13	BMW 128i	All Right Exc. Sport Suspension
F	08-13	135i	All Right Exc. Sport Suspension
F	06	325i	All Right Exc. Sport Suspension
F	07-13	328i	All Right Exc. Sport Suspension
F	06	330i	All Right Exc. Sport Suspension
F	07-13	335i	All Right Exc. Sport Suspension
G57365	W		
F	00-02	SUBARU LEGACY	All Left
G57366	W		
F	00-02	SUBARU LEGACY	All Right
G57367	W		
F	07-11	NISSAN ALTIMA	Hybrid Left
G57368	W		
F	07-11	NISSAN ALTIMA	Hybrid Right
G57369	D		
F	05-10	SCION TC	All Left
G57370	D		
F	05-10	SCION TC	All Right
G57372	W		
F	05-06	TOYOTA SIENNA	FWD Left Mfg to 6/05 w/ 7 Passenger Seating
F	04	SIENNA	FWD Left w/ 7 Passenger Seating
G57373	W		
F	05-06	TOYOTA SIENNA	FWD Right Mfg to 6/05 w/ 7 Passenger Seating
F	04	SIENNA	FWD Right w/ 7 Passenger Seating
G57375	W		
F	07-10	TOYOTA SIENNA	AWD Left w/ 8 Passenger Seating
G57376	W		
F	07-10	TOYOTA SIENNA	AWD Right w/ 8 Passenger Seating
G57377	D		
F	12-17	BUICK VERANO	All Left
F	11-15	CHEVROLET CRUZE	All Left
F	16	CRUZE LIMITED	All Left Exc. 3 Stud Mounts

Ultra ReadyMount

Shock	POP	Alternative No.	MTG Acc. Supplied
Pos.	Year	Application	
G57378	D		
F	12-17	BUICK VERANO	All Right
F	11-15	CHEVROLET CRUZE	All Right
F	16	CRUZE LIMITED	All Right Exc. 3 Stud Mounts
G57390	D		
F	06-11	ACURA CSX	All Left
F	09-11	HONDA CIVIC	Hybrid-L Left
F	09-11	CIVIC	LX-S Left
F	08-11	CIVIC	DX-G Left
F	08-11	CIVIC	EX-L Left
F	06-11	CIVIC	DX Left
F	06-11	CIVIC	EX Left
F	06-11	CIVIC	Hybrid Left
F	06-11	CIVIC	LX Left
F	11	CIVIC	Base Left
F	09-10	CIVIC	Sport Left
F	08	CIVIC	MUGEN Si Left
F	06-07	CIVIC	EXS Left
F	06-07	CIVIC	LXS Left
G57391	D		
F	06-11	ACURA CSX	All Right
F	09-11	HONDA CIVIC	Hybrid-L Right
F	09-11	CIVIC	LX-S Right
F	08-11	CIVIC	DX-G Right
F	08-11	CIVIC	EX-L Right
F	06-11	CIVIC	DX Right
F	06-11	CIVIC	EX Right
F	06-11	CIVIC	Hybrid Right
F	06-11	CIVIC	LX Right
F	11	CIVIC	Base Right
F	09-10	CIVIC	Sport Right
F	08	CIVIC	MUGEN Si Right
F	06-07	CIVIC	EXS Right
F	06-07	CIVIC	LXS Right
G57392	W		
F	97-98	VOLKSWAGEN JETTA	1.9L 4Cyl L (116), 3.13 79.5(Bore)3.76 95.5(Stroke)
G57393	W		
F	07-10	HYUNDAI ELANTRA	All Left
G57394	W		
F	07-10	HYUNDAI ELANTRA	All Right
G57397	D		
F	00-05	TOYOTA ECHO	All
G57398	W		
F	03-08	HYUNDAI TIBURON	All Left
G57399	W		
F	03-08	HYUNDAI TIBURON	All Right
G57400	D		
R	03-08	HYUNDAI TIBURON	All Left
G57401	D		
R	03-08	HYUNDAI TIBURON	All Right
G57404	C		
F	04-09	TOYOTA PRIUS	All Left
G57405	C		
F	04-09	TOYOTA PRIUS	All Right
G57409	W		
F	05-09	DODGE DAKOTA RWD	
F	06-09	MITSUBISHI RAIDER	RWD
G57413	W		
F	05-15	NISSAN XTERRA	4WD
F	09-12	SUZUKI EQUATOR	All
G57414	D		
R	06-14	HONDA RIDGELINE	All Left
G57415	D		
R	06-14	HONDA RIDGELINE	All Right
G57416	A		
R	07-11	HONDA CR-V	All Left
G57417	D		
F	08-12	HONDA ACCORD	Manual Left
G57418	D		
F	08-12	HONDA ACCORD	Manual Right
G57419	W		
R	08-12	HONDA ACCORD	All
G57420	W		
R	95-00	LEXUS LS400	All

Numerical listing

Shock	POP	Alternative No.	MTG Acc. Supplied
Pos.	Year	Application	
G57421	D		
F	96-00	LEXUS LS400	All Exc. Rough Road Package
F	90-95	LEXUS LS400	All
G57422	W		
R	95-98	CHRYSLER CIRRUS	All Convertible
R	01-06	SEBRING	Convertible
R	95-98	DODGE STRATUS	All Convertible
R	96-98	PLYMOUTH BREEZE	All Convertible
G57423	W		
R	05-09	SUBARU LEGACY	All
G57424	B		
R	11	HONDA ELEMENT	All Left
R	07-10	ELEMENT	EX Left
R	07-10	ELEMENT	LX Left
R	03-06	ELEMENT	All Left
G57425	B		
R	11	HONDA ELEMENT	All Right
R	07-10	ELEMENT	EX Right
R	07-10	ELEMENT	LX Right
R	03-06	ELEMENT	All Right
G57427	C		
F	10-12	FORD FUSION	All
F	10-12	LINCOLN MKZ	All
F	10-11	MERCURY MILAN	All
G57428	C		
R	05-10	SCION TC	All Left
G57429	C		
R	05-10	SCION TC	All Right
G57430	W		
R	00-02	SUBARU LEGACY	All
G57431	W		
F	99-00	CHRYSLER CIRRUS	2.4L 4Cyl L (148), 3.44 87.5(Bore)3.98 101.0(Stroke) Left
F	99-00	DODGE STRATUS	2.4L 4Cyl L (148), 3.44 87.5(Bore)3.98 101.0(Stroke) Left
F	99-00	PLYMOUTH BREEZE	All Left
G57432	W		
F	99-00	CHRYSLER CIRRUS	2.4L 4Cyl L (148), 3.44 87.5(Bore)3.98 101.0(Stroke) Right
F	99-00	DODGE STRATUS	2.4L 4Cyl L (148), 3.44 87.5(Bore)3.98 101.0(Stroke) Right
F	99-00	PLYMOUTH BREEZE	All Right
G57437	W		
R	95-98	CHRYSLER CIRRUS	All
R	95-98	DODGE STRATUS	All
R	96-98	PLYMOUTH BREEZE	All
G57441	D		
R	02-06	ACURA RSX	All Right
G57442	D		
R	02-06	ACURA RSX	All Left
G57444	N		
R	01-03	TOYOTA PRIUS	All
G57447	D		
R	11-14	CHRYSLER 200	Sedan
R	08-10	SEBRING	Sedan
R	08-14	DODGE AVENGER	All
G57449	C		
R	08-09	FORD TAURUS	FWD Left
R	08-09	MERCURY SABLE	FWD Left
G57450	C		
R	08-09	FORD TAURUS	FWD Right
R	08-09	MERCURY SABLE	FWD Right
G57451	W		
R	09-10	TOYOTA COROLLA	XRS Left
R	09-13	MATRIX	FWD Left
G57452	W		
R	09-10	TOYOTA COROLLA	XRS Right
R	09-13	MATRIX	FWD Right
G57453	W		
F	08-15	TOYOTA SEQUOIA	All Right

Numerical listing

Shock	POP	Alternative No.	MTG Acc. Supplied
Pos.	Year	Application	
G57454	W		
F	08-15	TOYOTA SEQUOIA All Left	
G57455	W		
F	09-13	MAZDA 6 All Left	
G57456	W		
F	09-13	MAZDA 6 All Right	
G57457	W		
F	03-09	KIA SORENTO All Left	
G57458	W		
F	03-09	KIA SORENTO All Right	
G57459	W		
F	04-05	SUBARU FORESTER All Left	
G57460	W		
F	04-05	SUBARU FORESTER All Right	
G57463	C		
F	07-10	JEEP COMPASS All Right	
F	07-10	PATRIOT All Right	
G57464	C		
F	07-10	JEEP COMPASS All Left	
F	07-10	PATRIOT All Left	
G57465	C		
F	11-14	CHRYSLER 200 Sedan Left	
F	08-10	SEBRING Sedan Left	
F	08-14	DODGE AVENGER All Left	
G57466	C		
F	11-14	CHRYSLER 200 Sedan Right	
F	08-10	SEBRING Sedan Right	
F	08-14	DODGE AVENGER All Right	
G57471	W		
F	07-09	HYUNDAI SANTA FE All Left	
G57472	W		
F	07-09	HYUNDAI SANTA FE All Right	
G57473	D		
F	08-10	NISSAN ROGUE All Left	
G57474	D		
F	08-10	NISSAN ROGUE All Right	
G57477	W		
F	06-08	SUBARU FORESTER Manual Left	
G57478	W		
F	06-08	SUBARU FORESTER Manual Right	
G57479	D		
F	12-16	HONDA CR-V FWD Left	
G57480	D		
F	12-16	HONDA CR-V FWD Right	
G57481	W		
F	09-10	TOYOTA HIGHLANDER AWD, 2.7L 4Cyl L (163), 3.54 90.0(Bore)4.13 105.0(Stroke) Left	
F	08-10	HIGHLANDER 3.3L 6Cyl V (202), 3.62 91.95(Bore)3.27 83.06(Stroke) Left	
G57482	W		
F	09-10	TOYOTA HIGHLANDER AWD, 2.7L 4Cyl L (163), 3.54 90.0(Bore)4.13 105.0(Stroke) Right	
F	08-10	HIGHLANDER 3.3L 6Cyl V (202), 3.62 91.95(Bore)3.27 83.06(Stroke) Right	
G57483	W		
R	08-10	TOYOTA HIGHLANDER FWD Left	
R	09-14	VENZA FWD Left	
G57484	W		
R	08-10	TOYOTA HIGHLANDER FWD Right	
R	09-14	VENZA FWD Right	
G57487	C		
F	07-08	HYUNDAI ENTOURAGE All Left	
F	14	KIA SEDONA All Left	
F	06-12	SEDONA All Left	
G57488	C		
F	07-08	HYUNDAI ENTOURAGE All Right	
F	14	KIA SEDONA All Right	
F	06-12	SEDONA All Right	
G57489	W		
F	02-05	KIA SEDONA All Left	

Ultra ReadyMount

Shock	POP	Alternative No.	MTG Acc. Supplied
Pos.	Year	Application	
G57490	W		
F	02-05	KIA SEDONA All Right	
G57493	C		
F	09-15	NISSAN MAXIMA All Left	
G57494	C		
F	09-15	NISSAN MAXIMA All Right	
G57495	C		
F	10-11	FORD FLEX All Left	
F	09	FLEX All Left Mfg from 7/09	
G57496	C		
F	10-11	FORD FLEX All Right	
F	09	FLEX All Right Mfg from 7/09	
G57497	W		
F	10-12	FORD TAURUS All Left	
F	09	TAURUS FWD Left	
G57498	W		
F	10-12	FORD TAURUS All Right	
F	09	TAURUS FWD Right	
G57499	W		
R	14-17	TOYOTA CAMRY SE Left	
R	12-13	CAMRY All Left	
G57500	W		
R	14-17	TOYOTA CAMRY SE Right	
R	12-13	CAMRY All Right	
G57509	W		
R	02-03	MAZDA PROT G / PROT G5 All Left	
G57510	W		
R	02-03	MAZDA PROT G / PROT G5 All Right	
G57515	W		
F	03-04	SUBARU LEGACY All Left	
G57516	W		
F	03-04	SUBARU LEGACY All Right	
G57517	C		
F	13-16	FORD ESCAPE All Left	
G57518	C		
F	13-16	FORD ESCAPE All Right	
G57521	W		
F	01-03	ACURA EL All Left	
F	03-05	HONDA CIVIC Hybrid Left	
G57522	W		
F	01-03	ACURA EL All Right	
F	03-05	HONDA CIVIC Hybrid Right	
G57523	C		
F	02-04	ACURA RSX All Left	
G57524	C		
F	02-04	ACURA RSX All Right	
G57533	N		
R	04-06	LEXUS RX330 FWD Left	
R	07-09	RX350 FWD Left	
R	04-07	TOYOTA HIGHLANDER FWD Left	
G57534	N		
R	04-06	LEXUS RX330 FWD Right	
R	07-09	RX350 FWD Right	
R	04-07	TOYOTA HIGHLANDER FWD Right	
G57535	W		
F	06	PONTIAC TORRENT All Left	
G57536	W		
F	06	PONTIAC TORRENT All Right	
G57539	W		
F	07-12	TOYOTA AVALON All Left	
F	06	AVALON All Left Mfg. from 1/06	
G57540	W		
F	07-12	TOYOTA AVALON All Right	
F	06	AVALON All Right Mfg. from 1/06	
G57541	A		
F	06-08	HONDA FIT All Left	
G57542	A		
F	06-08	HONDA FIT All Right	
G57543	D		
F	14-17	TOYOTA COROLLA All Left	

Numerical listing

Shock	POP	Alternative No.	MTG Acc. Supplied
Pos.	Year	Application	
G57544	D		
F	14-17	TOYOTA COROLLA All Right	
G57545	C		
F	14-16	NISSAN ALTIMA All Left	
G57546	C		
F	14-16	NISSAN ALTIMA All Right	
G57549	W		
F	12-15	CHEVROLET CAPTIVA SPORT All Left	
G57550	W		
F	12-15	CHEVROLET CAPTIVA SPORT All Right	
G57557	W		
F	95-98	HONDA ODYSSEY All	
F	96-99	ISUZU OASIS All	
G57558	W		
F	00-01	NISSAN ALTIMA All Left	
G57559	W		
F	00-01	NISSAN ALTIMA All Right	
G57560	B		
F	07-13	ACURA MDX All Left Exc. Active Suspension	
G57561	B		
F	07-13	ACURA MDX All Right Exc. Active Suspension	
G57562	D		
F	10-14	LEXUS RX350 All Left	
G57563	D		
F	10-14	LEXUS RX350 All Right	
G57564	B		
F	08-10	HONDA ODYSSEY All Left	
G57565	B		
F	08-10	HONDA ODYSSEY All Right	
G57566	W		
F	09-10	PONTIAC VIBE FWD Left	
F	09-13	TOYOTA MATRIX FWD Left	
G57567	W		
F	09-10	PONTIAC VIBE FWD Right	
F	09-13	TOYOTA MATRIX FWD Right	
G57568	W		
R	04-09	TOYOTA PRIUS All Left	
G57569	W		
R	04-09	TOYOTA PRIUS All Right	
G57572	W		
R	09-10	TOYOTA COROLLA XRS Left AWD	
R	09-13	MATRIX S, AWD Left	
G57573	W		
R	09-10	TOYOTA COROLLA XRS Right AWD	
R	09-13	MATRIX S, AWD Right	
G57574	D		
F	07-12	ACURA RDX All Left	
G57575	D		
F	07-12	ACURA RDX All Right	
G57576	W		
R	02-03	ACURA TL Type-S	
R	99-01	TL All Type-S Sub Model	
G57577	D		
F	11-14	CHRYSLER 200 Convertible Left	
F	08-10	SEBRING Convertible Left	
G57578	D		
F	11-14	CHRYSLER 200 Convertible Right	
F	08-10	SEBRING Convertible Right	
G57579	W		
R	11-14	CHRYSLER 200 Convertible	
R	08-10	SEBRING Convertible	
G57582	A		
F	07-14	FORD EDGE FWD Left	
F	11-14	LINCOLN MKX FWD Left	
G57583	A		
F	07-14	FORD EDGE FWD Right	
F	11-14	LINCOLN MKX FWD Right	

Numerical listing

Shock	POP	Alternative No.	MTG Acc. Supplied
Pos.	Year	Application	
G57586	W		
R	06	LEXUS RX400H FWD Left	
G57587	W		
R	06	LEXUS RX400H FWD Right	
G57594	W		
F	09-13	MAZDA 6 i Left	
G57595	W		
F	09-13	MAZDA 6 i Right	
G57597	W		
R	12-16	HONDA CR-V FWD Left	
G57598	W		
R	12-16	HONDA CR-V FWD Right	
G57599	W		
R	12-14	HONDA CR-V AWD Left	
G57600	W		
R	12-14	HONDA CR-V AWD Right	
G57601	W		
F	12-14	HONDA CR-V AWD Left	
G57602	W		
F	12-14	HONDA CR-V AWD Right	
G57603	C		
F	09-13	HONDA FIT All Left	
F	10-14	INSIGHT All Left	
G57604	C		
F	09-13	HONDA FIT All Right	
F	10-14	INSIGHT All Right	
G57605	W		
F	06-08	HONDA PILOT FWD Left	
G57606	W		
F	06-08	HONDA PILOT FWD Right	
G57607	W		
R	07-10	JEEP COMPASS All	
R	07-10	PATRIOT All	
G57608	W		
F	03-05	KIA RIO All Left 3 Stud Top Mount from 07/01/2002	
G57609	W		
F	03-05	KIA RIO All Right 3 Stud Top Mount from 07/01/2002	
G57612	W		
R	99-03	LEXUS RX300 FWD Left	
G57613	W		
R	99-03	LEXUS RX300 FWD Right	
G57614	W		
F	99-03	LEXUS RX300 AWD Left	
G57615	W		
F	99-03	LEXUS RX300 AWD Right	
G57628	D		
F	09-10	SUBARU FORESTER AWD Left	
G57629	D		
F	09-10	SUBARU FORESTER AWD Right	
G57634	W		
R	02-03	SUBARU IMPREZA RS Left	
G57635	W		
R	02-03	SUBARU IMPREZA RS Right	
G57640	W		
F	04-07	SUBARU IMPREZA All Left Exc. Sti	
G57641	W		
F	04-07	SUBARU IMPREZA All Right Exc. Sti	
G57642	W		
R	04-07	SUBARU IMPREZA All Left Exc. Sti	
G57643	W		
R	04-07	SUBARU IMPREZA All Right Exc. Sti	
G57644	D		
F	08-11	SUBARU IMPREZA All Left	
G57645	D		
F	08-11	SUBARU IMPREZA All Right	

Ultra ReadyMount

Shock	POP	Alternative No.	MTG Acc. Supplied
Pos.	Year	Application	
G57646	W		
F	05-21	NISSAN FRONTIER RWD	
G57647	W		
F	05-21	NISSAN FRONTIER 4WD	
G57648	W		
F	01-03	TOYOTA HIGHLANDER AWD Left	
G57649	W		
F	01-03	TOYOTA HIGHLANDER AWD Right	
G57650	D		
R	99-03	LEXUS RX300 AWD Left	
R	01-03	TOYOTA HIGHLANDER AWD Left	
G57651	D		
R	99-03	LEXUS RX300 AWD Right	
R	01-03	TOYOTA HIGHLANDER AWD Right	
G57658	D		
R	11-13	TOYOTA HIGHLANDER AWD Left	
R	08-10	HIGHLANDER AWD Left w/o 3rd Row Seat	
R	09-14	VENZA AWD Left	
G57659	D		
R	11-13	TOYOTA HIGHLANDER AWD Right	
R	08-10	HIGHLANDER AWD Right w/o 3rd Row Seat	
R	09-14	VENZA AWD Right	
G57663	D		
F	07-10	TOYOTA SIENNA FWD Left w/ 7 Passenger Seating	
F	05-06	SIENNA FWD Left Mfg from 7/05 w/ 7 Passenger Seating	
G57664	D		
F	07-10	TOYOTA SIENNA FWD Right w/ 7 Passenger Seating	
F	05-06	SIENNA FWD Right Mfg from 7/05 w/ 7 Passenger Seating	
G57665	W		
F	07-10	TOYOTA SIENNA FWD Left w/ 8 Passenger Seating	
G57666	W		
F	07-10	TOYOTA SIENNA FWD Right w/ 8 Passenger Seating	
G57673	W		
F	10-12	SUBARU LEGACY 2.5i Left	
F	10-12	LEGACY 2.5i Limited Left	
F	10-12	LEGACY 2.5i Premium Left	
F	10-12	LEGACY 3.6R Left	
F	10-12	LEGACY 3.6R Limited Left	
F	10-12	LEGACY 3.6R Premium Left	
F	10-12	LEGACY Base Left	
F	10-12	LEGACY Sport Left	
F	12	LEGACY 2.5i Touring Left	
G57674	W		
F	10-12	SUBARU LEGACY 2.5i Limited Right	
F	10-12	LEGACY 2.5i Premium Right	
F	10-12	LEGACY 2.5i Right	
F	10-12	LEGACY 3.6R Limited Right	
F	10-12	LEGACY 3.6R Premium Right	
F	10-12	LEGACY 3.6R Right	
F	10-12	LEGACY Base Right	
F	10-12	LEGACY Sport Right	
F	12	LEGACY 2.5i Touring Right	
G57675	W		
R	10-12	SUBARU LEGACY 2.5i	
R	10-12	LEGACY 2.5i Limited	
R	10-12	LEGACY 2.5i Premium	
R	10-12	LEGACY 3.6R	
R	10-12	LEGACY 3.6R Limited	
R	10-12	LEGACY 3.6R Premium	
R	10-12	LEGACY Base	
R	10-12	LEGACY Sport	
R	12	LEGACY 2.5i Touring	
G57676	D		
F	09-14	TOYOTA VENZA All Left	
G57677	D		
F	09-14	TOYOTA VENZA All Right	
G57680	W		
F	10-14	VOLKSWAGEN GTI All	

Numerical listing

Shock	POP	Alternative No.	MTG Acc. Supplied
Pos.	Year	Application	
G57682	A		
R	07-11	HONDA CR-V All Right	
G57683	N		
F	14-21	FORD EXPEDITION 4WD	
F	14-22	LOBO 4WD	
F	22-23	PICKUP 1/2 TON, F-150 King Ranch, 4WD	
F	22-23	PICKUP 1/2 TON, F-150 Lariat, 4WD	
F	22-23	PICKUP 1/2 TON, F-150 Limited, 4WD	
F	22-23	PICKUP 1/2 TON, F-150 Platinum, 4WD	
F	22-23	PICKUP 1/2 TON, F-150 Police Responder, 4WD	
F	22-23	PICKUP 1/2 TON, F-150 Raptor, 4WD	
F	22-23	PICKUP 1/2 TON, F-150 SSV, 4WD	
F	22-23	PICKUP 1/2 TON, F-150 XL, 4WD	
F	22-23	PICKUP 1/2 TON, F-150 XLT, 4WD	
F	23	PICKUP 1/2 TON, F-150 Raptor R, 4WD	
F	14-21	PICKUP 1/2 TON, F-150 4WD	
F	14-20	LINCOLN NAVIGATOR All Exc. Adaptive Suspension	
G57689	C		
F	11-13	KIA SORENTO AWD Left	
G57690	C		
F	11-13	KIA SORENTO AWD Right	
G57691	W		
F	11-13	FORD EXPLORER AWD Left Mfg. to 9/4/12	
G57692	W		
F	11-13	FORD EXPLORER AWD Right Mfg. to 9/4/12	
G57693	W		
F	13	FORD EXPLORER FWD Left Mfg. to 9/4/12	
F	11-12	EXPLORER FWD Left	
G57694	W		
F	13	FORD EXPLORER FWD Right Mfg. to 9/4/12	
F	11-12	EXPLORER FWD Right	
G57695	B		
F	10-15	HONDA PILOT All Left	
G57696	B		
F	10-15	HONDA PILOT All Right	
G57697	D		
F	13-15	FORD EXPLORER AWD Left	
G57698	D		
F	13-15	FORD EXPLORER AWD Right	
G57699	W		
F	13-15	FORD EXPLORER FWD Left	
G57700	W		
F	13-15	FORD EXPLORER FWD Right	
G57701	W		
F	08-14	SUBARU IMPREZA Sport Left	
G57702	W		
F	08-14	SUBARU IMPREZA Sport Right	
G57703	C		
R	08-14	SUBARU IMPREZA All	
G57704	W		
F	11-13	SUBARU FORESTER All Left	
G57705	W		
F	11-13	SUBARU FORESTER All Right	
G57706	D		
R	09-13	SUBARU FORESTER All	
G57709	C		
F	13-17	BUICK ENCLAVE All	
F	13-17	CHEVROLET TRAVERSE All	
F	13-17	GMC ACADIA All	
G57710	W		
F	12-15	HONDA CIVIC Coupe Left	
G57711	W		
F	12-15	HONDA CIVIC Coupe Right	

Numerical listing

Shock	POP	Alternative No.	MTG Acc. Supplied
Pos.	Year	Application	
G57712	W		
F	12-15	HONDA CIVIC Sedan, 1.8L 4Cyl L (1799), 3.19 81.0(Bore)3.44 87.3(Stroke) Left w/ 14mm Lower Mounting Holes	
G57713	W		
F	12-15	HONDA CIVIC Sedan, 1.8L 4Cyl L (1799), 3.19 81.0(Bore)3.44 87.3(Stroke) Right w/ 14mm Lower Mounting Holes	
G57714	D		
F	10-15	MAZDA CX-9 All Left	
G57715	D		
F	10-15	MAZDA CX-9 All Right	
G57716	C		
F	14-20	CHEVROLET IMPALA All Left	
G57717	C		
F	14-20	CHEVROLET IMPALA All Right	
G57720	N		
F	11-13	TOYOTA HIGHLANDER FWD Left	
G57721	N		
F	11-13	TOYOTA HIGHLANDER FWD Right	
G57722	D		
F	08-15	SCION XB All Left	
G57723	D		
F	08-15	SCION XB All Right	
G57724	C		
F	12-18	FORD FOCUS All Left Standard Suspension	
G57725	C		
F	12-18	FORD FOCUS All Right Standard Suspension	
G57726	C		
F	12-18	FORD FOCUS All Left Heavy Duty Suspension	
G57727	C		
F	12-18	FORD FOCUS All Right Heavy Duty Suspension	
G57730	N		
F	14	TOYOTA SIENNA All Left 2.7L 4Cyl	
F	11-13	SIENNA 2.7L 4Cyl L (163) Left	
G57731	N		
F	14	TOYOTA SIENNA All Right 2.7L 4Cyl	
F	11-13	SIENNA 2.7L 4Cyl L (163) Right	
G57732	W		
F	11-14	TOYOTA SIENNA FWD, 3.5L 6Cyl V (3456), 3.70 94.0(Bore)3.27 83.0(Stroke) Left	
G57733	W		
F	11-14	TOYOTA SIENNA FWD, 3.5L 6Cyl V (3456), 3.70 94.0(Bore)3.27 83.0(Stroke) Right	
G57734	N		
F	11-14	TOYOTA SIENNA AWD, 3.5L 6Cyl V (3456), 3.70 94.0(Bore)3.27 83.0(Stroke) Left	
G57735	N		
F	11-14	TOYOTA SIENNA AWD, 3.5L 6Cyl V (3456), 3.70 94.0(Bore)3.27 83.0(Stroke) Right	
G57738	N		
F	10-15	TOYOTA PRIUS All Left	
G57739	N		
F	10-15	TOYOTA PRIUS All Right	
G57740	W		
F	14-17	HYUNDAI ELANTRA GT All Left Models w/ 16" or 17" Wheels; Mfg to 10/16	
G57741	W		
F	14-17	HYUNDAI ELANTRA GT All Right Models w/ 16" or 17" Wheels; Mfg to 10/16	

Ultra ReadyMount

Shock	POP	Alternative No.	MTG Acc. Supplied
Pos.	Year	Application	
G57742	D		
F	14-16	HYUNDAI ELANTRA Limited Left Mfg. to 10/16	
F	14-16	ELANTRA SE Left Mfg. to 10/16	
F	13	ELANTRA GLS Left	
F	13	ELANTRA Limited Left	
G57743	D		
F	14-16	HYUNDAI ELANTRA Limited Right Mfg. to 10/16	
F	14-16	ELANTRA SE Right Mfg. to 10/16	
F	13	ELANTRA GLS Right	
F	13	ELANTRA Limited Right	
G57744	N		
F	13-19	FORD POLICE INTERCEPTOR SEDAN All Left	
F	13-19	TAURUS All Left Police Interceptor	
G57745	N		
F	13-19	FORD POLICE INTERCEPTOR SEDAN All Right	
F	13-19	TAURUS All Right Police Interceptor	
G57746	W		
F	13-19	FORD TAURUS All Left	
G57747	W		
F	13-19	FORD TAURUS All Right	
G57748	N		
F	21-22	CHEVROLET COLORADO LT	
F	21-22	COLORADO WT	
F	21-22	COLORADO Z71	
F	21-22	COLORADO Z71 LT	
F	15-20	COLORADO All Exc. ZR2	
F	23	GMC CANYON All Exc. ZR2	
F	15-20	CANYON All Exc. ZR2	
G57749	C		
F	11-15	DODGE DURANGO All Left	
G57750	D		
F	20	DODGE JOURNEY All Left AWD	
F	11-19	JOURNEY AWD Left	
G57751	D		
F	20	DODGE JOURNEY All Right AWD	
F	11-19	JOURNEY AWD Right	
G57752	D		
F	15-18	FORD EDGE All Left	
F	16-18	LINCOLN MKX All Left	
G57753	D		
F	15-18	FORD EDGE All Right	
F	16-18	LINCOLN MKX All Right	
G57754	N		
F	15-16	HONDA CR-V AWD Left	
G57755	N		
F	15-16	HONDA CR-V AWD Right	
G57756	W		
F	13-16	HYUNDAI SANTA FE All Left	
G57757	W		
F	13-16	HYUNDAI SANTA FE All Right	
G57758	W		
F	10-15	HYUNDAI TUCSON All Left	
G57759	W		
F	10-15	HYUNDAI TUCSON All Right	
G57764	N		
F	10-15	JEEP GRAND CHEROKEE All Left	
G57765	N		
F	10-15	JEEP GRAND CHEROKEE All Right	
G57768	W		
F	15-18	JEEP RENEGADE FWD Left	
G57769	W		
F	15-18	JEEP RENEGADE FWD Right	
G57772	W		
F	14-18	NISSAN MURANO All Left	
F	13-20	PATHFINDER All Left	
G57773	W		
F	14-18	NISSAN MURANO All Right	
F	13-20	PATHFINDER All Right	

Numerical listing

Shock	POP	Alternative No.	MTG Acc. Supplied
Pos.	Year	Application	
G57774	B		
F	14-20	NISSAN ROGUE All Left	
G57775	B		
F	14-20	NISSAN ROGUE All Right	
G57776	N		
F	14-15	NISSAN ROGUE SELECT All Left	
G57777	N		
F	14-15	NISSAN ROGUE SELECT All Right	
G57778	W		
F	13-15	NISSAN ROGUE All Left w/ OE #E4302JM00A	
G57779	W		
F	13-15	NISSAN ROGUE All Right w/ OE #E4302JM00A	
G57780	N		
F	13-14	SUBARU OUTBACK All Left	
G57781	N		
F	13-14	SUBARU OUTBACK All Right	
G57782	N		
F	14-18	TOYOTA HIGHLANDER All Left	
G57783	N		
F	14-18	TOYOTA HIGHLANDER All Right	
G57784	D		
F	13-17	TOYOTA RAV4 All Left Exc. Japan Manufactured	
G57785	D		
F	13-17	TOYOTA RAV4 All Right Exc. Japan Manufactured	
G57786	D		
F	18-21	TOYOTA TACOMA 4WD	
G57790	N		
R	11-13	TOYOTA HIGHLANDER FWD Left	
G57791	N		
R	11-13	TOYOTA HIGHLANDER FWD Right	
G57792	N		
R	15-16	HONDA CR-V AWD Left	
G57793	N		
R	15-16	HONDA CR-V AWD Right	
G57794	D		
R	11-18	JEEP COMPASS All	
R	11-17	PATRIOT All	
G57795	W		
R	15-18	JEEP RENEGADE FWD Left	
G57796	W		
R	15-18	JEEP RENEGADE FWD Right	
G57797	N		
R	15-18	JEEP RENEGADE AWD Left	
G57798	N		
R	15-18	JEEP RENEGADE AWD Right	
G57799	D		
R	13-16	SUBARU OUTBACK All	
G57800	A		
F	14-22	RAM PROMASTER 1500 All Left	
F	14-22	PROMASTER 2500 All Left	
F	14-22	PROMASTER 3500 All Left	
G57801	A		
F	14-22	RAM PROMASTER 1500 All Right	
F	14-22	PROMASTER 2500 All Right	
F	14-22	PROMASTER 3500 All Right	
G57802	N		
F	07-09	DODGE SPRINTER 2500 All	
F	07-09	SPRINTER 3500 All	
F	07-18	FREIGHTLINER SPRINTER 2500 All	
F	07-18	SPRINTER 3500 All	
F	10-18	MERCEDES-BENZ SPRINTER 2500 All	
F	10-18	SPRINTER 3500 All	
G57803	W		
F	11-12	HYUNDAI ELANTRA Sedan Left	
G57804	W		
F	11-12	HYUNDAI ELANTRA Sedan Right	

Numerical listing

Shock	POP	Alternative No.	MTG Acc. Supplied
Pos.	Year	Application	
G57812 N			
F	13-20	FORD FUSION All	
G57816 N			
F	15-22	FORD TRANSIT-150 All	
F	15-22	TRANSIT-250 All	
F	15-22	TRANSIT-350 All	
G57817 W			
F	17-18	NISSAN ALTIMA All Left	
G57818 W			
F	17-18	NISSAN ALTIMA All Right	
G57819 N			
F	16-19	FORD EXPLORER All Left	
F	16-19	POLICE INTERCEPTOR UTILITY All Left	
G57820 N			
F	16-19	FORD EXPLORER All Right	
F	16-19	POLICE INTERCEPTOR UTILITY All Right	
G57825 C			
F	11-15	DODGE DURANGO All Right	
LTV Severe Duty			
58357 D			
F	71-95	CHEVROLET VAN 1/2 TON, G / EXPRESS All	
F	70	VAN 1/2 TON, G / EXPRESS All Independent Front Suspension	
F	78-96	VAN 1 TON, G / EXPRESS All	
F	96	VAN 1 TON, G / EXPRESS Cutaway Van	
F	75	VAN 1 TON, G / EXPRESS 146.0 / 370.8 (WheelBase)	
F	71-74	VAN 1 TON, G / EXPRESS All	
F	78-95	VAN 3/4 TON, G / EXPRESS All Exc. 8600# GVW	
F	70-77	VAN 3/4 TON, G / EXPRESS All	
F	70-95	GMC VAN 1/2 TON, G / SAVANA All	
F	76-96	VAN 1 TON, G / SAVANA All	
F	75	VAN 1 TON, G / SAVANA 110.0 / 279.4 (WheelBase)	
F	75	VAN 1 TON, G / SAVANA 125.0 / 317.5 (WheelBase)	
F	71-74	VAN 1 TON, G / SAVANA All	
F	78-95	VAN 3/4 TON, G / SAVANA All Exc. 8600# GVW	
F	71-77	VAN 3/4 TON, G / SAVANA All	
F	70	VAN 3/4 TON, G / SAVANA All Independent Front Suspension	
58359 W 140126			
F	84-86	DODGE MINI RAM All	
F	72-93	PICKUP 1/2 TON, D100 SERIES All	
F	72-93	PICKUP 3/4 TON, D200 SERIES All Exc. Heavy Duty Package	
F	75-93	RAMCHARGER RWD	
F	99-03	VAN 1/2 TON, A / B SERIES / RAM 109.3 / 277.6 (WheelBase) Exc. 7000# GVW	
F	81-98	VAN 1/2 TON, A / B SERIES / RAM 109.6 / 278.4 (WheelBase) Exc. 7000# GVW	
F	71-80	VAN 1/2 TON, A / B SERIES / RAM All	
F	99-03	VAN 1 TON, A / B SERIES / RAM All	
F	71-98	VAN 1 TON, A / B SERIES / RAM All Exc. 4000# Front Axle	
F	71-03	VAN 3/4 TON, A / B SERIES / RAM All	
F	78-80	VAN, CB300 All Exc. 4000# Front Axle	
F	74-77	VAN, CB300 All Up through 8300# GVW	
F	75-81	PLYMOUTH TRAILDUSTER RWD	
F	74-83	VAN 1/2 TON, PB SERIES All	
F	74-83	VAN 1 TON, PB SERIES All Exc. 4000# Front Axle	
F	74-83	VAN 3/4 TON, PB SERIES All	
58403 W			
R	79-95	CHEVROLET VAN 1 TON, G / EXPRESS Cutaway Van	
F	85	VAN 1 TON, P SERIES All Motorhome Chassis w/ I-Beam Front Suspension	
R	97-04	DODGE DAKOTA All	
R	01-03	DURANGO 4WD	
R	01-03	DURANGO RWD	
R	98-00	DURANGO All	
R	79-95	GMC VAN 1 TON, G / SAVANA Cutaway Van	

Ultra ReadyMount, LTV Severe Duty

Shock	POP	Alternative No.	MTG Acc. Supplied
Pos.	Year	Application	
58403 W (cont)			
F	85	VAN 1 TON, P SERIES All Motorhome Chassis w/ I-Beam Front Suspension	
58412 A			
R	99-07	CHEVROLET PICKUP 1/2 TON, SILVERADO 1500 4WD Exc. Electronic Adjustable Suspension	
R	07	PICKUP 1/2 TON, SILVERADO 1500 4WD Old Body Style; Exc. Electronic Adjustable Suspension	
R	05-06	PICKUP 1/2 TON, SILVERADO 1500 HD All	
R	01-03	PICKUP 1/2 TON, SILVERADO 1500 HD All	
R	77-86	PICKUP 1 TON, K30 All	
R	90-91	PICKUP 1 TON, R3500 All	
R	89	PICKUP 1 TON, R3500 Cab & Chassis	
R	89	PICKUP 1 TON, R3500 Crew Cab Pickup	
R	01-09	PICKUP 1 TON, SILVERADO 3500 All	
R	07-10	PICKUP 1 TON, SILVERADO 3500 HD All	
R	87-88	PICKUP 1 TON, V30 All	
R	89-91	PICKUP 1 TON, V3000 / V3500 All	
R	99-08	PICKUP 3/4 TON, SILVERADO 2500 All	
R	01-10	PICKUP 3/4 TON, SILVERADO 2500 HD All	
R	07	SILVERADO 1500 HD CLASSIC All	
R	07	SILVERADO 2500 HD CLASSIC All	
R	07	SILVERADO 3500 CLASSIC All	
R	06-10	DODGE PICKUP 1/2 TON, RAM 1500 (SEE RAM 1500) All Exc. Mega Cab	
R	02-05	PICKUP 1/2 TON, RAM 1500 (SEE RAM 1500) All	
R	77-86	GMC PICKUP 1 TON, K35 / K3500 All	
R	87-91	PICKUP 1 TON, V3000 / V3500 All	
R	07	SIERRA 1500 4WD Old Body Style; Exc. Electronic Adjustable Suspension	
R	99-06	SIERRA 1500 4WD Exc. Electronic Adjustable Suspension	
R	05-06	SIERRA 1500 HD All	
R	01-03	SIERRA 1500 HD All	
R	07	SIERRA 1500 HD CLASSIC All	
R	99-04	SIERRA 2500 All	
R	01-10	SIERRA 2500 HD All	
R	07	SIERRA 2500 HD CLASSIC All	
R	01-06	SIERRA 3500 All	
R	07	SIERRA 3500 CLASSIC All	
R	07-10	SIERRA 3500 HD All	
R	11-18	RAM 1500 (SEE DODGE RAM 1500) All	
R	19-22	1500 CLASSIC All Old Body Style	
58421 B 140455			
F	05	CHEVROLET BLAZER Base, RWD	
F	96-04	BLAZER LS, RWD	
F	95-02	BLAZER LT, RWD	
F	95-99	BLAZER Base, RWD	
F	95-97	BLAZER Deluxe, RWD	
F	83-94	BLAZER, S MODELS RWD	
F	94-03	S10 LS, RWD	
F	82-03	S10 Base, RWD	
F	92-93	S10 EL, RWD	
F	83-92	S10 Tahoe, RWD	
F	88-90	S10 Durango, RWD	
F	82-86	S10 Durango, RWD	
F	72-82	FORD COURIER All	
F	92-04	GMC JIMMY RWD	
F	83-91	S15 JIMMY RWD	
F	04	SONOMA / S15 All RWD	
F	82-03	SONOMA / S15 RWD	
F	78-87	SPRINT / CABALLERO RWD	
F	71-77	SPRINT / CABALLERO All	
F	96-00	ISUZU HOMBRE RWD Exc. Sport Chassis	
F	72-76	MAZDA B1600 All	
F	77-78	B1800 All	
F	79-84	B2000 All	
F	82-84	B2200 All	
58422 B			
R	05	CHEVROLET BLAZER Base, 4WD	
R	05	BLAZER Base, RWD	
R	96-04	BLAZER LS, 4WD	
R	96-04	BLAZER LS, RWD	
R	95-02	BLAZER LT, RWD	
R	95-01	BLAZER LT, 4WD	

Numerical listing

Shock	POP	Alternative No.	MTG Acc. Supplied
Pos.	Year	Application	
58422 B (cont)			
R	95-99	BLAZER Base, 4WD	
R	95-99	BLAZER Base, RWD	
R	95-97	BLAZER Deluxe, RWD	
R	83-94	BLAZER, S MODELS All	
R	94-04	S10 LS, 4WD	
R	99-03	S10 Base, RWD	
R	99-03	S10 LS, RWD	
R	83-03	S10 Base, 4WD	
R	92-93	S10 EL, 4WD	
R	83-92	S10 Tahoe, 4WD	
R	88-90	S10 Durango, 4WD	
R	83-86	S10 Durango, 4WD	
R	05	GMC JIMMY 4WD	
R	92-04	JIMMY All	
R	83-91	S15 JIMMY All	
R	82-04	SONOMA / S15 All	
R	91	SYCLONE All	
R	92-93	TYPHOON All	
R	96-00	ISUZU HOMBRE All	
R	96-01	OLDSMOBILE BRAVADA All	
R	91-94	BRAVADA All	
58423 B			
F	05	CHEVROLET BLAZER Base, 4WD	
F	96-04	BLAZER LS, 4WD	
F	95-01	BLAZER LT, 4WD	
F	95-99	BLAZER Base, 4WD	
F	83-94	BLAZER, S MODELS 4WD	
F	94-04	S10 LS, 4WD	
F	83-03	S10 Base, 4WD	
F	92-93	S10 EL, 4WD	
F	83-92	S10 Tahoe, 4WD	
F	88-90	S10 Durango, 4WD	
F	88	S10 Sport, 4WD	
F	83-86	S10 Durango, 4WD	
F	92-05	GMC JIMMY 4WD	
F	83-91	S15 JIMMY 4WD	
F	83-04	SONOMA / S15 4WD	
F	91	SYCLONE All	
F	92-93	TYPHOON All	
F	96-00	ISUZU HOMBRE All Sport Chassis	
F	96-01	OLDSMOBILE BRAVADA All	
F	91-94	BRAVADA All	
58488 A			
R	91-02	CHEVROLET C3500HD All Solid Front Axle	
R	88-99	PICKUP 1/2 TON, C15 / C1500 All	
R	88-99	PICKUP 1/2 TON, K15 / K1500 All	
R	88-90	PICKUP 1 TON, C35/3500 Extended Cab Pickup Exc. HD Straight Front Axle	
R	88-90	PICKUP 1 TON, C35/3500 Standard Cab Pickup Exc. HD Straight Front Axle	
R	88-00	PICKUP 1 TON, K35 / K3500 All	
R	88-00	PICKUP 3/4 TON, C25 / C2500 All	
R	88-00	PICKUP 3/4 TON, K25 / K2500 All	
R	91-02	GMC C3500HD All Solid Front Axle	
R	88-99	PICKUP 1/2 TON, C15 / C1500 All	
R	88-99	PICKUP 1/2 TON, K15 / K1500 All	
R	98-99	PICKUP 1 TON, C35/3500 Cab & Chassis HD Solid Front Axle	
R	88-97	PICKUP 1 TON, C35/3500 All HD Solid Front Axle	
R	88-00	PICKUP 1 TON, K35 / K3500 All	
R	88-00	PICKUP 3/4 TON, C25 / C2500 All	
R	88-00	PICKUP 3/4 TON, K25 / K2500 All	
58489 A 141537			
F	88-99	CHEVROLET PICKUP 1/2 TON, C15 / C1500 All	
F	92-00	PICKUP 1 TON, C35/3500 Crew Cab Pickup Exc. HD Straight Front Axle	
F	88-00	PICKUP 1 TON, C35/3500 Extended Cab Pickup Exc. HD Straight Front Axle	
F	88-00	PICKUP 1 TON, C35/3500 Standard Cab Pickup Exc. HD Straight Front Axle	
F	88-00	PICKUP 3/4 TON, C25 / C2500 All	
F	92-99	SUBURBAN 1/2 TON, C15 / C1500 All	
F	92-99	SUBURBAN 3/4 TON, C25 / C2500 All	
F	95-00	TAHOE RWD Old Body Style	
F	88-99	GMC PICKUP 1/2 TON, C15 / C1500 All	
F	92-00	PICKUP 1 TON, C35/3500 Crew Cab Pickup Exc. HD Straight Front Axle	

Numerical listing

Shock	POP	Alternative No.	MTG Acc. Supplied
Pos.	Year	Application	
58489		A (cont)	141537
F	88-00	PICKUP 1 TON, C35/3500 Extended Cab Pickup Exc. HD Straight Front Axle	
F	88-00	PICKUP 1 TON, C35/3500 Standard Cab Pickup Exc. HD Straight Front Axle	
F	88-00	PICKUP 3/4 TON, C25 / C2500 All	
F	92-99	SUBURBAN 1/2 TON, C15 / C1500 All	
F	92-99	SUBURBAN 3/4 TON, C25 / C2500 All	
F	92-99	YUKON RWD	
58609		A	140780
F	99-00	CADILLAC ESCALADE All	
F	90-05	CHEVROLET ASTRO AWD	
F	92-94	BLAZER 4WD Full Size	
F	88-00	PICKUP 1 TON, K35 / K3500 All	
F	88-00	PICKUP 3/4 TON, K25 / K2500 All	
F	92-99	SUBURBAN 1/2 TON, K15 / K1500 All	
F	92-99	SUBURBAN 3/4 TON, K25 / K2500 All	
F	88-00	GMC PICKUP 1 TON, K35 / K3500 All	
F	88-00	PICKUP 3/4 TON, K25 / K2500 All	
F	90-05	SAFARI AWD	
F	92-99	SUBURBAN 1/2 TON, K15 / K1500 All	
F	92-99	SUBURBAN 3/4 TON, K25 / K2500 All	
58622		D	142617
F	00-02	FORD E-450 ECONOLINE SUPER DUTY All	
F	00-06	ECONOLINE All	
F	21-22	VAN 1 TON, ECONOLINE / CLUB WAGON / SUPERDUTY All	
F	99-19	VAN 1 TON, ECONOLINE / CLUB WAGON / SUPERDUTY All	
F	04-11	VAN 1 TON, ECONOLINE / CLUB WAGON / SUPERDUTY All Exc. Cutaway Chassis	
F	07-08	VAN 1 TON, ECONOLINE / CLUB WAGON / SUPERDUTY All Cutaway Chassis	
F	92-05	VAN 1 TON, ECONOLINE / CLUB WAGON / SUPERDUTY All Cutaway Chassis	
F	92-14	VAN 3/4 TON, ECONOLINE / CLUB WAGON / SUPERDUTY All	
58623		D	142617
R	00-02	FORD E-450 ECONOLINE SUPER DUTY All	
R	00-06	ECONOLINE All	
R	10-14	VAN 1/2 TON, ECONOLINE / CLUB WAGON All	
R	21-22	VAN 1 TON, ECONOLINE / CLUB WAGON / SUPERDUTY All	
R	04-19	VAN 1 TON, ECONOLINE / CLUB WAGON / SUPERDUTY All Exc. Cutaway Chassis	
R	99-19	VAN 1 TON, ECONOLINE / CLUB WAGON / SUPERDUTY All	
R	07-08	VAN 1 TON, ECONOLINE / CLUB WAGON / SUPERDUTY All Cutaway Chassis	
R	92-05	VAN 1 TON, ECONOLINE / CLUB WAGON / SUPERDUTY All Cutaway Chassis	
R	92-14	VAN 3/4 TON, ECONOLINE / CLUB WAGON / SUPERDUTY All	
58638		A	
R	99-00	CADILLAC ESCALADE All	
R	92-94	CHEVROLET BLAZER 4WD Full Size	
R	09-22	EXPRESS 4500 All	
R	92-99	SUBURBAN 1/2 TON, C15 / C1500 All	
R	92-99	SUBURBAN 1/2 TON, K15 / K1500 All	
R	92-99	SUBURBAN 3/4 TON, C25 / C2500 All	
R	92-99	SUBURBAN 3/4 TON, K25 / K2500 All	
R	95-00	TAHOE All Old Body Style	
R	96-14	VAN 1/2 TON, G / EXPRESS All	
R	10-12	VAN 1 TON, G / EXPRESS All	
R	03-06	VAN 1 TON, G / EXPRESS All	
R	07-09	VAN 3/4 TON, G / EXPRESS All	
R	96-02	VAN 3/4 TON, G / EXPRESS All Exc. 8600# GVW	

LTV Severe Duty

Shock	POP	Alternative No.	MTG Acc. Supplied
Pos.	Year	Application	
58638		A (cont)	
R	92-99	GMC SUBURBAN 1/2 TON, C15 / C1500 All	
R	92-99	SUBURBAN 1/2 TON, K15 / K1500 All	
R	92-99	SUBURBAN 3/4 TON, C25 / C2500 All	
R	92-99	SUBURBAN 3/4 TON, K25 / K2500 All	
R	08-14	VAN 1/2 TON, G / SAVANA All	
R	96-06	VAN 1/2 TON, G / SAVANA All	
R	96-02	VAN 1 TON, G / SAVANA All Exc. 8600# GVW	
R	96-02	VAN 3/4 TON, G / SAVANA All Exc. 8600# GVW	
R	92-99	YUKON All	
58662		C	
R	99-07	CHEVROLET PICKUP 1/2 TON, SILVERADO 1500 RWD Exc. Electronic Adjustable Suspension	
R	94-01	DODGE PICKUP 1/2 TON, RAM 1500 (SEE RAM 1500) All	
R	94-02	PICKUP 1 TON, RAM 3500 (SEE RAM 3500) RWD Exc. Solid Front Axle	
R	94-02	PICKUP 3/4 TON, RAM 2500 (SEE RAM 2500) All Exc. 8800# GVW	
R	99-07	GMC SIERRA 1500 RWD Exc. Electronic Adjustable Suspension	
58714		W	142731
F	97-02	FORD EXPEDITION RWD Exc. Front Air- Leveling	
F	97-03	LOBO RWD	
F	97-04	PICKUP 1/2 TON, F-150 RWD	
F	96-99	PICKUP 3/4 TON, F-250 / SUPERDUTY RWD Up through 8500# GVW	
F	98-02	LINCOLN NAVIGATOR RWD	
58803		A	141665
F	02-06	CADILLAC ESCALADE All NON-GAS-CHARGED	
F	02-04	ESCALADE EXT All NON-GAS-CHARGED	
F	02-06	CHEVROLET AVALANCHE 1500 All Exc. Electronic Ride Control	
F	07	PICKUP 1/2 TON, SILVERADO 1500 4WD Old Body Style; Exc. Electronic Adjustable Suspension	
F	99-06	PICKUP 1/2 TON, SILVERADO 1500 4WD Exc. Electronic Adjustable Suspension	
F	00-06	SUBURBAN 1/2 TON, 1500 All Exc. Z55 Auto Ride Suspension	
F	02-06	TAHOE All Exc. Z55 Auto Ride Suspension	
F	00-01	TAHOE All New Body Style; Exc. Z55 Auto Ride Suspension	
F	07	GMC SIERRA 1500 4WD Old Body Style; Exc. Electronic Adjustable Suspension	
F	99-06	SIERRA 1500 4WD Exc. Electronic Adjustable Suspension	
F	00-06	YUKON All Exc. Z55 Auto Ride Suspension	
F	00-06	YUKON XL 1/2 TON All Exc. Z55 Auto Ride Suspension	
58807		C	142617
F	13-16	FORD PICKUP 1 TON, F-350 / SUPERDUTY All	
F	99-16	PICKUP 1 TON, F-350 / SUPERDUTY RWD	
F	99-16	PICKUP 3/4 TON, F-250 / SUPERDUTY RWD	
58808		W	
R	99-04	FORD PICKUP 1 TON, F-350 / SUPERDUTY RWD	
R	99-04	PICKUP 3/4 TON, F-250 / SUPERDUTY RWD	
58809		C	
F	99-04	FORD PICKUP 1 TON, F-350 / SUPERDUTY 4WD	
F	99-04	PICKUP 3/4 TON, F-250 / SUPERDUTY 4WD	
F	99-04	PICKUP, F-450 SUPERDUTY All	
F	99-04	PICKUP, F-550 SUPERDUTY All	
58810		D	
R	99-04	FORD PICKUP 1 TON, F-350 / SUPERDUTY 4WD	

Numerical listing

Shock	POP	Alternative No.	MTG Acc. Supplied
Pos.	Year	Application	
58810		D (cont)	
R	99-04	PICKUP 3/4 TON, F-250 / SUPERDUTY 4WD	
58817		A	141665
F	02-06	CHEVROLET AVALANCHE 2500 All Exc. Electronic Ride Control	
F	05-06	PICKUP 1/2 TON, SILVERADO 1500 HD All	
F	01-03	PICKUP 1/2 TON, SILVERADO 1500 HD All	
F	01-09	PICKUP 1 TON, SILVERADO 3500 All	
F	07-10	PICKUP 1 TON, SILVERADO 3500 HD All	
F	05-08	PICKUP 3/4 TON, SILVERADO 2500 All	
F	99-04	PICKUP 3/4 TON, SILVERADO 2500 4WD	
F	01-10	PICKUP 3/4 TON, SILVERADO 2500 HD All 9200# GVW	
F	07	SILVERADO 1500 HD CLASSIC All	
F	07	SILVERADO 2500 HD CLASSIC All 9200# GVW	
F	07	SILVERADO 3500 CLASSIC All Heavy Duty	
F	00-11	SUBURBAN 3/4 TON, 2500 All Exc. Z55 Auto Ride Suspension and Quadrateer	
F	05-06	GMC SIERRA 1500 HD All	
F	01-03	SIERRA 1500 HD All	
F	07	SIERRA 1500 HD CLASSIC All	
F	99-04	SIERRA 2500 All	
F	01-10	SIERRA 2500 HD All	
F	01-06	SIERRA 3500 All	
F	07	SIERRA 3500 CLASSIC All	
F	07-10	SIERRA 3500 HD Torsion Bar (Front/SpringType)	
F	00-06	YUKON XL 3/4 TON All Exc. Hydraulic Self-Leveling System	
58901		B	
F	88-99	CHEVROLET PICKUP 1/2 TON, K15 / K1500 All	
F	95-00	TAHOE 4WD Old Body Style	
F	88-99	GMC PICKUP 1/2 TON, K15 / K1500 All	
F	92-99	YUKON 4WD	
58929		D	140780
F	90	FORD BRONCO II All	
F	91-94	EXPLORER All	
F	90-97	RANGER All	
F	92-11	VAN 1/2 TON, ECONOLINE / CLUB WAGON All	
F	94-97	MAZDA B2300 All	
F	91-94	NAVAJO All	
58930		A	
R	02-13	CADILLAC ESCALADE All Exc. Electronic Ride Control	
R	07-13	CHEVROLET AVALANCHE 1500 All Exc. Z55 or ZW7 Ride Suspension	
R	02-06	AVALANCHE 1500 All Exc. Electronic Ride Control	
R	02-06	AVALANCHE 2500 All Exc. Electronic Ride Control	
R	07-11	SUBURBAN 1/2 TON, 1500 All Exc. Z55 or ZW7 Ride Suspension	
R	00-06	SUBURBAN 1/2 TON, 1500 All Exc. Z55 Auto Ride Suspension	
R	00-11	SUBURBAN 3/4 TON, 2500 All Exc. Z55 Auto Ride Suspension and Quadrateer	
R	07-11	TAHOE All Exc. Z55 or ZW7 Ride Suspension	
R	02-06	TAHOE All Exc. Z55 Auto Ride Suspension	
R	00-01	TAHOE All New Body Style; Exc. Z55 Auto Ride Suspension	
R	07-11	GMC YUKON All Exc. Z55 or ZW7 Ride Suspension	
R	00-06	YUKON All Exc. Z55 Auto Ride Suspension	
R	07-11	YUKON XL 1/2 TON All Exc. Z55 or ZW7 Ride Suspension	
R	00-06	YUKON XL 1/2 TON All Exc. Z55 Auto Ride Suspension	
R	00-11	YUKON XL 3/4 TON All Exc. Z55 Auto Ride Suspension and Quadrateer	
58944		W	
F	07-12	FORD PICKUP, F-450 SUPERDUTY All	
F	10-12	PICKUP, F-550 SUPERDUTY All	

Numerical listing

Shock	POP	Alternative No.	MTG Acc. Supplied
Pos.	Year	Application	
ProGuard			
61500	A		
R	75-80	CHEVROLET	LUV PICKUP All
R	72-74		LUV PICKUP All
F	55-56		PICKUP 3800
F	55		PICKUP 3100
R	79-82	DODGE	D50 RWD
R	87-93		PICKUP, RAM 50 RWD
R	83-86		PICKUP, RAM 50 All
R	61-64	FORD	PICKUP 1/2 TON, F-100 All
R	61-66		PICKUP 1 TON, F-350 / SUPERDUTY All
R	61-64		PICKUP 3/4 TON, F-250 / SUPERDUTY All
F	68-76		PICKUP P350 All Up through 8000# GVW
F	75-76		PICKUP P400 All Up through 8000# GVW
R	68	INTERNATIONAL	908C All
R	68		1000C All
F	68		1100C All Exc. 166" Wheelbase
R	68		1100C All Exc. 166" Wheelbase
F	68		1200C All Exc. 166" Wheelbase
R	68		1200C All Exc. 166" Wheelbase
F	68		1300C All Exc. 166" Wheelbase
R	68		1300C All Exc. 166" Wheelbase
R	68-72		M1100 / M1200 All
R	69		M1400 All
R	72-83	JEEP	CJ5 All Exc. Lift Kit
R	66-71		CJ5 All
R	72-75		CJ6 All Exc. Lift Kit
R	66-71		CJ6 All
R	76-86		CJ7 All Exc. Lift Kit
R	66-74		DJ5 All Exc. Lift Kit
R	66-68		DJ6 All
R	57-60		FC150 All
F	63-65		FC170 All
R	63-65		FC170 All
R	63-66		GLADIATOR All Independent Front Suspension
R	70-71		JEEPSTER All
R	81-85		SCRAMBLER / CJ8 All
R	61-67		UNIVERSAL All
R	86-87	MAZDA	B2000 RWD
R	87-93		B2200 RWD
R	87-93		B2600 RWD
R	95-96	MITSUBISHI	MIGHTY MAX All
R	83-94		MIGHTY MAX RWD
R	87-90		VAN All
R	98-04	NISSAN	FRONTIER RWD Exc. Desert Runner
R	87-97		PICKUP RWD
R	86		PICKUP RWD Mfg. from 8/86
R	79-82	PLYMOUTH	PICKUP All
R	69-74	TOYOTA	LAND CRUISER All Exc. Wagon
R	67-68		LAND CRUISER All
R	85-95		PICKUP RWD Exc. 1 Ton
R	84		PICKUP RWD
R	75-83		PICKUP RWD Mojave
R	70-74		PICKUP All RWD
R	04		TACOMA Base, RWD
R	95-03		TACOMA DLX, RWD
R	98-00		TACOMA SR5, 4WD
R	84-88		VAN Leaf (RearSpringType)
R	88		VAN WAGON All Leaf(RearSpringType)
61501	D		140857
F	81-82	CHEVROLET	LUV PICKUP RWD
F	81-95	ISUZU	PICKUP RWD
F	69-72	NISSAN	521 PICKUP All
F	72-79		620 PICKUP All
F	80-86		720 PICKUP All
F	87-97		PICKUP 4WD
F	86		PICKUP 4WD Mfg. from 8/86
61504	A		140455
F	05	CHEVROLET	BLAZER Base, RWD
F	96-04		BLAZER LS, RWD
F	95-02		BLAZER LT, RWD
F	95-99		BLAZER Base, RWD
F	95-97		BLAZER Deluxe, RWD
F	83-94		BLAZER, S MODELS RWD
F	68-87		EL CAMINO All
F	94-03		S10 LS, RWD
F	82-03		S10 Base, RWD
F	92-93		S10 EL, RWD
F	83-92		S10 Tahoe, RWD
F	88-90		S10 Durango, RWD
F	82-86		S10 Durango, RWD
F	72-82	FORD	COURIER All
F	92-04	GMC	JIMMY RWD
F	83-91		S15 JIMMY RWD
F	04		SONOMA / S15 All RWD

ProGuard

Shock	POP	Alternative No.	MTG Acc. Supplied
Pos.	Year	Application	
61504	A (cont)		140455
F	82-03		SONOMA / S15 RWD
F	71-87		SPRINT / CABALLERO All
F	96-00	ISUZU	HOMBRE RWD Exc. Sport Chassis
F	72-76	MAZDA	B1600 All
F	77-78		B1800 All
F	79-84		B2000 All
F	82-84		B2200 All
F	75-83	TOYOTA	PICKUP RWD Mojave
F	70-74		PICKUP All RWD
61506	B		141137
R	81-82	CHEVROLET	LUV PICKUP All
R	87-89	DODGE	RAIDER 2.6L 4Cyl L (156), 3.59 91.1(Bore)3.86 98.0(Stroke)
F	61-67	FORD	ECONOLINE All
R	89-94	ISUZU	AMIGO All
R	81-95		PICKUP All
R	84-86		TROOPER 4WD
R	86-92	JEEP	COMANCHE All
R	83-88	MITSUBISHI	MONTERO 2.6L 4Cyl L (156), 3.59 91.1(Bore)3.86 98.0(Stroke)
R	97-99		MONTERO SPORT All
R	82-86	NISSAN	720 PICKUP 4WD
R	00-04		FRONTIER Crew Cab Pickup, RWD w/ Desert Runner
R	98-04		FRONTIER 4WD
R	98-99		FRONTIER RWD Crew Cab; w/ Desert Runner Package
R	87-95		PATHFINDER All Exc. Electronic Adjustable Suspension
R	87-97		PICKUP 4WD
R	86		PICKUP 4WD Mfg. from 8/86
R	00-04		XTERRA All
R	84-87	TOYOTA	LAND CRUISER FJ60 (MfrBodyCode), Sport Utility
R	80-83		LAND CRUISER All
R	79		LAND CRUISER FJ40 (MfrBodyCode)
R	79		LAND CRUISER FJ55 (MfrBodyCode), Sport Utility
R	76-78		LAND CRUISER All
R	75		LAND CRUISER FJ40 (MfrBodyCode) Mfg. from 1/75
R	75		LAND CRUISER FJ55 (MfrBodyCode), Sport Utility Mfg. from 1/75
R	85-92		PICKUP RWD 1 Ton
R	80-83		PICKUP 4WD Exc. Lift Kit
R	93-98		T100 RWD
61508	C		140857
F	81-82	CHEVROLET	LUV PICKUP 4WD
F	75-80		LUV PICKUP All
F	72-74		LUV PICKUP All
F	89-94	ISUZU	AMIGO All
F	81-95		PICKUP 4WD
F	84-86		TROOPER 4WD
F	98-04	NISSAN	FRONTIER RWD Exc. Desert Runner
F	87-97		PICKUP RWD
F	86		PICKUP RWD Mfg. from 8/86
61509	W		140455
F	93-95	TOYOTA	PICKUP RWD Exc. 1 Ton
F	85-92		PICKUP RWD 1 Ton
F	84		PICKUP RWD
F	93-98		T100 RWD
61510	W		140149
R	84-89	TOYOTA	4RUNNER All
R	84-95		PICKUP 4WD Exc. Lift Kit
R	01-04		TACOMA S-Runner
R	04		TACOMA Base, 4WD
R	95-03		TACOMA DLX, 4WD
R	98-00		TACOMA Limited
61512	W		140126
F	87-04	DODGE	DAKOTA RWD
F	99-03		DURANGO RWD
61516	D		
F	87-91	CHEVROLET	BLAZER 4WD Exc. Quad Suspension and Lift Kit
F	81-86		BLAZER 4WD Quad Suspension Short Shock; Exc. Lift Kit
F	69-80		BLAZER 4WD Exc. Quad Suspension and Lift Kit
F	81-86		PICKUP 1/2 TON, K10 All Quad Suspension Short Shock; Exc. Lift Kit
F	69-80		PICKUP 1/2 TON, K10 All Exc. Lift Kit

Numerical listing

Shock	POP	Alternative No.	MTG Acc. Supplied
Pos.	Year	Application	
61516	D (cont)		
F	88		PICKUP 1/2 TON, K15 / K1500 All Quad Suspension Short Shock; Exc. Lift Kit
F	87		PICKUP 1/2 TON, V10 All Quad Suspension Short Shock; Exc. Lift Kit
F	81-86		PICKUP 3/4 TON, K20 All Quad Suspension Short Shock; Exc. Lift Kit
F	69-80		PICKUP 3/4 TON, K20 All Exc. Lift Kit
F	87		PICKUP 3/4 TON, V20 All Exc. Quad Suspension and Lift Kit
F	81-86		SUBURBAN 1/2 TON, K10 All Quad Suspension Short Shock; Exc. Lift Kit
F	69-80		SUBURBAN 1/2 TON, K10 All Exc. Lift Kit
F	87-88		SUBURBAN 1/2 TON, V10 All Quad Suspension Short Shock; Exc. Lift Kit
F	89-91		SUBURBAN 1/2 TON, V1500 All Exc. Quad Suspension and Lift Kit
F	81-86		SUBURBAN 3/4 TON, K20 All Quad Suspension Short Shock; Exc. Lift Kit
F	69-80		SUBURBAN 3/4 TON, K20 All Exc. Lift Kit
F	87-88		SUBURBAN 3/4 TON, V20 All Quad Suspension Short Shock; Exc. Lift Kit
F	89-91		SUBURBAN 3/4 TON, V2500 All Quad Suspension Short Shock; Exc. Lift Kit
F	75-91	GMC	JIMMY 4WD Exc. Quad Suspension and Lift Kit
F	70-74		JIMMY All 4WD; Exc. Quad Suspension and Lift Kit
F	69-86		PICKUP 1/2 TON, K15 / K1500 All Exc. Quad Suspension and Lift Kit
F	87		PICKUP 1/2 TON, V1500 All Quad Suspension Short Shock; Exc. Lift Kit
F	69-86		PICKUP 3/4 TON, K25 / K2500 All Exc. Quad Suspension and Lift Kit
F	87		PICKUP 3/4 TON, V2500 All Quad Suspension Short Shock; Exc. Lift Kit
F	69-86		SUBURBAN 1/2 TON, K15 / K1500 All Exc. Quad Suspension and Lift Kit
F	87-91		SUBURBAN 1/2 TON, V1500 All Quad Suspension Short Shock; Exc. Lift Kit
F	69-86		SUBURBAN 3/4 TON, K25 / K2500 All Exc. Quad Suspension and Lift Kit
F	87-91		SUBURBAN 3/4 TON, V2500 All Quad Suspension Short Shock; Exc. Lift Kit
61517	C		
F	71-95	CHEVROLET	VAN 1/2 TON, G / EXPRESS All
F	70		VAN 1/2 TON, G / EXPRESS All Independent Front Suspension
F	78-96		VAN 1 TON, G / EXPRESS All
F	75		VAN 1 TON, G / EXPRESS 146.0 / 370.8 (WheelBase)
F	71-74		VAN 1 TON, G / EXPRESS All
F	78-95		VAN 3/4 TON, G / EXPRESS All Exc. 8600# GVW
F	71-77		VAN 3/4 TON, G / EXPRESS All
F	70		VAN 3/4 TON, G / EXPRESS All Independent Front Suspension
F	71-95	GMC	VAN 1/2 TON, G / SAVANA All
F	70		VAN 1/2 TON, G / SAVANA All Independent Front Suspension
F	76-95		VAN 1 TON, G / SAVANA All
F	75		VAN 1 TON, G / SAVANA 110.0 / 279.4 (WheelBase)
F	75		VAN 1 TON, G / SAVANA 125.0 / 317.5 (WheelBase)
F	71-74		VAN 1 TON, G / SAVANA All
F	78-95		VAN 3/4 TON, G / SAVANA All Exc. 8600# GVW
F	71-77		VAN 3/4 TON, G / SAVANA All
F	70		VAN 3/4 TON, G / SAVANA All Independent Front Suspension
61518	C		140126
R	66	FORD	BRONCO All Thru Serial #830000
R	75-79		PICKUP 1/2 TON, F-100 RWD

Numerical listing

Shock	POP	Alternative No.	MTG Acc. Supplied
Pos.	Year	Application	
61518	C (cont)		140126
R	70-74	PICKUP 1/2 TON, F-100 All RWD	
R	75-79	PICKUP 1/2 TON, F-150 RWD	
R	75-79	PICKUP 1 TON, F-350 / SUPERDUTY Extended Cab Pickup, RWD	
R	67-74	PICKUP 1 TON, F-350 / SUPERDUTY RWD Extended Cab	
R	75-79	PICKUP 3/4 TON, F-250 / SUPERDUTY Cab & Chassis, RWD	
R	75-79	PICKUP 3/4 TON, F-250 / SUPERDUTY Standard Cab Pickup, RWD	
R	65-74	PICKUP 3/4 TON, F-250 / SUPERDUTY All RWD	
R	75-91	VAN 1/2 TON, ECONOLINE / CLUB WAGON All	
F	71-80	INTERNATIONAL SCOUT II All	
61519	A		141137
R	78-79	FORD BRONCO All Exc. Lift Kit	
R	66-77	BRONCO All From Serial #830001; Exc. Lift Kit	
R	65-69	PICKUP 1/2 TON, F-100 All RWD	
R	75-79	PICKUP 1 TON, F-350 / SUPERDUTY Standard Cab Pickup, RWD	
R	73-74	PICKUP 1 TON, F-350 / SUPERDUTY All RWD; Exc. Supercab	
R	75-79	PICKUP 3/4 TON, F-250 / SUPERDUTY Extended Cab Pickup, RWD	
R	73-74	PICKUP 3/4 TON, F-250 / SUPERDUTY RWD Supercab	
R	65-72	PICKUP 3/4 TON, F-250 / SUPERDUTY All RWD; Supercab	
R	69-74	VAN 1/2 TON, ECONOLINE / CLUB WAGON All	
R	69-74	VAN 1 TON, ECONOLINE / CLUB WAGON / SUPERDUTY All	
R	69-74	VAN 3/4 TON, ECONOLINE / CLUB WAGON / SUPERDUTY All	
R	76-83	JEEP CHEROKEE All	
F	74-83	CHEROKEE All	
F	82-83	CJ5 All Exc. Lift Kit	
F	82-86	CJ7 All Exc. Lift Kit	
R	67	GLADIATOR All	
F	93	GRAND WAGONEER All	
R	93	GRAND WAGONEER All	
F	84-91	GRAND WAGONEER All	
R	84-91	GRAND WAGONEER All	
F	74-88	J10 PICKUP All	
R	74-88	J10 PICKUP All	
F	74-88	J20 PICKUP All	
R	74-88	J20 PICKUP All	
R	68-73	J2500 PICKUP All	
F	82-85	SCRAMBLER / CJ8 All	
R	76-83	WAGONEER All	
F	74-83	WAGONEER All	
61520	A		140780
F	80-96	FORD BRONCO All Rearward of Front Axle; Exc. Lift Kit	
F	89	BRONCO II All Mfg. to 2/89; Vehicles w/ 10mm & 12mm bolt in rear lower mount	
F	84-88	BRONCO II All w/ 10mm Bolt In Rear Lower Mount	
F	97	F-250 HD RWD	
F	80-83	PICKUP 1/2 TON, F-100 RWD	
F	80-96	PICKUP 1/2 TON, F-150 4WD Rearward of Front Axle; Exc. Lift Kit	
F	80-96	PICKUP 1/2 TON, F-150 RWD	
F	80-97	PICKUP 1 TON, F-350 / SUPERDUTY RWD	
F	97	PICKUP 3/4 TON, F-250 / SUPERDUTY RWD Over 8500# GVW	
F	80-96	PICKUP 3/4 TON, F-250 / SUPERDUTY RWD	
F	87-89	RANGER All Exc. High Ryder Option	
F	83-86	RANGER All	
61521	B		140780
F	78-79	FORD BRONCO All RWD, 4WD Quad Suspension Rearward of Front Axle, Non Quad Suspension	
F	66-77	BRONCO All From Serial #830001; Exc. Lift Kit RWD, 4WD Quad Suspension Rearward of Front Axle, Non Quad Suspension	
F	65-79	PICKUP 1/2 TON, F-100 All Quad Suspension Rearward of Front Axle	

ProGuard

Shock	POP	Alternative No.	MTG Acc. Supplied
Pos.	Year	Application	
61521	B (cont)		140780
F	75-79	PICKUP 1/2 TON, F-150 All Quad Suspension Rearward of Front Axle	
F	67-79	PICKUP 1 TON, F-350 / SUPERDUTY All Quad Suspension Rearward of Front Axle	
F	65-79	PICKUP 3/4 TON, F-250 / SUPERDUTY All Quad Suspension Rearward of Front Axle	
F	75-91	VAN 1 TON, ECONOLINE / CLUB WAGON / SUPERDUTY All Exc. Cutaway Chassis RWD, 4WD Quad Suspension Rearward of Front Axle, Non Quad Suspension	
F	75-91	VAN 3/4 TON, ECONOLINE / CLUB WAGON / SUPERDUTY All RWD, 4WD Quad Suspension Rearward of Front Axle, Non Quad Suspension	
61522	C		
F	87-91	CHEVROLET BLAZER 4WD Full Size; Quad Suspension Long Shock; Exc. Lift Kit	
F	81-86	BLAZER 4WD Quad Suspension Long Shock; Exc. Lift Kit	
F	81-86	PICKUP 1/2 TON, K10 All Quad Suspension Long Shock; Exc. Lift Kit	
F	88	PICKUP 1/2 TON, K15 / K1500 All Quad Suspension Long Shock; Exc. Lift Kit	
F	87	PICKUP 1/2 TON, V10 All Quad Suspension Long Shock; Exc. Lift Kit	
F	81-86	PICKUP 3/4 TON, K20 All Quad Suspension Long Shock; Exc. Lift Kit	
F	87	PICKUP 3/4 TON, V20 All Quad Suspension Long Shock; Exc. Lift Kit	
F	81-86	SUBURBAN 1/2 TON, K10 All Quad Suspension Long Shock; Exc. Lift Kit	
F	87-88	SUBURBAN 1/2 TON, V10 All Quad Suspension Long Shock; Exc. Lift Kit	
F	81-86	SUBURBAN 3/4 TON, K20 All Quad Suspension Long Shock; Exc. Lift Kit	
F	87-88	SUBURBAN 3/4 TON, V20 All Quad Suspension Long Shock; Exc. Lift Kit	
F	89-91	SUBURBAN 3/4 TON, V2500 All Quad Suspension Long Shock; Exc. Lift Kit	
R	78-95	VAN 1/2 TON, G / EXPRESS All	
R	78-95	VAN 1 TON, G / EXPRESS Cutaway Van	
R	78-95	VAN 3/4 TON, G / EXPRESS All Exc. 8600# GVW	
R	84-86	DODGE MINI RAM All	
R	99-03	VAN 1/2 TON, A / B SERIES / RAM 109.3 / 277.6 (WheelBase) Exc. 7000# GVW	
R	81-98	VAN 1/2 TON, A / B SERIES / RAM 109.6 / 278.4 (WheelBase) Exc. 7000# GVW	
R	71-80	VAN 1/2 TON, A / B SERIES / RAM All	
R	99-03	VAN 1 TON, A / B SERIES / RAM All	
R	95-98	VAN 1 TON, A / B SERIES / RAM All Exc. 4000# Front Axle	
R	71-94	VAN 1 TON, A / B SERIES / RAM All	
R	71-03	VAN 3/4 TON, A / B SERIES / RAM All	
R	74-80	VAN, CB300 All	
F	75-91	GMC JIMMY 4WD Quad Suspension Long Shock; Exc. Lift Kit	
F	73-74	JIMMY All 4WD; Quad Suspension Long Shock; Exc. Lift Kit	
F	81-86	PICKUP 1/2 TON, K15 / K1500 All Quad Suspension Long Shock; Exc. Lift Kit	
F	87	PICKUP 1/2 TON, V1500 All Quad Suspension Long Shock; Exc. Lift Kit	
F	81-86	PICKUP 3/4 TON, K25 / K2500 All Quad Suspension Long Shock; Exc. Lift Kit	
F	87	PICKUP 3/4 TON, V2500 All Quad Suspension Long Shock; Exc. Lift Kit	
F	81-86	SUBURBAN 1/2 TON, K15 / K1500 All Quad Suspension Long Shock; Exc. Lift Kit	
F	87-91	SUBURBAN 1/2 TON, V1500 All Quad Suspension Long Shock; Exc. Lift Kit	
F	81-86	SUBURBAN 3/4 TON, K25 / K2500 All Quad Suspension Long Shock; Exc. Lift Kit	
F	87-91	SUBURBAN 3/4 TON, V2500 All Quad Suspension Long Shock; Exc. Lift Kit	
R	78-95	VAN 1/2 TON, G / SAVANA All	

Numerical listing

Shock	POP	Alternative No.	MTG Acc. Supplied
Pos.	Year	Application	
61522	C (cont)		
R	85-96	VAN 1 TON, G / SAVANA Extended Cargo Van	
R	85-96	VAN 1 TON, G / SAVANA Extended Passenger Van	
R	79-96	VAN 1 TON, G / SAVANA Standard Cargo Van	
R	79-96	VAN 1 TON, G / SAVANA Standard Passenger Van	
R	78	VAN 1 TON, G / SAVANA Cutaway Van	
R	78-95	VAN 3/4 TON, G / SAVANA All Exc. 8600# GVW	
R	74-83	PLYMOUTH VAN 1/2 TON, PB SERIES All	
R	74-83	VAN 1 TON, PB SERIES All	
R	74-83	VAN 3/4 TON, PB SERIES All	
61523	W		140126
F	84-86	DODGE MINI RAM All	
F	72-93	PICKUP 1/2 TON, D100 SERIES All	
F	72-93	PICKUP 3/4 TON, D200 SERIES All Exc. Heavy Duty Package	
F	75-93	RAMCHARGER RWD	
F	99-03	VAN 1/2 TON, A / B SERIES / RAM 109.3 / 277.6 (WheelBase) Exc. 7000# GVW	
F	81-98	VAN 1/2 TON, A / B SERIES / RAM 109.6 / 278.4 (WheelBase) Exc. 7000# GVW	
F	71-80	VAN 1/2 TON, A / B SERIES / RAM All	
F	99-03	VAN 1 TON, A / B SERIES / RAM All	
F	71-98	VAN 1 TON, A / B SERIES / RAM All Exc. 4000# Front Axle	
F	71-03	VAN 3/4 TON, A / B SERIES / RAM All	
F	74-80	VAN, CB300 All Exc. 4000# Front Axle	
F	75-81	PLYMOUTH TRAILDUSTER RWD	
F	74-83	VAN 1/2 TON, PB SERIES All	
F	74-83	VAN 1 TON, PB SERIES All Exc. 4000# Front Axle	
F	74-83	VAN 3/4 TON, PB SERIES All	
61524	A		140357
R	87-91	CHEVROLET BLAZER 4WD Full Size; Exc. Lift Kit	
R	85-86	BLAZER 4WD Exc. Lift Kit	
R	73-84	BLAZER All Exc. Lift Kit	
R	73-86	PICKUP 1/2 TON, C10 All	
R	73-86	PICKUP 1/2 TON, K10 All Exc. Lift Kit	
R	87	PICKUP 1/2 TON, R10 All	
R	87	PICKUP 1/2 TON, V10 All Exc. Lift Kit	
R	75-86	PICKUP 3/4 TON, C20 Standard Cab Pickup	
R	73-74	PICKUP 3/4 TON, C20 All Standard Cab Pickup	
R	73-86	PICKUP 3/4 TON, K20 All Exc. Lift Kit	
R	87	PICKUP 3/4 TON, R20 Standard Cab Pickup	
R	87	PICKUP 3/4 TON, V20 All Exc. Quad Suspension and Lift Kit	
R	73-86	SUBURBAN 1/2 TON, C10 All	
R	73-86	SUBURBAN 1/2 TON, K10 All Exc. Lift Kit	
R	87-88	SUBURBAN 1/2 TON, R10 All	
R	89-91	SUBURBAN 1/2 TON, R1500 All	
R	89-91	SUBURBAN 1/2 TON, V1500 All Exc. Lift Kit	
R	73-86	SUBURBAN 3/4 TON, C20 All	
R	73-86	SUBURBAN 3/4 TON, K20 All Exc. Lift Kit	
R	87-88	SUBURBAN 3/4 TON, R20 All	
R	89-91	SUBURBAN 3/4 TON, R2500 All	
R	87-88	SUBURBAN 3/4 TON, V20 All Exc. Quad Suspension and Lift Kit	
R	89-91	SUBURBAN 3/4 TON, V2500 All Exc. Lift Kit	
R	73	VAN 1/2 TON, P SERIES All	
R	73-78	VAN 3/4 TON, P SERIES All	
R	73-91	GMC JIMMY All Exc. Lift Kit	
R	73-86	PICKUP 1/2 TON, C15 / C1500 All	
R	73-86	PICKUP 1/2 TON, K15 / K1500 All Exc. Lift Kit	
R	87	PICKUP 1/2 TON, R1500 All	
R	87	PICKUP 1/2 TON, V1500 All Exc. Lift Kit	
R	75-86	PICKUP 3/4 TON, C25 / C2500 Cab & Chassis	
R	75-86	PICKUP 3/4 TON, C25 / C2500 Standard Cab Pickup	

Numerical listing

Shock	POP	Alternative No.	MTG Acc. Supplied
Pos.	Year	Application	
61524		A (cont)	140357
R	73-74	PICKUP 3/4 TON, C25 / C2500 All Exc. Crew Cab & Bonus Cab	
R	73-86	PICKUP 3/4 TON, K25 / K2500 All Exc. Lift Kit	
R	88-89	PICKUP 3/4 TON, R2500 All Exc. Crew Cab & Bonus Cab	
R	87	PICKUP 3/4 TON, R2500 Cab & Chassis Exc. Crew Cab & Bonus Cab	
R	87	PICKUP 3/4 TON, R2500 Standard Cab Pickup Exc. Crew Cab & Bonus Cab	
R	87	PICKUP 3/4 TON, V2500 All Exc. Lift Kit	
R	73-86	SUBURBAN 1/2 TON, C15 / C1500 All	
R	73-86	SUBURBAN 1/2 TON, K15 / K1500 All Exc. Lift Kit	
R	87-91	SUBURBAN 1/2 TON, R1500 All	
R	87-91	SUBURBAN 1/2 TON, V1500 All Exc. Lift Kit	
R	75-86	SUBURBAN 3/4 TON, C25 / C2500 All	
R	73-74	SUBURBAN 3/4 TON, C25 / C2500 All Exc. Crew Cab & Bonus Cab	
R	73-86	SUBURBAN 3/4 TON, K25 / K2500 All Exc. Lift Kit	
R	87-91	SUBURBAN 3/4 TON, R2500 All	
R	87-91	SUBURBAN 3/4 TON, V2500 All Exc. Lift Kit	
R	73	VAN 1/2 TON, P SERIES All	
R	73-78	VAN 3/4 TON, P SERIES All	
61525		A	140702
F	75-84	CHEVROLET BLAZER RWD	
F	69-74	BLAZER All RWD	
F	63-86	PICKUP 1/2 TON, C10 All	
F	87	PICKUP 1/2 TON, R10 All	
F	63-86	PICKUP 1 TON, C30 All	
F	88-91	PICKUP 1 TON, C35/3500 Cab & Chassis Exc. HD Solid Front Axle	
F	87-88	PICKUP 1 TON, R30 All	
F	89	PICKUP 1 TON, R3500 Standard Cab Pickup	
F	63-86	PICKUP 3/4 TON, C20 All	
F	87-88	PICKUP 3/4 TON, R20 All	
F	89	PICKUP 3/4 TON, R2500 All	
F	63-66	SUBURBAN 1/2 TON, 1500 All	
F	67-86	SUBURBAN 1/2 TON, C10 All	
F	87-88	SUBURBAN 1/2 TON, R10 All	
F	89-91	SUBURBAN 1/2 TON, R1500 All	
F	67-86	SUBURBAN 3/4 TON, C20 All	
F	87-88	SUBURBAN 3/4 TON, R20 All	
F	89-91	SUBURBAN 3/4 TON, R2500 All	
F	63-80	VAN 1/2 TON, P SERIES All	
F	68-90	VAN 1 TON, P SERIES All Cutaway Chassis	
F	68-89	VAN 3/4 TON, P SERIES All	
F	75-84	GMC JIMMY RWD	
F	70-74	JIMMY All RWD	
F	67-86	PICKUP 1/2 TON, C15 / C1500 All	
F	87	PICKUP 1/2 TON, R1500 All	
F	88-91	PICKUP 1 TON, C35/3500 Cab & Chassis HD Solid Front Axle	
F	67-78	PICKUP 1 TON, C35/3500 All	
F	87-91	PICKUP 1 TON, R3500 All	
F	85-86	PICKUP 3/4 TON, C25 / C2500 Crew Cab Pickup	
F	75-86	PICKUP 3/4 TON, C25 / C2500 Cab & Chassis	
F	75-86	PICKUP 3/4 TON, C25 / C2500 Standard Cab Pickup	
F	75-83	PICKUP 3/4 TON, C25 / C2500 Crew Cab Pickup	
F	67-74	PICKUP 3/4 TON, C25 / C2500 All	
F	87-89	PICKUP 3/4 TON, R2500 All Exc. Crew Cab & Bonus Cab	
F	63-66	PICKUP 1000 SERIES All	
F	63-66	PICKUP 1500 SERIES All	
F	66	PICKUP 2500 SERIES All	
F	75-86	SUBURBAN 1/2 TON, C15 / C1500 All	
F	68-74	SUBURBAN 1/2 TON, C15 / C1500 All Coil (FrontSpringType)	
F	87-91	SUBURBAN 1/2 TON, R1500 All	
F	68-86	SUBURBAN 3/4 TON, C25 / C2500 All	
F	87-91	SUBURBAN 3/4 TON, R2500 All	
F	67-80	VAN 1/2 TON, P SERIES All	
F	75-90	VAN 1 TON, P SERIES All Cutaway Chassis	
F	73-74	VAN 1 TON, P SERIES Base Cutaway Chassis	
F	68-72	VAN 1 TON, P SERIES All	

ProGuard

Shock	POP	Alternative No.	MTG Acc. Supplied
Pos.	Year	Application	
61525		A (cont)	140702
F	68-89	VAN 3/4 TON, P SERIES All	
F	63-65	VAN, PB 1000 SERIES All	
61528		A	
R	05	CHEVROLET BLAZER Base, 4WD	
R	05	BLAZER Base, RWD	
R	96-04	BLAZER LS, 4WD	
R	96-04	BLAZER LS, RWD	
R	95-02	BLAZER LT, RWD	
R	95-01	BLAZER LT, 4WD	
R	95-99	BLAZER Base, 4WD	
R	95-99	BLAZER Base, RWD	
R	95-97	BLAZER Deluxe, RWD	
R	83-94	BLAZER, S MODELS All	
R	94-04	S10 LS, 4WD	
R	99-03	S10 Base, RWD	
R	99-03	S10 LS, RWD	
R	83-03	S10 Base, 4WD	
R	92-93	S10 EL, 4WD	
R	83-92	S10 Tahoe, 4WD	
R	88-90	S10 Durango, 4WD	
R	83-86	S10 Durango, 4WD	
R	05	GMC JIMMY 4WD	
R	92-04	JIMMY All	
R	83-91	S15 JIMMY All	
R	82-04	SONOMA / S15 All	
R	91	SYCLONE All	
R	92-93	TYPHOON All	
R	96-00	ISUZU HOMBRE All	
R	96-01	OLDSMOBILE BRAVADA All	
R	91-94	BRAVADA All	
61529		W	140673
F	82	DODGE D50 4WD	
F	87-93	PICKUP, RAM 50 4WD	
F	87-89	RAIDER All	
F	83-94	MITSUBISHI MIGHTY MAX 4WD	
F	83-91	MONTERO All	
F	87-89	TOYOTA VAN RWD	
F	84-86	VAN All	
F	88	VAN WAGON RWD	
61530		B	
R	97	FORD F-250 HD 4WD	
R	80-96	PICKUP 1/2 TON, F-150 4WD Exc. Lift Kit	
R	86-97	PICKUP 1 TON, F-350 / SUPERDUTY 4WD Dual Rear Wheels	
R	82-85	PICKUP 1 TON, F-350 / SUPERDUTY 4WD Clevis Type Lower Front Mount; Exc. Dual Rear Wheels or Lift Kit	
R	80-81	PICKUP 1 TON, F-350 / SUPERDUTY 4WD	
R	97	PICKUP 3/4 TON, F-250 / SUPERDUTY 4WD Over 8500# GVW	
R	87-96	PICKUP 3/4 TON, F-250 / SUPERDUTY 4WD	
R	82-86	PICKUP 3/4 TON, F-250 / SUPERDUTY 4WD Clevis Type Lower Front Mount; Exc. Dual Rear Wheels or Lift Kit	
R	80-81	PICKUP 3/4 TON, F-250 / SUPERDUTY 4WD	
61531		B	
F	05	CHEVROLET BLAZER Base, 4WD	
F	96-04	BLAZER LS, 4WD	
F	95-01	BLAZER LT, 4WD	
F	95-99	BLAZER Base, 4WD	
F	83-94	BLAZER, S MODELS 4WD	
F	94-04	S10 LS, 4WD	
F	83-03	S10 Base, 4WD	
F	92-93	S10 EL, 4WD	
F	83-92	S10 Tahoe, 4WD	
F	88-90	S10 Durango, 4WD	
F	83-86	S10 Durango, 4WD	
F	92-05	GMC JIMMY 4WD	
F	83-91	S15 JIMMY 4WD	
F	83-04	SONOMA / S15 4WD	
F	91	SYCLONE All	
F	92-93	TYPHOON All	
F	99-00	ISUZU HOMBRE 4WD	
F	96-98	HOMBRE All Sport Chassis	
F	96-01	OLDSMOBILE BRAVADA All	
F	91-94	BRAVADA All	
61533		W	
R	89	FORD BRONCO II All Mfg. to 2/89; Vehicles w/ 10mm & 12mm bolt in rear lower mount	
R	84-88	BRONCO II All w/ 10mm Bolt In Rear Lower Mount	

Numerical listing

Shock	POP	Alternative No.	MTG Acc. Supplied
Pos.	Year	Application	
61533		W (cont)	
R	89	RANGER RWD Mfg. to 2/89; Vehicles w/ 10mm bolt in rear lower mount	
R	83-88	RANGER RWD	
61535		A	141353
F	84-01	JEEP CHEROKEE All	
F	86-92	COMANCHE All	
F	93-98	GRAND CHEROKEE All	
F	84-90	WAGONEER All	
61536		A	
R	84-01	JEEP CHEROKEE All	
R	84-90	WAGONEER All	
61539		C	
R	90-05	CHEVROLET ASTRO All	
R	85-89	ASTRO RWD	
R	90-05	GMC SAFARI All	
R	85-89	SAFARI RWD	
R	86-89	VOLKSWAGEN VANAGON 4WD	
61541		W	
R	86-88	FORD AEROSTAR RWD	
R	87-95	JEEP WRANGLER YJ (MfrBodyCode)	
61542		A	
F	99-00	CADILLAC ESCALADE All	
F	90-05	CHEVROLET ASTRO AWD	
F	92-94	BLAZER 4WD Full Size	
F	88-00	PICKUP 1 TON, K35 / K3500 All	
F	88-00	PICKUP 3/4 TON, K25 / K2500 All	
F	92-99	SUBURBAN 1/2 TON, K15 / K1500 All	
F	92-99	SUBURBAN 3/4 TON, K25 / K2500 All	
F	95-00	TAHOE 4WD Old Body Style	
F	88-00	GMC PICKUP 1 TON, K35 / K3500 All	
F	88-00	PICKUP 3/4 TON, K25 / K2500 All	
F	90-05	SAFARI AWD	
F	92-99	SUBURBAN 1/2 TON, K15 / K1500 All	
F	92-99	SUBURBAN 3/4 TON, K25 / K2500 All	
F	92-99	YUKON 4WD	
61543		A	
R	91-02	CHEVROLET C3500HD All Solid Front Axle	
R	88-99	PICKUP 1/2 TON, C15 / C1500 All	
R	88-99	PICKUP 1/2 TON, K15 / K1500 All	
R	88-90	PICKUP 1 TON, C35/3500 Extended Cab Pickup Exc. HD Straight Front Axle	
R	88-90	PICKUP 1 TON, C35/3500 Standard Cab Pickup Exc. HD Straight Front Axle	
R	88-00	PICKUP 1 TON, K35 / K3500 All	
R	88-00	PICKUP 3/4 TON, C25 / C2500 All	
R	88-00	PICKUP 3/4 TON, K25 / K2500 All	
R	01-02	GMC C3500HD All Solid Front Axle	
R	88-99	PICKUP 1/2 TON, C15 / C1500 All	
R	88-99	PICKUP 1/2 TON, K15 / K1500 All	
R	91-00	PICKUP 1 TON, C35/3500 All HD Solid Front Axle	
R	88-90	PICKUP 1 TON, C35/3500 All Exc. HD Straight Front Axle	
R	88-00	PICKUP 1 TON, K35 / K3500 All	
R	88-00	PICKUP 3/4 TON, C25 / C2500 All	
R	88-00	PICKUP 3/4 TON, K25 / K2500 All	
61544		A	141277
F	88-99	CHEVROLET PICKUP 1/2 TON, C15 / C1500 All	
F	92-00	PICKUP 1 TON, C35/3500 Crew Cab Pickup Exc. HD Straight Front Axle	
F	88-00	PICKUP 1 TON, C35/3500 Extended Cab Pickup Exc. HD Straight Front Axle	
F	88-00	PICKUP 1 TON, C35/3500 Standard Cab Pickup Exc. HD Straight Front Axle	
F	88-00	PICKUP 3/4 TON, C25 / C2500 All	
F	92-99	SUBURBAN 1/2 TON, C15 / C1500 All	
F	92-99	SUBURBAN 3/4 TON, C25 / C2500 All	
F	95-00	TAHOE RWD Old Body Style	
F	88-99	GMC PICKUP 1/2 TON, C15 / C1500 All	

Numerical listing

Shock	POP	Alternative No.	MTG Acc. Supplied
Pos.	Year	Application	
61544 A (cont) 141277			
F	92-00	PICKUP 1 TON, C35/3500 Crew Cab Pickup Exc. HD Straight Front Axle	
F	88-00	PICKUP 1 TON, C35/3500 Extended Cab Pickup Exc. HD Straight Front Axle	
F	88-00	PICKUP 1 TON, C35/3500 Standard Cab Pickup Exc. HD Straight Front Axle	
F	88-00	PICKUP 3/4 TON, C25 / C2500 All	
F	92-99	SUBURBAN 1/2 TON, C15 / C1500 All	
F	92-99	SUBURBAN 3/4 TON, C25 / C2500 All	
F	92-99	YUKON RWD	
61546 C 141047			
F	80-96	FORD BRONCO All Quad Suspension; Forward of Front Axle; Exc. Lift Kit	
F	80-96	PICKUP 1/2 TON, F-150 4WD Quad Suspension; Forward of Front Axle; Exc. Lift Kit	
F	80-81	PICKUP 1 TON, F-350 / SUPERDUTY 4WD	
F	80-82	PICKUP 3/4 TON, F-250 / SUPERDUTY 4WD	
61547 W			
R	97	FORD F-250 HD RWD	
R	85-96	PICKUP 1/2 TON, F-150 RWD	
R	80-97	PICKUP 1 TON, F-350 / SUPERDUTY RWD Exc. Dual Rear Wheels	
R	97	PICKUP 3/4 TON, F-250 / SUPERDUTY RWD Over 8500# GVW	
R	80-96	PICKUP 3/4 TON, F-250 / SUPERDUTY RWD	
61550 W			
R	86-95	SUZUKI SAMURAI All	
61552 W 140524			
F	86-95	TOYOTA 4RUNNER All	
F	86-95	PICKUP 4WD Exc. Lift Kit	
F	93-98	T100 4WD	
61554 C			
R	80-96	FORD BRONCO All Exc. Lift Kit	
R	80-83	PICKUP 1/2 TON, F-100 RWD	
R	80-84	PICKUP 1/2 TON, F-150 RWD	
R	88-97	PICKUP 1/2 TON, F SUPERDUTY All	
R	80-97	PICKUP 1 TON, F-350 / SUPERDUTY RWD Dual Rear Wheels	
R	97	PICKUP, F-450 SUPERDUTY All	
61555 C 142615			
F	85-05	CHEVROLET ASTRO RWD	
F	81	BEL AIR Sedan Police and Taxi Models	
F	71-75	BEL AIR Sedan Police and Taxi Models	
F	71-72	BISCAYNE All Police and Taxi Models	
F	73-96	CAPRICE Sedan Police and Taxi Models	
F	71-72	CAPRICE All Police and Taxi Models	
F	83-85	IMPALA All Police and Taxi Models	
F	71-82	IMPALA Sedan Police and Taxi Models	
F	96-02	VAN 1/2 TON, G / EXPRESS All	
F	96-02	VAN 1 TON, G / EXPRESS All	
F	96-02	VAN 3/4 TON, G / EXPRESS All Exc. 8600# GVW	
F	93-02	FORD CROWN VICTORIA Police Interceptor	
F	85-05	GMC SAFARI RWD	
F	96-02	VAN 1/2 TON, G / SAVANA All	
F	96-02	VAN 1 TON, G / SAVANA All	
F	96-02	VAN 3/4 TON, G / SAVANA All Exc. 8600# GVW	
61556 W 140455			
F	79-82	DODGE D50 RWD	
F	83-93	PICKUP, RAM 50 RWD	
F	83-96	MIYUBISHI MIGHTY MAX RWD	
F	79-82	PLYMOUTH PICKUP All	
61559 C			
R	90	FORD BRONCO II All	

ProGuard

Shock	POP	Alternative No.	MTG Acc. Supplied
Pos.	Year	Application	
61559 C (cont)			
R	89	BRONCO II All Mfg. from 2/89; Vehicles w/ 12mm bolt in rear lower mount	
R	90-97	RANGER RWD	
R	89	RANGER RWD Mfg. from 2/89; Vehicles w/ 12mm bolt in rear lower mount	
R	94-97	MAZDA B2300 RWD	
R	94-97	B3000 RWD	
R	94-97	B4000 RWD	
61560 W 141514			
R	92-93	ASUNA SUNRUNNER All	
R	98-04	CHEVROLET TRACKER Non-ABS	
R	89-97	GEO TRACKER All	
R	94-97	PONTIAC SUNRUNNER All	
R	99-05	SUZUKI GRAND VITARA All	
R	89-98	SIDEKICK Non-ABS	
R	99-04	VITARA Non-ABS	
R	96-98	X-90 All	
61561 W 140780			
F	90	FORD BRONCO II All	
F	90-97	RANGER All	
F	94-97	MAZDA B2300 All	
F	94-97	B3000 All	
F	94-97	B4000 RWD	
61565 C			
R	99-00	CADILLAC ESCALADE All	
R	92-94	CHEVROLET BLAZER 4WD Full Size	
R	92-99	SUBURBAN 1/2 TON, C15 / C1500 All	
R	92-99	SUBURBAN 1/2 TON, K15 / K1500 All	
R	92-99	SUBURBAN 3/4 TON, C25 / C2500 All	
R	92-99	SUBURBAN 3/4 TON, K25 / K2500 All	
R	95-00	TAHOE All Old Body Style	
R	03-11	VAN 1/2 TON, G / EXPRESS All Exc. Upfitter Package and Cutaway Chassis	
R	96-02	VAN 1/2 TON, G / EXPRESS All	
R	97-02	VAN 1 TON, G / EXPRESS All	
R	96	VAN 1 TON, G / EXPRESS All Exc. 8600# GVW	
R	96-02	VAN 3/4 TON, G / EXPRESS All Exc. 8600# GVW	
R	92-99	GMC SUBURBAN 1/2 TON, C15 / C1500 All	
R	92-99	SUBURBAN 1/2 TON, K15 / K1500 All	
R	92-99	SUBURBAN 3/4 TON, C25 / C2500 All	
R	92-99	SUBURBAN 3/4 TON, K25 / K2500 All	
R	03-11	VAN 1/2 TON, G / SAVANA All Exc. Upfitter Package and Cutaway Chassis	
R	96-02	VAN 1/2 TON, G / SAVANA All	
R	96-02	VAN 1 TON, G / SAVANA All Exc. 8600# GVW	
R	96-02	VAN 3/4 TON, G / SAVANA All Exc. 8600# GVW	
R	92-99	YUKON All	
61573 W			
R	90-97	FORD RANGER 4WD	
R	89	RANGER 4WD High Ryder Option	
R	95-96	MAZDA B2300 4WD	
61575 W			
R	93-98	JEEP GRAND CHEROKEE All	
61582 W			
R	93-98	TOYOTA T100 4WD	
61584 W			
R	87-96	DODGE DAKOTA 4WD	
61590 W 140719			
R	91-94	FORD EXPLORER All	
R	91-94	MAZDA NAVAJO All	
61591 D 140780			
F	91-94	FORD EXPLORER All	
F	92-11	VAN 1/2 TON, ECONOLINE / CLUB WAGON All	
F	92-11	VAN 1 TON, ECONOLINE / CLUB WAGON / SUPERDUTY All	
F	92-02	VAN 3/4 TON, ECONOLINE / CLUB WAGON / SUPERDUTY All	
F	91-94	MAZDA NAVAJO All	

Numerical listing

Shock	POP	Alternative No.	MTG Acc. Supplied
Pos.	Year	Application	
61592 W 142389			
R	94-97	HONDA PASSPORT All	
R	91-97	ISUZU RODEO All	
R	98-03	TOYOTA SIENNA All	
61593 W 140524			
F	94-02	HONDA PASSPORT All	
F	98-00	ISUZU AMIGO All	
F	02-04	AXIOM All	
F	91-04	RODEO All	
F	87-91	TROOPER 4WD	
F	86-87	MAZDA B2000 RWD	
F	87-93	B2200 RWD	
F	87-93	B2600 RWD	
F	87-90	MIYUBISHI VAN All	
F	87-95	NISSAN PATHFINDER All Exc. Electronic Adjustable Suspension	
61595 W 140780			
R	92-11	FORD VAN 1/2 TON, ECONOLINE / CLUB WAGON All	
61599 W 143000			
F	94-01	DODGE PICKUP 1/2 TON, RAM 1500 (SEE RAM 1500) RWD	
F	94-02	PICKUP 1 TON, RAM 3500 (SEE RAM 3500) RWD Exc. Solid Front Axle	
F	94-02	PICKUP 3/4 TON, RAM 2500 (SEE RAM 2500) RWD	
61600 A			
R	99-07	CHEVROLET PICKUP 1/2 TON, SILVERADO 1500 RWD Exc. Electronic Adjustable Suspension	
R	94-01	DODGE PICKUP 1/2 TON, RAM 1500 (SEE RAM 1500) All	
R	94-02	PICKUP 1 TON, RAM 3500 (SEE RAM 3500) RWD Exc. Solid Front Axle	
R	94-03	PICKUP 3/4 TON, RAM 2500 (SEE RAM 2500) All Exc. 8800# GVW	
R	99-07	GMC SIERRA 1500 RWD Exc. Electronic Adjustable Suspension	
61601 C 140126			
F	97-04	DODGE DAKOTA 4WD	
F	98-03	DURANGO 4WD	
61605 A			
R	96-07	CHRYSLER TOWN & COUNTRY All Exc. Hydraulic Self-Leveling System	
R	00-03	VOYAGER / GRAND VOYAGER All Exc. Hydraulic Self-Leveling System	
R	00	VOYAGER / GRAND VOYAGER Non-ABS Exc. Hydraulic Self-Leveling System	
R	96-07	DODGE CARAVAN / GRAND CARAVAN All Exc. Hydraulic Self-Leveling System	
R	96-00	PLYMOUTH VOYAGER / GRAND VOYAGER All Exc. Hydraulic Self-Leveling System	
61606 C 140673			
F	01-04	TOYOTA TACOMA S-Runner	
F	04	TACOMA Base, RWD	
F	95-03	TACOMA DLX, RWD	
61608 W 140169			
R	96-99	ACURA SLX All	
R	92-02	ISUZU TROOPER All	
R	99-01	VEHICROSS All	
61609 W 141137			
R	97-99	INFINITI QX4 All Mfg. to 12/98	
R	98-99	NISSAN PATHFINDER All Mfg. to 12/98	
R	96-97	PATHFINDER All	
61611 C 142731			
F	97-02	FORD EXPEDITION RWD Exc. Front Air- Leveling	
F	97-03	LOBO RWD	
F	97-04	PICKUP 1/2 TON, F-150 RWD	
F	96-99	PICKUP 3/4 TON, F-250 / SUPERDUTY RWD Up through 8500# GVW	
F	98-02	LINCOLN NAVIGATOR Coil (FrontSpringType)	
61612 W 142700			
R	98-03	FORD LOBO 4WD	
R	97-04	PICKUP 1/2 TON, F-150 4WD	

Numerical listing

ProGuard

Numerical listing

Shock	POP	Alternative No.	MTG Acc. Supplied
Pos.	Year	Application	
61612	W (cont)		142700
R	97-99	PICKUP 3/4 TON, F-250 / SUPERDUTY 4WD Up through 8500# GVW	
61613	D		142731
F	97-02	FORD EXPEDITION 4WD Exc. Front Air- Leveling	
F	98-03	LOBO 4WD	
F	04	PICKUP 1/2 TON, F-150 4WD Exc. 7000# GVW	
F	97-03	PICKUP 1/2 TON, F-150 4WD	
F	97-99	PICKUP 3/4 TON, F-250 / SUPERDUTY 4WD Up through 8500# GVW	
61614	W		
R	97-02	FORD EXPEDITION All F-250 HD 4WD	
F	97	F-250 HD 4WD	
F	86-97	PICKUP 1 TON, F-350 / SUPERDUTY 4WD	
F	97-98	PICKUP 3/4 TON, F-250 / SUPERDUTY 4WD Over 8500# GVW	
F	87-96	PICKUP 3/4 TON, F-250 / SUPERDUTY 4WD	
R	98-02	LINCOLN NAVIGATOR RWD	
61615	W		141665
F	97-06	JEEP WRANGLER TJ (MfrBodyCode)	
61616	W		
R	97-06	JEEP WRANGLER TJ (MfrBodyCode)	
61623	A		142277
F	95-01	FORD EXPLORER All Exc. Adjustable Suspension	
F	01-05	EXPLORER SPORT TRAC All	
F	98-11	RANGER Torsion Bar (FrontSpringType)	
F	06-07	MAZDA B3000 All 4WD	
F	05	B3000 4WD	
F	03-04	B3000 All 4WD	
F	98-02	B3000 4WD	
F	98-09	B4000 4WD	
F	97-01	MERCURY MOUNTAINEER All Exc. Electronic Adjustable Suspension	
61624	A		140719
R	95-01	FORD EXPLORER All Exc. Adjustable Suspension	
R	01-05	EXPLORER SPORT TRAC All	
R	97-01	MERCURY MOUNTAINEER All Exc. Electronic Adjustable Suspension	
61625	W		
R	95-03	FORD WINDSTAR Coil (RearSpringType)	
61626	A		141665
F	06-11	FORD RANGER RWD, Coil (FrontSpringType)	
F	01-05	RANGER XL, RWD, Coil (FrontSpringType)	
F	01-05	RANGER XLT, RWD, Coil (FrontSpringType)	
F	01-02	RANGER EV, RWD Coil (FrontSpringType)	
F	98-00	RANGER XL, RWD	
F	98-00	RANGER XLT, RWD	
F	01-09	MAZDA B2300 RWD	
F	98-01	B2500 RWD	
F	98-07	B3000 RWD	
F	98-09	B4000 RWD	
61627	A		
R	06-11	FORD RANGER RWD, Coil (FrontSpringType)	
R	98-05	RANGER XL, RWD	
R	98-05	RANGER XLT, RWD	
R	05	RANGER STX, RWD	
R	04	RANGER Tremor, RWD	
R	02	RANGER Postal, RWD	
R	01-09	MAZDA B2300 RWD	
R	98-01	B2500 RWD	
R	98-07	B3000 RWD	
R	98-09	B4000 RWD	
61629	D		
R	06-11	FORD RANGER RWD, Torsion Bar (FrontSpringType)	
R	98-11	RANGER 4WD	

Shock	POP	Alternative No.	MTG Acc. Supplied
Pos.	Year	Application	
61629	D (cont)		
R	03-07	MAZDA B3000 All 4WD	
R	98-02	B3000 4WD	
R	98-09	B4000 4WD	
61632	W		
F	81-93	DODGE PICKUP 1/2 TON, W100 SERIES All Exc. Lift Kit	
F	61-80	PICKUP 1/2 TON, W100 SERIES All	
F	81-93	PICKUP 1 TON, W300 SERIES All Exc. Quad Suspension and Lift Kit	
F	61-80	PICKUP 1 TON, W300 SERIES All	
R	61-71	PICKUP 1 TON, W300 SERIES All	
F	90-93	PICKUP 3/4 TON, W200 SERIES Extended Cab Pickup Exc. Lift Kit	
F	88-93	PICKUP 3/4 TON, W200 SERIES Cab & Chassis Exc. Lift Kit	
F	81-93	PICKUP 3/4 TON, W200 SERIES Standard Cab Pickup Exc. Lift Kit	
F	86	PICKUP 3/4 TON, W200 SERIES Cab & Chassis Exc. Lift Kit	
F	81-83	PICKUP 3/4 TON, W200 SERIES Cab & Chassis Exc. Lift Kit	
F	81-82	PICKUP 3/4 TON, W200 SERIES Extended Cab Pickup Exc. Lift Kit	
F	69-80	PICKUP 3/4 TON, W200 SERIES All	
F	61-67	PICKUP 3/4 TON, W200 SERIES All	
F	75-93	RAMCHARGER 4WD	
F	74	RAMCHARGER All 4WD	
F	75-81	PLYMOUTH TRAILDUSTER 4WD	
F	74	TRAILDUSTER All	
61634	W		142731
F	94-01	DODGE PICKUP 1/2 TON, RAM 1500 (SEE RAM 1500) 4WD	
F	94-02	PICKUP 3/4 TON, RAM 2500 (SEE RAM 2500) 4WD Exc. 8800# GVW	
61635	C		142731
F	94-02	DODGE PICKUP 1 TON, RAM 3500 (SEE RAM 3500) 4WD	
F	94-02	PICKUP 1 TON, RAM 3500 (SEE RAM 3500) RWD Solid Front Axle	
F	94-02	PICKUP 3/4 TON, RAM 2500 (SEE RAM 2500) 4WD 8800# GVW	
61638	C		142700
R	00-03	FORD LOBO Harley-Davidson Edition, RWD	
R	00-03	LOBO XLT, RWD	
R	00	LOBO Base, RWD	
R	00	LOBO Lariat, RWD	
R	97-98	LOBO RWD	
R	04	PICKUP 1/2 TON, F-150 RWD	
R	00-03	PICKUP 1/2 TON, F-150 Harley-Davidson Edition, RWD	
R	99-03	PICKUP 1/2 TON, F-150 Lariat, RWD	
R	99-03	PICKUP 1/2 TON, F-150 XL, RWD	
R	99-03	PICKUP 1/2 TON, F-150 XLT, RWD	
R	00	PICKUP 1/2 TON, F-150 Base, RWD	
R	97-98	PICKUP 1/2 TON, F-150 RWD	
R	97-99	PICKUP 3/4 TON, F-250 / SUPERDUTY RWD Up through 8500# GVW	
61641	A		141665
F	99-07	CHEVROLET PICKUP 1/2 TON, SILVERADO 1500 RWD Exc. Electronic Adjustable Suspension	
F	99-04	PICKUP 3/4 TON, SILVERADO 2500 RWD Exc. Electronic Adjustable Suspension	
F	01-04	PICKUP 3/4 TON, SILVERADO 2500 HD RWD	
F	99-07	GMC SIERRA 1500 RWD Exc. Electronic Adjustable Suspension	
F	99-04	SIERRA 2500 RWD Exc. Electronic Adjustable Suspension	
F	01-04	SIERRA 2500 HD RWD	
61642	A		
R	07	CHEVROLET PICKUP 1/2 TON, SILVERADO 1500 4WD Old Body Style; Exc. Electronic Adjustable Suspension	
R	99-06	PICKUP 1/2 TON, SILVERADO 1500 4WD Exc. Electronic Adjustable Suspension	
R	05-06	PICKUP 1/2 TON, SILVERADO 1500 HD All	
R	01-03	PICKUP 1/2 TON, SILVERADO 1500 HD All	
R	77-86	PICKUP 1 TON, K30 All	
R	90-91	PICKUP 1 TON, R3500 All	

Shock	POP	Alternative No.	MTG Acc. Supplied
Pos.	Year	Application	
61642	A (cont)		
R	89	PICKUP 1 TON, R3500 Cab & Chassis, RWD	
R	89	PICKUP 1 TON, R3500 Crew Cab Pickup, RWD	
R	01-09	PICKUP 1 TON, SILVERADO 3500 All	
R	07-10	PICKUP 1 TON, SILVERADO 3500 HD All	
R	87-88	PICKUP 1 TON, V30 All	
R	89-91	PICKUP 1 TON, V3000 / V3500 All	
R	99-08	PICKUP 3/4 TON, SILVERADO 2500 All	
R	01-10	PICKUP 3/4 TON, SILVERADO 2500 HD All	
R	07	SILVERADO 1500 HD CLASSIC 4WD	
R	07	SILVERADO 2500 HD CLASSIC All	
R	94-02	DODGE PICKUP 1 TON, RAM 3500 (SEE RAM 3500) 4WD	
R	94-02	PICKUP 1 TON, RAM 3500 (SEE RAM 3500) RWD Solid Front Axle	
R	94-02	PICKUP 3/4 TON, RAM 2500 (SEE RAM 2500) 4WD 8800# GVW	
R	77-86	GMC PICKUP 1 TON, K35 / K3500 All	
R	87-91	PICKUP 1 TON, V3000 / V3500 All	
R	07	SIERRA 1500 4WD Old Body Style; Exc. Electronic Adjustable Suspension	
R	99-06	SIERRA 1500 4WD Exc. Electronic Adjustable Suspension	
R	05-06	SIERRA 1500 HD All	
R	01-03	SIERRA 1500 HD All	
R	07	SIERRA 1500 HD CLASSIC All	
R	99-04	SIERRA 2500 All	
R	01-10	SIERRA 2500 HD All	
R	01-06	SIERRA 3500 All	
R	07	SIERRA 3500 CLASSIC All	
R	07-10	SIERRA 3500 HD All	
61643	A		141665
F	02-06	CHEVROLET AVALANCHE 1500 All Exc. Electronic Ride Control	
F	07	PICKUP 1/2 TON, SILVERADO 1500 4WD Old Body Style; Exc. Electronic Adjustable Suspension	
F	99-06	PICKUP 1/2 TON, SILVERADO 1500 4WD Exc. Electronic Adjustable Suspension	
F	00-06	SUBURBAN 1/2 TON, 1500 All Exc. Z55 Auto Ride Suspension	
F	02-06	TAHOE All Exc. Z55 Auto Ride Suspension	
F	00-01	TAHOE All New Body Style; Exc. Z55 Auto Ride Suspension	
F	07	GMC SIERRA 1500 4WD Old Body Style; Exc. Electronic Adjustable Suspension	
F	99-06	SIERRA 1500 4WD Exc. Electronic Adjustable Suspension	
F	00-06	YUKON All Exc. Z55 Auto Ride Suspension	
F	00-06	YUKON XL 1/2 TON All Exc. Z55 Auto Ride Suspension	
61646	W		142617
R	00-02	FORD E-450 ECONOLINE SUPER DUTY All	
R	00-06	ECONOLINE All	
R	12-14	VAN 1/2 TON, ECONOLINE / CLUB WAGON All	
R	21-22	VAN 1 TON, ECONOLINE / CLUB WAGON / SUPERDUTY All	
R	92-19	VAN 1 TON, ECONOLINE / CLUB WAGON / SUPERDUTY All	
R	04-11	VAN 1 TON, ECONOLINE / CLUB WAGON / SUPERDUTY All Exc. Cutaway Chassis	
R	92-14	VAN 3/4 TON, ECONOLINE / CLUB WAGON / SUPERDUTY All	
61651	W		142389
R	00	TOYOTA RAV4 All Mfg. to 5/00	
R	96-99	RAV4 All	
61654	D		
R	99-04	FORD PICKUP 1 TON, F-350 / SUPERDUTY RWD	
R	99-04	PICKUP 3/4 TON, F-250 / SUPERDUTY RWD	
61655	B		
R	02	FORD E-550 ECONOLINE SUPER DUTY All	
R	03	E-550 SUPER DUTY All	

Numerical listing

Shock	POP	Alternative No.	MTG Acc. Supplied
Pos.	Year	Application	
61655	B (cont)		
F	99-04	PICKUP 1 TON, F-350 / SUPERDUTY 4WD	
F	99-04	PICKUP 3/4 TON, F-250 / SUPERDUTY 4WD	
F	99-04	PICKUP, F-450 SUPERDUTY All	
F	99-04	PICKUP, F-550 SUPERDUTY All	
61656	B		
R	99-04	FORD PICKUP 1 TON, F-350 / SUPERDUTY 4WD	
R	99-04	PICKUP 3/4 TON, F-250 / SUPERDUTY 4WD	
61658	C		
R	97-04	DODGE DAKOTA All	
R	98-03	DURANGO 4WD	
R	98-03	DURANGO RWD	
61659	B		
R	02-05	CHEVROLET VENTURE All	
R	97-01	VENTURE FWD	
R	02-04	OLDSMOBILE SILHOUETTE AWD	
R	97-04	SILHOUETTE FWD	
R	99-05	PONTIAC MONTANA All Exc. Air-Leveling Suspension	
R	97-98	TRANS SPORT All	
61662	D		142389
F	00-04	NISSAN FRONTIER Crew Cab Pickup, RWD w/ Desert Runner	
F	98-04	FRONTIER 4WD	
F	98-99	FRONTIER RWD Crew Cab; w/ Desert Runner Package	
F	00-04	XTERRA All	
61663	A		141665
F	02-06	CHEVROLET AVALANCHE 2500 All Exc. Electronic Ride Control	
F	05-06	PICKUP 1/2 TON, SILVERADO 1500 HD All	
F	01-03	PICKUP 1/2 TON, SILVERADO 1500 HD All	
F	01-09	PICKUP 1 TON, SILVERADO 3500 All	
F	07-10	PICKUP 1 TON, SILVERADO 3500 HD All	
F	05-08	PICKUP 3/4 TON, SILVERADO 2500 All	
F	99-04	PICKUP 3/4 TON, SILVERADO 2500 4WD	
F	01-10	PICKUP 3/4 TON, SILVERADO 2500 HD All 9200# GVW	
F	07	SILVERADO 1500 HD CLASSIC All	
F	07	SILVERADO 2500 HD CLASSIC All	
F	00-11	SUBURBAN 3/4 TON, 2500 All Exc. Z55 Auto Ride Suspension and QuadraSteer	
F	16-19	SUBURBAN 3500 HD All	
F	05-06	GMC SIERRA 1500 HD All	
F	01-03	SIERRA 1500 HD All	
F	07	SIERRA 1500 HD CLASSIC All	
F	99-04	SIERRA 2500 4WD	
F	01-10	SIERRA 2500 HD All	
F	01-06	SIERRA 3500 All	
F	07	SIERRA 3500 CLASSIC All	
F	07-10	SIERRA 3500 HD Torsion Bar (FrontSpringType)	
F	00-06	YUKON XL 3/4 TON All Exc. Hydraulic Self-Leveling System	
F	03-09	HUMMER H2 All	
61664	A		141353
F	99-04	JEEP GRAND CHEROKEE All Exc. Up Country Suspension	
61675	A		
R	02-13	CADILLAC ESCALADE All Exc. Electronic Ride Control	
R	03-10	ESCALADE ESV All Exc. Electronic Ride Control	
R	02-10	ESCALADE EXT All Exc. Electronic Ride Control	
R	07-13	CHEVROLET AVALANCHE 1500 All Exc. Z55 or ZW7 Ride Suspension	
R	02-06	AVALANCHE 1500 All Exc. Electronic Ride Control	
R	02-06	AVALANCHE 2500 All Exc. Electronic Ride Control	
R	07-11	SUBURBAN 1/2 TON, 1500 All Exc. Z55 or ZW7 Ride Suspension	
R	00-06	SUBURBAN 1/2 TON, 1500 All Exc. Z55 Auto Ride Suspension	
R	00-11	SUBURBAN 3/4 TON, 2500 All Exc. Z55 Auto Ride Suspension and QuadraSteer	

ProGuard

Shock	POP	Alternative No.	MTG Acc. Supplied
Pos.	Year	Application	
61675	A (cont)		
R	07-11	TAHOE All Exc. Z55 or ZW7 Ride Suspension	
R	02-06	TAHOE All Exc. Z55 Auto Ride Suspension	
R	00-01	TAHOE All New Body Style; Exc. Z55 Auto Ride Suspension	
R	07-11	GMC YUKON All Exc. Z55 or ZW7 Ride Suspension	
R	00-06	YUKON All Exc. Z55 Auto Ride Suspension	
R	07-11	YUKON XL 1/2 TON All Exc. Z55 or ZW7 Ride Suspension	
R	00-06	YUKON XL 1/2 TON All Exc. Z55 Auto Ride Suspension	
R	00-11	YUKON XL 3/4 TON All Exc. Z55 Auto Ride Suspension and QuadraSteer	
61676	D		
R	99-04	JEEP GRAND CHEROKEE All	
61679	W		140126
F	87-96	DODGE DAKOTA 4WD	
61680	A		142731
F	05-16	FORD PICKUP 1 TON, F-350 / SUPERDUTY 4WD	
F	05-16	PICKUP 3/4 TON, F-250 / SUPERDUTY 4WD	
61682	A		
R	13-16	FORD PICKUP 1 TON, F-350 / SUPERDUTY 4WD w/ Off Road Package	
R	05-12	PICKUP 1 TON, F-350 / SUPERDUTY Crew Cab Pickup, 4WD Single Rear Wheels	
R	05-12	PICKUP 1 TON, F-350 / SUPERDUTY Extended Cab Pickup, 4WD Single Rear Wheels	
R	05-12	PICKUP 1 TON, F-350 / SUPERDUTY Standard Cab Pickup, 4WD Single Rear Wheels	
R	12-16	PICKUP 3/4 TON, F-250 / SUPERDUTY RWD w/ Off Road Package	
R	05-16	PICKUP 3/4 TON, F-250 / SUPERDUTY 4WD	
61683	W		143276
F	10-14	CHEVROLET VAN 1/2 TON, G / EXPRESS AWD, Torsion Bar (FrontSpringType)	
F	03-09	VAN 1/2 TON, G / EXPRESS Torsion Bar (FrontSpringType)	
F	06-12	VAN 3/4 TON, G / EXPRESS All Torsion Bar (FrontSpringType)	
F	03-05	VAN 3/4 TON, G / EXPRESS Torsion Bar (FrontSpringType)	
F	10-14	GMC VAN 1/2 TON, G / SAVANA AWD, Torsion Bar (FrontSpringType)	
F	04-09	VAN 1/2 TON, G / SAVANA Torsion Bar (FrontSpringType)	
F	03	VAN 1/2 TON, G / SAVANA Torsion Bar (FrontSpringType) Torsion Bar (FrontSpringType)	
F	06-12	VAN 3/4 TON, G / SAVANA All Torsion Bar (FrontSpringType)	
F	03-05	VAN 3/4 TON, G / SAVANA AWD, Torsion Bar (FrontSpringType)	
61684	C		143276
F	03-14	CHEVROLET VAN 1/2 TON, G / EXPRESS RWD, Coil (FrontSpringType)	
F	03-14	GMC VAN 1/2 TON, G / SAVANA RWD, Coil (FrontSpringType)	
61685	B		143078
F	09-22	CHEVROLET EXPRESS 4500 All	
F	17-22	VAN 1 TON, G / EXPRESS All	
F	03-16	VAN 1 TON, G / EXPRESS Coil (FrontSpringType)	
F	17-22	VAN 3/4 TON, G / EXPRESS All	
F	03-16	VAN 3/4 TON, G / EXPRESS Coil (FrontSpringType)	
F	14-20	GMC SAVANA 4500 All	
F	17-22	VAN 1 TON, G / SAVANA All	
F	03-16	VAN 1 TON, G / SAVANA Coil (FrontSpringType)	
F	17-22	VAN 3/4 TON, G / SAVANA All	
F	03-16	VAN 3/4 TON, G / SAVANA Coil (FrontSpringType)	

Numerical listing

Shock	POP	Alternative No.	MTG Acc. Supplied
Pos.	Year	Application	
61687	B		
R	09-22	CHEVROLET EXPRESS 4500 All	
R	13-22	VAN 1 TON, G / EXPRESS All	
R	03-12	VAN 1 TON, G / EXPRESS All Single Rear Wheels	
R	03-22	VAN 3/4 TON, G / EXPRESS All	
R	10-20	GMC SAVANA 4500 All	
R	13-22	VAN 1 TON, G / SAVANA All	
R	03-12	VAN 1 TON, G / SAVANA All Single Rear Wheels	
R	03-22	VAN 3/4 TON, G / SAVANA All	
61690	B		
R	18-21	CHEVROLET PICKUP 1/2 TON, SILVERADO 1500 All	
R	08-17	PICKUP 1/2 TON, SILVERADO 1500 All Exc. Electronic Adjustable Suspension	
R	07	PICKUP 1/2 TON, SILVERADO 1500 Base Exc. Electronic Adjustable Suspension	
R	07	PICKUP 1/2 TON, SILVERADO 1500 LT Exc. Electronic Adjustable Suspension	
R	07	PICKUP 1/2 TON, SILVERADO 1500 LTZ Exc. Electronic Adjustable Suspension	
R	07	PICKUP 1/2 TON, SILVERADO 1500 WT Exc. Electronic Adjustable Suspension	
R	19	SILVERADO 1500 LD All	
R	18-21	GMC SIERRA 1500 All	
R	08-17	SIERRA 1500 All Exc. Electronic Adjustable Suspension	
R	07	SIERRA 1500 Denali Exc. Electronic Adjustable Suspension	
R	07	SIERRA 1500 SLE Exc. Electronic Adjustable Suspension	
R	07	SIERRA 1500 SLT Exc. Electronic Adjustable Suspension	
R	07	SIERRA 1500 WT Exc. Electronic Adjustable Suspension	
R	19	SIERRA 1500 LIMITED All	
61691	B		
R	06-08	DODGE PICKUP 1/2 TON, RAM 1500 (SEE RAM 1500) Crew Cab Pickup, 4WD	
R	06-08	PICKUP 1/2 TON, RAM 1500 (SEE RAM 1500) Standard Cab Pickup, 4WD	
R	02-05	PICKUP 1/2 TON, RAM 1500 (SEE RAM 1500) 4WD	
61692	B		
R	06-08	DODGE PICKUP 1/2 TON, RAM 1500 (SEE RAM 1500) Crew Cab Pickup, RWD	
R	06-08	PICKUP 1/2 TON, RAM 1500 (SEE RAM 1500) Standard Cab Pickup, RWD	
R	02-05	PICKUP 1/2 TON, RAM 1500 (SEE RAM 1500) RWD	
61696	B		
R	07-17	JEEP WRANGLER All Exc. Models w/ 17" Wheels	
61697	B		
R	16-17	JEEP WRANGLER All Models w/ 17" Wheels; w/Heavy Duty Suspension	
R	07-15	WRANGLER All Models w/ 17" Wheels	
61699	B		140149
R	98-04	TOYOTA TACOMA Pre Runner Left	
61700	B		140149
R	98-04	TOYOTA TACOMA Pre Runner Right	
61703	B		
R	98-02	LINCOLN NAVIGATOR 4WD, Air (RearSpringType)	
61704	B		
R	01-06	ACURA MDX All	
R	03-08	HONDA PILOT All	
61710	B		
R	03-07	DODGE PICKUP 1 TON, RAM 3500 (SEE RAM 3500) Crew Cab Pickup, RWD	
R	03-08	PICKUP 3/4 TON, RAM 2500 (SEE RAM 2500) Crew Cab Pickup, RWD	

Numerical listing

Shock	POP	Alternative No.	MTG Acc. Supplied
Pos.	Year		Application
61711	B		142973
F	07-17	JEEP	WRANGLER All
61712	W		142731
F	06-08	DODGE	PICKUP 1/2 TON, RAM 1500 (SEE RAM 1500) 4WD Mega Cab
61713	B		
R	05-16	FORD	PICKUP 1 TON, F-350 / SUPERDUTY RWD Exc. Off Road
R	05-16	PICKUP	3/4 TON, F-250 / SUPERDUTY RWD Exc. Off Road
61714	B		142731
F	05-08	DODGE	PICKUP 3/4 TON, RAM 2500 (SEE RAM 2500) 4WD
61715	B		
R	06-10	JEEP	COMMANDER All
R	05-10	GRAND CHEROKEE	All
61716	B		
R	03-10	DODGE	PICKUP 3/4 TON, RAM 2500 (SEE RAM 2500) 4WD
R	11-13	RAM	2500 (SEE DODGE RAM 2500) 4WD
61717	B		
R	04-07	BUICK	RAINIER All
R	06-09	CHEVROLET	TRAILBLAZER Air (RearSpringType)
R	02-05	TRAILBLAZER	All Air(RearSpringType)
R	02-09	GMC	ENVOY All
R	03-08	ISUZU	ASCENDER Coil (RearSpringType)
R	02-04	OLDSMOBILE	BRAVADA All
R	05-09	SAAB	9-7X All
61718	B		
R	05-13	CHEVROLET	EQUINOX All
R	10-13	GMC	TERRAIN All
R	06-09	PONTIAC	TORRENT All
R	07-09	SUZUKI	XL-7 All Exc. 3rd Row Seating
61720	B		
F	07-09	CHRYSLER	ASPEN All
F	04-09	DODGE	DURANGO All
61734	B		
R	04-09	DODGE	DURANGO All
61777	B		
R	02-07	BUICK	RENDEZVOUS All Exc. Hydraulic Self-Leveling System
R	01-05	PONTIAC	AZTEK AWD
Ultra Truck Shock			
G63173	W		
R	93-98	TOYOTA	T100 RWD
G63183	D		
R	74	DODGE	M300 All
F	81-93	PICKUP	1/2 TON, W100 SERIES All Exc. Lift Kit
F	61-80	PICKUP	1/2 TON, W100 SERIES All
F	81-93	PICKUP	1 TON, W300 SERIES All Exc. Quad Suspension and Lift Kit
F	61-80	PICKUP	1 TON, W300 SERIES All
F	61-71	PICKUP	1 TON, W300 SERIES All
F	90-93	PICKUP	3/4 TON, W200 SERIES Extended Cab Pickup Exc. Lift Kit
F	88-93	PICKUP	3/4 TON, W200 SERIES Cab & Chassis Exc. Lift Kit
F	81-93	PICKUP	3/4 TON, W200 SERIES Standard Cab Pickup Exc. Lift Kit
F	86	PICKUP	3/4 TON, W200 SERIES Cab & Chassis Exc. Lift Kit
F	81-83	PICKUP	3/4 TON, W200 SERIES Cab & Chassis Exc. Lift Kit
F	81-82	PICKUP	3/4 TON, W200 SERIES Extended Cab Pickup Exc. Lift Kit
F	69-80	PICKUP	3/4 TON, W200 SERIES All
F	61-67	PICKUP	3/4 TON, W200 SERIES All
F	75-93	RAMCHARGER	4WD
F	74	RAMCHARGER	All 4WD
F	78-80	RD200	All
F	75-81	PLYMOUTH	TRAILDUSTER 4WD
F	74	TRAILDUSTER	All
G63299	W		140885
R	61-67	FORD	ECONOLINE All
F	72-81	JEEP	CJ5 All Exc. Lift Kit
F	72-75	CJ6	All Exc. Lift Kit

ProGuard, Ultra Truck Shock

Shock	POP	Alternative No.	MTG Acc. Supplied
Pos.	Year		Application
G63299	W (cont)		140885
F	76-81	CJ7	All Exc. Lift Kit
F	66-74	DJ5	All Exc. Lift Kit
F	81	SCRAMBLER / CJ8	All
R	71-74	WAGONEER	All
R	63-67	WAGONEER	All
R	97-02	MERCURY	VILLAGER Non-ABS
R	93-96	VILLAGER	4-Wheel ABS
R	93-02	NISSAN	QUEST All
F	76-83	TOYOTA	LAND CRUISER FJ40 (MfrBodyCode)
F	75	LAND CRUISER	FJ40 (MfrBodyCode) Mfg. to 2/75
F	67-74	LAND CRUISER	All
G63306	C		
R	69-72	CHEVROLET	BLAZER RWD
R	63-72	PICKUP	1/2 TON, C10 All Leaf(RearSpringType)
R	67-72	PICKUP	1 TON, C30 All Exc. 11,000# Rear Axle
R	63-72	PICKUP	3/4 TON, C20 All
R	63-66	SUBURBAN	1/2 TON, 1500 All
R	67-77	VAN	1/2 TON, G / EXPRESS All
R	63-66	VAN	1/2 TON, P SERIES All
R	76-77	VAN	1 TON, G / EXPRESS All
R	75	VAN	1 TON, G / EXPRESS 110.0 / 279.4 (WheelBase)
R	75	VAN	1 TON, G / EXPRESS 125.0 / 317.5 (WheelBase)
R	71-74	VAN	1 TON, G / EXPRESS All
R	68-72	VAN	1 TON, P SERIES All Exc. 11,000# Rear Axle
R	67-77	VAN	3/4 TON, G / EXPRESS All
R	68-72	VAN	3/4 TON, P SERIES All
R	70-72	GMC	JIMMY All RWD
R	68-72	PICKUP	1/2 TON, C15 / C1500 All RWD
R	67	PICKUP	1/2 TON, C15 / C1500 All
R	67-72	PICKUP	1 TON, C35/3500 All Exc. 11,000# Rear Axle
R	72	PICKUP	3/4 TON, C25 / C2500 All Leaf(RearSpringType)
R	71	PICKUP	3/4 TON, C25 / C2500 All
R	67-70	PICKUP	3/4 TON, C25 / C2500 All Leaf(RearSpringType)
R	63-65	PICKUP	1000 SERIES All
R	63-65	PICKUP	1500 SERIES All
R	67-77	VAN	1/2 TON, G / SAVANA All
R	67	VAN	1/2 TON, P SERIES All
R	76-77	VAN	1 TON, G / SAVANA All
R	75	VAN	1 TON, G / SAVANA 110.0 / 279.4 (WheelBase)
R	75	VAN	1 TON, G / SAVANA 125.0 / 317.5 (WheelBase)
R	71-74	VAN	1 TON, G / SAVANA All
R	68-72	VAN	1 TON, P SERIES All Exc. 11,000# Rear Axle
R	67-77	VAN	3/4 TON, G / SAVANA All
R	68-72	VAN	3/4 TON, P SERIES All
R	63-65	VAN,	PB 1000 SERIES All
G63347	C (cont)		
F	69-86	PICKUP	3/4 TON, K25 / K2500 All Exc. Quad Suspension and Lift Kit
F	87	PICKUP	3/4 TON, V2500 All Exc. Lift Kit
F	69-86	SUBURBAN	1/2 TON, K15 / K1500 All Exc. Quad Suspension and Lift Kit
F	87-91	SUBURBAN	1/2 TON, V1500 All Exc. Lift Kit
F	69-86	SUBURBAN	3/4 TON, K25 / K2500 All Exc. Quad Suspension and Lift Kit
F	87-91	SUBURBAN	3/4 TON, V2500 All Exc. Lift Kit
G63349	A		140357
R	87-91	CHEVROLET	BLAZER 4WD Full Size; Exc. Lift Kit
R	85-86	BLAZER	4WD Exc. Lift Kit
R	73-84	BLAZER	All Exc. Lift Kit
R	75-86	PICKUP	1/2 TON, C10 All
R	73-86	PICKUP	1/2 TON, K10 All Exc. Lift Kit
R	87	PICKUP	1/2 TON, R10 All
R	87	PICKUP	1/2 TON, V10 All Exc. Lift Kit
R	75-86	PICKUP	3/4 TON, C20 Standard Cab Pickup
R	75-86	PICKUP	3/4 TON, K20 All Exc. Lift Kit
R	87	PICKUP	3/4 TON, R20 Standard Cab Pickup
R	87	PICKUP	3/4 TON, V20 All Exc. Quad Suspension and Lift Kit
R	73-86	SUBURBAN	1/2 TON, C10 All
R	73-86	SUBURBAN	1/2 TON, K10 All Exc. Lift Kit
R	87-88	SUBURBAN	1/2 TON, R10 All
R	89-91	SUBURBAN	1/2 TON, R1500 All
R	89-91	SUBURBAN	1/2 TON, V1500 All Exc. Lift Kit
R	73-86	SUBURBAN	3/4 TON, C20 All
R	73-86	SUBURBAN	3/4 TON, K20 All Exc. Lift Kit
R	87-88	SUBURBAN	3/4 TON, R20 All
R	89-91	SUBURBAN	3/4 TON, R2500 All
R	87-88	SUBURBAN	3/4 TON, V20 All Exc. Quad Suspension and Lift Kit
R	89-91	SUBURBAN	3/4 TON, V2500 All Exc. Lift Kit
R	73	VAN	1/2 TON, P SERIES All
R	73-78	VAN	3/4 TON, P SERIES All
R	73-91	GMC	JIMMY All Exc. Lift Kit
R	73-86	PICKUP	1/2 TON, C15 / C1500 All
R	73-86	PICKUP	1/2 TON, K15 / K1500 All Exc. Lift Kit
R	87	PICKUP	1/2 TON, R1500 All
R	87	PICKUP	1/2 TON, V1500 All Exc. Lift Kit
R	75-86	PICKUP	3/4 TON, C25 / C2500 Cab & Chassis
R	75-86	PICKUP	3/4 TON, C25 / C2500 Standard Cab Pickup
R	73-74	PICKUP	3/4 TON, C25 / C2500 All Exc. Crew Cab & Bonus Cab
R	73-86	PICKUP	3/4 TON, K25 / K2500 All Exc. Lift Kit
R	88-89	PICKUP	3/4 TON, R2500 All Exc. Crew Cab & Bonus Cab
R	87	PICKUP	3/4 TON, R2500 Cab & Chassis Exc. Crew Cab & Bonus Cab
R	87	PICKUP	3/4 TON, R2500 Standard Cab Pickup Exc. Crew Cab & Bonus Cab
R	87	PICKUP	3/4 TON, V2500 All Exc. Lift Kit
R	73-86	SUBURBAN	1/2 TON, C15 / C1500 All
R	73-86	SUBURBAN	1/2 TON, K15 / K1500 All Exc. Lift Kit
R	87-91	SUBURBAN	1/2 TON, R1500 All
R	87-91	SUBURBAN	1/2 TON, V1500 All Exc. Lift Kit
R	75-86	SUBURBAN	3/4 TON, C25 / C2500 All
R	73-74	SUBURBAN	3/4 TON, C25 / C2500 All Exc. Crew Cab & Bonus Cab
R	73-86	SUBURBAN	3/4 TON, K25 / K2500 All Exc. Lift Kit
R	87-91	SUBURBAN	3/4 TON, R2500 All
R	87-91	SUBURBAN	3/4 TON, V2500 All Exc. Lift Kit
R	73	VAN	1/2 TON, P SERIES All

Numerical listing

Shock	POP	Alternative No.	MTG Acc. Supplied
Pos.	Year		Application

Numerical listing

Shock	POP	Alternative No.	MTG Acc. Supplied
Pos.	Year	Application	
G63349	A (cont)		140357
R	73-78	VAN 3/4 TON, P SERIES All	
G63350	C		140126
R	66	FORD BRONCO All Thru Serial #830000	
R	75-79	PICKUP 1/2 TON, F-100 RWD	
R	70-74	PICKUP 1/2 TON, F-100 All RWD	
R	75-79	PICKUP 1/2 TON, F-150 RWD	
R	75-79	PICKUP 1 TON, F-350 / SUPERDUTY Extended Cab Pickup, RWD	
R	67-74	PICKUP 1 TON, F-350 / SUPERDUTY All Extended Cab	
R	75-79	PICKUP 3/4 TON, F-250 / SUPERDUTY Cab & Chassis, RWD	
R	75-79	PICKUP 3/4 TON, F-250 / SUPERDUTY Standard Cab Pickup, RWD	
R	65-74	PICKUP 3/4 TON, F-250 / SUPERDUTY All Exc. Supercab	
R	75-91	VAN 1/2 TON, ECONOLINE / CLUB WAGON All	
F	71-80	INTERNATIONAL SCOUT II All	
G63353	D		
R	72-93	DODGE PICKUP 1/2 TON, D100 SERIES All	
R	72-93	PICKUP 1 TON, D300 SERIES All	
R	72-93	PICKUP 3/4 TON, D200 SERIES All	
R	75-93	RAMCHARGER RWD	
R	74	RAMCHARGER All	
R	76-81	PLYMOUTH TRAILDUSTER RWD	
R	74-75	TRAILDUSTER All	
G63355	A		140702
F	75-84	CHEVROLET BLAZER RWD	
F	69-74	BLAZER All RWD	
F	63-86	PICKUP 1/2 TON, C10 All	
F	87	PICKUP 1/2 TON, R10 All	
F	63-86	PICKUP 1 TON, C30 All	
F	88-91	PICKUP 1 TON, C35/3500 Cab & Chassis Exc. HD Solid Front Axle	
F	87-88	PICKUP 1 TON, R30 All	
F	89	PICKUP 1 TON, R3500 Standard Cab Pickup	
F	63-86	PICKUP 3/4 TON, C20 All	
F	87-88	PICKUP 3/4 TON, R20 All	
F	89	PICKUP 3/4 TON, R2500 All	
F	63-66	SUBURBAN 1/2 TON, 1500 All	
F	67-86	SUBURBAN 1/2 TON, C10 All	
F	87-88	SUBURBAN 1/2 TON, R10 All	
F	89-91	SUBURBAN 1/2 TON, R1500 All	
F	68-86	SUBURBAN 3/4 TON, C20 All	
F	87-88	SUBURBAN 3/4 TON, R20 All	
F	89-91	SUBURBAN 3/4 TON, R2500 All	
F	63-80	VAN 1/2 TON, P SERIES All	
F	68-90	VAN 1 TON, P SERIES All Cutaway Chassis	
F	68-89	VAN 3/4 TON, P SERIES All	
F	75-84	GMC JIMMY RWD	
F	70-74	JIMMY All RWD	
F	67-86	PICKUP 1/2 TON, C15 / C1500 All	
F	87	PICKUP 1/2 TON, R1500 All	
F	88-90	PICKUP 1 TON, C35/3500 Cab & Chassis Exc. HD Solid Front Axle	
F	67-78	PICKUP 1 TON, C35/3500 All	
F	87-91	PICKUP 1 TON, R3500 All	
F	85-86	PICKUP 3/4 TON, C25 / C2500 Crew Cab Pickup	
F	75-86	PICKUP 3/4 TON, C25 / C2500 Cab & Chassis	
F	75-86	PICKUP 3/4 TON, C25 / C2500 Standard Cab Pickup	
F	75-83	PICKUP 3/4 TON, C25 / C2500 Crew Cab Pickup	
F	67-74	PICKUP 3/4 TON, C25 / C2500 All	
F	87-89	PICKUP 3/4 TON, R2500 All Exc. Crew Cab & Bonus Cab	
F	63-66	PICKUP 1000 SERIES All	
F	63-66	PICKUP 1500 SERIES All	
F	66	PICKUP 2500 SERIES All	
F	68-86	SUBURBAN 1/2 TON, C15 / C1500 All	
F	87-91	SUBURBAN 1/2 TON, R1500 All	
F	68-86	SUBURBAN 3/4 TON, C25 / C2500 All	
F	87-91	SUBURBAN 3/4 TON, R2500 All	
F	67-80	VAN 1/2 TON, P SERIES All	
F	75-90	VAN 1 TON, P SERIES All Cutaway Chassis	
F	73-74	VAN 1 TON, P SERIES Base Cutaway Chassis	
F	68-72	VAN 1 TON, P SERIES All	
F	68-89	VAN 3/4 TON, P SERIES All	

Ultra Truck Shock

Shock	POP	Alternative No.	MTG Acc. Supplied
Pos.	Year	Application	
G63355	A (cont)		140702
F	63-65	VAN, PB 1000 SERIES All	
G63357	C		
F	71-95	CHEVROLET VAN 1/2 TON, G / EXPRESS All	
F	70	VAN 1/2 TON, G / EXPRESS All Independent Front Suspension	
F	76-96	VAN 1 TON, G / EXPRESS All	
F	75	VAN 1 TON, G / EXPRESS 146.0 / 370.8 (WheelBase)	
F	71-74	VAN 1 TON, G / EXPRESS All	
F	71-95	VAN 3/4 TON, G / EXPRESS All	
F	70	VAN 3/4 TON, G / EXPRESS All Independent Front Suspension	
F	71-95	GMC VAN 1/2 TON, G / SAVANA All	
F	70	VAN 1/2 TON, G / SAVANA All Independent Front Suspension	
F	76-95	VAN 1 TON, G / SAVANA All	
F	75	VAN 1 TON, G / SAVANA 146.0 / 370.8 (WheelBase)	
F	71-74	VAN 1 TON, G / SAVANA All	
F	78-95	VAN 3/4 TON, G / SAVANA All Exc. 8600# GVW	
F	71-77	VAN 3/4 TON, G / SAVANA All	
F	70	VAN 3/4 TON, G / SAVANA All Independent Front Suspension	
G63359	C		140126
F	84-86	DODGE MINI RAM All	
F	72-93	PICKUP 1/2 TON, D100 SERIES All	
F	72-93	PICKUP 3/4 TON, D200 SERIES All Exc. Heavy Duty Package	
F	75-93	RAMCHARGER RWD	
F	99-03	VAN 1/2 TON, A / B SERIES / RAM 109.3 / 277.6 (WheelBase) Exc. 7000# GVW	
F	81-98	VAN 1/2 TON, A / B SERIES / RAM 109.6 / 278.4 (WheelBase) Exc. 7000# GVW	
F	71-80	VAN 1/2 TON, A / B SERIES / RAM All Exc. 4000# Front Axle	
F	99-03	VAN 1 TON, A / B SERIES / RAM All	
F	71-98	VAN 1 TON, A / B SERIES / RAM All Exc. 4000# Front Axle	
F	81-03	VAN 3/4 TON, A / B SERIES / RAM All	
F	71-80	VAN 3/4 TON, A / B SERIES / RAM All Exc. 4000# Front Axle	
F	74-80	VAN, CB300 All Exc. 4000# Front Axle	
F	75-81	PLYMOUTH TRAILDUSTER RWD	
F	74-83	VAN 1/2 TON, PB SERIES All	
F	74-83	VAN 1 TON, PB SERIES All Exc. 4000# Front Axle	
F	74-83	VAN 3/4 TON, PB SERIES All	
G63360	D		140126
F	72-93	DODGE PICKUP 1 TON, D300 SERIES All Heavy Duty Package	
F	72-93	PICKUP 3/4 TON, D200 SERIES All Heavy Duty Package	
F	71-93	VAN 1 TON, A / B SERIES / RAM All 4000# Front Axle	
F	74-80	VAN, CB300 All 4000# Front Axle	
F	74-83	PLYMOUTH VAN 1 TON, PB SERIES All 4000# Front Axle	
G63366	A		
R	75-86	CHEVROLET PICKUP 1 TON, C30 All	
R	88-91	PICKUP 1 TON, C35/3500 Cab & Chassis Exc. HD Solid Front Axle	
R	87-88	PICKUP 1 TON, R30 All	
R	89	PICKUP 1 TON, R3500 Standard Cab Pickup	
R	75-86	PICKUP 3/4 TON, C20 Crew Cab Pickup	
R	87-88	PICKUP 3/4 TON, R20 Crew Cab Pickup	
R	89	PICKUP 3/4 TON, R2500 All	
R	74-80	VAN 1/2 TON, P SERIES All	
R	73-99	VAN 1 TON, P SERIES All	
R	79-89	VAN 3/4 TON, P SERIES All	
R	88-91	GMC PICKUP 1 TON, C35/3500 Cab & Chassis Exc. HD Solid Front Axle	
R	73-78	PICKUP 1 TON, C35/3500 All	
R	87-91	PICKUP 1 TON, R3500 All	
R	85-86	PICKUP 3/4 TON, C25 / C2500 Crew Cab Pickup	
R	75-83	PICKUP 3/4 TON, C25 / C2500 Crew Cab Pickup	
R	73-74	PICKUP 3/4 TON, C25 / C2500 All Crew Cab	

Numerical listing

Shock	POP	Alternative No.	MTG Acc. Supplied
Pos.	Year	Application	
G63366	A (cont)		
R	87-89	PICKUP 3/4 TON, R2500 Crew Cab Pickup	
R	74-80	VAN 1/2 TON, P SERIES All	
R	73-99	VAN 1 TON, P SERIES All	
R	79-89	VAN 3/4 TON, P SERIES All	
G63375	A		140780,142615
F	85-05	CHEVROLET ASTRO RWD	
F	81	BEL AIR Sedan Police and Taxi Models	
F	71-75	BEL AIR Sedan Police and Taxi Models	
F	71-72	BISCAYNE All	
F	73-96	CAPRICE Sedan Police and Taxi Models	
F	71-72	CAPRICE All Police and Taxi Models	
F	83-85	IMPALA All Police and Taxi Models	
F	71-82	IMPALA Sedan Police and Taxi Models	
F	96-02	VAN 1/2 TON, G / EXPRESS All	
F	96-02	VAN 1 TON, G / EXPRESS All	
F	96-02	VAN 3/4 TON, G / EXPRESS All Exc. 8600# GVW	
F	93-02	FORD CROWN VICTORIA Police Interceptor	
F	85-05	GMC SAFARI RWD	
F	96-02	VAN 1/2 TON, G / SAVANA RWD	
F	96-02	VAN 1 TON, G / SAVANA All	
F	96-02	VAN 3/4 TON, G / SAVANA All Exc. 8600# GVW	
G63377	B		141137
R	78-79	FORD BRONCO All Exc. Lift Kit	
R	66-77	BRONCO All From Serial #830001; Exc. Lift Kit	
R	65-69	PICKUP 1/2 TON, F-100 All RWD	
R	75-79	PICKUP 1 TON, F-350 / SUPERDUTY Standard Cab Pickup, RWD	
R	73-74	PICKUP 1 TON, F-350 / SUPERDUTY All RWD; Supercab	
R	75-79	PICKUP 3/4 TON, F-250 / SUPERDUTY Extended Cab Pickup, RWD	
R	65-74	PICKUP 3/4 TON, F-250 / SUPERDUTY All RWD; Supercab	
R	69-74	VAN 1/2 TON, ECONOLINE / CLUB WAGON All	
R	69-74	VAN 1 TON, ECONOLINE / CLUB WAGON / SUPERDUTY All	
R	69-74	VAN 3/4 TON, ECONOLINE / CLUB WAGON / SUPERDUTY All	
R	76-83	JEEP CHEROKEE All	
F	74-83	CHEROKEE All	
F	82-83	CJ5 All Exc. Lift Kit	
F	82-86	CJ7 All Exc. Lift Kit	
F	93	GRAND WAGONEER All	
R	93	GRAND WAGONEER All	
F	84-91	GRAND WAGONEER All	
R	84-91	GRAND WAGONEER All	
F	74-88	J10 PICKUP All	
R	74-88	J10 PICKUP All	
F	74-88	J20 PICKUP All	
R	74-88	J20 PICKUP All	
F	82-85	SCRAMBLER / CJ8 All	
R	76-83	WAGONEER All	
F	74-83	WAGONEER All	
G63386	A		140780
F	66-77	FORD BRONCO All From Serial #830001; Exc. Lift Kit RWD, 4WD Quad Suspension Rearward of Front Axle, Non Quad Suspension	
F	75-79	PICKUP 1/2 TON, F-100 RWD RWD, 4WD Quad Suspension Rearward of Front Axle, Non Quad Suspension	
F	65-74	PICKUP 1/2 TON, F-100 All RWD, 4WD Quad Suspension Rearward of Front Axle, Non Quad Suspension	
F	75-79	PICKUP 1/2 TON, F-150 RWD RWD, 4WD Quad Suspension Rearward of Front Axle, Non Quad Suspension	
F	75-79	PICKUP 1 TON, F-350 / SUPERDUTY RWD RWD, 4WD Quad Suspension Rearward of Front Axle, Non Quad Suspension	
F	67-74	PICKUP 1 TON, F-350 / SUPERDUTY All RWD, 4WD Quad Suspension Rearward of Front Axle, Non Quad Suspension	

Numerical listing

Shock	POP	Alternative No.	MTG Acc. Supplied
Pos.	Year	Application	
G63386 A (cont) 140780			
F	75-79	PICKUP 3/4 TON, F-250 / SUPERDUTY RWD RWD, 4WD Quad Suspension Rearward of Front Axle, Non Quad Suspension	
F	65-74	PICKUP 3/4 TON, F-250 / SUPERDUTY All RWD, 4WD Quad Suspension Rearward of Front Axle, Non Quad Suspension	
F	75-91	VAN 1 TON, ECONOLINE / CLUB WAGON / SUPERDUTY All Cutaway Chassis RWD, 4WD Quad Suspension Rearward of Front Axle, Non Quad Suspension	
F	75-91	VAN 3/4 TON, ECONOLINE / CLUB WAGON / SUPERDUTY All RWD, 4WD Quad Suspension Rearward of Front Axle, Non Quad Suspension	
G63387 D 140126			
R	75-76	FORD PICKUP 1/2 TON, F-100 4WD Exc. Lift Kit	
R	70-74	PICKUP 1/2 TON, F-100 All 4WD; Exc. Lift Kit	
R	76-79	PICKUP 1/2 TON, F-150 4WD Exc. Lift Kit	
R	75	PICKUP 1/2 TON, F-150 All 4WD; Exc. Lift Kit	
R	79	PICKUP 1 TON, F-350 / SUPERDUTY 4WD	
R	77-79	PICKUP 3/4 TON, F-250 / SUPERDUTY Cab & Chassis, 4WD All From Serial No. Y20001	
R	77-79	PICKUP 3/4 TON, F-250 / SUPERDUTY Standard Cab Pickup, 4WD All From Serial No. Y20001	
R	75-91	VAN 1 TON, ECONOLINE / CLUB WAGON / SUPERDUTY All Cutaway Chassis	
R	75-91	VAN 3/4 TON, ECONOLINE / CLUB WAGON / SUPERDUTY All	
G63394 C 140702			
F	85-99	CHEVROLET VAN 1 TON, P SERIES All Motorhome Chassis w/ Independent Front Suspension	
F	74-84	VAN 1 TON, P SERIES All Motorhome Chassis	
F	85-99	GMC VAN 1 TON, P SERIES All Motorhome Chassis w/ Independent Front Suspension	
F	75-84	VAN 1 TON, P SERIES All Motorhome Chassis	
F	74	VAN 1 TON, P SERIES Motorhome	
G63403 A			
R	79-91	CHEVROLET VAN 1 TON, G / EXPRESS All 9200# GVW	
F	85	VAN 1 TON, P SERIES All Motorhome Chassis w/ I-Beam Front Suspension	
R	97-04	DODGE DAKOTA All	
R	98-03	DURANGO All	
R	93-96	GMC VAN 1 TON, G / SAVANA Cutaway Van 9200# GVW	
R	79-91	VAN 1 TON, G / SAVANA Cutaway Van 9200# GVW	
F	85	VAN 1 TON, P SERIES All Motorhome Chassis w/ I-Beam Front Suspension	
G63404 W 141349			
F	84-85	TOYOTA 4RUNNER All	
F	80-85	PICKUP 4WD Exc. Lift Kit	
G63405 D 140884			
F	55-56	CHEVROLET PICKUP All	
R	61-64	FORD PICKUP 1/2 TON, F-100 All	
R	61-66	PICKUP 1 TON, F-350 / SUPERDUTY All	
R	61-64	PICKUP 3/4 TON, F-250 / SUPERDUTY All	
F	68-76	PICKUP P350 All Up through 8000# GVW	
F	75-76	PICKUP P400 All Up through 8000# GVW	
R	68	INTERNATIONAL 908C All	
R	68	1000C All Exc. 166" Wheelbase	
F	68	1100C All Exc. 166" Wheelbase	
R	68	1100C All Exc. 166" Wheelbase	
F	68	1200C All Exc. 166" Wheelbase	
R	68	1200C All Exc. 166" Wheelbase	
F	68	1300C All Exc. 166" Wheelbase	
R	68	1300C All Exc. 166" Wheelbase	
R	68-72	M1100 / M1200 All	
R	69	M1400 All	

Ultra Truck Shock

Shock	POP	Alternative No.	MTG Acc. Supplied
Pos.	Year	Application	
G63405 D (cont) 140884			
R	65	JEEP CJ3 All Exc. Lift Kit	
R	65-83	CJ5 All Exc. Lift Kit	
R	65-75	CJ6 All Exc. Lift Kit	
R	76-86	CJ7 All Exc. Lift Kit	
R	66-74	DJ5 All Exc. Lift Kit	
R	66-68	DJ6 All Exc. Lift Kit	
R	57-60	FC150 All	
F	63-65	FC170 All	
R	63-65	FC170 All	
R	63-66	GLADIATOR All Independent Front Suspension	
R	70-71	JEEPSTER All	
R	81-85	SCRAMBLER / CJ8 All	
R	65-67	UNIVERSAL All Exc. Lift Kit	
R	61-64	UNIVERSAL All	
G63406 B			
R	97	FORD F-250 HD RWD	
R	85-96	PICKUP 1/2 TON, F-150 RWD	
R	80-97	PICKUP 1 TON, F-350 / SUPERDUTY RWD Exc. Dual Rear Wheels	
R	97	PICKUP 3/4 TON, F-250 / SUPERDUTY RWD Over 8500# GVW	
R	80-96	PICKUP 3/4 TON, F-250 / SUPERDUTY RWD	
G63409 C			
R	80-96	FORD BRONCO All Exc. Lift Kit	
R	80-83	PICKUP 1/2 TON, F-100 RWD	
R	80-84	PICKUP 1/2 TON, F-150 RWD	
R	88-97	PICKUP 1/2 TON, F SUPERDUTY All	
R	80-97	PICKUP 1 TON, F-350 / SUPERDUTY RWD Dual Rear Wheels	
R	97	PICKUP, F-450 SUPERDUTY All	
G63410 C 141047			
F	80-96	FORD BRONCO All Quad Suspension; Forward of Front Axle; Exc. Lift Kit	
F	80-96	PICKUP 1/2 TON, F-150 4WD Quad Suspension; Forward of Front Axle; Exc. Lift Kit	
F	80-81	PICKUP 1 TON, F-350 / SUPERDUTY 4WD	
F	80-82	PICKUP 3/4 TON, F-250 / SUPERDUTY Standard Cab Pickup, 4WD	
G63411 C			
F	77-86	CHEVROLET PICKUP 1 TON, K30 All	
F	90-91	PICKUP 1 TON, R3500 All	
F	89	PICKUP 1 TON, R3500 Cab & Chassis	
F	89	PICKUP 1 TON, R3500 Crew Cab Pickup	
F	87-88	PICKUP 1 TON, V30 All	
F	89-91	PICKUP 1 TON, V3000 / V3500 All	
F	77-86	GMC PICKUP 1 TON, K35 / K3500 All	
F	87-91	PICKUP 1 TON, V3000 / V3500 All	
G63413 B			
R	78-95	CHEVROLET VAN 1/2 TON, G / EXPRESS All	
R	85-95	VAN 1 TON, G / EXPRESS Extended Cargo Van	
R	85-95	VAN 1 TON, G / EXPRESS Extended Passenger Van	
R	78-95	VAN 1 TON, G / EXPRESS Standard Cargo Van	
R	78-95	VAN 1 TON, G / EXPRESS Standard Passenger Van	
R	78	VAN 1 TON, G / EXPRESS Extended Cargo Van	
R	78-95	VAN 3/4 TON, G / EXPRESS All Exc. 8600# GVW	
R	84-86	DODGE MINI RAM All	
R	99-03	VAN 1/2 TON, A / B SERIES / RAM 109.3 / 277.6 (WheelBase) Exc. 7000# GVW	
R	81-98	VAN 1/2 TON, A / B SERIES / RAM 109.6 / 278.4 (WheelBase) Exc. 7000# GVW	
R	71-80	VAN 1/2 TON, A / B SERIES / RAM All	
R	99-03	VAN 1 TON, A / B SERIES / RAM All	
R	94-98	VAN 1 TON, A / B SERIES / RAM All Exc. 4000# Front Axle	
R	71-93	VAN 1 TON, A / B SERIES / RAM All	

Numerical listing

Shock	POP	Alternative No.	MTG Acc. Supplied
Pos.	Year	Application	
G63413 B (cont)			
R	71-03	VAN 3/4 TON, A / B SERIES / RAM All	
R	74-80	VAN, CB300 All	
R	78-95	GMC VAN 1/2 TON, G / SAVANA All	
R	85-96	VAN 1 TON, G / SAVANA Extended Cargo Van	
R	85-96	VAN 1 TON, G / SAVANA Extended Passenger Van	
R	79-96	VAN 1 TON, G / SAVANA Standard Cargo Van	
R	79-96	VAN 1 TON, G / SAVANA Standard Passenger Van	
R	78	VAN 1 TON, G / SAVANA Cutaway Van	
R	78-95	VAN 3/4 TON, G / SAVANA All Exc. 8600# GVW	
R	74-83	PLYMOUTH VAN 1/2 TON, PB SERIES All	
R	74-83	VAN 1 TON, PB SERIES All	
R	74-83	VAN 3/4 TON, PB SERIES All	
G63414 A 140780			
F	80-96	FORD BRONCO All Rearward of Front Axle; Exc. Lift Kit	
F	89	BRONCO II All Mfg. to 2/89; Vehicles w/ 10mm & 12mm bolt in rear lower mount	
F	84-88	BRONCO II All w/ 10mm Bolt In Rear Lower Mount	
F	97	F-250 HD RWD	
F	80-83	PICKUP 1/2 TON, F-100 RWD	
F	80-96	PICKUP 1/2 TON, F-150 4WD Rearward of Front Axle; Exc. Lift Kit	
F	80-96	PICKUP 1/2 TON, F-150 RWD	
F	80-97	PICKUP 1 TON, F-350 / SUPERDUTY RWD	
F	97	PICKUP 3/4 TON, F-250 / SUPERDUTY RWD Over 8500# GVW	
F	80-96	PICKUP 3/4 TON, F-250 / SUPERDUTY RWD	
F	87-89	RANGER All Exc. High Ryder Option	
F	83-86	RANGER All	
G63418 W 141356			
F	82	DODGE D50 4WD	
F	83-86	PICKUP, RAM 50 4WD	
F	87-89	RAIDER All	
F	83-94	MITSUBISHI MIGHTY MAX 4WD	
F	83-91	MONTERO All	
G63419 W			
R	82	DODGE D50 4WD	
R	87-93	PICKUP, RAM 50 4WD	
R	83-94	MITSUBISHI MIGHTY MAX 4WD	
G63421 A 140455			
F	05	CHEVROLET BLAZER Base, RWD	
F	96-04	BLAZER LS, RWD	
F	95-02	BLAZER LT, RWD	
F	95-99	BLAZER Base, RWD	
F	95-97	BLAZER Deluxe, RWD	
F	83-94	BLAZER, S MODELS RWD	
F	94-03	S10 LS, RWD	
F	82-03	S10 Base, RWD	
F	99	S10 Xtreme, RWD	
F	92-93	S10 EL, RWD	
F	83-92	S10 Tahoe, RWD	
F	88-90	S10 Durango, RWD	
F	82-86	S10 Durango, RWD	
F	72-82	FORD COURIER All	
F	92-04	GMC JIMMY RWD	
F	83-91	S15 JIMMY RWD	
F	04	SONOMA / S15 All RWD	
F	82-03	SONOMA / S15 RWD	
F	78-87	SPRINT / CABALLERO RWD	
F	71-77	SPRINT / CABALLERO All	
F	96-00	ISUZU HOMBRE RWD Exc. Sport Chassis	
F	72-76	MAZDA B1600 All	
F	77-78	B1800 All	
F	79-84	B2000 All	
F	82-84	B2200 All	
G63422 A			
R	05	CHEVROLET BLAZER Base, 4WD	
R	05	BLAZER Base, RWD	
R	96-04	BLAZER LS, 4WD	
R	96-04	BLAZER LS, RWD	
R	95-02	BLAZER LT, RWD	
R	95-01	BLAZER LT, 4WD	
R	95-99	BLAZER Base, 4WD	
R	95-99	BLAZER Base, RWD	
R	95-97	BLAZER Deluxe, RWD	

Numerical listing

Shock	POP	Alternative No.	MTG Acc. Supplied
Pos.	Year	Application	
G63422 A (cont)			
R	83-94	BLAZER, S MODELS All	
R	94-04	S10 LS, 4WD	
R	83-03	S10 Base, 4WD	
R	92-93	S10 EL, 4WD	
R	83-92	S10 Tahoe, 4WD	
R	88-90	S10 Durango, 4WD	
R	83-86	S10 Durango, 4WD	
R	05	GMC JIMMY 4WD	
R	92-04	JIMMY All	
R	83-91	S15 JIMMY All	
R	82-04	SONOMA / S15 All	
R	91	SYCLONE All	
R	92-93	TYPHOON All	
R	96-00	ISUZU HOMBRE All	
R	96-01	OLDSMOBILE BRAVADA All	
R	91-94	BRAVADA All	
G63423 A			
F	05	CHEVROLET BLAZER Base, 4WD	
F	96-04	BLAZER LS, 4WD	
F	95-01	BLAZER LT, 4WD	
F	95-99	BLAZER Base, 4WD	
F	83-94	BLAZER, S MODELS 4WD	
F	94-04	S10 LS, 4WD	
F	83-03	S10 Base, 4WD	
F	92-93	S10 EL, 4WD	
F	83-92	S10 Tahoe, 4WD	
F	88-90	S10 Durango, 4WD	
F	83-86	S10 Durango, 4WD	
F	92-05	GMC JIMMY 4WD	
F	83-91	S15 JIMMY 4WD	
F	83-04	SONOMA / S15 4WD	
F	91	SYCLONE All	
F	92-93	TYPHOON All	
F	00	ISUZU HOMBRE 4WD	
F	96-99	HOMBRE All Sport Chassis	
F	96-01	OLDSMOBILE BRAVADA All	
F	91-94	BRAVADA All	
G63424 B 141353,142592			
F	84-01	JEEP CHEROKEE All	
F	86-92	COMANCHE All	
F	93-98	GRAND CHEROKEE All	
F	84-90	WAGONEER All	
G63425 B			
R	84-01	JEEP CHEROKEE All	
R	84-90	WAGONEER All	
G63426 W			
R	90-95	CHRYSLER TOWN & COUNTRY All	
R	84-95	DODGE CARAVAN / GRAND CARAVAN All	
R	87-88	MINI RAM All	
R	84-95	PLYMOUTH VOYAGER / GRAND VOYAGER All	
G63432 W 141349,140169			
F	88-90	TOYOTA LAND CRUISER All	
F	81-87	LAND CRUISER FJ60 (MfrBodyCode), Sport Utility	
G63443 W			
R	82-83	JEEP CJ5 All 2" Lift Kit	
F	66-81	CJ5 All 2 - 4" Lift Kit	
F	66-75	CJ6 All 2 - 4" Lift Kit	
R	82-86	CJ7 All 2" Lift Kit	
F	76-81	CJ7 All 2 - 4" Lift Kit	
F	66-74	DJ5 All 2 - 4" Lift Kit	
F	66-68	DJ6 All 2 - 4" Lift Kit	
F	65-67	UNIVERSAL All 2 - 4" Lift Kit	
G63454 A			
R	90-05	CHEVROLET ASTRO All	
R	85-89	ASTRO RWD	
R	90-05	GMC SAFARI All	
R	85-89	SAFARI RWD	
R	86-89	VOLKSWAGEN VANAGON 4WD	
G63455 C			
F	97	FORD F-250 HD 4WD	
F	86-97	PICKUP 1 TON, F-350 / SUPERDUTY 4WD	
F	97-98	PICKUP 3/4 TON, F-250 / SUPERDUTY 4WD Over 8500# GVW	
F	87-96	PICKUP 3/4 TON, F-250 / SUPERDUTY 4WD	
G63456 W			
R	86-97	FORD PICKUP 1 TON, F-350 / SUPERDUTY 4WD Exc. Dual Rear Wheels	

Ultra Truck Shock

Shock	POP	Alternative No.	MTG Acc. Supplied
Pos.	Year	Application	
G63461 B			
R	97	FORD F-250 HD 4WD	
R	80-96	PICKUP 1/2 TON, F-150 4WD Exc. Lift Kit	
R	86-97	PICKUP 1 TON, F-350 / SUPERDUTY 4WD Dual Rear Wheels	
R	82-85	PICKUP 1 TON, F-350 / SUPERDUTY 4WD Clevis Type Lower Front Mount; Exc. Dual Rear Wheels or Lift Kit	
R	80-81	PICKUP 1 TON, F-350 / SUPERDUTY 4WD	
R	97	PICKUP 3/4 TON, F-250 / SUPERDUTY 4WD Over 8500# GVW	
R	86-96	PICKUP 3/4 TON, F-250 / SUPERDUTY 4WD	
R	82-85	PICKUP 3/4 TON, F-250 / SUPERDUTY 4WD Clevis Type Lower Front Mount; Exc. Dual Rear Wheels or Lift Kit	
R	80-81	PICKUP 3/4 TON, F-250 / SUPERDUTY 4WD	
G63479 W 140524			
F	86-89	TOYOTA 4RUNNER All	
F	86-95	PICKUP 4WD Exc. Lift Kit	
F	93-98	T100 4WD	
G63488 A			
R	88-99	CHEVROLET PICKUP 1/2 TON, C15 / C1500 All	
R	88-99	PICKUP 1/2 TON, K15 / K1500 All	
R	92-00	PICKUP 1 TON, C35/3500 Crew Cab Pickup Exc. HD Straight Front Axle	
R	92-00	PICKUP 1 TON, C35/3500 Standard Cab Pickup Exc. HD Straight Front Axle	
R	88-00	PICKUP 1 TON, C35/3500 Extended Cab Pickup Exc. HD Straight Front Axle	
R	88-90	PICKUP 1 TON, C35/3500 Standard Cab Pickup Exc. HD Straight Front Axle	
R	88-00	PICKUP 1 TON, K35 / K3500 All	
R	88-00	PICKUP 3/4 TON, C25 / C2500 All	
R	88-99	GMC PICKUP 1/2 TON, C15 / C1500 All	
R	88-99	PICKUP 1/2 TON, K15 / K1500 All	
R	92-00	PICKUP 1 TON, C35/3500 Crew Cab Pickup Exc. HD Straight Front Axle	
R	88-00	PICKUP 1 TON, C35/3500 Extended Cab Pickup Exc. HD Straight Front Axle	
R	88-00	PICKUP 1 TON, C35/3500 Standard Cab Pickup Exc. HD Straight Front Axle	
R	88-00	PICKUP 1 TON, K35 / K3500 All	
R	88-00	PICKUP 3/4 TON, C25 / C2500 All	
R	88-00	PICKUP 3/4 TON, K25 / K2500 All	
G63489 A 141277			
F	88-99	CHEVROLET PICKUP 1/2 TON, C15 / C1500 All	
F	92-00	PICKUP 1 TON, C35/3500 Crew Cab Pickup Exc. HD Straight Front Axle	
F	88-00	PICKUP 1 TON, C35/3500 Extended Cab Pickup Exc. HD Straight Front Axle	
F	88-00	PICKUP 1 TON, C35/3500 Standard Cab Pickup Exc. HD Straight Front Axle	
F	88-00	PICKUP 3/4 TON, C25 / C2500 All	
F	92-99	SUBURBAN 1/2 TON, C15 / C1500 All	
F	92-99	SUBURBAN 3/4 TON, C25 / C2500 All	
F	95-00	TAHOE RWD Old Body Style	
F	88-99	GMC PICKUP 1/2 TON, C15 / C1500 All	
F	92-00	PICKUP 1 TON, C35/3500 Crew Cab Pickup Exc. HD Straight Front Axle	
F	88-00	PICKUP 1 TON, C35/3500 Extended Cab Pickup Exc. HD Straight Front Axle	
F	88-00	PICKUP 1 TON, C35/3500 Standard Cab Pickup Exc. HD Straight Front Axle	
F	88-00	PICKUP 3/4 TON, C25 / C2500 All	

Numerical listing

Shock	POP	Alternative No.	MTG Acc. Supplied
Pos.	Year	Application	
G63489 A (cont) 141277			
F	92-99	SUBURBAN 1/2 TON, C15 / C1500 All	
F	92-99	SUBURBAN 3/4 TON, C25 / C2500 All	
F	92-99	YUKON RWD	
G63490 C			
R	86-88	FORD AEROSTAR RWD	
R	87-95	JEEP WRANGLER YJ (MfrBodyCode)	
G63492 A 141137			
R	81-82	CHEVROLET LUV PICKUP All	
R	87-89	DODGE RAIDER 2.6L 4Cyl L (156) Exc. Sport Utility	
F	61-67	FORD ECONOLINE All	
R	81-95	ISUZU PICKUP RWD	
R	86-92	JEEP COMANCHE All	
F	66-73	WAGONEER All	
F	63-65	WAGONEER All Exc. Independent Front Suspension	
R	83-89	MITSUBISHI MONTERO 2.6L 4Cyl L (156)	
R	97-99	MONTERO SPORT All	
R	82-86	NISSAN 720 PICKUP 4WD	
R	00-04	FRONTIER Crew Cab Pickup, RWD w/ Desert Runner	
R	98-04	FRONTIER 4WD	
R	98-99	FRONTIER RWD Crew Cab; w/ Desert Runner Package	
R	87-95	PATHFINDER All Exc. Electronic Adjustable Suspension	
R	87-97	PICKUP 4WD	
R	86	PICKUP 4WD Mfg. from 8/86	
R	00-04	XTERRA All	
R	84-87	TOYOTA LAND CRUISER FJ60 (MfrBodyCode), Sport Utility	
R	76-83	LAND CRUISER All	
R	75	LAND CRUISER All Mfg. from 1/75	
R	69-74	LAND CRUISER All	
R	85-92	PICKUP RWD 1 Ton	
R	80-83	PICKUP 4WD Exc. Lift Kit	
G63494 C 140149			
R	84-89	TOYOTA 4RUNNER All	
R	84-95	PICKUP 4WD Exc. Lift Kit	
R	98-04	TACOMA Pre Runner, RWD Exc. Heavy Duty Upgrade	
R	95-04	TACOMA 4WD Exc. Heavy Duty Upgrade	
G63495 W 141350			
F	87-91	ISUZU TROOPER 4WD	
F	86-87	MAZDA B2000 RWD	
F	87-93	B2200 RWD	
F	87-93	B2600 RWD	
G63506 W 141448			
F	99	LAND ROVER DISCOVERY SD	
F	99	DISCOVERY SE7	
F	94-98	DISCOVERY All	
F	94-95	RANGE ROVER Air (RearSpringType)	
G63510 W 140149			
R	88-90	TOYOTA LAND CRUISER All	
G63511 C 141353			
F	78-79	FORD BRONCO All 4WD Quad Suspension Forward of Front Axle Non Quad Suspension	
F	78-79	PICKUP 1/2 TON, F-150 Custom, 4WD Quad Suspension Forward of Front Axle Non Quad Suspension	
F	78-79	PICKUP 1/2 TON, F-150 Ranger Lariat, 4WD Quad Suspension Forward of Front Axle Non Quad Suspension	
F	78-79	PICKUP 1/2 TON, F-150 Ranger, 4WD Quad Suspension Forward of Front Axle Non Quad Suspension	
F	78	PICKUP 1/2 TON, F-150 Base, 4WD Quad Suspension Forward of Front Axle Non Quad Suspension	
F	78	PICKUP 1/2 TON, F-150 Northland, 4WD Quad Suspension Forward of Front Axle Non Quad Suspension	
F	87-95	JEEP WRANGLER YJ (MfrBodyCode) 4WD Quad Suspension Forward of Front Axle Non Quad Suspension	
G63524 W			
R	89-97	FORD RANGER 4WD	
R	95-96	MAZDA B2300 4WD	

Numerical listing

Shock	POP	Alternative No.	MTG Acc. Supplied
Pos.	Year	Application	
G63524	W	(cont)	
R	94-97	B3000	4WD
R	94-97	B4000	4WD
G63525	C		
R	90	FORD BRONCO II All	
R	89	BRONCO II All Mfg. from 2/89; Vehicles w/ 12mm bolt in rear lower mount	
R	90-97	RANGER RWD	
R	89	RANGER RWD Mfg. from 2/89; Vehicles w/ 12mm bolt in rear lower mount	
R	94-97	MAZDA B2300 RWD	
R	94-97	B3000 RWD	
R	94-97	B4000 RWD	
G63547	D		141350
F	90-95	TOYOTA 4RUNNER All	
G63548	D		140921
R	90-95	TOYOTA 4RUNNER All	
G63604	W		
R	89	DODGE RAIDER Sport Utility, 3.0L 6Cyl V (181), 3.59 91.1(Bore)2.99 76.0(Stroke)	
R	89-91	MITSUBISHI MONTERO 3.0L 6Cyl V (181), 3.59 91.1(Bore)2.99 76.0(Stroke)	
G63605	W		140169
F	74	DODGE M300 All	
F	74	M350 All	
G63607	W		140719
R	00-05	FORD EXCURSION RWD	
R	91-94	EXPLORER All	
R	91-94	MAZDA NAVAJA All	
G63608	W		140780
F	91-94	FORD EXPLORER All	
F	91-94	MAZDA NAVAJA All	
G63609	A		
F	99-00	CADILLAC ESCALADE All	
F	92-94	CHEVROLET BLAZER 4WD Full Size	
F	88-00	PICKUP 1 TON, K35 / K3500 All	
F	88-00	PICKUP 3/4 TON, K25 / K2500 All	
F	92-99	SUBURBAN 1/2 TON, K15 / K1500 All	
F	92-99	SUBURBAN 3/4 TON, K25 / K2500 All	
F	95-00	TAHOE 4WD Old Body Style	
F	88-00	GMC PICKUP 1 TON, K35 / K3500 All	
F	88-00	PICKUP 3/4 TON, K25 / K2500 All	
F	92-99	SUBURBAN 1/2 TON, K15 / K1500 All	
F	92-99	SUBURBAN 3/4 TON, K25 / K2500 All	
F	92-99	YUKON 4WD	
G63610	C		142389
R	94-97	HONDA PASSPORT All	
R	91-97	ISUZU RODEO All	
R	98-03	TOYOTA SIENNA All	
G63611	D		140524
F	90-92	DAIHATSU ROCKY All	
F	94-02	HONDA PASSPORT All	
F	98-00	ISUZU AMIGO All	
F	02-04	AXIOM All	
F	91-04	RODEO All	
G63614	B		140780
F	90	FORD BRONCO II All	
F	00-05	EXCURSION RWD	
F	90-97	RANGER All	
F	94-97	MAZDA B2300 All	
F	94-97	B3000 All	
F	94-97	B4000 All	
G63615	W		142657
F	95	LAND ROVER RANGE ROVER All	
F	94	RANGE ROVER Coil (RearSpringType)	
F	96-97	LEXUS LX450 All	
F	91-97	TOYOTA LAND CRUISER All	
G63616	D		140169,142656
R	96-97	LEXUS LX450 All	
R	93-97	TOYOTA LAND CRUISER All	
R	91-92	LAND CRUISER FJ80 (MfrBodyCode)	

Ultra Truck Shock

Shock	POP	Alternative No.	MTG Acc. Supplied
Pos.	Year	Application	
G63620	W		141405
R	91-97	TOYOTA PREVIA All	
G63622	A		142617
F	00-02	FORD E-450 ECONOLINE SUPER DUTY All	
F	00-06	ECONOLINE All	
F	99-16	PICKUP 1 TON, F-350 / SUPERDUTY RWD	
F	11-16	PICKUP 3/4 TON, F-250 / SUPERDUTY RWD Exc. Off Road	
F	99-10	PICKUP 3/4 TON, F-250 / SUPERDUTY RWD	
F	08-14	VAN 1/2 TON, ECONOLINE / CLUB WAGON All	
F	21-22	VAN 1 TON, ECONOLINE / CLUB WAGON / SUPERDUTY All	
F	99-19	VAN 1 TON, ECONOLINE / CLUB WAGON / SUPERDUTY All	
F	07	VAN 1 TON, ECONOLINE / CLUB WAGON / SUPERDUTY All Exc. Cutaway Chassis	
F	92-05	VAN 1 TON, ECONOLINE / CLUB WAGON / SUPERDUTY All Cutaway Chassis	
F	92-14	VAN 3/4 TON, ECONOLINE / CLUB WAGON / SUPERDUTY All	
G63623	A		142617
R	00-02	FORD E-450 ECONOLINE SUPER DUTY All	
R	00-06	ECONOLINE All	
R	08-14	VAN 1/2 TON, ECONOLINE / CLUB WAGON All	
R	21-22	VAN 1 TON, ECONOLINE / CLUB WAGON / SUPERDUTY All	
R	99-19	VAN 1 TON, ECONOLINE / CLUB WAGON / SUPERDUTY All	
R	04-11	VAN 1 TON, ECONOLINE / CLUB WAGON / SUPERDUTY All Exc. Cutaway Chassis	
R	92-05	VAN 1 TON, ECONOLINE / CLUB WAGON / SUPERDUTY All Cutaway Chassis	
R	92-14	VAN 3/4 TON, ECONOLINE / CLUB WAGON / SUPERDUTY All	
G63624	D		140780
R	92-07	FORD VAN 1/2 TON, ECONOLINE / CLUB WAGON All	
G63625	C		140702
F	86-99	CHEVROLET VAN 1 TON, P SERIES All Motorhome Chassis w/ I-Beam Front Suspension	
F	86-99	GMC VAN 1 TON, P SERIES All Motorhome Chassis w/ I-Beam Front Suspension	
G63635	W		140524
F	87-93	MAZDA B2600 4WD	
G63638	A		
R	99-00	CADILLAC ESCALADE All	
R	92-94	CHEVROLET BLAZER 4WD Full Size	
R	92-99	SUBURBAN 1/2 TON, K15 / K1500 All	
R	92-99	SUBURBAN 3/4 TON, K25 / K2500 All	
R	95-00	TAHOE 4WD Old Body Style	
R	97-02	VAN 1 TON, G / EXPRESS All Exc. 8600# GVW	
R	96-02	VAN 3/4 TON, G / EXPRESS All Exc. 8600# GVW	
R	92-99	GMC SUBURBAN 1/2 TON, K15 / K1500 All	
R	92-99	SUBURBAN 3/4 TON, K25 / K2500 All	
R	96-02	VAN 1 TON, G / SAVANA All Exc. 8600# GVW	
R	96-02	VAN 3/4 TON, G / SAVANA All Exc. 8600# GVW	
G63661	C		143000
F	94-01	DODGE PICKUP 1/2 TON, RAM 1500 (SEE RAM 1500) RWD	
F	94-02	PICKUP 1 TON, RAM 3500 (SEE RAM 3500) RWD Exc. Solid Front Axle	
F	94-02	PICKUP 3/4 TON, RAM 2500 (SEE RAM 2500) RWD	

Numerical listing

Shock	POP	Alternative No.	MTG Acc. Supplied
Pos.	Year	Application	
G63662	A		
R	99-07	CHEVROLET PICKUP 1/2 TON, SILVERADO 1500 RWD Exc. Electronic Adjustable Suspension	
R	94-01	DODGE PICKUP 1/2 TON, RAM 1500 (SEE RAM 1500) All	
R	94-02	PICKUP 1 TON, RAM 3500 (SEE RAM 3500) RWD Exc. Solid Front Axle	
R	94-03	PICKUP 3/4 TON, RAM 2500 (SEE RAM 2500) All Exc. 8800# GVW	
R	99-07	GMC SIERRA 1500 RWD Exc. Electronic Adjustable Suspension	
G63671	W		
R	92-96	CHEVROLET VAN 1 TON, G / EXPRESS Cutaway Van	
R	92-96	GMC VAN 1 TON, G / SAVANA Cutaway Van	
G63673	C		143000
F	94-01	DODGE PICKUP 1/2 TON, RAM 1500 (SEE RAM 1500) 4WD	
F	03-10	PICKUP 1 TON, RAM 3500 (SEE RAM 3500) 4WD	
F	94-02	PICKUP 3/4 TON, RAM 2500 (SEE RAM 2500) 4WD Exc. 8800# GVW	
F	11-20	RAM 3500 (SEE DODGE RAM 3500) 4WD	
G63674	D		142731
F	94-02	DODGE PICKUP 1 TON, RAM 3500 (SEE RAM 3500) 4WD	
F	94-02	PICKUP 1 TON, RAM 3500 (SEE RAM 3500) RWD Solid Front Axle	
F	94-02	PICKUP 3/4 TON, RAM 2500 (SEE RAM 2500) 4WD 8800# GVW	
G63675	A		
R	07	CHEVROLET PICKUP 1/2 TON, SILVERADO 1500 4WD Old Body Style; Exc. Electronic Adjustable Suspension	
R	99-06	PICKUP 1/2 TON, SILVERADO 1500 4WD Exc. Electronic Adjustable Suspension	
R	05-06	PICKUP 1/2 TON, SILVERADO 1500 HD All	
R	01-03	PICKUP 1/2 TON, SILVERADO 1500 HD All	
R	77-86	PICKUP 1 TON, K30 All	
R	90-91	PICKUP 1 TON, R3500 All	
R	89	PICKUP 1 TON, R3500 Cab & Chassis, RWD	
R	89	PICKUP 1 TON, R3500 Crew Cab Pickup, RWD	
R	01-09	PICKUP 1 TON, SILVERADO 3500 All	
R	07-10	PICKUP 1 TON, SILVERADO 3500 HD All	
R	87-88	PICKUP 1 TON, V30 All	
R	89-91	PICKUP 1 TON, V3000 / V3500 All	
R	99-08	PICKUP 3/4 TON, SILVERADO 2500 All	
R	01-10	PICKUP 3/4 TON, SILVERADO 2500 HD All	
R	07	SILVERADO 1500 HD CLASSIC All	
R	02-05	SILVERADO 2500 HD CLASSIC All	
R	02-05	DODGE PICKUP 1/2 TON, RAM 1500 (SEE RAM 1500) All	
R	94-02	PICKUP 1 TON, RAM 3500 (SEE RAM 3500) 4WD	
R	94-02	PICKUP 1 TON, RAM 3500 (SEE RAM 3500) RWD Solid Front Axle	
R	94-02	PICKUP 3/4 TON, RAM 2500 (SEE RAM 2500) 4WD 8800# GVW	
R	77-86	GMC PICKUP 1 TON, K35 / K3500 All	
R	87-91	PICKUP 1 TON, V3000 / V3500 All	
R	07	SIERRA 1500 4WD Old Body Style; Exc. Electronic Adjustable Suspension	
R	99-06	SIERRA 1500 4WD Exc. Electronic Adjustable Suspension	
R	05-06	SIERRA 1500 HD All	
R	01-03	SIERRA 1500 HD All	
R	07	SIERRA 1500 HD CLASSIC All	
R	99-04	SIERRA 2500 All	
R	01-10	SIERRA 2500 HD All	
R	01-06	SIERRA 3500 All	
R	07-10	SIERRA 3500 HD All	
G63676	W		
R	95-03	FORD WINDSTAR Coil (RearSpringType)	

Numerical listing

Shock	POP	Alternative No.	MTG Acc. Supplied
Pos.	Year	Application	
G63678 A 142277			
F	95-01	FORD EXPLORER All Exc. Adjustable Suspension	
F	01-05	EXPLORER SPORT TRAC All	
F	98-11	RANGER Torsion Bar (FrontSpringType)	
F	06-07	MAZDA B3000 All 4WD	
F	05	B3000 4WD	
F	03	B3000 All 4WD	
F	98-02	B3000 4WD	
F	98-09	B4000 4WD	
F	97-01	MERCURY MOUNTAINEER All Exc. Electronic Adjustable Suspension	
G63679 B 140719			
R	95-01	FORD EXPLORER All Exc. Adjustable Suspension	
R	01-05	EXPLORER SPORT TRAC All	
R	97-01	MERCURY MOUNTAINEER All Exc. Electronic Adjustable Suspension	
G63683 D			
R	95-98	JEEP GRAND CHEROKEE All	
G63689 C			
R	01-04	TOYOTA TACOMA S-Runner	
R	04	TACOMA Base, RWD	
R	95-03	TACOMA DLX, RWD	
G63690 C			
R	96-07	CHRYSLER TOWN & COUNTRY All Exc. Hydraulic Self-Leveling System	
R	00-03	VOYAGER / GRAND VOYAGER All Exc. Hydraulic Self-Leveling System	
R	96-07	DODGE CARAVAN / GRAND CARAVAN All Exc. Hydraulic Self-Leveling System	
R	05	CARAVAN / GRAND CARAVAN All	
R	96-00	PLYMOUTH VOYAGER / GRAND VOYAGER All Exc. Hydraulic Self-Leveling System	
G63692 W			
F	93-97	FORD PICKUP 1/2 TON, F SUPERDUTY All Mfg. from 2/93	
F	97	PICKUP, F-450 SUPERDUTY All	
G63694 W 141448			
R	99	LAND ROVER DISCOVERY SD	
R	99	DISCOVERY SE7	
R	94-98	DISCOVERY All	
R	94-95	RANGE ROVER Air (RearSpringType)	
G63707 W 141354			
F	96-99	ACURA SLX All	
F	92-02	ISUZU TROOPER All	
F	99-01	VEHICROSS All	
G63708 W 140169			
R	96-99	ACURA SLX All	
R	92-02	ISUZU TROOPER All	
R	99-01	VEHICROSS All	
G63710 W 140524			
R	98-02	HONDA PASSPORT All	
R	98-00	ISUZU AMIGO All	
R	02-04	AXIOM All	
R	98-04	RODEO All	
G63712 W 141137			
R	98	INFINITI QX4 All Mfg. to 12/98	
R	97	QX4 All	
R	98-99	NISSAN PATHFINDER All Mfg. to 12/98	
R	96-97	PATHFINDER All	
G63714 B 142731			
F	97-02	FORD EXPEDITION RWD Exc. Front Air- Leveling	
F	97-04	LOBO RWD	
F	97-04	PICKUP 1/2 TON, F-150 RWD	
F	97-99	PICKUP 3/4 TON, F-250 / SUPERDUTY RWD Up through 8500# GVW	
F	98-02	LINCOLN NAVIGATOR RWD	
G63715 B 142700			
R	98-03	FORD LOBO 4WD	
R	97-04	PICKUP 1/2 TON, F-150 4WD	
R	97-99	PICKUP 3/4 TON, F-250 / SUPERDUTY 4WD Up through 8500# GVW	

Ultra Truck Shock

Shock	POP	Alternative No.	MTG Acc. Supplied
Pos.	Year	Application	
G63716 A 142731			
F	97-02	FORD EXPEDITION 4WD Exc. Front Air- Leveling	
F	98-03	LOBO 4WD	
F	04	PICKUP 1/2 TON, F-150 4WD Exc. 7000# GVW	
F	97-03	PICKUP 1/2 TON, F-150 4WD	
F	97-99	PICKUP 3/4 TON, F-250 / SUPERDUTY 4WD Up through 8500# GVW	
G63717 C			
R	97-02	FORD EXPEDITION All	
R	98-02	LINCOLN NAVIGATOR RWD	
G63720 W 140800			
R	95-02	KIA SPORTAGE All	
G63721 C 141665			
F	97-06	JEEP WRANGLER TJ (MfrBodyCode)	
G63722 B			
R	97-06	JEEP WRANGLER TJ (MfrBodyCode)	
G63726 A 140921			
R	96-02	TOYOTA 4RUNNER All	
G63772 A 141665			
F	06-11	FORD RANGER RWD, Coil (FrontSpringType)	
F	01-05	RANGER XL, RWD, Coil (FrontSpringType)	
F	01-05	RANGER XLT, RWD, Coil (FrontSpringType)	
F	02	RANGER EV, Torsion Bar (FrontSpringType) 4WD	
F	01	RANGER EV Coil (FrontSpringType)	
F	98-00	RANGER XL, RWD	
F	98-00	RANGER XLT, RWD	
F	01-09	MAZDA B2300 RWD	
F	98-01	B2500 RWD	
F	98-07	B3000 RWD	
F	98-06	B4000 RWD	
G63773 A			
R	06-11	FORD RANGER RWD, Coil (FrontSpringType)	
R	98-05	RANGER XL, RWD	
R	98-05	RANGER XLT, RWD	
R	05	RANGER STX, RWD	
R	04	RANGER Tremor, RWD	
R	02	RANGER Postal, RWD	
R	01-06	MAZDA B2300 RWD	
R	98-01	B2500 All	
R	98-06	B3000 RWD	
R	98-06	B4000 RWD	
G63775 A			
R	98-11	FORD RANGER 4WD	
R	98-11	RANGER RWD, Torsion Bar (FrontSpringType)	
R	06-07	MAZDA B3000 All 4WD	
R	05	B3000 4WD	
R	98-02	B3000 4WD	
R	98-09	B4000 4WD	
G63776 A			
R	05-07	BUICK TERRAZA FWD Exc. Air- Leveling Suspension	
R	05-09	CHEVROLET UPLANDER FWD Exc. Auto-Leveling System	
R	02-05	VENTURE All	
R	97-01	VENTURE FWD	
R	02-04	OLDSMOBILE SILHOUETTE AWD	
R	97-04	SILHOUETTE FWD	
R	07-09	PONTIAC MONTANA CAN	
R	06	MONTANA FWD Exc. Air- Leveling Suspension	
R	99-05	MONTANA All Exc. Air- Leveling Suspension	
R	97-99	TRANS SPORT All	
R	05-07	SATURN RELAY FWD Exc. Air- Leveling Suspension	
G63778 B 142700			
R	00-03	FORD LOBO Harley-Davidson Edition, RWD	
R	00-03	LOBO XLT, RWD	
R	00	LOBO Base, RWD	
R	00	LOBO Lariat, RWD	
R	97-98	LOBO RWD	
R	04	PICKUP 1/2 TON, F-150 RWD	

Numerical listing

Shock	POP	Alternative No.	MTG Acc. Supplied
Pos.	Year	Application	
G63778 B (cont) 142700			
R	00-03	PICKUP 1/2 TON, F-150 Harley-Davidson Edition, RWD	
R	99-03	PICKUP 1/2 TON, F-150 Lariat, RWD	
R	99-03	PICKUP 1/2 TON, F-150 XL, RWD	
R	99-03	PICKUP 1/2 TON, F-150 XLT, RWD	
R	00	PICKUP 1/2 TON, F-150 Base, RWD	
R	97-98	PICKUP 1/2 TON, F-150 RWD	
R	97-99	PICKUP 3/4 TON, F-250 / SUPERDUTY RWD Up through 8500# GVW	
G63781 W 141350			
R	92-00	MITSUBISHI MONTERO All	
G63782 W 141350			
F	92-00	MITSUBISHI MONTERO All	
F	97-99	MONTERO SPORT All	
G63783 A 141665			
F	99-07	CHEVROLET PICKUP 1/2 TON, SILVERADO 1500 RWD Exc. Electronic Adjustable Suspension	
F	99-04	PICKUP 3/4 TON, SILVERADO 2500 RWD Exc. Electronic Adjustable Suspension	
F	01-04	PICKUP 3/4 TON, SILVERADO 2500 HD RWD	
F	99-07	GMC SIERRA 1500 RWD Exc. Electronic Adjustable Suspension	
F	99-04	SIERRA 2500 RWD Exc. Electronic Adjustable Suspension	
F	01-04	SIERRA 2500 HD RWD	
G63799 W 141514			
R	92-93	ASUNA SUNRUNNER All	
R	98-04	CHEVROLET TRACKER Non-ABS	
R	89-97	GEO TRACKER All	
R	94-97	PONTIAC SUNRUNNER All	
R	99-05	SUZUKI GRAND VITARA All	
R	89-98	SIDEKICK Non-ABS	
R	99-04	VITARA Non-ABS	
R	96-98	X-90 All	
G63803 A 141665			
F	02-06	CHEVROLET AVALANCHE 1500 All Exc. Electronic Ride Control	
F	07	PICKUP 1/2 TON, SILVERADO 1500 4WD Old Body Style; Exc. Electronic Adjustable Suspension	
F	99-06	PICKUP 1/2 TON, SILVERADO 1500 4WD Exc. Electronic Adjustable Suspension	
F	00-06	SUBURBAN 1/2 TON, 1500 All Exc. Z55 Auto Ride Suspension	
F	02-06	TAHOE All Exc. Z55 Auto Ride Suspension	
F	00-01	TAHOE All New Body Style; Exc. Z55 Auto Ride Suspension	
F	07	GMC SIERRA 1500 4WD Old Body Style; Exc. Electronic Adjustable Suspension	
F	99-06	SIERRA 1500 4WD Exc. Electronic Adjustable Suspension	
F	00-06	YUKON All Exc. Z55 Auto Ride Suspension	
F	00-06	YUKON XL 1/2 TON All Exc. Z55 Auto Ride Suspension	
G63808 D			
R	99-04	FORD PICKUP 1 TON, F-350 / SUPERDUTY RWD	
R	99-04	PICKUP 3/4 TON, F-250 / SUPERDUTY RWD	
G63809 A			
F	00-05	FORD EXCURSION 4WD	
F	99-04	PICKUP 1 TON, F-350 / SUPERDUTY 4WD	
F	99-04	PICKUP 3/4 TON, F-250 / SUPERDUTY 4WD	
F	99-04	PICKUP, F-450 SUPERDUTY All	
F	99-04	PICKUP, F-550 SUPERDUTY All	
G63810 C			
R	99-04	FORD PICKUP 1 TON, F-350 / SUPERDUTY 4WD	
R	99-04	PICKUP 3/4 TON, F-250 / SUPERDUTY 4WD	
G63813 B 142389			
F	00-04	NISSAN FRONTIER Crew Cab Pickup, RWD w/ Desert Runner	
F	98-04	FRONTIER 4WD	

Numerical listing

Shock	POP	Alternative No.	MTG Acc. Supplied
Pos.	Year	Application	
G63813	B (cont)	142389	
F	98-99	FRONTIER RWD Crew Cab; w/ Desert Runner Package	
F	00-04	XTERRA All	
G63815	C	142389	
R	00-06	TOYOTA TUNDRA All	
G63817	A	141665	
F	02-06	CHEVROLET AVALANCHE 2500 All Exc. Electronic Ride Control	
F	05-06	PICKUP 1/2 TON, SILVERADO 1500 HD All	
F	01-03	PICKUP 1/2 TON, SILVERADO 1500 HD All	
F	01-09	PICKUP 1 TON, SILVERADO 3500 All	
F	07-10	PICKUP 1 TON, SILVERADO 3500 HD All	
F	05-08	PICKUP 3/4 TON, SILVERADO 2500 All	
F	99-04	PICKUP 3/4 TON, SILVERADO 2500 4WD	
F	01-10	PICKUP 3/4 TON, SILVERADO 2500 HD All 9200# GVW	
F	07	SILVERADO 1500 HD CLASSIC All	
F	07	SILVERADO 2500 HD CLASSIC All	
F	00-11	SUBURBAN 3/4 TON, 2500 All Exc. Z55 Auto Ride Suspension and Quadrasteer	
F	05-06	GMC SIERRA 1500 HD All	
F	01-03	SIERRA 1500 HD All	
F	07	SIERRA 1500 HD CLASSIC All	
F	99-04	SIERRA 2500 4WD	
F	01-10	SIERRA 2500 HD All	
F	01-06	SIERRA 3500 All	
F	07-10	SIERRA 3500 HD Torsion Bar (FrontSpringType)	
F	00-06	YUKON XL 3/4 TON All Exc. Hydraulic Self-Leveling System	
F	03-09	HUMMER H2 All	
G63818	A	142976	
F	90-05	CHEVROLET ASTRO AWD	
F	88-99	PICKUP 1/2 TON, K15 / K1500 All	
F	88-99	GMC PICKUP 1/2 TON, K15 / K1500 All	
F	90-05	SAFARI AWD	
G63828	B	142976	
R	07	LEXUS LX470 All	
R	98-06	LX470 Torsion Bar (FrontSpringType)	
R	98-07	TOYOTA LAND CRUISER All	
G63829	B	142976	
R	99-04	JEEP GRAND CHEROKEE All	
G63832	A	142976	
F	07	LEXUS LX470 All	
F	98-06	LX470 Torsion Bar (FrontSpringType)	
F	98-07	TOYOTA LAND CRUISER All	
G63837	D	142976	
R	00-05	FORD EXCURSION 4WD	
G63842	A	142976	
R	04-07	BUICK RAINIER Coil (FrontSpringType)	
R	03-06	CHEVROLET SSR All	
R	02-09	TRAILBLAZER Coil (RearSpringType)	
R	02-09	GMC ENVOY Coil (RearSpringType)	
R	03-08	ISUZU ASCENDER Coil (RearSpringType)	
R	02-04	OLDSMOBILE BRAVADA Coil (RearSpringType)	
R	05-09	SAAB 9-7X All	
G63844	A	142976	
R	07-11	DODGE NITRO All	
R	02-12	JEEP LIBERTY All	
G63845	C	142976	
R	99-03	INFINITI QX4 All Mfg. from 12/98	
R	02-04	NISSAN PATHFINDER All	
R	99-01	PATHFINDER All Mfg. from 12/98	
G63847	B	141353,142592	
F	99-04	JEEP GRAND CHEROKEE All Exc. Up Country Suspension	
G63848	B	142731	
F	02-05	DODGE PICKUP 1/2 TON, RAM 1500 (SEE RAM 1500) 4WD	

Ultra Truck Shock

Shock	POP	Alternative No.	MTG Acc. Supplied
Pos.	Year	Application	
G63860	C	140455	
R	96-05	TOYOTA RAV4 All	
G63862	W	141041	
R	01-07	FORD ESCAPE All	
R	01-06	MAZDA TRIBUTE All	
R	05-07	MERCURY MARINER All	
G63864	W	141041	
R	00-06	MAZDA MPV All	
G63866	A	141041	
R	02-13	CADILLAC ESCALADE All Exc. Electronic Ride Control	
R	07-13	CHEVROLET AVALANCHE 1500 All Exc. Z55 or ZW7 Ride Suspension	
R	02-06	AVALANCHE 1500 All Exc. Electronic Ride Control	
R	02-06	AVALANCHE 2500 All Exc. Electronic Ride Control	
R	21-22	COLORADO Z71 LT	
R	15-22	COLORADO LT	
R	15-22	COLORADO WT	
R	15-22	COLORADO Z71	
R	15-20	COLORADO Base	
R	15	COLORADO LTZ	
R	07-11	SUBURBAN 1/2 TON, 1500 All Exc. Z55 or ZW7 Ride Suspension	
R	00-06	SUBURBAN 1/2 TON, 1500 All Exc. Z55 Auto Ride Suspension	
R	00-11	SUBURBAN 3/4 TON, 2500 All Exc. Z55 Auto Ride Suspension and Quadrasteer	
R	07-11	TAHOE All Exc. Z55 or ZW7 Ride Suspension	
R	02-06	TAHOE All Exc. Z55 Auto Ride Suspension	
R	00-01	TAHOE All New Body Style; Exc. Z55 Auto Ride Suspension	
R	15-22	GMC CANYON All Exc. ZR2 Package	
R	07-11	YUKON All Exc. Z55 or ZW7 Ride Suspension	
R	00-06	YUKON All Exc. Z55 Auto Ride Suspension	
R	00-11	YUKON XL 1/2 TON All Exc. Z55 Auto Ride Suspension	
R	00-11	YUKON XL 3/4 TON All Exc. Z55 Auto Ride Suspension and Quadrasteer	
G63867	B	140455	
R	09-10	FORD LOBO RWD	
R	04-08	LOBO 4WD	
R	09-10	PICKUP 1/2 TON, F-150 RWD	
R	04-08	PICKUP 1/2 TON, F-150 4WD	
R	06-08	LINCOLN MARK LT 4WD	
G63868	D	140455	
R	02-07	BUICK RENDEZVOUS All Exc. Hydraulic Self-Leveling System	
R	01-05	PONTIAC AZTEK AWD	
G63869	W	140455	
R	01-05	PONTIAC AZTEK FWD	
G63870	B	140455	
R	05-08	FORD LOBO RWD	
R	04	LOBO XLT, RWD	
R	05-08	PICKUP 1/2 TON, F-150 RWD	
R	04	PICKUP 1/2 TON, F-150 Lariat, RWD	
R	04	PICKUP 1/2 TON, F-150 STX, RWD	
R	04	PICKUP 1/2 TON, F-150 XL, RWD	
R	04	PICKUP 1/2 TON, F-150 XLT, RWD	
R	06-08	LINCOLN MARK LT RWD	
G63872	B	140455	
R	02-10	SATURN VUE All	
G63873	W	140455	
R	04-07	FORD FREESTAR All	
R	04-07	MERCURY MONTEREY Mini Passenger Van	
G63875	B	140455	
R	04-08	CHEVROLET TORNADO All	
R	05-07	INFINITI QX56 All Exc. Air-Leveling Suspension	
R	05-15	NISSAN ARMADA All Exc. Auto-Leveling System	
R	04	PATHFINDER ARMADA All	
G63878	D	140455	
R	17-22	NISSAN TITAN 4WD	
R	04-15	TITAN 4WD	
R	20-22	TITAN XD Platinum Reserve	

Numerical listing

Shock	POP	Alternative No.	MTG Acc. Supplied
Pos.	Year	Application	
G63878	D (cont)	140455	
R	20-22	TITAN XD S	
R	20-22	TITAN XD SV	
R	20-21	TITAN XD SL	
R	16-19	TITAN XD Platinum Reserve, 4WD	
R	16-19	TITAN XD S, 4WD	
R	16-19	TITAN XD SL, 4WD	
R	16-19	TITAN XD SV, 4WD	
G63879	B	140455	
R	04-12	CHEVROLET COLORADO Torsion Bar (FrontSpringType)	
R	04-12	GMC CANYON Torsion Bar (FrontSpringType)	
R	06	ISUZU I-280 All Torsion Bar (FrontSpringType)	
G63882	D	140455	
R	04-12	CHEVROLET COLORADO RWD, Coil (FrontSpringType) D Standard Suspension; Exc. Z71 Off Road Package	
R	04-12	GMC CANYON RWD, Coil (FrontSpringType) D Standard Suspension; Exc. Z71 Off Road Package	
R	06	ISUZU I-280 Coil (FrontSpringType)	
R	07-08	I-290 Coil (FrontSpringType)	
R	08	I-370 Coil (FrontSpringType)	
G63883	W	140455	
R	17-22	NISSAN TITAN RWD	
R	04-15	TITAN RWD	
G63884	B	143312	
F	04-12	CHEVROLET COLORADO Torsion Bar (FrontSpringType)	
F	04-08	GMC CANYON Torsion Bar (FrontSpringType)	
F	06	ISUZU I-350 Torsion Bar (FrontSpringType)	
G63885	C	142280	
R	17-18	TOYOTA 4RUNNER RWD Exc. Kinetic Suspension	
R	10-16	4RUNNER All	
R	03-09	4RUNNER Limited	
R	03-09	4RUNNER SR5	
G63886	A	142731	
F	13-16	FORD PICKUP 1 TON, F-350 / SUPERDUTY 4WD Exc. Off Road	
F	05-12	PICKUP 1 TON, F-350 / SUPERDUTY 4WD	
F	12-16	PICKUP 3/4 TON, F-250 / SUPERDUTY RWD w/ Off Road Package	
F	05-16	PICKUP 3/4 TON, F-250 / SUPERDUTY 4WD	
G63888	A	142731	
R	13-16	FORD PICKUP 1 TON, F-350 / SUPERDUTY 4WD	
R	05-12	PICKUP 1 TON, F-350 / SUPERDUTY Crew Cab Pickup, 4WD Single Rear Wheels	
R	05-12	PICKUP 1 TON, F-350 / SUPERDUTY Extended Cab Pickup, 4WD Single Rear Wheels	
R	05-12	PICKUP 1 TON, F-350 / SUPERDUTY Standard Cab Pickup, 4WD Single Rear Wheels	
R	13-16	PICKUP 3/4 TON, F-250 / SUPERDUTY RWD	
R	05-12	PICKUP 3/4 TON, F-250 / SUPERDUTY 4WD	
G63889	C	141041	
R	05-15	TOYOTA TACOMA Base, RWD	
R	05-15	TACOMA Pre Runner, RWD	
G63890	D	141041	
R	05-10	DODGE DAKOTA RWD	
R	06-09	MITSUBISHI RAIDER RWD	
R	11	RAM DAKOTA RWD	
G63891	C	141041	
R	05-10	DODGE DAKOTA 4WD	
R	06-09	MITSUBISHI RAIDER 4WD	
R	11	RAM DAKOTA 4WD	
G63892	C	141041	
R	07-09	CHRYSLER ASPEN All	
R	04-09	DODGE DURANGO All	

Numerical listing

Shock	POP	Alternative No.	MTG Acc. Supplied
Pos.	Year	Application	
G63893	D		143276
F	10-14	CHEVROLET VAN 1/2 TON, G / EXPRESS AWD, Torsion Bar (FrontSpringType)	
F	03-09	VAN 1/2 TON, G / EXPRESS Torsion Bar (FrontSpringType)	
F	03-12	VAN 1 TON, G / EXPRESS All Torsion Bar (FrontSpringType)	
F	06-12	VAN 3/4 TON, G / EXPRESS All Torsion Bar (FrontSpringType)	
F	03-05	VAN 3/4 TON, G / EXPRESS Torsion Bar (FrontSpringType)	
F	10-14	GMC VAN 1/2 TON, G / SAVANA AWD, Torsion Bar (FrontSpringType)	
F	03-09	VAN 1/2 TON, G / SAVANA Torsion Bar (FrontSpringType)	
F	03-12	VAN 1 TON, G / SAVANA All Torsion Bar (FrontSpringType)	
F	04-12	VAN 3/4 TON, G / SAVANA All Torsion Bar (FrontSpringType)	
F	03	VAN 3/4 TON, G / SAVANA Torsion Bar (FrontSpringType)	
G63894	B		143276
F	03-14	CHEVROLET VAN 1/2 TON, G / EXPRESS RWD, Coil (FrontSpringType)	
F	03-14	GMC VAN 1/2 TON, G / SAVANA RWD, Coil (FrontSpringType)	
G63895	A		143276
F	09-22	CHEVROLET EXPRESS 4500 All	
F	17-22	VAN 1 TON, G / EXPRESS All	
F	03-16	VAN 1 TON, G / EXPRESS Coil (FrontSpringType)	
F	17-22	VAN 3/4 TON, G / EXPRESS All	
F	03-16	VAN 3/4 TON, G / EXPRESS Coil (FrontSpringType)	
F	14-20	GMC SAVANA 4500 All	
F	17-22	VAN 1 TON, G / SAVANA All	
F	03-16	VAN 1 TON, G / SAVANA Coil (FrontSpringType)	
F	17-22	VAN 3/4 TON, G / SAVANA All	
F	03-16	VAN 3/4 TON, G / SAVANA Coil (FrontSpringType)	
G63896	C		
R	92-99	CHEVROLET SUBURBAN 1/2 TON, C15 / C1500 All	
R	92-99	SUBURBAN 3/4 TON, C25 / C2500 All	
R	95-00	TAHOE RWD Old Body Style	
R	96-14	VAN 1/2 TON, G / EXPRESS All	
R	93-99	GMC SUBURBAN 1/2 TON, C15 / C1500 All	
R	92	SUBURBAN 1/2 TON, C15 / C1500 All Old Body Style	
R	92-99	SUBURBAN 3/4 TON, C25 / C2500 All	
R	96-14	VAN 1/2 TON, G / SAVANA All	
R	00	YUKON Denali	
R	92-99	YUKON All	
G63897	A		
R	09-22	CHEVROLET EXPRESS 4500 All	
R	13-22	VAN 1 TON, G / EXPRESS All	
R	03-12	VAN 1 TON, G / EXPRESS All Single Rear Wheels	
R	03-22	VAN 3/4 TON, G / EXPRESS All	
R	10-20	GMC SAVANA 4500 All	
R	13-22	VAN 1 TON, G / SAVANA All	
R	03-12	VAN 1 TON, G / SAVANA All Single Rear Wheels	
R	03-22	VAN 3/4 TON, G / SAVANA All	
G63902	D		140857
F	81-82	CHEVROLET LUV PICKUP RWD	
F	81-95	ISUZU PICKUP RWD	
F	69-72	NISSAN 521 PICKUP All	
F	72-79	620 PICKUP All	
F	80-86	720 PICKUP All	
F	87-97	PICKUP 4WD	
F	86	PICKUP 4WD Mfg. from 8/86	
G63903	C		141376
F	85-95	TOYOTA PICKUP RWD Exc. 1 Ton	
F	84	PICKUP RWD	
F	93-98	T100 RWD	
G63904	W		141356
F	87-90	MITSUBISHI VAN All	
F	87-95	NISSAN PATHFINDER All Exc. Electronic Adjustable Suspension	
G63905	A		140126
F	97-04	DODGE DAKOTA 4WD	

Ultra Truck Shock

Shock	POP	Alternative No.	MTG Acc. Supplied
Pos.	Year	Application	
G63905	A (cont)		140126
F	98-03	DURANGO 4WD	
G63907	A		
R	75-80	CHEVROLET LUV PICKUP All	
R	72-74	LUV PICKUP All	
R	79-82	DODGE D50 RWD	
R	87-93	PICKUP, RAM 50 RWD	
R	83-86	PICKUP, RAM 50 All	
R	86-87	MAZDA B2000 RWD	
R	87-93	B2200 RWD	
R	87-93	B2600 RWD	
R	95-96	MITSUBISHI MIGHTY MAX All	
R	83-94	MIGHTY MAX RWD	
R	87-90	VAN All	
R	98-04	NISSAN FRONTIER RWD Exc. Desert Runner	
R	87-97	PICKUP RWD	
R	86	PICKUP RWD Mfg. from 8/86	
R	79-82	PLYMOUTH PICKUP All	
R	85-95	TOYOTA PICKUP RWD Exc. 1 Ton	
R	75-84	PICKUP RWD Mojave	
R	70-74	PICKUP All RWD	
R	84-88	VAN Leaf (RearSpringType)	
R	88	VAN WAGON All Leaf (RearSpringType)	
G63909	B		141368
F	81-82	CHEVROLET LUV PICKUP 4WD	
F	75-80	LUV PICKUP All	
F	72-74	LUV PICKUP All	
F	89-94	ISUZU AMIGO All	
F	81-95	PICKUP 4WD	
F	84-86	TROOPER 4WD	
F	98-04	NISSAN FRONTIER RWD Exc. Desert Runner	
F	87-97	PICKUP RWD	
F	86	PICKUP RWD Mfg. from 8/86	
G63915	B		140126
F	87-04	DODGE DAKOTA RWD	
F	99-03	DURANGO RWD	
G63918	W		
R	07-09	DODGE SPRINTER 2500 All Single Rear Wheels	
R	03-06	SPRINTER 2500 All Exc. Dual Rear Wheels	
R	07-09	SPRINTER 3500 All Single Rear Wheels	
R	03-06	SPRINTER 3500 All Exc. Dual Rear Wheels	
R	02-06	FREIGHTLINER SPRINTER 2500 All	
R	04-06	MERCEDES-BENZ SPRINTER All Exc. Dual Rear Wheels	
G63928	W		
R	89-94	ISUZU AMIGO All	
R	81-95	PICKUP 4WD	
R	84-86	TROOPER 4WD	
G63929	D		140780
F	92-07	FORD VAN 1/2 TON, ECONOLINE / CLUB WAGON All	
G63937	D		140673
F	01-04	TOYOTA TACOMA S-Runner	
F	04	TACOMA Base, RWD	
F	95-03	TACOMA DLX, RWD	
G63950	W		140455
F	79-82	DODGE D50 RWD	
F	83-93	PICKUP, RAM 50 RWD	
F	83-96	MITSUBISHI MIGHTY MAX RWD	
F	79-82	PLYMOUTH PICKUP All	
G63958	A		143276
F	06-08	DODGE PICKUP 1/2 TON, RAM 1500 (SEE RAM 1500) Crew Cab Pickup, RWD	
F	06-08	PICKUP 1/2 TON, RAM 1500 (SEE RAM 1500) Standard Cab Pickup, RWD	
F	02-05	PICKUP 1/2 TON, RAM 1500 (SEE RAM 1500) RWD	
G63959	A		
R	18-21	CHEVROLET PICKUP 1/2 TON, SILVERADO 1500 All Exc. Payload Package	
R	08-17	PICKUP 1/2 TON, SILVERADO 1500 All Exc. Electronic Adjustable Suspension	

Numerical listing

Shock	POP	Alternative No.	MTG Acc. Supplied
Pos.	Year	Application	
G63959	A (cont)		
R	07	PICKUP 1/2 TON, SILVERADO 1500 Base Exc. Electronic Adjustable Suspension	
R	07	PICKUP 1/2 TON, SILVERADO 1500 LT Exc. Electronic Adjustable Suspension	
R	07	PICKUP 1/2 TON, SILVERADO 1500 LTZ Exc. Electronic Adjustable Suspension	
R	07	PICKUP 1/2 TON, SILVERADO 1500 WT Exc. Electronic Adjustable Suspension	
R	18-21	GMC SIERRA 1500 All Exc. Payload Package	
R	08-17	SIERRA 1500 All Exc. Electronic Adjustable Suspension	
R	07	SIERRA 1500 SLE Exc. Electronic Adjustable Suspension	
R	07	SIERRA 1500 SLT Exc. Electronic Adjustable Suspension	
R	07	SIERRA 1500 WT Exc. Electronic Adjustable Suspension	
R	19	SIERRA 1500 LIMITED All Exc. Payload Package	
G63961	W		
R	06-08	DODGE PICKUP 1/2 TON, RAM 1500 (SEE RAM 1500) 4WD Exc. Mega Cab	
G63962	W		
R	06-08	DODGE PICKUP 1/2 TON, RAM 1500 (SEE RAM 1500) RWD Exc. Mega Cab	
G63965	C		
R	09-10	HUMMER H3 All	
R	06-10	H3 All	
G63966	D		
R	07-17	JEEP WRANGLER All Exc. Models w/ 17" Wheels	
G63967	C		
R	13-17	JEEP WRANGLER All Models w/ 17" Wheels; w/Heavy Duty Suspension	
R	07-12	WRANGLER All Models w/ 17" Wheels	
G63969	W		143146
F	05-08	FORD PICKUP, F-450 SUPERDUTY All	
F	05-07	PICKUP, F-550 SUPERDUTY All	
G63971	W		
R	03-07	DODGE PICKUP 1 TON, RAM 3500 (SEE RAM 3500) Crew Cab Pickup, RWD	
R	03-08	PICKUP 3/4 TON, RAM 2500 (SEE RAM 2500) Crew Cab Pickup, RWD	
G64000	C		
R	16-19	CHEVROLET SUBURBAN 3500 HD All	
R	03-09	HUMMER H2 All	
G64001	B		143276
F	09-10	HUMMER H3 All	
F	06-10	H3 All	
G64002	W		
R	98-02	LINCOLN NAVIGATOR 4WD, Air (RearSpringType)	
G64003	B		
R	01-06	ACURA MDX All	
R	03-08	HONDA PILOT All	
G64006	C		141041
R	17-21	TOYOTA TACOMA Edicion Especial, 4WD	
R	17-21	TACOMA Sport, 4WD	
R	16-21	TACOMA Limited, 4WD	
R	16-21	TACOMA SR, 4WD	
R	16-21	TACOMA TRD Off-Road, 4WD	
R	16-21	TACOMA TRD Sport, 4WD	
R	21	TACOMA Nightshade, 4WD	
R	21	TACOMA Trail, 4WD	
R	16-17	TACOMA SR5, 4WD	
R	13-15	TACOMA 4WD Exc. Off Road	
R	05-12	TACOMA 4WD	
G64008	C		142973
F	07-12	JEEP WRANGLER All	

Numerical listing

Shock	POP	Alternative No.	MTG Acc. Supplied
Pos.	Year	Application	
G64009	W		142731
F	15-18	RAM 2500 (SEE DODGE RAM 2500) Power Wagon, 4WD	
F	11-14	2500 (SEE DODGE RAM 2500) 4WD	
G64010	D		
R	05-16	FORD PICKUP 1 TON, F-350 / SUPERDUTY RWD	
R	11-16	PICKUP 3/4 TON, F-250 / SUPERDUTY RWD Exc. Off Road	
R	05-10	PICKUP 3/4 TON, F-250 / SUPERDUTY RWD	
G64011	W		142731
F	05-08	DODGE PICKUP 3/4 TON, RAM 2500 (SEE RAM 2500) 4WD	
G64012	B		
R	06-10	JEEP COMMANDER All	
R	05-10	GRAND CHEROKEE All	
G64013	W		
R	03-10	DODGE PICKUP 3/4 TON, RAM 2500 (SEE RAM 2500) 4WD 8800# GVW	
R	11-13	RAM 2500 (SEE DODGE RAM 2500) 4WD	
G64014	D		
R	06-09	CHEVROLET TRAILBLAZER Air (RearSpringType)	
R	02-05	TRAILBLAZER All Air(RearSpringType)	
R	03-06	GMC ENVOY Air (RearSpringType)	
G64015	A		
R	05-13	CHEVROLET EQUINOX All	
R	10-13	GMC TERRAIN All	
R	06-09	PONTIAC TORRENT All	
R	07-09	SUZUKI XL-7 All Exc. 3rd Row Seating	
G64016	C		
F	07-09	CHRYSLER ASPEN All	
F	04-09	DODGE DURANGO All	
G64026	A		
R	06-12	TOYOTA RAV4 All	
G64027	W		
F	00-04	MITSUBISHI MONTERO SPORT All	
G64028	W		
R	00-04	MITSUBISHI MONTERO SPORT All	
G64029	W		142731
R	07-14	TOYOTA FJ CRUISER RWD	
G64030	W		142731
R	11-14	TOYOTA FJ CRUISER 4WD	
R	07-09	FJ CRUISER 4WD	
G64031	C		
R	20-21	NISSAN FRONTIER All Exc. Nismo Off Road	
R	14-19	FRONTIER All	
R	09-13	FRONTIER All Exc. Nismo Off Road	
R	05-08	FRONTIER LE	
R	05-08	FRONTIER SE	
R	05-08	FRONTIER XE	
R	09-12	SUZUKI EQUATOR All	
G64032	W		
R	03-06	KIA SORENTO All Exc. Self-Leveling Suspension	
G64033	B		
R	12-13	NISSAN PATHFINDER All Mfg. to 9/12	
R	05-11	PATHFINDER All	
G64037	C		
R	07-10	FORD EDGE All	
R	07-09	LINCOLN MKX All	
G64038	D		143340
R	07-20	TOYOTA TUNDRA All	
G64040	A		
R	08-17	BUICK ENCLAVE All	
R	09-17	CHEVROLET TRAVERSE All	
R	07-16	GMC ACADIA All	
R	17	ACADIA LIMITED All	
R	07-10	SATURN OUTLOOK All	

Ultra Truck Shock, Ultra Shock

Shock	POP	Alternative No.	MTG Acc. Supplied
Pos.	Year	Application	
G64042	A		
R	08-16	CHRYSLER TOWN & COUNTRY All Exc. Self-Leveling Suspension	
R	19-20	DODGE CARAVAN / GRAND CARAVAN All	
R	17-18	CARAVAN / GRAND CARAVAN SE	
R	17-18	CARAVAN / GRAND CARAVAN SXT	
R	17-18	CARAVAN / GRAND CARAVAN SXT Plus	
R	18	CARAVAN / GRAND CARAVAN Blacktop	
R	18	CARAVAN / GRAND CARAVAN Canada Value Package	
R	18	CARAVAN / GRAND CARAVAN Crew	
R	18	CARAVAN / GRAND CARAVAN Crew Plus	
R	18	CARAVAN / GRAND CARAVAN SXT Premium Plus	
R	08-16	CARAVAN / GRAND CARAVAN All Exc. Self-Leveling Suspension	
R	12-15	RAM C/V All Exc. Load Leveling	
R	09-14	VOLKSWAGEN ROUTAN All Exc. Self-Leveling Suspension	
G64043	D		
F	09-10	DODGE PICKUP 1/2 TON, RAM 1500 (SEE RAM 1500) RWD	
F	16-18	RAM 1500 (SEE DODGE RAM 1500) RWD Exc. Air Suspension	
F	11-15	1500 (SEE DODGE RAM 1500) RWD	
F	19-20	1500 CLASSIC RWD Old Body Style	
F	11-15	2500 (SEE DODGE RAM 2500) Standard Cab Pickup, RWD	
F	11-15	3500 (SEE DODGE RAM 3500) Standard Cab Pickup, RWD	
G64044	C		
R	09-10	DODGE PICKUP 1/2 TON, RAM 1500 (SEE RAM 1500) All	
R	11-18	RAM 1500 (SEE DODGE RAM 1500) All	
R	19-20	1500 CLASSIC 4WD	
G64046	C		
R	00-06	BMW X5 All	
G64047	B		
R	08-12	FORD ESCAPE All	
R	08-11	MAZDA TRIBUTE All	
R	08-11	MERCURY MARINER All	
G64048	C		
R	07-09	HYUNDAI SANTA FE All	
R	07-12	VERACRUZ All	
G64049	D		
F	00-03	MERCEDES-BENZ ML55 AMG All	
F	98-03	ML320 All	
F	03-05	ML350 All	
F	99-01	ML430 All	
F	02-05	ML500 All	
G64050	B		
R	08-20	NISSAN ROGUE All	
R	14-15	ROGUE SELECT All	
R	19-20	X-TRAIL All	
R	10-12	X-TRAIL All	
R	08	X-TRAIL All	
G64052	D		
R	06-13	SUZUKI GRAND VITARA All	
G64056	W		
R	07-10	MAZDA CX-7 All	
G64063	W		
R	07-10	FORD TRANSIT All	
G64071	C		
R	07-08	HYUNDAI ENTOURAGE All	
R	14	KIA SEDONA All	
R	06-12	SEDONA All	
G64079	B		
R	09-21	FORD LOBO 4WD	
R	09-22	PICKUP 1/2 TON, F-150 4WD	
R	10-12	LINCOLN MARK LT All	
G64080	B		
R	07-13	ACURA MDX All Exc. Active Suspension	
R	10-13	ZDX All Exc. Electronic Suspension	

Numerical listing

Shock	POP	Alternative No.	MTG Acc. Supplied
Pos.	Year	Application	
G64087	C		143426
R	01-07	TOYOTA SEQUOIA All	
G64089	N		
R	07-10	MERCEDES-BENZ SPRINTER All	
R	11-20	SPRINTER 3500 All	
G64101	A		
R	20	CHEVROLET SUBURBAN 1/2 TON, 1500 All Old Body Style	
R	12-19	SUBURBAN 1/2 TON, 1500 All	
R	11-19	TAHOE All Exc. Police Package	
R	12-20	GMC YUKON All Old Body Style	
R	15-20	YUKON XL All Old Body Style	
R	12-14	YUKON XL 1/2 TON All	
G64104	C		
R	09-15	HONDA PILOT All	
G64105	W		
R	02-06	SUZUKI XL-7 All	
G64111	D		
R	11-14	FORD EDGE All	
R	11-15	LINCOLN MKX All	
G64121	D		
R	15-18	CHEVROLET PICKUP 1 TON, SILVERADO 3500 All	
R	11-13	PICKUP 1 TON, SILVERADO 3500 All	
R	15-22	PICKUP 1 TON, SILVERADO 3500 HD All	
R	11-18	PICKUP 3/4 TON, SILVERADO 2500 All	
R	11-22	PICKUP 3/4 TON, SILVERADO 2500 HD All	
R	11-22	GMC SIERRA 2500 HD All	
R	11-22	SIERRA 3500 HD All	
R	14-20	RAM 3500 (SEE DODGE RAM 3500) 4WD	
G64140	D		
R	14-17	CHEVROLET EQUINOX All	
R	14-17	GMC TERRAIN All	
G64143	N		
R	13-16	HYUNDAI SANTA FE FWD	
G64146	C		
R	15-18	CHEVROLET CITY EXPRESS All	
R	13-19	NISSAN NV200 All	
G64148	W		
F	11-22	CHEVROLET PICKUP 1 TON, SILVERADO 3500 HD All	
F	11-22	PICKUP 3/4 TON, SILVERADO 2500 HD All	
F	11-22	GMC SIERRA 2500 HD All	
F	11-22	SIERRA 3500 HD All	
G64151	N		
R	15-17	LEXUS NX200T All	
R	13-17	TOYOTA RAV4 All	
G64157	D		
R	11-20	FORD LOBO RWD	
R	11-22	PICKUP 1/2 TON, F-150 RWD	
G64163	W		
R	11-17	LEXUS RX350 All	
G64164	W		
R	12-19	NISSAN NV1500 All	
R	12-19	NV2500 All	
R	12-19	NV3500 All	
G64177	N		
R	15-22	FORD TRANSIT-150 All	
R	15-22	TRANSIT-250 All	
R	15-22	TRANSIT-350 All	
G64186	N		
R	14-18	TOYOTA HIGHLANDER All	
G64216	W		
R	10-15	HYUNDAI TUCSON AWD	
R	11-16	KIA SPORTAGE AWD	
Ultra Shock			
G6920	W		
R	00-06	AUDI TT All	
G69450	B		
R	00-05	TOYOTA ECHO All	

Numerical listing

Shock	POP	Alternative No.	MTG Acc. Supplied
Pos.	Year	Application	
69462	W		
R	92-96	EAGLE SUMMIT	Wagon
R	92-95	MINI EXPO	All
R	92-94	PLYMOUTH COLT	Wagon
69464	B 142950		
R	08-11	FORD FOCUS	All
R	00-07	FOCUS	Hatchback
R	00-07	FOCUS	Sedan
69465	B		
R	00-07	FORD FOCUS	Wagon
69473	B		
R	01-10	CHRYSLER PT CRUISER	All
69574	B 140505		
R	03-11	FORD CROWN VICTORIA	Police Interceptor
R	03-11	LINCOLN TOWN CAR	All Limo Models
69575	B 140505		
R	10-11	FORD CROWN VICTORIA	Base Exc. Police and Taxi Models
R	03-11	CROWN VICTORIA LX	Exc. Police and Taxi Models
R	03-08	CROWN VICTORIA	Base Exc. Police and Taxi Models
R	04-06	CROWN VICTORIA LX	Sport Exc. Police and Taxi Models
R	05	CROWN VICTORIA S	Exc. Police and Taxi Models
R	05	CROWN VICTORIA	Special Edition Exc. Police and Taxi Models
R	03	CROWN VICTORIA	LWB Exc. Police and Taxi Models
R	03	CROWN VICTORIA S	Exc. Police and Taxi Models
R	03-11	LINCOLN TOWN CAR	All
R	03-11	MERCURY GRAND MARQUIS	All
R	03-04	MARAUDER	All
69585	B		
R	01-03	KIA RIO	All
69586	D 142155		
R	01-08	AUDI A4	All
R	01-08	A4 QUATTRO	All Mfg. from 11/00; Exc. Sport Suspension
69587	A		
R	05-10	CHEVROLET COBALT	LS
R	05-10	COBALT	LT
R	10	COBALT	Base
R	10	COBALT	LT Team Canada
R	06-07	COBALT	LTZ
R	05	COBALT	Base
R	11	HHR	All
R	08-10	HHR	LS Panel
R	08-10	HHR	LT Panel
R	06-10	HHR	LS
R	06-10	HHR	LT
R	06-08	HHR	Comfort LT
R	06-08	HHR	Elegance LT
R	07	HHR	Edicion Especial
R	07-09	PONTIAC G5	All
R	05-06	PURSUIT	All
R	08-09	SATURN ASTR	All
R	03-07	ION	All
69589	C		
R	08	CHEVROLET MALIBU	Classic LS
R	08	MALIBU	Classic LT
R	06-07	MALIBU	LTZ
R	06-07	MALIBU	SS
R	04-07	MALIBU	LS
R	04-07	MALIBU	LT
R	04-05	MALIBU	Base
69590	A 143269		
R	09-12	CHEVROLET MALIBU	All
R	08	MALIBU	Hybrid
R	08	MALIBU	LS
R	08	MALIBU	LT
R	08	MALIBU	LTZ
R	04-07	MALIBU	Maxx LS
R	04-07	MALIBU	Maxx LT
R	04	MALIBU	Maxx
R	05-10	PONTIAC G6	All
R	07-09	SATURN AURA	XE
R	07-09	AURA	XR
69591	A		
R	06-12	FORD FUSION	FWD
R	07-12	LINCOLN MKZ	FWD
R	06	ZEPHYR	All

Ultra Shock

Shock	POP	Alternative No.	MTG Acc. Supplied
Pos.	Year	Application	
69591	A (cont)		
R	03-08	MAZDA 6	All
R	06-11	MERCURY MILAN	FWD
69592	C 140524		
R	05-14	FORD MUSTANG / MUSTANG II	Coupe
69593	C 140524		
R	05-14	FORD MUSTANG / MUSTANG II	Convertible
69594	W		
R	13-15	NISSAN XTERRA	RWD
R	12	XTERRA	RWD Mfg. to 12/12
R	05-11	XTERRA	RWD
69595	C		
R	13-15	NISSAN XTERRA	4WD
R	12	XTERRA	4WD Mfg. to 12/12
R	05-11	XTERRA	4WD
69600	A 140455		
F	87-91	AVANTI II	All
F	74-75	BUICK APOLLO	All
F	73-81	CENTURY	All
F	68-72	GS / GS350 / GS400 / GS455	All
F	73-87	REGAL	All
F	75-79	SKYLARK	All
F	68-72	SKYLARK	All
F	68-69	SPECIAL	All
F	68-72	SPORTWAGON	All
F	76-79	CADILLAC SEVILLE	All
F	67-69	CHEVROLET CAMARO	All
F	68-73	CHEVELLE	All
F	68	CHEVY II	All
F	73-83	MALIBU	All
F	70-88	MONTE CARLO	All
F	69-79	NOVA	All
F	64-65	NISSAN 410	All
F	64-67	411	All
F	68-87	OLDSMOBILE CUTLASS /	CUTLASS SUPREME All
F	80-84	CUTLASS CALAIS	All
F	80-83	CUTLASS CLASSIC / CUTLASS	CRUISER All
F	68-72	F85	All
F	74-79	OMEGA	All
F	73	OMEGA	All Exc. Heavy Duty Suspension
F	68-75	VISTA	CRUISER All
F	82-86	PONTIAC BONNEVILLE	All
F	67-69	FIREBIRD	All
F	78-80	GRAND AM	All
F	73-75	GRAND AM	All
F	75-83	GRAND LEMANS	All
F	69-87	GRAND PRIX	All
F	71-75	GRANDVILLE	All
F	68-73	GTO	All
F	68-81	LEMANS	All
F	77-79	PHOENIX	All
F	68-70	TEMPEST	All
F	71-77	VENTURA	All
F	78	TOYOTA CORONA	All
F	73-77	CORONA	All Mfg. from 8/73
F	69-72	CORONA	Mark II
F	68-75	VOLVO 142 / 144 / 145 / 164	All
69604	A 140629		
R	87-88	AVANTI II	All
R	73-81	BUICK CENTURY	All
R	71-83	ESTATE WAGON	All
R	65-67	GRAN SPORT	All
R	68-72	GS / GS350 / GS400 / GS455	All
R	73-87	REGAL	All
R	91-96	ROADMASTER	Wagon
R	68-72	SKYLARK	All
R	64-67	SKYLARK	All Heavy Duty Suspension
R	68-69	SPECIAL	All
R	64-67	SPECIAL	All Heavy Duty Suspension
R	70-72	SPORTWAGON	All
R	71-72	CHEVROLET BROOKWOOD	All
R	71-96	CAPRICE	Wagon
R	68-73	CHEVELLE	All
R	64-67	CHEVELLE	All Heavy Duty Suspension
R	71-82	IMPALA	Wagon
R	71-72	KINGSWOOD	All
R	73-83	MALIBU	All
R	64-67	MALIBU	All Heavy Duty Suspension
R	70-88	MONTE CARLO	All
R	71-72	TOWNSMAN	All
R	75-76	NISSAN 610	Wagon
R	73-74	610	All

Numerical listing

Shock	POP	Alternative No.	MTG Acc. Supplied
Pos.	Year	Application	
69604	A (cont) 140629		
R	74-77	710	Wagon
R	78-80	810	Wagon
R	71-92	OLDSMOBILE CUSTOM CRUISER	All
R	71-87	CUTLASS / CUTLASS SUPREME	All
R	68-72	CUTLASS / CUTLASS SUPREME	All Heavy Duty Suspension
R	64-66	CUTLASS / CUTLASS SUPREME	All Heavy Duty Suspension
R	80-84	CUTLASS CALAIS	All
R	80-83	CUTLASS CLASSIC / CUTLASS	CRUISER All
R	68-72	F85	All
R	61-67	F85	All Heavy Duty Suspension
R	71-78	TORONADO	All
R	82-86	PONTIAC BONNEVILLE	All
R	77-81	CATALINA	Wagon
R	71-75	CATALINA	Wagon
R	78-80	GRAND AM	All
R	73-75	GRAND AM	All
R	75-83	GRAND LEMANS	All
R	69-87	GRAND PRIX	All
R	71-78	GRAND SAFARI	All
R	71-75	GRANDVILLE	All
R	68-73	GTO	All
R	64-67	GTO	All Heavy Duty Suspension
R	68-81	LEMANS	All
R	64-67	LEMANS	All Heavy Duty Suspension
R	80-86	PARISIENNE	Wagon
R	76-79	PARISIENNE	All Wagon
R	87-89	SAFARI	All
R	68-70	TEMPEST	All
R	64-67	TEMPEST	All Heavy Duty Suspension
69606	A 141150		
R	64-69	BUICK SPORTWAGON	All
R	68-69	CHEVROLET CAMARO	All Multi-Leaf Models
R	65-74	FORD COUNTRY SEDAN	All
R	87-91	COUNTRY SQUIRE	All
R	65-74	COUNTRY SQUIRE	All
R	92-02	CROWN VICTORIA	All
R	65-72	CUSTOM	All
R	68-77	CUSTOM 500	All
R	75-76	ELITE	All
R	66-70	FAIRLANE	All Wagon; Multi-Leaf Rear Spring
R	66-70	FALCON	All Wagon; Multi-Leaf Rear Spring
R	65-67	GALAXIE	All
R	68-74	GALAXIE 500	All
R	64-66	GALAXIE 500	All
R	01-02	GRAND MARQUIS	All
R	87-91	LTD / COUNTRY SEDAN /	COUNTRY SQUIRE / CROWN VICTORIA All
R	65-82	LTD / COUNTRY SEDAN /	COUNTRY SQUIRE / CROWN VICTORIA All
R	77-79	LTD II	All
R	66-79	RANCHERO	All
R	65-74	RANCH WAGON	All
R	77-79	THUNDERBIRD	All
R	67-72	THUNDERBIRD	All
R	68-76	TORINO	All
R	70-80	LINCOLN CONTINENTAL	All
R	68-71	MARK III	All
R	72	MARK IV	All
R	80-83	MARK VI	All
R	81-02	TOWN CAR	All
R	67	MERCURY BROUGHAM	All
R	87-91	COLONY PARK	All
R	65-74	COLONY PARK	All
R	66-67	COMET	Wagon
R	65-68	COMMUTER	All
R	74-79	COUGAR	All
R	75-02	GRAND MARQUIS	All
R	69-70	MARAUDER	All
R	65-67	MARAUDER	All
R	67-82	MARQUIS	All
R	65-68	MONTCLAIR	All
R	68-76	MONTEGO	All
R	65-74	MONTEREY	All
R	65-68	PARKLANE	All
R	65-67	VILLAGER	All
R	66-67	VOYAGER	All
R	64-72	OLDSMOBILE VISTA	CRUISER All
R	68-69	PONTIAC FIREBIRD	All
69622	A		
R	63-82	CHEVROLET CORVETTE	All

Numerical listing

Shock	POP	Alternative No.	MTG Acc. Supplied
Pos.	Year	Application	
69624 B 140524			
R	70-81	CHEVROLET CAMARO All	
R	70-81	PONTIAC FIREBIRD All	
69625 A 140877			
F	55-57	CHEVROLET BEL AIR All	
F	63-82	CORVETTE All	
F	55-57	ONE-FIFTY SERIES All	
F	55-57	TWO-TEN SERIES All	
69632 D			
R	84-93	CHRYSLER DAYTONA All	
R	83-84	E CLASS All	
R	85	EXECUTIVE LIMOUSINE All	
R	83-84	EXECUTIVE SEDAN All	
R	90-93	IMPERIAL All Exc. Hydraulic Self-Leveling System	
R	84-86	LASER All	
R	81-95	LEBARON All	
R	88-93	NEW YORKER All Exc. Hydraulic Self-Leveling System	
R	83-87	NEW YORKER All	
R	92-95	SPIRIT All	
R	82-88	TOWN & COUNTRY All	
R	82-83	DODGE 400 All	
R	83-88	600 All	
R	81-89	ARIES All	
R	92-93	DAYTONA Iroc R/T	
R	91-93	DAYTONA Iroc	
R	89-93	DAYTONA ES	
R	89-90	DAYTONA ES Turbo	
R	87-88	DAYTONA Pacifica	
R	86	DAYTONA Turbo Z	
R	84-85	DAYTONA Turbo	
R	85-89	LANCER All	
R	87-94	SHADOW All	
R	89-95	SPIRIT All	
R	89-95	PLYMOUTH ACCLAIM All	
R	88	CARAVELLE FWD	
R	83-87	CARAVELLE All	
R	81-89	RELIANT All	
R	87-94	SUNDANCE All	
69675 A 141041			
F	71-73	BUICK CENTURION All	
F	91-96	COMMERCIAL CHASSIS All	
F	71-84	ELECTRA All	
F	71-83	ESTATE WAGON All	
F	71-85	LESABRE All	
F	71-78	RIVIERA All	
F	92-96	ROADMASTER All	
F	91	ROADMASTER Wagon	
F	87-92	CADILLAC BROUGHAM All	
F	92-96	COMMERCIAL CHASSIS RWD	
F	77-84	COMMERCIAL CHASSIS All	
F	77-84	DEVILLE All	
F	93-96	FLEETWOOD RWD	
F	77-86	FLEETWOOD RWD	
F	81	CHEVROLET BEL AIR Sedan Exc. Police and Taxi Models	
F	65-75	BEL AIR Sedan Exc. Police and Taxi Models	
F	71-72	BISCAYNE All	
F	69-72	BROOKWOOD All	
F	70-81	CAMARO All	
F	66-96	CAPRICE All	
F	94-96	IMPALA All	
F	65-85	IMPALA All	
F	69-72	KINGSWOOD All	
F	69-72	TOWNSMAN All	
F	65-74	FORD COUNTRY SEDAN All	
F	87-91	COUNTRY SQUIRE All	
F	65-74	COUNTRY SQUIRE All	
F	92-02	CROWN VICTORIA All	
F	65-72	CUSTOM All	
F	68-77	CUSTOM 500 All	
F	75-76	ELITE All	
F	65-67	GALAXIE All	
F	68-74	GALAXIE 500 All	
F	64-66	GALAXIE 500 All	
F	01-02	GRAND MARQUIS All	
F	87-91	LTD / COUNTRY SEDAN / COUNTRY SQUIRE / CROWN VICTORIA All	
F	65-82	LTD / COUNTRY SEDAN / COUNTRY SQUIRE / CROWN VICTORIA All	
F	77-79	LTD II All	
F	65-74	RANCH WAGON All	
F	67-79	THUNDERBIRD All	
F	72-76	TORINO All	
F	70-80	LINCOLN CONTINENTAL All	
F	68-71	MARK III All	
F	72-76	MARK IV All	
F	77-79	MARK V All	

Ultra Shock

Shock	POP	Alternative No.	MTG Acc. Supplied
Pos.	Year	Application	
69675 A (cont) 141041			
F	80-83	MARK VI All	
F	81-02	TOWN CAR All	
F	67	MERCURY BROUGHAM All	
F	87-91	COLONY PARK All	
F	65-74	COLONY PARK All	
F	65-68	COMMUTER All	
F	74-79	COUGAR All	
F	75-02	GRAND MARQUIS All	
F	69-70	MARAUDER All	
F	65-67	MARAUDER All	
F	67-82	MARQUIS All	
F	65-68	MONTCLAIR All	
F	72-76	MONTEGO All	
F	65-74	MONTEREY All	
F	65-68	PARKLANE All	
F	65-67	VILLAGER All	
F	66-67	VOYAGER All	
F	71-85	OLDSMOBILE 88 SERIES All	
F	71-84	98 All	
F	71-92	CUSTOM CRUISER All	
F	71-81	PONTIAC BONNEVILLE All	
F	71-81	CATALINA All	
F	70-81	FIREBIRD All	
F	71-78	GRAND SAFARI All	
F	76-81	LAURENTIAN All	
F	76-86	PARISIENNE All	
F	87-89	SAFARI All	
69676 A 142261			
R	82-02	CHEVROLET CAMARO All	
R	82-02	PONTIAC FIREBIRD All	
69677 D 141350			
F	72-86	JAGUAR XJ6 All	
F	81-92	XJ12 All	
F	73-79	XJ12 All	
F	76-96	XJS All	
69714 C 141147			
F	84-87	CHEVROLET CORVETTE All	
69715 C 141147			
R	84-87	CHEVROLET CORVETTE All	
69724 A 140629			
R	89-91	AVANTI II All	
R	73	BUICK APOLLO All Heavy Duty Suspension	
R	71-73	CENTURION All	
R	71-84	ELECTRA All	
R	70	ESTATE WAGON All	
R	71-85	LESABRE All	
R	71-78	RIVIERA All	
R	92-96	ROADMASTER Sedan	
R	64-67	SKYLARK All Exc. Heavy Duty Suspension	
R	64-67	SPECIAL All Exc. Heavy Duty Suspension	
R	87-92	CADILLAC BROUGHAM All	
R	92-96	COMMERCIAL CHASSIS RWD	
R	77-84	COMMERCIAL CHASSIS All	
R	77-84	DEVILLE All	
R	93-96	FLEETWOOD RWD	
R	77-86	FLEETWOOD RWD	
R	81	CHEVROLET BEL AIR Sedan	
R	65-75	BEL AIR All	
R	65-72	BISCAYNE All	
R	69-70	BROOKWOOD All	
R	73-96	CAPRICE Sedan Police and Taxi Models	
R	71-72	CAPRICE Hardtop Police and Taxi Models	
R	66-70	CAPRICE All	
R	64-67	CHEVELLE All Exc. Heavy Duty Suspension	
R	68	CHEVY II All	
R	64-67	EL CAMINO All Exc. Heavy Duty Suspension	
R	94-96	IMPALA All	
R	83-85	IMPALA All	
R	81-82	IMPALA Sedan	
R	81	IMPALA Coupe	
R	74-80	IMPALA Coupe Exc. Wagon	
R	74-80	IMPALA Sedan Exc. Wagon	
R	71-73	IMPALA Sedan	
R	73	IMPALA Hardtop	
R	65-70	IMPALA All	
R	69-70	KINGSWOOD All	
R	64-67	MALIBU All Exc. Heavy Duty Suspension	
R	73	NOVA All Heavy Duty Suspension	
R	69-72	NOVA All	
R	69-70	TOWNSMAN All	
R	65-85	OLDSMOBILE 88 SERIES All	
R	65-84	98 All	

Numerical listing

Shock	POP	Alternative No.	MTG Acc. Supplied
Pos.	Year	Application	
69724 A (cont) 140629			
R	64-67	CUTLASS / CUTLASS SUPREME All Exc. Heavy Duty Suspension	
R	65-66	DYNAMIC 88 All	
R	61-67	F85 All Exc. Heavy Duty Suspension	
R	65-66	STARFIRE All	
R	63-81	PONTIAC BONNEVILLE All	
R	75-81	CATALINA Coupe	
R	71-81	CATALINA Sedan	
R	71-74	CATALINA Hardtop	
R	63-70	CATALINA All	
R	67-70	EXECUTIVE All	
R	63-68	GRAND PRIX All	
R	64-67	GTO All Exc. Heavy Duty Suspension	
R	76-81	LAURENTIAN All	
R	64-67	LEMANS All Exc. Heavy Duty Suspension	
R	76-86	PARISIENNE Sedan	
R	63-66	STAR CHIEF All	
R	64-67	TEMPEST All Exc. Heavy Duty Suspension	
R	73	VENTURA All Heavy Duty Suspension	
R	71-72	VENTURA All Leaf(RearSpringType)	
69725 W 140814			
R	91	BMW 318i All	
R	84-85	318i All	
R	91	318iS All	
R	86-88	325 All	
R	84-87	325E All	
R	87-92	325i E30 (MfrBodyCode) Exc. Sport Suspension	
R	87-92	325iS All	
R	88-91	M3 All	
69755 W 141301			
R	87-93	FORD MUSTANG / MUSTANG II GT, 5.0L 8Cyl V (302), 4.00 101.6(Bore)3.00 76.2(Stroke)	
R	84-86	MUSTANG / MUSTANG II SVO	
R	82-86	MUSTANG / MUSTANG II GT	
69757 W 140045			
R	84-89	NISSAN 300ZX All	
69766 W 140800			
R	68-73	MERCEDES-BENZ 200D All	
R	68-73	220 / 220D All	
R	74-78	230 All	
R	68-69	230 All	
R	74-83	240D All	
R	68-70	250 All	
R	87-89	260E All Exc. Hydromat Suspension	
R	76	280 All	
R	73-76	280C All	
R	77-81	280CE / 280E / 280S / 280SE / 280SEL All	
R	75-80	280CE / 280E / 280S / 280SE / 280SEL All Exc. Hydromat Suspension	
R	73	280CE / 280E / 280S / 280SE / 280SEL All Exc. Hydromat Suspension	
R	72	280CE / 280E / 280S / 280SE / 280SEL All Mfg. from 9/72; Exc. Hydromat Suspension	
R	80-85	300CD All	
R	75-84	300D All W123	
R	78-91	300SD / 300SDL / 300SE / 300SEL / 300TD / 350SD / 350SDL / 350SL / 380SE / 380SEC / 380SEL All Exc. Hydromat Suspension	
R	72	300SD / 300SDL / 300SE / 300SEL / 300TD / 350SD / 350SDL / 350SL / 380SE / 380SEC / 380SEL All	
R	81-85	380SL / 380SLC All	
R	86-91	400E / 400SE / 400SEL / 420SEL / 450SE / 450SEL All Exc. Hydromat Suspension	
R	73-80	400E / 400SE / 400SEL / 420SEL / 450SE / 450SEL All Exc. Hydromat Suspension	
R	74-80	450SL / 450SLC All	
R	84-91	500SEC / 500SEL / 500SEC / 560SEC / 560SEL All Exc. Hydromat Suspension	
69787 W			
R	75	VOLVO 142 / 144 / 145 / 164 All	
R	75-93	240 / 242 / 244 / 245 / 262 / 264 / 265 All	

Numerical listing

Shock	POP	Alternative No.	MTG Acc. Supplied
Pos.	Year	Application	
69787 W (cont)			
R	84	DL All Exc.	Hydraulic Self-Leveling System
R	84	GLE All Exc.	Hydraulic Self-Leveling System
69795 C 141666			
R	89-96	CHEVROLET CORVETTE All Exc.	Electronic Adjustable Suspension
R	88	CORVETTE All	
69811 C 141665			
F	89-96	CHEVROLET CORVETTE All Exc.	Electronic Adjustable Suspension
69813 D 140455			
R	01-05	TOYOTA RAV4 All	
R	00	RAV4 All Mfg. from 5/00	
69845 W 141743			
R	92-97	FORD THUNDERBIRD All Exc.	Electronic Adjustable Suspension
R	92-97	MERCURY COUGAR All Exc.	Electronic Adjustable Suspension
69863 D 142155			
R	92-99	BMW 318I All	
R	92-98	318IS All	
R	00	323CI All	
R	00	323I Wagon	
R	98-99	323I All	
R	98-99	323IS All	
R	01-06	325CI All	
R	01-05	325I All	
R	92-95	325I E36 (MfrBodyCode)	
R	00	328CI All	
R	96-00	328I All	
R	96-99	328IS All	
R	01-06	330CI All	
R	01-05	330I All	
69877 W 142155			
F	94-96	MERCEDES-BENZ C220 All	
F	97-00	C230 All	
F	94-00	C280 All	
69898 B 140126			
R	03-04	FORD MUSTANG / MUSTANG II Mach 1	
R	94-04	MUSTANG / MUSTANG II Base	
R	94-04	MUSTANG / MUSTANG II GT	
R	04	MUSTANG / MUSTANG II GT Base	
R	04	MUSTANG / MUSTANG II GT Equipado	
R	01	MUSTANG / MUSTANG II GT Bullitt	
R	95	MUSTANG / MUSTANG II GTS	
69900 B 140455			
R	01-07	FORD ESCAPE All	
R	01-06	MAZDA TRIBUTE All	
R	05-07	MERCURY MARINER All	
69901 D			
R	93-97	VOLVO 850 All Exc.	Hydraulic Self-Leveling System
R	98-04	C70 All	
R	98-00	S70 All	
R	98-00	V70 All Mfg. to 3/00; Exc. XC Cross Country	
69903 W			
R	95-99	BMW 318TI All	
69907 D 141716			
R	01-06	HYUNDAI SANTA FE All	
69909 C			
R	99-04	HONDA ODYSSEY All	
69945 C 142155			
R	98-10	VOLKSWAGEN BEETLE All	
R	99-06	GOLF A4 (MfrBodyCode)	
R	01-05	JETTA Sedan	
R	99-00	JETTA All	
69946 W 141191			
R	98-04	AUDI A6 All	
R	98-05	VOLKSWAGEN PASSAT FWD	From VIN# 3B300001 through VIN# 3B300000
69952 W			
F	00-02	MERCEDES-BENZ E55 AMG All	
F	96-99	E300 All Exc.	Sport Suspension
F	96-02	E320 Sedan Exc.	Sport Suspension
F	97	E420 All Exc.	4 Matic & Sport Suspension

Ultra Shock

Shock	POP	Alternative No.	MTG Acc. Supplied
Pos.	Year	Application	
69952 W (cont)			
F	98-02	E430 All Exc.	4 Matic & Sport Suspension
69962 W 141727,141354			
R	96-05	FORD TAURUS Wagon	
R	96-05	MERCURY SABLE Wagon	
69966 W			
R	99	MERCEDES-BENZ E300 All Exc.	4 Matic
R	96-98	E300 All	
R	96-02	E320 Sedan	
R	97	E420 All	
R	98-02	E430 All	
69996 W 140800,142628			
F	77-78	MERCEDES-BENZ 230 All Exc.	W115
F	76-83	240D All	W123
F	87-89	260E All Exc.	Hydromat Suspension
F	76	280 All	
F	76	280C All Exc.	W115
F	77-81	280CE / 280E / 280S / 280SE / 280SEL All	
F	75-80	280CE / 280E / 280S / 280SE / 280SEL All Exc.	Hydromat Suspension
F	73	280CE / 280E / 280S / 280SE / 280SEL All Exc.	Hydromat Suspension
F	72	280CE / 280E / 280S / 280SE / 280SEL All Mfg. from 9/72; Exc. Hydromat Suspension	
F	80-85	300CD All	
F	77-84	300D All	
F	76	300D All	W123
F	78-91	300SD / 300SDL / 300SE / 300SEL / 300TD / 350SD / 350SDL / 350SL / 380SE / 380SEC / 380SEL All Exc.	Hydromat Suspension
F	79-85	300SD / 300SDL / 300SE / 300SEL / 300TD / 350SD / 350SDL / 350SL / 380SE / 380SEC / 380SEL All	
F	86-91	400E / 400SE / 400SEL / 420SEL / 450SE / 450SEL All Exc.	Hydromat Suspension
F	73-80	400E / 400SE / 400SEL / 420SEL / 450SE / 450SEL All Exc.	Hydromat Suspension
F	84-91	500SEC / 500SEL / 500SEC / 560SEC / 560SEL All Exc.	Hydromat Suspension
69998 W			
R	01-03	BMW 525I Wagon Exc.	Electronic Adjustable Suspension
R	99-00	528I Wagon	
R	00-03	540I Wagon Exc.	Electronic Adjustable Suspension
70000 W			
R	02-05	KIA SEDONA All	
70001 W			
R	04-05	KIA RIO All	
70003 D			
R	08-09	MAZDA 3 GS	
R	08-09	3 GT	
R	08-09	3 GX	
R	07-09	3 i	
R	07-09	3 S	
R	04-06	3 All	
R	06-10	5 All	
70010 B			
R	05-10	HONDA ODYSSEY All	
70013 A			
R	06-11	HYUNDAI AZERA All	
R	06-10	SONATA All	
70020 W 142154			
R	01-02	SAAB 9-3 Turbo	
R	99-02	9-3 SE	
R	99-01	9-3 Base	
70024 D			
R	94-99	MERCEDES-BENZ S320 / S350 / S420 / S500 / S600 All Exc.	Electronic Ride Control
70027 B			
R	07-12	NISSAN SENTRA Base	
R	07-12	SENTRA S	
R	07-12	SENTRA SE-R	

Numerical listing

Shock	POP	Alternative No.	MTG Acc. Supplied
Pos.	Year	Application	
70027 B (cont)			
R	07-12	SENTRA SL	
70028 D			
R	04-06	SCION XA All	
R	04-06	XB All	
70031 D			
R	03-07	CADILLAC CTS All Exc.	Magnetic Ride Control Suspension
70033 D			
R	02-07	MERCEDES-BENZ C230 All	
R	03-05	C240 RWD	
R	01-02	C240 All	
R	06-07	C280 RWD	
R	03-05	C320 RWD	
R	01-02	C320 All	
R	06-07	C350 RWD	
R	03-05	CLK320 All	
R	06-09	CLK350 All	
R	03	CLK430 All	
R	02	CLK430 All	Mfg. from 4/02
R	03-06	CLK500 All	
R	07-09	CLK550 All	
70034 B			
R	04-10	BMW X3 All	
70036 C			
R	06-11	DODGE ATTITUDE All	
R	06-11	HYUNDAI ACCENT All	
R	06-11	KIA RIO All	
R	06-11	RIO All	
R	14-19	SOUL All	
70037 C			
R	09-10	HYUNDAI ELANTRA GL	
R	09-10	ELANTRA GLS	
R	09-10	ELANTRA L	
R	09-10	ELANTRA Limited	
R	09-10	ELANTRA SE	
R	10	ELANTRA Blue	
R	07-08	ELANTRA All Exc.	Touring Models
70038 D			
R	13-15	MERCEDES-BENZ C250 All Exc.	Electronic Suspension
R	10-12	C250 All	
R	08-09	C280 All	
R	08-11	C300 All	
R	12	C350 CGI (FuelDelSubType)	
R	08-11	C350 All	
70039 C			
R	08-11	SAAB 9-3 FWD	
R	03-07	9-3 All	
70040 D			
R	04-09	VOLVO S60 FWD	
R	01-03	S60 All	
R	99-06	S80 All	
R	01-07	V70 All Exc.	Electronic Suspension / Nivomat
70041 D			
R	12	NISSAN VERSA All	
R	07-11	VERSA S	
R	07-11	VERSA SL	
70045 B			
R	08-13	BMW 128I All	
R	12-13	135I All Exc.	Sport Suspension
R	08-11	135I All	
R	06	325I All	
R	14	328D All	
R	14	328D XDRIVE All	
R	07-14	328I All Exc.	F30 Suspension
R	07-08	328XI All	
R	06	330I All	
R	07-13	335I All	
R	11-13	335IS All	
70049 D			
R	07-10	KIA MAGENTIS All	
R	07-10	OPTIMA All	
R	07-11	RONDO All	
70052 A			
R	11-19	FORD FIESTA All	
R	11-14	MAZDA 2 All	
70053 D			
R	08-15	SCION XB All	
R	10-15	TOYOTA PRIUS All Models w/ 17" Wheels	

Numerical listing

Shock	POP	Alternative No.	MTG Acc. Supplied
Pos.	Year	Application	
70055	D		
R	08-10	SCION XD All	
R	17	TOYOTA PRIUS C All	
R	15-16	PRIUS C All Models w/ 15" or 16" Wheels	
R	12-14	PRIUS C All	
R	06-14	YARIS All	
70056	C		
R	07-13	VOLVO C30 All	
R	05-12	S40 All	
R	04	S40 All Mfg to 04/00	
R	05-11	V50 All	
70059	D		
R	10	BUICK ALLURE FWD Exc. Electronic Suspension	
R	10-16	LACROSSE FWD Exc. Electronic Suspension	
70060	D		
R	06-08	HONDA FIT All	
70064	W		
F	04-08	CHRYSLER CROSSFIRE All	
F	98-02	MERCEDES-BENZ CLK320 All	
F	99-02	CLK430 All	
F	98-04	SLK230 All	
F	03-04	SLK320 All	
F	01-02	SLK320 170.465 (MfrBodyCode)	
70065	W		
R	04-08	CHRYSLER CROSSFIRE All	
R	98-02	MERCEDES-BENZ CLK320 All	
R	02	CLK430 All Mfg. to 4/02	
R	99-01	CLK430 All	
R	98-04	SLK230 All	
R	03-04	SLK320 All	
R	01-02	SLK320 170.465 (MfrBodyCode)	
70068	A		
R	12-17	HYUNDAI AZERA All	
R	11-14	SONATA All	
R	14-16	KIA CADENZA All	
R	14-15	OPTIMA Limited	
R	14-15	OPTIMA SX Turbo	
R	14-15	OPTIMA SXL Turbo	
R	13-15	OPTIMA EX Luxury	
R	11-15	OPTIMA EX	
R	11-15	OPTIMA LX	
R	11-15	OPTIMA SX	
R	13	OPTIMA SXL	
70078	D		
R	07-09	KIA SORENTO All Exc. HPD (High Performance Dampers)	
70086	W		
R	05-10	CHRYSLER 300 AWD Exc. Nivomat Suspension	
R	07-10	DODGE CHARGER AWD Exc. Nivomat Suspension	
70089	C		
R	09-14	NISSAN MAXIMA All	
70095	B		
R	12-14	DODGE ATTITUDE All	
R	12-17	HYUNDAI ACCENT All	
R	12-17	VELOSTER All	
R	12-17	KIA RIO All	
70096	C		
R	16-19	FORD POLICE INTERCEPTOR SEDAN All	
R	18-19	TAURUS All	
R	10-17	TAURUS Limited w/ Suspension Code A and B	
R	10-17	TAURUS SE w/ Suspension Code A and B	
R	10-17	TAURUS SEL w/ Suspension Code A and B	
R	09-12	LINCOLN MKS All	
70098	B		
R	11-16	HYUNDAI ELANTRA All	
70102	W		
R	11-13	KIA FORTE Sedan	
70203	D		
R	11-13	KIA SORENTO All	
70204	D		
R	14-20	CHEVROLET IMPALA All	

Ultra Shock

Shock	POP	Alternative No.	MTG Acc. Supplied
Pos.	Year	Application	
70207	N		
R	14-17	MAZDA 3 All	
70208	W		
R	14-18	KIA FORTE5 All	
R	17-18	FORTE Hatchback	
R	14-16	FORTE All Hatchback	
R	14-17	FORTE KOUP All	
70209	W		
R	13-16	KIA OPTIMA Hybrid EX	
R	13-16	OPTIMA Hybrid LX	
R	16	OPTIMA Hybrid	
R	16	OPTIMA Hybrid EX Premium	
R	14	OPTIMA Hybrid EX Premium	
R	11-13	OPTIMA Hybrid	
R	13	OPTIMA Hybrid Premium	
70210	W		
R	14-15	KIA SORENTO FWD	
70213	W		
R	14-15	KIA SORENTO AWD	
G51063	D		142487
R	93-95	DODGE COLT All	
R	93-96	EAGLE SUMMIT Coupe	
R	93-96	SUMMIT Sedan	
R	97-02	MITSUBISHI MIRAGE All	
R	96	MIRAGE All Mfg. to 5/96	
R	93-95	MIRAGE All	
R	93-94	PLYMOUTH COLT Sedan	
G51254	W		142874
R	01-05	CHRYSLER SEBRING ST (MfrBodyCode), Coupe	
R	95-00	SEBRING Coupe	
R	95-00	DODGE AVENGER All	
R	01-05	STRATUS ST (MfrBodyCode), Coupe	
R	95-98	EAGLE TALON FWD	
R	95-99	MITSUBISHI ECLIPSE FWD	
R	99-03	GALANT All	
G51721	D		
R	11-22	CHRYSLER 300 RWD	
R	05-10	300 RWD Exc. Nivomat Suspension	
R	11-22	DODGE CHALLENGER RWD Exc. Nivomat Suspension	
R	07-22	CHARGER RWD Exc. Nivomat Suspension	
R	06	CHARGER All Exc. Nivomat Suspension	
R	05-08	MAGNUM All Exc. Nivomat Suspension	
G51725	W		
R	02-06	NISSAN ALTIMA All	
G51783	C		
R	07-11	TOYOTA YARIS All Exc. Dust Boot	
G51798	D		
R	03-07	NISSAN MURANO All	
G51799	B		
R	06-13	AUDI A3 All Exc. Electronic Suspension	
R	06-13	A3 QUATTRO All Exc. Electronic Suspension	
R	06-09	VOLKSWAGEN BORA All	
R	09-17	CC All	
R	12-14	GOLF Comfortline TDI	
R	12-14	GOLF Highline TDI	
R	11-14	GOLF Base	
R	11-14	GOLF Comfortline	
R	11-14	GOLF TDI	
R	11-14	GOLF Trendline	
R	14	GOLF Trendline TDI	
R	11-13	GOLF Sportline	
R	13	GOLF GTI	
R	11-12	GOLF Highline	
R	11	GOLF TDI Comfortline	
R	11	GOLF TDI Highline	
R	06-14	GTI All	
R	06-09	JETTA All	
R	06-10	PASSAT All	
R	06-09	RABBIT All	
G51802	W		
R	04-08	NISSAN MAXIMA All	
G51803	W		
R	04-09	NISSAN QUEST All	
G51804	C		
R	15-18	TOYOTA SIENNA FWD	

Numerical listing

Shock	POP	Alternative No.	MTG Acc. Supplied
Pos.	Year	Application	
G51804	C (cont)		
R	04-10	SIENNA FWD 7 Passenger	
G51805	C		
R	14-18	TOYOTA SIENNA AWD	
R	11-13	SIENNA AWD, 3.5L 6Cyl V (3456)	
R	04-10	SIENNA AWD	
R	04-10	SIENNA FWD 8 Passenger	
G51807	C		
R	06-11	ACURA CSX All	
R	06-11	HONDA CIVIC All	
G51812	W		
R	03-06	INFINITI G35 Coupe Sport Suspension	
R	03-05	NISSAN 350Z All Sport Suspension	
G51841	W		
R	01-04	VOLVO S40 All	
R	00	S40 All Mfg. from 4/00	
R	01-04	V40 All	
R	00	V40 All Mfg. from 4/00	
G51871	C		
R	97-13	CHEVROLET CORVETTE All Exc. Electronic Adjustable Suspension	
G51874	A		
R	19-20	NISSAN ALTIMA All w/Rebound Spring	
R	07-18	ALTIMA All	
G51884	B		
R	17-19	NISSAN MURANO All	
R	15-16	MURANO Platinum	
R	14-16	MURANO S	
R	14-16	MURANO SL	
R	14-16	MURANO SV	
R	14	MURANO Exclusive	
R	14	MURANO LE	
R	08-13	MURANO All	
G51904	C		
F	97-13	CHEVROLET CORVETTE All Exc. Electronic Adjustable Suspension	
G51905	W		
R	10-12	HONDA CITY All	
R	13-14	FIT DX	
R	13-14	FIT EX	
R	13-14	FIT LX	
R	13-14	FIT Sport	
R	13	FIT Base	
R	09-12	FIT All	
G51930	C		
R	97-01	INFINITI Q45 All	
G51955	W		
R	07-09	NISSAN 350Z All	
G51965	D		
R	13-20	FORD FUSION All	
G51966	D		
R	07-12	ACURA RDX All	
G51971	C		
R	11-15	CHEVROLET CRUZE All	
R	16	CRUZE LIMITED All	
G51972	W		
R	12-16	HONDA CR-V All	
G51975	W		
R	10-12	CHEVROLET CAMARO SS	
G51980	C		
R	11-19	FORD EXPLORER All	
R	13-19	POLICE INTERCEPTOR UTILITY All	
G51982	D		
R	11-17	BUICK REGAL All Exc. Active Suspension	
G51983	B		
R	10-13	MAZDA 3 All	
G51990	D		
R	14-16	NISSAN NOTE All	
R	13-20	VERSA All	
R	17-19	VERSA NOTE All	
G51992	N		
R	11-14	TOYOTA SIENNA FWD, 3.5L 6Cyl V (3456)	

Numerical listing

Shock	POP	Alternative No.	MTG Acc. Supplied
Pos.	Year	Application	
G51993 D			
R	09-17	VOLKSWAGEN TIGUAN All	
R	18	TIGUAN LIMITED All	
G51994 W			
R	07-09	KIA AMANTI All	
G51996 C			
R	09-19	FORD FLEX All	
R	10-17	LINCOLN MKT All	
G511000 D			
R	11-21	DODGE DURANGO All	
R	11-15	JEEP GRAND CHEROKEE All Exc. Load Leveling Suspensions	
G511001 N			
R	12-19	FORD ESCAPE All	
G511002 N			
R	12-14	FORD FOCUS All Exc. Heavy Duty Suspension	
G511004 D			
R	12-13	MINI COOPER S All	
R	12-13	MINI COOPER SE All	
R	12-13	MINI COOPER S All	
R	10-11	MINI COOPER S All	
R	09-11	MINI COOPER S All	
R	09-11	MINI COOPER S All	
R	08	MINI COOPER S All	
R	07	MINI COOPER S All	
G511007 W			
R	14	TOYOTA SIENNA AWD 2.7L	
R	11-13	SIENNA AWD, 2.7L 4Cyl L (163)	
G511030 W			
R	13-22	BUICK ENCORE All	
R	13-22	CHEVROLET TRAX All	
G511037 W			
R	11-16	HONDA CR-Z All	
G511038 N			
R	14-17	JEEP CHEROKEE FWD	
G511043 W			
R	16-20	INFINITI QX60 All	
R	13-20	NISSAN PATHFINDER All	
G511044 D			
R	13-15	NISSAN SENTRA All	
G511078 W			
R	13-18	MAZDA CX-5 All	
G511092 N			
R	12-15	HONDA CIVIC All	
G511122 W 143429			
R	14-16	NISSAN JUKE Automatic CVT	
G511123 W			
R	14-16	NISSAN JUKE Manual	
G511134 W			
R	12-18	FORD FOCUS All Exc. Sport Suspension	
G511135 D			
R	12-18	FORD FOCUS All w/ Sport Suspension	
G511142 D			
R	13-16	DODGE DART All Sport Suspension	

Max Control

75676 C 142261			
R	82-02	CHEVROLET CAMARO All	
R	82-02	PONTIAC FIREBIRD All	
77375 C 140780			
F	85-05	CHEVROLET ASTRO RWD	
F	81	BEL AIR All	
F	71-75	BEL AIR All	
F	71-72	BISCAYNE All	
F	73-96	CAPRICE Sedan Police and Taxi Models	
F	71-72	CAPRICE All Sedan; Police and Taxi Models	
F	83-85	IMPALA All Police and Taxi Models	

Ultra Shock, Max Control

Shock	POP	Alternative No.	MTG Acc. Supplied
Pos.	Year	Application	
77375 C (cont) 140780			
F	71-82	IMPALA Sedan Police and Taxi Models	
F	96-02	VAN 1/2 TON, G / EXPRESS All	
F	96-02	VAN 1 TON, G / EXPRESS All	
F	96-02	VAN 3/4 TON, G / EXPRESS All Exc. 8600# GVW	
F	93-02	FORD CROWN VICTORIA Police Interceptor	
F	85-05	GMC SAFARI RWD	
F	96-02	VAN 1/2 TON, G / SAVANA RWD	
F	96-02	VAN 1 TON, G / SAVANA All	
F	96-02	VAN 3/4 TON, G / SAVANA All Exc. 8600# GVW	
77403 D			
R	79-95	CHEVROLET VAN 1 TON, G / EXPRESS All 9200# GVW	
F	85	VAN 1 TON, P SERIES All Motorhome Chassis w/ I-Beam Front Suspension	
R	97-04	DODGE DAKOTA All	
R	98-03	DURANGO All	
R	79-95	GMC VAN 1 TON, G / SAVANA Cutaway Van 9200# GVW	
F	85	VAN 1 TON, P SERIES All Motorhome Chassis w/ I-Beam Front Suspension	
77412 A			
R	07-21	CHEVROLET PICKUP 1/2 TON, SILVERADO 1500 All Exc. Electronic Adjustable Suspension	
R	07	PICKUP 1/2 TON, SILVERADO 1500 4WD Old Body Style; Exc. Electronic Adjustable Suspension	
R	99-06	PICKUP 1/2 TON, SILVERADO 1500 4WD Exc. Electronic Adjustable Suspension	
R	05-06	PICKUP 1/2 TON, SILVERADO 1500 HD All	
R	01-03	PICKUP 1/2 TON, SILVERADO 1500 HD All	
R	77-86	PICKUP 1 TON, K30 All	
R	90-91	PICKUP 1 TON, R3500 All	
R	89	PICKUP 1 TON, R3500 Cab & Chassis, RWD	
R	89	PICKUP 1 TON, R3500 Crew Cab Pickup, RWD	
R	01-09	PICKUP 1 TON, SILVERADO 3500 All	
R	08-10	PICKUP 1 TON, SILVERADO 3500 HD All	
R	07	PICKUP 1 TON, SILVERADO 3500 HD All Classic	
R	87-88	PICKUP 1 TON, V30 All	
R	89-91	PICKUP 1 TON, V3000 / V3500 All	
R	99-08	PICKUP 3/4 TON, SILVERADO 2500 All	
R	01-10	PICKUP 3/4 TON, SILVERADO 2500 HD All	
R	07	SILVERADO 1500 HD CLASSIC 4WD	
R	19	SILVERADO 1500 LD All	
R	07	SILVERADO 2500 HD CLASSIC All	
R	08-10	DODGE PICKUP 1/2 TON, RAM 1500 (SEE RAM 1500) All	
R	06-07	PICKUP 1/2 TON, RAM 1500 (SEE RAM 1500) All Exc. Mega Cab	
R	02-05	PICKUP 1/2 TON, RAM 1500 (SEE RAM 1500) All	
R	77-86	GMC PICKUP 1 TON, K35 / K3500 All	
R	87-91	PICKUP 1 TON, V3000 / V3500 All	
R	19-21	SIERRA 1500 All	
R	07-18	SIERRA 1500 All Exc. Electronic Adjustable Suspension	
R	07	SIERRA 1500 4WD Old Body Style; Exc. Electronic Adjustable Suspension	
R	99-06	SIERRA 1500 4WD Exc. Electronic Adjustable Suspension	
R	05-06	SIERRA 1500 HD All	
R	01-03	SIERRA 1500 HD All	
R	07	SIERRA 1500 HD CLASSIC All	
R	19	SIERRA 1500 LIMITED All	
R	99-04	SIERRA 2500 All	
R	01-10	SIERRA 2500 HD All	
R	07	SIERRA 2500 HD CLASSIC 4WD	
R	01-06	SIERRA 3500 All	
R	07	SIERRA 3500 CLASSIC All	
R	07-10	SIERRA 3500 HD All	
R	11-18	RAM 1500 (SEE DODGE RAM 1500) All	
R	19-20	1500 CLASSIC All	

Numerical listing

Shock	POP	Alternative No.	MTG Acc. Supplied
Pos.	Year	Application	
77414 C 140780			
F	80-96	FORD BRONCO All Rearward of Front Axle; Exc. Lift Kit	
F	89	BRONCO II All Mfg. from 2/89; Vehicles w/ 12mm bolt in rear lower mount	
F	84-88	BRONCO II All w/ 10mm Bolt In Rear Lower Mount	
F	97	F-250 HD 4WD	
F	80-83	PICKUP 1/2 TON, F-100 RWD	
F	80-96	PICKUP 1/2 TON, F-150 4WD Rearward of Front Axle; Exc. Lift Kit	
F	80-96	PICKUP 1/2 TON, F-150 RWD	
F	80-97	PICKUP 1 TON, F-350 / SUPERDUTY RWD	
F	97	PICKUP 3/4 TON, F-250 / SUPERDUTY RWD Over 8500# GVW	
F	80-96	PICKUP 3/4 TON, F-250 / SUPERDUTY RWD	
F	87-89	RANGER All Exc. High Ryder Option	
F	83-86	RANGER All	
77422 C			
R	05	CHEVROLET BLAZER Base, 4WD	
R	05	BLAZER Base, RWD	
R	96-04	BLAZER LS, 4WD	
R	96-04	BLAZER LS, RWD	
R	95-02	BLAZER LT, RWD	
R	95-01	BLAZER LT, 4WD	
R	95-99	BLAZER Base, 4WD	
R	95-99	BLAZER Base, RWD	
R	95-97	BLAZER Deluxe, RWD	
R	83-94	BLAZER, S MODELS All	
R	04-12	COLORADO Torsion Bar (FrontSpringType)	
R	94-04	S10 LS, 4WD	
R	02-03	S10 Base, RWD	
R	02-03	S10 LS, RWD	
R	83-03	S10 Base, 4WD	
R	99-00	S10 Base, RWD	
R	99-00	S10 LS, RWD	
R	92-93	S10 EL, 4WD	
R	83-92	S10 Tahoe, 4WD	
R	88-90	S10 Durango, 4WD	
R	83-86	S10 Durango, 4WD	
R	04-12	GMC CANYON RWD	
R	05	JIMMY 4WD	
R	92-04	JIMMY All	
R	83-91	S15 JIMMY All	
R	82-04	SONOMA / S15 All	
R	91	SYCLONE All	
R	92-93	TYPHOON All	
R	96-00	ISUZU HOMBRE All	
R	06	I-280 Coil (FrontSpringType)	
R	06	I-280 RWD, Coil (FrontSpringType)	
R	96-01	OLDSMOBILE BRAVADA All	
R	91-94	BRAVADA All	
77423 D			
F	05	CHEVROLET BLAZER Base, 4WD Exc. ZR2	
F	03-04	BLAZER LS, 4WD Exc. ZR2	
F	02	BLAZER LS, 4WD	
F	96-01	BLAZER LS, 4WD Exc. ZR2	
F	01	BLAZER LT, 4WD	
F	95-00	BLAZER LT, 4WD Exc. ZR2	
F	98-99	BLAZER Base, 4WD Exc. ZR2	
F	97	BLAZER Base, 4WD	
F	95-96	BLAZER Base, 4WD Exc. ZR2	
F	83-94	BLAZER, S MODELS 4WD	
F	02-04	S10 LS, 4WD Exc. ZR2, ZR5 or Sport Chassis	
F	02-03	S10 Base, 4WD Exc. ZR2, ZR5 or Sport Chassis	
F	01	S10 4WD Exc. ZR2, ZR5 or Sport Chassis	
F	94-00	S10 LS, 4WD Exc. ZR2, ZR5 or Sport Chassis	
F	83-00	S10 Base, 4WD Exc. ZR2, ZR5 or Sport Chassis	
F	92-93	S10 EL, 4WD Exc. ZR2, ZR5 or Sport Chassis	
F	83-92	S10 Tahoe, 4WD Exc. ZR2, ZR5 or Sport Chassis	
F	88-90	S10 Durango, 4WD Exc. ZR2, ZR5 or Sport Chassis	
F	83-86	S10 Durango, 4WD Exc. ZR2, ZR5 or Sport Chassis	
F	92-05	GMC JIMMY 4WD	
F	83-91	S15 JIMMY 4WD	
F	83-04	SONOMA / S15 4WD	
F	91	SYCLONE All	
F	92-93	TYPHOON All	

Numerical listing

Shock	POP	Alternative No.	MTG Acc. Supplied
Pos.	Year	Application	
77423 D (cont)			
F	99-00	ISUZU HOMBRE 4WD	
F	96-98	HOMBRE All Sport Chassis	
F	96-01	OLDSMOBILE BRAVADA All	
F	91-94	BRAVADA All	
77424 W 141353			
F	84-01	JEEP CHEROKEE All	
F	86-92	COMANCHE All	
F	93-98	GRAND CHEROKEE All	
F	84-90	WAGONEER All	
77425 D			
R	84-01	JEEP CHEROKEE All	
R	84-90	WAGONEER All	
77454 W			
R	90-05	CHEVROLET ASTRO All	
R	85-89	ASTRO RWD	
R	90-05	GMC SAFARI All	
R	85-89	SAFARI RWD	
77455 C			
F	86-97	FORD PICKUP 1 TON, F-350 / SUPERDUTY 4WD	
F	97-98	PICKUP 3/4 TON, F-250 / SUPERDUTY 4WD Over 8500# GVV	
F	87-96	PICKUP 3/4 TON, F-250 / SUPERDUTY 4WD	
77461 B			
R	97	FORD F-250 HD 4WD	
R	80-96	PICKUP 1/2 TON, F-150 4WD Exc. Lift Kit	
R	86-97	PICKUP 1 TON, F-350 / SUPERDUTY 4WD Dual Rear Wheels	
R	82-85	PICKUP 1 TON, F-350 / SUPERDUTY 4WD Clevis Type Lower Front Mount; Exc. Dual Rear Wheels or Lift Kit	
R	80-81	PICKUP 1 TON, F-350 / SUPERDUTY 4WD	
R	97	PICKUP 3/4 TON, F-250 / SUPERDUTY 4WD Over 8500# GVV	
R	87-96	PICKUP 3/4 TON, F-250 / SUPERDUTY 4WD	
R	82-86	PICKUP 3/4 TON, F-250 / SUPERDUTY 4WD Clevis Type Lower Front Mount; Exc. Dual Rear Wheels or Lift Kit	
R	80-81	PICKUP 3/4 TON, F-250 / SUPERDUTY 4WD	
R	99-04	PICKUP, F-450 SUPERDUTY All	
R	99-04	PICKUP, F-550 SUPERDUTY All	
77479 D 140524			
F	86-95	TOYOTA 4RUNNER All	
F	86-95	PICKUP 4WD Exc. Lift Kit	
F	93-98	T100 4WD	
77488 B			
R	88-99	CHEVROLET PICKUP 1/2 TON, C15 / C1500 All	
R	88-99	PICKUP 1/2 TON, K15 / K1500 All	
R	91-00	PICKUP 1 TON, C35/3500 All	
R	89-90	PICKUP 1 TON, C35/3500 Extended Cab Pickup	
R	89-90	PICKUP 1 TON, C35/3500 Standard Cab Pickup	
R	88	PICKUP 1 TON, C35/3500 Extended Cab Pickup Exc. HD Straight Front Axle	
R	88	PICKUP 1 TON, C35/3500 Standard Cab Pickup Exc. HD Straight Front Axle	
R	88-00	PICKUP 1 TON, K35 / K3500 All	
R	88-00	PICKUP 3/4 TON, C25 / C2500 All	
R	88-00	PICKUP 3/4 TON, K25 / K2500 All	
R	88-99	GMC PICKUP 1/2 TON, C15 / C1500 All	
R	88-99	PICKUP 1/2 TON, K15 / K1500 All	
R	91-00	PICKUP 1 TON, C35/3500 All	
R	88-90	PICKUP 1 TON, C35/3500 Extended Cab Pickup Exc. HD Straight Front Axle	
R	88-90	PICKUP 1 TON, C35/3500 Standard Cab Pickup Exc. HD Straight Front Axle	
R	88-00	PICKUP 1 TON, K35 / K3500 All	
R	88-00	PICKUP 3/4 TON, C25 / C2500 All	
R	88-00	PICKUP 3/4 TON, K25 / K2500 All	

Max Control

Shock	POP	Alternative No.	MTG Acc. Supplied
Pos.	Year	Application	
77489 C			
F	88-99	CHEVROLET PICKUP 1/2 TON, C15 / C1500 All	
F	98-00	PICKUP 1 TON, C35/3500 All Exc. HD Straight Front Axle	
F	92-97	PICKUP 1 TON, C35/3500 Crew Cab Pickup Exc. HD Straight Front Axle	
F	88-97	PICKUP 1 TON, C35/3500 Extended Cab Pickup Exc. HD Straight Front Axle	
F	88-97	PICKUP 1 TON, C35/3500 Standard Cab Pickup Exc. HD Straight Front Axle	
F	88-00	PICKUP 3/4 TON, C25 / C2500 All	
F	92-99	SUBURBAN 1/2 TON, C15 / C1500 All	
F	92-99	SUBURBAN 3/4 TON, C25 / C2500 All	
F	95-00	TAHOE RWD Old Body Style	
F	88-99	GMC PICKUP 1/2 TON, C15 / C1500 All	
F	92-00	PICKUP 1 TON, C35/3500 Crew Cab Pickup Exc. HD Straight Front Axle	
F	88-00	PICKUP 1 TON, C35/3500 Extended Cab Pickup Exc. HD Straight Front Axle	
F	88-00	PICKUP 1 TON, C35/3500 Standard Cab Pickup Exc. HD Straight Front Axle	
F	88-00	PICKUP 3/4 TON, C25 / C2500 All	
F	92-99	SUBURBAN 1/2 TON, C15 / C1500 All	
F	92-99	SUBURBAN 3/4 TON, C25 / C2500 All	
F	92-99	YUKON RWD	
77494 W 140149			
R	84-89	TOYOTA 4RUNNER All	
R	84-95	PICKUP 4WD Exc. Lift Kit	
R	98-04	TACOMA Pre Runner, RWD	
R	04	TACOMA Base, 4WD	
R	95-03	TACOMA 4WD	
77524 C			
R	06-11	FORD RANGER RWD, Torsion Bar (FrontSpringType)	
R	90-11	RANGER 4WD	
R	89	RANGER 4WD Mfg. from 2/89; Vehicles w/ 12mm bolt in rear lower mount	
R	95-96	MAZDA B2300 4WD	
R	03-07	B3000 All 4WD	
R	98-02	B3000 4WD	
R	98-09	B4000 4WD	
77525 C			
R	90	FORD BRONCO II All	
R	89	BRONCO II All Mfg. from 2/89; Vehicles w/ 12mm bolt in rear lower mount	
R	06-11	RANGER RWD, Coil (FrontSpringType)	
R	98-05	RANGER XL, RWD	
R	98-05	RANGER XLT, RWD	
R	05	RANGER STX, RWD	
R	04	RANGER Tremor, RWD	
R	02	RANGER Postal, RWD	
R	90-97	RANGER RWD	
R	89	RANGER RWD Mfg. from 2/89; Vehicles w/ 12mm bolt in rear lower mount	
R	01-09	MAZDA B2300 RWD	
R	94-97	B2300 RWD	
R	98-01	B2500 RWD	
R	94-07	B3000 RWD	
R	94-09	B4000 RWD	
77607 W 140719			
R	00-05	FORD EXCURSION RWD	
R	91-94	EXPLORER All	
R	91-94	MAZDA NAVAJO All	
77608 W 140780			
F	91-94	FORD EXPLORER All	
F	92-11	VAN 1/2 TON, ECONOLINE / CLUB WAGON All	
F	91-94	MAZDA NAVAJO All	
77609 A			
F	99-00	CADILLAC ESCALADE All	
F	90-05	CHEVROLET ASTRO AWD	
F	92-94	BLAZER 4WD Full Size	
F	88-99	PICKUP 1/2 TON, K15 / K1500 All	
F	88-00	PICKUP 1 TON, K35 / K3500 All	

Numerical listing

Shock	POP	Alternative No.	MTG Acc. Supplied
Pos.	Year	Application	
77609 A (cont)			
F	88-00	PICKUP 3/4 TON, K25 / K2500 All	
F	92-99	SUBURBAN 1/2 TON, K15 / K1500 All	
F	92-99	SUBURBAN 3/4 TON, K25 / K2500 All	
F	95-00	TAHOE 4WD Old Body Style	
F	88-99	GMC PICKUP 1/2 TON, K15 / K1500 All	
F	88-00	PICKUP 1 TON, K35 / K3500 All	
F	88-00	PICKUP 3/4 TON, K25 / K2500 All	
F	90-05	SAFARI AWD	
F	92-99	SUBURBAN 1/2 TON, K15 / K1500 All	
F	92-99	SUBURBAN 3/4 TON, K25 / K2500 All	
F	92-99	YUKON 4WD	
77614 A 140780			
F	90	FORD BRONCO II All	
F	00-02	E-450 ECONOLINE SUPER DUTY All	
F	96-99	ECONOLINE SUPER DUTY All	
F	00-05	EXCURSION RWD	
F	90-97	RANGER All	
F	21-22	VAN 1 TON, ECONOLINE / CLUB WAGON / SUPERDUTY All	
F	07-19	VAN 1 TON, ECONOLINE / CLUB WAGON / SUPERDUTY All Exc. Cutaway Chassis	
F	99-19	VAN 1 TON, ECONOLINE / CLUB WAGON / SUPERDUTY All	
F	92-05	VAN 1 TON, ECONOLINE / CLUB WAGON / SUPERDUTY All Cutaway Chassis	
F	92-14	VAN 3/4 TON, ECONOLINE / CLUB WAGON / SUPERDUTY All	
F	94-97	MAZDA B2300 All	
F	94-97	B3000 RWD	
F	94-97	B4000 RWD	
77623 C 142731			
R	00-02	FORD E-450 ECONOLINE SUPER DUTY All	
R	00-02	E-450 ECONOLINE SUPER DUTY All Exc. Cutaway Chassis	
R	96-99	ECONOLINE SUPER DUTY All	
R	10-14	VAN 1/2 TON, ECONOLINE / CLUB WAGON All	
R	21-22	VAN 1 TON, ECONOLINE / CLUB WAGON / SUPERDUTY All	
R	03-19	VAN 1 TON, ECONOLINE / CLUB WAGON / SUPERDUTY All Exc. Cutaway Chassis	
R	07-08	VAN 1 TON, ECONOLINE / CLUB WAGON / SUPERDUTY All	
R	92-05	VAN 1 TON, ECONOLINE / CLUB WAGON / SUPERDUTY All Cutaway Chassis	
R	99-03	VAN 1 TON, ECONOLINE / CLUB WAGON / SUPERDUTY All	
R	92-14	VAN 3/4 TON, ECONOLINE / CLUB WAGON / SUPERDUTY All	
77638 A			
R	99-00	CADILLAC ESCALADE All	
R	92-94	CHEVROLET BLAZER 4WD Full Size	
R	09-22	EXPRESS 4500 All	
R	92-99	SUBURBAN 1/2 TON, C15 / C1500 All	
R	92-99	SUBURBAN 1/2 TON, K15 / K1500 All	
R	92-99	SUBURBAN 3/4 TON, C25 / C2500 All	
R	92-99	SUBURBAN 3/4 TON, K25 / K2500 All	
R	95-00	TAHOE All Old Body Style	
R	96-14	VAN 1/2 TON, G / EXPRESS All	
R	03-22	VAN 1 TON, G / EXPRESS All	
R	03-20	VAN 3/4 TON, G / EXPRESS All	
R	96-02	VAN 3/4 TON, G / EXPRESS All Exc. 8600# GVV	
R	15-20	GMC SAVANA 4500 All	
R	92-99	SUBURBAN 1/2 TON, C15 / C1500 All	
R	92-99	SUBURBAN 1/2 TON, K15 / K1500 All	
R	92-99	SUBURBAN 3/4 TON, C25 / C2500 All	
R	92-99	SUBURBAN 3/4 TON, K25 / K2500 All	
R	96-14	VAN 1/2 TON, G / SAVANA RWD	
R	04-22	VAN 1 TON, G / SAVANA All	

Numerical listing

Max Control

Numerical listing

Shock	POP	Alternative No.	MTG Acc. Supplied
Pos.	Year	Application	
77638 A (cont)			
R	96-02	VAN 1 TON, G / SAVANA All Exc. 8600# GVW	
R	96	VAN 1 TON, G / SAVANA All 7100, 7400 and 8600# GVW	
R	03-22	VAN 3/4 TON, G / SAVANA All	
R	96-02	VAN 3/4 TON, G / SAVANA All Exc. 8600# GVW	
R	92-99	YUKON All	
77661 D			
F	94-01	DODGE PICKUP 1/2 TON, RAM 1500 (SEE RAM 1500) RWD	
F	94-02	PICKUP 1 TON, RAM 3500 (SEE RAM 3500) RWD Exc. Solid Front Axle	
F	94-02	PICKUP 3/4 TON, RAM 2500 (SEE RAM 2500) RWD	
77662 B			
R	07	CHEVROLET PICKUP 1/2 TON, SILVERADO 1500 RWD Old Body Style; Exc. Electronic Adjustable Suspension	
R	99-06	PICKUP 1/2 TON, SILVERADO 1500 RWD Exc. Electronic Adjustable Suspension	
R	74-80	VAN 1/2 TON, P SERIES All	
R	79-89	VAN 3/4 TON, P SERIES All	
R	94-01	DODGE PICKUP 1/2 TON, RAM 1500 (SEE RAM 1500) All	
R	94-02	PICKUP 1 TON, RAM 3500 (SEE RAM 3500) RWD Exc. Solid Front Axle	
R	94-02	PICKUP 3/4 TON, RAM 2500 (SEE RAM 2500) All Exc. 8800# GVW	
R	99-07	GMC SIERRA 1500 RWD Exc. Electronic Adjustable Suspension	
R	74-80	VAN 1/2 TON, P SERIES All	
R	75-99	VAN 1 TON, P SERIES All	
R	73-74	VAN 1 TON, P SERIES Base Cutaway Chassis	
R	74	VAN 1 TON, P SERIES Motorhome	
77673 W 142731			
F	94-01	DODGE PICKUP 1/2 TON, RAM 1500 (SEE RAM 1500) 4WD	
F	94-02	PICKUP 3/4 TON, RAM 2500 (SEE RAM 2500) 4WD Exc. 8800# GVW	
77674 A 142731			
F	94-02	DODGE PICKUP 1 TON, RAM 3500 (SEE RAM 3500) 4WD	
F	94-02	PICKUP 1 TON, RAM 3500 (SEE RAM 3500) RWD Solid Front Axle	
F	94-02	PICKUP 3/4 TON, RAM 2500 (SEE RAM 2500) 4WD 8800# GVW	
77675 C			
R	94-02	DODGE PICKUP 1 TON, RAM 3500 (SEE RAM 3500) 4WD	
R	94-02	PICKUP 1 TON, RAM 3500 (SEE RAM 3500) RWD Solid Front Axle	
R	94-02	PICKUP 3/4 TON, RAM 2500 (SEE RAM 2500) 4WD 8800# GVW	
77678 C			
F	95-01	FORD EXPLORER All Exc. Adjustable Suspension	
F	01-05	EXPLORER SPORT TRAC All	
F	98-11	RANGER Torsion Bar (FrontSpringType)	
F	03-07	MAZDA B3000 All 4WD	
F	98-02	B3000 4WD	
F	98-09	B4000 4WD	
F	97-01	MERCURY MOUNTAINEER All Exc. Electronic Adjustable Suspension	
77679 W 140719			
R	95-01	FORD EXPLORER All Exc. Adjustable Suspension	
R	01-05	EXPLORER SPORT TRAC All	
R	97-01	MERCURY MOUNTAINEER All Exc. Electronic Adjustable Suspension	
77683 W			
R	93-98	JEEP GRAND CHEROKEE All	
77714 D 142731			
F	97-02	FORD EXPEDITION RWD Exc. Front Air- Leveling	
F	97-03	LOBO RWD	
F	97-04	PICKUP 1/2 TON, F-150 RWD	

Shock	POP	Alternative No.	MTG Acc. Supplied
Pos.	Year	Application	
77714 D (cont) 142731			
F	96-99	PICKUP 3/4 TON, F-250 / SUPERDUTY RWD Up through 8500# GVW	
F	98-02	LINCOLN NAVIGATOR RWD	
77715 C 142700			
R	98-03	FORD LOBO 4WD	
R	97-04	PICKUP 1/2 TON, F-150 4WD	
R	97-99	PICKUP 3/4 TON, F-250 / SUPERDUTY 4WD Up through 8500# GVW	
77716 B 142731			
F	97-02	FORD EXPEDITION 4WD Exc. Front Air- Leveling	
F	98-03	LOBO 4WD	
F	04	PICKUP 1/2 TON, F-150 4WD Exc. 7000# GVW	
F	97-03	PICKUP 1/2 TON, F-150 4WD	
F	97-99	PICKUP 3/4 TON, F-250 / SUPERDUTY 4WD Up through 8500# GVW	
77717 W			
R	97-02	FORD EXPEDITION All	
R	98-02	LINCOLN NAVIGATOR RWD	
77726 C 140921			
R	90-02	TOYOTA 4RUNNER All	
77772 C 140780			
F	06-11	FORD RANGER RWD, Coil (FrontSpringType)	
F	01-05	RANGER XL, RWD, Coil (FrontSpringType)	
F	01-05	RANGER XLT, RWD, Coil (FrontSpringType)	
F	01-02	RANGER EV Coil (FrontSpringType)	
F	02	RANGER Sport, RWD, Coil (FrontSpringType)	
F	98-00	RANGER XL, RWD	
F	98-00	RANGER XLT, RWD	
F	01-09	MAZDA B2300 RWD	
F	98-01	B2500 RWD	
F	98-07	B3000 RWD	
F	98-09	B4000 RWD	
77783 C 141665			
F	99-07	CHEVROLET PICKUP 1/2 TON, SILVERADO 1500 RWD Exc. Electronic Adjustable Suspension	
F	99-04	PICKUP 3/4 TON, SILVERADO 2500 RWD Exc. Electronic Adjustable Suspension	
F	01-04	PICKUP 3/4 TON, SILVERADO 2500 HD RWD	
F	99-07	GMC SIERRA 1500 RWD Exc. Electronic Adjustable Suspension	
F	99-04	SIERRA 2500 RWD Exc. Electronic Adjustable Suspension	
F	01-04	SIERRA 2500 HD RWD	
77803 A 143276			
F	02-06	CADILLAC ESCALADE All	
F	02-04	ESCALADE EXT All	
F	02-06	CHEVROLET AVALANCHE 1500 All Exc. Electronic Ride Control	
F	07	PICKUP 1/2 TON, SILVERADO 1500 All Old Body Style; Exc. Electronic Adjustable Suspension	
F	99-06	PICKUP 1/2 TON, SILVERADO 1500 4WD Exc. Electronic Adjustable Suspension	
F	00-06	SUBURBAN 1/2 TON, 1500 All Exc. Z55 Auto Ride Suspension	
F	02-06	TAHOE All Exc. Z55 Auto Ride Suspension	
F	00-01	TAHOE All New Body Style; Exc. Z55 Auto Ride Suspension	
F	07	GMC SIERRA 1500 4WD Old Body Style; Exc. Electronic Adjustable Suspension	
F	99-06	SIERRA 1500 4WD Exc. Electronic Adjustable Suspension	
F	00-06	YUKON All Exc. Z55 Auto Ride Suspension	
F	00-06	YUKON XL 1/2 TON All Exc. Z55 Auto Ride Suspension	
77807 C 142617			
F	99-12	FORD PICKUP 1 TON, F-350 / SUPERDUTY RWD	
F	99-13	PICKUP 3/4 TON, F-250 / SUPERDUTY RWD	

Shock	POP	Alternative No.	MTG Acc. Supplied
Pos.	Year	Application	
77808 D			
R	99-04	FORD PICKUP 1 TON, F-350 / SUPERDUTY RWD	
R	99-04	PICKUP 3/4 TON, F-250 / SUPERDUTY RWD	
77809 A			
F	00-05	FORD EXCURSION 4WD	
R	97	F-250 HD All	
R	85-96	PICKUP 1/2 TON, F-150 RWD	
F	99-04	PICKUP 1 TON, F-350 / SUPERDUTY 4WD	
R	80-97	PICKUP 1 TON, F-350 / SUPERDUTY RWD Exc. Dual Rear Wheels	
F	99-04	PICKUP 3/4 TON, F-250 / SUPERDUTY 4WD	
R	97	PICKUP 3/4 TON, F-250 / SUPERDUTY RWD Over 8500# GVW	
R	80-96	PICKUP 3/4 TON, F-250 / SUPERDUTY RWD	
F	99-04	PICKUP, F-450 SUPERDUTY All	
F	99-04	PICKUP, F-550 SUPERDUTY All	
77810 B			
R	99-04	FORD PICKUP 1 TON, F-350 / SUPERDUTY 4WD	
R	99-04	PICKUP 3/4 TON, F-250 / SUPERDUTY 4WD	
77815 D 142389			
R	00-06	TOYOTA TUNDRA All	
77817 A 141665			
F	02-06	CHEVROLET AVALANCHE 2500 All Exc. Electronic Ride Control	
F	05-06	PICKUP 1/2 TON, SILVERADO 1500 HD All	
F	01-03	PICKUP 1/2 TON, SILVERADO 1500 HD All	
F	01-09	PICKUP 1 TON, SILVERADO 3500 All	
F	16-19	PICKUP 1 TON, SILVERADO 3500 HD All	
F	07-10	PICKUP 1 TON, SILVERADO 3500 HD All	
F	05-08	PICKUP 3/4 TON, SILVERADO 2500 All	
F	99-04	PICKUP 3/4 TON, SILVERADO 2500 4WD	
F	01-10	PICKUP 3/4 TON, SILVERADO 2500 HD All 9200# GVW	
F	07	SILVERADO 1500 HD CLASSIC All	
F	07	SILVERADO 2500 HD CLASSIC All	
F	00-11	SUBURBAN 3/4 TON, 2500 All Exc. Z55 Auto Ride Suspension and Quadrateer	
F	05-06	GMC SIERRA 1500 HD All	
F	01-03	SIERRA 1500 HD All	
F	07	SIERRA 1500 HD CLASSIC All	
F	99-04	SIERRA 2500 4WD	
F	01-10	SIERRA 2500 HD All	
F	01-06	SIERRA 3500 All	
F	07-10	SIERRA 3500 HD Torsion Bar (FrontSpringType)	
F	00-06	YUKON XL 3/4 TON All Exc. Hydraulic Self-Leveling System	
F	03-09	HUMMER H2 All	
77829 D			
R	99-04	JEEP GRAND CHEROKEE All	
77837 W			
R	00-05	FORD EXCURSION 4WD	
77847 C 142592,141353			
F	99-04	JEEP GRAND CHEROKEE All Exc. Up Country Suspension	
77905 D 140126			
F	97-04	DODGE DAKOTA 4WD	
F	98-03	DURANGO 4WD	
77907 W			
R	75-80	CHEVROLET LUV PICKUP All	
R	72-74	LUV PICKUP All	
R	79-82	DODGE D50 RWD	
R	87-93	PICKUP, RAM 50 RWD	
R	83-86	PICKUP, RAM 50 All	
R	86-87	MAZDA B2000 RWD	
R	87-93	B2200 RWD	
R	87-93	B2600 RWD	
R	95-96	MITSUBISHI MIGHTY MAX All	
R	83-94	MIGHTY MAX RWD	
R	87-90	VAN All	

Numerical listing

Table with columns: Shock, POP, Alternative No., MTG Acc. Supplied, Pos., Year, Application. Lists vehicle models and their specifications.

Max Control, Guardian Shock

Table with columns: Shock, POP, Alternative No., MTG Acc. Supplied, Pos., Year, Application. Lists vehicle models and their specifications.

Numerical listing

Table with columns: Shock, POP, Alternative No., MTG Acc. Supplied, Pos., Year, Application. Lists vehicle models and their specifications.

Numerical listing

Guardian Shock

Numerical listing

Shock	POP	Alternative No.	MTG Acc. Supplied
Pos.	Year	Application	
81039 A (cont) 140357			
F	68-90	VAN 1/2 TON, P SERIES All Cutaway Chassis	
F	68-89	VAN 3/4 TON, P SERIES All	
F	75-84	GMC JIMMY RWD	
F	70-74	JIMMY All RWD	
F	67-86	PICKUP 1/2 TON, C15 / C1500 All	
F	87	PICKUP 1/2 TON, R1500 All	
F	88-91	PICKUP 1/2 TON, C35/3500 Cab & Chassis	
F	80-86	PICKUP 1 TON, C35/3500 All	
F	67-78	PICKUP 1 TON, C35/3500 All	
F	87-91	PICKUP 1 TON, R3500 All	
F	83-86	PICKUP 3/4 TON, C25 / C2500 All	
F	75-82	PICKUP 3/4 TON, C25 / C2500 Cab & Chassis	
F	75-82	PICKUP 3/4 TON, C25 / C2500 Crew Cab Pickup	
F	75-82	PICKUP 3/4 TON, C25 / C2500 Standard Cab Pickup	
F	67-74	PICKUP 3/4 TON, C25 / C2500 All	
F	87-89	PICKUP 3/4 TON, R2500 All Exc. Crew Cab & Bonus Cab	
F	63-66	PICKUP 1000 SERIES All	
F	63-66	PICKUP 1500 SERIES All	
F	66	PICKUP 2500 SERIES All	
F	73-86	SUBURBAN 1/2 TON, C15 / C1500 All	
F	68-72	SUBURBAN 1/2 TON, C15 / C1500 All Coil (FrontSpringType)	
F	87-91	SUBURBAN 1/2 TON, R1500 All	
F	68-86	SUBURBAN 3/4 TON, C25 / C2500 All	
F	87-91	SUBURBAN 3/4 TON, R2500 All	
F	67-80	VAN 1/2 TON, P SERIES All	
F	75-90	VAN 1 TON, P SERIES All Cutaway Chassis	
F	73-74	VAN 1 TON, P SERIES Base Cutaway Chassis	
F	68-72	VAN 1 TON, P SERIES All	
F	68-89	VAN 3/4 TON, P SERIES All	
F	63-65	VAN, PB 1000 SERIES All	
81076 B 140496			
F	70-77	FORD MAVERICK All	
F	67-70	MUSTANG / MUSTANG II All	
F	71-77	MERCURY COMET All	
F	67-70	COUGAR All	
81082 D			
R	97	FORD F-250 HD RWD	
R	85-96	PICKUP 1/2 TON, F-150 RWD	
R	80-97	PICKUP 1 TON, F-350 / SUPERDUTY RWD Exc. Dual Rear Wheels	
R	97	PICKUP 3/4 TON, F-250 / SUPERDUTY RWD Over 8500# GVW	
R	80-96	PICKUP 3/4 TON, F-250 / SUPERDUTY RWD	
81091 C			
R	67-73	CHRYSLER IMPERIAL All	
R	70-73	NEWPORT All	
R	70-73	NEW YORKER All	
R	71-73	TOWN & COUNTRY All	
R	73	DODGE MONACO All	
R	71	MONACO All	
R	72-93	PICKUP 1/2 TON, D100 SERIES All	
R	72-93	PICKUP 1 TON, D300 SERIES All	
R	72-93	PICKUP 3/4 TON, D200 SERIES All	
R	73	POLARA All	
R	71	POLARA All	
R	75-93	RAMCHARGER RWD	
R	74	RAMCHARGER All RWD	
R	70-73	PLYMOUTH FURY All	
R	73	FURY All Exc. Wagon	
R	73	GRAN FURY Hardtop	
R	72	GRAN FURY All	
R	75-81	TRAILDUSTER RWD	
R	74	TRAILDUSTER All	
81095 C 140524			
R	70-81	CHEVROLET CAMARO All	
R	70-81	PONTIAC FIREBIRD All	
81096 C 140126			
F	84-86	DODGE MINI RAM All	
F	72-93	PICKUP 1/2 TON, D100 SERIES All	
F	72-93	PICKUP 3/4 TON, D200 SERIES All Exc. Heavy Duty Package	
F	75-93	RAMCHARGER RWD	
F	99-03	VAN 1/2 TON, A / B SERIES / RAM 109.3 / 277.6 (WheelBase) Exc. 7000# GVW	

Shock	POP	Alternative No.	MTG Acc. Supplied
Pos.	Year	Application	
81096 C (cont) 140126			
F	81-98	VAN 1/2 TON, A / B SERIES / RAM 109.6 / 278.4 (WheelBase) Exc. 7000# GVW	
F	71-80	VAN 1/2 TON, A / B SERIES / RAM All	
F	99-03	VAN 1 TON, A / B SERIES / RAM All	
F	71-98	VAN 1 TON, A / B SERIES / RAM All Exc. 4000# Front Axle	
F	71-03	VAN 3/4 TON, A / B SERIES / RAM All	
F	74-80	VAN, CB300 All Exc. 4000# Front Axle	
F	75-81	PLYMOUTH TRAILDUSTER RWD	
F	74-83	VAN 1/2 TON, PB SERIES All	
F	74-83	VAN 1 TON, PB SERIES All Exc. 4000# Front Axle	
F	74-83	VAN 3/4 TON, PB SERIES All	
81113 D			
F	87-91	CHEVROLET BLAZER 4WD Exc. Quad Suspension and Lift Kit	
F	81-86	BLAZER 4WD Quad Suspension Short Shock; Exc. Lift Kit	
F	69-80	BLAZER 4WD Exc. Quad Suspension and Lift Kit	
F	81-86	PICKUP 1/2 TON, K10 All Standard Suspension; Exc. Lift Kit	
F	69-80	PICKUP 1/2 TON, K10 All Exc. Lift Kit	
F	87	PICKUP 1/2 TON, V10 All Quad Suspension Short Shock; Exc. Lift Kit	
F	81-86	PICKUP 3/4 TON, K20 All Standard Suspension; Exc. Lift Kit	
F	69-80	PICKUP 3/4 TON, K20 All Exc. Lift Kit	
F	81-86	SUBURBAN 1/2 TON, K10 All Standard Suspension; Exc. Lift Kit	
F	69-80	SUBURBAN 1/2 TON, K10 All Exc. Lift Kit	
F	87-88	SUBURBAN 1/2 TON, V10 All Quad Suspension Short Shock; Exc. Lift Kit	
F	81-86	SUBURBAN 3/4 TON, K20 All Standard Suspension; Exc. Lift Kit	
F	69-80	SUBURBAN 3/4 TON, K20 All Exc. Lift Kit	
F	87-88	SUBURBAN 3/4 TON, V20 All Quad Suspension Short Shock; Exc. Lift Kit	
F	89-91	SUBURBAN 3/4 TON, V2500 All Quad Suspension Short Shock; Exc. Lift Kit	
F	75-91	GMC JIMMY 4WD Exc. Quad Suspension and Lift Kit	
F	70-74	JIMMY All 4WD; Exc. Quad Suspension and Lift Kit	
F	69-86	PICKUP 1/2 TON, K15 / K1500 All Exc. Quad Suspension and Lift Kit	
F	87	PICKUP 1/2 TON, V1500 All Quad Suspension Short Shock; Exc. Lift Kit	
F	69-86	PICKUP 3/4 TON, K25 / K2500 All Exc. Quad Suspension and Lift Kit	
F	87	PICKUP 3/4 TON, V2500 All Quad Suspension Short Shock; Exc. Lift Kit	
F	69-86	SUBURBAN 1/2 TON, K15 / K1500 All Exc. Quad Suspension and Lift Kit	
F	87-91	SUBURBAN 1/2 TON, V1500 All Quad Suspension Short Shock; Exc. Lift Kit	
F	69-86	SUBURBAN 3/4 TON, K25 / K2500 All Exc. Quad Suspension and Lift Kit	
F	87-91	SUBURBAN 3/4 TON, V2500 All Quad Suspension Short Shock; Exc. Lift Kit	
81147 B			
R	56	BUICK ROADMASTER All Exc. Air Suspension	
R	56	SPECIAL All	
R	56	SUPER All	
R	75-80	CHEVROLET LUV PICKUP All	
R	72-74	LUV PICKUP All	
F	55-56	PICKUP 3200	
F	55-56	PICKUP 3600	
F	55-56	PICKUP 3800	
F	55	PICKUP 3100	
R	79-82	DODGE D50 RWD	
R	83-93	PICKUP, RAM 50 RWD	
F	61-65	FORD PICKUP 1/2 TON, F-100 All	

Shock	POP	Alternative No.	MTG Acc. Supplied
Pos.	Year	Application	
81147 B (cont)			
F	61-66	PICKUP 1 TON, F-350 / SUPERDUTY All	
F	61-64	PICKUP 3/4 TON, F-250 / SUPERDUTY All	
F	68-75	PICKUP P350 All Up through 8000# GVW	
F	75-76	PICKUP P400 All Up through 8000# GVW	
R	68	INTERNATIONAL 908C All	
R	68	1000C All	
F	68	1100C All Exc. 166" Wheelbase	
R	68	1100C All Exc. 166" Wheelbase	
F	68	1200C All Exc. 166" Wheelbase	
R	68	1200C All Exc. 166" Wheelbase	
F	68	1300C All Exc. 166" Wheelbase	
R	68	1300C All Exc. 166" Wheelbase	
R	68-72	M1100 / M1200 All	
R	69	M1400 All	
R	72-83	JEEP CJ5 All Exc. Lift Kit	
R	66-71	CJ5 All Exc. 5 Leaf Front Springs & Lift Kit	
R	66-75	CJ6 All Exc. Lift Kit	
R	76-86	CJ7 All Exc. Lift Kit	
R	66-74	DJ5 All Exc. Lift Kit	
R	66-68	DJ6 All	
R	57-60	FC150 All	
F	63-65	FC170 All	
R	63-65	FC170 All	
R	64-66	GLADIATOR All	
R	63	GLADIATOR All Independent Front Suspension	
R	70-71	JEEPSTER All	
R	81-85	SCRAMBLER / CJ8 All	
R	61-67	UNIVERSAL All	
R	86-87	MAZDA B2000 RWD	
R	87-93	B2200 RWD	
R	87-93	B2600 RWD	
R	95-96	MITSUBISHI MIGHTY MAX All	
R	83-94	MIGHTY MAX RWD	
R	87-90	VAN All	
R	98-04	NISSAN FRONTIER RWD Exc. Desert Runner	
R	87-97	PICKUP RWD	
R	86	PICKUP RWD Mfg. from 8/86	
R	79-82	PLYMOUTH PICKUP All	
R	67-68	TOYOTA LAND CRUISER All	
R	84-95	PICKUP RWD Exc. 1 Ton	
R	77-83	PICKUP RWD Mojave	
R	75-76	PICKUP RWD	
R	70-74	PICKUP All RWD	
R	84-88	VAN Leaf (RearSpringType)	
R	88	VAN WAGON All Leaf(RearSpringType)	
81153 W 140126			
F	75-79	CHRYSLER CORDOBA All	
F	79-81	NEWPORT All	
F	79-81	TOWN & COUNTRY All	
F	73-78	DODGE CHARGER All	
F	73-76	CORONET All	
F	78-79	MAGNUM All	
F	77-78	MONACO All	
F	79-81	ST. REGIS All	
F	75-78	PLYMOUTH FURY All	
F	80-81	GRAN FURY All	
F	73-75	ROAD RUNNER All	
F	73-74	SATELLITE All	
81164 B 140357			
R	87-91	CHEVROLET BLAZER 4WD Full Size; Exc. Quad Suspension and Lift Kit	
R	85-86	BLAZER 4WD Exc. Lift Kit	
R	73-84	BLAZER All Exc. Lift Kit	
R	73-86	PICKUP 1/2 TON, C10 All	
R	73-86	PICKUP 1/2 TON, K10 All Exc. Lift Kit	
R	87	PICKUP 1/2 TON, R10 All	
R	87	PICKUP 1/2 TON, V10 All Exc. Lift Kit	
R	75-86	PICKUP 3/4 TON, C20 Standard Cab Pickup	
R	73-74	PICKUP 3/4 TON, C20 All Standard Cab Pickup	
R	73-86	PICKUP 3/4 TON, K20 All Exc. Lift Kit	
R	87	PICKUP 3/4 TON, R20 Standard Cab Pickup	
R	87	PICKUP 3/4 TON, V20 All Exc. Quad Suspension and Lift Kit	
R	73-86	SUBURBAN 1/2 TON, C10 All	
R	73-86	SUBURBAN 1/2 TON, K10 All Exc. Lift Kit	
R	87-88	SUBURBAN 1/2 TON, R10 All	

Numerical listing

Shock	POP	Alternative No.	MTG Acc. Supplied
Pos.	Year	Application	
81164	B	(cont)	140357
R	89-91	SUBURBAN 1/2 TON, R1500 All	
R	89-91	SUBURBAN 1/2 TON, V1500 All Exc. Lift Kit	
R	73-86	SUBURBAN 3/4 TON, C20 All	
R	73-86	SUBURBAN 3/4 TON, K20 All Exc. Lift Kit	
R	87-88	SUBURBAN 3/4 TON, R20 All	
R	89-91	SUBURBAN 3/4 TON, R2500 All	
R	87-88	SUBURBAN 3/4 TON, V20 All Exc. Quad Suspension and Lift Kit	
R	89-91	SUBURBAN 3/4 TON, V2500 All Exc. Lift Kit	
R	73	VAN 1/2 TON, P SERIES All	
R	73-78	VAN 3/4 TON, P SERIES All	
R	73-91	GMC JIMMY All Exc. Lift Kit	
R	73-86	PICKUP 1/2 TON, C15 / C1500 All	
R	73-86	PICKUP 1/2 TON, K15 / K1500 All Exc. Lift Kit	
R	87	PICKUP 1/2 TON, R1500 All	
R	87	PICKUP 1/2 TON, V1500 All Exc. Lift Kit	
R	83-86	PICKUP 3/4 TON, C25 / C2500 All	
R	75-82	PICKUP 3/4 TON, C25 / C2500 Cab & Chassis	
R	75-82	PICKUP 3/4 TON, C25 / C2500 Standard Cab Pickup	
R	73-86	PICKUP 3/4 TON, K25 / K2500 All Exc. Lift Kit	
R	88-89	PICKUP 3/4 TON, R2500 All Exc. Crew Cab & Bonus Cab	
R	87	PICKUP 3/4 TON, R2500 Cab & Chassis Exc. Crew Cab & Bonus Cab	
R	87	PICKUP 3/4 TON, R2500 Standard Cab Pickup Exc. Crew Cab & Bonus Cab	
R	87	PICKUP 3/4 TON, V2500 All Exc. Lift Kit	
R	73-86	SUBURBAN 1/2 TON, C15 / C1500 All	
R	73-86	SUBURBAN 1/2 TON, K15 / K1500 All Exc. Lift Kit	
R	87-91	SUBURBAN 1/2 TON, R1500 All	
R	87-91	SUBURBAN 1/2 TON, V1500 All Exc. Lift Kit	
R	75-86	SUBURBAN 3/4 TON, C25 / C2500 All	
R	73-74	SUBURBAN 3/4 TON, C25 / C2500 All Exc. Crew Cab & Bonus Cab	
R	73-86	SUBURBAN 3/4 TON, K25 / K2500 All Exc. Lift Kit	
R	87-91	SUBURBAN 3/4 TON, R2500 All	
R	87-91	SUBURBAN 3/4 TON, V2500 All Exc. Lift Kit	
R	73	VAN 1/2 TON, P SERIES All	
R	73-78	VAN 3/4 TON, P SERIES All	
81242	B		140126
R	62-67	CHEVROLET CHEVY II All	
R	66	FORD BRONCO All Thru Serial #830000	
R	73-79	PICKUP 1/2 TON, F-100 RWD	
R	70-72	PICKUP 1/2 TON, F-100 All RWD	
R	75-79	PICKUP 1/2 TON, F-150 RWD	
R	75-79	PICKUP 1 TON, F-350 / SUPERDUTY Extended Cab Pickup, RWD	
R	75-79	PICKUP 3/4 TON, F-250 / SUPERDUTY Cab & Chassis, RWD	
R	75-79	PICKUP 3/4 TON, F-250 / SUPERDUTY Standard Cab Pickup, RWD	
R	73-74	PICKUP 3/4 TON, F-250 / SUPERDUTY RWD Exc. Supercab	
R	70-72	PICKUP 3/4 TON, F-250 / SUPERDUTY All RWD; Exc. Supercab	
R	75-91	VAN 1/2 TON, ECONOLINE / CLUB WAGON All	
F	71-80	INTERNATIONAL SCOUT II All	
81270	A		140523
R	75-80	AMERICAN MOTORS PACER All	
F	58	BUICK CENTURY All	
F	58	LIMITED All	
F	58	ROADMASTER All Exc. Air Suspension	
F	58	SPECIAL All Exc. Air Suspension	
F	58	SUPER All Exc. Air Suspension	
F	54-55	CHEVROLET PICKUP All	
F	50-53	PICKUP 3100	
F	50-53	PICKUP 3600	
F	50-53	PICKUP 3800	
R	90-92	DAIHATSU ROCKY All	

Guardian Shock

Shock	POP	Alternative No.	MTG Acc. Supplied
Pos.	Year	Application	
81270	A	(cont)	140523
R	62-70	FORD FAIRLANE All	
R	55-58	FAIRLANE All	
R	66-70	FALCON All Exc. Wagon	
R	60-65	FALCON All	
R	52-56	MAINLINE All	
R	65-73	MUSTANG / MUSTANG II All	
R	56	PARK LANE WAGON All	
R	60	PICKUP 1/2 TON, F-100 All	
R	60	PICKUP 1 TON, F-350 / SUPERDUTY All	
R	60	PICKUP 3/4 TON, F-250 / SUPERDUTY All	
R	60-65	RANCHERO All	
R	52-56	RANCH WAGON All	
R	54-56	SKYLINER All	
R	52-58	SUNLINER All	
R	55-57	THUNDERBIRD All	
R	68-70	TORINO All Exc. Wagon	
R	52-58	VICTORIA All	
F	53-54	GMC PICKUP All	
R	62-64	JAGUAR XKE All	
R	72-77	MAZDA 808 Wagon Exc. Models w/ Tokico OE Struts	
R	79-83	GLC Wagon	
R	78	GLC All	
R	74-76	RX3 Wagon	
R	72-73	RX3 All	
R	74-78	RX4 All	
R	59-60	MERCURY COLONY PARK All	
R	68-69	COMET All	
R	66-67	COMET Convertible	
R	66-67	COMET Hardtop	
R	66-67	COMET Sedan	
R	60-65	COMET All	
R	59-60	COMMUTER All	
R	67-73	COUGAR All	
R	59-60	COUNTRY CRUISER All	
R	68-71	CYCLONE All	
R	62-63	METEOR All	
R	59-60	MONTCLAIR All	
R	68-71	MONTEGO All Exc. Wagon	
R	59-60	MONTEREY All	
R	59-60	PARKLANE All	
R	59	VOYAGER All	
R	69-78	SAAB 99 All	
R	59-68	VOLVO 122 All	
81318	C		141137
R	81-82	CHEVROLET LUV PICKUP All	
R	55	PICKUP 3100	
R	87-89	DODGE RAIDER 2.6L 4Cyl L (156), 3.59 91.1(Bore)3.86 98.0(Stroke)	
F	61-67	FORD ECONOLINE All	
F	68-72	INTERNATIONAL M1100 / M1200 All	
R	89-94	ISUZU AMIGO All	
R	81-95	PICKUP All	
R	84-86	TROOPER 4WD	
R	86-92	JEEP COMANCHE All	
R	66-67	GLADIATOR All	
F	64-65	GLADIATOR All Exc. Independent Front Suspension	
F	68-73	J2500 PICKUP All	
F	66-73	WAGONEER All	
F	63-65	WAGONEER All Exc. Independent Front Suspension	
R	49-51	MERCURY MERCURY All	
R	50-51	MONTEREY All	
R	83-89	MITSUBISHI MONTERO 2.6L 4Cyl L (156), 3.59 91.1(Bore)3.86 98.0(Stroke)	
R	82-86	NISSAN 720 PICKUP 4WD	
R	00-04	FRONTIER Crew Cab Pickup, RWD w/ Desert Runner	
R	98-04	FRONTIER 4WD	
R	98-99	FRONTIER RWD Crew Cab; w/ Desert Runner Package	
R	87-95	PATHFINDER All Exc. Electronic Adjustable Suspension	
R	87-97	PICKUP 4WD	
R	86	PICKUP 4WD Mfg. from 8/86	
R	57-60	PONTIAC BONNEVILLE All	
R	58-60	CATALINA All	
R	58	CHIEFTAIN All	
R	58-60	STAR CHIEF All	
R	58	SUPER CHIEF All	
R	60	VENTURA All	
R	84-87	TOYOTA LAND CRUISER FJ60 (MfrBodyCode), Sport Utility	
R	75-83	LAND CRUISER All	
R	69-74	LAND CRUISER All Wagon	
R	85-92	PICKUP RWD 1 Ton	
R	80-83	PICKUP 4WD Exc. Lift Kit	

Numerical listing

Shock	POP	Alternative No.	MTG Acc. Supplied
Pos.	Year	Application	
81340	D		141041
R	70-74	AMERICAN MOTORS AMBASSADOR All	
R	70	AMX All	
R	80-88	EAGLE All	
R	70-74	JAVELIN All	
R	71-78	MATADOR All	
R	76-87	CHEVROLET CHEVETTE All	
R	83-89	ISUZU IMPULSE All	
R	72	NISSAN 510 All	
R	74-77	710 Hardtop	
R	74-77	710 Sedan	
R	76-87	PONTIAC ACADIAN All	
R	81-87	T1000 All	
R	76-79	TOYOTA COROLLA Coupe	
R	72-79	COROLLA Sedan	
R	75-78	COROLLA Hardtop	
R	72-74	COROLLA Coupe	
R	79-81	CORONA Wagon	
R	73-76	CORONA Sedan	
R	73-74	CORONA Hardtop	
R	72	CORONA Mark II Exc. Wagon	
R	78-80	CRESSIDA Wagon	
F	75-79	LAND CRUISER FJ55 (MfrBodyCode), Sport Utility	
F	69-74	LAND CRUISER All	
81342	C		
R	81-93	DODGE PICKUP 1/2 TON, W100 SERIES All Exc. Lift Kit	
R	72-80	PICKUP 1/2 TON, W100 SERIES All	
R	81-93	PICKUP 1 TON, W300 SERIES All Exc. Quad Suspension and Lift Kit	
R	72-80	PICKUP 1 TON, W300 SERIES All	
R	90-93	PICKUP 3/4 TON, W200 SERIES Extended Cab Pickup Exc. Lift Kit	
R	88-93	PICKUP 3/4 TON, W200 SERIES Cab & Chassis Exc. Lift Kit	
R	81-93	PICKUP 3/4 TON, W200 SERIES Standard Cab Pickup Exc. Lift Kit	
R	86	PICKUP 3/4 TON, W200 SERIES Cab & Chassis Exc. Lift Kit	
R	81-83	PICKUP 3/4 TON, W200 SERIES Cab & Chassis Exc. Lift Kit	
R	81-82	PICKUP 3/4 TON, W200 SERIES Extended Cab Pickup Exc. Lift Kit	
R	72-80	PICKUP 3/4 TON, W200 SERIES All	
R	76-93	RAMCHARGER 4WD	
R	78-80	RD200 All	
R	76-81	PLYMOUTH TRAILDUSTER 4WD	
81394	B		140780
F	78-79	FORD BRONCO All Quad Front Suspension, Shocks behind the front axle; Exc. Lift Kit	
F	78-79	BRONCO All RWD, 4WD Quad Suspension Rearward of Front Axle, Non Quad Suspension	
F	66-77	BRONCO All From Serial #830001; Exc. Lift Kit	
F	66-77	BRONCO All From Serial #830001; Exc. Lift Kit RWD, 4WD Quad Suspension Rearward of Front Axle, Non Quad Suspension	
F	65-79	PICKUP 1/2 TON, F-100 All Quad Suspension Rearward of Front Axle	
F	75-79	PICKUP 1/2 TON, F-150 All Quad Suspension Rearward of Front Axle	
F	67-79	PICKUP 1 TON, F-350 / SUPERDUTY All Quad Suspension Rearward of Front Axle	
F	65-79	PICKUP 3/4 TON, F-250 / SUPERDUTY All Quad Suspension Rearward of Front Axle	
F	75-91	VAN 1 TON, ECONOLINE / CLUB WAGON / SUPERDUTY All Exc. Cutaway Chassis	
F	75-91	VAN 1 TON, ECONOLINE / CLUB WAGON / SUPERDUTY All Exc. Cutaway Chassis RWD, 4WD Quad Suspension Rearward of Front Axle, Non Quad Suspension	
F	75-91	VAN 3/4 TON, ECONOLINE / CLUB WAGON / SUPERDUTY All	
F	75-91	VAN 3/4 TON, ECONOLINE / CLUB WAGON / SUPERDUTY All RWD, 4WD Quad Suspension Rearward of Front Axle, Non Quad Suspension	
81416	W		141045
R	78-85	TOYOTA CELICA All	
R	75-83	COROLLA Wagon	
R	74	COROLLA All Mfg. from 8/74; Wagon	
R	79-82	CORONA Hatchback	

Numerical listing

Shock	POP	Alternative No.	MTG Acc. Supplied
Pos.	Year	Application	
81416	W (cont)		141045
R	79-82	CORONA Sedan	
R	81-87	CRESSIDA Wagon	
81440	W		141045
R	85-88	TOYOTA CRESSIDA Sedan Exc. Electronic Adjustable Suspension	
R	83-84	CRESSIDA Sedan	
R	81-82	CRESSIDA Sedan Exc. Electronic Adjustable Suspension	
R	78-80	CRESSIDA Sedan	
R	81-84	STARLET All	
81446	A		141041
F	71-73	BUICK CENTURION All	
F	91-96	COMMERCIAL CHASSIS All	
F	71-84	ELECTRA All	
F	71-83	ESTATE WAGON All	
F	71-85	LESABRE All	
F	71-78	RIVIERA All	
F	91-96	ROADMASTER All	
F	87-92	CADILLAC BROUGHAM All	
F	92-96	COMMERCIAL CHASSIS RWD	
F	77-84	COMMERCIAL CHASSIS All	
F	77-84	DEVILLE All	
F	93-96	FLEETWOOD RWD	
F	77-86	FLEETWOOD RWD	
F	81	CHEVROLET BEL AIR Sedan Exc. Police and Taxi Models	
F	65-75	BEL AIR Sedan Exc. Police and Taxi Models	
F	65-72	BISCAYNE All Exc. Police and Taxi Models	
F	69-72	BROOKWOOD All	
F	70-81	CAMARO All	
F	73-96	CAPRICE Wagon	
F	71-72	CAPRICE Hardtop Exc. Police and Taxi Models	
F	70	CAPRICE Hardtop	
F	66-69	CAPRICE All	
F	94-96	IMPALA All Wagon; Exc. Police and Taxi Models	
F	83-85	IMPALA All Wagon; Exc. Police and Taxi Models	
F	65-82	IMPALA Wagon Exc. Police and Taxi Models	
F	69-72	KINGSWOOD All	
F	69-72	TOWNSMAN All	
F	65-74	FORD COUNTRY SEDAN All	
F	87-91	COUNTRY SQUIRE All	
F	65-74	COUNTRY SQUIRE All	
F	93-02	CROWN VICTORIA Base	
F	93-02	CROWN VICTORIA LX	
F	93-02	CROWN VICTORIA S	
F	02	CROWN VICTORIA LWB	
F	92	CROWN VICTORIA All	
F	65-72	CUSTOM All	
F	68-77	CUSTOM 500 All	
F	75-76	ELITE All	
F	65-67	GALAXIE All	
F	68-74	GALAXIE 500 All	
F	64-66	GALAXIE 500 All	
F	01-02	GRAND MARQUIS All	
F	87-91	LTD / COUNTRY SEDAN / COUNTRY SQUIRE / CROWN VICTORIA All	
F	85-86	LTD / COUNTRY SEDAN / COUNTRY SQUIRE / CROWN VICTORIA Crown Victoria	
F	65-82	LTD / COUNTRY SEDAN / COUNTRY SQUIRE / CROWN VICTORIA All	
F	77-79	LTD II All	
F	72-79	RANCHERO All	
F	65-74	RANCH WAGON All	
F	67-79	THUNDERBIRD All	
F	72-76	TORINO All	
F	70-80	LINCOLN CONTINENTAL All	
F	68-71	MARK III All	
F	72-76	MARK IV All	
F	77-79	MARK V All	
F	80-83	MARK VI All	
F	81-02	TOWN CAR All	
F	67	MERCURY BROUGHAM All	
F	87-91	COLONY PARK All	
F	65-74	COLONY PARK All	
F	65-68	COMMUTER All	
F	74-79	COUGAR All	
F	75-02	GRAND MARQUIS All	
F	69-70	MARAUDER All	
F	65-67	MARAUDER All	
F	67-82	MARQUIS All	
F	65-68	MONTCLAIR All	
F	72-76	MONTEGO All	
F	65-74	MONTEREY All	

Guardian Shock

Shock	POP	Alternative No.	MTG Acc. Supplied
Pos.	Year	Application	
81446	A (cont)		141041
F	65-68	PARKLANE All	
F	65-67	VILLAGER All	
F	66-67	VOYAGER All	
F	71-85	OLDSMOBILE 88 SERIES All	
F	71-84	98 All	
F	71-92	CUSTOM CRUISER All	
F	71-81	PONTIAC BONNEVILLE All	
F	71-81	CATALINA All	
F	70-81	FIREBIRD All	
F	71-78	GRAND SAFARI All	
F	76-81	LAURENTIAN All	
F	76-86	PARISIENNE All	
F	87-89	SAFARI All	
81459	W		
R	84-93	CHRYSLER DAYTONA All	
R	83-84	E CLASS All	
R	85	EXECUTIVE LIMOUSINE All	
R	83-84	EXECUTIVE SEDAN All	
R	90-93	IMPERIAL All Exc. Hydraulic Self-Leveling System	
R	84-86	LASER All	
R	81-95	LEBARON All	
R	88-93	NEW YORKER All Exc. Hydraulic Self-Leveling System	
R	83-87	NEW YORKER All	
R	82-88	TOWN & COUNTRY All	
R	82-83	DODGE 400 All	
R	87-88	600 All	
R	86	600 All Mfg. to 2/86	
R	83-85	600 All	
R	81-89	ARIES All	
R	92-93	DAYTONA Iroc R/T	
R	91-93	DAYTONA Iroc	
R	89-93	DAYTONA ES	
R	89-90	DAYTONA ES Turbo	
R	87-88	DAYTONA Pacifica	
R	86	DAYTONA Turbo Z	
R	84-85	DAYTONA Turbo	
R	85-89	LANCER All	
R	87-94	SHADOW All	
R	89-95	SPIRIT All	
R	89-95	PLYMOUTH ACCLAIM All	
R	88	CARAVELLE FWD	
R	83-87	CARAVELLE All	
R	81-89	RELIANT All	
R	87-94	SUNDANCE All	
81469	A		
R	57-64	CHRYSLER 300 All	
R	57-66	IMPERIAL All	
R	55	IMPERIAL All	
R	55-56	NASSAU All	
R	51-64	NEWPORT All	
R	51-64	NEW YORKER All	
R	57-60	SARATOGA All	
R	51-52	SARATOGA All	
R	55-56	ST REGIS All	
R	51-64	TOWN & COUNTRY All	
R	51-61	WINDSOR All	
R	62-64	DODGE 880 All	
R	64-70	A100 TRUCK All	
R	51-59	CORONET All	
R	54-61	CUSTOM All	
R	63-76	DART All	
R	60-61	DART All	
R	61-62	LANCER All	
R	51-54	MEADOWBROOK All	
R	60-61	POLARA All	
R	64-70	VAN 1/2 TON, A / B SERIES / RAM All	
R	58-59	EDSEL CORSAIR All Exc. Wagon	
R	58-59	RANGER All Exc. Wagon	
R	58-59	VILLAGER All Exc. Wagon	
R	64-69	PLYMOUTH BARRACUDA All	
R	53-61	BELVEDERE All	
R	51-53	CAMBRIDGE All	
R	51-52	CONCORD All	
R	51-53	CRANBROOK All	
R	58-61	CUSTOM All	
R	70-76	DUSTER All	
R	60-61	FLEET SPECIAL All	
R	56-61	FURY All	
R	54-58	PLAZA All	
R	53-61	SAVOY All	
R	71-76	SCAMP All	
R	60-61	SPORT WAGON All	
R	51-61	SUBURBAN All	
R	60-76	VALIANT All	
81478	W		140857
F	81-82	CHEVROLET LUV PICKUP RWD	
F	81-95	ISUZU PICKUP RWD	
F	69-72	NISSAN 521 PICKUP All	

Numerical listing

Shock	POP	Alternative No.	MTG Acc. Supplied
Pos.	Year	Application	
81478	W (cont)		140857
F	72-79	620 PICKUP All	
F	80-86	720 PICKUP All	
F	87-97	PICKUP 4WD	
F	86	PICKUP 4WD Mfg. from 8/86	
81481	B		142261
R	82-02	CHEVROLET CAMARO All	
R	82-02	PONTIAC FIREBIRD All	
81482	A		
R	05	CHEVROLET BLAZER Base, 4WD	
R	05	BLAZER Base, RWD	
R	96-04	BLAZER LS, 4WD	
R	96-04	BLAZER LS, RWD	
R	95-02	BLAZER LT, RWD	
R	95-01	BLAZER LT, 4WD	
R	95-99	BLAZER Base, 4WD	
R	95-99	BLAZER Base, RWD	
R	95-97	BLAZER Deluxe, RWD	
R	83-94	BLAZER, S MODELS All	
R	94-04	S10 LS, 4WD	
R	99-03	S10 Base, 4WD	
R	99-03	S10 LS, RWD	
R	98-03	S10 Base, RWD	
R	83-97	S10 Base, 4WD	
R	92-93	S10 EL, 4WD	
R	83-92	S10 Tahoe, 4WD	
R	88-90	S10 Durango, 4WD	
R	83-86	S10 Durango, 4WD	
R	05	GMC JIMMY 4WD	
R	92-04	JIMMY All	
R	83-91	S15 JIMMY All	
R	82-04	SONOMA / S15 All	
R	91	SYCLONE All	
R	92-93	TYPHOON All	
R	96-00	ISUZU HOMBRE All	
R	96-01	OLDSMOBILE BRAVADA All	
R	91-94	BRAVADA All	
81484	C		141137
R	78-79	FORD BRONCO All Exc. Lift Kit	
R	66-77	BRONCO All From Serial #830001; Exc. Lift Kit	
R	65-69	PICKUP 1/2 TON, F-100 All RWD; w/Front Coil Springs	
R	75-79	PICKUP 1 TON, F-350 / SUPERDUTY Standard Cab Pickup, RWD	
R	73-74	PICKUP 1 TON, F-350 / SUPERDUTY All RWD; Exc. Supercab	
R	75-79	PICKUP 3/4 TON, F-250 / SUPERDUTY Extended Cab Pickup, RWD	
R	73-74	PICKUP 3/4 TON, F-250 / SUPERDUTY RWD Supercab	
R	65-72	PICKUP 3/4 TON, F-250 / SUPERDUTY All RWD; Supercab	
R	69-74	VAN 1/2 TON, ECONOLINE / CLUB WAGON All	
R	69-74	VAN 1 TON, ECONOLINE / CLUB WAGON / SUPERDUTY All	
R	69-74	VAN 3/4 TON, ECONOLINE / CLUB WAGON / SUPERDUTY All	
R	76-83	JEEP CHEROKEE All	
F	74-83	CHEROKEE All	
F	82-83	CJ5 All Exc. Lift Kit	
F	82-86	CJ7 All Exc. Lift Kit	
F	67	GLADIATOR All	
F	93	GRAND WAGONEER All	
R	93	GRAND WAGONEER All	
F	84-91	GRAND WAGONEER All	
R	84-91	GRAND WAGONEER All	
F	74-88	J10 PICKUP All	
F	74-88	J10 PICKUP All	
F	74-88	J20 PICKUP All	
R	74-88	J20 PICKUP All	
R	68-73	J2500 PICKUP All	
F	82-85	SCRAMBLER / CJ8 All	
R	76-83	WAGONEER All	
F	74-83	WAGONEER All	
81490	B		140780
F	80-96	FORD BRONCO All Rearward of Front Axle; Exc. Lift Kit	
F	89	BRONCO II All Mfg. to 2/89; Vehicles w/ 10mm & 12mm bolt in rear lower mount	
F	84-88	BRONCO II All w/ 10mm Bolt In Rear Lower Mount	
F	86-90	F-200 All	
F	97	F-250 HD RWD	
F	80-83	PICKUP 1/2 TON, F-100 RWD	
F	80-96	PICKUP 1/2 TON, F-150 All	

Numerical listing

Shock	POP	Alternative No.	MTG Acc. Supplied
Pos.	Year	Application	
81490	B (cont)		140780
F	80-97	PICKUP 1 TON, F-350 / SUPERDUTY RWD	
F	97	PICKUP 3/4 TON, F-250 / SUPERDUTY RWD Over 8500# GVW	
F	80-96	PICKUP 3/4 TON, F-250 / SUPERDUTY RWD	
F	87-89	RANGER All Exc. High Ryder Option	
F	83-86	RANGER All	
81491	C		141164
F	80-88	AMERICAN MOTORS EAGLE All	
F	75-80	FORD GRANADA All	
F	71-73	MUSTANG / MUSTANG II All	
F	77-80	LINCOLN VERSAILLES All	
F	71-73	MERCURY COUGAR All	
F	75-80	MONARCH All	
81492	A		140629
R	73-81	BUICK CENTURY All	
R	71-83	ESTATE WAGON All	
R	65-67	GRAND SPORT All	
R	68-72	GS / GS350 / GS400 / GS455 All	
R	73-87	REGAL All	
R	91-96	ROADMASTER Wagon	
R	68-72	SKYLARK All	
R	64-67	SKYLARK All Heavy Duty Suspension	
R	68-69	SPECIAL All	
R	64-67	SPECIAL All Heavy Duty Suspension	
R	70-72	SPORTWAGON All	
R	71-72	CHEVROLET BROOKWOOD All	
R	71-96	CAPRICE Wagon	
R	68-73	CHEVELLE All	
R	64-67	CHEVELLE All Heavy Duty Suspension	
R	68-87	EL CAMINO All	
R	71-82	IMPALA Wagon	
R	71-72	KINGSWOOD All	
R	73-83	MALIBU All	
R	64-67	MALIBU All Heavy Duty Suspension	
R	70-88	MONTE CARLO All	
R	71-72	TOWNSMAN All	
R	78-87	GMC SPRINT / CABALLERO RWD	
R	71-77	SPRINT / CABALLERO All	
R	74-76	NISSAN 610 Wagon	
R	73	610 All Wagon	
R	74-77	710 Wagon	
R	77-80	810 Wagon	
R	71-92	OLDSMOBILE CUSTOM CRUISER All	
R	68-87	CUTLASS / CUTLASS SUPREME All	
R	72	CUTLASS / CUTLASS SUPREME Base	
R	72	CUTLASS / CUTLASS SUPREME S All Heavy Duty Suspension	
R	64-67	CUTLASS / CUTLASS SUPREME All Heavy Duty Suspension	
R	80-83	CUTLASS CLASSIC / CUTLASS CRUISER All	
R	68-72	F85 All	
R	61-67	F85 All Heavy Duty Suspension	
R	71-78	TORONADO All	
R	82-86	PONTIAC BONNEVILLE All	
R	77-81	CATALINA Wagon	
R	71-75	CATALINA Wagon	
R	78-80	GRAND AM All	
R	73-75	GRAND AM All	
R	75-83	GRAND LEMANS All	
R	69-87	GRAND PRIX All	
R	71-78	GRAND SAFARI All	
R	71-75	GRANDVILLE All	
R	68-73	GTO All	
R	64-67	GTO All Heavy Duty Suspension	
R	68-81	LEMANS All	
R	64-67	LEMANS All Heavy Duty Suspension	
R	80-86	PARISIENNE Wagon	
R	76-79	PARISIENNE All Wagon	
R	87-89	SAFARI All	
R	68-70	TEMPEST All	
R	64-67	TEMPEST All Heavy Duty Suspension	
81494	A		140455
F	73-75	BUICK APOLLO All	
F	73-81	CENTURY All	
F	68-72	GS / GS350 / GS400 / GS455 All	
F	73-87	REGAL All	
F	75-79	SKYLARK All	
F	68-72	SKYLARK All	
F	68-69	SPECIAL All	

Guardian Shock

Shock	POP	Alternative No.	MTG Acc. Supplied
Pos.	Year	Application	
81494	A (cont)		140455
F	68-72	SPORTWAGON All	
F	76-79	CADILLAC SEVILLE All	
F	67-69	CHEVROLET CAMARO All	
F	68-73	CHEVELLE All	
F	68	CHEVY II All	
F	73-83	MALIBU All	
F	70-88	MONTE CARLO All	
F	69-79	NOVA All	
F	64-65	NISSAN 410 All	
F	64-67	411 All	
F	68-87	OLDSMOBILE CUTLASS / CUTLASS SUPREME All	
F	80-83	CUTLASS CLASSIC / CUTLASS CRUISER All	
F	68-72	F85 All	
F	74-79	OMEGA All	
F	73	OMEGA All Exc. Heavy Duty Suspension	
F	82-86	PONTIAC BONNEVILLE All	
F	67-69	FIREBIRD All	
F	78-80	GRAND AM All	
F	73-75	GRAND AM All	
F	75-83	GRAND LEMANS All	
F	69-87	GRAND PRIX All	
F	71-75	GRANDVILLE All	
F	68-73	GTO All	
F	68-81	LEMANS All	
F	77-79	PHOENIX All	
F	68-70	TEMPEST All	
F	71-77	VENTURA All	
F	67-78	TOYOTA CORONA All	
F	68-75	VOLVO 142 / 144 / 145 / 164 All	
81495	A		141150
R	61-63	BUICK SKYLARK All	
R	61-63	SPECIAL All	
R	64-69	SPORTWAGON All	
R	68-69	CHEVROLET CAMARO All Multi Leaf Models	
R	65-74	FORD COUNTRY SEDAN All	
R	87-91	COUNTRY SQUIRE All	
R	65-74	COUNTRY SQUIRE All	
R	92-02	CROWN VICTORIA All	
R	65-72	CUSTOM All	
R	68-77	CUSTOM 500 All	
R	75-76	ELITE All	
R	66-70	FALCON All Wagon	
R	65-67	GALAXIE All	
R	68-74	GALAXIE 500 All	
R	64-66	GALAXIE 500 All	
R	01-02	GRAND MARQUIS All	
R	87-91	LTD / COUNTRY SEDAN / COUNTRY SQUIRE / CROWN VICTORIA All	
R	65-82	LTD / COUNTRY SEDAN / COUNTRY SQUIRE / CROWN VICTORIA All	
R	77-79	LTD II All	
R	66-79	RANCHERO All	
R	65-74	RANCH WAGON All	
R	77-79	THUNDERBIRD All	
R	67-72	THUNDERBIRD All	
R	74-76	TORINO Wagon	
R	71	TORINO All Wagon	
R	70-80	LINCOLN CONTINENTAL All	
R	68-71	MARK III All	
R	72	MARK IV All	
R	80-83	MARK VI All	
R	81-02	TOWN CAR All	
R	67	MERCURY BROUGHAM All	
R	87-91	COLONY PARK All	
R	65-74	COLONY PARK All	
R	66-67	COMET Wagon	
R	65-68	COMMUTER All	
R	74-79	COUGAR All	
R	75-02	GRAND MARQUIS All	
R	69-70	MARAUDER All	
R	65-67	MARAUDER All	
R	67-82	MARQUIS All	
R	65-68	MONTECLAIR All	
R	74-76	MONTEGO Wagon	
R	68-73	MONTEGO All Wagon	
R	65-74	MONTEREY All	
R	65-68	PARKLANE All	
R	65-67	VILLAGER All	
R	66-67	VOYAGER All	
R	64-72	OLDSMOBILE VISTA CRUISER All	
R	68-69	PONTIAC FIREBIRD All	
81496	D		
F	87-91	CHEVROLET BLAZER 4WD Full Size; Quad Suspension Long Shock; Exc. Lift Kit	

Numerical listing

Shock	POP	Alternative No.	MTG Acc. Supplied
Pos.	Year	Application	
81496	D (cont)		
F	81-86	BLAZER 4WD Quad Suspension Long Shock; Exc. Lift Kit	
F	81-86	PICKUP 1/2 TON, K10 All Quad Suspension Long Shock; Exc. Lift Kit	
F	87	PICKUP 1/2 TON, V10 All Quad Suspension Long Shock; Exc. Lift Kit	
F	81-86	PICKUP 3/4 TON, K20 All Quad Suspension Long Shock; Exc. Lift Kit	
F	87	PICKUP 3/4 TON, V20 All Quad Suspension Long Shock; Exc. Lift Kit	
F	81-86	SUBURBAN 1/2 TON, K10 All Quad Suspension Long Shock; Exc. Lift Kit	
F	87-88	SUBURBAN 1/2 TON, V10 All Quad Suspension Long Shock; Exc. Lift Kit	
F	81-86	SUBURBAN 3/4 TON, K20 All Quad Suspension Long Shock; Exc. Lift Kit	
F	87-88	SUBURBAN 3/4 TON, V20 All Quad Suspension Long Shock; Exc. Lift Kit	
F	89-91	SUBURBAN 3/4 TON, V2500 All Quad Suspension Long Shock; Exc. Lift Kit	
R	78-95	VAN 1/2 TON, G / EXPRESS All	
R	78-95	VAN 1 TON, G / EXPRESS Cutaway Van	
R	78-95	VAN 3/4 TON, G / EXPRESS All Exc. 8600# GVW	
R	84-86	DODGE MINI RAM All	
R	99-03	VAN 1/2 TON, A / B SERIES / RAM 109.3 / 277.6 (WheelBase) Exc. 7000# GVW	
R	81-98	VAN 1/2 TON, A / B SERIES / RAM 109.6 / 278.4 (WheelBase) Exc. 7000# GVW	
R	71-80	VAN 1/2 TON, A / B SERIES / RAM All	
R	99-03	VAN 1 TON, A / B SERIES / RAM All	
R	95-98	VAN 1 TON, A / B SERIES / RAM All Exc. 4000# Front Axle	
R	71-94	VAN 1 TON, A / B SERIES / RAM All	
R	71-03	VAN 3/4 TON, A / B SERIES / RAM All	
R	74-80	VAN, CB300 All	
F	75-91	GMC JIMMY 4WD Quad Suspension Long Shock; Exc. Lift Kit	
F	81-86	PICKUP 1/2 TON, K15 / K1500 All Quad Suspension Long Shock; Exc. Lift Kit	
F	87	PICKUP 1/2 TON, V1500 All Quad Suspension Long Shock; Exc. Lift Kit	
F	87-88	PICKUP 1 TON, V3000 / V3500 All Quad Suspension Long Shock; Exc. Lift Kit	
F	81-86	PICKUP 3/4 TON, K25 / K2500 All Quad Suspension Long Shock; Exc. Lift Kit	
F	87	PICKUP 3/4 TON, V2500 All Quad Suspension Long Shock; Exc. Lift Kit	
F	81-86	SUBURBAN 1/2 TON, K15 / K1500 All Quad Suspension Long Shock; Exc. Lift Kit	
F	87-91	SUBURBAN 1/2 TON, V1500 All Quad Suspension Long Shock; Exc. Lift Kit	
F	81-86	SUBURBAN 3/4 TON, K25 / K2500 All Quad Suspension Long Shock; Exc. Lift Kit	
F	87-91	SUBURBAN 3/4 TON, V2500 All Quad Suspension Long Shock; Exc. Lift Kit	
R	78-95	VAN 1/2 TON, G / SAVANA All	
R	85-96	VAN 1 TON, G / SAVANA Extended Cargo Van	
R	85-96	VAN 1 TON, G / SAVANA Extended Passenger Van	
R	79-96	VAN 1 TON, G / SAVANA Standard Cargo Van	
R	79-96	VAN 1 TON, G / SAVANA Standard Passenger Van	
R	78	VAN 1 TON, G / SAVANA Cutaway Van	
R	78-95	VAN 3/4 TON, G / SAVANA All Exc. 8600# GVW	
R	74-83	PLYMOUTH VAN 1/2 TON, PB SERIES All	
R	74-83	VAN 1 TON, PB SERIES All	
R	74-83	VAN 3/4 TON, PB SERIES All	
81507	A		140857
F	81-82	CHEVROLET LUV PICKUP 4WD	
F	75-80	LUV PICKUP All	
F	72-74	LUV PICKUP All	
F	89-94	ISUZU AMIGO All	
F	81-95	PICKUP 4WD	
F	84-86	TROOPER 4WD	

Numerical listing

Shock	POP	Alternative No.	MTG Acc. Supplied
Pos.	Year	Application	
81507		A (cont)	140857
F	98-04	NISSAN FRONTIER RWD Exc. Desert Runner	
F	87-97	PICKUP RWD	
F	86	PICKUP RWD Mfg. from 8/86	
81510		B	
R	97	FORD F-250 HD 4WD	
R	80-96	PICKUP 1/2 TON, F-150 4WD Exc. Lift Kit	
R	86-97	PICKUP 1 TON, F-350 / SUPERDUTY 4WD Dual Rear Wheels	
R	82-85	PICKUP 1 TON, F-350 / SUPERDUTY 4WD Clevis Type Lower Front Mount; Exc. Dual Rear Wheels or Lift Kit	
R	80-81	PICKUP 1 TON, F-350 / SUPERDUTY 4WD	
R	97	PICKUP 3/4 TON, F-250 / SUPERDUTY 4WD Over 8500# GVW	
R	86-96	PICKUP 3/4 TON, F-250 / SUPERDUTY 4WD	
R	82-85	PICKUP 3/4 TON, F-250 / SUPERDUTY 4WD Clevis Type Lower Front Mount; Exc. Dual Rear Wheels or Lift Kit	
R	80-81	PICKUP 3/4 TON, F-250 / SUPERDUTY 4WD	
81514		A	140629
R	73	BUICK APOLLO All Heavy Duty Suspension	
R	71-73	CENTURION All	
R	71-84	ELECTRA All	
R	70	ESTATE WAGON All	
R	71-85	LESABRE All	
R	71-78	RIVIERA All	
R	92-96	ROADMASTER Sedan	
R	64-67	SKYLARK All Exc. Heavy Duty Suspension	
R	64-67	SPECIAL All Exc. Heavy Duty Suspension	
R	87-92	CADILLAC BROUGHAM All	
R	92-96	COMMERCIAL CHASSIS RWD	
R	77-84	COMMERCIAL CHASSIS All	
R	77-84	DEVILLE All	
R	93-96	FLEETWOOD RWD	
R	77-86	FLEETWOOD RWD	
R	81	CHEVROLET BEL AIR Sedan	
R	65-75	BEL AIR All	
R	65-72	BISCAYNE All	
R	69-70	BROOKWOOD All	
R	73-96	CAPRICE Sedan Police and Taxi Models	
R	71-72	CAPRICE Hardtop Police and Taxi Models	
R	66-70	CAPRICE All	
R	64-67	CHEVELLE All Exc. Heavy Duty Suspension	
R	68	CHEVY II All	
R	64-67	EL CAMINO All	
R	94-96	IMPALA All	
R	83-85	IMPALA All	
R	65-82	IMPALA Sedan	
R	74-81	IMPALA Coupe	
R	73	IMPALA Hardtop	
R	69-70	KINGSWOOD All	
R	64-67	MALIBU All Exc. Heavy Duty Suspension	
R	73	NOVA All Heavy Duty Suspension	
R	69-72	NOVA All	
R	69-70	TOWNSMAN All	
R	65-85	OLDSMOBILE 88 SERIES All	
R	65-84	98 All	
R	64-67	CUTLASS / CUTLASS SUPREME All Exc. Heavy Duty Suspension	
R	65-66	DYNAMIC 88 All	
R	61-67	F85 All Exc. Heavy Duty Suspension	
R	65-66	STARFIRE All	
R	63-81	PONTIAC BONNEVILLE All	
R	75-81	CATALINA Coupe	
R	71-81	CATALINA Sedan	
R	71-74	CATALINA Hardtop	
R	63-70	CATALINA All	
R	67-70	EXECUTIVE All	
R	63-68	GRAND PRIX All	
R	64-67	GTO All Exc. Heavy Duty Suspension	
R	76-81	LAURENTIAN CAN	
R	64-67	LEMANS All Exc. Heavy Duty Suspension	
R	76-86	PARISIENNE Sedan	

Guardian Shock

Shock	POP	Alternative No.	MTG Acc. Supplied
Pos.	Year	Application	
81514		A (cont)	140629
R	63-66	STAR CHIEF All	
R	64-67	TEMPEST All Exc. Heavy Duty Suspension	
R	73	VENTURA All Heavy Duty Suspension	
R	71-72	VENTURA All Leaf(RearSpringType)	
81516		B	
F	05	CHEVROLET BLAZER Base, 4WD	
F	96-04	BLAZER LS, 4WD	
F	95-01	BLAZER LT, 4WD	
F	95-99	BLAZER Base, 4WD	
F	83-94	BLAZER, S MODELS 4WD	
F	94-04	S10 LS, 4WD	
F	83-03	S10 Base, 4WD	
F	92-93	S10 EL, 4WD	
F	83-92	S10 Tahoe, 4WD	
F	88-90	S10 Durango, 4WD	
F	83-86	S10 Durango, 4WD	
F	92-05	GMC JIMMY 4WD	
F	83-91	S15 JIMMY 4WD	
F	83-04	SONOMA / S15 4WD	
F	91	SYCLONE All	
F	92-93	TYPHOON All	
F	99-00	ISUZU HOMBRE 4WD	
F	96-98	HOMBRE All Sport Chassis	
F	96-01	OLDSMOBILE BRAVADA All	
F	91-94	BRAVADA All	
81540		D	
R	83-89	FORD RANGER 4WD	
81541		W	140455
F	85-95	TOYOTA PICKUP RWD Exc. 1 Ton	
F	84	PICKUP RWD	
F	93-98	T100 RWD	
81548		C	141353
F	84-01	JEEP CHEROKEE All	
F	86-92	COMANCHE All	
F	93-98	GRAND CHEROKEE All	
F	84-90	WAGONEER All	
81549		B	
R	84-01	JEEP CHEROKEE All	
R	84-90	WAGONEER All	
81553		W	140524
F	87-91	ISUZU TROOPER 4WD	
F	86-87	MAZDA B2000 RWD	
F	87-93	B2200 RWD	
F	87-93	B2600 RWD	
81559		C	140126
F	87-04	DODGE DAKOTA RWD	
F	99-03	DURANGO RWD	
81560		C	
R	87-96	DODGE DAKOTA RWD	
81581		W	
R	90-05	CHEVROLET ASTRO All	
R	85-89	ASTRO RWD	
R	90-05	GMC SAFARI All	
R	85-89	SAFARI RWD	
R	86-89	VOLKSWAGEN VANAGON 4WD	
81582		D	140126
F	86-97	FORD AEROSTAR RWD	
81583		C	
R	86-88	FORD AEROSTAR RWD	
R	87-95	JEEP WRANGLER YJ (MfirBodyCode)	
81667		C	
R	88-99	CHEVROLET PICKUP 1/2 TON, C15 / C1500 All	
R	88-99	PICKUP 1/2 TON, K15 / K1500 All	
R	88-00	PICKUP 1 TON, C35/3500 Extended Cab Pickup Exc. HD Straight Front Axle	
R	88-00	PICKUP 1 TON, C35/3500 Standard Cab Pickup Exc. HD Straight Front Axle	
R	88-00	PICKUP 1 TON, K35 / K3500 All	
R	88-00	PICKUP 3/4 TON, C25 / C2500 All	
R	88-00	PICKUP 3/4 TON, K25 / K2500 All	
R	88-99	GMC PICKUP 1/2 TON, C15 / C1500 All	
R	88-99	PICKUP 1/2 TON, K15 / K1500 All	
R	89-00	PICKUP 1 TON, C35/3500 Extended Cab Pickup Exc. HD Straight Front Axle	

Numerical listing

Shock	POP	Alternative No.	MTG Acc. Supplied
Pos.	Year	Application	
81667		C (cont)	
R	88-00	PICKUP 1 TON, C35/3500 Standard Cab Pickup Exc. HD Straight Front Axle	
R	88-00	PICKUP 1 TON, K35 / K3500 All	
R	88-00	PICKUP 3/4 TON, C25 / C2500 All	
R	88-00	PICKUP 3/4 TON, K25 / K2500 All	
81668		B	141277
F	88-99	CHEVROLET PICKUP 1/2 TON, C15 / C1500 All	
F	92-00	PICKUP 1 TON, C35/3500 All Exc. HD Straight Front Axle	
F	88-91	PICKUP 1 TON, C35/3500 Extended Cab Pickup Exc. HD Straight Front Axle	
F	88-91	PICKUP 1 TON, C35/3500 Standard Cab Pickup Exc. HD Straight Front Axle	
F	88-00	PICKUP 3/4 TON, C25 / C2500 All	
F	92-99	SUBURBAN 1/2 TON, C15 / C1500 All	
F	92-99	SUBURBAN 3/4 TON, C25 / C2500 All	
F	95-00	TAHOE RWD Old Body Style	
F	88-99	GMC PICKUP 1/2 TON, C15 / C1500 All	
F	88-00	PICKUP 1 TON, C35/3500 All Exc. HD Straight Front Axle	
F	88-00	PICKUP 3/4 TON, C25 / C2500 All	
F	92-99	SUBURBAN 1/2 TON, C15 / C1500 All	
F	92-99	SUBURBAN 3/4 TON, C25 / C2500 All	
F	92-99	YUKON RWD	
81675		C	140455
F	86-95	SUZUKI SAMURAI All	
81676		A	
R	77-79	DODGE COLT Coupe	
R	77-79	COLT Sedan	
R	77	COLT Hardtop	
R	54-55	FORD PICKUP 1/2 TON, F-100 All	
R	53	PICKUP 1/2 TON, F-100 All Exc. Heavy Duty Suspension	
R	53-55	PICKUP 1 TON, F-350 / SUPERDUTY All	
R	53-55	PICKUP 3/4 TON, F-250 / SUPERDUTY All	
R	74	JEEP CHEROKEE All	
F	59-66	CJ3 All	
R	59-66	CJ3 All	
F	66-68	CJ5 All	
F	72-81	CJ5 All	
R	59-81	CJ5 All	
F	66-71	CJ5 All 5 Leaf Front Springs; Exc. Lift Kit	
R	66-71	CJ5 All 5 Leaf Front Springs; Exc. Lift Kit	
F	59-65	CJ5 All	
F	66-68	CJ6 All	
F	72-75	CJ6 All	
R	59-75	CJ6 All	
F	66-71	CJ6 All 5 Leaf Front Springs; Exc. Lift Kit	
R	66-71	CJ6 All 5 Leaf Front Springs; Exc. Lift Kit	
F	59-65	CJ6 All	
F	76-81	CJ7 All	
F	61-67	DISPATCHER All	
R	61-67	DISPATCHER All	
F	59-66	DJ3 All	
R	59-66	DJ3 All	
F	65-74	DJ5 All	
F	65-68	DJ6 All	
R	61-65	FC150 All	
F	57-60	FC150 All	
F	60-68	M151 All	
F	81	SCRAMBLER / CJ8 All	
F	56-66	TRUCK All	
F	61-67	UNIVERSAL All 5 Leaf Front Springs; Exc. Lift Kit	
R	61-67	UNIVERSAL All 5 Leaf Front Springs; Exc. Lift Kit	
R	63-74	WAGONEER All	
F	63-65	WAGONEER All Independent Front Suspension	
F	43-58	WILLYS All	
R	43-58	WILLYS All	
R	76-80	PLYMOUTH ARROW All	
R	76-79	COLT All	
R	56-57	SAAB 93 All	
R	58-59	93B All	
R	58-59	GT750 All	

Numerical listing

Shock	POP	Alternative No.	MTG Acc. Supplied
Pos.	Year	Application	
81676	A (cont)		
R 63	GT850 All		
R 86-95	SUZUKI SAMURAI All		
81691	C 141353		
F 87-95	JEEP WRANGLER YJ (MfrBodyCode)		
81694	W 140780		
F 75-91	FORD VAN 1/2 TON, ECONOLINE / CLUB WAGON All		
81710	C		
R 80-96	FORD BRONCO All Exc. Lift Kit		
R 80-83	PICKUP 1/2 TON, F-100 RWD		
R 80-84	PICKUP 1/2 TON, F-150 RWD		
R 88-97	PICKUP 1/2 TON, F SUPERDUTY All		
R 80-97	PICKUP 1 TON, F-350 / SUPERDUTY RWD Dual Rear Wheels		
81713	B 140800		
F 85-05	CHEVROLET ASTRO RWD		
F 71-75	BEL AIR Wagon		
F 71-72	BISCAYNE All Police and Taxi Models		
F 73-96	CAPRICE Sedan Police and Taxi Models		
F 71-72	CAPRICE Hardtop Police and Taxi Models		
F 83-85	IMPALA All Police and Taxi Models		
F 71-82	IMPALA Sedan Police and Taxi Models		
F 96-02	VAN 1/2 TON, G / EXPRESS All		
F 96-02	VAN 1 TON, G / EXPRESS All		
F 96-02	VAN 3/4 TON, G / EXPRESS All Exc. 8600# GVW		
F 93-02	FORD CROWN VICTORIA Police Interceptor		
F 85-05	GMC SAFARI RWD		
F 96-02	VAN 1/2 TON, G / SAVANA RWD		
F 96-02	VAN 1 TON, G / SAVANA All		
F 96-02	VAN 3/4 TON, G / SAVANA All Exc. 8600# GVW		
81726	W		
F 99-00	CADILLAC ESCALADE All		
F 90-05	CHEVROLET ASTRO AWD		
F 92-94	BLAZER 4WD Full Size		
F 88-00	PICKUP 1 TON, K35 / K3500 All		
F 88-00	PICKUP 3/4 TON, K25 / K2500 All		
F 92-99	SUBURBAN 1/2 TON, K15 / K1500 All		
F 92-99	SUBURBAN 3/4 TON, K25 / K2500 All		
F 95-00	TAHOE 4WD Old Body Style		
F 88-00	GMC PICKUP 1 TON, K35 / K3500 All		
F 88-00	PICKUP 3/4 TON, K25 / K2500 All		
F 90-05	SAFARI AWD		
F 92-99	SUBURBAN 1/2 TON, K15 / K1500 All		
F 92-99	SUBURBAN 3/4 TON, K25 / K2500 All		
F 92-99	YUKON 4WD		
81730	C		
R 90	FORD BRONCO II All		
R 89	BRONCO II All Mfg. from 2/89; Vehicles w/ 12mm bolt in rear lower mount		
R 90-97	RANGER RWD		
R 89	RANGER RWD Mfg. from 2/89; Vehicles w/ 12mm bolt in rear lower mount		
R 94-97	MAZDA B2300 RWD		
R 94-97	B3000 RWD		
81744	A 140780		
F 90	FORD BRONCO II All		
F 91-94	EXPLORER All		
F 90-97	RANGER All		
F 92-14	VAN 1/2 TON, ECONOLINE / CLUB WAGON All		
F 21-22	VAN 1 TON, ECONOLINE / CLUB WAGON / SUPERDUTY All		
F 92-19	VAN 1 TON, ECONOLINE / CLUB WAGON / SUPERDUTY All		
F 92-14	VAN 3/4 TON, ECONOLINE / CLUB WAGON / SUPERDUTY All		
F 94-97	MAZDA B2300 All		
F 94-97	B3000 All		
F 94-97	B4000 All		
F 91-94	NAVAJO All		

Guardian Shock

Shock	POP	Alternative No.	MTG Acc. Supplied
Pos.	Year	Application	
81750	A 140455		
F 05	CHEVROLET BLAZER Base, RWD		
F 96-04	BLAZER LS , RWD		
F 95-02	BLAZER LT , RWD		
F 95-99	BLAZER Base, RWD		
F 95-97	BLAZER Deluxe , RWD		
F 83-94	BLAZER, S MODELS RWD		
F 68-87	EL CAMINO All		
F 94-03	S10 LS , RWD		
F 82-03	S10 Base, RWD		
F 92-93	S10 EL , RWD		
F 83-92	S10 Tahoe , RWD		
F 88-90	S10 Durango , RWD		
F 82-86	S10 Durango , RWD		
F 72-82	FORD COURIER All		
F 92-04	GMC JIMMY RWD		
F 83-91	S15 JIMMY RWD		
F 04	SONOMA / S15 All RWD		
F 82-03	SONOMA / S15 RWD		
F 78-87	SPRINT / CABALLERO RWD		
F 71-77	SPRINT / CABALLERO All		
F 96-00	ISUZU HOMBRE RWD Exc. Sport Chassis		
F 72-76	MAZDA B1600 All		
F 77-78	B1800 All		
F 79-84	B2000 All		
F 82-84	B2200 All		
F 78-83	TOYOTA PICKUP SR5 , RWD		
F 75-77	PICKUP RWD Mojave		
F 70-74	PICKUP All RWD		
81790	W 142369		
R 95-98	BUICK SKYLARK All		
R 95-96	CHEVROLET BERETTA All		
R 95-96	CORSICA All		
R 95-98	OLDSMOBILE ACHIEVA All Exc. Electronic Adjustable Suspension		
R 95-98	PONTIAC GRAND AM All Exc. Electronic Adjustable Suspension		
81794	D 140126		
R 03-04	FORD MUSTANG / MUSTANG II Mach 1		
R 94-04	MUSTANG / MUSTANG II Base		
R 94-04	MUSTANG / MUSTANG II GT		
R 04	MUSTANG / MUSTANG II GT Base		
R 04	MUSTANG / MUSTANG II GT Equipado		
R 01	MUSTANG / MUSTANG II GT Bullitt		
R 95	MUSTANG / MUSTANG II GTS		
81821	W		
F 97	FORD F-250 HD 4WD		
F 86-97	PICKUP 1 TON, F-350 / SUPERDUTY 4WD		
F 97	PICKUP 3/4 TON, F-250 / SUPERDUTY 4WD Over 8500# GVW		
F 87-96	PICKUP 3/4 TON, F-250 / SUPERDUTY 4WD		
81823	W 140719		
R 91-94	FORD EXPLORER All		
R 91-94	MAZDA NAVAJO All		
81825	W		
F 81-93	DODGE PICKUP 1/2 TON, W100 SERIES All Exc. Lift Kit		
F 61-80	PICKUP 1/2 TON, W100 SERIES All		
F 81-93	PICKUP 1 TON, W300 SERIES All Exc. Quad Suspension and Lift Kit		
F 61-80	PICKUP 1 TON, W300 SERIES All		
F 61-71	PICKUP 1 TON, W300 SERIES All		
F 90-93	PICKUP 3/4 TON, W200 SERIES Extended Cab Pickup Exc. Lift Kit		
F 88-93	PICKUP 3/4 TON, W200 SERIES Cab & Chassis Exc. Lift Kit		
F 81-93	PICKUP 3/4 TON, W200 SERIES Standard Cab Pickup Exc. Lift Kit		
F 86	PICKUP 3/4 TON, W200 SERIES Cab & Chassis Exc. Lift Kit		
F 81-83	PICKUP 3/4 TON, W200 SERIES Cab & Chassis Exc. Lift Kit		
F 81-82	PICKUP 3/4 TON, W200 SERIES Extended Cab Pickup Exc. Lift Kit		
F 69-80	PICKUP 3/4 TON, W200 SERIES All		
F 61-67	PICKUP 3/4 TON, W200 SERIES All		
F 75-93	RAMCHARGER 4WD		
F 74	RAMCHARGER All		
F 78-80	RD200 All		
F 75-81	PLYMOUTH TRAILDUSTER 4WD		
F 74	TRAILDUSTER All		
81828	W 142617		
R 10-14	FORD VAN 1/2 TON, ECONOLINE / CLUB WAGON All		

Numerical listing

Shock	POP	Alternative No.	MTG Acc. Supplied
Pos.	Year	Application	
81828	W (cont) 142617		
R 21-22	VAN 1 TON, ECONOLINE / CLUB WAGON / SUPERDUTY All		
R 10-19	VAN 1 TON, ECONOLINE / CLUB WAGON / SUPERDUTY All		
R 04-19	VAN 1 TON, ECONOLINE / CLUB WAGON / SUPERDUTY All Exc. Cutaway Chassis		
R 92-05	VAN 1 TON, ECONOLINE / CLUB WAGON / SUPERDUTY All		
R 92-14	VAN 3/4 TON, ECONOLINE / CLUB WAGON / SUPERDUTY All		
81833	W 140780		
R 92-07	FORD VAN 1/2 TON, ECONOLINE / CLUB WAGON All		
81834	W 140126		
F 72-93	DODGE PICKUP 1 TON, D300 SERIES All Heavy Duty Package		
F 82-93	PICKUP 3/4 TON, D200 SERIES All Heavy Duty Package		
F 75-81	PICKUP 3/4 TON, D200 SERIES 165.0 / 419.1 (WheelBase) Heavy Duty Package		
F 72-74	PICKUP 3/4 TON, D200 SERIES All Heavy Duty Package		
F 71-93	VAN 1 TON, A / B SERIES / RAM All 4000# Front Axle		
F 74-80	VAN, CB300 All 4000# Front Axle		
F 74-83	PLYMOUTH VAN 1 TON, PB SERIES All 4000# Front Axle		
81836	C 140126		
F 97-04	DODGE DAKOTA 4WD		
F 98-03	DURANGO 4WD		
81837	W		
R 87-96	DODGE DAKOTA 4WD		
81869	C 141353, 142592		
F 99-04	JEEP GRAND CHEROKEE All		
81870	W 141350		
F 86-95	TOYOTA 4RUNNER All		
F 86-95	PICKUP 4WD Exc. Lift Kit		
F 93-98	T100 4WD		
81871	D 140149		
R 84-89	TOYOTA 4RUNNER All		
R 84-95	PICKUP 4WD Exc. Lift Kit		
R 98-04	TACOMA Pre Runner, RWD		
R 95-04	TACOMA 4WD		
81872	W 140524		
F 90-92	DAIHATSU ROCKY All		
F 94-02	HONDA PASSPORT All		
F 98-00	ISUZU AMIGO All		
F 02-04	AXIOM All		
F 91-04	RODEO All		
F 87-90	MITSUBISHI VAN All		
F 87-95	NISSAN PATHFINDER All		
81873	A		
R 99-07	CHEVROLET PICKUP 1/2 TON, SILVERADO 1500 RWD Exc. Electronic Adjustable Suspension		
R 94-01	DODGE PICKUP 1/2 TON, RAM 1500 (SEE RAM 1500) All		
R 94-02	PICKUP 1 TON, RAM 3500 (SEE RAM 3500) RWD Exc. Solid Front Axle		
R 94-03	PICKUP 3/4 TON, RAM 2500 (SEE RAM 2500) All Exc. 8800# GVW		
R 99-07	GMC SIERRA 1500 RWD Exc. Electronic Adjustable Suspension		
81878	B		
R 96-07	CHRYSLER TOWN & COUNTRY All Exc. Hydraulic Self-Leveling System		
R 00-03	VOYAGER / GRAND VOYAGER All Exc. Hydraulic Self-Leveling System		
R 00	VOYAGER / GRAND VOYAGER Non-ABS Exc. Hydraulic Self-Leveling System		
R 96-07	DODGE CARAVAN / GRAND CARAVAN All Exc. Hydraulic Self-Leveling System		
R 96-00	PLYMOUTH VOYAGER / GRAND VOYAGER All Exc. Hydraulic Self-Leveling System		
81880	A		
R 63-82	CHEVROLET CORVETTE All		

Numerical listing

Shock	POP	Alternative No.	MTG Acc. Supplied
Pos.	Year	Application	
81882	W		
R 95-03	FORD WINDSTAR Coil (RearSpringType)		
81890	D		140719
R 95-01	FORD EXPLORER All Exc. Adjustable Suspension		
R 01-05	EXPLORER SPORT TRAC All		
R 97-01	MERCURY MOUNTAINEER All Exc. Electronic Adjustable Suspension		
81891	W		
R 93-98	JEEP GRAND CHEROKEE All		
81892	D		142700
R 00-03	FORD LOBO Harley-Davidson Edition, RWD		
R 00-03	LOBO XLT , RWD		
R 00	LOBO Base , RWD		
R 00	LOBO Lariat , RWD		
R 97-98	LOBO RWD		
R 04	PICKUP 1/2 TON , F-150 RWD		
R 00-03	PICKUP 1/2 TON , F-150 Harley-Davidson Edition, RWD		
R 99-03	PICKUP 1/2 TON , F-150 Lariat, RWD		
R 99-03	PICKUP 1/2 TON , F-150 XL, RWD		
R 99-03	PICKUP 1/2 TON , F-150 XLT, RWD		
R 00	PICKUP 1/2 TON , F-150 Base, RWD		
R 97-98	PICKUP 1/2 TON , F-150 RWD		
R 97-99	PICKUP 3/4 TON , F-250 / SUPERDUTY RWD Up through 8500# GVW		
81893	A		142277
F 95-01	FORD EXPLORER All Exc. Adjustable Suspension		
F 01-05	EXPLORER SPORT TRAC All		
F 98-11	RANGER Torsion Bar (FrontSpringType)		
F 03-07	MAZDA B3000 All 4WD		
F 98-02	B3000 4WD		
F 98-09	B4000 4WD		
F 97-01	MERCURY MOUNTAINEER All Exc. Electronic Adjustable Suspension		
81904	W		141514
R 92-93	ASUNA SUNRUNNER All		
R 98-04	CHEVROLET TRACKER Non-ABS		
R 89-97	GEO TRACKER All		
R 89-91	GMC TRACKER All		
R 94-97	PONTIAC SUNRUNNER All		
R 99-05	SUZUKI GRAND VITARA All		
R 89-98	SIDEKICK Non-ABS		
R 99-04	VITARA Non-ABS		
R 96-98	X-90 All		
81905	W		
R 90-97	FORD RANGER 4WD		
R 89	RANGER 4WD Mfg. from 2/89; Vehicles w/ 12mm bolt in rear lower mount		
R 95-96	MAZDA B2300 4WD		
R 94-97	B3000 4WD		
R 94-97	B4000 4WD		
81910	W		141137
R 98	INFINITI QX4 All Mfg. to 12/98		
R 97	QX4 All		
R 98-99	NISSAN PATHFINDER All Mfg. to 12/98		
R 96-97	PATHFINDER All		
81911	W		140524
R 98-02	HONDA PASSPORT All		
R 98-00	ISUZU AMIGO All		
R 02-04	AXIOM All		
R 98-04	RODEO All		
81912	C		142731
F 97-02	FORD EXPEDITION RWD Exc. Front Air- Leveling		
F 97-03	LOBO RWD		
F 97-04	PICKUP 1/2 TON , F-150 RWD		
F 97-99	PICKUP 3/4 TON , F-250 / SUPERDUTY RWD Up through 8500# GVW		
F 98-02	LINCOLN NAVIGATOR RWD		
81913	W		142700
R 98-03	FORD LOBO 4WD		
R 97-04	PICKUP 1/2 TON , F-150 4WD		

Guardian Shock

Shock	POP	Alternative No.	MTG Acc. Supplied
Pos.	Year	Application	
81913	W (cont)		142700
R 97-99	PICKUP 3/4 TON , F-250 / SUPERDUTY 4WD Up through 8500# GVW		
81914	D		142731
F 97-02	FORD EXPEDITION 4WD Exc. Front Air- Leveling		
F 98-03	LOBO 4WD		
F 04	PICKUP 1/2 TON , F-150 4WD Exc. 7000# GVW		
F 97-03	PICKUP 1/2 TON , F-150 4WD		
F 97-99	PICKUP 3/4 TON , F-250 / SUPERDUTY 4WD Up through 8500# GVW		
81916	A		141665
F 06-11	FORD RANGER RWD, Coil (FrontSpringType)		
F 01-05	RANGER XL , RWD, Coil (FrontSpringType)		
F 01-05	RANGER XLT , RWD, Coil (FrontSpringType)		
F 01-02	RANGER EV , RWD Coil (FrontSpringType)		
F 98-00	RANGER XL , RWD		
F 98-00	RANGER XLT , RWD		
F 01-09	MAZDA B2300 RWD		
F 98-01	B2500 RWD		
F 98-07	B3000 RWD		
F 98-09	B4000 RWD		
81917	B		
R 06-11	FORD RANGER RWD, Coil (FrontSpringType)		
R 98-05	RANGER XL , RWD		
R 98-05	RANGER XLT , RWD		
R 05	RANGER STX , RWD		
R 04	RANGER Tremor , RWD		
R 01	MAZDA B2500 Coil (FrontSpringType)		
R 98-00	B2500 All		
R 03-07	B3000 RWD, Coil (FrontSpringType)		
R 02	B3000 RWD Coil (FrontSpringType)		
R 98-01	B3000 RWD, Coil (FrontSpringType)		
R 01-09	B4000 RWD Coil (FrontSpringType)		
R 98-00	B4000 RWD, Coil (FrontSpringType)		
81918	C		
R 06-11	FORD RANGER RWD, Torsion Bar (FrontSpringType)		
R 98-11	RANGER 4WD		
R 03-07	MAZDA B3000 All 4WD		
R 98-02	B3000 4WD		
R 07-09	B4000 4WD		
R 98-04	B4000 4WD		
81919	D		142731
F 94-01	DODGE PICKUP 1/2 TON , RAM 1500 (SEE RAM 1500) 4WD		
F 99-02	PICKUP 3/4 TON , RAM 2500 (SEE RAM 2500) 4WD Exc. 8800# GVW		
F 94-95	PICKUP 3/4 TON , RAM 2500 (SEE RAM 2500) 4WD Exc. 8800# GVW		
81920	B		141665
F 99-07	CHEVROLET PICKUP 1/2 TON , SILVERADO 1500 RWD Exc. Electronic Adjustable Suspension		
F 99-04	PICKUP 3/4 TON , SILVERADO 2500 RWD Exc. Electronic Adjustable Suspension		
F 01-04	PICKUP 3/4 TON , SILVERADO 2500 HD RWD		
F 99-07	GMC SIERRA 1500 RWD Exc. Electronic Adjustable Suspension		
F 99-04	SIERRA 2500 RWD Exc. Electronic Adjustable Suspension		
F 01-04	SIERRA 2500 HD RWD		
81921	A		
R 07	CHEVROLET PICKUP 1/2 TON , SILVERADO 1500 4WD Old Body Style; Exc. Electronic Adjustable Suspension		
R 99-06	PICKUP 1/2 TON , SILVERADO 1500 4WD Exc. Electronic Adjustable Suspension		
R 05-06	PICKUP 1/2 TON , SILVERADO 1500 HD All		
R 01-03	PICKUP 1/2 TON , SILVERADO 1500 HD All		
R 77-86	PICKUP 1 TON , K30 All		

Numerical listing

Shock	POP	Alternative No.	MTG Acc. Supplied
Pos.	Year	Application	
81921	A (cont)		
R 90-91	PICKUP 1 TON , R3500 All		
R 89	PICKUP 1 TON , R3500 Cab & Chassis, RWD		
R 89	PICKUP 1 TON , R3500 Crew Cab Pickup, RWD		
R 01-09	PICKUP 1 TON , SILVERADO 3500 All		
R 08-10	PICKUP 1 TON , SILVERADO 3500 HD All		
R 87-88	PICKUP 1 TON , V30 All		
R 89-91	PICKUP 1 TON , V3000 / V3500 All		
R 99-08	PICKUP 3/4 TON , SILVERADO 2500 All		
R 01-10	PICKUP 3/4 TON , SILVERADO 2500 HD All		
R 07	SILVERADO 1500 HD CLASSIC All		
R 07	SILVERADO 3500 CLASSIC All		
R 94-02	DODGE PICKUP 1 TON , RAM 3500 (SEE RAM 3500) 4WD		
R 94-02	PICKUP 1 TON , RAM 3500 (SEE RAM 3500) RWD Solid Front Axle		
R 94-02	PICKUP 3/4 TON , RAM 2500 (SEE RAM 2500) 4WD 8800# GVW		
R 77-86	GMC PICKUP 1 TON , K35 / K3500 All		
R 87-91	PICKUP 1 TON , V3000 / V3500 All		
R 07	SIERRA 1500 4WD Old Body Style ; Exc. Electronic Adjustable Suspension		
R 99-06	SIERRA 1500 4WD Exc. Electronic Adjustable Suspension		
R 05-06	SIERRA 1500 HD All		
R 01-03	SIERRA 1500 HD All		
R 07	SIERRA 1500 HD CLASSIC All		
R 99-04	SIERRA 2500 All		
R 01-10	SIERRA 2500 HD All		
R 01-06	SIERRA 3500 All		
R 07-10	SIERRA 3500 HD All		
81922	A		141665
F 02-06	CHEVROLET AVALANCHE 1500 All Exc. Electronic Ride Control		
F 07	PICKUP 1/2 TON , SILVERADO 1500 4WD Old Body Style; Exc. Electronic Adjustable Suspension		
F 99-06	PICKUP 1/2 TON , SILVERADO 1500 4WD Exc. Electronic Adjustable Suspension		
F 00-06	SUBURBAN 1/2 TON , 1500 All Exc. Z55 Auto Ride Suspension		
F 02-06	TAHOE All Exc. Z55 Auto Ride Suspension		
F 00-01	TAHOE All New Body Style; Exc. Z55 Auto Ride Suspension		
F 07	GMC SIERRA 1500 4WD Old Body Style ; Exc. Electronic Adjustable Suspension		
F 99-06	SIERRA 1500 4WD Exc. Electronic Adjustable Suspension		
F 00-06	YUKON All Exc. Z55 Auto Ride Suspension		
F 00-06	YUKON XL 1/2 TON All Exc. Z55 Auto Ride Suspension		
F 00-13	YUKON XL 3/4 TON All Exc. Z55 Auto Ride Suspension		
81923	C		
R 97-04	DODGE DAKOTA All		
R 98-03	DURANGO 4WD		
R 98-03	DURANGO RWD		
81924	W		
R 02-05	CHEVROLET VENTURE All		
R 97-01	VENTURE FWD		
R 02-04	OLDSMOBILE SILHOUETTE AWD		
R 97-04	SILHOUETTE FWD		
R 99-05	PONTIAC MONTANA All Exc. Air-Leveling Suspension		
R 97-98	TRANS SPORT All		
81925	C		141665
F 02-06	CHEVROLET AVALANCHE 2500 All Exc. Electronic Ride Control		
F 05-06	PICKUP 1/2 TON , SILVERADO 1500 HD All		
F 01-03	PICKUP 1/2 TON , SILVERADO 1500 HD All		
F 01-09	PICKUP 1 TON , SILVERADO 3500 All		
F 05-08	PICKUP 3/4 TON , SILVERADO 2500 All		
F 99-04	PICKUP 3/4 TON , SILVERADO 2500 4WD		
F 07	SILVERADO 1500 HD CLASSIC All		
F 12-13	SUBURBAN 3/4 TON , 2500 All		

Numerical listing

Shock	POP	Alternative No.	MTG Acc. Supplied
Pos.	Year	Application	
81925	C (cont)		141665
F	00-11	SUBURBAN 3/4 TON, 2500 All Exc. Z55 Auto Ride Suspension and Quadrasteer	
F	05-06	GMC SIERRA 1500 HD All	
F	01-03	SIERRA 1500 HD All	
F	07	SIERRA 1500 HD CLASSIC All	
F	99-04	SIERRA 2500 4WD	
F	00-06	YUKON XL 3/4 TON All Exc. Hydraulic Self-Leveling System	
81926	C		
R	99-04	JEEP GRAND CHEROKEE All	
81927	W		141727,141354
R	96-05	FORD TAURUS Wagon	
R	96-05	MERCURY SABLE Wagon	
81928	D		143000
F	94-01	DODGE PICKUP 1/2 TON , RAM 1500 (SEE RAM 1500) RWD	
F	94-02	PICKUP 1 TON, RAM 3500 (SEE RAM 3500) RWD Exc. Solid Front Axle	
F	94-02	PICKUP 3/4 TON, RAM 2500 (SEE RAM 2500) RWD	
81929	W		
R	97-06	JEEP WRANGLER TJ (MfrBodyCode)	
81930	A		
R	07-13	CHEVROLET AVALANCHE 1500 All Exc. Z55 or ZW7 Ride Suspension	
R	02-06	AVALANCHE 1500 All Exc. Electronic Ride Control	
R	02-06	AVALANCHE 2500 All Exc. Electronic Ride Control	
R	07-11	SUBURBAN 1/2 TON, 1500 All Exc. Z55 or ZW7 Ride Suspension	
R	00-06	SUBURBAN 1/2 TON, 1500 All Exc. Z55 Auto Ride Suspension	
R	00-11	SUBURBAN 3/4 TON, 2500 All Exc. Z55 Auto Ride Suspension and Quadrasteer	
R	07-11	TAHOE All Exc. Z55 or ZW7 Ride Suspension	
R	02-06	TAHOE All Exc. Z55 Auto Ride Suspension	
R	00-01	TAHOE All New Body Style; Exc. Z55 Auto Ride Suspension	
R	07-11	GMC YUKON All Exc. Z55 or ZW7 Ride Suspension	
R	00-06	YUKON All Exc. Z55 Auto Ride Suspension	
R	07-11	YUKON XL 1/2 TON All Exc. Z55 or ZW7 Ride Suspension	
R	00-06	YUKON XL 1/2 TON All Exc. Z55 Auto Ride Suspension	
R	00-11	YUKON XL 3/4 TON All Exc. Z55 Auto Ride Suspension and Quadrasteer	
81931	C		
R	06-08	DODGE PICKUP 1/2 TON , RAM 1500 (SEE RAM 1500) Crew Cab Pickup, 4WD	
R	06-08	PICKUP 1/2 TON, RAM 1500 (SEE RAM 1500) Standard Cab Pickup, 4WD	
R	02-05	PICKUP 1/2 TON, RAM 1500 (SEE RAM 1500) 4WD	
81932	C		
F	02-05	DODGE PICKUP 1/2 TON , RAM 1500 (SEE RAM 1500) 4WD	
81933	C		
F	06-08	DODGE PICKUP 1/2 TON , RAM 1500 (SEE RAM 1500) Crew Cab Pickup, RWD	
F	06-08	PICKUP 1/2 TON, RAM 1500 (SEE RAM 1500) Standard Cab Pickup, RWD	
F	02-05	PICKUP 1/2 TON, RAM 1500 (SEE RAM 1500) RWD	
81934	W		142155
R	98-10	VOLKSWAGEN BEETLE All	
R	99-06	GOLF A4 (MfrBodyCode)	
R	01-05	JETTA Sedan	
81935	W		142950
R	08-11	FORD FOCUS All	
R	00-07	FOCUS Hatchback	
R	00-07	FOCUS Sedan	

See application pages for full details

Guardian Shock, Classic Shock Absorbers

Shock	POP	Alternative No.	MTG Acc. Supplied
Pos.	Year	Application	
81936	W		
F	97-06	JEEP WRANGLER TJ (MfrBodyCode)	
81937	W		142389
R	94-97	HONDA PASSPORT All	
R	91-97	ISUZU RODEO All	
R	98-03	TOYOTA SIENNA All	
Classic Shock Absorbers			
82001	A		141229
R	67-77	VOLKSWAGEN BEETLE All	
F	66	BEETLE All Exc. 1300 and 1500	
F	52-65	BEETLE All	
R	52-65	BEETLE All	
F	66-73	FASTBACK All	
R	66-73	FASTBACK All	
F	67-74	KARMANN GHIA All	
F	66-73	SQUAREBACK All	
R	66-73	SQUAREBACK All	
F	74-79	SUPER BEETLE All	
R	71-73	SUPER BEETLE All 3 Bolt Flange-Type Lower Mount	
R	73-74	THING All	
F	56-69	TRANSPORTER All	
R	56-67	TRANSPORTER All	
82003	B		
R	69-72	CHEVROLET BLAZER All Coil(RearSpringType)	
R	67-72	PICKUP 1/2 TON, C10 All Coil(RearSpringType)	
R	67-72	PICKUP 3/4 TON, C20 All Coil(RearSpringType)	
R	68-72	SUBURBAN 1/2 TON, C10 All	
R	68-72	SUBURBAN 3/4 TON, C20 All	
R	64-66	VAN 1/2 TON, G / EXPRESS All	
R	67-72	VAN 1/2 TON, P SERIES All	
R	70-72	GMC JIMMY All RWD	
R	67-72	PICKUP 1/2 TON, C15 / C1500 All Coil(RearSpringType)	
R	67-72	PICKUP 3/4 TON, C25 / C2500 All Coil(RearSpringType)	
R	68-72	SUBURBAN 1/2 TON, C15 / C1500 All Coil(RearSpringType)	
R	68-72	SUBURBAN 3/4 TON, C25 / C2500 All	
R	64-66	VAN 1/2 TON, G / SAVANA All	
R	68-72	VAN 1/2 TON, P SERIES All	
82004	W		140918
R	74-80	FORD PINTO Sedan	
R	71-73	PINTO All Sedan	
R	75-80	MERCURY BOBCAT Sedan	
82005	B		141147
F	66-77	VOLKSWAGEN BEETLE All	
F	67-74	KARMANN GHIA All	
F	73-74	THING All	
82007	B		140349
F	47-48	FORD DELUXE All Direct Acting Shocks	
R	61-67	ECONOLINE All	
F	47-48	SUPER DELUXE All Direct Acting Shocks	
F	68	INTERNATIONAL 908C All	
F	68	1100C All	
F	68	1200C All Exc. 166" Wheelbase	
F	68	1300C All Exc. 166" Wheelbase	
F	68-72	M1100 / M1200 All	
F	69	M1400 All	
F	61-71	SCOUT All	
F	61-66	JEEP CJ3 All Exc. 5 Leaf Front Springs & Lift Kit	
F	72-81	CJ5 All Exc. Lift Kit	
F	61-71	CJ5 All Exc. 5 Leaf Front Springs & Lift Kit	
F	72-75	CJ6 All Exc. Lift Kit	
F	66-71	CJ6 All Exc. 5 Leaf Front Springs & Lift Kit	
F	76-81	CJ7 All Exc. Lift Kit	
F	66-74	DJ5 All Exc. Lift Kit	
F	66-68	DJ6 All	
F	57-65	FC150 All	
F	67-71	JEEPSTER All	
R	67-69	JEEPSTER All	
F	81	SCRAMBLER / CJ8 All	
F	61-67	UNIVERSAL All	
F	76-83	TOYOTA LAND CRUISER FJ40 (MfrBodyCode)	
F	75	LAND CRUISER FJ40 (MfrBodyCode) Mfg. to 2/75	
F	67-74	LAND CRUISER All	

Numerical listing

Shock	POP	Alternative No.	MTG Acc. Supplied
Pos.	Year	Application	
82010	B		
F	71-78	CADILLAC ELDORADO All	
F	67-70	ELDORADO All Vertically Mounted	
F	71-78	OLDSMOBILE TORONADO All	
F	66-70	TORONADO All Vertically Mounted	
82011	B		140126
F	65-71	CHRYSLER 300 All	
F	67-73	IMPERIAL All	
F	65-73	NEWPORT All	
F	65-73	NEW YORKER All	
F	65-73	TOWN & COUNTRY All	
F	65	DODGE 880 All	
F	65-73	MONACO All	
F	65-73	POLARA All	
F	65-73	PLYMOUTH FURY All	
F	72-73	GRAN FURY All	
F	67	VIP All	
82012	C		
F	69-74	FORD VAN 1/2 TON , ECONOLINE / CLUB WAGON All	
F	69-74	VAN 1 TON, ECONOLINE / CLUB WAGON / SUPERDUTY All	
F	69-74	VAN 3/4 TON, ECONOLINE / CLUB WAGON / SUPERDUTY All	
82025	D		140873
F	75-80	AMERICAN MOTORS PACER All	
82026	A		140455
F	53	CADILLAC DEVILLE All	
F	50-53	FLEETWOOD / 60 SERIES / 70 SERIES All	
F	50-54	CHEVROLET BEL AIR All	
F	53-62	CORVETTE All	
F	53-54	ONE-FIFTY SERIES All	
F	49-52	STYLELINE DELUXE All	
F	49-52	STYLELINE SPECIAL All	
F	53-54	TWO-TEN SERIES All	
F	50-56	FORD COUNTRY SEDAN All	
F	50-56	COUNTRY SQUIRE All	
F	54-56	COURIER SEDAN DELIVERY All	
F	50-54	CRESTLINE All	
F	50-52	CUSTOM All	
F	52-56	CUSTOMLINE All	
F	49-51	DELUXE All	
F	55-56	FAIRLANE All	
F	49	FORD All	
F	52-56	MAINLINE All	
F	56	PARK LANE WAGON All	
F	50-56	RANCH WAGON All	
F	54-56	SKYLINER All	
F	52-56	SUNLINER All	
F	55-57	THUNDERBIRD All	
F	51-56	VICTORIA All	
F	52-56	MERCURY CUSTOM All	
F	56	MEDALIST All	
F	49-51	MERCURY All	
F	55-56	MONTCLAIR All	
F	50-56	MONTEREY All	
F	55	OLDSMOBILE 98 All	
F	57	PONTIAC BONNEVILLE All	
F	50-57	CATALINA All	
F	49-57	CHIEFTAIN All	
F	54-57	STAR CHIEF All	
F	49-52	STREAMLINER All	
F	57	SUPER CHIEF All	
F	56	STUDEBAKER POWER HAWK All	
F	55-56	PRESIDENT All	
F	56	SKY HAWK All	
F	59-68	VOLVO 122 All	
F	61-73	1800 All	
82032	W		
R	68-79	VOLKSWAGEN TRANSPORTER All	
82034	C		141138
R	55-56	CADILLAC DEVILLE All	
R	67	ELDORADO All Vertically Mounted	
R	55-56	FLEETWOOD / 60 SERIES / 70 SERIES All	
F	73-78	FORD PICKUP 3/4 TON , F-250 / SUPERDUTY 4WD Up through Serial No. Y20000	
F	66-72	PICKUP 3/4 TON, F-250 / SUPERDUTY All 4WD; Up through Serial No. Y2000	
F	61-65	PICKUP 3/4 TON, F-250 / SUPERDUTY All 4WD	
R	67-70	OLDSMOBILE TORONADO All Vertically Mounted	
82035	C		140357
F	60	CHEVROLET PICKUP All	

Page 309

Numerical listing

Shock	POP	Alternative No.	MTG Acc. Supplied
Pos.	Year	Application	
82035	C (cont)		140357
F	60-62	PICKUP 1/2 TON, C10 All	
F	61-62	PICKUP 1 TON, C30 All	
F	60-62	PICKUP 3/4 TON, C20 All	
F	61-62	SUBURBAN 1/2 TON, 1500 All	
F	61-62	VAN 1/2 TON, P SERIES All	
F	61-62	GMC PICKUP 1000 SERIES All	
F	61-62	PICKUP 1500 SERIES All	
F	61-62	PICKUP 2500 SERIES All	
82039	D		140455
R	53-59	CHEVROLET CORVETTE All	
R	61-71	INTERNATIONAL SCOUT All	
R	69-73	OPEL OPEL All	
82040	B		140455
R	68-70	CADILLAC ELDORADO All Vertically Mounted; Single Leaf Rear Springs	
R	67-69	CHEVROLET CAMARO All Single Leaf Rear Springs	
R	66	OLDSMOBILE TORONADO All Vertically Mounted; Single Leaf Rear Springs	
R	67	PONTIAC FIREBIRD All Single Leaf Rear Springs	
82047	B		140630
F	57-58	CHEVROLET PICKUP All	
F	61-67	VAN 1 TON, P SERIES All	
F	61-67	VAN 3/4 TON, P SERIES All	
F	55-59	GMC PICKUP All	
F	67	VAN 1 TON, P SERIES All	
F	67	VAN 3/4 TON, P SERIES All	
82051	D		
R	70	AMERICAN MOTORS GREMLIN All	
R	70	HORNET All	
R	58-64	CHEVROLET BEL AIR All	
R	58-64	BISCAYNE All	
R	58	DEL RAY All	
R	59-60	EL CAMINO All	
R	59-64	IMPALA All	
82060	A		140630
R	65-68	CADILLAC CALAIS All	
R	65-68	DEVILLE All	
R	65-68	FLEETWOOD All	
R	50-51	FLEETWOOD / 60 SERIES / 70 SERIES All	
R	57-58	CHEVROLET PICKUP Truck, 3200	
R	57-58	PICKUP Truck, 3600	
R	50-51	FORD COUNTRY SQUIRE All	
R	49	FORD All	
R	50-51	RANCH WAGON All	
R	55-59	GMC PICKUP All Series 100, 150	
R	56	STUDEBAKER POWER HAWK All	
R	55-56	PRESIDENT All	
R	56	SKY HAWK All	
82065	C		140478
R	74	DODGE M300 All	
R	74	M350 All	
F	60	PICKUP 1/2 TON, D100 SERIES All	
F	60	PICKUP 1/2 TON, W100 SERIES All	
R	61-71	PICKUP 1 TON, D300 SERIES All	
F	60	PICKUP 3/4 TON, D200 SERIES All	
F	60	PICKUP 3/4 TON, W200 SERIES All	
F	53-60	TRUCK All	
R	53-58	TRUCK All	
R	64-70	VAN 1/2 TON, A / B SERIES / RAM Van	
R	66-72	VAN 1 TON, P SERIES All	
R	61-64	VAN 1 TON, P SERIES All	
82066	B		140455
R	60-66	AMERICAN MOTORS AMBASSADOR All	
R	61-66	CLASSIC All	
R	65-66	MARLIN All	
R	53-54	CADILLAC DEVILLE All	
R	52-54	FLEETWOOD / 60 SERIES / 70 SERIES All	
R	55-57	CHEVROLET BEL AIR All	
R	55-57	ONE-FIFTY SERIES All	
R	50-53	PICKUP Truck, 3100	
R	50-53	PICKUP Truck, 3600	
R	50-53	PICKUP Truck, 3800	
R	55-57	TWO-TEN SERIES All	
R	87-88	ISUZU TROOPER 4WD	
82069	C		140435
F	64-68	AMERICAN MOTORS AMERICAN All	
F	68-69	AMX All	

Classic Shock Absorbers

Shock	POP	Alternative No.	MTG Acc. Supplied
Pos.	Year	Application	
82069	C (cont)		140435
F	68-69	JAVELIN All	
F	69	RAMBLER All	
R	62-63	MERCEDES-BENZ 190SL All	
82070	W		140494
F	62-67	CHEVROLET CHEVY II All	
82072	A		140126
F	57-64	CHRYSLER 300 All	
F	57-66	IMPERIAL All	
F	57-64	NEWPORT All	
F	57-64	NEW YORKER All	
F	57-60	SARATOGA All	
F	57-64	TOWN & COUNTRY All	
F	57-61	WINDSOR All	
F	62-64	DODGE 880 All	
F	57-59	CORONET All	
F	57-61	CUSTOM All	
F	60-61	DART All	
F	60-61	POLARA All	
F	57-61	PLYMOUTH BELVEDERE All	
F	58-61	CUSTOM All	
F	60-61	FLEET SPECIAL All	
F	57-61	FURY All	
F	57-58	PLAZA All	
F	57-61	SAVOY All	
F	60-61	SPORT WAGON All	
F	57-61	SUBURBAN All	
82075	B		140689
F	62-65	FORD FAIRLANE All	
F	62-63	MERCURY METEOR All	
82076	C		140524
R	58-59	EDSEL CORSAIR All	
R	58-60	RANGER All	
R	58-60	VILLAGER All	
R	60-64	FORD COUNTRY SEDAN All	
R	59-64	COUNTRY SQUIRE All	
R	59-60	COURIER SEDAN DELIVERY All	
R	64-66	CUSTOM All	
R	60	CUSTOM 300 All	
R	60-61	FAIRLANE All	
R	60-64	GALAXIE All	
R	59	RANCHERO All	
R	59-64	RANCH WAGON All	
R	59	SKYLARK All	
R	60	STARLINER All	
R	60	SUNLINER All	
R	60	VICTORIA All	
R	61-64	MERCURY COLONY PARK All	
R	64	COMMUTER All	
R	61-62	COMMUTER All	
R	63	COUNTRY CRUISER All	
R	63-64	MARAUDER All	
R	64	MONTCLAIR All	
R	61-64	MONTEREY All	
R	64	PARKLANE All	
R	62-64	VILLAGER All	
82079	B		
F	57-64	OLDSMOBILE 88 SERIES All	
F	58-64	98 All	
F	58-64	DYNAMIC 88 All	
F	57-63	FIESTA All	
F	62-63	JETFIRE All	
F	61-64	STARFIRE All	
F	57	STARFIRE All	
82086	B		
R	60	CHEVROLET PICKUP All	
R	60-62	PICKUP 1/2 TON, C10 All	
R	60-62	PICKUP 3/4 TON, C20 All	
R	61-62	SUBURBAN 1/2 TON, 1500 All	
R	61-62	VAN 1/2 TON, P SERIES All	
R	61-62	GMC PICKUP 1000 SERIES All	
R	61-62	PICKUP 1500 SERIES All	
82087	A		140455
F	56	BUICK CENTURY All	
F	61-64	ELECTRA All	
F	61-63	INVICTA All	
F	61-64	LESABRE All	
F	63-65	RIVIERA All	
F	56	ROADMASTER All Exc. Air Suspension	
F	56	SPECIAL All	
F	56	SUPER All Exc. Air Suspension	
F	63-64	WILDCAT All	
F	63-64	STUDEBAKER AVANTI All	
F	57-58	CHAMPION All	
F	57-58	COMMANDER All	
F	57-58	GOLDEN HAWK All	
F	60-62	HAWK All	
F	59-62	LARK All	

Numerical listing

Shock	POP	Alternative No.	MTG Acc. Supplied
Pos.	Year	Application	
82087	A (cont)		140455
F	57-58	PRESIDENT All	
F	57-59	SILVER HAWK All	
82090	A		140126
F	63-64	DODGE 330 All	
F	63-64	440 All	
F	70-74	CHALLENGER All	
F	66-72	CHARGER All	
F	65-72	CORONET All	
F	62-76	DART All	
F	61-62	LANCER All	
F	62-64	POLARA All	
F	64-74	PLYMOUTH BARRACUDA All	
F	62-70	BELVEDERE All	
F	70-76	DUSTER All	
F	62-63	FLEET SPECIAL All	
F	62-64	FURY All	
F	67-70	GTX All	
F	68-72	ROAD RUNNER All	
F	65-72	SATELLITE All	
F	62-64	SAVOY All	
F	71-76	SCAMP All	
F	70	SUPERBIRD All	
F	60-76	VALIANT All	
82093	D		
R	74-75	BUICK APOLLO All	
R	73	APOLLO All Exc. Heavy Duty Suspension	
R	75-79	SKYLARK All	
R	76-79	CADILLAC SEVILLE All	
R	68	CHEVROLET CHEVY II All Single Leaf Rear Springs	
R	73-79	NOVA All	
R	69-72	NOVA All Single Leaf Rear Springs	
R	74-79	OLDSMOBILE OMEGA All	
R	73	OMEGA All Exc. Heavy Duty Suspension	
R	77-79	PONTIAC PHOENIX All	
R	73-77	VENTURA All	
R	71-72	VENTURA All Single Leaf Rear Springs	
82099	A		140877
F	58-60	CADILLAC DEVILLE All	
F	56	DEVILLE All	
F	56-60	FLEETWOOD / 60 SERIES / 70 SERIES All	
F	55-57	CHEVROLET BEL AIR All	
F	60-64	CORVAIR All	
F	61-64	CORVAIR TRUCK All	
F	55-57	ONE-FIFTY SERIES All	
F	55-57	TWO-TEN SERIES All	
F	58	EDSEL BERMUDA All	
F	58	CITATION All	
F	58-59	CORSAIR All	
F	58	PACER All	
F	58-60	RANGER All	
F	58	ROUNDUP All	
F	58-60	VILLAGER All	
F	57-64	FORD COUNTRY SEDAN All	
F	57-64	COUNTRY SQUIRE All	
F	57-60	COURIER SEDAN DELIVERY All	
F	64-66	CUSTOM All	
F	57	CUSTOM All	
F	58-60	CUSTOM 300 All	
F	57-58	DEL RIO WAGON All	
F	57-61	FAIRLANE All	
F	59-64	GALAXIE All	
F	59	RANCHERO All	
F	57-64	RANCH WAGON All	
F	57-59	SKYLARK All	
F	60	STARLINER All	
F	57-60	SUNLINER All	
F	59-60	THUNDERBIRD All	
F	57-60	VICTORIA All	
F	57-64	MERCURY COLONY PARK All	
F	64	COMMUTER All	
F	57-62	COMMUTER All	
F	63	COUNTRY CRUISER All	
F	59-60	COUNTRY CRUISER All	
F	63-64	MARAUDER All	
F	58	MEDALIST All	
F	64	MONTCLAIR All	
F	57-60	MONTCLAIR All	
F	57-64	MONTEREY All	
F	64	PARKLANE All	
F	58-60	PARKLANE All	
F	57	TURNPIKE CRUISER All	
F	62-64	VILLAGER All	
F	57-59	VOYAGER All	
F	58-64	PONTIAC BONNEVILLE All	
F	58-64	CATALINA All	
F	58	CHIEFTAIN All	

Numerical listing

Shock	POP	Alternative No.	MTG Acc. Supplied
Pos.	Year	Application	
82099	A (cont)		140877
F	62-64	GRAND PRIX All	
F	58-64	STAR CHIEF All	
F	58	SUPER CHIEF All	
F	60-61	VENTURA All	
F	67	TOYOTA CROWN All Mfg. to 9/67	
F	65-66	CROWN All	
82103	C		140455
R	63-64	STUDEBAKER AVANTI All	
82104	D		140496
F	65-66	FORD MUSTANG / MUSTANG II All	
82109	A		140455
F	61-64	CADILLAC DEVILLE All	
F	61-64	FLEETWOOD / 60 SERIES / 70 SERIES All	
82110	W		140455
F	65-70	OLDSMOBILE 88 SERIES All	
F	65-70	98 All	
F	67	CUTLASS / CUTLASS SUPREME Turnpike Cruiser	
F	65-66	DYNAMIC 88 All	
F	65-66	STARFIRE All	
F	65-70	PONTIAC BONNEVILLE All	
F	65-70	CATALINA All	
F	67-70	EXECUTIVE All	
F	65-68	GRAND PRIX All	
F	65-66	STAR CHIEF All	
82118	C		141983
F	58-64	CHEVROLET BEL AIR All	
F	58-64	BISCAYNE All	
F	58	DEL RAY All	
F	59-60	EL CAMINO All	
F	59-64	IMPALA All	
82125	A		140523
R	78-80	AMERICAN MOTORS AMX All	
R	78-83	CONCORD All	
R	71-78	GREMLIN All	
R	71-77	HORNET All	
R	79-83	SPIRIT All	
R	75-76	CADILLAC COMMERCIAL CHASSIS All	
R	58-64	DEVILLE All	
R	57-64	FLEETWOOD / 60 SERIES / 70 SERIES All	
R	52-59	FORD COUNTRY SEDAN All	
R	52-56	COUNTRY SQUIRE All	
R	72-82	COURIER All	
R	54-56	COURIER SEDAN DELIVERY All	
R	52-54	CRESTLINE All	
R	57	CUSTOM All	
R	52	CUSTOM All	
R	58	CUSTOM 300 All	
R	52-56	CUSTOMLINE All	
R	72-76	MAZDA B1600 All	
R	77-78	B1800 All	
R	79-84	B2000 All	
R	82-84	B2200 All	
R	52-56	MERCURY CUSTOM All	
R	56	MEDALIST All	
R	49-51	MERCURY All	
R	55-56	MONTCLAIR All	
R	50-56	MONTEREY All	
R	76-78	NISSAN F10 Wagon	
R	59-66	PEUGEOT 403 All	
R	61-67	404 All	
82126	C		141164
F	70-74	AMERICAN MOTORS AMBASSADOR All	
F	78-80	AMX All	
F	70	AMX All	
F	78-83	CONCORD All	
F	70-78	GREMLIN All	
F	70-77	HORNET All	
F	70-74	JAVELIN All	
F	71-78	MATADOR All	
F	79-83	SPIRIT All	
F	66-70	FORD FAIRLANE All	
F	60-70	FALCON All	
F	60-71	RANCHERO All	
F	65-74	RANCH WAGON All	
F	68-71	TORINO All	
F	60-69	MERCURY COMET All	
F	68-71	CYCLONE All	
F	68-71	MONTEGO All	
82128	D		140873
F	74-77	FORD MUSTANG / MUSTANG II All	
F	74-80	PINTO Sedan	
F	71-73	PINTO All Sedan	

Classic Shock Absorbers

Shock	POP	Alternative No.	MTG Acc. Supplied
Pos.	Year	Application	
82128	D (cont)		140873
F	75-80	MERCURY BOBCAT All	
82130	W		141132
R	75-80	FORD GRANADA All	
R	70-77	MAVERICK All	
R	77-80	LINCOLN VERSAILLES All	
R	71-77	MERCURY COMET All	
R	75-80	MONARCH All	
R	66-70	NISSAN 1600 All	
R	68-70	2000 All	
82131	A		
R	65-69	CHRYSLER 300 All	
R	75-76	CORDOBA All	
R	74-75	IMPERIAL All	
R	74-78	NEWPORT All	
R	65-69	NEWPORT All	
R	74-78	NEW YORKER All	
R	65-69	NEW YORKER All	
R	74-78	TOWN & COUNTRY All	
R	65-70	TOWN & COUNTRY All	
R	63-64	DODGE 330 All	
R	63-64	440 All	
R	65	880 All	
R	70-74	CHALLENGER All	
R	66-76	CHARGER All	
R	65-76	CORONET All	
R	62	DART All	
R	72-78	MONACO All	
R	65-70	MONACO All	
R	73	POLARA All Exc. Wagon	
R	72	POLARA All	
R	62-70	POLARA All	
R	75-77	ROYAL MONACO All	
R	70-74	PLYMOUTH BARRACUDA All	
R	62-70	BELVEDERE All	
R	62-63	FLEET SPECIAL All	
R	77-78	FURY All Police Package	
R	73-76	FURY All	
R	73	FURY Wagon	
R	62-69	FURY All	
R	74-77	GRAN FURY All	
R	73	GRAN FURY Wagon Wagon	
R	67-71	GTX All	
R	68-75	ROAD RUNNER All	
R	65-74	SATELLITE All	
R	62-64	SAVOY All	
R	70	SUPERBIRD All	
R	67	VIP All	
82138	B		140455
F	65-67	BUICK GRAN SPORT All	
F	64-67	SKYLARK All Heavy Duty Suspension	
F	64-67	SPECIAL All Heavy Duty Suspension	
F	64-67	SPORTWAGON All	
F	64-67	CHEVROLET CHEVELLE All	
F	64-67	EL CAMINO All	
F	64-67	MALIBU All	
F	64-67	OLDSMOBILE CUTLASS / CUTLASS SUPREME Base	
F	64-67	CUTLASS / CUTLASS SUPREME Holiday	
F	61-67	F85 All	
F	64-67	PONTIAC GTO All	
F	64-67	LEMANS All	
F	64-67	TEMPEST All	
82147	W		
R	65-69	FORD PICKUP 1/2 TON, F-100 All 4WD: Exc. Lift Kit	
R	75-77	PICKUP 3/4 TON, F-250 / SUPERDUTY 4WD Up through Serial No. Y20000	
R	66-74	PICKUP 3/4 TON, F-250 / SUPERDUTY All 4WD; Up through Serial No. Y2000	
82151	C		
R	57-58	STUDEBAKER CHAMPION All	
R	57-58	COMMANDER All	
R	57-58	GOLDEN HAWK All	
R	60-62	HAWK All	
R	59-62	LARK All	
R	57-58	PRESIDENT All	
R	57-59	SILVER HAWK All	
82155	A		141041
R	67-69	AMERICAN MOTORS AMBASSADOR All	
R	59-68	AMERICAN All	
R	68-69	AMX All	
R	68-69	JAVELIN All	
R	67	MARLIN All	

Numerical listing

Shock	POP	Alternative No.	MTG Acc. Supplied
Pos.	Year	Application	
82155	A (cont)		141041
R	69	RAMBLER All	
R	59-60	RAMBLER All	
R	59-60	BUICK ELECTRA All Exc. Air Suspension	
R	59-60	INVICTA All Exc. Air Suspension	
R	60	LESABRE All	
R	59	LESABRE All Exc. Air Suspension	
R	51-54	CHEVROLET BEL AIR All	
R	50	BEL AIR All Exc. Air Suspension	
R	60-62	CORVETTE All	
R	53-54	ONE-FIFTY SERIES All	
R	55-58	PICKUP 3800	
R	54	PICKUP All	
R	49-52	STYLELINE DELUXE All	
R	49-52	STYLELINE SPECIAL All	
R	53-54	TWO-TEN SERIES All	
R	61-62	VAN 1 TON, P SERIES All	
R	61-62	VAN 3/4 TON, P SERIES All	
R	66-67	FIAT 1100 All Exc. Wagon	
R	64-67	1500 All Exc. Wagon	
R	53-54	GMC PICKUP All 1/2 and 3/4 Ton	
R	64-65	NISSAN 410 All	
R	64-67	411 All	
R	74-76	TOYOTA CORONA Hardtop	
R	74-76	CORONA Sedan	
R	73	CORONA Base, Hardtop Mfg. to 6/73	
R	73	CORONA Base, Sedan Mfg. to 6/73	
R	68-72	CORONA Base, Hardtop	
R	68-72	CORONA Base, Sedan	
82156	B		
R	57-58	BUICK CENTURY All	
R	58	LIMITED All	
R	57-58	ROADMASTER All Exc. Air Suspension	
R	57-58	SPECIAL All Exc. Air Suspension	
R	57-58	SUPER All Exc. Air Suspension	
R	75-80	DODGE COLT Wagon	
R	71-74	COLT All	
R	75-76	FIAT 124 All Wagon	
R	67-74	124 Wagon Wagon	
R	66-67	1100 All Wagon	
R	64-67	1500 All Wagon	
R	50-51	FORD COUNTRY SEDAN All	
R	50-51	CRESTLINE All	
R	50-51	CUSTOM All	
R	49-51	DELUXE All	
R	47-48	DELUXE All Direct Acting Shocks	
R	47-48	SUPER DELUXE All Direct Acting Shocks	
R	51	VICTORIA All	
R	78-81	NISSAN 510 Wagon	
R	83-84	MAXIMA Wagon	
R	51-56	OLDSMOBILE 98 All	
R	76-80	PLYMOUTH COLT All	
R	57-60	PONTIAC BONNEVILLE All	
R	50-60	CATALINA All	
R	49-58	CHIEFTAIN All	
R	54-60	STAR CHIEF All	
R	49-52	STREAMLINER All	
R	57-58	SUPER CHIEF All	
R	60	VENTURA All	
R	74-78	TOYOTA CORONA Wagon	
R	73	CORONA Wagon Mfg. from 8/73	
R	71	CORONA Mark II, Wagon Exc. Wagon	
R	69-70	CORONA Mark II, Wagon	
R	65-66	CROWN Wagon Wagon	
82601	A		140455
F	65-70	BUICK ELECTRA All	
F	70	ESTATE WAGON All	
F	65-70	LESABRE All	
F	66-70	RIVIERA All	
F	65-70	WILDCAT All	
F	65-76	CADILLAC CALAIS All	
F	75-76	COMMERCIAL CHASSIS All	
F	65-76	DEVILLE All	
F	65-76	FLEETWOOD All	
82602	D		140629
R	65-70	BUICK ELECTRA All	
R	65-70	LESABRE All	
R	65-70	WILDCAT All	
R	71-76	CADILLAC CALAIS All	
R	71-76	DEVILLE All	
R	71-76	FLEETWOOD All	
82609	D		
R	61-64	BUICK ELECTRA All	
R	61-63	INVICTA All	
R	61-64	LESABRE All	
R	63-65	RIVIERA All	
R	63-64	WILDCAT All	

Numerical listing

Shock	POP	Alternative No.	MTG Acc. Supplied
Pos.	Year	Application	
82615	W		
F	61-69	LINCOLN CONTINENTAL All	
82618	C		140629
R	66-70	BUICK RIVIERA All	

Suspension Mounts

142091	W		
F	73-79	AUDI FOX All	
F	85-93	VOLKSWAGEN CABRIOLET All	
F	80-84	JETTA All	
F	75-84	RABBIT All	
F	75-89	SCIROCOCO All	

142134	W		
F	85-88	CHEVROLET NOVA All	
F	83-86	TOYOTA CAMRY All	
F	88	COROLLA FX	
F	88	COROLLA FX16	
F	87	COROLLA All	

142135	B		
R	91-98	BMW 318i All	
R	84-85	318i All	
R	91-98	318iS All	
R	95-99	318Ti All	
R	98-99	323i All	
R	87-88	325 All	
R	84-87	325E All	
R	87-95	325i All	
R	87-92	325iS All	
R	88-91	325iX All	
R	96-98	328i All	
R	88-91	M3 All	

142144	W		
F	88-96	BUICK REGAL All Exc. Heavy Duty Suspension	
F	90-01	CHEVROLET LUMINA All Exc. Heavy Duty Suspension	
F	95-99	MONTE CARLO All	
F	88-97	OLDSMOBILE CUTLASS / CUTLASS SUPREME All Exc. Heavy Duty Suspension	
F	90-96	PONTIAC GRAND PRIX All Exc. Heavy Duty Suspension	

142173	W		
R	83-87	DODGE CHARGER All	
R	78-90	OMNI All	
R	87-89	PLYMOUTH EXPO All	
R	78-90	HORIZON All	
R	85	TURISMO All	
R	83	TURISMO All	

142183	W		
F	86-89	MAZDA 323 All Exc. Electronic Adjustable Suspension	
F	81-85	GLC Hatchback	
F	81-85	GLC Sedan	
F	87-89	MERCURY TRACER FWD	

142195	W		
F	88-92	AUDI 80 All	
F	88-92	80 QUATTRO All	
F	93-95	90 All	
F	88-91	90 All	
F	93-95	90 QUATTRO All	
F	88-91	90 QUATTRO All	
F	80-87	4000 All	
F	84-87	4000 QUATTRO All	
F	83-87	COUPE All	
F	90-91	COUPE QUATTRO All	
F	82-88	VOLKSWAGEN QUANTUM All	

142196	W		
R	89-92	FORD PROBE All	
R	88-92	MAZDA 626 All Exc. Electronic Adjustable Suspension or 4 Wheel Steer	
R	88-92	MX6 All Exc. Electronic Adjustable Suspension or 4 Wheel Steer	

142219	W		
F	89-90	DODGE 2000 GTX All Exc. Auto-Leveling System	
F	90-94	EAGLE TALON All	
F	90-94	MINIBUS ECLIPSE All	
F	90-94	PLYMOUTH LASER All	

142224	W		
F	92-94	BUICK SKYLARK All Exc. FE3 and Electronic Ride Control	
F	92-94	CHEVROLET BERETTA All	
F	94	CORSICA Base	
F	92-93	CORSICA All	

Classic Shock Absorbers, Suspension Mounts

Shock	POP	Alternative No.	MTG Acc. Supplied
Pos.	Year	Application	
142224	W (cont)		
F	92-94	OLDSMOBILE ACHIEVA All Exc. FE3 and Electronic Ride Control	
F	92-94	PONTIAC GRAND AM All Exc. Electronic Adjustable Suspension	

142227	W		
F	85-90	BUICK ELECTRA All	
F	86-90	LESABRE All	
F	91-96	PARK AVENUE All	
F	92-98	SKYLARK All Exc. FE3 and Electronic Ride Control	
F	93	CADILLAC 60 SPECIAL All	
F	87-93	ALLANTE All	
F	92-93	COMMERCIAL CHASSIS FWD	
F	85-91	COMMERCIAL CHASSIS All	
F	85-93	DEVILLE All	
F	91-02	ELDORADO All	
F	85-93	FLEETWOOD All	
F	87-97	SEVILLE All	
F	92-96	CHEVROLET BERETTA All	
F	95-98	CAVALIER All	
F	92-96	CORSICA All	
F	86-96	OLDSMOBILE 88 SERIES All	
F	91-96	98 All Exc. Soft Ride Susp (FE1) and Elec. Ride & Handling (FW1)	
F	85-90	98 All	
F	92-98	ACHIEVA All Exc. Electronic Adjustable Suspension	
F	95-96	AURORA All	
F	90-92	TONONADO All	
F	87-96	PONTIAC BONNEVILLE All	
F	95-98	GRAND AM All Exc. Electronic Adjustable Suspension	
F	92-94	GRAND AM SE All Exc. FE3 and Electronic Ride Control	
F	95-98	SUNFIRE All	

142230	B		
F	01-03	ACURA CL All	
F	97-99	CL All	
F	97-03	EL All	
F	90-01	INTEGRA All	
F	90-93	INTEGRA All	
F	86-90	LEGEND All Auto-Leveling System	
R	02-06	RSX All	
F	95-14	TL All	
R	99-12	TL All	
F	92-94	VIGOR All	
R	98-12	HONDA ACCORD All	
F	86-12	ACCORD All	
R	88-05	CIVIC All	
F	88-00	CIVIC All	
F	93-97	CIVIC DEL SOL All	
R	93-97	CIVIC DEL SOL All	
R	03-12	CR-V All	
F	97-01	CR-V All	
R	97-01	CR-V All	
F	88-91	CRX All	
R	88-91	CRX All	
R	03-11	ELEMENT All	
F	95-98	ODYSSEY All	
R	95-98	ODYSSEY All	
F	83-01	PRELUDE All	
R	06-14	RIDGELINE All	
R	00-09	S2000 All	
F	00-07	S2000 All	
F	96-99	ISUZU OASIS All	
R	96-99	OASIS All	

142240	W		
F	92	DODGE COLT All	
F	89-91	COLT Hatchback	
F	91-92	EAGLE SUMMIT Sedan	
F	89-90	SUMMIT All	
F	92-95	HYUNDAI ELANTRA Non-ABS	
F	89-92	MINIBUS MITSUBISHI MIRAGE All	
F	85-86	MIRAGE All	
F	90-91	PLYMOUTH COLT Hatchback, FWD	
F	89	COLT Hatchback	

142241	W		
F	70-73	NISSAN 240Z All	
F	74	260Z All Mfg. 9/74	
F	75-78	280Z All	
F	79-83	280ZX All	
F	84-89	300ZX All	
F	73-76	610 All	
F	77-81	810 All	
F	90-94	AXXESS All	
F	89-94	MAXIMA All Exc. Electronic Adjustable Suspension	
F	82-84	MAXIMA All Exc. Electronic Adjustable Suspension	
F	83-85	PULSAR / PULSAR NX All	

Numerical listing

Shock	POP	Alternative No.	MTG Acc. Supplied
Pos.	Year	Application	
142241	W (cont)		
F	93-02	QUEST All	
142244	W		
F	91-02	SATURN SC / SL / SW SERIES All	

142245	W		
R	91-02	SATURN SC / SL / SW SERIES All	
142247	W		
F	83-88	TOYOTA TERCEL Wagon	

142248	W		
F	87-90	TOYOTA TERCEL Hatchback	
F	87-90	TERCEL Sedan	

142249	W		
R	85-88	CHEVROLET NOVA All	
R	88-89	TOYOTA CELICA GT	
R	88-89	CELICA GTS	
R	88-89	CELICA ST	
R	86-87	CELICA All	
R	84-87	COROLLA All	
R	87	TERCEL Wagon	
R	83-86	TERCEL All	

142250	W		
R	90-91	LEXUS ES250 All	
R	87-91	TOYOTA CAMRY FWD	

142251	W		
F	73-79	VOLKSWAGEN SUPER BEETLE All	

142252	W		
R	85-93	VOLKSWAGEN CABRIOLET All	
R	90-92	CORRADO All	
R	85-98	GOLF All	
R	80-98	JETTA All	
R	75-84	RABBIT All	
R	75-89	SCIROCOCO All	

142300	W		
R	90-93	ACURA INTEGRA All	
R	98-02	HONDA ACCORD All	
R	89-95	CIVIC All	
R	93-97	CIVIC DEL SOL All	

142316	W		
F	88-94	CHEVROLET BLAZER, S MODELS 4WD, Torsion Bar (FrontSpringType)	
F	88-04	S10 4WD, Torsion Bar (FrontSpringType)	
F	05	GMC JIMMY 4WD	
F	92-04	JIMMY All	
F	83-91	S15 JIMMY All	
F	88-94	SONOMA / S15 4WD, Torsion Bar (FrontSpringType)	
F	91	SYCLONE Torsion Bar (FrontSpringType)	
F	92-93	TYPHOON All	
F	91-94	OLDSMOBILE BRAVADA Torsion Bar (FrontSpringType)	

142317	W		
F	93	ASUNA SUNFIRE (CANADIAN VEHICLE) All Exc. Lotus Suspension	
F	90-93	GEO STORM Non-ABS	
F	90-92	ISUZU IMPULSE All Exc. Lotus Suspension	
F	91-93	STYLUS All Exc. Lotus Suspension	

142329	W		
F	93-95	DODGE COLT All	
F	93-96	EAGLE SUMMIT Coupe	
F	93-96	SUMMIT Sedan	
F	96	MINIBUS MITSUBISHI MIRAGE All Mfg. to 5/96	
F	95	MIRAGE Sedan	
F	93-94	MIRAGE All	
F	93-94	PLYMOUTH COLT Sedan	

142330	W		
F	98-02	SUBARU FORESTER All	
F	93-01	IMPREZA Non-ABS	
F	90-04	LEGACY All	

142402	W		
R	95-00	FORD CONTOUR All	
R	99-00	MERCURY COUGAR All	
R	95-00	MYSTIQUE All	

142403	W		
R	93-97	FORD PROBE All Left	
R	93-97	MAZDA 626 All Left	
R	93-97	MX6 All Left	

Numerical listing

Shock	POP	Alternative No.	MTG Acc. Supplied
Pos.	Year	Application	
142404 W			
R	93-97	FORD PROBE All Right	
R	93-97	MAZDA 626 All Right	
R	93-97	MX6 All Right	
142419 B			
R	01-05	CHRYSLER SEBRING ST (MfrBodyCode), Coupe	
F	96-00	SEBRING Coupe	
R	96-00	SEBRING Coupe	
F	95	SEBRING All	
R	95	SEBRING All	
R	89-90	DODGE 2000 GTX All Exc. Auto-Leveling System	
F	95-00	AVENGER All	
R	95-00	AVENGER All	
R	92-95	COLT All	
R	89-91	COLT Hatchback	
R	91-96	STEALTH All	
R	01-05	STRATUS ST (MfrBodyCode), Coupe	
R	91-93	EAGLE 2000 GTX All	
R	93-96	SUMMIT All	
R	89-92	SUMMIT Sedan	
R	92	SUMMIT Wagon	
F	95-98	TALON All	
R	90-98	TALON All	
R	06-11	HYUNDAI ACCENT All	
R	92-95	ELANTRA Non-ABS	
F	00-05	SONATA All	
R	00-05	SONATA All	
R	01	XG300 All	
R	02-05	XG350 All	
R	01-06	KIA MAGENTIS All	
R	01-06	OPTIMA All	
R	06-11	RIO All	
R	06-11	RIO All	
R	91-99	MITSUBISHI 3000GT All	
R	97-04	DIAMANTE All	
R	90-05	ECLIPSE All	
F	95-99	ECLIPSE All	
R	92-95	EXPO All	
R	89-07	GALANT All	
F	94-98	GALANT All	
R	85-88	GALANT All Exc. Electronic Adjustable Suspension	
R	97-02	MIRAGE All	
R	96	MIRAGE All Mfg. to 5/96	
R	95	MIRAGE Sedan	
R	89-94	MIRAGE All	
R	89-90	SIGMA Non-ABS Exc. Auto-Leveling System	
R	89-94	PLYMOUTH COLT All	
R	90-94	LASER All	
142439 W			
R	95-96	TOYOTA AVALON All	
R	92-96	CAMRY All	
142444 W			
F	92-94	VOLKSWAGEN CORRADO VR6	
F	93-98	GOLF All	
F	94-98	JETTA 2.8L 6Cyl V (2771), 3.25 82.5(Bore)3.40 86.4(Stroke)	
F	90-97	PASSAT All	
142524 W			
F	05-09	BUICK ALLURE All	
F	97-05	CENTURY All	
F	05-09	LACROSSE All	
F	97-05	LESABRE All	
F	97-05	PARK AVENUE All	
F	97-04	REGAL All Exc. Heavy Duty Suspension	
F	98-99	RIVIERA All	
F	98-04	CADILLAC SEVILLE All	
F	00-16	CHEVROLET IMPALA All	
F	00-07	MONTE CARLO All	
F	02-05	VENTURE All	
F	97-01	VENTURE FWD	
F	97-99	OLDSMOBILE 88 SERIES All	
F	97	AURORA All	
F	98-02	INTRIGUE All	
F	96-99	LSS All	
F	97-98	REGENCY All	
F	97-04	SILHOUETTE All	
F	97-08	PONTIAC GRAND PRIX All	
F	04-05	MONTANA All	
F	02-03	MONTANA Mini Passenger Van	
F	99-01	MONTANA All	
F	97-99	TRANS SPORT All	
142526 W			
F	05-09	BUICK ALLURE All	
F	97-05	CENTURY All	
F	05-09	LACROSSE All	

Suspension Mounts

Shock	POP	Alternative No.	MTG Acc. Supplied
Pos.	Year	Application	
142526 W (cont)			
F	97-04	REGAL All Exc. Heavy Duty Suspension	
F	05-07	TERRAZA FWD	
F	00-16	CHEVROLET IMPALA All	
F	00-07	MONTE CARLO All	
F	05-09	UPLANDER FWD Exc. Air-Leveling Suspension	
F	02-05	VENTURE All	
F	97-01	VENTURE FWD	
F	98-02	OLDSMOBILE INTRIGUE All	
F	97-04	SILHOUETTE All	
F	01-05	PONTIAC AZTEK All	
F	97-08	GRAND PRIX All	
F	99-09	MONTANA All	
F	97-99	TRANS SPORT All	
F	05-07	SATURN RELAY FWD	
142529 W			
F	97	BUICK PARK AVENUE All	
F	97	OLDSMOBILE AURORA All	
142530 W			
F	97-99	BUICK LESABRE All	
F	97-99	OLDSMOBILE 88 SERIES All	
F	96-99	LSS All	
F	97-98	REGENCY All	
F	97-99	PONTIAC BONNEVILLE All	
142543 W			
F	90-93	MITSUBISHI GALANT All	
F	89	GALANT FWD	
142546 W			
F	96-99	INFINITI I30 All	
F	95-99	NISSAN MAXIMA All	
142547 W			
F	91-96	INFINITI G20 All	
R	96-99	I30 All	
R	95-99	NISSAN MAXIMA All	
142556 W			
F	95-04	TOYOTA AVALON All	
F	95-01	CAMRY All	
F	94-99	CELICA All	
142561 W			
F	92-94	LEXUS ES300 All	
F	92-94	TOYOTA CAMRY All	
142567 W			
F	87-93	CHRYSLER DAYTONA All	
F	86	DAYTONA CAN	
F	88-93	DYNASTY All	
F	90-93	IMPERIAL All Exc. Hydraulic Self-Leveling System	
F	86	LASER All	
F	86-95	LEBARON All	
F	86-93	NEW YORKER All	
F	90-95	TOWN & COUNTRY All	
F	86-88	TOWN & COUNTRY All	
F	86-88	DODGE 600 All	
F	86-89	ARIES All	
F	86-95	CARAVAN / GRAND CARAVAN All	
F	86-93	DAYTONA All	
F	88-93	DYNASTY All Exc. Hydraulic Self-Leveling System	
F	86-89	LANCER All	
F	87-94	SHADOW All	
F	89-95	SPIRIT All	
F	89-95	PLYMOUTH ACCLAIM All	
F	86-88	CARAVELLE All	
F	86-89	RELIANT All	
F	87-94	SUNDANCE All	
F	86-95	VOYAGER / GRAND VOYAGER All	
142569 W			
F	90-92	FORD PROBE GT, 2.2L 4Cyl L (133), 3.39 86.1(Bore)3.70 94.0(Stroke), Automatic	
F	89	PROBE GT, 2.2L 4Cyl L (133), 3.39 86.1(Bore)3.70 94.0(Stroke)	
F	88-92	MAZDA 626 Automatic Exc. Electronic Adjustable Suspension or 4 Wheel Steer	
F	89-92	MX6 Automatic	
142573 W			
R	85-98	VOLKSWAGEN GOLF All	
R	85-98	JETTA All	
142625 W			
F	96-06	HYUNDAI ELANTRA All	
F	97-01	TIBURON All	

Numerical listing

Shock	POP	Alternative No.	MTG Acc. Supplied
Pos.	Year	Application	
142643 W			
F	94-97	KIA SEPHIA All	
142649 W			
F	97-01	LEXUS ES300 All Right Exc. Electronic Adjustable Suspension	
F	99-03	RX300 All Right	
F	97-04	TOYOTA AVALON All Right	
F	97-01	CAMRY All Right	
F	98-03	SIENNA All Right Mfg. to 12/02	
F	99-03	SOLARA All Right	
142650 W			
F	97-01	LEXUS ES300 All Left Exc. Electronic Adjustable Suspension	
F	99-03	RX300 All Left	
F	97-04	TOYOTA AVALON All Left	
F	97-01	CAMRY All Left	
F	98-03	SIENNA All Left	
F	99-03	SOLARA All Left	
142651 B			
F	00-06	AUDI TT All	
F	00-06	TT QUATTRO All	
F	98-10	VOLKSWAGEN BEETLE All	
F	99-06	GOLF A4 (MfrBodyCode)	
F	01-05	JETTA Sedan	
F	99-00	JETTA All	
142653 W			
R	98-04	AUDI A6 All	
R	98-01	VOLKSWAGEN PASSAT All	
142735 W			
R	92-95	BMW 525i All Exc. Electronic Adjustable Suspension	
R	89-91	525i All	
R	94-95	530i All	
R	88-93	535i All	
R	88	535iS All	
142745 W			
R	84-94	FORD TEMPO All	
R	84-94	MERCURY TOPAZ All	
142746 D			
F	86-95	FORD TAURUS All	
F	91-95	MERCURY SABLE Sedan	
F	86-90	SABLE All	
142747 W			
F	96-07	FORD TAURUS All	
F	96-05	MERCURY SABLE All	
142751 W			
F	91-99	BUICK LESABRE All	
F	91-96	PARK AVENUE All	
F	91-93	RIVIERA All	
F	93	CADILLAC 60 SPECIAL All	
F	92-93	COMMERCIAL CHASSIS FWD	
F	91	COMMERCIAL CHASSIS All	
F	91-93	DEVILLE All	
F	91-93	FLEETWOOD All	
F	90-99	OLDSMOBILE 88 SERIES All	
F	92-96	98 Coil (FrontSpringType), Air (RearSpringType) Standard Equipment; Exc. Electronic Adjustable Suspension	
F	91	98 All Standard Equipment; Exc. Electronic Adjustable Suspension	
F	95-96	AURORA All	
F	96-99	LSS All	
F	97-98	REGENCY All	
F	90-99	PONTIAC BONNEVILLE All	
142752 W			
F	86-90	BUICK LESABRE All	
F	85-90	CADILLAC COMMERCIAL CHASSIS All	
F	85-90	DEVILLE All	
F	87-90	FLEETWOOD All	
F	86-89	OLDSMOBILE 88 SERIES All	
F	85-90	98 All	
F	87-89	PONTIAC BONNEVILLE All	
142755 W			
F	93-97	CHRYSLER CONCORDE All	
F	94-97	LHS All	
F	94-96	NEW YORKER All	
F	93-97	DODGE INTREPID All	
F	93-97	EAGLE VISION All	
142828 W			
R	99-04	CHRYSLER 300M All	
R	98-04	CONCORDE All	
R	98-04	INTREPID All	
R	99-01	LHS All	

Numerical listing

Shock	POP	Alternative No.	MTG Acc. Supplied
Pos.	Year	Application	
142828 W (cont)			
R	98-04	DODGE INTREPID All	
142836 W			
F	95-96	LEXUS ES300 All	
F	95-96	TOYOTA AVALON All	
F	95-96	CAMRY All	
142840 W			
F	95-99	DODGE NEON All	
F	95-99	PLYMOUTH NEON All	
142842 W			
F	93-97	CHRYSLER CONCORDE All	
F	93-97	INTREPID CAN	
F	94-97	LHS All	
F	94-96	NEW YORKER All	
F	93-97	DODGE INTREPID All	
F	93-97	EAGLE VISION All	
142843 W			
F	95-00	FORD CONTOUR All	
F	99-02	MERCURY COUGAR All	
F	95-00	MYSTIQUE All	
142845 W			
F	96-07	FORD TAURUS All	
F	96-05	MERCURY SABLE All	
142850 W			
F	82-85	HONDA ACCORD All	
142851 W			
F	95-98	MAZDA PROT G / PROT G5 All	
142852 W			
F	89-92	FORD PROBE All	
F	88-92	MAZDA 626 Automatic Exc. Electronic Adjustable Suspension or 4 Wheel Steer	
F	88-92	MX6 Automatic Exc. Electronic Adjustable Suspension or 4 Wheel Steer	
142854 W			
F	91-96	FORD ESCORT All	
F	90-94	MAZDA 323 All	
F	92-94	PROT G / PROT G5 FWD, Non-ABS	
F	90-91	PROT G / PROT G5 All	
F	91-96	MERCURY TRACER FWD	
142855 W			
F	86-87	MAZDA 626 Manual Exc. Electronic Adjustable Suspension	
F	83-85	626 All Exc. Electronic Adjustable Suspension	
142856 W			
F	93-97	FORD PROBE All	
F	98-01	KIA SEPHIA All	
F	93-97	MAZDA 626 All	
F	93-97	MX6 All	
142930 B			
F	00-11	FORD FOCUS All	
142932 B			
F	00-02	CHRYSLER NEON All	
F	01-10	PT CRUISER All	
F	00-05	DODGE NEON All	
F	00-01	PLYMOUTH NEON All	
142933 W			
F	86-93	CHRYSLER DAYTONA All	
F	88-93	DYNASTY All	
F	90-93	IMPERIAL All	
F	86	LASER All	
F	86-95	LEBARON All	
F	86-93	NEW YORKER All	
F	90-95	TOWN & COUNTRY All	
F	86-88	DODGE 600 All	
F	86-89	ARIES All	
F	86-95	CARAVAN / GRAND CARAVAN All	
F	86-93	DAYTONA All	
F	88-93	DYNASTY All	
F	86-89	LANCER All	
F	87-94	SHADOW All	
F	89-95	SPIRIT All	
F	89-95	PLYMOUTH ACCLAIM All	
F	86-88	CARAVELLE All	
F	86-89	RELIANT All	
F	87-94	SUNDANCE All	
F	86-95	VOYAGER / GRAND VOYAGER All	
142937 B			
F	03-08	INFINITI FX35 All	
F	03-08	FX45 All	

Suspension Mounts

Shock	POP	Alternative No.	MTG Acc. Supplied
Pos.	Year	Application	
142937 B (cont)			
F	00-01	I30 All	
F	02-04	I35 All	
F	02-06	NISSAN ALTIMA All	
F	00-08	MAXIMA All	
F	03-07	MURANO All	
F	04-09	QUEST All	
142938 B			
F	97-03	INFINITI QX4 All	
F	96-03	NISSAN PATHFINDER All	
142940 W			
F	86-93	CHRYSLER DAYTONA All	
F	88-93	DYNASTY All	
F	90-93	IMPERIAL All Exc. Hydraulic Self- Leveling System	
F	86	LASER All Mfg. from 1/2/86	
F	86-95	LEBARON All Mfg. from 1/2/86	
F	86-93	NEW YORKER All Mfg. from 1/2/86	
F	90-95	TOWN & COUNTRY All	
F	86-88	DODGE 600 All	
F	86-89	ARIES All	
F	86-95	CARAVAN / GRAND CARAVAN All	
F	89-93	DAYTONA ES	
F	89-90	DAYTONA ES Turbo	
F	87-88	DAYTONA Pacifica	
F	86	DAYTONA All	
F	88-93	DYNASTY All Exc. Hydraulic Self- Leveling System	
F	86-89	LANCER All	
F	87-94	SHADOW All	
F	89-95	SPIRIT All	
F	89-95	PLYMOUTH ACCLAIM All	
F	86-88	CARAVELLE All Mfg. from 1/2/86	
F	86-89	RELIANT All	
F	87-94	SUNDANCE All	
142941 W			
R	93-97	VOLVO 850 All Exc. Hydraulic Self- Leveling System	
R	98-04	C70 All	
R	98-00	S70 All	
R	99-00	V70 R AWD Exc. Auto Rear Leveling	
R	98-00	V70 Base Exc. Auto Rear Leveling	
R	98-00	V70 GLT Exc. Auto Rear Leveling	
R	98-00	V70 T5 Exc. Auto Rear Leveling	
R	00	V70 2.4T Exc. Auto Rear Leveling	
R	00	V70 GLT SE Exc. Auto Rear Leveling	
R	98-99	V70 AWD Exc. Auto Rear Leveling	
R	98	V70 R Exc. Auto Rear Leveling	
142949 W			
R	00-03	NISSAN MAXIMA All	
142992 W			
R	08-11	FORD FOCUS All	
R	00-07	FOCUS Hatchback	
R	00-07	FOCUS Sedan	
143030 W			
F	95-00	CHRYSLER CIRRU S All	
F	96-00	SEBRING Convertible	
F	95-98	DODGE STRATUS All	
F	96-99	PLYMOUTH BREEZE All	
143071 W			
R	95-01	CHEVROLET LUMINA All Left	
R	95-96	MONTE CARLO All Left	
143072 W			
R	95-01	CHEVROLET LUMINA All Right	
R	95-96	MONTE CARLO All Right	
143073 W			
R	05-09	BUICK ALLURE All Left	
R	97-05	CENTURY All Left	
R	05-09	LACROSSE All Left	
R	97-04	REGAL All Left Exc. Heavy Duty Suspension	
R	00-11	CHEVROLET IMPALA All Left	
R	95-01	LUMINA All Left	
R	95-07	MONTE CARLO All Left	
R	98-02	OLDSMOBILE INTRIGUE All Left	
R	97-08	PONTIAC GRAND PRIX All Left	
143074 W			
R	05-09	BUICK ALLURE All Right	
R	97-05	CENTURY All Right	
R	05-09	LACROSSE All Right	
R	97-04	REGAL All Right Exc. Heavy Duty Suspension	
R	00-11	CHEVROLET IMPALA All Right	
R	95-01	LUMINA All Right	

Numerical listing

Shock	POP	Alternative No.	MTG Acc. Supplied
Pos.	Year	Application	
143074 W (cont)			
R	95-07	MONTE CARLO All Right	
R	98-02	OLDSMOBILE INTRIGUE All Right	
R	97-08	PONTIAC GRAND PRIX All Right	
143082 W			
F	00	BMW 323CI Coupe	
F	00	323I Wagon	
F	01-06	325CI All Sport Suspension; Exc. M- Sport Pack II	
F	01-06	325I All Mfg. to 9/01; Sport Suspension	
F	00	328CI All	
F	99-00	328I All	
F	01-06	330CI All Exc. Sport Suspension M- Sport Pack II	
F	97-00	528I All Exc. Electronic Adjustable Suspension	
143083 W			
F	97-01	BMW 740I All Exc. Electronic Adjustable Suspension	
F	94-95	740I All Exc. Electronic Adjustable Suspension	
F	94-01	740IL All Exc. Electronic Adjustable Suspension	
F	94-01	750IL All Exc. Electronic Adjustable Suspension	
143086 W			
F	96-06	MERCEDES-BENZ E320 All Exc. 4 Matic	
F	97	E420 All Exc. 4 Matic	
F	98-02	E430 All Exc. 4 Matic	
143087 W			
F	01-05	CHRYSLER SEBRING ST (MfrBodyCode), Coupe	
F	01-05	DODGE STRATUS ST (MfrBodyCode), Coupe	
F	01-04	HYUNDAI SANTA FE All	
F	05-09	TUCSON All	
F	97-04	MITSUBISHI DIAMANTE All	
F	00-05	ECLIPSE All	
F	99-03	GALANT All	
143088 W			
F	02-07	MITSUBISHI LANCER All	
F	03-06	OUTLANDER All	
143089 W			
F	03-07	SATURN ION All	
143091 W			
F	02-07	BUICK RENDEZVOUS All Exc. Hydraulic Self-Leveling System	
143092 W			
F	03-07	CADILLAC CTS All	
143093 W			
F	03-08	PONTIAC VIBE All	
F	03-08	TOYOTA MATRIX All	
143094 D			
R	03-08	PONTIAC VIBE All	
R	05-10	SCION TC All	
R	00-05	TOYOTA CELICA All	
R	03-08	COROLLA All	
R	03-08	MATRIX All	
R	01-09	PRIUS All	
143140 W			
R	03-06	SUBARU BAJA All	
R	00-09	LEGACY All	
R	00-05	OUTBACK All	
143191 W			
F	94-97	VOLVO 850 Wagon Exc. Hydraulic Self-Leveling System	
F	93-97	850 Sedan Exc. Hydraulic Self- Leveling System	
F	06-07	C70 All	
F	98-04	C70 All	
F	01-07	S60 All	
F	98-00	S70 All	
F	99-06	S80 All Exc. Nivomat Rear Suspension	
F	06-07	V70 R, AWD	
F	04-05	V70 2.4	
F	04-05	V70 2.5T	
F	04-05	V70 R	
F	01-05	V70 T5	
F	04	V70 2.5T AWD	
F	01-03	V70 2.4T	
F	01-03	V70 Base	
F	02	V70 AWD	

Numerical listing

Shock	POP	Alternative No.	MTG Acc. Supplied
Pos.	Year	Application	
143191	W (cont)		
F	99-00	V70 R AWD Exc.	Auto Rear Leveling
F	98-00	V70 Base Exc.	Auto Rear Leveling
F	98-00	V70 GLT Exc.	Auto Rear Leveling
F	98-00	V70 T5 Exc.	Auto Rear Leveling
F	00	V70 2.4T Exc.	Auto Rear Leveling
F	00	V70 GLT SE Exc.	Auto Rear Leveling
F	98-99	V70 AWD Exc.	Auto Rear Leveling
F	98	V70 R Exc.	Auto Rear Leveling
F	04-06	XC90 All	
F	03	XC90 AWD	
143194	W		
F	00-05	TOYOTA ECHO All Only fits OE P/N's 48609-52011 & 48609-52050	
143197	W		
R	90-94	LEXUS LS400 All Exc.	Auto-Leveling System
143201	A		
F	00-05	TOYOTA CELICA All	
F	03-08	COROLLA All	
F	04-09	PRIUS All	
143202	C		
F	02-03	LEXUS ES300 All Exc.	Electronic Adjustable Suspension
F	04-06	ES330 All Exc.	Adaptive Variable Suspension
F	04-06	RX330 All	
F	06-07	RX400H All	
F	02-06	TOYOTA CAMRY All	
F	01-07	HIGHLANDER All	
F	04-08	SIENNA All	
F	04-08	SOLARA All	
143204	W		
F	03-04	CHEVROLET TRACKER All	
F	01-02	TRACKER 2.5L 6Cyl V (2500), 3.31 84.0(Bore)2.95 75.0(Stroke)	
F	99-02	TRACKER 2.0L 4Cyl L (122), 3.31 84.1(Bore)3.54 90.0(Stroke)	
F	99-04	SUZUKI GRAND VITARA All	
F	99-04	VITARA Non-ABS	
F	02-06	XL-7 All	
143205	W		
R	03-06	SUBARU FORESTER All	
R	04-06	IMPENZA All Exc.	Sti
143207	W		
F	94-98	SAAB 900 All	
143209	W		
R	00-06	NISSAN SENTRA All	
143210	W		
F	97-01	INFINITI Q45 All Exc.	Active Suspension
143218	W		
F	98-02	MAZDA 626 All	
143226	W		
F	03-06	KIA SORENTO All	
143227	W		
F	01-03	KIA RIO All	
143233	W		
F	05-06	ACURA RSX Type-S Left	
F	02-05	HONDA CIVIC Coupe Left	
F	02-05	CIVIC Sedan Left	
143239	W		
F	06-11	CHEVROLET AVEO All	
F	04-11	AVEO All	
F	09-10	PONTIAC G3 All	
F	05-08	WAVE All	
143241	W		
F	04-07	BUICK RAINIER All	
F	03-06	CHEVROLET SSR All	
F	02-09	TRAILBLAZER All	
F	02-09	GMC ENVOY All	
F	03-08	ISUZU ASCENDER All	
F	02-04	OLDSMOBILE BRAVADA All	
F	05-09	SAAB 9-7X All	
143244	W		
F	03-06	FORD EXPEDITION All Exc.	Adjustable Suspension
F	03-05	LINCOLN NAVIGATOR All	

Suspension Mounts

Shock	POP	Alternative No.	MTG Acc. Supplied
Pos.	Year	Application	
143246	W		
F	04-07	FORD FREESTAR All	
F	04-07	MERCURY MONTEREY Mini Passenger Van	
143248	W		
F	04-08	FORD LOBO All	
F	04-08	PICKUP 1/2 TON, F-150 All	
F	06-08	LINCOLN MARK LT All	
143255	W		
F	02-11	JEEP LIBERTY All Left	
143256	W		
R	00-02	CHRYSLER NEON All	
R	00-05	DODGE NEON All	
R	00-01	PLYMOUTH NEON All	
143259	W		
R	00-06	BMW X5 All	
143263	W		
R	97-01	BMW 740i All Exc.	Electronic Adjustable Suspension
R	94-95	740i All Exc.	Electronic Adjustable Suspension
R	94-01	740iL All Exc.	Electronic Adjustable Suspension
R	00-03	M5 All	
143265	W		
F	05-06	ACURA RSX Type-S Right	
F	02-05	HONDA CIVIC Coupe Right	
F	02-05	CIVIC Sedan Right	
143266	W		
F	02-11	JEEP LIBERTY All Right	
143277	W		
F	93-99	NISSAN ALTIMA All	
F	90-92	STANZA All	
143280	W		
F	93-97	TOYOTA COROLLA Base Exc.	LE Model
F	93-97	COROLLA DX Exc.	LE Model
F	93	COROLLA All Trac Exc.	LE Model
143281	W		
F	98-02	CHEVROLET PRIZM All	
F	89-97	GEO PRIZM All	
F	90-91	LEXUS ES250 All	
F	88-02	TOYOTA COROLLA All	
143305	B		
F	12-17	HONDA ODYSSEY All From	Chassis/VIN CB088499
F	05-10	ODYSSEY All	
143315	W		
F	01-06	ACURA MDX All	
F	99-04	HONDA ODYSSEY All	
F	03-08	PILOT All	
143316	W		
F	07-13	CADILLAC ESCALADE All Exc.	Electronic Ride Control
F	07-13	ESCALADE ESV All Exc.	Electronic Ride Control
F	07-13	ESCALADE EXT All Exc.	Electronic Ride Control
F	07-13	CHEVROLET AVALANCHE 1500 All Exc.	Electronic Ride Control
F	07-13	PICKUP 1/2 TON, SILVERADO 1500 All Exc.	Electronic Adjustable Suspension
F	07-13	SUBURBAN 1/2 TON, 1500 All Exc.	Z55 or ZW7 Ride Suspension
F	07-14	TAHOE All Exc.	Z55 or ZW7 Ride Suspension
F	07-13	GMC SIERRA 1500 All Exc.	Electronic Adjustable Suspension
F	07-14	YUKON All Exc.	Electronic Adjustable Suspension
F	07-14	YUKON XL 1/2 TON All Exc.	Z55 Auto Ride Suspension
143317	W		
R	03-06	FORD EXPEDITION All	
143318	W		
F	02-05	FORD EXPLORER All	
F	02-05	MERCURY MOUNTAINEER All	
143319	W		
R	02-05	FORD EXPLORER All	
R	02-05	MERCURY MOUNTAINEER All	

Numerical listing

Shock	POP	Alternative No.	MTG Acc. Supplied
Pos.	Year	Application	
143320	W		
R	99-00	CHRYSLER SEBRING	Convertible
143321	W		
R	01-06	CHRYSLER SEBRING JR (MfrBodyCode),	Sedan
R	01-06	DODGE STRATUS	Sedan
143323	B		
F	05-10	CHEVROLET COBALT	LS
F	05-10	COBALT	LT
F	10	COBALT	Base
F	10	COBALT	LT Team Canada
F	06-07	COBALT	LTZ
F	05	COBALT	Base
F	11	HHR	All
F	08-10	HHR	LS Panel
F	08-10	HHR	LT Panel
F	06-10	HHR	LS
F	06-10	HHR	LT
F	06-08	HHR	Comfort LT
F	06-08	HHR	Elegance LT
F	07	HHR	Edicion Especial
F	07-09	PONTIAC G5	All
F	05-06	PURSUIT	All
143324	D		
F	06-08	DODGE PICKUP 1/2 TON, RAM 1500 (SEE RAM 1500) 4WD Exc.	Mega Cab
143325	C		
F	96-02	TOYOTA 4RUNNER	4WD
F	01-07	SEQUOIA All	
F	95-04	TACOMA	4WD
F	00-06	TUNDRA All	
143335	W		
R	05-10	CHRYSLER 300	All
R	08-10	DODGE CHALLENGER	All
R	06-10	CHARGER	All
R	05-08	MAGNUM	All
143336	W		
F	11-14	CHRYSLER 200	All
F	07-10	SEBRING	All
F	08-14	DODGE AVENGER	All
143337	W		
R	11-14	CHRYSLER 200	All
R	07-10	SEBRING	All
R	08-14	DODGE AVENGER	All
R	07-12	CALIBER	All
R	07-12	JEEP COMPASS	All
R	07-12	PATRIOT	All
143339	W		
F	08-17	TOYOTA SEQUOIA All Exc.	Air Suspension
143340	B		
R	08-11	TOYOTA SEQUOIA	All
R	07-16	TUNDRA	All w/ Off Road Package
143341	W		
F	05-07	FORD FREESTYLE	All
F	05-10	MUSTANG / MUSTANG II	All
F	05-07	MERCURY MONTEGO	All
143342	W		
F	06-11	HYUNDAI AZERA	All
F	06-10	SONATA	All
F	07-09	KIA AMANTI	All
143343	W		
F	06-11	TOYOTA RAV4	4WD
143344	W		
F	06-11	AUDI A3	All
F	08-09	TT	All
F	08-10	TT QUATTRO	All
F	09-17	VOLKSWAGEN CC	All
F	07-11	EOS	All
F	10-11	GOLF	All
F	06-14	GTI	All
F	06-17	JETTA	All
F	09-10	PASSAT	All
F	06-10	PASSAT	All
F	08	R32	All
F	06-09	RABBIT	All
F	09-11	TIGUAN	All
143345	B		
R	06-11	AUDI A3	All
R	08-09	TT	All
R	08-10	TT QUATTRO	All
R	09-17	VOLKSWAGEN CC	All

Numerical listing

Shock	POP	Alternative No.	MTG Acc. Supplied
Pos.	Year	Application	
143345 B (cont)			
R	07-11	EOS	All
R	10-11	GOLF	All
R	06-14	GTI	All
R	06-17	JETTA	All
R	09-10	PASSAT	All
R	12-13	PASSAT	All Mfg to 10/12
R	10	PASSAT	All Mfg to 10/12
R	06-09	PASSAT	All
R	08	R32	All
R	06-09	RABBIT	All
R	09-17	TIGUAN	All
R	18	TIGUAN LIMITED	All
143346 B			
F	02-07	NISSAN X-TRAIL	All
143349 B			
F	06-08	CHEVROLET OPTRA	All
F	04-08	SUZUKI FORENZA	All
F	05-08	RENO	All
143350 W			
R	06-08	CHEVROLET OPTRA	All
R	04-08	SUZUKI FORENZA	All
R	05-08	RENO	All
143353 W			
F	02-06	ACURA RSX Base	
F	02-06	RSX Type-S	
F	02-05	HONDA CIVIC Hatchback Exc. Hybrid & Si Models	
F	01	CIVIC	All
F	02-06	CR-V	All
F	03-06	ELEMENT	All
143354 W			
F	04-12	CHEVROLET MALIBU	All Left
F	05-10	PONTIAC G6	All Right
F	07-09	SATURN AURA	All Left
143355 W			
F	04-12	CHEVROLET MALIBU	All Right
F	05-10	PONTIAC G6	All Right
F	07-09	SATURN AURA	All Right
143357 B			
F	07-11	FORD CROWN VICTORIA	All
F	03-06	CROWN VICTORIA	Base
F	03-06	CROWN VICTORIA	LX
F	04-05	CROWN VICTORIA	LX Sport
F	05	CROWN VICTORIA	S
F	05	CROWN VICTORIA	Special Edition
F	03	CROWN VICTORIA	LWB
F	03	CROWN VICTORIA	S
F	03-11	LINCOLN TOWN CAR	Executive
F	03-11	MERCURY GRAND MARQUIS	All
143358 W			
F	04-10	INFINITI QX56	All
F	05-11	NISSAN ARMADA	All
F	04-11	TITAN	All
143359 W			
F	04-10	INFINITI QX56	All
F	05-11	NISSAN ARMADA	All
F	04-11	TITAN	All
143360 W			
F	06-10	FORD EXPLORER	All
F	06-10	MERCURY MOUNTAINEER	All
143361 W			
R	06-10	FORD EXPLORER	All
R	06-10	MERCURY MOUNTAINEER	All
143362 B			
R	06-10	FORD EXPLORER	All
R	06-10	MERCURY MOUNTAINEER	All
143363 W			
F	05-06	CHEVROLET EQUINOX	All
F	06	PONTIAC TORRENT	All
143364 W			
F	06-10	JEEP COMMANDER	All
F	05-10	GRAND CHEROKEE	All
143365 W			
F	10-12	MAZDA 3	Grand Touring
F	10-12	3	GX
F	10-12	3	I Touring
F	08-12	3	GS
F	08-12	3	GT
F	04-12	3	i
F	12	3	GS-SKY
F	12	3	S

Suspension Mounts

Shock	POP	Alternative No.	MTG Acc. Supplied
Pos.	Year	Application	
143365 W (cont)			
F	08-09	3	S
F	08	3	GX
F	05	3	SP23
F	06-10	5	All
143366 W			
F	08-12	BUICK ENCLAVE	All
F	09-12	CHEVROLET TRAVERSE	All
F	07-12	GMC ACADIA	All
F	07-10	SATURN OUTLOOK	All
143367 W			
F	96-05	TOYOTA RAV4	All
143369 W			
F	05-10	CHRYSLER 300	RWD
F	08-10	DODGE CHALLENGER	All
F	06-10	CHARGER	RWD
F	05-08	MAGNUM	RWD
143378 W			
F	07-10	NISSAN SENTRA	All Right
143380 W			
R	02-05	VOLKSWAGEN PASSAT	FWD
143383 W			
F	03-18	TOYOTA 4RUNNER	All
F	07-12	FJ CRUISER	All
F	05-12	TACOMA	All
143385 W			
F	05-09	DODGE DAKOTA	All
F	06-09	MITSUBISHI RAIDER	All
143386 B			
R	06-10	HYUNDAI AZERA	All
R	06-10	SONATA	All
R	07-11	KIA RONDO	All
143387 B			
R	04-06	LEXUS RX330	All Left Exc. Air Suspension
R	07-09	RX350	All Left Exc. Air Suspension
R	06-08	RX400H	All Left
R	04-07	TOYOTA HIGHLANDER	All Left
143388 B			
R	04-06	LEXUS RX330	All Right Exc. Air Suspension
R	07-09	RX350	All Right Exc. Air Suspension
R	06-08	RX400H	All Right
R	04-07	TOYOTA HIGHLANDER	All Right
143390 W			
R	05-07	FORD FIVE HUNDRED	FWD Left
R	05-07	MERCURY MONTEGO	All Left
143391 W			
R	05-07	FORD FIVE HUNDRED	FWD Right
R	05-07	MERCURY MONTEGO	All Right
143393 W			
R	17	FORD EXPEDITION	All Exc. Air Suspension
R	15-16	EXPEDITION 4WD	Exc. Air Suspension
R	15-16	EXPEDITION RWD	Exc. Air Suspension
R	07-14	EXPEDITION	All
R	17	LINCOLN NAVIGATOR	All Exc. Air Suspension
R	11-16	NAVIGATOR 4WD	Exc. Air Suspension
R	11-16	NAVIGATOR RWD	Exc. Air Suspension
R	07-10	NAVIGATOR	All Exc. Air Suspension
143394 B			
R	02-10	MITSUBISHI LANCER	All
R	03-11	OUTLANDER	All
143396 B			
R	03-07	NISSAN MURANO	All
R	04-09	QUEST	All
143397 B			
F	03-08	HYUNDAI TIBURON	All
143398 W			
F	10	MITSUBISHI ENDEAVOR	All
F	04-08	ENDEAVOR	All
F	04-10	GALANT	All

Numerical listing

Shock	POP	Alternative No.	MTG Acc. Supplied
Pos.	Year	Application	
143399 W			
F	11-14	FORD FIESTA	All
F	11-14	MAZDA 2	All
143400 W			
R	11-12	FORD FIESTA	All
R	11	MAZDA 2	All
143401 W			
F	02-07	SUZUKI AERIO	All
143402 W			
F	07-11	LEXUS ES350	All
F	06-11	TOYOTA AVALON	All
F	07-11	CAMRY	All
F	08-13	HIGHLANDER	All
F	09-11	VENZA	All
143404 W			
F	02-06	MINI COOPER	All
143405 W			
F	02-11	MINI COOPER	All
143406 B			
F	05-10	SCION TC	All
143408 W			
R	98-05	LEXUS GS300	All
R	98-00	GS400	All
R	01-05	GS430	All
R	01-05	IS300	All
143409 B			
F	06-11	HYUNDAI ACCENT	All Left
F	06-11	KIA RIO	All Left
F	06-11	RIO	All Left
143410 B			
F	06-11	HYUNDAI ACCENT	All Right
F	06-11	KIA RIO	All Right
F	06-11	RIO	All Right
143412 B			
F	06-08	MAZDA MX-5 MIATA	All
R	06-08	MX-5 MIATA	All
143413 W			
R	06-11	TOYOTA CAMRY	All Left
143414 W			
R	06-11	TOYOTA CAMRY	All Right
143415 B			
F	07-10	FORD EDGE	All
F	08	TAURUS	All
F	08	TAURUS X	All
F	07-10	LINCOLN MKX	All
F	08-09	MERCURY SABLE	All
143416 A			
F	07-09	HYUNDAI ENTOURAGE	All
F	07-11	SANTA FE	All
F	07-11	VERACRUZ	All
F	06-11	KIA SEDONA	All
143418 B			
R	02-07	SUZUKI AERIO	All
143419 W			
F	04-06	KIA AMANTI	All
R	04-06	AMANTI	All
143422 W			
R	00-04	VOLVO S40	All
R	00-04	V40	All
143423 W			
R	03-06	CHRYSLER SEBRING JR	(MfrBodyCode), Convertible
R	03-06	SEBRING JR	(MfrBodyCode), Sedan
F	01-06	SEBRING JR	(MfrBodyCode), Convertible
F	01-06	SEBRING JR	(MfrBodyCode), Sedan
F	01-06	DODGE STRATUS	Sedan
R	01-06	STRATUS	Sedan
R	99-00	STRATUS	All
143424 W			
F	07-16	FORD EXPEDITION	All
F	10-13	LOBO	All
F	10-12	PICKUP 1/2 TON	F-150 All
F	07-16	LINCOLN NAVIGATOR	All
143425 B			
R	08-12	CHEVROLET MALIBU	All

Numerical listing

Shock	POP	Alternative No.	MTG Acc. Supplied
Pos.	Year	Application	
143425 B (cont)			
R	04	MALIBU All	
R	05-10	PONTIAC G6 All	
R	07-09	SATURN AURA XE	
R	07-09	AURA XR	
R	07-08	AURA Green Line	
143455 A			
F	03-07	INFINITI G35 All	
F	06-07	M35 All	
F	03-08	NISSAN 350Z All	
143456 W			
F	04-05	KIA RIO Sedan Left	
143457 W			
F	04-05	KIA RIO Sedan Right	
143458 B			
F	02-05	KIA SEDONA All	
143459 B			
F	04-06	PONTIAC GTO All	
143460 B			
F	10-12	CHEVROLET CAMARO All	
143461 B			
R	10-12	CHEVROLET CAMARO 3.6L 6Cyl V (217), 3.70 94.0(Bore)3.37 85.6(Stroke) Left	
143462 B			
R	10-12	CHEVROLET CAMARO 3.6L 6Cyl V (217) Right	
143463 W			
F	08-16	CHRYSLER TOWN & COUNTRY All	
F	08-16	DODGE CARAVAN / GRAND CARAVAN All	
F	09-14	VOLKSWAGEN ROUTAN All	
143464 W			
F	01-03	MITSUBISHI MONTERO All	
143465 B			
R	02-03	SUBARU IMPREZA All Left	
143466 B			
R	02-03	SUBARU IMPREZA All Right	
143468 B			
F	11-13	CHRYSLER 300 All	
F	11-13	DODGE CHARGER AWD	
143473 B			
F	10-15	CHEVROLET CRUZE All	
F	16	CRUZE LIMITED All	
143474 B			
R	10-15	CHEVROLET CRUZE All	
R	16	CRUZE LIMITED All	
143476 A			
R	11-14	FORD EXPLORER All	
R	10-14	TAURUS All	
143477 W			
F	07-11	HYUNDAI ELANTRA All	
143486 W			
F	13-14	CHEVROLET TRAVERSE All	
143491 W			
F	07-12	MINI COOPER All	
143492 B			
F	09-13	SUBARU FORESTER All	
F	06-08	FORESTER Manual	
F	98-05	FORESTER All	
F	12-14	IMPREZA All Exc. Sti	
F	08-11	IMPREZA All	
F	04-07	IMPREZA All Exc. Sti	
F	93-03	IMPREZA All	
F	90-13	LEGACY All	
F	00-14	OUTBACK All	
143495 B			
F	07-12	DODGE CALIBER All	
F	07-10	JEEP COMPASS All	
F	07-10	PATRIOT All	
143496 W			
R	07-11	DODGE CALIBER All	
R	07-10	JEEP COMPASS All	
R	07-09	PATRIOT All	

Suspension Mounts, Strut Cushion

Shock	POP	Alternative No.	MTG Acc. Supplied
Pos.	Year	Application	
143498 A			
R	06-11	HONDA CIVIC All	
143530 W			
R	12-13	HONDA CIVIC All	
143531 B			
R	04-11	MAZDA 3 All	
R	06-10	5 All	
143564 W			
F	10-13	FORD TRANSIT CONNECT All	
Strut Cushion			
143057 B			
F	93	ASUNA GT, SE All	
F	88-92	AUDI 80 All	
F	88-92	80 QUATTRO All	
F	93-95	90 All	
F	88-91	90 All	
F	93-95	90 QUATTRO All	
F	88-91	90 QUATTRO All	
F	89-90	100 QUATTRO All	
F	89-90	200 QUATTRO Wagon	
F	80-87	4000 All	
F	84-87	4000 QUATTRO All	
F	83-87	COUPE All	
F	90-91	COUPE QUATTRO All	
F	90-94	V8 QUATTRO All	
F	95-99	BMW 318TI All	
F	97-05	BUICK PARK AVENUE All	
F	97-99	RIVIERA All	
F	95-05	CHEVROLET CAVALIER All	
R	04-05	CLASSIC All	
R	97-03	MALIBU All	
R	98-01	METRO Non-ABS	
R	89-91	SPRINT All	
F	99-04	CHRYSLER 300M All	
F	93-04	CONCORDE All	
R	87-89	CONQUEST All Exc. Electronic Adjustable Suspension	
F	83	E CLASS All	
F	83	EXECUTIVE SEDAN All	
F	93-04	INTREPID CAN	
F	81-83	LEBARON All	
F	99-01	LHS All	
F	94-97	LHS All	
R	00-02	NEON All	
F	94-96	NEW YORKER All	
F	83	NEW YORKER All	
R	01-10	PT CRUISER All	
F	96-00	SEBRING Coupe	
R	96-00	SEBRING Coupe	
F	95	SEBRING All	
R	95	SEBRING All	
F	82-83	DODGE 400 All	
F	83	600 All	
F	81-83	ARIES All	
F	83-87	CHARGER All	
F	90-95	COLT Sedan	
F	90-94	COLT Hatchback	
F	93-04	INTREPID All	
R	95-05	NEON All	
R	78-89	OMNI All	
F	82-84	RAMPAGE All	
F	91-93	EAGLE 2000 GTX CAN	
F	89-96	SUMMIT All	
F	90-94	TALON All	
F	93-97	VISION All	
F	94-97	FORD ASPIRE Non-ABS	
F	81-96	ESCORT All	
F	82-88	EXP All	
F	00-05	FOCUS Hatchback	
F	00-05	FOCUS Sedan	
R	93-97	PROBE All	
F	89-92	PROBE All	
R	94-07	TAURUS Sedan	
F	84-85	TEMPO All	
R	89-97	GEO METRO Non-ABS	
F	85-87	HONDA CIVIC Wagon, 4WD	
F	92-95	HYUNDAI ELANTRA Non-ABS	
F	90-94	EXCEL All	
R	89-94	SONATA All	
F	91-96	INFINITI G20 All	
R	92-02	LEXUS ES300 All	
F	02	ES300 All Exc. Electronic Adjustable Suspension	
R	92-01	ES300 All	
F	90-94	MAZDA 323 All	
R	93-97	626 All	
R	88-92	626 All Exc. Electronic Adjustable Suspension or 4 Wheel Steer	
F	86-87	626 Automatic Exc. Electronic Adjustable Suspension	

Numerical listing

Shock	POP	Alternative No.	MTG Acc. Supplied
Pos.	Year	Application	
143057 B (cont)			
R	86-87	626 Automatic Exc. Electronic Adjustable Suspension	
F	83-85	626 All	
R	83-85	626 All	
R	84-85	GLC All	
R	81-83	GLC Hatchback	
R	81-83	GLC Sedan	
R	88-97	MX6 All	
F	90-03	PROTG / PROTG5 All	
F	91-93	MERCURY CAPRI All	
F	82-83	LN7 All	
F	81-87	LYNX All	
R	94-05	SABLE Sedan	
F	84-85	TOPAZ All	
F	91-96	TRACER FWD	
F	93-98	VILLAGER All	
F	90-94	MITSUBISHI ECLIPSE All	
F	92-95	EXPO All	
R	94-98	GALANT All	
F	89-98	GALANT All	
F	89-96	MIRAGE All	
F	90-94	PRECIS All	
F	87-89	STARION All	
F	95-98	NISSAN 200SX All	
F	90-96	300ZX 2+2	
F	84-86	300ZX All	
F	00-01	ALTIMA All	
R	89-94	MAXIMA All	
R	87-88	MULTI CAN	
F	91-93	NX All	
F	83-90	PULSAR / PULSAR NX All	
F	93-98	QUEST All	
F	91-99	SENTRA All	
F	87-90	SENTRA FWD	
F	82-86	SENTRA All	
R	87-89	STANZA Sedan	
R	99-04	OLDSMOBILE ALERO All	
R	97-99	CUTLASS / CUTLASS SUPREME All	
F	92-93	PLYMOUTH COLT All	
F	89-91	COLT Hatchback, FWD	
F	87-89	EXPO All	
F	78-89	HORIZON All	
F	90-94	LASER All	
F	95-99	NEON All	
F	81-83	RELIANT All	
F	83	SCAMP All	
F	85	TURISMO All	
F	83	TURISMO All	
R	94-99	PONTIAC FIREFLY CAN	
R	89-91	FIREFLY CAN	
R	99-05	GRAND AM All	
F	88-93	LEMANS All	
F	95-05	SUNFIRE All	
F	86-98	SAAB 900 All	
F	91-02	SATURN SC / SL / SW SERIES All	
F	98-02	SUBARU FORESTER All	
R	98-02	FORESTER All	
F	90-99	LEGACY All	
R	90-99	LEGACY All	
F	95-02	SUZUKI ESTEEM All	
R	95-02	ESTEEM All	
R	89-01	SWIFT All	
F	95-03	TOYOTA AVALON All	
R	95-03	AVALON All	
F	87-01	CAMRY All	
R	87-01	CAMRY All	
R	92-93	CELICA All	
F	75-85	CELICA All	
F	93-02	COROLLA All	
F	88	COROLLA FX	
F	88	COROLLA FX16	
F	80-87	COROLLA All	
F	75-79	COROLLA Wagon	
F	74	COROLLA All Mfg. from 8/74	
F	99-03	SOLARA All	
R	86-91	SUPRA All	
F	86	SUPRA All	
R	83-88	TERCEL Wagon	
F	87-93	VOLKSWAGEN FOX All	
F	82-88	QUANTUM All	
F	71-79	SUPER BEETLE All	
F	75-93	VOLVO 240 / 242 / 244 / 245 / 262 / 264 / 265 All	
143058 B			
F	93	ASUNA SUNFIRE (CANADIAN VEHICLE) All Exc. Lotus Suspension	
R	85-88	CHEVROLET NOVA All	
R	98-02	PRIZM All	
F	85-88	SPECTRUM All	
R	99-04	CHRYSLER 300M All	
R	98-04	CONCORDE All	

Numerical listing

Shock	POP	Alternative No.	MTG Acc. Supplied
Pos.	Year	Application	
143058 B (cont)			
F	87-89	CONQUEST All Exc. Electronic Adjustable Suspension	
R	98-04	INTREPID CAN	
R	99-01	LHS All	
R	94-97	LHS All	
R	84-86	DODGE CONQUEST All	
R	98-04	INTREPID All	
R	95-00	FORD CONTOUR All	
R	91-96	ESCORT All	
R	93-97	GEO PRIZM All	
F	89	SPECTRUM All	
F	90-93	STORM Non-ABS	
F	90-92	ISUZU IMPULSE All	
F	91-93	STYLUS All	
F	86-89	MAZDA 323 FWD	
R	86-89	323 FWD	
R	92-03	PROTG / PROTG5 All	
R	90-91	PROTG / PROTG5 FWD	
R	99-02	MERCURY COUGAR All	
R	91-96	TRACER FWD	
R	87-89	TRACER FWD	
R	87-89	MITSUBISHI STARION All	
F	84-86	STARION LE	
R	84-86	STARION LE	
F	84-85	STARION LS	
R	84-85	STARION LS	
F	83	STARION All	
R	83	STARION All	
F	86	NISSAN STANZA Sedan	
F	82-85	STANZA All	
F	85-88	PONTIAC SUNBURST CAN	
F	87-88	PORSCHÉ 924 All	
F	77-82	924 All	
F	83-88	944 All	
F	86-87	SAAB 9000 All	
F	83-86	TOYOTA CAMRY All	
R	84-92	COROLLA FWD	
F	85-93	VOLKSWAGEN CABRIOLET All	
F	85-98	GOLF All	
F	80-98	JETTA All	
F	90-01	PASSAT All	
F	75-84	RABBIT All	
F	80-83	RABBIT PICKUP All	
F	75-89	SCIROCCO All	
F	84-92	VOLVO 740 / 745 / 760 / 780 All	
F	91-95	940 All Exc. Hydraulic Self-Leveling System	
F	92-95	960 All	
143059 B			
R	73-79	AUDI FOX All	
F	92-98	BUICK SKYLARK All	
F	92-96	CHEVROLET BERETTA All	
F	87-94	CAVALIER All	
F	92-96	CORSICA All	
F	98-01	METRO Non-ABS	
R	95-07	MONTE CARLO All	
F	85-88	NOVA All	
F	98-02	PRIZM All	
F	89-91	SPRINT All	
F	86-93	CHRYSLER DAYTONA CAN	
F	88-93	DYNASTY CAN	
F	90-93	IMPERIAL All	
F	86-95	LEBARON All	
F	04-08	PACIFICA All	
F	90-00	TOWN & COUNTRY All	
F	00-07	VOYAGER / GRAND VOYAGER All	
F	84-00	DODGE CARAVAN / GRAND CARAVAN All	
F	78-83	CHALLENGER All	
F	85-91	COLT Vista, Wagon, FWD	
F	84	COLT Wagon	
F	71-80	COLT Wagon	
F	86-93	DAYTONA All	
F	88-93	DYNASTY All	
F	87-88	MINI RAM All	
R	95-99	NEON All	
F	90	OMNI All	
F	87-94	SHADOW All	
F	89-95	SPIRIT All	
F	89-91	EAGLE VISTA Wagon, CAN	
R	81-90	FORD ESCORT All	
R	82-88	EXP All	
F	78-83	FAIRMONT All	
F	88-93	FESTIVA All	
F	81-82	GRANADA All	
F	83-86	LTD / COUNTRY SEDAN / COUNTRY SQUIRE / CROWN VICTORIA All	
F	79-93	MUSTANG / MUSTANG II All	
F	94-07	TAURUS All	
R	86-93	TAURUS Sedan	
F	86-93	TAURUS Wagon	
R	84-94	TEMPO All	

Strut Cushion

Shock	POP	Alternative No.	MTG Acc. Supplied
Pos.	Year	Application	
143059 B (cont)			
F	87-88	THUNDERBIRD Non-ABS	
F	80-86	THUNDERBIRD All	
F	95-03	WINDSTAR All	
F	89-97	GEO METRO Non-ABS	
F	89-97	PRIZM All	
R	82-85	HONDA ACCORD All	
F	76-81	ACCORD All	
R	83-87	PRELUDE All	
F	79-87	PRELUDE All	
F	98-05	HYUNDAI ACCENT All	
R	97	ACCENT All Mfg. to 6/97	
F	95-96	ACCENT All	
R	95-96	ACCENT All	
F	86-89	EXCEL All	
F	82-87	LINCOLN CONTINENTAL All	
F	84-92	MARK VII All	
F	81-85	MAZDA GLC Hatchback	
F	81-85	GLC Sedan	
F	86-91	RX7 All	
R	91-93	MERCURY CAPRI All	
F	79-86	CAPRI All	
F	80-88	COUGAR All	
R	82-83	LN7 All	
R	81-87	LYNX All	
F	83-86	MARQUIS All	
F	86-05	SABLE All	
R	84-94	TOPAZ All	
F	87-91	TOPAZ All	
F	78-83	ZEPHYR All	
F	83-88	MITSUBISHI CORDIA All	
F	95-05	ECLIPSE All	
R	95-05	ECLIPSE All	
F	97-02	MIRAGE All	
F	87-89	PRECIS All	
F	83-88	TREDIA All	
F	80-88	NISSAN 200SX All	
F	79-82	210 All	
F	89-94	240SX All	
R	70-73	240Z All	
R	74-75	260Z All	
R	75-78	280Z All	
F	79-83	280ZX All	
F	79-82	310 All	
F	78-81	510 All	
R	81	810 All	
R	00-01	ALTIMA All	
F	90-94	AXXESS All	
F	90-94	AXXESS All	
R	74-78	B210 All	
F	76-78	F10 All	
F	89-94	MAXIMA All	
R	86-88	MAXIMA Sedan	
R	85	MAXIMA All	
F	82-84	MAXIMA All	
R	86-90	PULSAR / PULSAR NX All	
F	90-92	STANZA All	
F	92-98	OLDSMOBILE ACHIEVA All	
F	89-95	PLYMOUTH ACCLAIM All	
F	76-80	ARROW All	
F	79-82	CHAMP All	
F	84-91	COLT Vista, Wagon	
F	80-83	COLT Hatchback	
F	76-79	COLT Sedan	
F	76-79	COLT Wagon	
R	87-89	EXPO All	
F	90	HORIZON Hatchback	
R	95-99	NEON All	
F	78-83	SAPORO All	
F	96-00	VOYAGER / GRAND VOYAGER Non-ABS	
F	84-00	VOYAGER / GRAND VOYAGER All	
R	84-88	PONTIAC FIERO All	
F	94-99	FIREFLY CAN	
F	89-91	FIREFLY CAN	
F	92-98	GRAND AM All Exc. Electronic Adjustable Suspension	
R	91-02	SATURN SC / SL / SW SERIES All	
F	07-09	SUZUKI SWIFT All	
F	89-01	SWIFT All	
F	72-73	TOYOTA CARINA All	
F	92-93	CELICA GT	
F	92-93	CELICA GTS	
F	92-93	CELICA ST	
R	90-91	CELICA AWD	
F	90-91	CELICA AWD	
F	86-89	CELICA All	
F	89-02	COROLLA All	
F	88	COROLLA DLX	
F	88	COROLLA GTS	
F	88	COROLLA LE	
F	88	COROLLA SR5	
F	79-82	CORONA All	
F	78-92	CRESSIDA All	
F	92-95	MR2 All	

Numerical listing

Shock	POP	Alternative No.	MTG Acc. Supplied
Pos.	Year	Application	
143059 B (cont)			
F	85-89	MR2 All	
F	92-99	PASEO All	
F	81-84	STARLET All	
F	80-99	TERCEL All	
143061 B			
R	93	ASUNA SUNFIRE (CANADIAN VEHICLE) All Exc. Lotus Suspension	
R	88-92	AUDI 80 All	
R	93-95	90 All	
R	88-91	90 All	
R	91-94	100 All Mfg. Late 91	
F	89-94	100 All Mfg. Late 91	
R	89-90	100 All	
R	89-90	200 All	
R	80-87	4000 All	
R	84-87	4000 QUATTRO All	
F	95-97	A6 QUATTRO All	
R	83-87	COUPE All	
F	91-98	BMW 318i All	
F	84-85	318i All	
F	91-98	318iS All	
F	98-99	323i All	
F	87-88	325 All	
F	84-87	325E All	
F	87-95	325i All	
F	87-92	325iS All	
F	88-91	325iX All	
F	96-98	328i All	
F	89-95	525i All	
F	82-88	528E All	
F	94-95	530i All	
F	83-84	533i All	
F	91-93	535i All	
F	90	535i All Mfg. from 8/90	
F	85-89	535i All	
F	88	535iS All	
F	85-89	635CSI All	
F	86-92	735i All	
F	88-92	735iL All	
R	05-09	BUICK ALLURE All	
R	97-05	CENTURY All	
F	85-90	ELECTRA All	
R	05-09	LACROSSE All	
F	90	LESABRE All Early Design Front Strut w/ Spring Guard	
F	86-89	LESABRE All	
R	97-04	REGAL All	
F	86-89	RIVIERA All	
F	87-88	CADILLAC ALLANTE All	
F	87-92	BROUGHAM All	
F	85-90	COMMERCIAL CHASSIS All	
F	85-90	DEVILLE All	
F	86-89	ELDORADO All	
F	85-90	FLEETWOOD All	
F	86-89	SEVILLE All	
R	00-16	CHEVROLET IMPALA All	
R	95-01	LUMINA All	
F	95-00	FORD CONTOUR All	
F	97-03	ESCORT All	
R	89-92	GEO PRIZM All	
R	90-93	STORM Non-ABS	
F	99-04	HONDA ODYSSEY All	
R	90-92	ISUZU IMPULSE All	
R	91-93	STYLUS All	
F	90-91	LEXUS ES250 All	
R	90-91	ES250 All	
F	00-06	MAZDA MPV All	
F	99-02	MERCURY COUGAR All	
F	97-99	TRACER FWD	
F	86-90	OLDSMOBILE 88 SERIES All Early Design Front Strut w/ Spring Guard	
F	85-90	98 All	
R	98-02	INTRIGUE All	
F	91	PEUGEOT 504 / 505 / 604 All	
F	86-90	504 / 505 / 604 Sedan	
F	87-89	PONTIAC BONNEVILLE All	
F	88-98	SAAB 9000 All	
F	80-87	SUBARU BRAT All	
F	85-89	DL All	
F	85-89	GL Hatchback	
F	90-94	LOYALE All	
F	91-97	TOYOTA PREVIA All	
F	90-92	VOLKSWAGEN CORRADO All	
143063 B			
R	91-95	ACURA LEGEND All	
R	86-90	LEGEND All Auto-Leveling System	
R	85-89	BMW 635CSI All	
R	95-00	CHRYSLER CIRRUS All	
R	96-00	SEBRING Convertible	
R	95-00	DODGE STRATUS All	
R	88-93	FORD FESTIVA All	
R	90-02	HONDA ACCORD All	

Numerical listing

Shock	POP	Alternative No.	MTG Acc. Supplied
Pos.	Year	Application	
143063 B (cont)			
R	95-98	ODYSSEY All	
R	96-99	ISUZU OASIS All	
R	86-91	MAZDA RX7 All	
R	93	MITSUBISHI GALANT All	
R	90-92	GALANT AWD	
R	89	GALANT All	
R	96-00	PLYMOUTH BREEZE All	
R	90-92	VOLKSWAGEN CORRADO All	
R	87-93	FOX All	
R	85-98	GOLF All	
R	85-98	JETTA All	
R	98-01	PASSAT All	
R	82-88	QUANTUM All	
R	75-89	SCIROCCO All	

Shock	POP	Alternative No.	MTG Acc. Supplied
Pos.	Year	Application	
143064 B			
R	97-99	ACURA CL All	
F	97-00	EL All	
R	97-00	EL All	
F	90-01	INTEGRA All	
R	90-01	INTEGRA All	
F	86-90	LEGEND All Auto-Leveling System	
F	92-94	VIGOR All	
R	92-94	VIGOR All	
F	95-00	CHRYSLER CIRRUS All	
F	96-00	SEBRING Convertible	
R	89	DODGE 2000 GTX CAN	
R	92-95	COLT All	
R	89-91	COLT Hatchback	
F	95-00	STRATUS All	
R	91-93	EAGLE 2000 GTX CAN	
R	92	SUMMIT Sedan	
R	89-91	SUMMIT All	
R	90-94	TALON All	
F	90-02	HONDA ACCORD All	
R	86-89	ACCORD All	
R	89-00	CIVIC All	
R	93-97	CIVIC DEL SOL All	
F	97-01	CR-V All	
R	97-01	CR-V All	
F	89-91	CRX All	
R	88	CRX All	
F	95-98	ODYSSEY All	
R	92-01	PRELUDE All	
F	88-01	PRELUDE All	
F	96-99	ISUZU OASIS All	
F	95-99	KIA SPORTAGE All	
R	91-97	MAZDA MIATA Non-ABS	
R	90	MIATA All	
R	90-94	MITSUBISHI ECLIPSE All	
R	85-88	GALANT All	
R	89-02	MIRAGE All	
R	89-90	SIGMA Non-ABS	
R	89-94	NISSAN 240SX All	
F	90-96	300ZX 2+2	
F	96-00	PLYMOUTH BREEZE All	
R	90-94	LASER All	
R	90-94	SUBARU LOYALE All	
R	85-91	XT FWD, Coil (RearSpringType)	
R	92-99	TOYOTA PASEO All	
R	91-99	TERCEL All	
R	87-90	TERCEL Hatchback	
R	87-90	TERCEL Sedan	

Strut Cushion

Shock	POP	Alternative No.	MTG Acc. Supplied
Pos.	Year	Application	

Numerical listing

Shock	POP	Alternative No.	MTG Acc. Supplied
Pos.	Year	Application	

LEFT/RIGHT COMBINATIONS

	ProGuard			G51917	FL	G51918	FR	G52173	FL	G52174	FR
61699	RL	61700	RR	G51920	FL	G51921	FR	G52175	FL	G52176	FR
	Suspension Mounts			G51925	FL	G51926	FR	G52182	RL	G52183	RR
				G51947	FL	G51948	FR	G52184	FL	G52185	FR
142403	RL	142404	RR	G51979	FL	G51981	FR	G52187	FL	G52188	FR
142650	FL	142649	FR	G52004	FL	G52007	FR	G52199	FL	G52200	FR
143071	RL	143072	RR	G52005	FL	G52006	FR	G52201	FL	G52202	FR
143073	RL	143074	RR	G52008	FL	G52009	FR	G52203	RL	G52204	RR
143233	FL	143265	FR	G52013	FL	G52014	FR	G52209	FL	G52210	FR
143255	FL	143266	FR	G52017	RL	G52018	RR	G52237	FL	G52238	FR
143387	RL	143388	RR	G52019	FL	G52020	FR	G52245	FL	G52246	FR
143390	RL	143391	RR	G52023	FL	G52024	FR	G52247	FL	G52248	FR
143409	FL	143410	FR	G52026	FL	G52027	FR	G52253	FL	G52254	FR
143413	RL	143414	RR	G52032	FL	G52033	FR	G52255	FL	G52256	FR
143456	FL	143457	FR	G52036	FL	G52037	FR	G52257	FL	G52258	FR
143461	RL	143462	RR	G52038	FL	G52039	FR	G52260	FL	G52261	FR
143465	RL	143466	RR	G52081	FL	G52082	FR	G52264	FL	G52265	FR
143233	FL	143265	FR	G52094	FL	G52095	FR	G52270	FL	G52271	FR
143255	FL	143266	FR	G52096	FL	G52097	FR	G52272	FL	G52273	FR
143377	FL	143378	FR	G52103	RL	G52104	RR	G52274	FL	G52275	FR
143381	FL	143382	FR	G52105	FL	G52106	FR	G52278	FL	G52279	FR
143387	RL	143388	RR	G52107	FL	G52108	FR	G52280	FL	G52281	FR
143390	RL	143391	RR	G52110	FL	G52111	FR	G52282	FL	G52283	FR
143409	FL	143410	FR	G52112	FL	G52113	FR	G52293	FL	G52294	FR
143413	RL	143414	RR	G52117	FL	G52118	FR	G52297	FL	G52298	FR
143456	FL	143457	FR	G52121	FL	G52122	FR	G52299	FL	G52300	FR
143461	RL	143462	RR	G52127	FL	G52128	FR	G52329	FL	G52330	FR
143465	RL	143466	RR	G52129	FL	G52130	FR	G52331	FL	G52332	FR
143516	FL	143517	FR	G52140	FL	G52141	FR	G52333	RL	G52334	RR
	Ultra Struts			G52142	FL	G52143	FR	G52335	RL	G52336	RR
G511019	FL	G511020	FR	G52144	FL	G52145	FR	G52348	FL	G52349	FR
G511054	FL	G511055	FR	G52148	FL	G52149	FR	G52351	FL	G52352	FR
G51761	FL	G51760	FR	G52150	FL	G52151	FR	G52353	FL	G52354	FR
G51810	FL	G51811	FR	G52152	FL	G52153	FR	G52355	FL	G52356	FR
G51813	FL	G51814	FR	G52154	FL	G52155	FR	G52360	FL	G52361	FR
G51853	FL	G51854	FR	G52156	FL	G52157	FR	G52367	RL	G52368	RR
G51877	FL	G51878	FR	G52158	FL	G52159	FR	G52374	FL	G52375	FR
G51896	FL	G51897	FR	G52160	FL	G52161	FR	G52376	FL	G52377	FR
				G52162	RL	G52163	RR	G52382	FL	G52383	FR
				G52164	FL	G52165	FR	G52395	FL	G52396	FR
				G52168	FL	G52169	FR	G52398	FL	G52399	FR
				G52170	FL	G52171	FR	G52410	FL	G52411	FR

LEFT/RIGHT COMBINATIONS

G52435	FL	G52436	FR	G56730	FL	G56731	FR	G56822	RL	G56821	RR
G52437	FL	G52438	FR	G56732	RL	G56733	RR	G56836	FL	G56837	FR
G52439	FL	G52440	FR	G56734	RL	G56735	RR	G56840	FL	G56841	FR
G52449	FL	G52450	FR	G56750	FL	G56751	FR	G56842	FL	G56843	FR
G52494	FL	G52495	FR	G56759	FL	G56758	FR	G56882	FL	G56883	FR
G52524	FL	G52525	FR	G56773	FL	G56774	FR	G56886	FL	G56887	FR
G52906	FL	G52907	FR	G56782	FL	G56781	FR	G56888	FL	G56889	FR
G55661	RL	G55662	RR	G56785	FL	G56784	FR	G56890	FL	G56891	FR
G55675	RL	G55676	RR	G56798	FL	G56797	FR	G56892	FL	G56893	FR
G55993	FL	G55994	FR	G56800	FL	G56799	FR				
G56506	FL	G56514	FR	G56819	FL	G56820	FR	Ultra Readymounts			
G56512	RL	G56513	RR	G56822	RL	G56821	RR	G56924	RL	G56925	RR
G56516	FL	G56517	FR	G56836	FL	G56837	FR	G56930	FL	G56931	FR
G56530	FL	G56529	FR	G56840	FL	G56841	FR	G56932	RL	G56933	RR
G56532	FL	G56531	FR	G56842	FL	G56843	FR	G56934	FL	G56937	FR
G56534	RL	G56533	RR	G56886	FL	G56887	FR	G56949	RL	G56950	RR
G56538	RL	G56537	RR	G56888	FL	G56889	FR	G56956	FL	G56957	FR
G56539	FL	G56540	FR	G56892	FL	G56893	FR	G56962	FL	G56963	FR
G56554	RL	G56553	RR	G56642	FL	G56643	FR	G56973	RL	G56974	RR
G56562	FL	G56561	FR	G56661	FL	G56660	FR	G56991	FL	G56992	FR
G56570	FL	G56569	FR	G56671	FL	G56672	FR	G56993	FL	G56994	FR
G56573	FL	G56576	FR	G56677	FL	G56678	FR	G56996	FL	G56997	FR
G56582	FL	G56581	FR	G56679	FL	G56680	FR	G57007	FL	G57008	FR
G56601	FL	G56568	FR	G56683	FL	G56684	FR	G57011	FL	G57012	FR
G56615	FL	G56616	FR	G56685	FL	G56686	FR	G57030	FL	G57031	FR
G56621	FL	G56622	FR	G56687	FL	G56688	FR	G57032	RL	G57033	RR
G56634	FL	G56633	FR	G56689	FL	G56690	FR	G57034	FL	G57035	FR
G56636	FL	G56635	FR	G56721	FL	G56722	FR	G57037	FL	G57038	FR
G56637	RL	G56571	RR	G56728	RL	G56729	RR	G57041	FL	G57042	FR
G56640	RL	G56641	RR	G56730	FL	G56731	FR	G57043	RL	G57044	RR
G56641	RL	G56640	RR	G56732	RL	G56733	RR	G57045	FL	G57046	FR
G56642	FL	G56643	FR	G56734	RL	G56735	RR	G57047	FL	G57048	FR
G56661	FL	G56660	FR	G56750	FL	G56751	FR	G57049	FL	G57050	FR
G56671	FL	G56672	FR	G56759	FL	G56758	FR	G57054	FL	G57055	FR
G56677	FL	G56678	FR	G56761	FL	G56760	FR	G57057	RL	G57058	RR
G56679	FL	G56680	FR	G56773	FL	G56774	FR	G57061	RL	G57062	RR
G56683	FL	G56684	FR	G56782	FL	G56781	FR	G57063	FL	G57064	FR
G56685	FL	G56686	FR	G56785	FL	G56784	FR	G57065	FL	G57066	FR
G56687	FL	G56688	FR	G56798	FL	G56797	FR				
G56689	FL	G56690	FR	G56800	FL	G56799	FR				
G56721	FL	G56722	FR	G56813	FL	G56814	FR				
G56728	RL	G56729	RR	G56819	FL	G56820	FR				

LEFT/RIGHT COMBINATIONS

G57067	RL	G57068	RR	G57176	FL	G57177	FR	G57365	FL	G57366	FR
G57069	FL	G57070	FR	G57183	FL	G57182	FR	G57366	FL	G57365	FR
G57071	FL	G57072	FR	G57184	FL	G57185	FR	G57367	FL	G57368	FR
G57076	FL	G57077	FR	G57190	FL	G57191	FR	G57369	FL	G57370	FR
G57078	RL	G57079	RR	G57192	RL	G57193	RR	G57372	FL	G57373	FR
G57081	FL	G57082	FR	G57194	FL	G57195	FR	G57373	FL	G57372	FR
G57084	FL	G57085	FR	G57197	FL	G57198	FR	G57375	FL	G57376	FR
G57086	RL	G57087	RR	G57200	FL	G57201	FR	G57377	FL	G57378	FR
G57088	FL	G57089	FR	G57202	FL	G57203	FR	G57390	FL	G57391	FR
G57090	RL	G57091	RR	G57204	FL	G57205	FR	G57393	FL	G57394	FR
G57097	FL	G57098	FR	G57207	FL	G57208	FR	G57398	FL	G57399	FR
G57099	FL	G57100	FR	G57218	FL	G57219	FR	G57400	RL	G57401	RR
G57101	FL	G57102	FR	G57220	FL	G57221	FR	G57404	FL	G57405	FR
G57105	FL	G57106	FR	G57222	FL	G57223	FR	G57414	RL	G57415	RR
G57107	FL	G57108	FR	G57266	FL	G57267	FR	G57416	RL	G57682	RR
G57110	FL	G57111	FR	G57268	FL	G57269	FR	G57417	FL	G57418	FR
G57112	FL	G57113	FR	G57275	FL	G57276	FR	G57424	RL	G57425	RR
G57114	FL	G57115	FR	G57278	RL	G57279	RR	G57428	RL	G57429	RR
G57119	FL	G57120	FR	G57311	FL	G57312	FR	G57431	FL	G57432	FR
G57121	FL	G57122	FR	G57322	FL	G57323	FR	G57442	RL	G57441	RR
G57123	FL	G57124	FR	G57329	FL	G57330	FR	G57449	RL	G57450	RR
G57126	FL	G57127	FR	G57331	FL	G57332	FR	G57451	RL	G57452	RR
G57128	RL	G57129	RR	G57333	FL	G57334	FR	G57454	FL	G57453	FR
G57130	FL	G57131	FR	G57335	FL	G57336	FR	G57455	FL	G57456	FR
G57133	FL	G57134	FR	G57337	FL	G57338	FR	G57457	FL	G57458	FR
G57135	FL	G57136	FR	G57339	FL	G57340	FR	G57459	FL	G57460	FR
G57137	FL	G57138	FR	G57341	FL	G57342	FR	G57464	FL	G57463	FR
G57139	FL	G57140	FR	G57343	RL	G57344	RR	G57465	FL	G57466	FR
G57144	FL	G57145	FR	G57344	RL	G57343	RR	G57471	FL	G57472	FR
G57150	FL	G57151	FR	G57345	FL	G57346	FR	G57473	FL	G57474	FR
G57152	RL	G57153	RR	G57349	FL	G57350	FR	G57477	FL	G57478	FR
G57157	FL	G57158	FR	G57350	FL	G57349	FR	G57479	FL	G57480	FR
G57159	RL	G57160	RR	G57353	FL	G57354	FR	G57481	FL	G57482	FR
G57161	FL	G57162	FR	G57357	FL	G57358	FR	G57483	RL	G57484	RR
G57163	FL	G57164	FR	G57359	FL	G57360	FR	G57487	FL	G57488	FR
G57165	FL	G57166	FR	G57361	FL	G57362	FR	G57489	FL	G57490	FR
G57167	RL	G57168	RR	G57363	FL	G57364	FR	G57493	FL	G57494	FR
								G57495	FL	G57496	FR

LEFT/RIGHT COMBINATIONS

G57497	FL	G57498	FR	G57665	FL	G57666	FR	G57790	FL	G57791	FR
G57499	RL	G57500	RR	G57673	FL	G57674	FR	G57792	RL	G57793	RR
G57509	RL	G57510	RR	G57676	FL	G57677	FR	G57795	RL	G57796	RR
G57515	FL	G57516	FR	G57689	FL	G57690	FR	G57797	RL	G57798	RR
G57517	FL	G57518	FR	G57691	FL	G57692	FR	G57800	FL	G57801	FR
G57521	FL	G57522	FR	G57693	FL	G57694	FR	G57803	FL	G57804	FR
G57523	FL	G57524	FR	G57695	FL	G57696	FR	G57817	FL	G57818	FR
G57533	RL	G57534	RR	G57697	FL	G57698	FR	G57774	FL	G57775	FR
G57535	FL	G57536	FR	G57698	FL	G57699	FR	G57776	FL	G57777	FR
G57539	FL	G57540	FR	G57699	FL	G57700	FR	G57778	FL	G57779	FR
G57541	FL	G57542	FR	G57701	FL	G57702	FR	G57780	FL	G57781	FR
G57543	FL	G57544	FR	G57704	FL	G57705	FR	G57782	FL	G57783	FR
G57545	FL	G57546	FR	G57710	FL	G57711	FR	G57784	FL	G57785	FR
G57549	FL	G57550	FR	G57712	FL	G57713	FR	G57790	FL	G57791	FR
G57558	FL	G57559	FR	G57714	FL	G57715	FR	G57792	RL	G57793	RR
G57560	FL	G57561	FR	G57716	FL	G57717	FR	G57795	RL	G57796	RR
G57562	FL	G57563	FR	G57720	FL	G57721	FR	G57797	RL	G57798	RR
G57564	FL	G57565	FR	G57722	FL	G57723	FR	G57800	FL	G57801	FR
G57566	FL	G57567	FR	G57724	FL	G57725	FR	G57803	FL	G57804	FR
G57568	RL	G57569	RR	G57726	FL	G57727	FR	G57817	FL	G57818	FR
G57572	RL	G57573	RR	G57730	FL	G57731	FR	G57819	FL	G57820	FR
G57574	FL	G57575	FR	G57732	FL	G57733	FR				
G57577	FL	G57578	FR	G57734	FL	G57735	FR				
G57582	FL	G57583	FR	G57738	FL	G57739	FR				
G57586	RL	G57587	RR	G57740	FL	G57741	FR				
G57594	FL	G57595	FR	G57742	FL	G57743	FR				
G57597	RL	G57598	RR	G57744	FL	G57745	FR				
G57599	RL	G57600	RR	G57746	FL	G57747	FR				
G57601	FL	G57602	FR	G57749	FL	G57825	FR				
G57603	FL	G57604	FR	G57750	FL	G57751	FR				
G57605	FL	G57606	FR	G57752	FL	G57753	FR				
G57608	FL	G57609	FR	G57754	FL	G57755	FR				
G57612	RL	G57613	RR	G57756	FL	G57757	FR				
G57614	FL	G57615	FR	G57758	FL	G57759	FR				
G57628	FL	G57629	FR	G57764	FL	G57765	FR				
G57634	RL	G57635	RR	G57768	FL	G57769	FR				
G57640	FL	G57641	FR	G57772	FL	G57773	FR				
G57642	RL	G57643	RR	G57774	FL	G57775	FR				
G57644	FL	G57645	FR	G57776	FL	G57777	FR				
G57648	FL	G57649	FR	G57778	FL	G57779	FR				
G57650	RL	G57651	RR	G57780	FL	G57781	FR				
G57658	RL	G57659	RR	G57782	FL	G57783	FR				
G57663	FL	G57664	FR	G57784	FL	G57785	FR				

Guardian Struts

M55913	FL	M55912	FR
M55920	FL	M55921	FR
M56506	FL	M56514	FR
M56516	FL	M56517	FR
M56559	FL	M56558	FR
M56621	FL	M56622	FR
M55977	RL	M55976	RR
M56506	FL	M56514	FR
M56516	FL	M56517	FR
M56559	FL	M56558	FR
M56621	FL	M56622	FR
M56739	FL	M56736	FR
M56930	FL	M56931	FR

EXPLANATION OF SPECIFICATIONS

Part Number:	The catalog number for the individual shock absorber.
Extended Length*:	The length of the shock absorber when it is fully extended. See "How to Measure" instructions.
Collapsed Length*:	The length of the shock absorber when it is fully collapsed. See "How to Measure" instructions.
Stroke:	This is the approximate length of the stroke of the individual shock absorber being described.
Mounting Codes:	Indicates the type of mounting ends for the upper and lower end of each shock absorber. They are listed as follows: Top mounts ("TM") Eye ring and bushing with sleeve mounts ("ES") Stud type mounts ("S" & "DS") Eye ring and bushing with bar pin mounts ("BP") Special mounting codes ("SP") Eye ring and bushing mounts ("EB") Clevis mounts ("CL") Pinch socket mounts ("LP") U joint mounts ("LU")

CONVERSION CHART

Fraction (Inches)	Decimal (Inches)	Metric (MM)	Fraction (Inches)	Decimal (Inches)	Metric (MM)
1/64	0.016	0.397	33/64	0.516	13.097
1/32	0.031	0.794	17/32	0.531	13.494
3/64	0.047	1.191	35/64	0.547	13.891
1/16	0.063	1.588	9/16	0.563	14.288
5/64	0.078	1.984	37/64	0.578	14.684
3/32	0.094	2.381	19/32	0.594	15.081
7/64	0.109	2.778	39/64	0.609	15.478
1/8	0.125	3.175	5/8	0.625	15.875
9/64	0.141	3.572	41/64	0.641	16.272
5/32	0.156	3.969	21/32	0.656	16.669
11/64	0.172	4.366	43/64	0.672	17.066
3/16	0.188	4.763	11/16	0.688	17.463
13/64	0.203	5.159	45/64	0.703	17.859
7/32	0.219	5.556	23/32	0.719	18.256
15/64	0.234	5.953	47/64	0.734	18.653
1/4	0.250	6.350	3/4	0.750	19.050
17/64	0.266	6.747	49/64	0.766	19.447
9/32	0.281	7.144	25/32	0.781	19.844
19/64	0.297	7.541	51/64	0.797	20.241
5/16	0.313	7.938	13/16	0.813	20.638
21/64	0.328	8.334	53/64	0.828	21.034
11/32	0.344	8.731	27/32	0.844	21.431
23/64	0.359	9.128	55/64	0.859	21.828
3/8	0.375	9.525	7/8	0.875	22.225
25/64	0.391	9.922	57/64	0.891	22.622
13/32	0.406	10.319	29/32	0.906	23.019
27/64	0.422	10.716	59/64	0.922	23.416
7/16	0.438	11.113	15/16	0.938	23.813
29/64	0.453	11.509	61/64	0.953	24.209
15/32	0.469	11.906	31/32	0.969	24.606
31/64	0.484	12.303	63/64	0.984	25.003
1/2	0.500	12.700	1	1.000	25.400

METRIC CONVERSION CHART

MILLIMETERS	INCHES	MILLIMETERS	INCHES	MILLIMETERS	INCHES
1	0.03937	10	0.39370	19	0.74803
2	0.07874	11	0.43307	20	0.78740
3	0.11811	12	0.47244	21	0.82677
4	0.15748	13	0.51181	22	0.86614
5	0.19685	14	0.55118	23	0.90551
6	0.23622	15	0.59055	24	0.94488
7	0.27559	16	0.62992	25	0.98425
8	0.31496	17	0.66929		
9	0.35433	18	0.70866		

HOW TO MEASURE EXTENDED & COLLAPSED LENGTHS OF SHOCK ABSORBERS

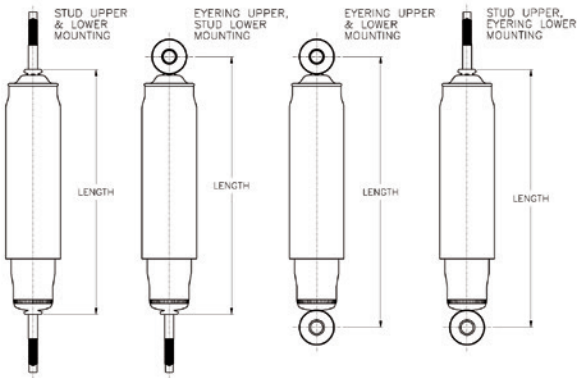

Instructions

1. Using the proper measuring points as shown above find the nearest replacement shock absorber from the listing increments of extended length.
2. Identify the proper mounting form the mounting codes and match these requirements by carefully measuring the mounting dimensions (top and bottom) of the shock absorber to be replaced.
3. Carefully take note of the following requirements:
 - a. **Mounting Accessories** - Contents and descriptions of parts are shown in this manual.
 - b. **Dust tubes** - This requirement should be noted in comparison with the shock absorber to be replaced. Shock absorber environment in its application makes this requirement necessary for piston rod protection and extended shock absorber life.
 - c. **Recoil Cutoff and Compression Bumper** - Carefully note these specifications- deviation of length requirements should not exceed $\pm 1/2$ ". These shock absorber designs are footnoted for easy identification.
 - d. **Limited Environment Application** - Most conventional shock absorbers are offered in "straight" construction to fit limited environment applications. These shock absorber designs are footnoted.

SHOCK ABSORBER DIAMETERS

Shown below are measuring points for diameters by type of shock absorber. Refer to the chart below which lists diameters for the various bore sizes available for each type.

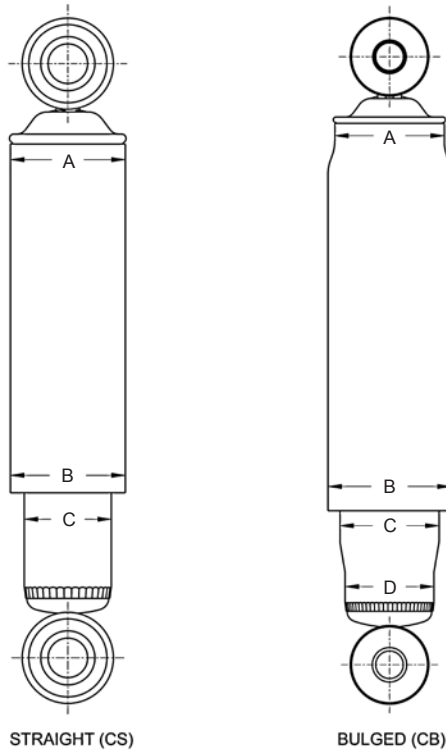

BORE SIZE	SHOCK ABSORBERS	TYPE (Shown Above)	Diameters			
			A	B	C	D
1 3/16"	Classic, Guardian, Ultra Pass. Car	CS	2.06	2.00	1.63	NA
1 3/16"	Classic, Guardian, Ultra Pass. Car	CB	2.06	2.19	1.81	1.63
1 3/8"	Ultra Truck	CS	NA	2.37	2.00	NA
1 3/8"	Ultra Truck	CB	2.37	2.50	2.19	2.00

MOUNTING CODE “TM” TOP MOUNT

T M # # # #

1st & 2nd digit - “Top Mount”

3rd digit - Part type/shape from the five categories listed below

4th digit - Number of studs / bolts (the amount of mounting points to the vehicle (see example below)

5th digit - Design of the mounting point - Stud (S) Bolt (B) Clip (C) (see example below)

TOP MOUNT DESIGN SHAPES



EXAMPLES

The fourth digit will note how many mounting points to the vehicle body exist.
 The final digits indicate the type of mounting point **Stud (S) Bolt (B) Clip(C)**
 (a combination is used for multiple mounting points)

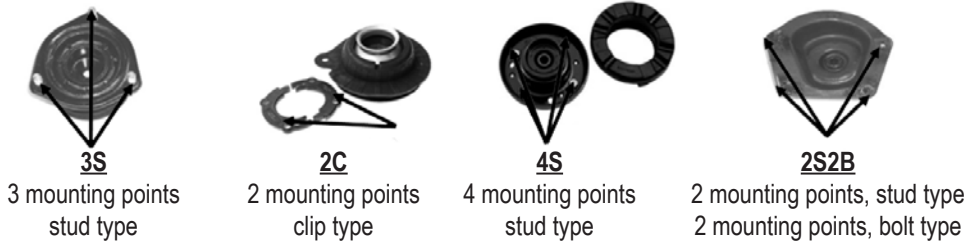

TOP MOUNT CODE	TOP MOUNT DESIGN	MOUNTING TYPE
TMC0	Circle	
TMC2B	Circle	2 Bolt
TMC2S	Circle	2 Stud
TMC2S1B	Circle	2 Stud, 1 Bolt
TMC3B	Circle	3 Bolt
TMC3S	Circle	3 Stud
TMC4B	Circle	4 Bolt
TMC4S	Circle	4 Stud
TMC5S	Circle	5 Stud
TMO2B	Oval	2 Bolt
TMO2S	Oval	2 Stud
TMO3S	Oval	3 Stud
TMO4B	Oval	4 Bolt
TMR2S	Rectangle	2 Stud
TMR3S	Rectangle	3 Stud
TMR4S	Rectangle	4 Stud
TMS3S	Square	3 Stud

TOP MOUNT CODE	TOP MOUNT DESIGN	MOUNTING TYPE
TMS3S1B	Square	3 Stud 1 Bolt
TMS4S	Square	4 Stud
TMT3B	Triangle	3 Bolt
TMT3S	Triangle	3 Stud
TMU2B	Unique	2 bolt
TMU2B1S	Unique	2 Bolt, 1 Stud
TMU2S	Unique	2 Stud
TMU2S1B	Unique	2 Stud, 1 Bolt
TMU2S2B	Unique	2 Stud, 2 Bolt
TMU3B	Unique	3 Bolt
TMU3B1S	Unique	3 Bolt, 1 Stud
TMU3S	Unique	3 Stud
TMU3S1B	Unique	3 Stud 1 Bolt
TMU4B	Unique	4 Bolt
TMU4S	Unique	4 Stud
TMU5S	Unique	5 Stud

MOUNTING CODE "ES" EYE RING AND BUSHING WITH STEEL SLEEVE

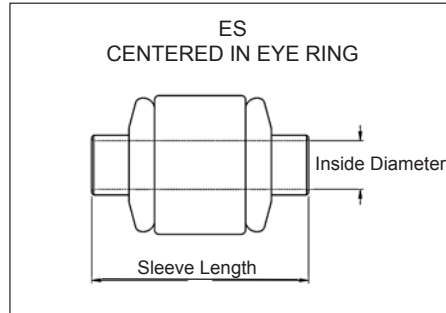

MOUNTING CODE	DIMENSION			
	Inside Diameter		Sleeve Length	
	(inches)	(mm)	(inches)	(mm)
ES3	0.39	10.00	1.56	39.62
ES7	0.56	14.29	1.25	31.75
ES9	0.44	11.11	1.31	33.27
ES10	0.44	11.11	1.38	35.05
ES13	0.56	14.29	1.89	48.01
ES17	0.47	12.00	1.25	31.75
ES18	0.47	12.00	1.65	41.91
ES19	0.47	12.00	1.88	47.75
ES20	0.47	12.00	1.95	49.53
ES22	0.50	12.70	1.25	31.75
ES24	0.50	12.70	1.38	35.05
ES25	0.50	12.70	1.50	38.10
ES26	0.50	12.70	1.56	39.62
ES27	0.50	12.70	1.62	41.15
ES29	0.39	10.00	2.95	74.93
ES30	0.47	12.00	2.57	65.28
ES31*	0.50	12.70	2.25	57.15
ES34	0.56	14.29	1.66	42.16
ES35	0.63	15.88	1.38	35.05
ES36	0.75	19.05	1.75	44.45
ES41	0.47	12.00	3.48	88.39
ES42	0.47	12.00	3.77	95.76
ES45	0.51	13.00	1.68	42.67
ES47	0.51	13.00	2.50	63.50
ES48	0.55	14.00	1.42	36.07
ES49	0.55	14.00	1.66	42.16
ES51	0.55	14.00	1.89	48.01
ES53	0.39	10.00	1.38	35.05
ES56	0.55	14.00	1.58	40.13
ES61	0.47	12.00	1.76	44.70
ES64	0.63	16.00	1.25	31.75
ES65	0.47	12.00	1.38	35.05
ES66	0.63	16.00	1.38	35.05
ES67	0.63	16.00	1.56	39.62
ES69	0.47	12.00	1.58	40.13
ES75	0.63	16.00	2.04	51.82
ES82	0.48	12.30	1.53	38.86
ES83	0.47	12.00	1.48	37.59
ES84	0.39	10.00	1.62	41.15
ES85	0.47	12.00	2.36	59.94
ES86	0.55	14.00	2.44	61.98
ES87	0.48	12.30	1.65	41.91
ES88	0.47	12.00	1.81	45.97
ES90	0.63	15.88	2.00	50.80
ES99	0.55	14.00	1.42	36.07
ES110	0.63	16.00	1.61	40.89
ES115	0.39	10.00	2.02	51.31
ES120	0.75	19.05	2.76	70.10
ES126	0.50	12.70	2.44	61.98
ES128	0.50	12.70	1.66	42.16
ES136	0.63	15.88	1.75	44.45
ES141	0.47	12.00	1.61	40.89
ES145	0.44	11.11	2.25	57.15
ES147	0.47	12.00	1.97	50.04
ES149	0.50	12.70	2.36	59.94
ES150	0.75	19.05	2.24	56.90

MOUNTING CODE	DIMENSION			
	Inside Diameter		Sleeve Length	
	(inches)	(mm)	(inches)	(mm)
ES152	0.79	20.00	1.69	42.93
ES153	0.55	14.00	1.55	39.37
ES158	0.75	19.05	3.80	96.52
ES160	1.00	25.40	2.01	51.05
ES161	0.63	16.00	3.95	100.33
ES162	0.63	16.00	2.60	66.04
ES163	0.44	11.11	2.50	63.50
ES164	0.50	12.70	2.26	57.40
ES166	0.63	15.88	2.97	75.44
ES167	0.55	14.00	2.31	58.67
ES168	0.55	14.00	2.62	66.55
ES171	0.50	12.70	1.88	47.75
ES173	0.88	22.23	2.28	57.91
ES174	0.63	15.88	3.25	82.55
ES175	0.63	16.00	1.96	49.78
ES176	0.63	16.00	3.72	94.49
ES177	0.63	16.00	3.55	90.17
ES178	0.75	19.05	1.96	49.78
ES179	0.79	20.00	1.75	44.45
ES182	0.79	20.00	1.96	49.78
ES183	0.79	20.00	3.80	96.52
ES185	0.47	12.00	2.44	61.98
ES187	1.00	25.40	1.75	44.45
ES188	0.63	16.00	1.81	45.97
ES190	0.87	22.00	1.75	44.45
ES194	0.88	22.23	2.28	57.91
ES201	0.57	14.40	1.94	49.28
ES206	0.50	12.70	3.13	79.50
ES210	0.73	18.50	1.87	47.50
ES216	0.57	14.50	3.15	80.00

* 1" / 25.4mm Offset

“S” STUD MOUNT

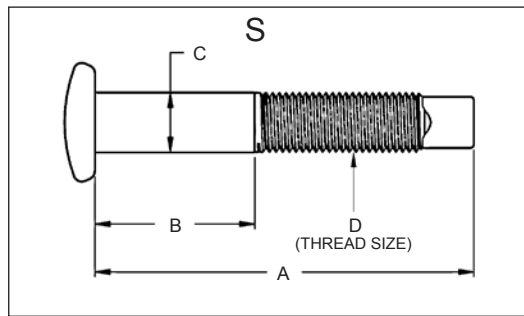

MOUNTING CODE	DIMENSION						
	A		B		C		D
	(inches)	(mm)	(inches)	(mm)	(inches)	(mm)	(thread)
S1	2.37	60.20	1.00	25.40	0.38	9.53	3/8-24
S2	2.06	52.32	1.00	25.40	0.38	9.53	3/8-24
S3	2.67	67.82	1.37	34.80	0.39	10.00	3/8-16
S4	1.85	46.99	1.00	25.40	0.38	9.53	3/8-24
S5	1.29	32.77	1.14	28.96	0.51	13.00	3/8-24
S8	1.75	44.45	1.00	25.40	0.39	10.00	3/8-24
S9	1.84	46.74	1.05	26.67	0.44	11.11	3/8-24
S10	2.37	60.20	1.33	33.78	0.44	11.11	3/8-24
S11	3.00	76.20	1.12	28.45	0.38	9.53	3/8-24
S12	2.37	60.20	1.15	29.21	0.44	11.11	3/8-24
S15	3.29	83.57	1.98	50.29	0.38	9.53	3/8-24
S16	2.95	74.93	1.45	36.83	0.63	16.00	M16x1.5
S17	2.15	54.61	1.03	26.16	0.44	11.11	3/8-24
S18	2.67	67.82	1.81	45.97	0.39	10.00	M10x1.25
S19	1.34	34.04	0.41	10.41	0.44	11.11	M10x1
S20	1.34	34.04	0.41	10.41	0.39	10.00	M10x1
S21	3.28	83.31	1.75	44.45	0.63	15.88	5/8-18
S22	0.75	19.05	0.35	8.89	0.39	10.00	M10x1
S25	1.81	45.97	1.50	38.10	0.38	9.53	M10x1
S26	2.02	51.31	0.82	20.83	0.47	12.00	M10x1
S27	2.36	59.94	1.14	28.96	0.39	10.00	M10x1
S29	2.99	75.95	1.87	47.50	0.38	9.53	3/8-24
S30	2.59	65.79	1.41	35.81	0.39	10.00	M10x1
S32	2.31	58.67	1.38	35.05	0.55	14.00	M12x1.25
S33	3.44	87.38	2.17	55.12	0.39	10.00	M10x1
S34	1.06	26.92	0.59	14.99	0.31	7.94	M8x1.25
S36	2.49	63.25	1.33	33.78	0.44	11.11	3/8-24
S37	3.18	80.77	1.41	35.81	0.47	12.00	M10x1
S38	2.75	69.85	1.70	43.18	0.55	14.00	M12x1.25
S40	2.52	64.01	1.33	33.78	0.44	11.11	3/8-24
S42	3.50	88.90	2.00	50.80	0.63	15.88	5/8-18
S43	2.75	69.85	1.25	31.75	0.63	15.88	5/8-18
S44	1.57	39.88	0.39	9.91	0.39	10.00	M10x1.25
S45	2.36	59.94	1.00	25.40	0.39	10.00	M10x1.25
S46	1.57	39.88	1.18	29.97	0.39	10.00	M10x1.25
S47	2.20	55.88	1.31	33.27	0.39	10.00	M10x1.25
S48	2.55	64.77	1.51	38.35	0.39	10.00	M10x1.25
S49	2.67	67.82	1.29	32.77	0.39	10.00	M10x1.25
S50	2.95	74.93	1.57	39.88	0.39	10.00	M10x1.25
S51	3.00	76.20	1.65	41.91	0.39	10.00	M10x1.25
S52	1.18	29.97	0.74	18.80	0.39	10.00	M10x1.5
S53	2.16	54.86	1.89	48.01	0.39	10.00	M10x1.5
S54	2.42	61.47	1.28	32.51	0.59	15.00	M10x1.5
S55	2.51	63.75	1.39	35.31	0.39	10.00	M10x1.5
S56	2.67	67.82	1.53	38.86	0.43	11.00	M10x1.5
S57	2.95	74.93	1.40	35.56	0.42	10.72	M10x1.5
S58	2.98	75.69	1.68	42.67	0.39	10.00	M10x1.5
S59	2.98	75.69	1.68	42.67	0.47	12.00	M10x1.5
S60	3.46	87.88	1.96	49.78	0.56	14.29	M10x1.5
S61	3.11	78.99	1.45	36.83	0.55	14.00	M12x1.25
S62	3.24	82.30	1.70	43.18	0.56	14.29	M12x1.25
S63	3.54	89.92	2.24	56.90	0.67	17.00	M12x1.25
S64	2.36	59.94	1.18	29.97	0.47	12.00	M12x1.5
S65	2.89	73.41	1.65	41.91	0.47	12.00	M12x1.5
S66	1.39	35.31	0.15	3.81	0.47	12.00	M12x1.75
S67	2.40	60.96	1.53	38.86	0.56	14.29	M14x1.5

“S” STUD MOUNTS CONT'D

MOUNTING CODE	DIMENSION						
	A		B		C		D
	(inches)	(mm)	(inches)	(mm)	(inches)	(mm)	(thread)
S68	2.95	74.93	1.45	36.83	0.63	15.88	M16x1.5
S69	1.32	33.53	1.37	34.80	0.61	15.48	M16x2
S70	1.88	47.75	0.90	22.86	0.44	11.11	M8x1.25
S71	1.42	36.07	0.71	18.03	0.39	10.00	M10x1.5
S74	2.66	67.50	1.24	31.50	0.39	10.00	M10x1
S75	1.57	40.00	0.47	12.00	0.39	10.00	M10x1.25
S80	1.18	30.00	0.39	10.01	0.47	12.00	M12x1.25
S81	2.80	71.12	1.53	38.89	0.47	12.00	M12x1.25
S82	3.70	94.00	1.54	39.00	0.39	10.00	M10x1.5
S83	3.17	80.52	2.14	54.36	0.39	10.00	M10x1.25
S84	1.18	30.00	0.20	5.00	0.47	12.00	M12x1.5
S85	3.35	85.00	1.85	47.00	0.43	11.00	M10x1
S86	2.90	73.66	1.65	41.91	0.39	10.00	M10x1.25
S87	3.21	81.53	2.09	53.06	0.39	10.00	M10x1.25
S88	2.55	64.64	1.30	33.02	0.47	12.00	M12x1.25
S89	3.35	85.09	2.18	55.25	0.39	10.00	M10x1.25
S90	3.08	78.23	2.00	50.70	0.39	10.00	M10x1.25
S91	1.20	30.50	0.79	20.00	0.39	10.00	M10x1.25
S92	1.42	35.99	0.63	16.00	0.41	10.50	M12x1.25
S95	2.52	64.00	1.34	34.00	0.47	12.00	M12x1.25
S96	2.56	65.00	0.98	25.00	0.39	10.00	M10x1.25
S97	1.50	38.00	0.51	13.00	0.47	12.00	M12x1.75
S98	2.72	69.00	1.34	34.00	0.47	12.00	M12x1.5
S99	3.07	78.00	1.61	41.00	0.47	12.00	M10x1
S100	1.89	48.00	1.38	35.00	0.47	12.00	M12x1.25
S101	1.77	45.00	1.22	31.00	0.39	10.00	M10x1.5
S102	2.72	69.20	1.18	30.00	0.55	14.00	M10X1.25
S103	1.50	38.00	0.59	15.00	0.55	14.00	M14X1.5
S104	0.98	25.00	0.08	2.00	0.47	12.00	M12X1.25
s105	2.19	55.50	1.02	26.00	0.55	14.00	M14x2
S106	1.54	39.00	1.22	31.00	0.55	14.00	M14X2
S107	2.36	60.00	1.30	33.00	0.67	17.00	M16X2
S108	1.69	43.00	1.46	37.00	0.87	22.00	M14X2
S109	1.93	49.00	0.63	16.00	0.55	14.00	M12X1.5
S110	1.10	28.00	0.08	2.00	0.87	22.00	M14X1.5
S111	2.72	69.09	1.26	32.00	0.87	22.00	M14x2
S112	2.73	69.27	1.47	37.21	0.87	22.00	M14x1.5
S113	3.30	83.82	0.20	5.08	0.87	22.00	M15x2.00
S114	1.38	35.00	0.01	0.35	0.87	22.00	M14x1.5
S115	3.96	100.48	1.47	37.26	0.79	20.00	M12x1.75
S116	1.71	43.51	0.85	21.49	0.87	22.00	M14x1.5
S117	1.16	29.36	0.84	21.34	0.79	20.00	M14x2
S118	2.08	52.76	1.78	45.26	0.79	20.00	M12X1.75
S118	3.40	86.36	3.15	80.01	0.87	22.00	M16x2
S119	2.95	74.93	1.38	35.00	0.98	25.00	M16X2
S120	2.05	52.00	1.10	28.00	0.47	12.00	M12X1.25
S121	1.46	37.00	1.34	34.00	0.87	22.00	M14x1.25
S122	3.05	77.50	1.26	32.00	0.63	16.00	M14x1.5

MOUNTING CODE "BP" EYE RING AND BUSHING WITH BAR PIN

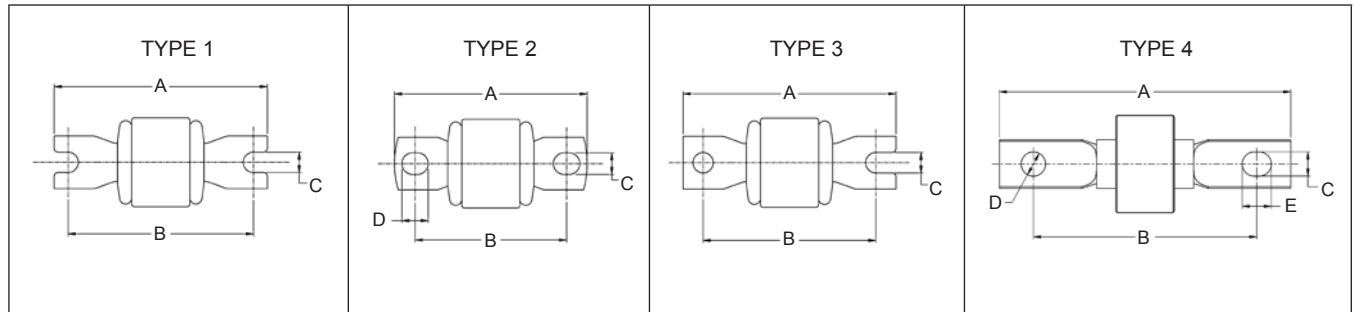

MOUNTING CODE	TYPE	DIMENSION									
		A		B		C		D		E	
		(inches)	(mm)	(inches)	(mm)	(inches)	(mm)	(inches)	(mm)	(inches)	(mm)
BP4	1	3.19	81.03	2.38	60.45	0.33	8.38	--	--	--	--
BP6	1	4.25	107.95	3.62	91.95	0.33	8.38	--	--	--	--
BP7	2	3.13	79.50	2.50	63.50	0.35	8.89	0.42	10.67	--	--
BP8	2	3.50	88.90	2.87	72.90	0.35	8.89	0.42	10.67	--	--
BP10	2	3.50	88.90	2.74	69.60	0.50	12.70	0.50	12.70	--	--
BP12	1	3.75	95.25	3.14	79.76	0.33	8.38	--	--	--	--
BP13	1	3.45	87.63	3.00	76.20	0.33	8.38	--	--	--	--
BP14	2	3.43	87.12	2.87	72.90	0.45	11.43	--	--	--	--
BP15	4	4.56	115.82	3.62	91.95	0.39	9.91	0.47	11.94	0.39	9.91
BP18	1	3.75	95.25	3.14	79.76	0.39	9.91	--	--	--	--
BP19	1	3.19	81.03	2.62	66.55	0.33	8.38	--	--	--	--
BP20	1	3.59	91.19	3.12	79.25	0.33	8.38	--	--	--	--
BP27	2	4.00	101.60	2.95	74.93	0.52	13.21	0.50	12.70	--	--
BP31	3	3.50	88.90	2.87	72.90	0.35	8.89	--	--	--	--
BP34	1	3.81	96.77	2.99	75.95	0.41	10.41	--	--	--	--
BP36	2	4.72	119.89	3.38	85.85	0.52	13.21	0.52	13.21	--	--

MOUNTING CODE "SP" SPECIAL MOUNTS

Part numbers with "SP" mounting codes are unique to the application. Please reference the specific OE or Gabriel part for dimensions. If you have any further questions or concerns, contact the Gabriel® Answerman at 1.800.999.3903.

MOUNTING CODE "EB" EYE RING AND BUSHING

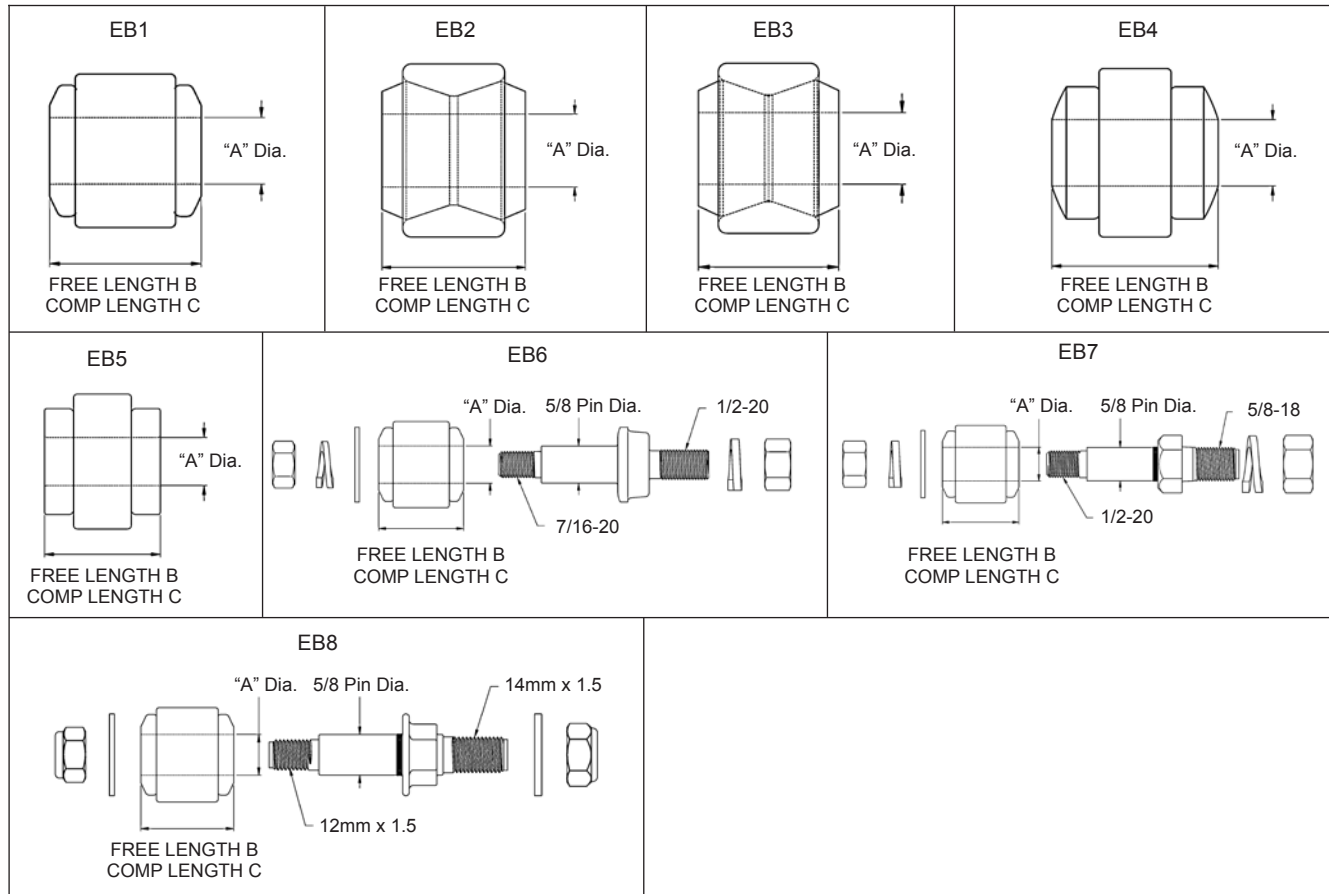

MOUNTING CODE	A DIAMETER	B FREE LENGTH	C COMP. LENGTH	VEHICLE MOUNTING PIN DIAMETER
EB1	5/8	1.44	1.31	5/8
EB2	3/4	1.75	1.50	3/4
EB3	1.00	1.91	1.75	1.00
EB4	11/16	1.72	1.55	11/16
EB5	5/8	1.51	1.25	5/8
EB16	16MM	1.5	--	16MM
EB19	20MM	1.75	1.25	20MM

MOUNTING CODE "CL" CLEVIS

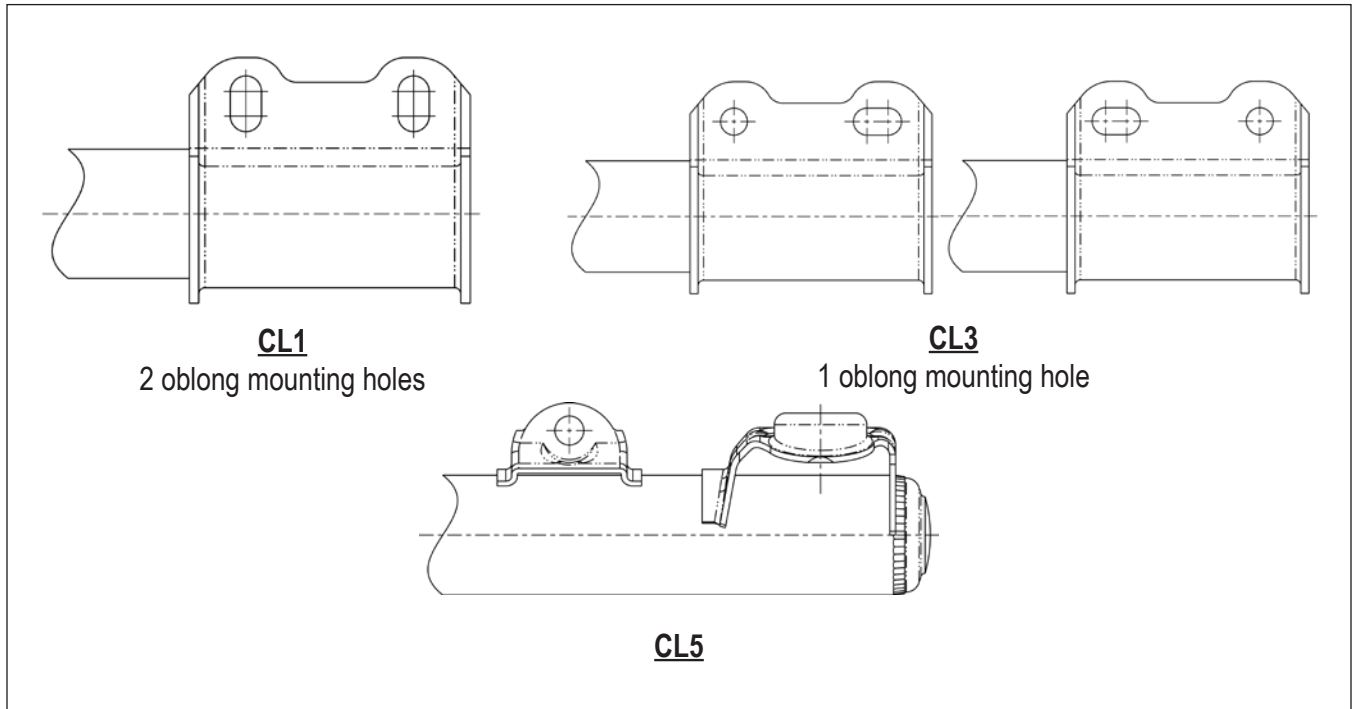

MOUNTING CODE "LP" PINCH SOCKET

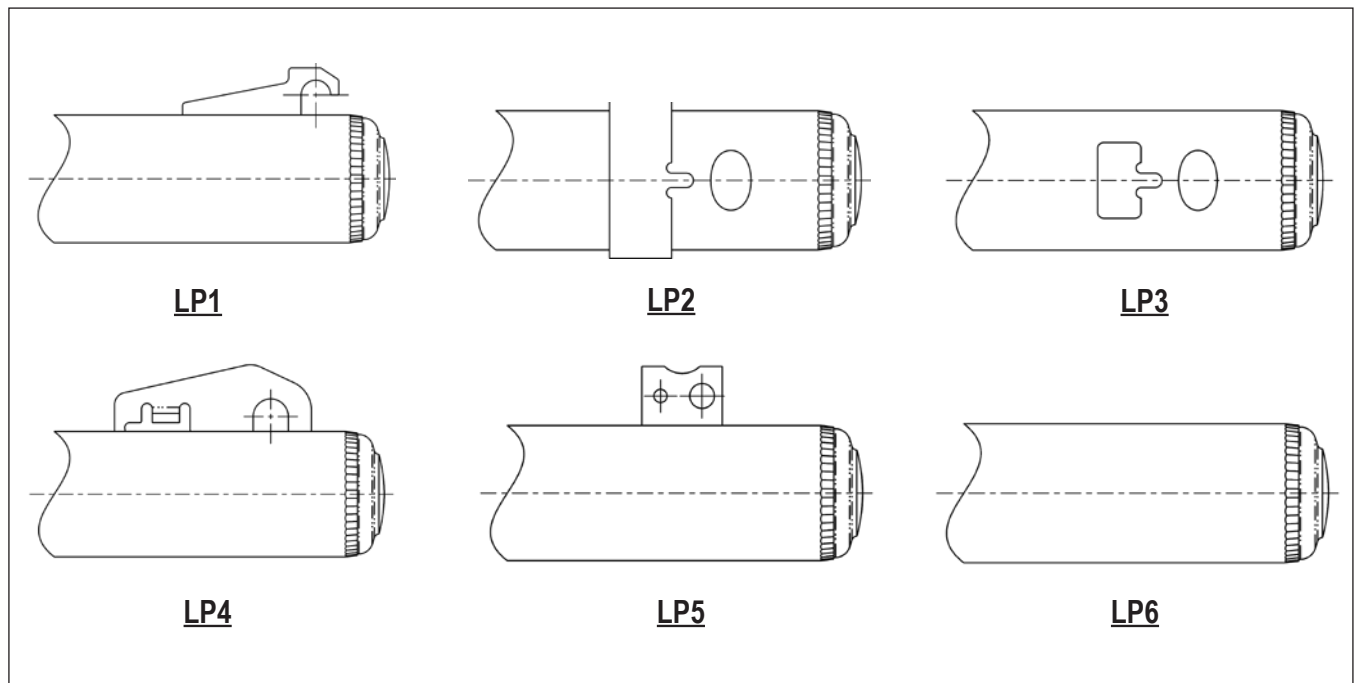

MOUNTING CODE "LU" U JOINT

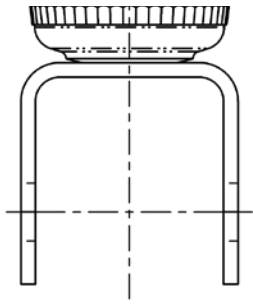

LU1

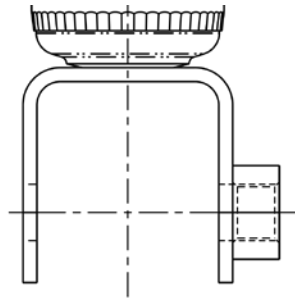
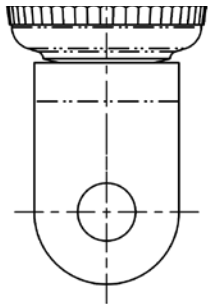

LU2

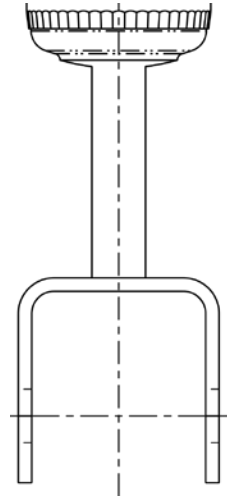
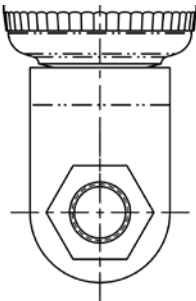

LU3

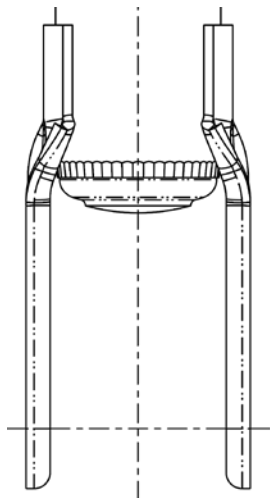
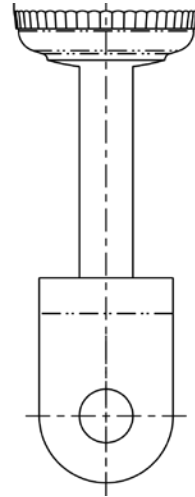

LU4

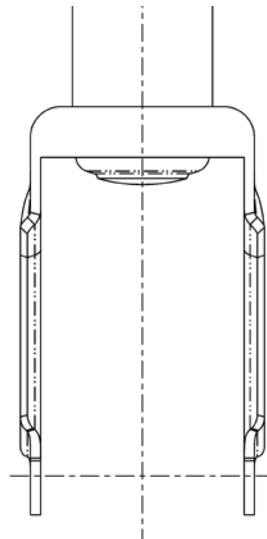
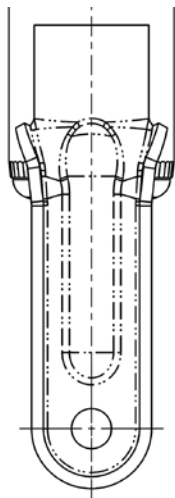

LU5

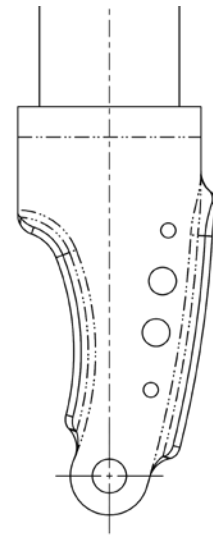

SPECIFICATIONS BY PART NUMBER

AXLE SHAFT DAMPER

CATALOG PART NO.	EXTENDED LENGTH	COLLAPSED LENGTH	STROKE	UPPER MTG CODE	LOWER MTG CODE
14039	15.73	12.12	3.51	ES41	ES41

CLASSIC SHOCK ABSORBERS

CATALOG PART NO.	EXTENDED LENGTH	COLLAPSED LENGTH	STROKE	UPPER MTG CODE	LOWER MTG CODE	CATALOG PART NO.	EXTENDED LENGTH	COLLAPSED LENGTH	STROKE	UPPER MTG CODE	LOWER MTG CODE
82001	15.98	10.37	5.61	ES17	ES17	82090	16.11	10	6.11	S1	ES8
82003	18.55	11.44	7.11	ES24	ES24	82093	21.23	12.87	8.36	BP31	ES10
82004	14.17	8.81	5.36	S17	S1	82099	14.09	9.06	5.11	S1	BP19
82005	17.2	12.44	4.76	S1	ES64	82103	22.7	13.34	9.36	ES145	S1
82007	18.23	11.37	6.86	EB1	EB1	82104	14.2	9.44	4.76	BP19	DS1
82010	16.63	12.47	4.16	ES34	ES34	82109	13.64	8.74	4.90	S1	ES32
82011	12.11	8	4.11	S1	ES11	82110	14.1	8.99	5.11	S1	BP8
82012	16.04	10.53	5.51	BP6	ES25	82118	15.24	10.16	5.25	S5	BP19
82025	12.95	9.19	3.76	S36	BP17	82125	20.67	12.06	8.61	S8	S1
82026	13.42	8.56	4.86	S1	S1	82126	14.25	9.24	5.01	S36	DS1
82032	22.73	13.87	8.86	ES64	ES64	82128	11.2	8.19	3.01	S36	ES40
82034	22.17	12.81	9.36	S1	S1	82130	17.7	10.84	6.86	EB1	S36
82035	14.64	9.53	5.11	ES24	EB1	82131	22.39	13.53	8.86	ES27	EB4
82039	17.7	10.84	6.86	S1	EB1	82138	15.1	9.49	5.61	S1	BP3
82040	21.7	12.84	8.86	S1	ES10	82147	23.23	13.87	9.36	EB1	ES25
82047	20.23	12.37	7.86	EB1	EB1	82151	23.23	13.87	9.36	ES145	ES70
82051	22.14	13.28	8.86	BP8	EB1	82155	20.7	12.34	8.36	S1	EB1
82060	23.23	13.87	9.36	EB1	EB1	82156	20.23	12.37	7.86	EB1	EB1
82065	19.04	11.93	7.11	EB4	EB4	82601	13.61	8.75	4.86	S1	ES16
82066	22.7	13.34	9.36	S1	EB1	82602	23.23	13.87	9.36	BP8	EB1
82069	14.59	9.31	5.28	S1	S1	82609	25.64	15.03	10.61	EB1	ES35
82070	15.75	9.99	5.76	S1	DS1	82615	15.69	10.43	5.26	EB4	BP11
82072	11.61	7.75	3.86	S1	ES8	82618	25.73	15.12	10.61	BP14	EB1
82075	16.1	10.34	5.76	S1	BP10	82609	25.64	15.03	10.61	EB1	ES35
82076	18.7	11.34	7.36	ES66	S1	82614	12.01	8.25	3.76	S12	ES5
82079	15.54	9.93	5.61	ES9	BP20	82615	15.69	10.43	5.26	EB4	BP11
82086	25.54	14.93	10.61	ES35	ES35	82618	25.73	15.12	10.61	BP14	EB1
82087	14.61	9.25	5.36	S1	BP20						

FRONT LOAD CARRIERS

CATALOG PART NO.	EXTENDED LENGTH	COLLAPSED LENGTH	STROKE	UPPER MTG CODE	LOWER MTG CODE	CATALOG PART NO.	EXTENDED LENGTH	COLLAPSED LENGTH	STROKE	UPPER MTG CODE	LOWER MTG CODE
34036	14.16	9.53	4.63	EB1	ES24	34058	17.13	11.01	n/a	S12	ES3
34051	13.28	8.67	4.61	S1	BP30	34073	14.29	9.37	4.92	S1	BP7
34052	13.62	9	4.62	S1	BP13	34076	14.59	9.87	n/a	S36	EB1
34057	15.01	10.13	4.87	S12	E83						

SPECIFICATIONS BY PART NUMBER

GUARDIAN SHOCKS

CATALOG PART NO.	EXTENDED LENGTH	COLLAPSED LENGTH	STROKE	UPPER MTG CODE	LOWER MTG CODE	CATALOG PART NO.	EXTENDED LENGTH	COLLAPSED LENGTH	STROKE	UPPER MTG CODE	LOWER MTG CODE
81039	14.73	9.62	5.11	EB1	ES24	81540	25.73	15.12	10.61	EB1	ES106
81076	14.2	9.44	4.76	BP4	DS1	81541	14.7	9.34	5.36	S1	BP14
81082	23.23	13.87	9.36	EB1	ES83	81548	20.6	12.59	8.01	S1	BP7
81091	25.14	15.28	9.86	ES27	EB4	81549	20.73	12.62	8.11	BP20	EB1
81095	21.7	12.84	8.86	BP14	S1	81553	15.2	9.59	5.61	S1	ES64
81096	13.7	8.84	4.86	S1	BP13	81559	13.2	8.59	4.61	S1	BP7
81113	18.23	11.37	6.86	ES31	ES24	81560	23.14	13.78	9.36	BP13	ES27
81147	20.23	12.37	7.86	EB1	EB1	81581	22.54	13.68	8.86	ES141	ES141
81153	11.61	7.75	3.86	S1	ES38	81582	13.45	8.84	4.61	S1	BP4
81164	23.23	13.87	9.36	EB1	ES34	81583	18.39	11.53	6.86	EB5	ES25
81242	19.2	11.59	7.61	S1	ES25	81667	26.95	16.19	10.76	BP14	ES34
81270	17.67	10.56	7.11	S1	S1	81668	14.32	9.56	4.76	S29	BP11
81318	22.73	13.87	8.86	EB1	EB1	81675	15.7	9.84	5.86	S1	EB1
81340	20.7	12.34	8.36	S1	EB1	81676	17.73	11.12	6.61	EB1	EB1
81342	28.89	16.78	12.11	ES27	EB4	81691	24.2	14.09	10.11	S1	ES25
81394	17.47	11.21	6.26	S36	ES25	81694	14.72	9.71	5.01	S36	ES25
81416	18.6	11.59	7.01	S9	EB1	81710	21.73	13.12	8.61	EB1	ES185
81440	24.6	14.59	10.01	S17	EB1	81713	14.42	9.31	5.11	S29	BP7
81446	14.61	9.25	5.36	S1	BP7	81726	16.48	10.87	5.61	ES126	ES128
81459	21.73	13.37	8.36	ES84	ES84	81730	23.23	13.87	9.36	EB1	ES185
81469	22.54	13.68	8.86	EB4	EB4	81744	14.52	9.76	4.76	S36	EB1
81478	12.6	8.59	4.01	S1	ES64	81750	13.61	8.75	4.86	S1	BP30
81481	19.7	11.84	7.86	S1	EB1	81790	18.92	11.56	7.36	S29	ES24
81482	24.23	14.37	9.86	BP14	ES34	81794	19.85	14.19	5.66	S1	ES185
81484	20.23	12.37	7.86	EB1	ES25	81821	23.23	13.87	9.36	ES83	ES83
81490	14.85	9.84	5.01	S12	ES83	81823	25.73	15.12	10.61	BP14	ES83
81491	13	8.74	4.26	S12	DS1	81825	21.1	12.99	8.11	EB4	EB4
81492	20.64	12.78	7.86	BP31	EB1	81828	22.72	14.21	8.51	S36	ES83
81494	13.61	8.75	4.86	S1	BP30	81833	20.21	12.45	7.76	S36	ES83
81495	20.2	12.34	7.86	S1	EB1	81834	15.7	9.84	5.86	S1	BP13
81496	20.49	12.63	7.86	ES27	ES27	81836	14.75	9.39	5.36	S1	ES83
81507	14.26	9.15	5.11	S1	ES64	81837	26.28	15.42	10.86	BP13	ES27
81510	25.73	15.12	10.61	EB1	ES83	81869	20.6	12.59	8.01	S1	BP7
81514	22.14	13.28	8.86	BP31	EB1	81870	13.86	9	4.86	S1	ES113
81516	16.73	10.62	6.11	ES26	ES26	81871	22.04	13.43	8.61	EB2	EB2

SPECIFICATIONS BY PART NUMBER

GUARDIAN SHOCKS (CONT'D)

CATALOG PART NO.	EXTENDED LENGTH	COLLAPSED LENGTH	STROKE	UPPER MTG CODE	LOWER MTG CODE	CATALOG PART NO.	EXTENDED LENGTH	COLLAPSED LENGTH	STROKE	UPPER MTG CODE	LOWER MTG CODE
81872	14.95	9.59	5.36	S1	ES17	81924	20.78	12.67	8.11	ES83	ES83
81873	24.74	14.88	9.86	ES34	ES34	81925	14.7	9.59	5.11	S12	ES7
81878	17.73	11.12	6.61	ES18	ES18	81926	21.25	13.24	8.01	ES88	ES65
81880	14.73	9.62	5.11	ES10	EB1	81927	21.01	15.87	5.14	S36	LU1
81882	15.63	10.37	5.26	ES69	ES69	81928	13.78	9.52	4.26	S38	ES34
81890	25.28	14.92	10.36	BP14	ES83	81929	19.49	12.13	7.36	BP20	ES24
81891	21.09	13.33	7.76	EB5	ES24	81930	22.81	13.95	8.86	ES34	ES34
81892	24.2	14.09	10.11	S12	ES171	81931	26.53	16.02	10.51	ES34	ES34
81893	18.27	13.51	4.76	S36	BP7	81932	15.87	10.51	5.36	S38	ES34
81904	18.46	11.7	6.76	S1	ES83	81933	13.97	9.11	4.86	S29	BP13
81905	26.97	15.86	11.11	EB1	ES185	81934	26.14	16.45	9.69	S20	ES84
81910	22.48	13.62	8.86	ES19	ES110	81935	24.19	15.93	8.26	S70	ES41
81911	19.04	11.68	7.36	S1	ES153	81936	20.3	12.19	8.11	S12	BP11
81912	15.48	9.87	5.61	S62	BP7	81937	21.44	13.18	8.26	S47	EB1
81913	28.39	16.28	12.11	S12	ES171	81931	26.53	16.02	10.51	ES34	ES34
81914	15.48	9.87	5.61	S62	ES26	81932	15.87	10.51	5.36	S38	ES34
81916	13.72	9.46	4.26	S36	BP10	81933	13.97	9.11	4.86	S29	BP13
81917	23.03	13.92	9.11	EB1	ES83	81934	26.14	16.45	9.69	S20	ES84
81918	26.97	15.86	11.11	EB1	ES83	81935	24.19	15.93	8.26	S70	ES41
81919	22.3	13.54	8.76	S38	ES34	81936	20.3	12.19	8.11	S12	BP11
81920	14.71	10.1	4.61	S12	BP11	81937	21.44	13.18	8.26	S47	EB1
81921	26.76	15.67	11.09	ES34	ES34						
81922	15.35	10.24	5.11	S12	LU1						
81923	24.47	14.61	9.86	ES26	ES26						

SPECIFICATIONS BY PART NUMBER

GUARDIAN STRUT

CATALOG PART NO.	EXTENDED LENGTH	COLLAPSED LENGTH	STROKE	UPPER MTG CODE	LOWER MTG CODE	CATALOG PART NO.	EXTENDED LENGTH	COLLAPSED LENGTH	STROKE	UPPER MTG CODE	LOWER MTG CODE
M55693	24.59	15.59	9	S95	LP1	M55921	16.87	11.13	5.74	S100	CL1
M55697	19.7	13.19	6.51	S103	CL1	M55974	18.01	11.14	6.88	S108	CL1
M55786	24.75	16.50	8.25	n/a	n/a	M55975	20.97	12.80	8.18	S111	CL1
M55802	15.31	10.37	4.94	S102	LP2	M56501	20.18	12.01	8.18	S111	CL1
M55803	18.92	13.23	5.69	S86	LU1	M56502	17.22	10.54	6.68	n/a	n/a
M55848	20.16	11.87	8.30	S32	CL1	M56506	17.22	10.54	6.68	S116	CL1
M55870	16.78	11.56	5.22	S86	LP3	M56514	17.22	10.54	6.68	S116	CL1
M55871	25.31	16.56	8.75	S86	ES199	M56516	20.22	14.02	6.2	S104	LP1
M55877	15.24	10.55	4.7	S86	LP3	M56517	20.22	13.94	6.28	S104	LP1
M55892	20.19	14.09	6.9	S117	CL1	M56558	20.98	14.44	6.54	n/a	n/a
M55896	20.2	14.1	6.10	S117	CL1	M56559	20.98	14.44	6.54	n/a	n/a
M55901	20.41	13.65	6.76	S111	LP4	M56621	19.12	13.00	6.12	S120	CL1
M55912	19.32	12.31	7.02	S104	CL1	M56622	19.12	13.00	6.12	S120	CL1
M55913	19.32	12.31	7.02	S104	CL1	M56708	21.85	13.86	7.92	n/a	n/a
M55920	16.87	11.13	5.74	S100	CL1	M56718	20.91	13.82	7.57	S69	CL1

HIJACKERS

CATALOG PART NO.	EXTENDED LENGTH	COLLAPSED LENGTH	STROKE	UPPER MTG CODE	LOWER MTG CODE	CATALOG PART NO.	EXTENDED LENGTH	COLLAPSED LENGTH	STROKE	UPPER MTG CODE	LOWER MTG CODE
49105	18.21	11.23	6.98	S1	S1	49221	18.36	11.88	6.48	ES141	ES25
49106	22.43	13.95	8.48	ES26	EB4	49223	23.27	14.29	8.98	EB1	ES83
49107	19.27	12.29	6.98	ES24	ES24	49226	20.77	13.04	7.73	BP20	EB1
49110	22.08	13.85	8.23	EB4	EB4	49228	24.47	14.74	9.73	S15	BP14
49122	21.62	13.14	8.48	S1	ES10	49230	20.27	12.79	7.48	ES185	ES185
49127	19.87	12.63	7.24	EB1	ES25	49231	24.27	14.79	9.48	BP14	ES34
49128	22.77	14.04	8.73	BP14	EB1	49232	25.09	15.16	9.93	BP14	ES83
49131	22.15	13.67	8.48	BP31	EB1	49233	15.67	10.79	4.88	ES69	ES69
49135	21.62	13.14	8.48	BP14	S1	49234	19.77	13.98	5.79	S1	ES83
49149	24.93	15.64	9.29	ES27	EB4	49235	24.77	15.04	9.73	ES34	ES34
49152	20.27	13.04	7.23	BP31	EB1	49236	17.77	11.54	6.23	ES18	ES18
49155	23.27	14.29	8.98	EB1	ES34	49237	24.18	14.45	9.73	S12	ES171
49157	21.37	13.29	8.08	BP14	EB1	49254	17.86	12.45	5.41	S69	ES15
49162	20.02	12.79	7.23	ES24	ES24	49255	24.54	14.66	9.87	S15	BP31
49173	19.24	12.01	7.23	S1	ES25	49304	14.35	9.75	4.60	ES10	EB1
49178	23.12	13.89	9.23	S1	ES25	49307	16.35	10.75	5.60	ES17	ES17
49199	20.68	12.7	7.98	S1	ES91	49310	20.35	12.75	7.60	EB1	EB1
49203	20.24	12.51	7.73	S1	EB1	49311	22.44	14	8.44	EB1	EB1
49205	21.12	13.13	7.99	S1	EB1	49334	20.7	13.05	7.65	BP31	EB1
49212	21.02	13.29	7.73	ES27	ES27	49369	21.86	13.51	8.35	ES84	ES84
49213	24.27	14.79	9.48	BP14	ES34	49387	21.14	13.03	8.11	S12	EB2
49215	23.02	14.16	8.86	ES18	ES18	49388	21.79	13.39	8.40	S12	EB2
49218	26.34	16.36	9.98	BP14	ES34						

SPECIFICATIONS BY PART NUMBER

LTV SEVERE DUTY

CATALOG PART NO.	EXTENDED LENGTH	COLLAPSED LENGTH	STROKE	UPPER MTG CODE	LOWER MTG CODE	CATALOG PART NO.	EXTENDED LENGTH	COLLAPSED LENGTH	STROKE	UPPER MTG CODE	LOWER MTG CODE
58357	14.68	10.06	4.62	ES24	ES24	58662	24.68	15.36	9.32	ES34	ES34
58359	13.92	9.14	4.78	S1	BP13	58714	15.26	9.98	5.28	S62	BP7
58403	24.48	14.95	9.53	ES26	ES26	58803	15.24	10.37	4.87	S12	LU1
58412	26.68	16.18	10.50	ES34	ES34	58807	15.24	10.11	5.13	S36	EB1
58421	13.42	8.89	4.53	S1	BP30	58808	28.38	16.75	11.63	EB1	ES83
58422	23.87	14.49	9.38	BP14	ES34	58809	23.65	14.53	9.12	EB1	ES83
58423	16.45	10.67	5.78	ES26	ES26	58810	31.42	18.42	13.00	EB1	ES83
58488	26.69	16.02	10.63	BP14	ES34	58817	15.59	10.96	4.63	S12	ES60
58489	14.64	9.61	5.03	S29	BP11	58901	16.49	10.87	5.62	ES126	ES34
58609	16.49	11.05	5.44	ES126	ES45	58929	14.54	9.76	4.78	S36	EB1
58622	15.04	10.16	4.88	S36	EB1	58930	22.81	14.06	8.75	ES34	ES34
58623	22.54	13.91	8.63	S36	ES83	58944	20.73	13.35	7.38	S62	ES204
58638	23.87	14.49	9.38	BP14	ES34						

MAX CONTROL

CATALOG PART NO.	EXTENDED LENGTH	COLLAPSED LENGTH	STROKE	UPPER MTG CODE	LOWER MTG CODE	CATALOG PART NO.	EXTENDED LENGTH	COLLAPSED LENGTH	STROKE	UPPER MTG CODE	LOWER MTG CODE
75676	19.66	11.83	7.83	S1	EB1	77638	24.31	14.78	9.53	BP14	ES34
77375	14.14	9.04	5.10	S12	BP7	77661	13.72	9.5	4.22	S12	ES34
77403	24.31	14.78	9.53	ES26	ES26	77662	24.31	14.78	9.53	ES34	ES34
77412	26.77	16.26	10.51	ES34	ES34	77673	22.38	13.84	8.54	S38	ES34
77414	15.33	10.34	4.99	S36	ES83	77674	23.27	14.27	9.00	S38	ES34
77422	23.92	14.39	9.53	BP14	ES34	77675	26.25	15.74	10.51	ES34	ES34
77423	16.8	10.83	5.97	ES128	ES128	77678	18.01	13.51	4.50	S36	BP7
77424	20.34	12.59	7.75	S1	BP7	77679	24.9	14.88	10.02	BP14	ES83
77425	19.87	12.23	7.64	EB1	BP20	77683	21.11	13.27	7.84	EB5	ES24
77454	22.77	14	8.77	ES141	ES141	77714	15.34	9.84	5.50	S38	BP7
77455	22.92	13.9	9.02	ES83	ES83	77715	28.32	16.33	11.99	S12	ES171
77461	25.39	15.18	10.21	EB1	ES83	77716	15.32	9.84	5.48	S38	ES26
77479	14.14	9.04	5.10	S1	ES113	77717	22.92	13.9	9.02	ES25	ES25
77488	26.77	16.26	10.51	BP14	ES34	77726	20.85	13.05	7.80	S12	EB19
77489	14.36	9.55	4.81	S29	BP11	77772	14.51	9.72	4.79	S36	BP10
77494	21.78	13.52	8.26	EB2	EB2	77783	14.64	10.12	4.52	S12	BP11
77524	26.87	15.87	11.00	EB1	ES83	77803	15.31	10.32	4.99	S29	LU1
77525	22.9	14	8.90	EB1	ES83	77807	15.33	10.34	4.99	S36	EB1
77607	25.39	15.18	10.21	BP14	ES83	77808	28.73	16.92	11.81	EB1	ES83
77608	14.45	9.64	4.81	S36	EB1	77809	22.92	13.9	9.02	EB1	ES83
77609	16.43	10.95	5.48	ES126	ES128	77810	31.53	18.5	13.03	EB1	ES83
77614	15.04	10.05	4.99	S36	EB1	77815	21.97	13.2	8.77	S47	ES64
77623	22.38	13.84	8.54	S38	ES83	77817	15.73	10.94	4.79	S12	ES60

SPECIFICATIONS BY PART NUMBER

MAX CONTROL (CONT'D)

CATALOG PART NO.	EXTENDED LENGTH	COLLAPSED LENGTH	STROKE	UPPER MTG CODE	LOWER MTG CODE	CATALOG PART NO.	EXTENDED LENGTH	COLLAPSED LENGTH	STROKE	UPPER MTG CODE	LOWER MTG CODE
77829	22.33	13.6	8.73	ES88	ES65	77953	22.65	13.9	8.75	ES34	ES34
77837	28.73	16.92	11.81	ES83	BP14	77954	13.83	9.08	4.75	S29	BP13
77847	20.34	12.59	7.75	S1	BP7	77967	20.75	13.13	7.62	S62	ES34
77905	14.64	9.33	5.31	S1	ES83	77968	24.71	15.09	9.62	EB1	ES185
77907	19.87	12.23	7.64	EB1	EB1	77969	25.43	15.81	9.62	EB1	ES185
77909	14.14	9.04	5.10	S1	ES17	77971	23.64	14.70	8.94	ES45	ES47
77915	13.61	8.85	4.76	S1	BP7	77973	22.57	14.41	8.16	BP12	ES207
77947	15.63	10.88	4.75	S38	ES34	77975	23.98	15.69	8.34	ES34	ES34
77948	23.5	14.75	8.75	S38	ES34	77976	24.84	16.07	8.76	ES34	ES34
77949	16.16	10.67	5.49	S38	BP27	77978	20.26	12.39	7.87	S10	BP39
77950	27.5	17.5	10.00	ES34	ES34	77980	23	14.39	8.61	S38	ES204
77951	20.5	13	7.50	S38	ES34	77981	21.77	13.65	8.12	S57	ES26
77952	29.68	17.43	12.25	EB1	ES83	77983	24.08	15.23	8.85	BP8	ES204

PRO GUARD

CATALOG PART NO.	EXTENDED LENGTH	COLLAPSED LENGTH	STROKE	UPPER MTG CODE	LOWER MTG CODE	CATALOG PART NO.	EXTENDED LENGTH	COLLAPSED LENGTH	STROKE	UPPER MTG CODE	LOWER MTG CODE
61500	20.23	12.37	7.86	EB1	EB1	61535	20.45	12.67	7.78	S1	BP7
61501	12.6	8.59	4.01	S1	ES64	61536	19.98	12.45	7.53	BP20	EB1
61504	13.7	8.92	4.78	S1	BP30	61539	22.79	14.01	8.78	ES141	ES141
61506	21.86	13.58	8.28	EB1	EB1	61541	18.14	11.61	6.53	EB5	ES25
61508	14.11	9	5.11	S1	ES64	61542	16.73	10.95	5.78	ES126	ES128
61509	14.7	9.34	5.36	S1	BP14	61543	26.76	16.23	10.53	BP14	ES34
61510	22.29	13.76	8.53	EB2	EB2	61544	14.54	9.75	4.79	S29	BP11
61512	13.2	8.59	4.61	S1	BP7	61546	18.45	11.67	6.78	S1	ES64
61516	18.23	11.37	6.86	ES31	ES24	61547	23.01	14.07	8.94	EB1	ES83
61517	14.98	9.95	5.03	ES24	ES24	61550	17.73	11.12	6.61	EB1	EB1
61518	18.73	11.7	7.03	S1	ES25	61552	13.95	9.17	4.78	S1	ES113
61519	19.98	12.45	7.53	EB1	ES25	61554	21.48	13.2	8.28	ES185	ES185
61520	15.34	10.31	5.03	S36	ES41	61555	14.14	9.11	5.03	S12	BP7
61521	16.45	10.67	5.78	S12	ES25	61556	14.2	9.09	5.11	S1	BP7
61522	20.49	12.63	7.86	ES27	ES27	61559	22.98	13.95	9.03	EB1	ES185
61523	13.7	8.92	4.78	S1	BP13	61560	18.45	11.67	6.78	S1	ES83
61524	23.26	14.23	9.03	EB1	ES34	61561	15.09	10.06	5.03	S36	EB1
61525	15.01	9.95	5.06	EB1	ES24	61565	24.26	14.73	9.53	BP14	ES34
61528	23.98	14.45	9.53	BP14	ES34	61573	26.98	15.95	11.03	EB1	ES185
61529	14.1	9.34	4.76	S1	BP4	61575	21.14	13.36	7.78	EB5	ES24
61530	25.48	15.2	10.28	EB1	ES83	61582	24.98	14.95	10.03	EB1	EB1
61531	16.73	10.7	6.03	ES26	ES26	61584	25.48	15.2	10.28	BP13	ES26
61533	22.98	13.95	9.03	EB1	ES106	61590	25.48	15.2	10.28	BP14	ES83

SPECIFICATIONS BY PART NUMBER

PRO GUARD (CONT'D)

CATALOG PART NO.	EXTENDED LENGTH	COLLAPSED LENGTH	STROKE	UPPER MTG CODE	LOWER MTG CODE	CATALOG PART NO.	EXTENDED LENGTH	COLLAPSED LENGTH	STROKE	UPPER MTG CODE	LOWER MTG CODE
61591	14.47	9.71	4.76	S36	EB1	61658	24.48	14.7	9.78	ES26	ES26
61592	21.45	13.17	8.28	S47	EB1	61659	20.76	12.98	7.78	ES185	ES185
61593	14.95	9.67	5.28	S1	ES64	61662	12.23	8.45	3.78	S47	ES17
61595	20.07	12.54	7.53	S36	ES83	61663	15.7	10.92	4.78	S12	ES60
61599	13.8	9.52	4.28	S38	ES34	61664	20.45	12.67	7.78	S1	BP7
61600	24.51	14.98	9.53	ES34	ES34	61675	22.81	14.12	8.69	ES34	ES34
61601	14.71	9.49	5.22	S1	ES83	61676	21.25	13.31	7.94	ES88	ES65
61605	17.98	11.45	6.53	ES18	ES18	61679	14.71	9.49	5.22	S1	ES25
61606	14.7	9.34	5.36	S1	BP19	61680	20.83	13.39	7.44	S38	ES34
61608	19.64	12.36	7.28	ES99	ES48	61682	31.36	18.67	12.69	EB1	ES83
61609	22.48	13.7	8.78	ES110	ES19	61683	15.07	10.44	4.63	S11	LU1
61611	15.48	9.95	5.53	S62	BP7	61684	12.82	8.88	3.94	S11	BP9
61612	28.39	16.36	12.03	S12	ES171	61685	14.12	9.68	4.44	S11	BP9
61613	15.48	9.95	5.53	S62	ES26	61687	23.87	14.68	9.19	BP14	ES34
61614	22.98	13.95	9.03	ES41	ES41	61690	24.78	15.84	8.94	ES34	ES34
61615	20.3	12.27	8.03	S12	BP11	61691	26.51	16.12	10.39	ES34	ES34
61616	19.39	12.23	7.16	BP20	ES24	61692	26.05	15.87	10.18	ES34	ES34
61623	18.04	13.51	4.53	S36	BP7	61696	22.45	14.5	7.95	BP18	ES26
61624	24.98	14.95	10.03	BP14	ES83	61697	22.62	14.43	8.19	BP18	ES26
61625	15.48	10.45	5.03	ES69	ES69	61699	19.41	12.65	6.76	EB2	EB2
61626	13.73	9.45	4.28	S36	BP10	61700	20.37	13.11	7.26	EB2	EB2
61627	22.98	13.95	9.03	EB1	ES83	61703	20.15	13.96	6.19	ES83	ES83
61629	26.98	15.95	11.03	EB1	ES83	61704	16.84	11.28	5.56	ES69	ES69
61632	20.79	13.01	7.78	EB4	EB4	61710	27.58	17.14	10.44	ES34	ES34
61634	22.3	13.77	8.53	S38	ES34	61711	21.8	13.61	8.19	S36	ES26
61635	23.27	14.24	9.03	S38	ES34	61712	23.3	14.26	9.04	S38	ES34
61638	24.45	14.42	10.03	S12	ES171	61713	26.94	16	10.94	EB1	ES83
61641	14.7	10.17	4.53	S12	BP11	61714	23.36	14.22	9.14	S62	ES77
61642	26.76	15.98	10.78	ES34	ES34	61715	24.12	15.18	8.94	ES88	ES69
61643	15.36	10.33	5.03	S12	LU1	61716	26.5	16.33	10.17	ES34	ES34
61646	22.57	14.29	8.28	S36	ES185	61717	22.75	14.56	8.19	ES47	ES26
61651	24.4	14.64	9.76	S47	EB1	61718	21.33	13.64	7.69	ES45	ES45
61654	28.76	16.98	11.78	ES185	ES185	61720	15.92	11.23	4.69	ES17	ES19
61655	23.01	14.07	8.94	ES185	ES185	61734	23.97	15.27	8.69	ES87	ES87
61656	31.51	18.48	13.03	ES185	ES185	61777	15.62	10.68	4.94	ES164	ES68

SPECIFICATIONS BY PART NUMBER

REAR LOAD CARRIERS

CATALOG PART NO.	EXTENDED LENGTH	COLLAPSED LENGTH	STROKE	UPPER MTG CODE	LOWER MTG CODE	CATALOG PART NO.	EXTENDED LENGTH	COLLAPSED LENGTH	STROKE	UPPER MTG CODE	LOWER MTG CODE
43048	20.45	12.62	7.83	EB1	EB1	43140	20.92	12.84	8.08	S1	EB1
43049	21.86	13.28	8.58	BP31	EB1	43162	22.99	14.38	8.61	BP14	ES34
43058	19.95	12.37	7.58	EB1	ES25	43163	25.05	15.69	9.36	BP14	ES34
43060	20.2	12.55	7.65	BP31	EB1	43167	22.99	13.88	9.11	EB1	ES83
43085	20.61	12.78	n/a	EB4	ES27	43171	24.74	15.38	9.36	BP14	ES83
43099	19.17	11.77	7.40	S1	ES25	43180	23.55	14.19	9.36	BP8	ES34
43111	22.9	13.82	9.08	EB7	ES34	43181	24.24	14.88	9.36	ES34	ES34

STEERING DAMPERS

CATALOG PART NO.	EXTENDED LENGTH	COLLAPSED LENGTH	STROKE	UPPER MTG CODE	LOWER MTG CODE	CATALOG PART NO.	EXTENDED LENGTH	COLLAPSED LENGTH	STROKE	UPPER MTG CODE	LOWER MTG CODE
14004	17.48	11.28	6.20	S71	ES60	14040	19.73	12.12	7.61	EB1	ES24
14005	14.49	9.41	5.08	S54	ES60	14071	20.7	12.79	7.91	ES53	ES65
14017	24.04	14.43	9.61	EB1	EB1	14072	28.22	16.49	11.73	ES83	EB18
14018	21.37	12.8	8.57	ES35	EB1	14074	20.62	13.30	7.32	ES65	ES65

STEERING STABILIZERS

CATALOG PART NO.	EXTENDED LENGTH	COLLAPSED LENGTH	STROKE	UPPER MTG CODE	LOWER MTG CODE	CATALOG PART NO.	EXTENDED LENGTH	COLLAPSED LENGTH	STROKE	UPPER MTG CODE	LOWER MTG CODE
6801SE	19.33	12.16	7.17	EB1	EB1	6850SE	23.3	13.77	9.53	EB1	S1
6802SE	20.02	12.11	7.91	S1	S1	6853SE	19.33	12.05	7.28	EB1	ES24
6803SE	22.52	13.36	9.16	S1	S1	6854SE	23.03	14.27	8.76	EB1	EB1
6804SE	24.08	14.67	9.41	EB1	EB1	6855SE	23.83	14.3	9.53	EB1	EB1
6828SE	21.23	12.87	8.36	EB1	EB1	6856SE	27.3	15.77	11.53	S1	EB1
6847SE	23	13.83	9.17	EB1	ES65	6861SE	20.27	11.99	8.28	S1	S1

ULTRA CARTRIDGE

CATALOG PART NO.	EXTENDED LENGTH	COLLAPSED LENGTH	STROKE	UPPER MTG CODE	LOWER MTG CODE	CATALOG PART NO.	EXTENDED LENGTH	COLLAPSED LENGTH	STROKE	UPPER MTG CODE	LOWER MTG CODE
G44459	20.32	13.41	6.91	S69	LP6	G44903	19.81	13.59	6.22	S84	LP6
G44461	20.58	14.67	5.91	S16	LP6	G44986	21.45	14.95	6.5	S103	LP6
G44493	22.8	17.92	4.88	S116	LP6	G44997	21.76	14.76	7	S103	LP6
G44748	20.38	14.45	5.93	S103	LP6	G44999	20.93	14.23	6.7	S103	LP6

SPECIFICATIONS BY PART NUMBER

ULTRA READYMOUNTS

CATALOG PART NO.	EXTENDED LENGTH	COLLAPSED LENGTH	STROKE	UPPER MTG CODE	LOWER MTG CODE	CATALOG PART NO.	EXTENDED LENGTH	COLLAPSED LENGTH	STROKE	UPPER MTG CODE	LOWER MTG CODE
G56726	25.15	17.27	7.88	TMO2S	CL1	G57012	20.98	14.44	6.54	TMT3S	CL1
G56924	23.13	16.09	7.05	TMU3S	CL1	G57013	17.25	10.25	7	TMC3S	CL1
G56925	23.13	16.09	7.05	TMU3S	CL1	G57014	19.63	12.38	7.25	TMC3S	CL1
G56927	18.01	11.14	6.88	TMC2S1B	CL1	G57015	21.05	16.14	4.91	TMC3S	ES77
G56928	20.18	12.01	8.18	TMU3B1S	CL1	G57016	21.25	14.21	7.04	TMC3S	ES77
G56929	17.51	10.62	6.89	TMT3S	CL1	G57017	18.93	16.73	2.2	TMC3S	ES159
G56930	17.22	10.54	6.68	TMT3S	CL1	G57018	19.28	13.69	5.59	TMC3S	ES162
G56931	17.22	10.54	6.68	TMT3S	CL1	G57019	18.93	16.73	2.2	TMC3S	ES159
G56932	20.95	12.25	8.7	TMT3S	CL1	G57020	20.6	16.65	3.95	TMC3S	ES184
G56933	20.95	12.25	8.7	TMT3S	CL1	G57021	21.69	16.62	5.07	TMC3S	ES184
G56934	19.51	13.60	5.91	TMU3S	LP4	G57022	16.61	11.41	5.2	TMC2S	LP3
G56935	20.01	13.49	6.52	TMC3S	LP4	G57023	17.76	12.87	4.76	TMC3S	BP37
G56936	20.41	13.65	6.76	TMC3S	LP4	G57025	20.47	13.19	7.28	TMR2S	LU1
G56937	19.51	13.60	5.91	TMU3S	LP4	G57026	24.48	16.97	7.16	TMO2S	LU1
G56938	22.88	17.33	5.55	TMU2B1S	ES58	G57027	18.14	13.36	4.78	TMC3S	ES153
G56939	19.92	13.14	6.78	TMC2S1B	CL1	G57030	20.5	13.62	6.87	TMT3S	CL1
G56943	25.31	16.56	8.75	TMO2S	ES199	G57031	20.5	13.61	6.87	TMT3S	CL1
G56948	16.79	10.81	5.98	TMC3S	CL1	G57032	14.68	10.35	4.33	TMO2S	ES69
G56949	19.57	11.76	7.81	TMT3S	CL1	G57033	14.68	10.35	4.33	TMO2S	ES69
G56950	19.57	11.76	7.81	TMC3S	CL1	G57034	18.75	12.75	6.00	TMT3S	CL1
G56951	19.92	13.14	6.78	TMC2S1B	CL1	G57035	18.75	12.75	6.00	TMT3S	CL1
G56956	18.6	12.14	6.47	TMC3S	CL1	G57036	16.37	11.07	5.3	TMO2S	ES45
G56957	18.6	12.14	6.47	TMC3S	CL1	G57037	23.31	16.65	6.66	TMT3S	CL1
G56962	17.34	11.26	6.09	TMC4S	CL1	G57038	23.31	16.65	6.66	TMT3S	CL1
G56963	17.34	11.26	6.09	TMC4S	CL1	G57039	19.65	13.23	6.42	TMC2B	LP1
G56964	23.37	14.26	9.11	TMC3S	LP3	G57040	20.39	14.21	6.18	TMR3S	CL1
G56965	20.2	14.1	6.10	TMT3S	CL1	G57041	18.89	11.48	7.41	TMC3S	CL1
G56973	24.41	16.46	7.95	TMU3S1B	CL1	G57042	18.89	11.48	7.41	TMC3S	CL1
G56974	24.41	16.46	7.95	TMU3S1B	CL1	G57043	20.95	12.25	8.7	TMC3S	CL1
G56975	20.19	14.09	6.9	TMT3S	CL1	G57044	20.95	12.25	8.7	TMC3S	CL1
G56991	16.78	11.56	5.22	TMC5S	LP3	G57045	25	17.75	7.25	TMC4S	CL1
G56992	16.78	11.56	5.22	TMC5S	LP3	G57046	25	17.75	7.25	TMC4S	CL1
G56993	15.31	10.37	4.94	TMC2S	LP2	G57047	20	13.50	6.5	TMU3S	CL1
G56994	15.31	10.37	4.94	TMC2S	LP2	G57048	20	13.50	6.5	TMU3S	CL1
G56995	18.92	13.23	5.69	TMO2S	LU1	G57049	19.87	13.37	6.5	TMT3S	CL1
G56996	15.32	10.38	4.94	TMO2S	LP3	G57050	19.87	13.37	6.5	TMT3S	CL1
G56997	15.32	10.38	4.94	TMO2S	LP3	G57051	16.82	10.66	6.17	TMT3B	CL1
G56998	19.02	13.11	5.86	TMO2S	LU2	G57053	21.5	15.34	5.85	TMC3S	LU1
G57000	17.76	12.87	4.76	TMC3S	BP37	G57054	17.12	12.50	4.62	TMC5S	LP3
G57005	20.43	13.78	6.65	TMC0	CL1	G57055	17.12	12.50	4.62	TMC5S	LP3
G57006	18.49	11.34	7.15	TMC0	CL1	G57056	24.57	17.09	7.48	TMU2S	ES202
G57007	13.87	9.62	4.25	TMU4S	LP6	G57057	17.86	11.91	5.95	TMC2S	ES87
G57008	13.87	9.62	4.25	TMU4S	LP6	G57058	17.86	11.91	5.95	TMC2S	ES87
G57010	18.02	12.75	5.27	TMC3S	ES56	G57059	16.79	11.99	4.8	TMT3S	LP2
G57011	20.98	14.44	6.54	TMT3S	CL1	G57060	16.5	10.71	5.79	TMT3S	CL1

SPECIFICATIONS BY PART NUMBER

ULTRA READYMOUNTS (CONT'D)

CATALOG PART NO.	EXTENDED LENGTH	COLLAPSED LENGTH	STROKE	UPPER MTG CODE	LOWER MTG CODE	CATALOG PART NO.	EXTENDED LENGTH	COLLAPSED LENGTH	STROKE	UPPER MTG CODE	LOWER MTG CODE
G57061	14.68	10.35	4.33	TMO2S	ES112	G57111	20.94	12.87	8.07	TMC3S	CL1
G57062	14.68	10.35	4.33	TMO2S	ES112	G57112	20.8	13.38	7.42	TMU3S	CL1
G57063	20.22	13.94	6.28	TMT3S	LP1	G57113	20.8	13.38	7.42	TMU3S	CL1
G57064	20.22	14.02	6.2	TMT3S	LP1	G57114	19.62	13.87	5.75	TMT3S	CL1
G57065	18.02	12.75	5.27	TMC3S	ES56	G57115	19.62	13.87	5.75	TMT3S	CL1
G57066	18.02	12.75	5.27	TMC3S	ES56	G57118	15.56	10.99	4.57	TMC3S	ES49
G57067	16.5	11.50	5	TMU2S1B	ES104	G57119	27.75	14.50	13.25	TMT3S	CL1
G57068	16.5	11.50	5	TMU2S1B	ES104	G57120	21.75	14.50	7.25	TMT3S	CL1
G57069	20.47	12.68	7.79	TMC3S	CL1	G57121	20.47	12.68	7.79	TMC3S	CL1
G57070	20.47	13.07	7.40	TMC3S	CL1	G57122	20.47	13.07	7.40	TMC3S	CL1
G57071	25.17	19.37	5.8	TMC3S	LU2	G57123	23.26	17.55	5.7	TMC4S	ES67
G57072	25.17	19.37	5.8	TMC3S	LU2	G57124	23.26	17.55	5.7	TMC4S	ES67
G57075	21.3	14.3	7	TMC3S	ES96	G57125	17.8	13.54	4.26	TMC3S	BP37
G57076	18.91	11.48	7.43	TMT3S	CL1	G57126	20.44	13.69	6.75	TMC0	CL1
G57077	18.91	11.48	7.43	TMT3S	CL1	G57127	20.44	13.69	6.75	TMC0	CL1
G57078	20.95	12.25	8.7	TMT3S	CL1	G57128	22.34	14.9	7.44	TMT3S	CL1
G57079	20.95	12.25	8.7	TMT3S	CL1	G57129	22.34	14.9	7.44	TMT3S	CL1
G57080	15.55	12.09	3.46	TMC3S	ES75	G57130	20.09	13.79	6.30	TMC0	CL1
G57081	18.84	13.12	5.72	TMT3S	LP1	G57131	20.09	13.79	6.30	TMC0	CL1
G57082	18.84	13.12	5.72	TMT3S	LP1	G57132	20.86	16.45	4.4	TMC3S	ES77
G57083	21	14.25	6.75	TMU4S	LP4	G57133	21.36	16.79	4.57	TMC3S	ES153
G57084	21.1	14.53	6.57	TMT3S	CL1	G57134	21.36	16.79	4.57	TMC3S	ES153
G57085	21.1	14.53	6.57	TMT3S	CL1	G57135	22.05	18.19	3.86	TMC2S	LU3
G57086	15.65	10.84	4.81	TMO2S	ES165	G57136	22.05	18.19	3.86	TMC2S	LU3
G57087	15.65	10.84	4.81	TMO2S	ES165	G57137	24.88	17.95	6.92	TMT3S	CL1
G57088	19.62	13.37	6.25	TMT3S	CL1	G57138	24.88	17.95	6.92	TMT3S	CL1
G57089	19.62	13.37	6.25	TMT3S	CL1	G57139	23	16.37	6.62	TMT3S	CL1
G57090	22	15.69	6.31	TMC0	ES104	G57140	23	16.37	6.62	TMT3S	CL1
G57091	22	15.69	6.31	TMC0	ES104	G57141	19.6	13.07	6.53	TMT3S	CL1
G57092	14.92	10.43	4.49	TMC4S	ES49	G57142	19.6	13.14	6.45	TMT3S	CL1
G57095	20.11	17.44	2.51	TMC3S	ES208	G57144	22.56	15.98	6.58	TMT3S	CL1
G57096	19.33	13.42	5.9	TMC3S	ES209	G57145	22.56	15.98	6.58	TMT3S	CL1
G57097	21.73	15.16	6.57	TMC3S	CL1	G57146	18.07	13.46	4.61	TMU3S	LU1
G57098	21.73	15.16	6.57	TMC3S	CL1	G57147	21.18	15.11	6.06	TMT3S	LU1
G57099	19.75	13.12	6.62	TMC4B	CL1	G57148	18.5	14.29	4.21	TMT3S	LP3
G57100	19.75	13.12	6.62	TMC2B	CL1	G57149	15.74	11.34	4.4	TMC3S	LP3
G57101	22.8	14.84	7.96	TMC2S1B	CL1	G57150	23.72	16.95	6.77	TMT3S	CL1
G57102	22.8	14.84	7.96	TMC2S1B	CL1	G57151	23.72	16.95	6.77	TMT3S	CL1
G57103	21.57	17.16	4.41	TMC3S	ES77	G57152	22.99	15.08	7.91	TMT3S	CL1
G57105	20.74	13.59	7.15	TMT3S	CL1	G57153	22.99	15.08	7.91	TMT3S	CL1
G57106	20.74	13.59	7.15	TMT3S	CL1	G57156	21.1	14.8	6.30	TMT3S	LP5
G57107	18.63	14.83	3.8	TMU2S2B	BP37	G57157	21.14	13.66	7.48	TMT3S	CL1
G57108	18.63	14.83	3.8	TMU2S2B	BP37	G57158	21.14	13.66	7.48	TMT3S	CL1
G57109	22	14.13	7.87	TMR3S	CL1	G57159	17.62	12.87	4.75	TMC2S	ES18
G57110	20.94	12.87	8.07	TMC3S	CL1	G57160	17.62	12.87	4.75	TMC2S	ES18

SPECIFICATIONS BY PART NUMBER

ULTRA READYMOUNTS (CONT'D)

CATALOG PART NO.	EXTENDED LENGTH	COLLAPSED LENGTH	STROKE	UPPER MTG CODE	LOWER MTG CODE	CATALOG PART NO.	EXTENDED LENGTH	COLLAPSED LENGTH	STROKE	UPPER MTG CODE	LOWER MTG CODE
G57161	17.51	13.3	4.21	TMT3B	CL1	G57270	19.65	14.09	5.55	TMT3S	LP3
G57162	17.51	13.3	4.21	TMT3B	CL1	G57271	21.69	16.02	5.66	TMC4S	CL1
G57163	22.2	15.04	7.16	TMC3S	CL1	G57274	19.76	13.30	6.45	TMT3S	CL1
G57164	22.2	15.04	7.16	TMC3S	CL1	G57275	19.21	12.44	6.77	TMT3S	CL1
G57165	21.14	13.85	7.28	TMC3S	CL1	G57276	19.21	12.44	6.77	TMT3S	CL1
G57166	21.14	13.85	7.28	TMC3S	CL1	G57277	21.77	16.39	6.37	TMT3S	LP5
G57167	22.12	14.37	7.75	TMC3S	CL1	G57278	22.28	13.93	8.34	TMT3S	CL1
G57168	22.12	14.37	7.75	TMC3S	CL1	G57279	22.28	13.93	8.34	TMT3S	CL1
G57172	19.96	16.29	3.67	TMC3S	ES77	G57282	15.86	11.06	4.8	TMC3S	ES56
G57173	19.21	15.15	4.05	TMC3S	ES77	G57311	23.03	14.88	7.96	TMC2S1B	CL1
G57176	22.83	16.3	6.53	TMT3S	CL1	G57312	23.03	14.88	7.96	TMC2S1B	CL1
G57177	22.83	16.3	6.53	TMT3S	CL1	G57314	22.05	14.21	7.87	TMR3S	CL1
G57178	19.05	12.75	6.30	TMO2S	ES19	G57322	23.39	14.37	7.7	TMC3S	CL1
G57182	20.52	13.5	7.02	TMT3S	CL1	G57323	23.39	14.37	7.7	TMC3S	CL1
G57183	20.52	13.5	7.02	TMT3S	CL1	G57324	19.29	13.07	6.22	TMT3S	CL1
G57184	21.53	14.13	7.40	TMT3S	CL1	G57329	20.43	13.5	7.13	TMT3S	CL1
G57185	21.53	14.13	7.40	TMT3S	CL1	G57330	20.43	13.5	7.13	TMT3S	CL1
G57190	21.5	14.49	6.89	TMT3S	CL1	G57331	23.19	14.96	8.46	TMU5S	CL1
G57191	21.5	14.37	6.89	TMT3S	CL1	G57332	23.19	14.96	8.46	TMU5S	CL1
G57192	24.13	15.82	8.30	TMT3S	CL1	G57333	24.84	16.77	7.99	TMT3S	CL1
G57193	24.13	15.82	8.30	TMT3S	CL1	G57334	24.84	16.77	7.99	TMT3S	CL1
G57194	25	19.41	5.59	TMC3S	LU1	G57335	20.83	13.98	6.63	TMU3S	CL1
G57195	25	19.41	5.59	TMC3S	LU1	G57336	20.83	13.98	6.63	TMU3S	CL1
G57197	23.47	14.37	7.7	TMC3S	CL1	G57337	21.18	15.07	6.1	TMC3S	LP2
G57198	23.47	14.37	7.7	TMC3S	CL1	G57338	21.18	15.07	6.1	TMC3S	LP2
G57200	19.72	12.87	4.25	TMT3S	CL1	G57339	20.87	14.65	5.55	TMT3S	CL1
G57201	19.72	12.87	4.25	TMT3S	CL1	G57340	20.87	14.65	5.55	TMT3S	CL1
G57202	19.09	14.29	4.8	TMT3S	CL1	G57341	21.69	15.79	5.98	TMT3S	CL1
G57203	19.09	14.29	4.8	TMT3S	CL1	G57342	21.69	15.79	5.98	TMT3S	CL1
G57204	21.02	14.69	6.33	TMT3S	CL1	G57343	23.35	15.47	7.36	TMS3S	CL1
G57205	21.02	14.69	6.33	TMT3S	CL1	G57344	23.35	15.47	7.36	TMS3S	CL1
G57206	22.71	15.74	6.97	TMT3S	CL1	G57345	19.88	13.5	6.3	TMT3S	CL1
G57207	17.67	12.91	4.76	TMC3S	LP3	G57346	19.88	13.5	6.3	TMT3S	CL1
G57208	17.67	12.91	4.76	TMC3S	LP3	G57349	20.75	15.31	7.15	TMT3S	CL1
G57212	21.02	16.1	4.14	TMC3S	ES77	G57350	20.75	15.31	7.15	TMT3S	CL1
G57218	21.46	14.72	6.61	TMT3S	CL1	G57353	21.61	14.92	6.06	TMC0	CL1
G57219	21.46	14.72	6.61	TMT3S	CL1	G57354	21.61	14.92	6.06	TMC0	CL1
G57220	23.27	17.56	5.70	TMU4S	ES67	G57357	20.63	13.35	7.02	TMT3S	CL1
G57221	23.27	17.56	5.70	TMU4S	ES67	G57358	20.63	13.35	7.02	TMT3S	CL1
G57222	21.46	14.45	7.40	TMT3S	CL1	G57359	19.53	12.72	6.88	TMC4S	LP4
G57223	21.46	14.45	7.40	TMT3S	CL1	G57360	19.53	12.72	6.88	TMC4S	LP4
G57266	22.13	14.84	7.29	TMT3S	CL1	G57361	25.71	16.89	8.69	TMS4S	CL1
G57267	22.13	14.84	7.28	TMT3S	CL1	G57362	25.71	16.89	8.69	TMS4S	CL1
G57268	18.82	12.52	6.29	TMT3S	CL1	G57363	18.43	14.13	4.33	TMC3S	LP4
G57269	18.82	12.52	6.29	TMT3S	CL1	G57364	18.43	14.13	4.33	TMC3S	LP4

SPECIFICATIONS BY PART NUMBER

ULTRA READYMOUNTS (CONT'D)

CATALOG PART NO.	EXTENDED LENGTH	COLLAPSED LENGTH	STROKE	UPPER MTG CODE	LOWER MTG CODE	CATALOG PART NO.	EXTENDED LENGTH	COLLAPSED LENGTH	STROKE	UPPER MTG CODE	LOWER MTG CODE
G57365	20.75	14.29	6.53	TMT3S	CL1	G57441	14.68	10.35	4.33	TMO2S	ES61
G57366	20.75	14.29	6.53	TMT3S	CL1	G57442	15.04	10.43	4.61	TMO2S	ES61
G57367	19.72	13.07	4.21	TMT3S	CL1	G57444	18.7	12.01	6.69	TMU2S1B	ES104
G57368	19.72	13.07	4.21	TMT3S	CL1	G57447	20.31	12.48	7.83	TMO2S	ES88
G57369	20.67	13.39	7.28	TMT3S	CL1	G57449	18.11	12.4	5.71	TMU3B	ES206
G57370	20.67	13.39	7.28	TMT3S	CL1	G57450	18.11	12.4	5.71	TMU3B	ES206
G57372	23.78	16.3	6.73	TMC3S	CL1	G57451	17.76	11.77	5.99	TMU2S1B	ES214
G57373	23.78	16.3	6.73	TMC3S	CL1	G57452	14.8	10.75	4.05	TMU2S1B	ES89
G57375	23.27	16.69	6.73	TMC3S	CL1	G57453	22.05	17.87	4.18	TMS4S	ES67
G57376	23.27	16.69	6.73	TMC3S	CL1	G57454	22.05	17.87	4.18	TMS4S	ES67
G57377	19.06	15.08	4.09	TMC0	CL1	G57455	19.53	14.37	5.16	TMC3S	LP3
G57378	19.06	15.08	4.09	TMC0	CL1	G57456	19.53	14.37	5.16	TMC3S	LP3
G57390	20.12	13.11	6.93	TMT3S	CL1	G57457	19.38	15	4.38	TMC3S	ES153
G57391	20.12	13.11	6.93	TMT3S	CL1	G57458	19.38	15	4.38	TMC3S	ES153
G57392	20.47	13.35	7.15	TMC0	CL1	G57459	22.2	14.96	7.24	TMT3S	CL3
G57393	19.76	12.48	7.25	TMT3S	CL1	G57460	22.2	14.96	7.24	TMT3S	CL3
G57394	19.76	12.48	7.25	TMT3S	CL1	G57463	18.66	11.42	7.24	TMT3S	CL1
G57397	20.51	13.46	6.89	TMT3S	CL1	G57464	18.66	11.42	7.24	TMT3S	CL1
G57398	19.65	13.19	6.16	TMT3S	CL1	G57465	21.93	14.8	7.13	TMT3S	CL3
G57399	19.65	13.19	6.16	TMT3S	CL1	G57466	21.93	14.8	7.13	TMT3S	CL3
G57400	21.34	13.9	7.07	TMU3S	CL1	G57471	22.99	15.94	7.05	TMT3S	CL3
G57401	21.34	13.9	7.07	TMU3S	CL1	G57472	22.99	15.94	7.05	TMT3S	CL3
G57404	20.47	13.31	7.16	TMT3S	CL1	G57473	23.19	15.83	7.36	TMU3S	CL1
G57405	20.47	13.31	7.16	TMT3S	CL1	G57474	23.19	15.83	7.36	TMU3S	CL1
G57409	18.07	13.46	4.61	TMT3S	LU1	G57477	21.85	15.12	6.73	TMT3S	CL3
G57413	15.12	10.95	4.17	TMC3S	ES49	G57478	21.85	15.12	6.73	TMT3S	CL3
G57414	18.43	11.81	6.42	TMT3S	ES197	G57479	23.19	14.72	8.47	TMU5S	CL1
G57415	18.43	11.81	6.42	TMT3S	ES197	G57480	23.19	14.72	8.47	TMU5S	CL1
G57416	15.67	10.94	4.73	TMO2S	ES50	G57481	23.78	16.06	7.72	TMT3S	CL3
G57417	18	13.23	4.76	TMC3S	LP3	G57482	23.78	16.06	7.72	TMT3S	CL3
G57418	18	13.23	4.76	TMC3S	LP3	G57483	26.34	18.03	8.31	TMU3S	CL1
G57419	23.03	15.87	7.14	TMC2S	LU2	G57484	26.34	18.03	8.31	TMU3S	CL1
G57420	25	16.96	8.34	TMC3S	ES52	G57487	23.46	15.51	7.95	TMT3S	CL1
G57421	20.63	15.51	5	TMC3S	ES201	G57488	23.46	15.51	7.95	TMT3S	CL1
G57422	24.48	16.97	7.16	TMC3S	LU1	G57489	20.38	14.41	5.97	TMS4S	CL1
G57423	16.23	10.43	5.48	TMO2S	ES49	G57490	20.38	14.41	5.97	TMS4S	CL1
G57424	15.12	11.14	3.98	TMO2S	ES50	G57493	19.88	13.31	6.57	TMT3S	CL1
G57425	15.12	11.14	3.98	TMO2S	ES50	G57494	19.88	13.31	6.57	TMT3S	CL1
G57427	19.69	13.94	4.45	TMC3S	LP3	G57495	19.17	11.93	7.24	TMC4S	LP4
G57428	14.8	10.75	4.05	TMU3S	ES71	G57496	19.17	11.93	7.24	TMC4S	LP4
G57429	14.8	10.74	4.06	TMU3S	ES71	G57497	18.62	11.38	7.24	TMC4S	LP4
G57430	16.18	10.47	5.71	TMO2S	ES49	G57498	18.62	11.38	7.24	TMC4S	LP4
G57431	14.41	10.83	3.58	TMU4B	LP3	G57499	22.99	15.98	7.01	TMT3S	CL1
G57432	14.41	10.83	3.58	TMU4B	LP3	G57500	22.99	15.98	7.01	TMT3S	CL1
G57437	20.47	13.3	7.16	TMR2S	LU1	G57509	23.46	15	8.46	TMU3S	CL1

SPECIFICATIONS BY PART NUMBER

ULTRA READYMOUNTS (CONT'D)

CATALOG PART NO.	EXTENDED LENGTH	COLLAPSED LENGTH	STROKE	UPPER MTG CODE	LOWER MTG CODE	CATALOG PART NO.	EXTENDED LENGTH	COLLAPSED LENGTH	STROKE	UPPER MTG CODE	LOWER MTG CODE
G57510	23.46	15	8.46	TMU3S	CL1	G57583	24.17	16.5	7.67	TMU4S	CL1
G57515	20.75	14.29	6.46	TMT3S	CL1	G57586	24.33	16.81	7.52	TMT3S	CL3
G57516	20.75	14.29	6.46	TMT3S	CL1	G57587	24.33	16.81	7.52	TMT3S	CL3
G57517	22.56	15.59	6.97	TMT3S	LP3	G57594	19.61	14.09	5.52	TMU3S	LP3
G57518	22.56	15.59	6.97	TMT3S	LP3	G57595	19.61	14.09	5.52	TMU3S	LP3
G57521	19.25	12.72	6.53	TMT3S	CL1	G57597	16.69	12.36	4.33	TMO2S	ES50
G57522	19.25	12.72	6.53	TMT3S	CL1	G57598	16.69	12.36	4.33	TMO2S	ES50
G57523	19.25	12.99	6.26	TMT3S	CL1	G57599	16.81	12.05	4.76	TMO2S	ES50
G57524	19.25	12.99	6.26	TMT3S	CL1	G57600	16.81	12.05	4.76	TMO2S	ES50
G57533	24.21	16.85	7.36	TMT3S	CL1	G57601	23.27	14.72	8.55	TMU5S	CL1
G57534	24.21	16.85	7.36	TMT3S	CL1	G57602	23.27	14.72	8.55	TMU5S	CL1
G57535	23.31	15.28	8.03	TMC3S	CL3	G57603	21.73	14.13	7.6	TMC0	CL1
G57536	23.31	15.28	8.03	TMC3S	CL3	G57604	21.73	14.13	7.6	TMC0	CL1
G57539	21.38	14.53	6.85	TMT3S	CL1	G57605	24.09	16.85	7.24	TMT3S	CL1
G57540	21.38	14.53	6.85	TMT3S	CL1	G57606	24.09	16.85	7.24	TMT3S	CL1
G57541	20.79	13.82	6.97	TMC0	CL1	G57607	19.06	12.76	6.3	TMU2S	ES19
G57542	20.79	13.82	6.97	TMC0	CL1	G57608	18.98	13.35	5.63	TMU3S	CL1
G57543	20.16	13.39	6.77	TMT3S	CL3	G57609	18.98	13.35	5.63	TMU3S	CL1
G57544	20.16	13.39	6.77	TMT3S	CL3	G57612	25.94	17.83	8.11	TMT3S	CL3
G57545	20.79	17.83	2.96	TMT3S	CL3	G57613	25.94	17.83	8.11	TMT3S	CL3
G57546	20.79	17.83	2.96	TMT3S	CL3	G57614	22.24	15.91	6.33	TMU3S	CL3
G57549	22.8	15.47	7.33	TMC3S	CL1	G57615	22.24	15.91	6.33	TMU3S	CL3
G57550	22.8	15.47	7.33	TMC3S	CL1	G57628	21.3	15.24	6.06	TMT3S	CL1
G57557	15.24	10.55	4.69	TMC3S	LP3	G57629	21.3	15.24	6.06	TMT3S	CL1
G57558	19.09	12.52	6.57	TMT3S	CL1	G57634	23.9	15.75	8.15	TMT3S	CL3
G57559	16.61	10.61	6	TMT3S	CL1	G57635	23.9	15.75	8.15	TMT3S	CL3
G57560	24.69	16.89	7.8	TMT3S	CL1	G57640	20.79	14.57	6.22	TMT3S	CL1
G57561	24.69	16.89	7.8	TMT3S	CL1	G57641	20.79	14.57	6.22	TMT3S	CL1
G57562	23.31	15.98	7.33	TMT3S	CL1	G57642	23.78	14.88	8.9	TMU3S	CL3
G57563	23.31	15.98	7.33	TMT3S	CL1	G57643	23.78	14.88	8.9	TMU3S	CL3
G57564	25.31	16.54	8.77	TMT3S	CL3	G57644	19.72	13.07	6.65	TMT3S	CL1
G57565	25.31	16.54	8.77	TMT3S	CL3	G57645	19.72	13.07	6.65	TMT3S	CL1
G57566	20.55	13.43	7.12	TMT3S	CL1	G57646	15.04	10.71	4.33	TMC3S	ES49
G57567	20.55	13.43	7.12	TMT3S	CL1	G57647	15.04	10.75	4.29	TMC3S	ES49
G57568	18.82	12.13	6.69	TMU2S1B	ES104	G57648	21.69	16.14	5.55	TMC3S	CL3
G57569	18.82	12.13	6.69	TMU2S1B	ES104	G57649	21.69	16.14	5.55	TMC3S	CL3
G57572	14.8	10.75	4.05	TMU3S	ES75	G57650	24.53	16.5	8.03	TMU3S	CL3
G57573	14.8	10.75	4.05	TMU3S	ES89	G57651	24.53	16.5	8.03	TMU3S	CL3
G57574	23.39	14.92	8.47	TMU5S	CL1	G57658	24.53	16.5	8.03	TMU3S	CL3
G57575	23.39	14.92	8.47	TMU5S	CL1	G57659	24.53	16.5	8.03	TMU3S	CL3
G57576	25.31	16.56	8.75	TMU2S	ES199	G57663	23.27	16.1	7.17	TMC3S	CL3
G57577	21.93	14.8	7.13	TMT3S	CL1	G57664	23.27	16.1	7.17	TMC3S	CL3
G57578	21.93	14.8	7.13	TMT3S	CL1	G57665	23.27	16.65	6.62	TMC3S	CL3
G57579	20.28	13.5	6.78	TMU2S	ES19	G57666	23.27	16.65	6.62	TMC3S	CL3
G57582	24.17	16.5	7.67	TMU4S	CL1	G57673	20.87	14.45	6.42	TMT3S	CL1

SPECIFICATIONS BY PART NUMBER

ULTRA READYMOUNTS (CONT'D)

CATALOG PART NO.	EXTENDED LENGTH	COLLAPSED LENGTH	STROKE	UPPER MTG CODE	LOWER MTG CODE	CATALOG PART NO.	EXTENDED LENGTH	COLLAPSED LENGTH	STROKE	UPPER MTG CODE	LOWER MTG CODE
G57674	20.87	14.45	6.42	TMT3S	CL1	G57734	23.5	16.73	6.77	TMT3S	CL1
G57675	16.65	11.06	5.59	TMO2S	ES107	G57735	23.5	16.73	6.77	TMT3S	CL1
G57676	23.27	15.79	7.48	TMC3S	ES107	G57738	19.49	12.72	6.77	TMT3S	CL3
G57677	23.27	15.79	7.48	TMC3S	ES107	G57739	19.49	12.72	6.77	TMT3S	CL3
G57680	21.73	15.28	6.45	TMT3S	LP6	G57740	19.65	13.27	6.38	TMT3S	CL3
G57682	15.71	10.94	4.77	TMO2S	ES46	G57741	19.65	13.27	6.38	TMT3S	CL3
G57689	23.62	15.75	7.87	TMT3S	CL1	G57742	19.06	13.66	5.4	TMT3S	CL3
G57690	23.62	15.75	7.87	TMT3S	CL1	G57743	19.06	13.66	5.4	TMT3S	CL3
G57691	22.68	15.39	7.29	TMS4S	CL3	G57744	21.1	14.09	7.01	TMC4S	CL1
G57692	22.68	15.39	7.29	TMS4S	CL3	G57745	21.1	14.09	7.01	TMC4S	CL1
G57693	22.68	15.39	7.29	TMS4S	CL3	G57746	21.1	14.09	7.01	TMC4S	CL1
G57694	22.68	15.39	7.29	TMS4S	CL3	G57747	21.1	14.09	7.01	TMC4S	CL1
G57695	24.61	17.05	7.56	TMT3S	CL1	G57748	19.21	14.72	4.48	TMC3S	ES56
G57696	24.61	17.05	7.56	TMT3S	CL1	G57749	22.32	16.14	6.18	TMO3S	LU1
G57697	23.15	15.04	8.11	TMC4S	CL1	G57750	19.09	12.36	6.73	TMT3S	CL1
G57698	23.15	15.04	8.11	TMC4S	CL1	G57751	19.09	12.36	6.73	TMT3S	CL1
G57699	23.15	15.04	8.11	TMC4S	CL3	G57752	22.36	14.8	7.55	TMC3S	CL3
G57700	23.15	15.04	8.11	TMC4S	CL3	G57753	22.36	14.8	7.55	TMC3S	CL3
G57701	19.76	13.5	6.26	TMT3S	CL1	G57754	23.26	14.8	8.46	TMT3S	CL3
G57702	19.76	13.5	6.26	TMT3S	CL1	G57755	23.26	14.8	8.46	TMT3S	CL3
G57703	17.13	10.94	6.19	TMO2S	ES107	G57756	22.32	15.2	7.12	TMT3S	CL3
G57704	21.25	15	6.25	TMT3S	CL3	G57757	22.32	15.2	7.12	TMT3S	CL3
G57705	21.25	15	6.25	TMT3S	CL3	G57758	21.42	13.94	7.48	TMT3S	CL3
G57706	18.94	13.11	5.83	TMO2S	ES107	G57759	21.42	13.94	7.48	TMT3S	CL3
G57709	20.59	14.29	6.3	TMS3S	CL1	G57764	31.69	26.26	5.43	TMO3S	LU4
G57710	20.2	13.07	7.13	TMT3S	CL1	G57765	31.69	26.26	5.43	TMO3S	LU4
G57711	20.2	13.07	7.13	TMT3S	CL1	G57768	22.44			TMT3S	n/a
G57712	19.96	13.66	6.3	TMT3S	CL3	G57769	22.44			TMT3S	n/a
G57713	19.96	13.66	6.3	TMT3S	CL3	G57772	23.39	16.38	7.01	TMT3S	CL3
G57714	25.31	17.28	8.03	TMS4S	n/a	G57773	23.39	16.38	7.01	TMT3S	CL3
G57715	25.31	17.28	8.03	TMS4S	n/a	G57774	19.76	13.23	6.53	TMT3S	LP3
G57716	22.02	10.06	11.96	TMC0	n/a	G57775	19.76	13.23	6.53	TMT3S	LP3
G57717	22.02	10.06	11.96	TMC0	n/a	G57776	22.17	15.79	6.38	TMT3S	CL1
G57720	23.78	16.06	7.72	TMT3S	CL1	G57777	22.17	15.79	6.38	TMT3S	CL1
G57721	23.78	16.06	7.72	TMT3S	CL1	G57778	18.94	13.23	5.71	TMU3S	CL3
G57722	19.48	12.72	6.77	TMT3S	n/a	G57779	18.94	13.23	5.71	TMU3S	CL3
G57723	19.48	12.72	6.77	TMT3S	n/a	G57780	22.55	16.73	5.82	TMT3S	n/a
G57724	17.91	11.34	6.57	TMT3S	LP3	G57781	22.55	16.73	5.82	TMT3S	n/a
G57725	17.91	11.34	6.57	TMT3S	LP3	G57782	23.62	15.9	7.71	TMT3S	n/a
G57726	21.18	14.45	6.73	TMT3S	LP3	G57783	23.62	15.9	7.71	TMT3S	n/a
G57727	21.18	14.45	6.73	TMT3S	CL3	G57784	21.54	14.53	7.01	TMT3S	CL1
G57730	23.46	16.77	6.69	TMT3S	CL1	G57785	21.54	14.53	7.01	TMT3S	CL1
G57731	23.46	16.77	6.69	TMT3S	CL1	G57786	20.51	16.81	3.7	TMT3S	n/a
G57732	23.74	16.3	7.44	TMT3S	CL1	G57790	26.34	18.19	8.15	TMT3S	CL1
G57733	23.74	16.3	7.44	TMT3S	CL1	G57791	26.34	18.19	8.15	TMT3S	CL1

SPECIFICATIONS BY PART NUMBER

ULTRA READYMOUNTS (CONT'D)

CATALOG PART NO.	EXTENDED LENGTH	COLLAPSED LENGTH	STROKE	UPPER MTG CODE	LOWER MTG CODE	CATALOG PART NO.	EXTENDED LENGTH	COLLAPSED LENGTH	STROKE	UPPER MTG CODE	LOWER MTG CODE
G57792	17	12	5	TMO2S	n/a	G57804	19.9	13.62	6.28	TMT3S	CL1
G57793	17	12	5	TMO2S	n/a	G57812	20.63	13.94	6.69	TMC3B	CL1
G57794	19.05	12.75	6.3	TMO2S	n/a	G57816	27.17	18.98	8.19	TMT3S	LP4
G57799	19.29	13.38	5.9	TMO2S	n/a	G57817	20.83	13.94	6.89	TMC3B	CL1
G57800	26.73	19.49	7.24	TMU2B1S	LP4	G57818	20.83	13.94	6.89	TMC3B	CL1
G57801	26.73	19.49	7.24	TMU2B1S	LP4	G57819	23.15	15.04	8.11	TMC4S	CL1
G57802						G57820	23.15	15.04	8.11	TMC4S	CL1
G57803	19.9	13.62	6.28	TMT3S	CL1						

ULTRA SHOCKS

CATALOG PART NO.	EXTENDED LENGTH	COLLAPSED LENGTH	STROKE	UPPER MTG CODE	LOWER MTG CODE	CATALOG PART NO.	EXTENDED LENGTH	COLLAPSED LENGTH	STROKE	UPPER MTG CODE	LOWER MTG CODE
69420	22.81	14.68	8.13	S1	EB3	69757	24.6	17.54	7.06	S1	ES85
69450	26.25	16	10.25	S48	EB5	69766	17.48	10.95	6.53	S36	EB21
69462	24.11	15.01	9.10	S50	ES80	69787	17.79	11.53	6.26	ES27	ES19
69464	24.2	15.93	8.27	S70	ES41	69795	15.2	9.59	5.61	S12	ES110
69465	17.94	12.78	5.16	ES162	ES65	69811	13.6	9.69	3.91	S36	BP14
69473	18.29	11.43	6.86	ES85	ES30	69813	24.26	14.15	10.11	S1	EB1
69574	20.26	12.5	7.76	S36	ES7	69845	19.2	13.94	5.26	S36	ES143
69575	20.16	12.4	7.76	S36	ES162	69863	24.43	14.91	9.52	S27	ES18
69585	22.5	13.99	8.51	BP18	ES18	69877	20.94	14.76	6.18	S26	ES3
69586	23.5	15.62	7.88	S20	ES89	69898	19.85	14.19	5.66	S1	ES83
69587	15.9	10.64	5.26	ES19	ES56	69900	24.91	14.8	10.11	S1	ES67
69589	17.54	11.53	6.01	ES19	ES59	69901	16.69	10.51	6.18	S52	ES143
69590	17.82	11.21	6.61	S58	ES59	69903	21.69	12.99	8.70	S27	ES18
69591	17.73	11.72	6.01	ES185	ES185	69907	23.35	15.16	8.19	S50	ES113
69592	20.07	12.56	7.51	S1	ES107	69909	16.63	10.88	5.75	ES69	ES69
69593	20.07	12.56	7.51	S1	ES107	69945	26.35	16.45	9.90	S19	ES84
69594	19.42	12.41	7.01	EB1	ES34	69946	24.04	14.33	9.71	S25	ES6
69595	20.34	12.83	7.51	EB1	ES34	69952	21.45	18.38	3.07	S33	ES3
69600	13.61	8.75	4.86	S1	BP30	69962	21.11	15.1	6.01	S36	LU1
69604	20.64	12.78	7.86	BP31	EB1	69966	17.62	11.27	6.35	S33	ES3
69606	20.2	12.34	7.86	S1	EB1	69996	19.1	15.04	4.06	S36	ES169
69622	14.73	9.62	5.11	ES10	EB1	69998	17.91	14.09	3.82	S67	ES92
69624	21.7	12.84	8.86	BP14	S1	70000	19.57	12.09	7.48	S64	ES113
69625	14.11	9	5.11	S1	BP19	70001	22.52	13.94	8.58	BP34	ES72
69632	21.78	13.42	8.36	ES84	ES84	70003	26.55	18.62	7.93	S34	ES147
69675	14.61	9.25	5.36	S1	BP7	70010	22.56	14.09	8.47	BP15	ES69
69676	19.7	11.84	7.86	S1	EB1	70013	22.95	14.88	8.07	S44	ES113
69677	18.45	11.34	7.11	S1	ES8	70020	21.89	13.14	8.75	S60	ES53
69714	14.1	9.94	4.16	S1	BP17	70024	23.39	19.48	3.9	S84	ES114
69715	13.98	9.37	4.61	ES18	ES110	70027	17.82	12.95	4.88	ES29	ES141
69724	22.14	13.28	8.86	BP31	EB1	70028	25.39	16.42	8.98	S96	ES197
69725	21.6	13.09	8.51	S1	ES69	70031	21.89	14.41	7.48	S53	LU2
69755	20.45	12.34	8.11	S1	ES185	70033	22.44	15.51	6.93	S37	ES205

SPECIFICATIONS BY PART NUMBER

ULTRA SHOCKS (CONT'D)

CATALOG PART NO.	EXTENDED LENGTH	COLLAPSED LENGTH	STROKE	UPPER MTG CODE	LOWER MTG CODE	CATALOG PART NO.	EXTENDED LENGTH	COLLAPSED LENGTH	STROKE	UPPER MTG CODE	LOWER MTG CODE
70034	22.95	17.39	5.55	S30	ES18	G511044	20.31	15.08	5.23	S1	ES26
70036	23.86	14.49	9.36	S18	ES107	G511078	26.38	16.46	9.92	S34	ES50
70037	21.34	13.7	7.64	S75	LP1	G511092	21.54	14.33	7.21	S1	ES26
70038	23.11	15.67	7.44	S22	ES78	G511122	24.45	16.95	7.5	S90	ES61
70039	16.69	10.51	6.18	S3	ES56	G511123	25.96	16.61	9.35	S90	ES61
70040	18.03	11.38	6.65	S66	ES54	G511134	27.95	18.74	9.21	S34	ES65
70041	21.38	14.8	6.57	S18	ES69	G511135	20.67	13.78	6.89	S34	ES83
70045	20.51	14.37	6.14	S74	S54	G511142	27.01	20.71	6.3	S91	LU1
70049	21.57	15.08	6.5	S75	LU1	G51254	21.3	14.30	7	S51	ES178
70052	26.41	16.18	10.23	S34	ES69	G51721	24.88	17.95	6.94	S55	ES87
70053	23.81	14.52	9.28	S95	ES85	G51725	21.12	14.62	6.5	S90	LU2
70055	23.89	14.84	9.05	S96	ES199	G51783	24.41	14.45	9.96	S96	ES205
70056	27.67	18.54	9.13	S34	ES65	G51798	15.35	11.1	4.25	S61	ES61
70059	22.2	13.77	8.43	S101	ES153	G51799	23.03	14.65	8.38	S71	ES48
70060	20.78	17.28	3.5	S50	ES102	G51802	20.83	14.09	6.74	S51	LP2
70064	20.31	15.23	5.07	S99	ES3	G51803	14.41	10.12	4.29	S61	ES61
70065	19.8	12.75	7.04	S37	ES3	G51804	26.18	15.83	10.35	S88	ES214
70068	22.52	14.88	7.63	S46	LU1	G51805	27.13	16.61	10.52	S88	ES214
70078	19.68	12.12	7.55	S61	ES34	G51807	21.93	17.48	4.45	S47	ES69
70086	25.27	18.66	6.61	S56	ES19	G51812	19.96	13.94	6.02	S87	LU2
70089	20.43	16.45	3.97	S51	LU2	G51841	20.98	14.29	6.69	S50	ES199
70095	15.27	10.02	5.23	ES19	EB19	G51871	15.7	11.77	3.93	S71	LU1
70096	23.14	15.27	7.87	S97	LU2	G51874	20.43	16.41	4.01	S90	LU2
70098	15.03	10.47	4.56	ES19	ES69	G51884	16.53	13.5	3.03	S1	ES88
70102	15.28	10.35	4.93	ES88	ES69	G51904	16.22	11.5	4.72	S55	BP13
70203	17.09	11.57	5.52	ES75	ES113	G51905	23.74	17.79	5.95	S91	ES3
70204	22.24	14.25	7.99	S18	ES56	G51930	22.28	15.27	7	S51	ES152
70207	25.63	16.81	8.82	S34	EB13	G51955	17.32	14.33	2.99	S87	LU2
70208	14.76	10.28	4.48	ES19	ES69	G51965	19.69	12.52	7.17	S71	BP27
70209	22.44	14.72	7.72	S75	LU1	G51966	21.49	14.68	6.81	S97	LU2
70210	17.09	11.85	5.24	ES160	ES113	G51971	25.47	17.60	7.87	S52	ES153
70213	17.09	11.85	5.24	ES160	ES113	G51972	17	12	5	S96	ES50
G51063	21.31	13.05	8.26	S58	ES199	G51975	15.78	11.37	4.4	S38	ES168
G511000	20.91	16.14	4.77	S92	LU1	G51980	24.52	16.41	8.11	S97	LU2
G511001	25.35	16.02	9.33	S34	ES83	G51982	22.24	13.97	8.26	S101	ES60
G511002	28.58	18.77	9.84	S34	ES65	G51983	26.5	18.58	7.92	S34	ES83
G511004	17.12	12.24	4.88	S51	ES107	G51990	23.34	14.68	8.66	S18	ES69
G511007	26.82	16.7	10.12	S95	EB25	G51992					
G511030	24.88	15.04	9.84	S52	ES153	G51993	24.84	15.11	9.72	S20	ES48
G511037	23.23	15.08	8.15	S18	ES3	G51994	23.18	14.88	8.29	n/a	n/a
G511038	25.91	19.21	6.7	S75	ES56	G51996	23.15	15.24	7.91	S97	LU2
G511043	16.85	12.20	4.64	S1	ES61						

SPECIFICATIONS BY PART NUMBER

ULTRA STRUTS

CATALOG PART NO.	EXTENDED LENGTH	COLLAPSED LENGTH	STROKE	UPPER MTG CODE	LOWER MTG CODE	CATALOG PART NO.	EXTENDED LENGTH	COLLAPSED LENGTH	STROKE	UPPER MTG CODE	LOWER MTG CODE
G51077	18.02	12.75	5.27	S88	ES56	G51766	15.56	10.99	4.01	S62	ES49
G51087	17.86	11.91	5.95	S83	ES87	G51767	18.19	12.36	5.83	S104	ES49
G51097	22.83	18.07	4.76	S84	LU3	G51768	16.87	12.12	4.75	S32	ES58
G511003	22.63	15.82	6.81	S83	LU2	G51772	26	17.37	8.63	S4	EB3
G511019	14.21	11.77	2.44	S100	LP2	G51773	18	13.5	4.50	S38	ES51
G511020	14.21	11.77	2.44	S100	LP2	G51774	16.73	11.88	4.85	S51	LP2
G511054	19.48	15.15	4.33	S88	ES72	G51794	17.28	11.06	6.22	S86	ES19
G511055	19.48	15.15	4.33	S88	ES72	G51795	18.78	12.01	6.77	S64	ES214
G51252	18.82	12.02	6.8	S54	ES81	G51806	15.74	11.34	4.41	S60	LP3
G51255	15.76	11.54	4.22	S48	LP2	G51810	19.17	13.27	5.90	S91	LP3
G51256	22.66	15.45	7.22	S48	LP2	G51811	19.17	13.27	5.90	S91	LP3
G51267	14.25	10.7	3.54	S60	LP3	G51813	23.98	19.21	4.77	S92	LU1
G51268	24.48	16.97	7.16	S82	CL1	G51814	23.98	19.21	4.77	S92	LU1
G51279	16.37	11.07	5.3	S51	ES45	G51815	18.07	13.46	4.61	S97	LU1
G51286	15.65	10.84	4.81	S49	ES204	G51825	22.48	16.1	6.38	S51	ES152
G51477	18.14	13.36	4.78	S38	ES153	G51832	22.13	17.48	4.65	S92	ES49
G51700	14.68	10.35	4.33	S55	CL5	G51833	25.51	16.29	9.21	S92	ES49
G51703	20.6	16.65	3.95	S55	ES184	G51836	19.53	16.69	2.83	S38	ES197
G51704	21.69	16.62	5.07	S55	ES184	G51838	19.02	12.72	6.3	S86	ES19
G51712	21.1	14.80	6.3	S90	ES104	G51842	19.05	12.75	6.30	S51	ES19
G51713	22	15.69	6.31	S90	ES104	G51847	24.8	17.04	7.76	S49	ES61
G51714	16.79	11.99	4.8	S102	LP2	G51848	21.41	13.66	7.75	S90	ES88
G51715	14.92	10.43	4.49	S89	ES49	G51849	17.95	12.36	5.59	S118	ES206
G51716	14.68	10.35	4.33	S48	ES112	G51850	16.1	11.06	5.04	S96	ES56
G51718	16.61	11.41	5.2	S48	LP3	G51852	13.89	10.66	3.23	S32	ES71
G51719	19.84	15.70	4.14	S55	ES77	G51853	16.85	12	4.84	S80	ES56
G51722	18.93	16.73	2.2	S38	ES159	G51854	16.85	12	4.84	S80	ES56
G51723	18.93	16.73	2.2	S38	ES159	G51855	23.26	17.55	5.7	S61	ES67
G51724	19.28	13.69	5.59	S38	ES162	G51856	21.18	15.11	6.07	S92	LU1
G51727	17.62	12.87	4.75	S90	ES18	G51858	15.35	11.18	4.17	S96	ES50
G51728	13.87	9.62	4.25	S102	LP6	G51859	18.5	14.29	4.21	S91	LP3
G51729	21.5	14.26	7.24	S55	ES77	G51860	19.96	16.29	3.67	S32	ES77
G51736	16.5	11.50	5	S32	ES104	G51861	19.21	15.15	4.05	S32	ES77
G51737	17.12	12.50	4.62	S86	LP3	G51863	20.3	12.48	7.83	S90	ES88
G51738	24.57	17.09	7.48	S50	ES202	G51864	21.57	17.16	4.41	S38	ES77
G51739	21.36	16.79	4.57	S98	ES153	G51865	20.86	16.45	4.41	S38	ES77
G51740	24.5	19	5.50	SS4	LU1	G51870	17.76	12.87	4.76	S101	BP37
G51742	22.12	17.37	4.75	S2	ES85	G51877	17.67	12.91	4.76	S49	LP3
G51746	22.12	17.37	4.75	SS2	BP36	G51878	17.67	12.91	4.76	S49	LP3
G51756	20.37	17.75	2.62	S38	ES50	G51879	15.67	10.94	4.73	S45	ES50
G51758	21.5	15.34	5.85	S66	LU1	G51880	18.42	12	6.42	S45	ES197
G51759	23.25	15.12	8.12	SS2	ES63	G51881	16.57	11.65	4.92	S27	ES52
G51760	25.17	19.37	5.8	S32	LU2	G51883	19.52	12.48	7.04	S18	ES152
G51761	25.17	19.37	5.8	S32	LU2	G51887	15.55	12.08	3.47	S38	ES95
G51765	15.56	10.99	4.01	S62	ES49	G51888	15.55	12.08	3.47	S115	ES209

SPECIFICATIONS BY PART NUMBER

ULTRA STRUTS (CONT'D)

CATALOG PART NO.	EXTENDED LENGTH	COLLAPSED LENGTH	STROKE	UPPER MTG CODE	LOWER MTG CODE	CATALOG PART NO.	EXTENDED LENGTH	COLLAPSED LENGTH	STROKE	UPPER MTG CODE	LOWER MTG CODE
G51891	17.8	13.54	4.26	S101	BP37	G52019	19.17	12.64	6.53	S104	CL1
G51892	23	15.86	7.14	S48	LU2	G52022	21.42	13.66	7.76	S104	CL1
G51896	18.54	14.09	4.45	S91	LP3	G52023	19.84	13.54	6.30	S100	CL1
G51897	18.54	14.09	4.45	S91	LP3	G52024	19.84	13.54	6.30	S100	CL1
G51898	16.57	12.09	4.49	S80	ES214	G52025	19.61	13.15	6.46	S105	CL1
G51899	17.04	11.73	5.31	S102	LP2	G52026	22.8	14.84	7.96	S105	CL1
G51900	22.83	14.92	7.91	S64	ES93	G52027	22.8	14.84	7.96	S105	CL1
G51901	22.4	19.32	3.07	S52	BP6	G52032	21.54	14.13	7.41	S92	CL1
G51906	20.07	14.49	5.59	S45	LU1	G52033	21.54	14.13	7.41	S92	CL1
G51908	17.44	11.3	6.14	S47	ES19	G52036	19.37	15.04	4.33	S61	ES56
G51910	18.03	12.36	5.67	S104	ES49	G52037	19.37	15.04	4.33	S61	ES56
G51911	18.86	15	3.86	S48	LP2	G52038	20.04	13.11	6.93	S80	CL1
G51914	15.16	10.94	4.21	S48	ES61	G52039	20.04	13.11	6.93	S80	CL1
G51916	16.33	11.22	5.11	S38	ES168	G52081	22.83	16.3	6.53	S92	CL1
G51917	17.68	12.91	4.76	S18	LP2	G52082	22.83	16.3	6.53	S92	CL1
G51918	17.68	12.91	4.76	S18	LP2	G52094	17.28	13.03	4.25	S92	CL1
G51919	23.31	15.79	7.52	S102	LU2	G52095	17.28	13.03	4.25	S92	CL1
G51920	20.9	16.88	4.01	S92	ES49	G52096	20.7	13.42	7.28	S103	CL1
G51921	20.9	16.88	4.01	S92	ES49	G52097	20.7	13.42	7.28	S103	CL1
G51922	20.91	16.64	4.25	S61	ES167	G52098	20.6	13.85	6.75	S92	CL1
G51925	20.9	17.71	3.18	S100	LU1	G52103	24.13	15.82	8.31	S103	CL1
G51926	20.9	17.71	3.18	S100	LU1	G52104	24.13	15.82	8.31	S103	CL1
G51928	21.33	15.55	5.78	S84	ES147	G52105	23.3	16.57	6.73	S103	CL1
G51933	19.8	12.48	7.32	S91	ES152	G52106	23.3	16.57	6.73	S103	CL1
G51934	16.37	11.57	4.8	S26	ES93	G52107	23.22	16.18	7.04	S103	CL3
G51935	17	12.16	4.84	S55	BP27	G52108	23.22	16.18	7.04	S103	CL3
G51937	21.77	17.79	3.97	S88	ES67	G52110	18.14	11.96	6.19	S105	LP4
G51947	24.96	19.29	5.67	S118	LU2	G52111	18.14	11.96	6.19	S105	LP4
G51948	24.96	19.29	5.67	S118	LU2	G52112	21.41	14	7.41	S95	CL1
G51949	18.27	14.49	3.78	S101	BP37	G52113	21.41	14	7.41	S95	CL1
G51961	18.93	13.11	5.82	S91	ES107	G52116	19.29	13.07	6.22	S107	CL1
G51969	19.33	12.51	6.81	S102	ES152	G52117	21.69	14.76	6.93	S92	CL3
G51979	15.7	11.38	4.32	n/a	n/a	G52118	21.69	14.76	6.93	S92	CL3
G51981	15.7	11.38	4.32	n/a	n/a	G52121	17.51	13.3	4.21	S100	CL1
G51995	21.93	15.55	6.38	S61	ES215	G52122	17.51	13.3	4.21	S100	CL1
G52004	21.02	14.69	6.33	S103	CL1	G52125	22	14.13	7.87	S108	CL1
G52005	19.02	11.81	7.21	S104	LP1	G52127	23.3	15.6	7.7	S106	CL1
G52006	19.02	11.81	7.21	S104	LP1	G52128	23.3	15.6	7.7	S106	CL1
G52007	21.02	14.69	6.33	S103	CL1	G52129	17.82	11.49	6.34	S105	LP4
G52008	22.2	15.04	7.16	S92	CL1	G52130	17.82	11.49	6.34	S105	LP4
G52009	22.2	15.04	7.16	S92	CL1	G52131	22.71	15.74	6.97	S92	CL1
G52013	20.52	13.5	7.02	S103	CL1	G52140	24.13	16.97	7.16	S38	CL1
G52014	20.52	13.5	7.02	S103	CL1	G52141	24.13	16.97	7.16	S38	CL1
G52017	21.77	13.9	7.87	S80	CL1	G52142	18.38	14.05	4.33	S109	LP3
G52018	21.77	13.9	7.87	S80	CL1	G52143	18.38	14.05	4.33	S109	LP3

SPECIFICATIONS BY PART NUMBER

ULTRA STRUTS (CONT'D)

CATALOG PART NO.	EXTENDED LENGTH	COLLAPSED LENGTH	STROKE	UPPER MTG CODE	LOWER MTG CODE	CATALOG PART NO.	EXTENDED LENGTH	COLLAPSED LENGTH	STROKE	UPPER MTG CODE	LOWER MTG CODE
G52144	20.35	15.39	4.96	S67	CL1	G52238	19.64	14.92	4.72	S116	LP6
G52145	20.35	15.39	4.96	S67	CL1	G52244	23.15	15.82	7.33	S111	CL1
G52148	22.12	14.76	7.36	S90	ES88	G52245	20.51	13.39	7.13	S103	CL1
G52149	22.12	14.76	7.36	S90	ES88	G52246	20.51	13.39	7.13	S103	CL1
G52150	24.68	16.69	7.99	S81	CL1	G52247	20.78	13.66	7.12	S92	CL1
G52151	24.68	16.69	7.99	S81	CL1	G52248	20.78	13.66	7.12	S92	CL1
G52152	21.77	13.93	7.84	S100	CL1	G52249	25.35	16.57	8.77	S104	CL1
G52153	21.77	13.93	7.84	S100	CL1	G52250	17.34	11.25	6.08	S104	CL1
G52154	19.29	12.52	6.77	S100	CL1	G52253	25.35	16.57	8.77	S104	CL3
G52155	19.29	12.52	6.77	S100	CL1	G52254	25.35	16.57	8.77	S104	CL3
G52156	19.84	12.59	7.25	S100	CL1	G52255	20.03	13.22	6.81	S80	CL1
G52157	19.84	12.59	7.25	S100	CL1	G52256	20.03	13.22	6.81	S80	CL1
G52158	23	15.94	7.06	S80	CL3	G52257	23.5	15.59	7.91	S100	CL1
G52159	23	15.94	7.06	S80	CL3	G52258	23.5	15.59	7.91	S100	CL1
G52160	19.68	13.15	6.53	S100	CL1	G52260	25.31	17.28	8.02	S110	CL1
G52161	19.68	13.15	6.53	S100	CL1	G52261	25.31	17.28	8.02	S110	CL1
G52162	22.2	14.13	8.07	S92	CL1	G52264	19.48	12.72	6.77	S103	CL1
G52163	22.2	14.13	8.07	S92	CL1	G52265	19.48	12.72	6.77	S103	CL1
G52164	16.25	10.78	5.47	S109	LP4	G52270	25.94	17.59	8.34	S112	CL5
G52165	16.25	10.78	5.47	S109	LP4	G52271	13.26	8.46	4.8	S39	CL5
G52167	21.22	13.81	7.41	S92	CL1	G52272	20.23	14.68	5.55	S92	CL1
G52168	21.61	14.17	7.44	S92	CL1	G52273	20.23	14.68	5.55	S92	CL1
G52169	21.61	14.17	7.44	S92	CL1	G52274	19.72	13.19	6.54	S104	LP1
G52170	20.9	16.02	4.88	S92	CL1	G52275	19.72	13.19	6.54	S104	LP1
G52171	20.9	16.02	4.88	S92	CL1	G52276	18.3	11.3	7.01	S92	LP1
G52172	20.66	16.32	4.33	S110	CL3	G52278	19.45	13.5	5.94	S122	CL1
G52173	21.61	15.23	6.38	S100	CL1	G52279	19.45	13.5	5.94	S122	CL1
G52174	21.61	15.23	6.38	S100	CL1	G52280	19.48	12.87	6.61	S122	CL1
G52175	20.86	13.85	7	S110	CL1	G52281	19.48	12.87	6.61	S122	CL1
G52176	20.86	13.85	7	S110	CL1	G52282	20.83	13.86	6.97	S120	CL1
G52182	25.35	16.18	9.17	S80	CL1	G52283	20.83	13.86	6.97	S120	CL1
G52183	25.35	16.18	9.17	S80	CL1	G52293	24.4	15.59	8.81	S80	CL1
G52184	22.75	14.96	7.79	S110	CL1	G52294	24.4	15.59	8.81	S80	CL1
G52185	22.75	14.96	7.79	S110	CL1	G52295	20.43	15.78	4.63	S111	CL1
G52187	23.26	14.8	8.46	S104	CL1	G52297	16.45	11.14	5.31	S104	LP1
G52188	23.26	14.8	8.46	S104	CL1	G52298	16.45	11.14	5.31	S104	LP1
G52199	19.44	14.76	4.68	S116	LP6	G52299	20.62	15.11	5.51	S80	CL1
G52200	19.44	14.76	4.68	S116	LP6	G52300	20.62	15.11	5.51	S80	CL1
G52201	22.51	15.94	6.57	S103	CL1	G52301	20.23	14.68	5.55	S114	LP5
G52202	22.51	15.94	6.57	S103	CL1	G52314	20.98	16.34	4.65	S116	LP3
G52203	26.33	17.95	8.38	S116	CL1	G52329	20.74	13.5	7.24	S92	CL1
G52204	26.33	17.95	8.38	S116	CL1	G52330	20.74	13.5	7.24	S92	CL1
G52209	19.21	13.18	6.03	S110	CL1	G52331	19.48	12.71	6.77	S103	CL1
G52210	25.7	17	8.69	S110	CL1	G52332	19.48	12.71	6.77	S103	CL1
G52237	19.64	14.92	4.72	S116	LP6	G52333	22.44	13.78	8.66	S80	CL1

SPECIFICATIONS BY PART NUMBER

ULTRA STRUTS (CONT'D)

CATALOG PART NO.	EXTENDED LENGTH	COLLAPSED LENGTH	STROKE	UPPER MTG CODE	LOWER MTG CODE	CATALOG PART NO.	EXTENDED LENGTH	COLLAPSED LENGTH	STROKE	UPPER MTG CODE	LOWER MTG CODE
G52334	22.44	13.78	8.66	S80	CL1	G55615	16.26	11.06	5.2	S92	CL1
G52335	21.46	14.06	7.4	S92	CL1	G55661	19.57	11.76	7.81	S114	CL1
G52336	21.46	14.06	7.4	S92	CL1	G55662	19.57	11.76	7.81	S114	CL1
G52348	26.37	21.53	4.84	S84	LU5	G55675	20.84	12.64	8.20	S116	CL1
G52349	26.37	21.53	4.84	S84	LU5	G55676	20.84	12.64	8.2	S116	CL1
G52351	24.13	16.69	7.44	S105	CL3	G55681	22.44	12.17	10.27	S118	CL1
G52352	24.13	16.69	7.44	S105	CL3	G55697	19.7	13.19	6.51	S106	CL1
G52353	20.07	13.93	6.14	S100	CL1	G55698	19.92	13.14	6.78	S103	CL1
G52354	20.07	13.93	6.14	S100	CL1	G55772	20.35	13.85	6.5	S104	LP3
G52355	20.43	15.86	4.56	S92	CL1	G55774	15.24	10.55	4.7	S45	LP2
G52356	20.43	15.86	4.56	S92	CL1	G55804	18.55	12.05	6.49	S88	ES57
G52360	24.6	17.04	7.55	S61	CL1	G55820	16	11.25	4.75	S51	LP2
G52361	24.6	17.04	7.55	S61	CL1	G55821	23.3	15.95	7.35	S50	ES20
G52367	24.09	15.90	8.18	S103	CL1	G55825	22.88	17.33	5.55	S114	CL1
G52368	24.09	15.90	8.18	S103	CL1	G55856	23.37	14.26	9.11	S103	LP3
G52374	21.25	15	6.25	S103	CL1	G55870	16.78	11.56	5.22	S86	LP3
G52375	21.25	15	6.25	S103	CL1	G55879	16.51	10.28	6.23	S116	CL1
G52382	17.28	13.3	3.97	S100	CL1	G55892	20.19	14.09	6.9	S117	CL1
G52383	17.28	13.3	3.97	S100	CL1	G55896	20.2	14.1	6.10	S117	CL1
G52395	19.48	12.87	6.61	S103	CL1	G55901	20.41	13.65	6.76	S111	LP4
G52396	19.48	12.87	6.61	S103	CL1	G55909	15.32	10.38	4.95	S49	LP3
G52398	18.62	11.29	7.32	S105	LP4	G55910	19.23	13.09	6.14	S49	LU1
G52399	18.62	11.29	7.32	S105	LP4	G55911	16.22	9.72	6.5	S18	LU2
G52406	22.16	15.66	6.49	S108	CL1	G55948	16.5	10.71	5.79	S105	CL1
G52410	19.76	13.23	6.53	S104	LP3	G55949	23.13	16.09	7.05	S111	CL1
G52411	19.76	13.22	6.53	S104	LP3	G55990	17.93	11.32	6.61	S103	CL1
G52435	19.48	13.5	5.98	S122	CL1	G55991	20.87	14.53	6.34	S103	CL1
G52436	19.48	13.5	5.98	S122	CL1	G55993	21.73	15.16	6.57	S103	CL1
G52437	20.7	13.54	2.36	S92	CL1	G55994	21.73	15.16	6.57	S103	CL1
G52438	20.7	13.54	2.36	S92	CL1	G55999	16.79	10.81	5.98	S103	CL1
G52439	19.05	13.58	5.47	S100	CL1	G56506	17.22	10.54	6.68	S116	CL1
G52440	19.05	13.58	5.47	S100	CL1	G56509	16.82	10.66	6.17	S119	CL1
G52449	17.91	13.22	4.68	S104	LP1	G56512	20.5	13.75	6.75	S92	CL1
G52450	17.91	13.22	4.68	S104	LP1	G56513	20.5	13.75	6.75	S92	CL1
G52494	20.87	15.16	5.71	S110	CL1	G56514	17.22	10.54	6.68	S116	CL1
G52495	20.87	15.16	5.71	S110	CL1	G56516	20.22	14.02	6.2	S104	LP1
G52524	21.29	16.41	4.88	S80	CL1	G56517	20.22	13.94	6.28	S104	LP1
G52525	21.29	16.41	4.88	S80	CL1	G56518	15.23	8.83	6.41	S67	CL1
G52906	21.65	16.06	5.59	S104	CL1	G56529	16.9	10.55	6.35	S92	CL1
G52907	21.65	16.06	5.59	S104	CL1	G56530	16.9	10.55	6.35	S92	CL1
G55526	17.41	10.83	6.58	S112	CL1	G56531	18.37	12.62	5.75	S114	CL1
G55551	24.1	14.50	9.6	S113	CL1	G56532	18.37	12.62	5.75	S114	CL1
G55579	20.56	16.32	4.23	S115	LU1	G56533	21.87	14.12	7.75	S110	CL1
G55591	16.94	10.76	6.18	S116	CL1	G56534	21.87	14.12	7.75	S110	CL1
G55600	16.09	9.60	6.49	S103	CL1	G56537	23.39	15.00	8.39	S32	CL1

SPECIFICATIONS BY PART NUMBER

ULTRA STRUTS (CONT'D)

CATALOG PART NO.	EXTENDED LENGTH	COLLAPSED LENGTH	STROKE	UPPER MTG CODE	LOWER MTG CODE	CATALOG PART NO.	EXTENDED LENGTH	COLLAPSED LENGTH	STROKE	UPPER MTG CODE	LOWER MTG CODE
G56538	23.39	15.00	8.39	S32	CL1	G56683	21.12	14.37	6.75	S100	CL1
G56539	19.62	13.37	6.25	S100	CL1	G56684	21.12	14.37	6.75	S100	CL1
G56540	19.62	13.37	6.25	S100	CL1	G56685	21.12	14.37	6.75	S92	CL1
G56554	22.58	14.4	8.18	S103	CL1	G56686	21.12	14.37	6.75	S92	CL1
G56561	23	16.37	6.62	S100	CL1	G56687	22.56	15.98	6.58	S100	CL1
G56562	23	16.37	6.62	S100	CL1	G56688	22.56	15.98	6.58	S100	CL1
G56565	16.77	11.81	4.96	S102	LP3	G56689	19.12	13.12	6	n/a	n/a
G56568	25	17.75	7.25	S117	CL1	G56690	19.12	13.12	6	n/a	n/a
G56569	19.12	12.25	6.87	S84	CL1	G56700	17.19	10.57	6.62	S108	CL1
G56570	19.12	12.25	6.87	S84	CL1	G56701	18.49	11.34	7.15	S100	CL1
G56571	22.12	14.12	8	S110	CL1	G56718	18.63	11.07	7.57	S69	CL1
G56572	20.55	13.66	6.89	S92	CL1	G56721	18.91	11.48	7.43	S116	CL1
G56573	19.87	13.50	6.37	S103	CL1	G56722	18.91	11.48	7.43	S116	CL1
G56576	19.87	13.50	6.37	S103	CL1	G56728	20.95	12.25	8.7	S103	CL1
G56581	20.74	13.59	7.15	S103	CL1	G56729	20.95	12.25	8.7	S103	CL1
G56582	20.74	13.59	7.15	S103	CL1	G56730	23.72	16.95	6.77	S116	CL1
G56591	17.5	12.12	5.37	SS2	ES185	G56731	23.72	16.95	6.77	S116	CL1
G56597	14.5	9.87	4.62	S102	ES61	G56732	22.91	15.41	7.50	S116	CL1
G56598	19.74	15.23	4.51	S95	ES201	G56733	22.91	15.41	7.50	S116	CL1
G56601	25	17.75	7.25	S117	CL1	G56734	24.31	17.32	6.99	S116	CL1
G56606	19.65	13.23	6.42	S114	LP1	G56735	24.31	17.32	6.99	S116	CL1
G56608	17.13	12.2	4.93	S116	LP6	G56750	18.74	12.76	5.98	S116	LP6
G56615	22.62	16.00	6.62	S92	CL1	G56751	18.74	12.76	5.98	S116	LP6
G56616	22.62	16.00	6.62	S92	CL1	G56758	21.75	14.50	7.25	S81	CL1
G56620	18.6	12.14	6.47	S106	CL1	G56759	27.75	14.50	13.25	S81	CL1
G56621	19.12	13.00	6.12	S120	CL1	G56772	20.8	13.38	7.42	S106	CL1
G56622	19.12	13.00	6.12	S120	CL1	G56773	20.94	12.87	8.07	S112	CL1
G56633	20.08	12.52	7.56	S104	CL1	G56774	20.94	12.87	8.07	S112	CL1
G56634	20.08	12.52	7.56	S104	CL1	G56778	21.37	14.37	7	S68	CL1
G56635	16.6	10.42	6.18	S120	CL1	G56781	19.37	14.00	5.37	S92	CL1
G56636	16.6	10.42	6.18	S120	CL1	G56782	19.37	14.00	5.37	S92	CL1
G56637	22.12	14.12	8	S110	CL1	G56784	20.25	14.25	6	S104	CL1
G56640	22.12	14.37	7.75	S92	CL1	G56785	20.25	14.25	6	S104	CL1
G56641	22.12	14.37	7.75	S92	CL1	G56786	13.26	8.46	4.8	S45	CL5
G56642	17.3	11.14	6.16	S92	CL1	G56787	13.26	8.46	4.8	S45	CL5
G56643	17.3	11.14	6.16	S92	CL1	G56791	20.25	16.12	4.13	S110	CL5
G56655	20.03	13.38	6.65	S105	LP4	G56792	19.5	16.12	3.38	S112	CL5
G56660	19.62	13.87	5.75	S103	CL1	G56797	23.82	16.54	7.28	S103	CL1
G56661	19.62	13.87	5.75	S103	CL1	G56798	23.54	16.34	7.2	S103	CL1
G56664	17.86	12.45	5.41	S107	ES215	G56799	21.1	14.53	6.57	S120	CL1
G56671	20.5	13.62	6.87	S92	CL1	G56800	21.1	14.53	6.57	S120	CL1
G56672	20.5	13.61	6.87	S92	CL1	G56802	20.75	14.12	6.63	S111	CL1
G56677	19.87	13.37	6.5	S120	CL1	G56807	21	14.25	6.75	S115	LP4
G56678	19.87	13.37	6.5	S120	CL1	G56809	19.75	13.12	6.62	S117	CL1
G56679	21.26	15.9	5.36	S103	CL1	G56810	20	13.50	6.5	S117	CL1
G56680	21.26	15.9	5.36	S103	CL1	G56814	21.73	15.75	5.98	S100	CL1

SPECIFICATIONS BY PART NUMBER

ULTRA STRUTS (CONT'D)

CATALOG PART NO.	EXTENDED LENGTH	COLLAPSED LENGTH	STROKE	UPPER MTG CODE	LOWER MTG CODE	CATALOG PART NO.	EXTENDED LENGTH	COLLAPSED LENGTH	STROKE	UPPER MTG CODE	LOWER MTG CODE
G56817	16.59	10.9	5.69	S112	CL1	G56842	19.47	13.41	6.06	S32	CL1
G56819	21.35	15.18	6.16	S100	CL1	G56843	19.47	13.41	6.06	S32	CL1
G56820	21.35	15.18	6.16	S100	CL1	G56886	20.09	13.79	6.30	S116	CL1
G56821	23.27	15.90	7.36	S92	CL1	G56887	20.09	13.79	6.30	S116	CL1
G56822	23.27	15.90	7.36	S92	CL1	G56888	21.38	14.49	6.89	S103	CL1
G56836	18.84	13.12	5.72	S100	LP1	G56889	21.38	14.49	6.89	S103	CL1
G56837	18.84	13.12	5.72	S100	LP1	G56892	17.87	12.24	5.63	S100	CL1
G56838	21.06	17.99	3.07	S38	ES208	G56893	17.87	12.24	5.63	S100	CL1
G56839	19.33	13.42	5.91	S38	ES209	G56894	20.98	14.29	6.69	S92	CL1
G56840	20.51	13.63	6.88	S105	CL3	G56899	21.1	14.8	6.30	S114	LP5
G56841	20.51	13.63	6.88	S105	CL3						

ULTRA TRUCK SHOCKS

CATALOG PART NO.	EXTENDED LENGTH	COLLAPSED LENGTH	STROKE	UPPER MTG CODE	LOWER MTG CODE	CATALOG PART NO.	EXTENDED LENGTH	COLLAPSED LENGTH	STROKE	UPPER MTG CODE	LOWER MTG CODE
G63173	21.86	13.58	8.28	EB1	EB1	G63422	24.01	14.48	9.53	BP14	ES34
G63183	20.79	13.01	7.78	EB4	EB4	G63423	16.76	10.73	6.03	ES26	ES26
G63299	18.08	11.55	6.53	EB1	EB1	G63424	20.45	12.67	7.78	S1	BP7
G63306	19.85	12.57	7.28	ES24	ES24	G63425	20.01	12.48	7.53	BP20	EB1
G63347	18.08	11.55	6.53	ES31	ES35	G63426	18.01	11.48	6.53	ES18	ES18
G63349	23.33	14.3	9.03	EB1	ES34	G63432	21.11	12.83	8.28	S1	EB19
G63350	18.82	11.79	7.03	S1	ES25	G63443	23.33	13.95	9.38	EB1	EB1
G63353	24.74	14.96	9.78	ES27	EB4	G63454	22.79	14.01	8.78	ES141	ES141
G63355	14.98	9.95	5.03	EB1	ES24	G63455	22.98	13.95	9.03	ES83	ES83
G63357	14.98	9.95	5.03	ES24	ES24	G63456	26.85	16.07	10.78	EB1	ES83
G63359	13.7	8.92	4.78	S1	BP13	G63461	25.51	15.23	10.28	EB1	ES83
G63360	15.7	9.92	5.78	S1	BP13	G63479	13.95	9.17	4.78	S1	ES113
G63366	23.26	14.23	9.03	ES34	ES34	G63488	26.61	16.33	10.28	BP14	ES34
G63375	14.14	9.11	5.03	S12	BP7	G63489	14.42	9.64	4.78	S29	BP11
G63377	20.08	12.55	7.53	EB1	ES25	G63490	19.08	12.05	7.03	EB1	ES25
G63386	16.11	10.58	5.53	S36	ES25	G63492	22.58	13.8	8.78	EB1	EB1
G63387	23.32	14.04	9.28	S1	ES25	G63494	22.39	13.86	8.53	EB2	EB2
G63394	16.01	10.48	5.53	EB1	ES24	G63495	14.95	9.67	5.28	S1	ES64
G63403	24.58	14.8	9.78	ES26	ES26	G63506	21.4	12.64	8.76	S32	S32
G63404	17.05	11.02	6.03	S1	ES64	G63510	21.29	13.26	8.03	EB19	EB19
G63405	20.01	12.48	7.53	EB1	EB1	G63511	22.45	13.42	9.03	S1	ES25
G63406	22.98	13.95	9.03	EB1	ES83	G63524	27.08	16.05	11.03	EB1	ES185
G63409	21.48	13.2	8.28	EB1	ES185	G63525	22.98	13.95	9.03	EB1	ES185
G63410	18.55	11.77	6.78	S12	EB1	G63547	13.61	9.08	4.53	S1	ES113
G63411	18.58	11.8	6.78	ES31	ES26	G63548	21.11	13.08	8.03	S12	EB19
G63413	20.76	12.98	7.78	ES27	ES27	G63604	19.74	12.46	7.28	EB1	ES142
G63414	15.09	10.06	5.03	S36	ES41	G63605	24.24	14.71	9.53	EB19	ES27
G63418	13.95	9.17	4.78	S1	BP11	G63607	25.58	15.3	10.28	BP14	ES83
G63419	24.08	14.55	9.53	EB1	EB1	G63608	14.56	9.78	4.78	S36	EB1
G63421	13.7	8.92	4.78	S1	BP30	G63609	16.5	10.97	5.53	ES126	ES128

SPECIFICATIONS BY PART NUMBER

ULTRA TRUCK SHOCKS (CONT'D)

CATALOG PART NO.	EXTENDED LENGTH	COLLAPSED LENGTH	STROKE	UPPER MTG CODE	LOWER MTG CODE	CATALOG PART NO.	EXTENDED LENGTH	COLLAPSED LENGTH	STROKE	UPPER MTG CODE	LOWER MTG CODE
G63610	21.95	13.17	8.78	S47	EB1	G63799	18.55	11.77	6.78	S1	ES83
G63611	14.95	9.67	5.28	S1	ES64	G63803	15.36	10.33	5.03	S12	LU1
G63614	15.09	10.06	5.03	S36	EB1	G63808	28.86	17.08	11.78	EB1	ES83
G63615	23.66	13.88	9.78	S38	S38	G63809	22.98	13.95	9.03	EB1	ES83
G63616	23.78	14.25	9.53	S38	EB19	G63810	31.6	18.57	13.03	EB1	ES185
G63620	19.55	12.27	7.28	EB1	S17	G63813	12.23	8.45	3.78	S47	ES64
G63622	15.32	10.29	5.03	S36	EB1	G63815	21.95	13.17	8.78	S47	ES64
G63623	22.57	14.29	8.28	S36	ES83	G63817	15.8	11.02	4.78	S12	ES60
G63624	20.17	12.64	7.53	S36	ES185	G63818	16.51	10.98	5.53	ES126	ES128
G63625	22.56	13.78	8.78	EB1	ES24	G63828	23.16	15.13	8.03	S21	EB20
G63635	14.45	9.42	5.03	S1	ES69	G63829	22.52	13.74	8.78	ES88	ES65
G63638	24.33	14.8	9.53	BP14	ES34	G63832	17.16	11.38	5.78	S21	ES153
G63661	13.8	9.52	4.28	S38	ES34	G63837	28.23	17.95	10.28	BP8	ES41
G63662	24.58	15.05	9.53	ES34	ES34	G63842	23.33	14.8	8.53	ES18	ES126
G63671	22.48	13.7	8.78	ES26	ES26	G63844	22.52	13.74	8.78	ES87	ES19
G63673	22.3	13.77	8.53	EB1	ES83	G63845	24.58	14.8	9.78	ES18	ES73
G63674	23.39	14.36	9.03	S38	ES34	G63847	20.45	12.67	7.78	S1	BP7
G63675	26.86	16.08	10.78	EB1	ES83	G63848	15.87	10.59	5.28	S38	ES34
G63676	15.48	10.45	5.03	ES69	ES69	G63860	24.33	14.39	9.94	S1	EB1
G63678	18.09	13.56	4.53	S36	BP7	G63862	25.07	14.94	10.13	S1	ES67
G63679	25.01	14.98	10.03	BP14	ES83	G63864	15	10.56	4.44	ES67	ES61
G63683	21.14	13.36	7.78	EB5	ES24	G63866	22.81	14.12	8.69	ES34	ES34
G63689	19.08	12.05	7.03	EB1	EB1	G63867	27.31	16.37	10.94	ES82	ES82
G63690	18.01	11.48	6.53	ES18	ES18	G63868	15.61	10.67	4.94	ES164	ES68
G63692	27.58	16.3	11.28	EB1	EB1	G63869	20.26	12.82	7.44	ES41	ES41
G63694	22.18	13.4	8.78	S38	EB20	G63870	24.89	15.2	9.69	ES82	ES82
G63707	15.89	10.11	5.78	S12	ES64	G63872	21.65	13.29	8.36	ES128	ES128
G63708	19.74	12.46	7.28	ES48	EB19	G63873	15.75	10.56	5.19	ES82	ES82
G63710	18.96	11.93	7.03	S1	ES153	G63875	17.67	11.73	5.94	ES13	ES13
G63712	22.48	13.7	8.78	ES110	ES19	G63878	24.16	14.97	9.19	ES34	ES13
G63714	15.39	9.86	5.53	S62	BP7	G63879	23	14.31	8.69	BP10	ES34
G63715	28.55	16.52	12.03	S12	ES171	G63882	21	13.31	7.69	BP10	ES34
G63716	16.39	9.86	6.53	S62	ES26	G63883	22.82	14.38	8.44	ES49	ES49
G63717	22.98	13.95	9.03	ES83	ES83	G63884	14.72	9.78	4.94	S47	EB13
G63720	21.39	12.86	8.53	S36	ES22	G63885	22.24	13.56	8.68	S59	ES36
G63721	20.21	12.43	7.78	S12	BP11	G63886	20.8	13.36	7.44	S38	ES34
G63722	19.49	12.21	7.28	BP20	ES24	G63888	31.36	18.67	12.69	EB1	ES83
G63726	21.05	12.77	8.28	S12	EB19	G63889	20.44	12.75	7.69	S1	ES81
G63772	13.73	9.45	4.28	S36	BP10	G63890	23.97	15.28	8.69	ES87	ES87
G63773	22.98	13.95	9.03	EB1	ES185	G63891	23.97	15.28	8.69	ES87	ES87
G63775	27.08	16.05	11.03	EB1	ES185	G63892	23.97	15.28	8.69	ES19	ES87
G63776	20.76	12.98	7.78	ES185	ES185	G63893	15.07	10.44	4.63	S11	LU1
G63778	24.55	14.52	10.03	S12	ES171	G63894	12.82	8.88	3.94	S11	BP9
G63781	18.45	11.93	6.52	S1	ES113	G63895	14.12	9.68	4.44	S11	BP9
G63782	13.7	9.09	4.61	S1	ES118	G63896	22.36	13.92	8.44	BP14	ES34
G63783	14.59	10.21	4.38	S12	BP11	G63897	23.87	14.68	9.19	BP14	ES34

SPECIFICATIONS BY PART NUMBER

ULTRA TRUCK SHOCKS (CONT'D)

CATALOG PART NO.	EXTENDED LENGTH	COLLAPSED LENGTH	STROKE	UPPER MTG CODE	LOWER MTG CODE	CATALOG PART NO.	EXTENDED LENGTH	COLLAPSED LENGTH	STROKE	UPPER MTG CODE	LOWER MTG CODE
G63902	12.6	8.59	4.01	S1	ES64	G64014	22.75	14.56	8.19	ES47	ES45
G63903	14.7	9.34	5.36	S1	BP14	G64015	21.32	13.63	7.69	ES45	ES128
G63904	14.95	9.95	5.00	S1	ES64	G64016	15.91	11.22	4.69	ES19	ES17
G63905	14.7	9.34	5.36	S1	ES76	G64026	16.26	11.57	4.69	ES61	ES61
G63907	20.23	12.37	7.86	EB1	EB1	G64027	13.62	8.74	4.88	S47	ES118
G63909	14.11	9	5.11	S1	ES64	G64028	20.75	13.19	7.56	EB16	ES113
G63915	13.2	8.59	4.61	S1	BP7	G64029	21.73	13.54	8.19	S38	ES36
G63918	21.25	13.56	7.69	ES34	ES141	G64030	22.56	13.86	8.70	S38	ES36
G63928	22.73	13.87	8.86	EB1	EB1	G64031	21.19	13.5	7.69	ES34	EB1
G63929	14.72	9.71	5.01	S36	EB1	G64032	18.7	12.09	6.61	ES49	ES49
G63937	14.7	9.34	5.36	S1	BP19	G64033	14.72	10.36	4.36	ES51	ES51
G63950	14.2	9.09	5.11	S1	BP7	G64037	26.37	15.47	10.9	S55	ES147
G63958	13.8	9.13	4.67	S29	BP13	G64038	24.48	15.07	9.41	S63	ES69
G63959	24.78	15.84	8.94	ES34	ES34	G64040	15.9	11.1	4.8	ES42	ES50
G63961	26.51	16.12	10.39	ES34	ES34	G64042	14.92	10.55	4.37	ES18	ES18
G63962	26.05	15.87	10.18	ES34	ES34	G64043	14.09	9.68	4.41	S61	BP38
G63965	24.14	15.2	8.94	BP14	ES34	G64044	25.98	16.22	9.76	ES49	ES49
G63966	22.45	14.5	7.95	BP18	ES26	G64046	18.62	14.72	3.9	S65	ES93
G63967	22.62	14.43	8.19	BP18	ES26	G64047	25.03	15	10.03	S56	ES67
G63969	20.75	13.31	7.44	S62	ES34	G64048	17.16	11.57	5.59	ES75	ES113
G63971	27.58	17.14	10.44	ES34	ES34	G64049	14.96	11.65	3.31	S51	ES55
G64000	27.36	17.68	9.68	ES34	ES34	G64050	19.55	12.91	6.65	ES30	ES137
G64001	14.67	11.47	3.20	S11	LU1	G64052	20.86	13.11	7.75	ES83	ES83
G64002	20.15	13.96	6.19	ES83	ES83	G64056	20.51	13.11	7.4	S18	ES83
G64003	16.84	11.28	5.56	ES69	ES69	G64063	19.17	13.26	5.9	ES201	ES141
G64006	22.75	13.81	8.94	S1	ES81	G64071	18.66	12.12	6.53	ES167	ES113
G64008	21.79	13.6	8.19	S57	ES26	G64079	29.37	17.32	12.05	ES83	ES83
G64009	23.29	14.25	9.04	S38	ES34	G64080	21.57	17.72	3.85	ES69	ES33
G64010	26.94	16	10.94	EB1	ES83	G64087	22.63	13.78	8.85	S29	ES36
G64011	23.36	14.21	9.15	S62	ES87	G64089	20.43	13.03	7.4	ES56	ES56
G64012	24.11	15.17	8.94	ES88	ES69	G64101	23.81	15.7	8.11	ES35	ES35

DISPOSAL OF OLD OR DEFECTIVE GAS-PRESSURIZED SHOCKS & STRUTS

STORAGE OF USED SHOCK ABSORBERS AND STRUTS

Used struts and shocks should be stored so that any oil leakage will be properly collected. Those containers used to store this product should be labeled "USED OIL".

Used struts and shocks can either be punctured to recycle the shock oil or disposed of in a manner consistent with local or state programs.

RECYCLING OF SHOCK AND STRUT OIL

1. FOR YOUR SAFETY, ALWAYS WEAR SAFETY GLASSES AND PROTECTIVE GLOVES WHEN PUNCTURING STRUTS AND SHOCKS.
2. Securely mount the strut or shock in a vice in the horizontal position. Make sure that the piston rod is fully extended prior to drilling the unit (Fig. #1).
3. Using a 1/16" or 1/8" drill bit, drill a hole in a downward direction approximately 1.0" from the bottom of the strut or shock (Fig #2). It is important to cover the area where the hole is being drilled with a towel or some type of shield to prevent spraying gas and oil upon initial penetration of the drill bit.
4. After the gas pressure is released continue drilling into the inner cylinder of the strut or shock unit, approximately 1/2" deep. Drill a second 1/2" hole near the top of the unit.
5. Remove the strut or shock from the vice and hold it over a container to collect the used oil. Hand stroke the unit to completely purge the oil from the cylinder of the unit (Fig #3).
6. Collect all used oil, **being careful not to mix this oil with any other waste or refuse**. Store in DOT approved containers labeled "USED OIL".
7. Dispose of the remaining strut or shock body and internal parts in accordance with local or state regulations (e.g., scrap metal recycler).
8. Store, dispose, and/or transport used oil in accordance with EPA regulations and your state's used oil program.

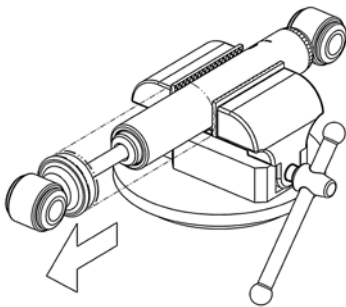

FIG. #1

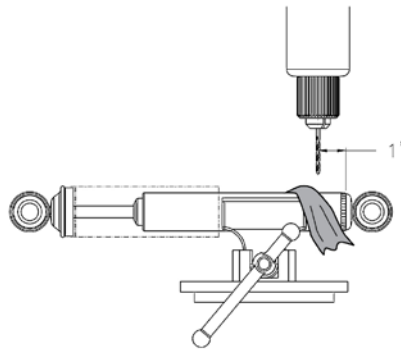

FIG. #2

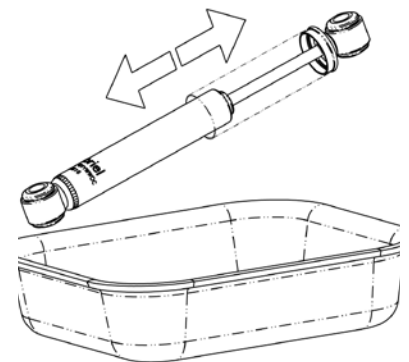

FIG. #3

DISPOSITION DE VIEUX OU DÉFECTUEUX CHOCS ET DE CONTREFICHES DE GAS-PRESSURIZED STOCKAGE DES AMORTISSEURS ET DES CONTREFICHES UTILISÉS

Des contrefiches utilisées et les chocs devraient être stockés de sorte que n'importe quelle fuite d'huile soit correctement rassemblée. Ces récipients stockaient ce produit devraient être marqués "HUILE USÉE".

Des contrefiches utilisées et les chocs peuvent se crever pour réutiliser l'huile de choc ou en quelque sorte le conformé débarassé aux programmes de gens du pays ou d'état.

RÉUTILISATION DU CHOC ET DE L'HUILE DE CONTREFICHE

1. POUR VOTRE SÛRETÉ, TOUJOURS VERRES DE SÛRETÉ D'USAGE ET GANTS PROTECTEURS EN CREVANT DES CONTREFICHES ET DES CHOCS.
2. Montez solidement la contrefiche ou la choquez dans un vice en position horizontale. Assurez-vous que la tige de piston est entièrement prolongée avant de forer l'unité (Fig. # 1).
3. Emploi d'un morceau de foret de 1/16" ou de 1/8", forez un trou dans un sens de haut en bas approximativement 1.0" du fond de la contrefiche ou le choquez (Fig. # 2). Il est important de couvrir le domaine où le trou est foré avec un essuie-main ou un certain type d'écran protecteur pour empêcher pulvériser le gas et le pétrole sur la pénétration initiale du morceau de foret.
4. Après que la pression de gaz soit libérée continuent de forer dans le cylindre intérieur de la contrefiche ou choquez l'unité, approximativement 1/2" profondément. Trou forez deuxième 1/2 " près du dessus de l'unité.
5. Enlevez la contrefiche ou la choquez du vice et tenez-l'au-dessus d'un récipient pour rassembler la huile usée. Course de main l'unité pour purger complet l'huile du cylindre de l'unité (Fig. # 3).
6. Rassemblez toute la huile usée, **faisant attention à ne pas mélanger cette huile à tout autre erte ou à ne pas refuser.** Le magasin dans le POINT a reconnu des récipients marqués "HUILE USÉE."
7. Débarassez-vous de la contrefiche restante ou choquez le corps et les pièces internes selon les règlements de gens du pays ou d'état (e.g., recycleur en métal de chute).
8. Magasin, disposez, etou le transport a employé l'huile selon des règlements d'EPA et le programme de la huile usée de votre état.

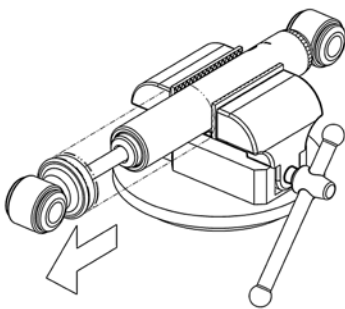

FIG. #1

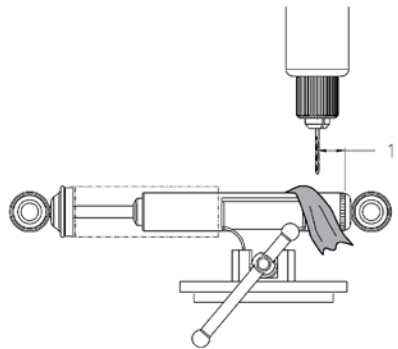

FIG. #2

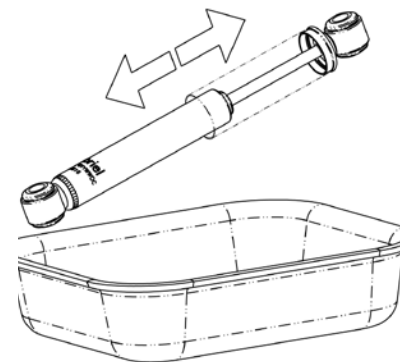

FIG. #3

COMO DESHACERSE DE AMORTIGUADORES Y STRUTS VIEJOS O DEFECTUOSOS -SIN PRESURIZACION CON GAS ALMACENAJE DE AMORTIGUADORES Y STRUTS USADOS

Los struts y amortiguadores deben almacenarse para que el aceite se pueda recoger. Los recipientes que se usen para almacenar este producto deben tener una etiqueta que diga: "ACEITE USADO".

Los struts y amortiguadores pueden ser perforados para reciclar el aceite o deshacerse de una manera constante con un programa local o del estado.

RECYCLAJE DEL ACEITE DE AMORTIGUADOR Y STRUT

1. PARA SU SEGURIDAD, SIEMPRE USE ANTEOJOS DE SEGURIDAD Y GANTES CUANDO PERFORE LOS STRUTS Y LOS AMORTIGUADORES.
2. Asegure la montura del strut o amortiguador sobre una manija horizontalmente. Asegúrese de que la varilla del pistón este totalmente extendida antes de taladrar la unidad (Fig. #1).
3. Use una broca de taladro de 1/16" o de 1/8", taladre un hueco de para abajo, aproximadamente de 1.0" en la parte de abajo del strut o amortiguador (Fig. #2). Es importante cubrir el área en que taladre con una toalla o cualquier otra manera de protección, para evitar que el gas y el aceite salten por todas partes cuando haga la primera incisión con la broca.
4. Después de que la presión del gas salga continúe taladrando dentro del cilindro interior del strut o amortiguador, aproximadamente 1/2" de profundidad. Taladre un Segundo hueco de 1/2" cerca de la parte de arriba de la unidad.
5. Remueva el strut o amortiguador del la manija y sosténgala sobre un recipiente para coleccionar el aceite usado. Sacuda la unidad para sacarle completamente el aceite del cilindro de la unidad (Fig. #3).
6. Recoja el aceite usado, **tenga cuidado de no mezclar este aceite con otro desperdicio o basura.** Almacene en recipientes aprobados por el DOT con una etiqueta que diga: "ACEITE USADO."
7. Deshágase de los sobrados del strut o amortiguador y las partes interiores de acuerdo con las regulaciones locales o del estado (por ejemplo: reciclaje para sobras de metal).
8. Almacene, deshágase, y/o lleve el aceite usado de acuerdo con las regulaciones del EPA y el programa de aceite usado.

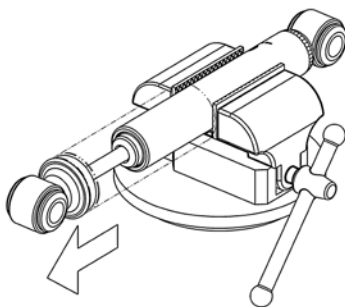

FIG. #1

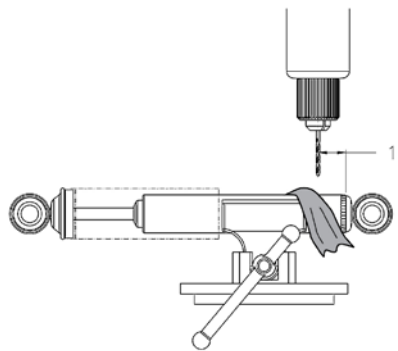

FIG. #2

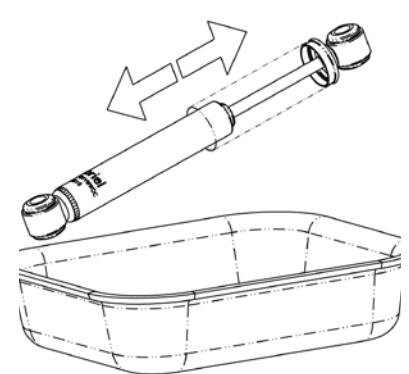

FIG. #3

AIR ADJUSTABLE HOSE KITS

Hose kit **141099** is packaged with all Air Adjustable Shocks listed in this catalog. For those vehicles equipped with G.M. Self-Leveling Systems, it may be necessary to purchase adapter kit **141248**. Hose kit **140656** with separate fill valves can be installed on vehicles to allow Air Adjustable Shocks to be filled individually.

REPLACEMENT AIR FITTINGS KITS

Each kit packaged in individual plastic bags.

KIT PART NUMBER	CONTENTS OF KIT	
140701 Replacement Air Fill Valve.	1 Tee Valve 1 Cap 1 Metal Washer	1 Rubber Washer 2 Nuts 1 Air Pressure Warning Circle

G.M. SELF-LEVELING SYSTEM / HOSE KIT CROSS REFERENCE

General Motors vehicles equipped with factory installed G.M. Self-Leveling Systems require an adapter hose kit to operate with our Air Adjustable Shocks. See chart below for the correct application for your vehicle.

Use of conventional shock absorbers on these applications would require deactivation of the air compressor.

APPLICATION	AIR ADJUSTABLE NO.	HOSE KIT(S) REQUIRED
G.M. vehicles with electrically operated self-leveling system or vacuum operated self-leveling system (except above listings)	Listed with Vehicle	141099 and 141248**

* 141099 and 141248 are packaged with the Air Adjustable shocks. Shown for reference if replacement is required.

** 141099 is packaged with the Air Adjustable shocks. 141248 must be purchased separately and used with hose kit packaged with shocks.

No. 141099 Kit Contains:

- 4 - Tube Nuts
- 4 - Tube Clamps
- 10 - Packing 'O' Rings
- 1 - Tube
- 1 - Tee Block Air Valve Fitting
- 1 - Valve Core
- 6 - Tubing Clips
- 1 - Valve Cap
- 1 - Washer
- 2 - Hex Nuts
- 1 - Seal
- 1 - Warning Tag
- 1 - Instruction Sheet

*** Used in conjunction with Hose Kit #141099.

No. 141248*** Kit Contains:

- 3 - Tube Nuts
- 3 - Tube Clamps
- 8 - Packing 'O' Rings
- 2 - Tubing Clips
- 1 - Valve stem adapter & seal sub-assy
- 1 - Valve stem adapter
- 1 - Self-tapping screw
- 1 - Coupling (brass)
- 1 - Compression Spring
- 1 - Valve core
- 1 - Tee clip
- 1 - Valve cap
- 1 - Instruction sheet

EQUIPOS DE MANGUERA DE AIRE AJUSTABLE

El paquete de manguera **141099** viene con todos los Amortiguadores de Aire Ajustables en este catalogo. Para los autos equipados con Sistema de Auto Nivelación G.M., puede ser necesario comprar el paquete con adaptador **141248**. El paquete de manguera **140656** con válvulas separadas puede ser instalado en el auto para permitir que los amortiguadores de Aire Ajustable puedan ser cargados individualmente.

PAQUETES PARA REEMPLAZAR EQUIPOS DE AIRE

Cada paquete esta empacado en bolsas plásticas.

NUMERO DE PARTE	CONTENIDO	
140701 Válvula de aire para reemplazo.	1 Válvula de arriba 1 Tapa 1 Arandela de metal	1 Arandela de caucho 2 Tuercas 1 Anillo de alerta de presión de aire

SYSTEMA G.M. AUTO NIVELACION / PAQUETE DE MANGUERA PARA REMISION

Los autos de General Motors con equipos de fábrica de Sistema de Auto-Nivelación G.M. requieren un adaptador de manguera para operar con nuestro Aire Ajustable. Vea la lista de abajo para la aplicación correcta para su auto.

El uso del amortiguador convencional en esta instalación requerirá la desactivación del compresor del aire.

APLICACION	AIR- AJUSTABLE NO.	PAQUETE(S) DE MANGUERA EQUERIDO
Los autos G.M. con sistema de auto-nivelación operados electrónicamente o los operados con sistema de auto nivelación al vacío (excepto los de la lista de arriba)	Información viene en el manual	141099 y 141248**

* 141099 y 141248 están empacados con amortiguadores de Aire Ajustable. En lista como referencia, si es necesario reemplazarlos.

** 141099 esta empacado con los amortiguadores de Aire Ajustable. 141248 deben comprarse separadamente y usarlos con el paquete de manguera empacados con amortiguadores.

No. 141099 Empaque contiene:

- 4 - Tuercas de tubo
- 4 - Ganchos de tubo
- 10 – Empaque de 'O' anillos
- 1 - Tubo
- 1 - Equipo de válvula de aire de bloqueo de arriba
- 1 - Válvula central
- 6 - Agarraderas para tubo
- 1 - Tapa de válvula
- 1 - Arandela
- 2 - Tuercas hexagonales
- 1 - Sello
- 1 - Tiquete de advertencia
- 1 - Hoja de instrucciones

*** Use junto con el paquete de manguera # 141099.

No. 141248*** Empaque contiene:

- 3 – Tuercas de tubo
- 3 – Ganchos de tubo
- 8 - Empaque de 'O' anillos
- 2 – Agarraderas para tubo
- 1 – Válvula con adaptador de tubo & sellado subalterno
- 1 - Válvula con adaptador de tubo
- 1 – Tornillo auto-golpes
- 1 - Combinación (latón)
- 1 – Resorte de compresión
- 1 – Válvula central
- 1 – Agarradera de arriba
- 1 – Tapa de válvula
- 1 – Hoja de instrucciones

ENSEMBLES DE BOYAUX POUR HI JACKER

Kit de tuyau 141099 est emballé avec tous les amortisseurs réglables à Air répertoriés dans ce catalogue.
 Pour les véhicules équipés de systèmes de Self-Leveling de G.M., il peut être nécessaire d'acheter la trousse 141248.
 Kit de tuyau 140656 avec les robinets de remplissage séparé peut être installé sur les véhicules afin de permettre un réglage uniforme de chacun des amortisseurs à Air.

ENSEMBLES DE QUINCAILLERIE DE REMPLACEMENT POUR SYSTEME DE COMPRESSION

Chaque ensemble est emballé individuellement dans des sachets plastiques.

NUMÉRO DE PIÈCE	CONTENU DE L'ENSEMBLE	
140701 Soupape de remplissage d'air de remplacement.	1 Valve en "T" 1 Capuchon 1 Rondelle de métal	1 Rondelle de métal 2 Écrous 1 Anneau indicateur de

LISTE DE RENVOIS POUR ENSEMBLES DE BOYAUX "SELF LEVELING SYSTEM" DE GM

Les véhicules General Motors équipé d'un "Self Leveling System" installé en usine requièrent un ensemble d'adaptateurs de boyaux pour fonctionner avec notre système Hi Jacker. Consultez le tableau ci-dessous pour l'application appropriée à votre véhicule.

Pour utiliser des amortisseurs conventionnels avec ces applications, on doit désactiver le compresseur d'air.

APPLICATION	NUMÉRO AIR RÉGLABLE	ENSEMBLE DE TUYAU REQUIS
G.M. avec système Auto Réglage électrique ou avec système Auto Réglage a air (sauf la liste au dessus)	En vente avec un véhicule	141099 et 141248**

* 141099 et 141248 sont emballés avec les amortisseurs d'Air réglable.
 Voir les références si le remplacement est nécessaire.

** 141099 est emballé avec les Amortisseurs d'Air réglable.
 141248 doit être acheté séparément et utilisé avec l'ensemble de tuyau emballé avec les Amortisseurs.

No 141099 Ensemble:

- 4 - Écrous pour tuyau
- 4 - Colliers de serrage pour tuyau
- 10 - Joints toriques
- 1 - Tuyau
- 1 - Raccord de soupape en "T"
- 1 - Noyau de valve
- 6 - Brides pour tuyau
- 1 - Capuchon de soupape
- 1 - Rondelle
- 2 - Écrous à hexagonaux
- 1 - Joint d'étanchéité
- 1 - Étiquette de prévention
- 1 - Feuille d'instructions

*** Utiliser conjointement avec l'ensemble de boyaux no. 141099.

No 141248 Ensemble:***

- 3 - Écrous pour tuyau
- 3 - Colliers de serrage pour tuyau
- 8 - Joints toriques
- 2 - Brides de tuyau
- 1 - Sous-ensemble d'adaptateurs de corps de valve et de joint d'étanchéité
- 1 - Adaptateur de corps de valve
- 1 - Vis à tôle autotaraudeuse
- 1 - Raccord en cuivre
- 1 - Ressort de compression
- 1 - Obus de valve
- 1 - Bride en "T"
- 1 - Bouchon de valve
- 1 - Feuille d'instructions

QUESTIONS ANSWERED.

800.999.3903 | ANSWERGARAGE.COM

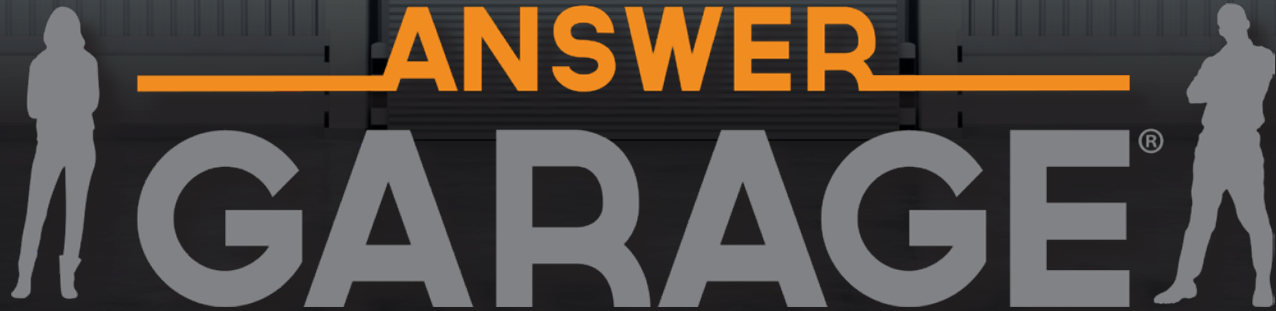

Ride Control Answer Garage/Tech Line:

800.999.3903

For application, technical and
product questions
Monday - Friday, 8AM - 5PM CT

Gabriel Customer Service:

800.251.5932

To place and track orders
Monday - Friday, 7AM - 5PM CT

Watch our Videos:

**Good Shocks vs.
Bad Shocks**



**HiJackers®
Installation**



**ReadyMount®
Installation**



FIND MORE AT GABRIEL.COM
part lookup, product info, technical help & training



Ride Control, LLC, 39300 Country Club Dr.
Farmington Hills, MI 48331, 248.247.7600